



This is a digital copy of a book that was preserved for generations on library shelves before it was carefully scanned by Google as part of a project to make the world's books discoverable online.

It has survived long enough for the copyright to expire and the book to enter the public domain. A public domain book is one that was never subject to copyright or whose legal copyright term has expired. Whether a book is in the public domain may vary country to country. Public domain books are our gateways to the past, representing a wealth of history, culture and knowledge that's often difficult to discover.

Marks, notations and other marginalia present in the original volume will appear in this file - a reminder of this book's long journey from the publisher to a library and finally to you.

Usage guidelines

Google is proud to partner with libraries to digitize public domain materials and make them widely accessible. Public domain books belong to the public and we are merely their custodians. Nevertheless, this work is expensive, so in order to keep providing this resource, we have taken steps to prevent abuse by commercial parties, including placing technical restrictions on automated querying.

We also ask that you:

- + *Make non-commercial use of the files* We designed Google Book Search for use by individuals, and we request that you use these files for personal, non-commercial purposes.
- + *Refrain from automated querying* Do not send automated queries of any sort to Google's system: If you are conducting research on machine translation, optical character recognition or other areas where access to a large amount of text is helpful, please contact us. We encourage the use of public domain materials for these purposes and may be able to help.
- + *Maintain attribution* The Google "watermark" you see on each file is essential for informing people about this project and helping them find additional materials through Google Book Search. Please do not remove it.
- + *Keep it legal* Whatever your use, remember that you are responsible for ensuring that what you are doing is legal. Do not assume that just because we believe a book is in the public domain for users in the United States, that the work is also in the public domain for users in other countries. Whether a book is still in copyright varies from country to country, and we can't offer guidance on whether any specific use of any specific book is allowed. Please do not assume that a book's appearance in Google Book Search means it can be used in any manner anywhere in the world. Copyright infringement liability can be quite severe.

About Google Book Search

Google's mission is to organize the world's information and to make it universally accessible and useful. Google Book Search helps readers discover the world's books while helping authors and publishers reach new audiences. You can search through the full text of this book on the web at <http://books.google.com/>



Smith & Mabley.....34, 61
 Smith, Elwin L.....36
 Snow & Co., H. H.....42
 Snow, H. M.....34
 Southern Pacific Railroad.....56
 Speare's Sons Co., Alden.....37
 Sprague Umbrella Co.....50
 Springfield Hat & Cap Co.....35
 Springfield Metal Body Co.....42
 Springfield Moulding Works.....36
 Standard Automobile Co.....34, 70 and Cover
 Standard Wheel Co.....59
 Star Auto Co.....34
 Steam Carriage Boiler Co.....35
 Stearns Co., F. B.....58
 Stevens Arms & Tool Co., J.....62
 St. Louis Motor Carriage Co.....58
 Studebaker Automobile Co.....72
 Steel Highway Track Construction Co.....41
 Suffolk Chemical Co.....36
 Swinehart Clincher Tire & Rubber Co., The.43

T

Tennant Auto Tire Co.....48
 The Beaconsfield.....56
 Thomas Motor Co., E. R.....63
 Thorn Mfg. Co.....35
 Timken Roller Bearing Axle Co.....53
 Trebert Gas Engine Co.....54
 Tremont Garage.....34
 Tucker, C. F.....35
 Tuck, Robt., Co.....35

U

Ullman, Henry J.....34
 Union Automobile Co.....59
 United Motor Corporation.....58
 Upton, Colcord.....53
 Upton Machine Co., The.....53
 Utility Co.....35

V

Van Husan & Farr Co.....51
 Veeder Mfg. Co.....37

W

Wagner Electric Manufacturing Co.....54
 Wakefield, J. E.....35
 Walker & Dam.....34
 Waltham Mfg. Co.....66
 Welch Motor Car Co.....65
 West Box Co., F. M.....35
 Western Motor Co.....54
 Weston Electrical Instrument Co.....49
 Wheelock Motor Car Clock Co.....35
 White Sewing Machine Co.....59
 Whitney Mfg. Co.....53
 Whitlock Coll Pipe Co., The.....53
 Willard Storage Battery Co.....49
 Willis Co., E. J.....35
 Wilson & Hayes Mfg. Co.....42
 Winton Motor Carriage Co.....58
 Witherbee Igniter Co.....36
 Woods Motor Vehicle Co.....34

Special Notices.

Advertisements inserted under this heading at 20 cents per line; about 7 words make a line. Remittance should accompany copy. Replies forwarded if postage is furnished.

AUTOMOBILES FOR NEXT TO NOTHING.

If you are in want of an automobile at less than one-third it costs to manufacture, write to us for a special price list on the following machines that we have, belonging to private parties who want immediate offers. They mean business, as they don't want their autos and we must sell them quick. 9-hp. touring Car Darracq; 7-hp. U. S. Long Distance Tonneau; 8-hp. Winton; 9-hp. Ward Leonard; 7-hp. U. S. Long Distance Runabout; 16-hp. Mors, almost new, perfect condition; 16-hp. Darracq, canopy top; 2 cylinder, 16-hp. 1903 Peerless; double cylinder, 8-hp. Auto Car Tonneau; 12-hp. Gasmobile; very handsome, 6-hp. fine French Clement; 3 cylinder, 18-hp. Gasoline Tonneau; 5-hp. De Dion Motorette; double cylinder Remington runabout, with top, 8-hp.; Haynes-Apperson surrey, seats 3 and chauffeur, artillery wheels, canopy top; Waverly Electric, 40 cells; Mobile dos-a-dos; three new Pope Toledo Steam Cars at one-half their original cost; Orient Buckboard, crank starter; White Steamer, leather top; American Stanhope, new, with leather top; Columbia Electric Victoria; National Electric, with top; brand new Meteor Steamer; Victor Steamer; 18 passenger, 18-hp. Steam Omnibus, 24-hp. Boiler, used 1 month; Haynes-Apperson Surrey, full leather top, newly painted; Remington Surrey, artillery wheels.

Remember we are the largest dealers in shop-worn, second-hand and demonstrating automobiles in America. Manhattan Storage Co., 334-336-338-340 West 44th St., New York City, near Ninth Ave. Phone No. 4290—38th. Philadelphia branch, 631 Market St. 2

A MERICAN PATENT to be sold for a combined puncture-proof and non-skid device for pneumatic tires of motor cars, bicycles, etc.; already abundantly proved to be the simplest, neatest, effective and durable, and the cheapest on the market. Easily made with little or no machinery. Address Climax, care of The Automobile. 9

C REST RUNABOUT for sale, \$250. Dos-a-dos seat; would send photo. Box 877, So. Manchester, Conn. 2

F ORD TONNEAU, in good condition, brass trimmings, pair Solar lamps and tall lamp, extra seat for tonneau, horn, tools, and equipped with 28x3 Flak detachable tires. First check \$500 takes it. Balto. Motor Car Co., 400-402 Bloom St., Baltimore, Md. 2

F OR SALE—One 1904 Orient Buckboard, never been used. Price \$325. Quick buyer. W. A. McGowan, Wilmington, N. C. 2

F OR SALE—Complete set of drawings, patterns and special fixtures for 4 3/4x6 in. Horizontal Gas Engine. Special price for cash sale. Write or apply, Cleveland Automatic Machine Co., Cleveland, O. 9

F OR SALE—1903 Stearns Touring Car and Columbia XLX. Electric Surrey at bargain prices if taken immediately. E. R. Thomas Motor Co., No. 1209 Niagara St., Buffalo, N. Y. 2

F OR SALE at a bargain, 30 Apple Dynamos, new, for Automobiles, complete with governor, either with friction or belt drive. The R. M. Cornwell Co., 416-420 S. Salina St., Syracuse, N. Y. 1f

F OR SALE—Kensington 12-hp. tonneau, almost new, cost \$2,500, for \$800; Electric Stanhope, new, \$1,800, for \$300; Electric Light Delivery, new, \$1,800, for \$900. The Knowles Automobile Mfg. Co., Buffalo, N. Y. 16

F OR SALE—Gasoline Charging Plant. 4-horsepower, Ohio Engine, belted to 30 ampere, 150-volt dynamo; includes switchboard, water tank, gasoline tank, etc. Complete, ready to operate; new; for \$215 cash. Frank Balch, 329 Essex St., Salem, Mass. 2

F OR SALE—16-horsepower, 4-cylinder, air-cooled Premier roadster, with tonneau, lamps, horn, complete set of tools. Used only three weeks by expert. Owner leaving city, unable to use it. Price right for quick sale. R. G. Handy, Bay City, Mich. 2

F OR SALE—One No. 02 Locomobile (rebuilt), dos-a-dos seat, steam air pump, Midgley wheels, fire pan, large gasoline tank; glass on water tank; in first-class running order; sight feed oil cups; large cylinder oil cup; price \$200. Address J. Vonder Linden, Rhinebeck, N. Y. 2

G ASOLINE testing outfit, accurate, indispensable, vest-pocket size, complete, \$1 postpaid. C. A. Vuille, Huntingdon, Pa. 1f

H AYNES-APPERSON 10-H.P. runabout, like new, \$750. C. F. J., 1744 W. North Ave., Baltimore, Md.

K EAN STEAM 8 H.P. for sale. Only run 300 miles; new last May; cost \$750. Will sell cheap; rare bargain. Box 28, South Bend, Indiana. 2

N EW Ford Touring Car, will exchange for good Olds or Rambler runabout; will take difference in cash. Wilke Auto Co., Richmond, Indiana. 2

O LDSMOBILE, about one year old, leather top, artillery wood wheels, new tires, looks like new car, and in absolutely first-class condition. Price to quick cash buyer, \$395. Address T. D. Whyte, Mint Arcade, Philadelphia, Pa. 2

O LDSMOBILE, with top and dos-a-dos seat, nearly all late improvements, \$375. Locomobile in fine condition, \$190. One No. 16 model Thomas light touring car, complete outfit with extra tire, bargain at \$500. 1902 Toledo Steamer, like new, complete with Rochester automatic oiling system, \$250. De Dion Motorette, 4 1/2 H.P. engine, tires good, in fine running order, \$175. One 1902 Elmore, 2-cylinder, 7 H.P. engine, folding front seat, exceptional bargain, \$275. Send for our large illustrated catalogue. The R. M. Cornwell Co., 416 S. Salina St., Syracuse, N. Y. 1f

P ACKARD 1903, Model F, very little used and practically new; have purchased four-cylinder car; will take gasoline runabout in part payment. Rushmore Dynamo Works, Plainfield, N. J. 2



Goggles in Service.

Patented Cap
 WITH GOGGLES ATTACHED.

Perhaps this is the cleverest cap ever filed at the patent office. The goggles, which are very light, fold in the projecting crown of the cap. You are never conscious of their presence until they are needed, nor can you break or forget them. The flap to protect the ears and head fastens at the top with ball and socket snaps.

Of Covert in tan or brown, Linen in tan, Scotch Tweed in mixtures, Silk Rubber in tan, navy, brown or black, and Pongee Silk in tan, \$4.75.

Of Danish Kidskin leather, in black or tan, \$6.00.

Please send for our catalogue.

Saks & Company

Broadway, 33d to 34th Sts., New York



Goggles Folded in Crown.

**CHICAGO
AUTOMOBILE AGENCIES**

WOODS

ELECTRIC
Stanhopes, Victorias, Landauettes and Broughams
WOODS MOTOR VEHICLE CO.
1408-1410 Michigan Ave., Chicago
Write or Phone 1134 South for Catalogue

Geo. A. Crane, Manager

KNOX AUTO CO.

531 Wabash Ave. Phone, Harrison, 4374
WATERLESS KNOX CARS
SINGLE AND DOUBLE CYLINDER
Tonneaus, Surreys, Runabouts,
Physicians' Cars, and Delivery Wagons.

WHITE TOURING CARS

HENRY J. ULLMANN
Distributor
Reading Standard Motor Cycles
1404-1406 Michigan Avenue

PARDEE & COMPANY

1404-6 Michigan Boulevard
Tel. Calumet 2523

**PACKARD YALE
ELMORE**

BUFFALO ELECTRIC STANHOPE

MASON, HARVEY & CO.

1466 Michigan Avenue
CHICAGO

**AUSTIN GASOLINE CARS
BAKER ELECTRICS**

SPECIAL NOTICES—Continued.

QUICK—One new 1904 Winton, complete, with canopy; never run; \$2,000. One 1903 Winton in good condition, with baskets, No. 1 Solar Headlight, etc., \$1,000. R. W. Whipple, Whipple Bldg., Binghamton, N. Y.

SEND five cents for our illustrated catalogue of second-hand automobiles. Big variety, low figures. Mississippi Valley Automobile Co., St. Louis, Mo. tf

WANTED—1904 White Touring Car—must be cheap, with canopy top. S. K. P. care Automobile. 2

WANTED—Exclusive manufacture or sale of improved specialties in automobile motor line. Box "X," care Automobile. 2

WANTED—In connection with our engineering business we have equipped machine shop, and are prepared to do contract or experimental job work, especially in the automobile line. Write us and get benefit of our engineering experience. Try us for finished aluminium parts. Winn, Mil-moe & Porter, Stock Exchange, Chicago. 2

5-HP. Double Cylinder, High Speed, Air cooled gasoline engine. Never mounted. Cost \$115; will sell for \$90 if taken at once. T. A. Tilden, Rexford, Kansas. 2

1903 Winton, fine shape, only \$1,500; Olds \$325; Crest Tonneau, \$700. The Reichert Auto Co., New Haven, Conn. 9

1903 Elmore runabout for sale—Lamps and horn, \$550. Used only six times; is as good as new. Foster Automobile Co., Richmond, Va. tf

**NEW YORK
AUTOMOBILE AGENCIES**

The DOLSON

15 horsepower. \$1,400.
Most Powerful Car at the Price
Efficient Repairs promptly executed at reasonable rates
Cleanest, Lightest Storage Station in New York City
WALKER & DAM, 20 W. 60th St., New York

STANDARD AUTOMOBILE CO.

Finest equipped Garage in N. Y.
Repair Department for Foreign Cars.
A few bargains in Second-Hand Cars.
146-148 WEST 39th STREET, N. Y.

THE YALE

A 16 HP., 35-mile an hour touring car, embodying all the latest mechanical improvements.
\$1,500, \$1,600; with canopy top \$1,800.
PIONEER AUTOMOBILE CO.,
54-56 West 43d St., N. Y.

**MITCHELL
ROYAL
ACME**

"Cars That Content"

\$700
To \$3000
THE DUERR-WARD CO.
1787 Broadway, N. Y.

CADILLAC

We Have a Special Proposition to Make to People of Moderate Means.
For particulars call at Cadillac Co. of N. Y., 151 W. 36th Street, New York.

SIMPLICITY—POWER—EFFICIENCY
QUICK DELIVERIES

The Phelps Touring Car

This famous 3-cylinder Hill Climber is easily operated by a lady.—No noise.—No vibration.—Just solid comfort.
E. F. PHELPS, Mgr. 154 W. 38th St., N. Y.
Phone 4000 36th.

BROOKLYN AUTOMOBILE CO
AGENTS FOR

HAYNES - APPERSON

For Connecticut, New York State (except Buffalo) New Jersey, Eastern Pennsylvania and Delaware.
PROMPT DELIVERIES
66 WEST 43d STREET, NEW YORK
Brooklyn Garage, 1239-41-43 Fulton St.

CRESTMOBILES

STAR AUTO CO.
144 West 39th St., New York
Telephone, 294-38
SEE LARGE AD. THIS ISSUE

35 H. P. Panhard
for sale. Racing body, individual seats, 4-cylinder motor, separated cylinders, Krebs Carbureter, latest control on wheel; in perfect condition; exceptional bargain. PRICE, \$8,500.
SMITH & MABLEY, INC.,
513 SEVENTH AVE., CITY.

**BOSTON
AUTOMOBILE AGENCIES**

DECAUVILLE CARS DECAUVILLE CARS

THE LEWIS & MATTHEWS CO.
66-70 Stanhope St.
'Phone 311 Tremont

DECAUVILLE CARS DECAUVILLE CARS

CRESTMOBILES

Runabout - \$800
Tonneau - \$900

R. F. COBURN, Mgr. 182 COLUMBUS AVE.
Phone, 576 Tremont, for demonstration.

**STEVENS-DURYEA
CLEMENT-BAYARD
INDIAN MOTORCYCLE**

Send for new illustrated Catalogues!
See the new models.
F. E. RANDALL, Salesroom: 245 Columbus Av.

Columbia

AUTOMOBILES ELECTRIC and GASOLINE
NEW SALESROOM AND GARAGE
NOW OPEN AT
74-76-78 STANHOPE ST.

American POPULAIRE CAR
Without Tonneau \$850. With Tonneau \$950.

AMERICAN AUTOMOBILE AND POWER CO.
GENERAL OFFICES, 5 PARK SQUARE, BOSTON
Phone 929-4 Oxford

A C M E

**TOURING CARS
NEW MODELS READY**
Phone, 271-272 Tremont. Salesroom, 43 Columbus Ave.
HERBERT M. SNOW Agent.

**IMPORTED CARS
BOYER & DeDION**

4 Cylinder Boyer Tonneau, \$2,700.
French Cars at American Prices.
1-2-4 Cylinder Touring Cars Ready.
Full line of parts always in stock.
K. A. SKINNER, 179 Clarendon Street BOSTON

**TREMONT
GARAGE**

Largest and best equipped station in the world. 40,000 sq. ft. floor surface. Rates reasonable. 'Phone, 75 Tremont
541 TREMONT ST.
G. H. BURT, Prop. F. CARLETON DOLE, Mgr.

ADVERTISING

IS A MATTER OF BUSINESS. THE BEST ADVERTISING IS THAT WHICH BRINGS THE BEST RESULTS. SPACE IN THE AUTOMOBILE BRINGS BUSINESS

OUTFITS AND SUPPLIES

"DRAPER" ROBE

FOR AUTOMOBILES
WIND COLD WATER **Proof** SENT ON APPROVAL.
Write for Sample and Price. Phone, 29 Canton.
DRAPER BROS. CO., Canton, Mass.



WAKEFIELD
AUTO WRENCH
2 1/4 ins. long; Jaw 3/8 in. thick; Opens 3 ins. Gun Metal Finish.
\$1.50 - PREPAID - \$1.50
J. E. WAKEFIELD, WORCESTER, MASS.
86 Exchange Street



COMET
MICA SPARK PLUG
BEST Plug Made at any price
Guaranteed for ninety days Price, \$1.50
MANUFACTURED EXCLUSIVELY BY
CAKES & DOW CO., 40 Sudbury St., Boston, Mass.



LEATHER AUTO COATS
(Our Specialty)
LATEST DESIGNS LOWEST PRICES PROMPT DELIVERIES
ROBERT TUCK CO., Peabody, Mass.
Formerly of N. Y. City
Largest Mfrs. of Leather Coats in the U. S.



YANKEE SILK CAP
PRICE, \$1.50.
Very swell; silk brilliantine; color either light cream or grey featherweight; very cool; East-land shape same fabric and price.
"Everything for the Automobile."
Big Free Catalogue Discounts to Dealers
E. J. WILLIS CO., 14 Park Place, N. Y.



SCOOP CAP
New Style for Summer Use
Feather Weight. Made in all Sizes in Chevrets and Rain Proof Cloth. Send for Catalog.
SPRINGFIELD HAT AND CAP CO.
Springfield, Mass.

A SUBSCRIPTION FOR THE AUTOMOBILE WILL COST YOU BUT \$2.00 PER YEAR, ABOUT 4 CENTS A COPY, PUBLISHED WEEKLY

STANDARD SUPPLIES

Genuine Continental Tires, Funke Autolyte Lamps and Horns, Solar Lamps, Splitdorf Coils. All leading Spark Plugs. Everything for Automobile owners and dealers.

NEW CATALOGUE SENT ON REQUEST

EXCELSIOR SUPPLY CO.

33-5-7 Randolph St.

Chicago



Wheelock Motor Car Clock
Popular Price
SEND FOR CIRCULAR
WHEELOCK MOTOR CAR CLOCK CO.
Tremont Building
BOSTON :: :: U. S. A.



Thorn Automobile Clock
Pat. Jan. 26, 1904
Dust, rain, theft-proof. No opening top or bottom. Solid brass, hand-turned, highly polished. Enclosed in a crystal front. If not satisfactory money refunded. Send for illustrated circular.
PRICE, \$3.50
THORN MFG. CO. - Salem, Mass.

"BAY STATE" HAMPERS

ALL STYLES AND SIZES
RATTAN NOVELTY CO., SPRINGFIELD MASS.

NOTICE!!
COIL MAKERS
Write us for prices on Hard Wood Polished
BOXES TO ORDER
All styles, all sizes. Prompt deliveries
F. M. WEST BOX CO. Springfield, Mass.



SEND 50 CENTS FOR ASSORTED PACKAGE
FOR ASSORTED PACKAGE
SHAIN'S AUTO WIRE TERMINALS
Prevent Loose Wires & Poor Connections.
— CHAS. D. SHAIN —
AUTO-SPECIALIST
70 MURRAY ST. N. Y.
Everything Else for Autos.

WHY NOT

use the very best brake?
It is the Raymond.
Guaranteed to hold.

ROYAL EQUIPMENT CO.,
55 Golden Hill St., BRIDGEPORT, Conn.



MAIL ONE DOLLAR BILL FOR SEASON'S SUPPLY
FOR GRIMY HANDS
"...since ahead of soap."
THE UTILITY CO.,
281-285 Greenwich St., N. Y.



SPUC, LIO, REKCUT
This is not Latin, it reads
TUCKER OIL CUPS
Postal will bring Samples or Catalog.
C. F. TUCKER, HARTFORD, CONN.,
302 ASYLUM STREET



Bennett Handy Oilers
easily reached in unhandy places. No plugging up. Oil tight and dust proof.
Bay State Stamping Co. WORCESTER, MASS.
European Agents: Chas. Churchill & Co., London, England.
Pat. July 21, 1903 Pat. July 28, 1901



PERFECTION PLUGS
TAPER MICA WINJINGS
Guaranteed for 90 days
COILS ALL STYLES AND SIZES
New Catalog gives Prices.
AMERICAN MACHINE MFG. CO., - So. Braintree, Mass.



FISHER PLUGS
Are Well Made Every Way
The Fisher Special Mfg. Co.
229 W. Sixth St. CINCINNATI, O.



DR. DYKE'S "Diseases of Gasoline Automobiles and How to Remedy Them."
Price \$1.50. A book worth the money
Send 10 cents for largest Automobile Supply Catalogue in the World.
A. L. DYKE
Automobile Supply Co.
2108 Olive St., ST. LOUIS, MO.



Kent Pocket Battery Meters
The Automatic Volt-Ammeter is designed and calibrated especially for testing batteries in connection with gasoline automobiles and lanterns. The needle is carefully pivoted, and the readings are accurate. No change is made in the connection to the battery for the two readings, so that in lamps is indicated by simply pressing the button. The most convenient and complete battery tester on the market. Price of Automatic Volt-Ammeter, \$6.00; price of Ampere meter, \$4.50. Special notes made to order.
ATWATER KENT MFG. WORKS, 116 N. 6th St., Philadelphia

The Ferg Gasoline Burner



P. FERG
Somerville MASS.

HOLTZER-CABOT GAS ENGINE IGNITERS

ARE SUCCESSFUL
Perhaps you have not seen our new booklet "About Sparkers" SEND FOR ONE
THE HOLTZER-CABOT ELECTRIC CO.
BOSTON (Brookline), MASS.
CHICAGO—395 Dearborn St. NEW YORK—143 Liberty St.



"If you are looking for a thoroughly reliable article"
Better Investigate"
Boilers and Kerosene Burners
We make all sizes. Write for Catalog.
STEAM CARRIAGE BOILER CO.,
119 W. First Street, Oswego, N. Y.

YOU AUTO USE NON-FLUID OILS

They don't drip, waste and oil the roads like fluid oils. Unlike greases, cause no increase in friction-load and fuel consumption, because don't make bearings run warm before they lubricate. Recommended by *Mfrs.* Sold by leading garages. Let us send **FREE SAMPLES** to prove claims. Write today
N.Y. & N. J. Lubricant Co. 14 Church St., New York
79 7th St., San Francisco



Not made like a toy from light tubing that will smash easily, but from heavy seamless brass tubing. Can be operated with one hand. Saves crawling under the car to get at hard-to-reach parts. Prevents waste of oil.
Ask your dealer or write for circular.

N. Y. & N. J. LUBRICANT CO., 14 Church Street, New York City.
79 Ninth Street, San Francisco, Cal.

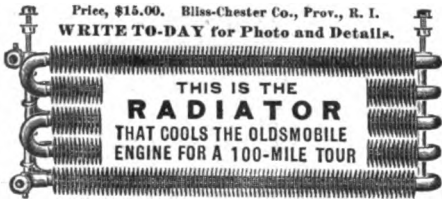

SUPPLIES DIRT CHEAP

CATALOG
THE MOTOR CAR SUPPLY CO.
1427 Michigan Ave., Chicago



Portable Houses
for AUTOS, LAUNCHES,
SHORE COTTAGES
All styles and sizes. \$75 and
up. Immediate deliveries.
Mfg. by
Springfield Moulding Works
Springfield, Mass.

RUBBERINE

MAKES TIRES PUNCTURE-PROOF
MAKES AIR TIGHT
Agents Make Good Money Selling to Auto
Repair Shops
N. E. Rubberine Co., 43 Columbus Ave., Boston

WITHERBEE STORAGE BATTERY IGNITER

Accomplishes Results when Other Makes Fail
OUR PATENTED VENT eliminates evaporation, makes battery practically air-tight, prevents the acid from sloping over. It forces the gas under pressure.
THE WITHERBEE is clean, economical, durable, and has the longest life of any storage battery made.
Agents wanted in unoccupied territory We guarantee satisfaction
WITHERBEE IGNITER CO, Main Office, 27 Thames St., New York



Simplest lock check made for wheel steer
Etwin L. Smith, 43 Columbus Ave., Boston, Mass.

UNIVERSAL JOINTS
BRONZE and STEEL,
sent on trial to responsible firms
Cam and Gear Cutting.
Sprockets, Chains, Differentials, Worms and Worm Gears
for Steering Devices
BOSTON GEAR WORKS, 149 Pearl St., Boston, Mass.
SEND FOR CATALOG R. A.

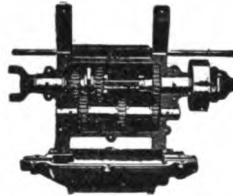

CHANGE SPEED GEAR
(Interior view)
3 Speeds Ahead, Direct Drive
on Top Speed and Reverse
Prompt deliveries. Send for
prices and gasoline parts
catalog.
Looke Regulator Co.
Salem, Mass.

CANDY CARBIDE

For FRENCH AUTO LAMPS (Impregnation dans le vide)
Packed only in 10 lb. cans. Price, \$2 each.
Discount to Dealers in case lot of 12 cans.
SOLE MANUFACTURERS—
ACETYLENE GAS ILLUMINATING CO.
105 Walker Street, New York
In stock, all kind of imported Lava BURNERS (Bouillons
for Acetylene Auto Lamps.

DOW

COILS and PLUGS
ONE QUALITY
THE BEST
Send for New Catalog.
Dow Portable
Electric Company
Braintree, Mass.

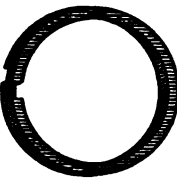

JORDEN PISTON RINGS
For Gas Engines, Steam
Hammers, etc., etc.
THE BEST RING MADE. Get
our prices. Hague & Co.
Sole Agents
for U. S. 6188 Penn. A. e.
Pittsburg, Pa.

AUTO-MASKS

GOGGLES and FACELIERES
Largest Line of Imported Specialties
and Original Productions
Write for Price List "H"
E. P. Meyrowitz
104 East 23d Street, New York
KENTWAPOLES ST. PAUL PARIS

\$5. PREPAID.

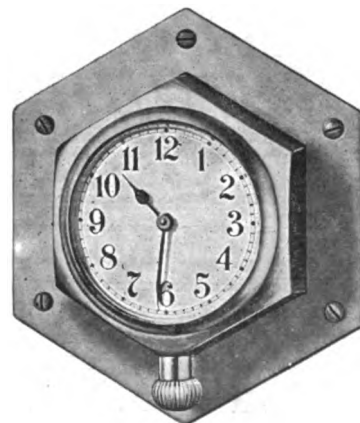

HIGH GRADE
HEX-DASH-CLOCK
FOR AUTOMOBILES.
Case of polished brass, dust and water proof.
Illustration about half size.
Manufactured exclusively by
A. N. CLARK & SON, - PLAINVILLE, CONN.

ONE DOLLAR



Don't worry about
Fire! You won't need
to if you equip your
Auto with The Light-
ning Fire Exting-
guisher. Dry
chemicals. Absolu-
te Death to Gas-
oline or Oil Fires.
Fully guar-
anteed.

A Maxi-
mum of
Protection
is fur-
nished in The
Lightning
Fire Exting-
guisher for a
Minimum Ex-
pense. Complete
in every detail.

Manufactured by
THE SUFFOLK CHEMICAL CO.
BOSTON, MASS.
Price, \$1.00 each, \$10.50 per doz.



"MEYERS" PUTZ CREAM

Will keep your auto shining.
Best polish made for Auto
Trimmings. Ask your dealer
or write us for sample.

MANUFACTURED BY
AMERICAN METAL POLISH CO., Boston, Mass.

McCANNA Force Feed Lubricators

Write for Booklet con-
taining valuable infor-
mation on proper oiling



McCord & COMPANY, 24 Broad Street
New York
Old Colony Building, Chicago

GILBERT TIRE CASE.



Protects the
extra tire
from water
and dust,
can be taken
off or put
on in a
moment;
made from
black enam-
el duck, to

fit all size tires.
Price, 28 or 30 in. tires, \$5.00
" 32, 34, 36 in. " 6.00

For sale at leading supply houses
and dealers generally. Write for
Catalogue of Auto. Fabric Supplies,
such as Leggings, Lamp Covers, Steer-
ing Knuckle Protectors and Covers
for Automobiles. Discount sheet for
jobbers and dealers on application.

GILBERT MFG. CO., New Haven, Conn.

SPEARE'S AUTO OILS



The only perfect lubricants. Thoroughly adapted to all sorts of automobiles under the varying conditions of road travel. Insist on having SPEARE'S and you'll never be stalled with hot journals as the cause.

THE ALDEN SPEARE'S SONS COMPANY, - 369 Atlantic Avenue, Boston.
 NEW YORK—100 William Street. Established 1851. CHICAGO—9 Milwaukee Avenue.



"ALL MICA" AUTO GOGGLE

PATENT APPLIED FOR

Lightest in weight—less than 1/2 oz. No glass to break or endanger sight. Can be worn over eyeglasses. No distorted view. Uninterrupted view in all directions. Well ventilated. Cool. Sent postpaid to any part of the U. S.

PRICE, \$1.00.

EUGENE MUNSELL & CO.,
 218 Water St., New York City.

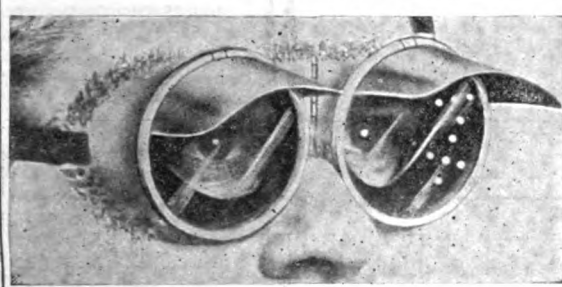

The Non-Strain Auto-Goggle

What Oldfield says about the Non Strain

Gentlemen.—The Non-Strain is the real thing. I use it in all my races and tours. It prevents the tremendous headaches caused by the ordinary goggle. It is a splendid thing for touring.

Yours sincerely,
 BARNEY E. OLDFIELD.

Order in time for the St. Louis Tour. \$3.00 by mail, circular and testimonials sent on request.

OPHTHALMUSCOPE COMPANY,
 Toledo, O., - 3322 Monroe St.

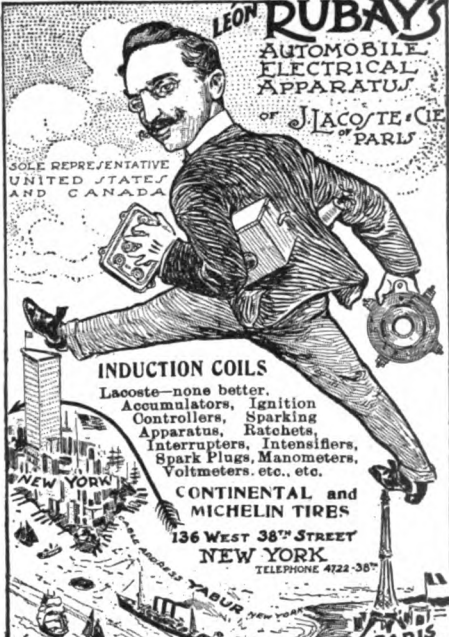

LEON RUBAYS
 AUTOMOBILE ELECTRICAL APPARATUS
 of JACOITE & CO. PARIS

SOLE REPRESENTATIVE UNITED STATES AND CANADA

INDUCTION COILS
 Lacoste—none better.
 Accumulators, Ignition Controllers, Sparking Apparatus, Ratchets, Interrupters, Intensifiers, Spark Plugs, Manometers, Voltmeters, etc., etc.

CONTINENTAL and MICHELIN TIRES
 136 WEST 38th STREET
 NEW YORK
 TELEPHONE 4722-367

St. Louis Trip?

Veeder Odometer!

*"It's nice to know
 How far you go."*

THE VEEDER MFG. CO., 22 Sargeant St. HARTFORD, CONN.

CYCLOMETERS, ODOMETERS, TACHOMETERS, COUNTERS!!
 AND FINE CASTINGS

Kingston Carbureter

OVER 16,000 IN USE

PAT. MAY 12, 1903
 Other Patents Pending



KINGSTON

Carbureters, Mufflers, Spark-Coils, Spark-Plugs, Steering Wheels, Pumps, Oiling Devices, Etc.



BYRNE, KINGSTON & CO.
 Kokomo, Ind., U. S. A.

THE PEDERSEN IMPROVED OILERS

are the most reliable. An easy flow of oil always assured.



Finely finished they are an ornament on any car
 Write for Circular

J. T. PEDERSEN, 642-644 First Ave., New York

WHEN WRITING TO ADVERTISERS PLEASE MENTION THE AUTOMOBILE

SOLVES THE

Bullock

IGNITION

PROBLEM.

THE BULLOCK-BERESFORD MFG. CO.
 CLEVELAND O

You want the Best because only the Best will give entire satisfaction

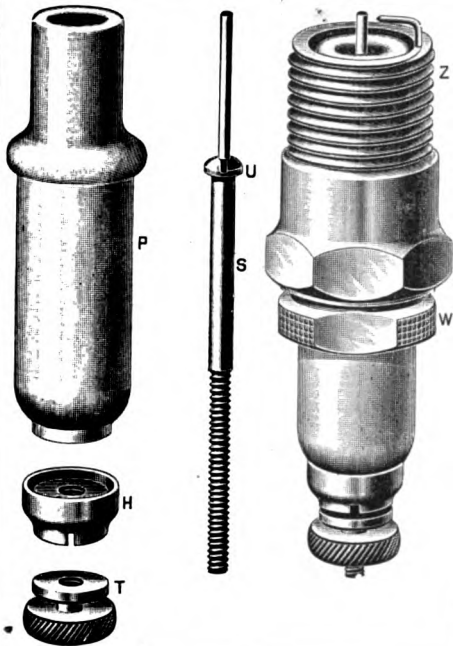

THERE IS ONLY ONE BEST SPARK PLUG.

It is called
“SOOT-PROOF”

and it will pay you to try it. Has stood the test for three years under conditions that have put other spark plugs out of business.

SOOT-PROOF PLUGS are made on scientific principles. They are reliable, efficient and durable.

Listed by leading jobbers and dealers.

By mail, \$2 postpaid.

C. A. MEZGER, M. E., 203 W. 80th St., New York

Irregular Ignition is caused by a bad Circuitbreaker.

THE HERZ-TIMER

works as promptly and accurately as a good watch. No Springs to bend or to vibrate. Sticking of vibrator impossible. Saving on current 50 per cent. A radical cure.

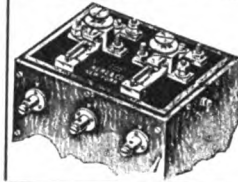

GUENET-COILS.
The Finest French Make.
Ignition Specialists
HERZ & CO.
55 Grand Street, NEW YORK.

SUBSCRIBE FOR THE AUTOMOBILE WEEKLY—\$2.00 PER YEAR

Save Trouble and Ask for the BRIGGS BATTERY CONNECTION



No Automobile Complete without these Connections.
ABSOLUTELY NON-SHORT-CIRCUIT
Sample Packages of Connections and Terminals, 50c. postpaid
W. H. BRIGGS, Manfr., 424 Bedford Ave., Brooklyn, N.Y.
SPECIAL PRICES IN QUANTITIES.



Dixon's Graphite Motor Chain Compound

Prevents rust and wear,
Provides excellent lubrication.

Special circular 9-S upon request.

JOSEPH DIXON CRUCIBLE CO.
JERSEY CITY, N. J.
N. Y. City Salesroom, 68 Reade St.

WHEN WRITING TO ADVERTISERS PLEASE MENTION THE AUTOMOBILE.

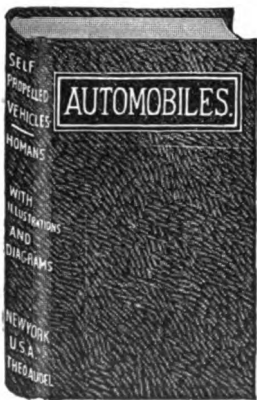

OWNERS OF AUTOMOBILES SHOULD HAVE Self-Propelled Vehicles

IN THEIR LIBRARIES

It's a new book by J. E. Homans, A.M., tells the whole story. It explains in simple, non-technical language the mechanism and management of every type of automobile. 640 pages; 500 illustrations; complete diagrams; ready reference index; \$2.00.

ADDRESS

BOOK DEPT., CLASS JOURNAL CO.
Flatiron Bldg., Madison Sq., New York

Engine Repairs!

American and Foreign Cars repaired in a first-class manner. Difficult work solicited.

AUTOMOBILE BODIES!

Aluminum or wood, of all designs, built to order. Delivery Wagons and Trucks. Painting, Upholstering, Touring Tops, Storm Covers, etc.

GENERAL AUTO. AND REPAIR WORKS,
764 Eleventh Ave., near 54th St.,
Telephone, 4267 Columbus. **NEW YORK.**

BOOKS FOR AUTOMOBILISTS and MOTORCYCLISTS

- The Practical Gas Engineer, E. W. Longnecker.....\$1.00
- Gas Engine Hand-Book, E. W. Roberts, M. E.....\$1.50
- Gas, Gasoline and Oil Vapor Engines, Gardner D. Hiscox, \$2.50
- Gas Engine Construction, Henry V. A. Parcell and A. J. Weed, \$2.50
- Horseless Vehicle, Automobile and Motorcycles, G. D. Hiscox, \$2.00

THE AUTOMOBILE

Flatiron Building, Madis on Square, New York

COME OUT OF THE DARK

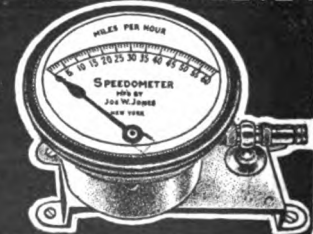

A NEW Automobile Law now in effect allows \$100 fine for exceeding the speed limit. "Come out of the Dark" and equip your car with a Jones Speedometer; the speed of your machine is constantly and accurately indicated. Send for our interesting literature on the subject.

Jones Speedometer, 126 West 32d St., New York

ON THE RUN TO ST. LOUIS

USE HARRIS OILS AND AVOID TROUBLE

Having for the past fifteen years furnished oils for Gas Engine lubrication, we have perfected lubricants which fulfill all requirements of the various types of motors.

We have established grades recognized as the standard for water cooled, air cooled, or splash system, as well as for the steam carriages, using either saturated or superheated steam, and electric vehicles.

Send us the make of your Car or Motor and let us suggest the grade most suitable

A. W. H. GAS ENGINE CYLINDER
(Medium Bodied Oil)

EXCELLO GAS ENGINE CYLINDER
(Very Light Bodied Oil)

SUPER GAS ENGINE CYLINDER
(Heavy Bodied Oil)

HARRIS S. H. CYLINDER
for Steam Carriages

HARRIS AUTO ENGINE
for External Parts

HARRIS MOTOR GREASE
for Use in Compression Cups

HARRIS GRAPHITE GREASE
for Chains and Gears

FOR SALE AT ALL THE PRINCIPAL AUTOMOBILE STATIONS AND GARAGES THROUGHOUT THE COUNTRY, OR

A. W. HARRIS OIL CO.,

330 South Water St.,

Providence, R. I.

JULY 25

Left Boston on time. Car runs fine-never had any trouble with it anyway.

JULY 26

Springfield last night. Arrived at Albany tonight - in the lead. This is dead easy.

JULY 27

Hundred miles today. Arrived at Utica tonight. Running is fine - there's nothing like it.

JULY 28

Short run to Syracuse. Big bunch behind. Never saw a machine run better - no trouble whatever - it's the best ever.

JULY 29

Run out of oil today. Borrowed enough to get to Rochester. Got some oil, cleaned machine and re-oiled up.

JULY 30

Had trouble all day - got to Buffalo late tonight. Will have machine thoroughly overhauled tomorrow.

AUGUST 1

Got as far as Fredonia tonight. Lots of trouble. Buffalo machinist said poor oil - gave me another kind - no improvement.

AUGUST 2

Erie tonight - one day behind. Machine seems alright but oil carbonizes in the cylinder.

AUGUST 3

Made Connelville tonight. Car ran badly all day - tried three different oils - not one was good.

AUGUST 4

Was towed into Geneva tonight. Will try it one more day and if trouble continues will ship back to Boston and go on to St Louis by train.

AUGUST 5

Reached Cleveland by good luck - happy thought - telegraphed my Boston garage for name of no-trouble oils.

AUGUST 6

Boston garage say "get Harris Oil". Got Harris oil, cleaned thoroughly and re-oiled with Harris oil - started out three days behind. Run fine today - will catch up.

AUGUST 8

Caught bunch in Chicago Sunday afternoon. Left with the leaders - arrived at Pontiac in fine shape tonight.

AUGUST 9

Easy running to Springfield. No troubles at all since I got Harris Oils. Tomorrow we hit St. Louis.

AUGUST 10

Arrived at St. Louis on schedule. Fine parade - received with enthusiasm. Never before realized the troubles caused by poor or unsuitable oils. I saw hundreds of breakdowns from Cleveland on - gave the "Harris Oil" tip to all. I give it now to you. Yours truly,
A. N. Automobilist



THE MOSS PHOTO ENGRAVING CO.

PUCK BUILDING
Elm St. Cor. Houston
NEW YORK.

There must be some reason why we make seven out of ten
Automobile cuts.

Write us in relation to half-tones, zinc etchings, wash draw-
ings, electrotyping or any other work you may want.

Work intrusted to us will not only be done well, it will be
done quickly and reasonable.



TELEPHONE 81 SPRING.

ESTABLISHED 1871.

STEEL HIGHWAY TRACK

UNITED STATES DEPARTMENT OF AGRICULTURE ADVOCATES STEEL TRACKS FOR HIGHWAYS

THE Secretary of Agriculture, a short while ago, determined to undertake through the Road Inquiry Bureau, a test as to the utility of a steel track, made and laid so that vehicles without flanged wheels might have the great advantage of a smooth track, heretofore enjoyed only by those having flanged wheels.

Hon. Martin Dodge, Director of the Road Inquiry Bureau, began preparations to build a sample steel-track wagon road which should permit of making tests as to value, cost and utility of such a road. For this purpose he secured considerable space on the grounds of The Trans-Mississippi Exposition at Omaha. The Illustrations here given show the result of his test. We quote the following from the Director's Report:—

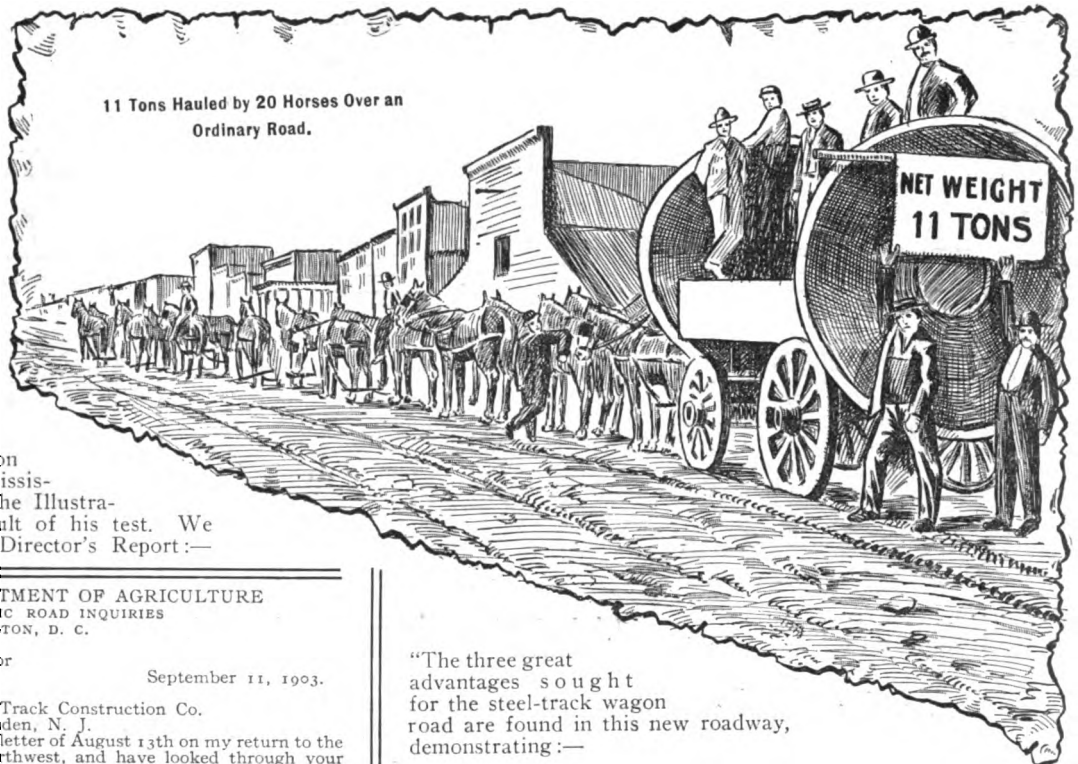

11 Tons Hauled by 20 Horses Over an Ordinary Road.

UNITED STATES DEPARTMENT OF AGRICULTURE
OFFICE OF PUBLIC ROAD INQUIRIES
WASHINGTON, D. C.

MARTIN DODGE, Director
M. O. ELDRIDGE, Assistant Director

September 11, 1903.

Mr. Thomas H. Gibbon
Chief Engineer, Steel Highway Track Construction Co.
Security Trust Bldg., Camden, N. J.

Dear Sir:—I have just received your letter of August 13th on my return to the office after a long absence in the Northwest, and have looked through your thesis on steel highway track construction with much interest. For cheapness, simplicity and durability, I have never seen its equal, and have no doubt that you will be very successful in introducing your new steel highway track for general service. I hope to see a good example of this in operation in the near future, and shall be glad to have you notify me of any work that you may have in progress of construction. Regretting that I was not at the office when you called on me, and hoping to see you in the future, I remain, Yours truly

Martin Dodge,
Director.

"The three great advantages sought for the steel-track wagon road are found in this new roadway, demonstrating:—

- "I.—That the steel-track wagon road can be built without greater cost in most cases, and probably with less cost in many cases, than any other hard and durable road.
- "II.—That it will last many times as long as any known material for road purposes, and with much less repair.

"III.—That the power required to move a vehicle over the steel-track road is only a fraction of the power required to move the same vehicle over any other kind of a road."

Correspondence solicited relative to the formation of subsidiary companies to operate under State Rights. Full details, estimates, etc., supplied promptly

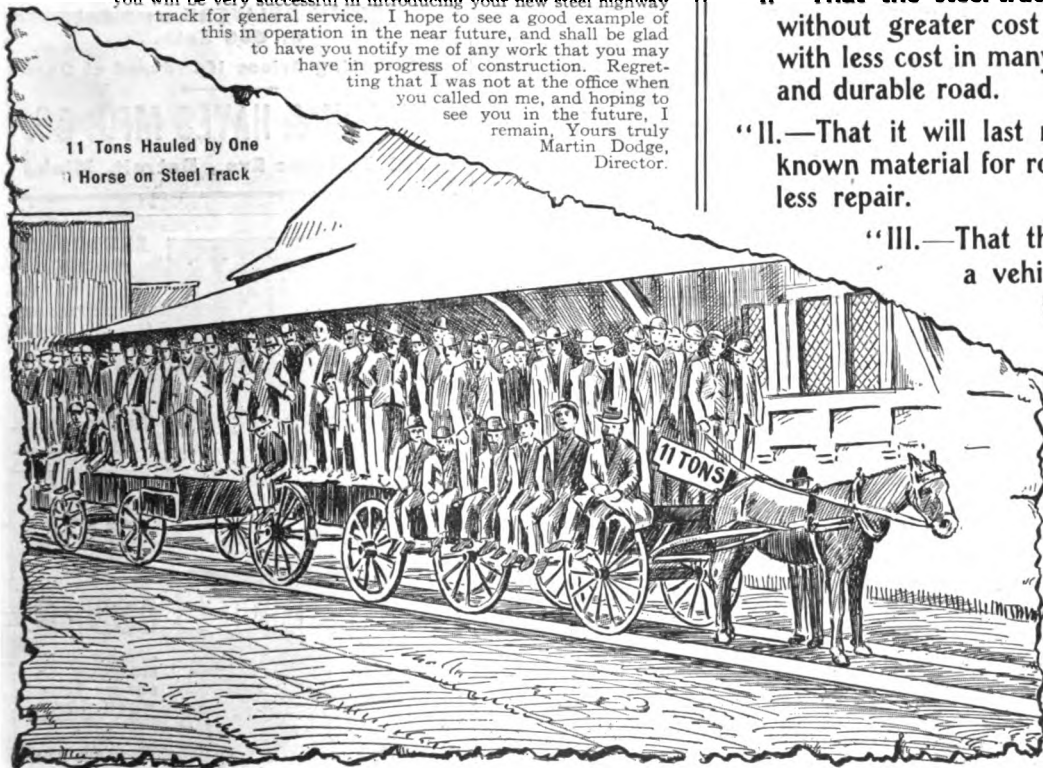

11 Tons Hauled by One Horse on Steel Track

STEEL HIGHWAY TRACK CONSTRUCTION CO. OF AMERICA

NEW YORK OFFICE: 114-118 Liberty Street

HOME OFFICE: 758 Drexel Building, Philadelphia

Laminated Wood Mud Guards

We Make Fenders for Any Style Machine. We Carry a Stock on Hand.

AMERICAN VENEER COMPANY,

100 Market St., New Orange, N. J.

1905 Styles SIDE ENTRANCE AUTO BODIES

In the white or finished complete

BIDDLE & SMART CO., Amesbury, Mass.

CANOPY TOPS

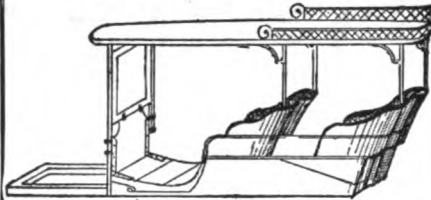

ALL STYLES LATEST DESIGNS

Plate Glass or Celluloid Folding Front. Best work and reasonable prices. Send for quotations giving name of your car and style wanted. Write for illustrated catalogue of Detachable Limousines carried in stock.

THE LIMOUSINE AND CARRIAGE MFG. CO.

O. C. GRAFF, GEN. MGR.,
542-544 WABASH AVENUE, CHICAGO

FINE HAND FINISHED BODIES.



Correspondence solicited.

RIVERSIDE BODY FACTORY,
BUFFALO, N. Y.

QUINBY AUTOMOBILE-BODY DEPARTMENT

1534 BROADWAY, Cor. 45th ST.
EMERSON BROOKS, MANAGER.

PHONE, 6536-38TH ST.

ROYAL HAMPERS

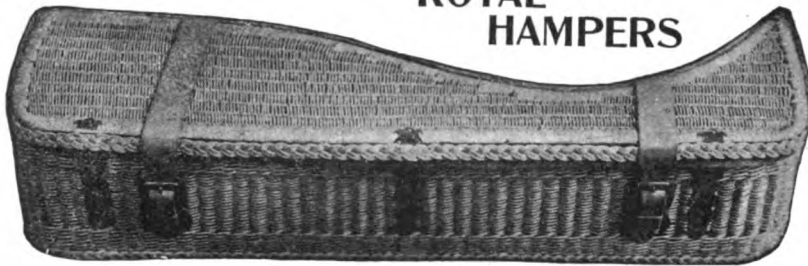

Royal Hampers at special, money-saving prices

High-Grade Hampers perfectly finished, in new designs for all the 1904 cars.

PICTURES AND FULL INFORMATION.

The Post & Lester Co.

15 Sargeant Street,
HARTFORD, CONN.



N. H. SNOW & CO.

26 Hawley St.
BINGHAMTON, N. Y.

Automobile Tops & Trimmings

All Styles and Prices

MUD GUARDS

TO FIT

OLDSMOBILES

OR OTHER

RUNABOUTS

With Forged Irons Ready to Attach.

QUICK DELIVERY on 1 Set or 500 Sets.

Interesting Prices if Ordered at Once

WILSON & HAYES MFG. CO.

770 Bellevue Ave., Detroit, Mich.



NEW YORK BRANCH,
BROADWAY & 38TH ST.

PHILADELPHIA BRANCH,
318-320 N. BROAD ST.

BOSTON BRANCH: 202-204 COLUMBUS AV.

THE MOST COMPLETE CATALOG OF ITS KIND MAILED ON REQUEST.



ALUMINUM BODIES

Springfield Top (Patent Pending)
Aluminum Fenders and Aluminum Hoods
SPRINGFIELD METAL BODY CO.
11 CYPRESS ST.
Springfield, Mass.

This Wrench is Made of 50-POINT OPEN HEARTH Drop Forged Carbon Steel

ORDER ONE TO-DAY



5 IN 1
NUT WRENCH, PIPE WRENCH,
THREAD CUTTERS.

THE BEST AND MOST USEFUL AUTOMOBILE WRENCH

Should be in the tool box of every Automobile. Will be used more times because can be used more ways than any other wrench made

Full Nickel-Plated \$1 50 Delivered Prepaid

Should be Handled by all Supply Dealers

HAWKEYE WRENCH CO., Manufacturers
Marshalltown, Iowa, U.S.A.

HAS MORE USES THAN ANY OTHER WRENCH MADE

YOU CAN'T BREAK THE JAWS OFF THIS WRENCH



BOLTS BEFORE AND AFTER USING THE HAWKEYE

CANOPY TOPS

For

Cadillacs



or other Standard makes. Cut shows front when down, which is celluloid in frame. When not in use can be fastened on deck. No

extra weight, all curtains equipped with lights.

All kinds of automobile trimmings, tops, aprons and cushions. Satisfaction guaranteed.

BERG & LEINBACH

Phone: Main 3544J, 238 Jefferson Ave., DETROIT

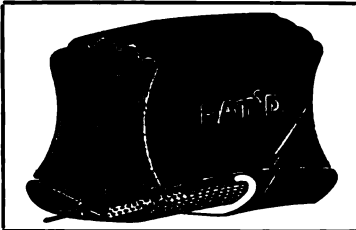

CLOSSON POINT AUTO. TRANSPORTATION CO.

Largest individual users of Knox Cars have adopted Swinehart tires on all their cars. You should do the same.

THE SWINEHART CLINCHER TIRE & RUBBER CO., Akron, Ohio.

1784 Broadway, New York.



SCHUG JUMP SPARK COILS

FOR AUTOMOBILE, LAUNCH AND STATIONARY GASOLINE ENGINES

Schug Electric Mfg. Co. Detroit, Mich.

Atwood "STAYLIT" Lamps

ATWOOD MFG. CO.

AMESBURY, MASS.

IT'S AWKWARD to be caught on a hill without power and WITH A BRAKE THAT WON'T LOCK. **VICTOR RATCHET FOOT LEVER** for brakes changes all this, and can be fitted to any car in a few minutes.

Steam Runabout Size, \$8.50
Oldsmobile, Northern, \$8.50
Other Gasoline Cars, \$5.00

THE READING AUTOMOBILE CO.
6 South Fifth St., READING, PA.

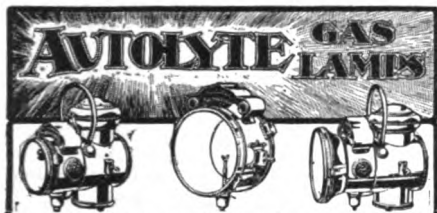

AUTOLYTE GAS LAMPS

The lamps that combine American ingenuity and foreign experience—practical as well as ornamental. **THEY LIGHT THE WAY**

Prices \$7.50 to \$40. Automobile makers and dealers everywhere catalogue and recommend these lamps. Ask your dealer to show you the Autolyte Lamps and Generators, or write to us for booklet of lamps, horns and launch whistles.

A. H. FUNKE, 88 Chambers Street, New York.



PHARE ANGELICUS A NEW LAMP

Made by Experienced French and Italian Lamp Makers

THE MOST BEAUTIFUL LAMP EVER MADE
SEND FOR CATALOGUE AND PRICES

LUIGI ANGIULLI, Manufacturer, 180-182 Centre St., New York

COLUMBIA LAMPS

Light the way. They turn night into day

GUARANTEED

HINE-WATT MFG. CO., 58 Wabash Ave., Chicago

SAXON

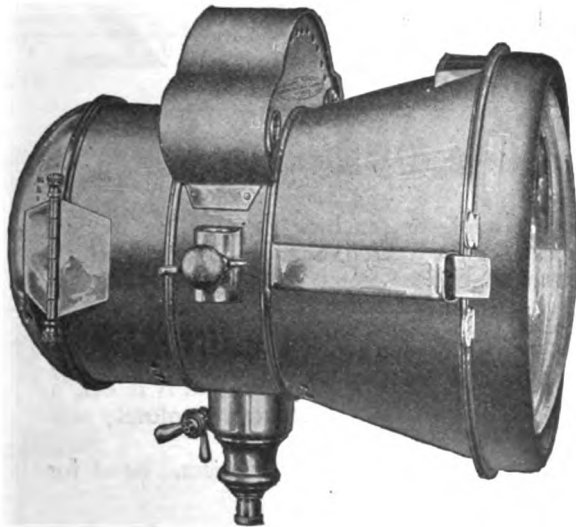

MOTOR LAMPS

Send for Catalog of Other Styles

MANHATTAN LAMP WORKS,

42-50 W. 67th St., NEW YORK, N. Y.



DON'T PUSH!

BUY A

DURO

BATTERY

AND

RIDE

DURO—Built for Durability

CHICAGO BATTERY CO.

1425 Michigan Avenue - - Chicago



WHEN WRITING TO ADVERTISERS PLEASE MENTION THE AUTOMOBILE.

GRAY AND DAVIS

ARE GOOD LAMPS
Be Sure YOUR CAR is Equipped With Them

AMHERST, MASS.

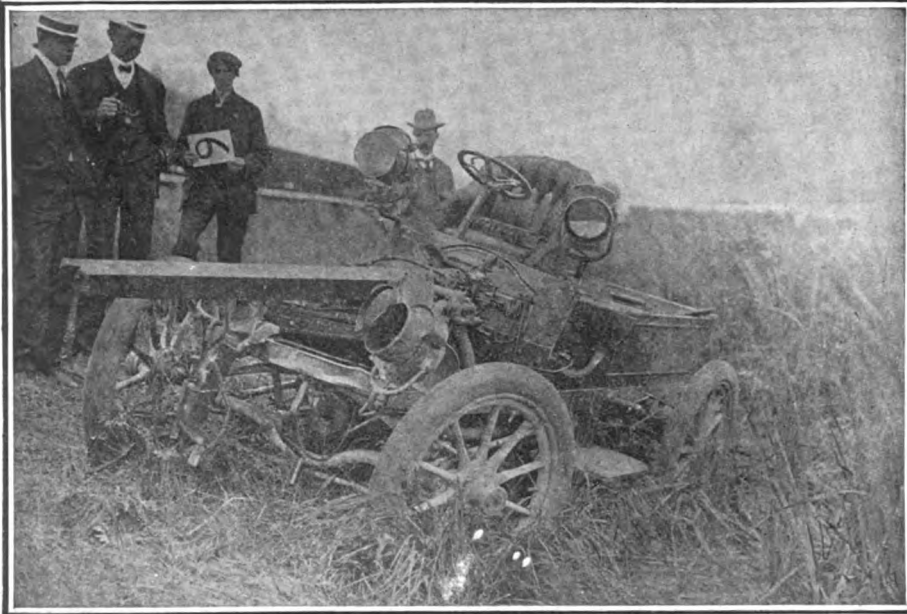

The Lights Went Out

FRIGHTFUL ACCIDENT TO THE PACKARD MODEL "L" RECORD CAR AT DETROIT. THE DESIGNER OF THE CAR NEARLY KILLED

ACCORDING to press reports three of the four lights went out and the remaining light was insufficient to show the track and the car smashed blindly into the fence.

The lights used probably cost less than the Rushmore Searchlights, but was there any economy?

With one of the smallest Rushmore Searchlights the accident could not have occurred.

The curse of most American automobiles is false economy. Insure your life to-day by adopting the Rushmore Light.

Rushmore Dynamo Works

PLAINFIELD, N. J.

A SUBSCRIPTION for *THE AUTOMOBILE* will cost you but \$2.00 per year, about 4 cents a copy. Published weekly



DIETZ LAMPS

are made wherever possible by machinery—all alike and all good. The parts are always interchangeable. No hand work can equal the strength and symmetry of that done in our up-to-date factory devoted to the manufacture of *Modern American Goods by Modern American Methods.*

Notice the convenient and safe way in which we fasten the oil pot to the lamp. A turn of the hand and it is off, a turn of the hand and it is on, and when on, absolutely safe from falling off.

All live dealers sell them at reasonable prices. Send for circular.

R. E. Dietz Company

33 LAIGHT ST., NEW YORK

ESTABLISHED 1840

MICHELIN VICTORIES

GORDON BENNETT RACE WON ON

MICHELIN TIRES

This is the third time Michelin Tires have won this famous cup.

The three cars in the French Team were ALL equipped with Michelin Tires and all finished in fine condition without a mishap.

Besides They, the winner of the cup, Rougier, the fourth man and Salleron, the seventh, rode Michelin Tires, making an unequalled record for this famous tire.

Michelin Tires Win First 1000 Miles Endurance Run

Michelin Tires equipped the 15-20 H.P. Darracq Car which made a phenomenal three days' non-stop run of 1,053 3-5 miles over the New York-Boston route four times. There was but one change of a tire on account of nail puncture; a new inner tube was used. This severe test showed Michelin Tires again the King of all Tires.

First Successful Run from N. Y. to St. Louis on Michelins

Mr. Wilson, who just made the run from New York to St. Louis, rode on Michelin Tires without a mishap. This is the very first run to St. Louis. Many attempts on other tires have been made.

Michelin Tires have been on more winning cars than any other tire in existence.

Why?

Write us and we will tell you.

United States Agency Michelin Tire Co.

140 West 27th Street, New York

Over 300 American Cars Equipped This Year with MICHELIN Tires

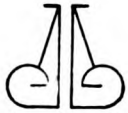

Rims branded in the channel with this copyrighted-mark have been inspected and pronounced perfect. We guarantee our tires only on rims so branded.

A GUIDE POST TO IMMUNITY FROM TIRE TROUBLES ON THE ST. LOUIS TOUR.



Diamond

1904 TIRES

NAPA GARAGE.

THE DIAMOND RUBBER CO.,
8 Beale St., San Francisco, Cal.
Gentlemen:

NAPA, CAL. May 22nd, 1904

As I am selling large quantities of tires and machines I thought perhaps it might interest you to know what success I am meeting with on your new 1904 Diamond Auto Tires.

Your new tire is giving perfect satisfaction. I have a number which have been out since December and January and which have seen the very hardest kind of service. Some of them were put on in place of other make tires, which went to pieces, and the Diamond tire up to this date is hardly even showing wear.

In no instances are your new tires separating or showing the least signs of such defects, and as to rim cutting, tubes blowing out, etc., such things seem to be utterly out of the question with your new tire. Nine people out of every ten who call at my garage for tires will have nothing but Diamond, and it looks to me that in the near future no other make will be sold in this territory.

Yours truly,
E. J. WILSON.

BRANCHES—EAST
NEW YORK, 15 Warren Street
NEW YORK, 1717 Broadway
BOSTON, 174 Columbus Avenue
PHILA., 304-306 No. Broad St.
BUFFALO, 41 Court Street

The Diamond Rubber Co.
AKRON, OHIO

BRANCHES—WEST
DETROIT, 310 Woodward Ave
CLEVELAND, 823 Huron Street
CHICAGO, 167-169 Lake Street
DENVER, 1655 Blake Street
SAN FRANCISCO, 608 Mission Street

It's the Dealer's Delight

to sell the P. & B. Tubular Steel Artillery Wheels, with detachable spokes, as he can quietly sit down and watch them leave him "for keeps," as we then assume responsibility for five years.

Our "Chat on Wheels" booklet will tell you all about it. Get it.

The
Parish & Bingham Co.
Cleveland.

OLD Tires Made NEW

NEW Tires Made Puncture Proof

THE **NEWMASTIC FILLING**

Just as Resilient as a Pneumatic
Just as Safe as a Solid Tire
How Do We Do It?
Write Us and Learn

MORGAN & HARDING
GENERAL AGENTS
3856 Olive St. St. Louis, Mo.

AUTO LEATHER

Our Leathers are used by most of the largest automobile manufacturers of this country Ask us why.

AMERICAN OAK LEATHER COMPANY
CINCINNATI ST. LOUIS CHICAGO BOSTON

FAST DRIVING

is the **BEST TEST** of the **QUALITY** of tires. When several machines are driven at the rate of 60 miles an hour for 6 hours and none of the machines lost any time on account of tire troubles, **SUCH TIRES ARE SAFE FOR YOU TO PUT ON YOUR CAR**

In the Gordon Bennett Cup Race in Germany on June 17th

CONTINENTAL TIRES



came in **FIRST** and **SECOND** of the German cars.

Four of the first 6 cars were equipped with Continental Tires. The heat and strain that the tires must endure in such a long and fast journey, is beyond comprehension. The American automobile owners are fast learning that the same tires that have done such wonderful work in Europe, are the tires for them to use in the future. American sizes now in stock.

Any high grade Automobile Manufacturer will put them on without extra charge **IF YOU INSIST.**

Even if you are asked to pay a small difference, you will save **50%** on your tire bills.

Send for catalog and price list.

The Continental Caoutchouc Co.

EMIL GROSSMAN, Manager

298 BROADWAY

NEW YORK

PRINCIPAL AGENCIES CARRYING STOCK:

New York—Smith & Mabley, Inc., 38th St. and 7th Ave.
Leon Rubay, 136 West 38th St.
Alexander Fischer, 237 West 50th St.
The Central Automobile Co., 1684 Broadway.
The Auto Import Co., 1786 Broadway.
American DeDietrich Co., 1 E. 34th St.
F. A. La Roche Co., West 38th St.
Albany, N. Y.—Albany Hardware & Iron Co.
Buffalo, N. Y.—Ephraim Bros., 557 Main St.

Binghamton, N. Y.—Sterling Motor Car Co., 184 Water St.
Rochester, N. Y.—Rochester Auto Co.
Boston, Mass.—The Angier Co., 43 Columbus Ave.
Washington, D. C.—The National Electrical Supply Co., 1330 New York Ave.
Chicago, Ill.—The Excelsior Supply Co., 237 E. Randolph St.
Philadelphia, Pa.—James L. Gibney & Bro., 828 Arch St.
John Wanamaker.

Pittsburg, Pa.—The Standard Automobile Co., East Liberty.
Detroit, Mich.—Automobile Equipment Co., 251 Jefferson Ave.
Cleveland, O.—The Automobile Garage & Repair Co., Huron St., near Euclid Ave.
St. Louis, Mo.—The Continental Tire Agency, F. O. Sawyer, Mgr., 2212 Olive St.
San Antonio, Tex.—The Rambler Automobile Co.
San Francisco, Cal.—Geo. H. Bill.

THIS is the Tire that TENNANT Built

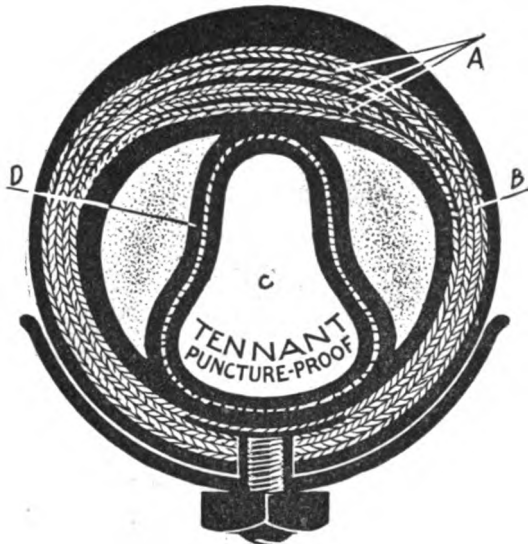

**This is the TREAD that lay in the TIRE
That TENNANT built**

- (A) These are the PUNCTURE PROOF STRIPS
That make up the TREAD
That lay in the TIRE
That TENNANT built.



This is the TACK that all of a sudden
Was turned aside by the PUNCTURE
PROOF STRIPS
That make up the TREAD
That lay in the TIRE
That TENNANT built.

- (B) This is the FABRIC of quality rare
That supports the TUBES that never will tear
That surround the SPACE that is filled with air
That the TACK so sharp had severely tried
That all of a sudden was turned aside
By the PUNCTURE PROOF STRIPS
That make up the TREAD
That lay in the TIRE
That TENNANT built.

- (C) This is the SPACE that is filled with air,
That the TACK so sharp had severely tried
That all of a sudden was turned aside
By the PUNCTURE PROOF STRIPS
That make up the TREAD
That lay in the TIRE
That TENNANT built.

- (D) These are the TUBES that never will tear
That surround the SPACE that is filled with air
That the TACK so sharp had severely tried
That all of a sudden was turned aside
By the PUNCTURE PROOF STRIPS
That make up the TREAD
That lay in the TIRE
That TENNANT built.

The remainder is RUBBER that is made to wear
And fills up the FABRIC of quality rare
That supports the TUBES that never will tear
That surround the SPACE that is filled with air
That the TACK so sharp had severely tried
That all of a sudden was turned aside
By the PUNCTURE PROOF STRIPS
That make up the TREAD
That lay in the TIRE
That TENNANT built.

TENNANT AUTO TIRE CO.

"THE HOUSE THAT BARNETT BUILT." SPRINGFIELD, OHIO

New York Office, 1900 Broadway and 63d Street
Chicago Office, 1461 Michigan Avenue

Look Here!

**SOMETHING NEW
— IN —
STEERING DEVICES.**

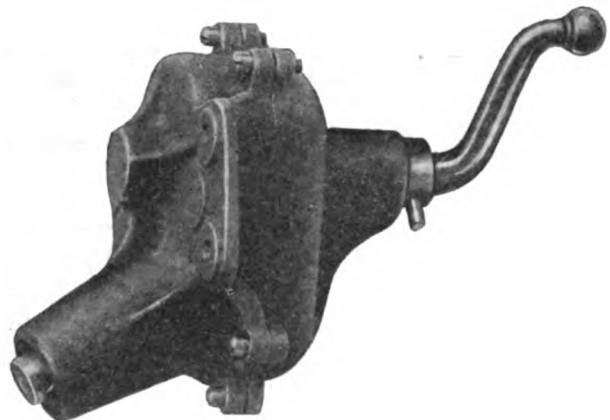

*Easy to Attach
No Lost Motion
Steel Gears Running in Grease
Simple and Compact
For Vehicles up to 1200 lbs.*



TRANSMISSIONS

THE "STANDARD"

8 and 20 H. P.

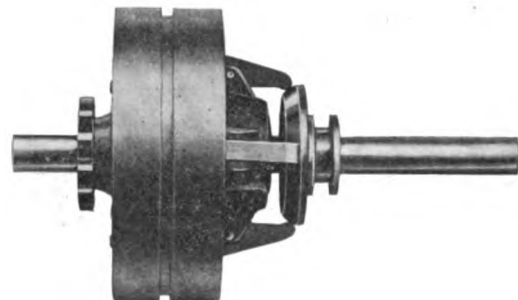

*Two Speeds Forward, and Reverse
Steel Gears cut from Solid Metal
Dust Proof Case
Gears Run in Oil
Parts Interchangeable
Write for Descriptive Matter and Prices*

The Automobile Supply Co.

Sole Selling Agents

1339 Michigan Boulevard • Chicago, Ill.

NO RUBBER IS USED IN THE MANUFACTURE OF *Packard* Ignition Cable

OIL, GREASE AND HEAT RUIN RUBBER
Packard Cable is insulated with oiled linen and varnish. The oil, grease and heat does it good
Ask for booklet B Specify that your 1904 car be wired with Packard Cable

THE PACKARD ELECTRIC CO., 412 North Ave., Warren, Ohio



A SUBSCRIPTION FOR THE AUTOMOBILE WILL COST YOU BUT
\$2.00 PER YEAR, ABOUT 4 CENTS A COPY, PUBLISHED WEEKLY



THE "Exide" BATTERY FOR ELECTRIC VEHICLES . . .

CLEVELAND, 23 Oak St.
NEW YORK, 49th St. and 8th Ave.
PHILADELPHIA, 280 North Broad St.
BUFFALO, 200 Pearl St.
ROCHESTER, 152 South Ave.
BOSTON, 29 Stanhope St.
DENVER, 1810 Court Place.

DEPOTS FOR THE PROMPT DELIVERY
AND CARE OF EXIDE BATTERIES.

SAN FRANCISCO, 7 Hawthorne St.
CHICAGO, 204 East Lake Street.
ST. LOUIS, 809 Walnut Street.
ST. PAUL, 370 Minnesota Street.
DETROIT, 285 Jefferson Ave.
TOLEDO, 715 Jefferson Ave.
PITTSBURG, 5905 Centre Ave.
COLUMBUS, 4th & Gay Sts.

THE ELECTRIC STORAGE BATTERY CO. PHILADELPHIA, PA.

SALES OFFICES: NEW YORK, BOSTON, CHICAGO, ST. LOUIS, CLEVELAND, SAN FRANCISCO, TORONTO, CANADA



ACCESSORIES OF EVERY DESCRIPTION

Many New Specialties
Illustrated Catalogue Sent on Request

Auto Supply Company, Broadway and 50th St., N. Y.



JUMP SPARK COILS

For Automobile, Launch and Stationary Engines

Send for Booklet

THE INDUCTION COIL CO
Milwaukee, Wis.

Agencies: The Sta-Bite Co. Room 20, 629 Broadway N. Y.,
Neustadt Co., St. Louis; T. Bissell Co., Toledo.

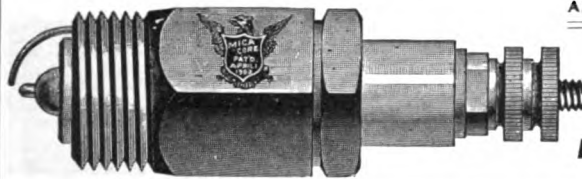

AMERICAN PLUGS

(Double insulation of Mica)

150,000 IN USE

Satisfied customers are our best advertisement

New illustrated Catalog Ready!

AMERICAN COIL CO.,
W. Somerville, Mass.



Is the most satisfactory ignition plug in the world at any price. More sold than all other advertised American made plugs combined. 18 sizes; Olds, Ford, Rambler, Northern, Queen, Peerless, Packard, Orient, Panhard, etc., \$1.50. Winton, Auto-car, Thomas, Locomobile, Knox, etc., \$1.75. Mica plugs, \$2.00. Cadillac size plug, \$3.00. New No. 17 size, \$5.00. Best porcelain obtainable used. Get a set right away. Send for complete catalogue and discounts. Dynamos, Coils, Meters, etc.

THE R. E. HARDY CO.,

Formerly Detroit Motor Works, Inc., 1900.

P. G. DASEY

156 JEFFERSON AVE.,

435 Wabash Ave., Chicago. DETROIT, MICH.

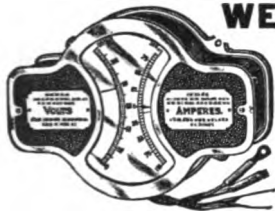

WESTON ELECTRICAL INSTRUMENT CO.

Electrical Measuring Instruments,

FOR USE IN

Electrical Carriages and in Charging Stations

Send for Catalogue

WORKS: - Waverly Park, NEWARK, N. J.

New York Office, 74 CORTLANDT ST.



Switchboard Instrument Type K.

Combination Volt and Ammeter, Model R.

Storage Batteries

The Northwestern Storage Battery Co.

284 Madison Street,

CHICAGO, ILL.

WHEN WRITING TO ADVERTISERS PLEASE MENTION THE AUTOMOBILE

Briscoe Radiators

Briscoe Radiators, Fenders and parts are used on more Automobiles than all other makes combined. Our catalogue tells you why. Write us a postal for it, now. BRISCOE MFG. CO. 1431 Woodward Ave., Detroit, Mich.

Fenders and Parts

WILLARD Storage Batteries

MANUFACTURED BY

The Willard Storage Battery Co., Cleveland, O.

SUBSCRIBE FOR THE AUTOMOBILE

WEEKLY - \$2.00 PER YEAR

STANDARD AUTOMOBILE PARTS

Pressed steel frames, pressed steel hubs, malleable hubs, brakes, steering gear, chains, transmission gears, engine cranks, mufflers, front axles (tubular and forged), rear axles (chain and bevel gear drive), electric truck parts.

FEDERAL MANUFACTURING COMPANY, ELYRIA, OHIO.

Selling Agent-Hayden Eames, American Trust Building, Cleveland

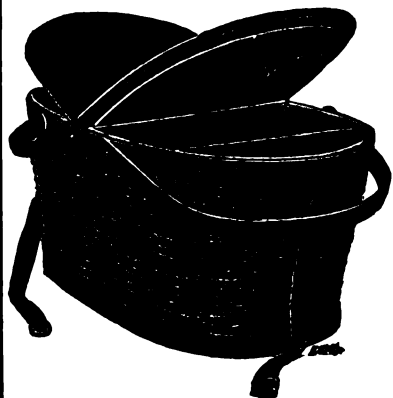

KEEP COOL A Necessity for Every Tourist SENT ON APPROVAL

THE HAWKEYE REFRIGERATOR BASKET keeps contents ice cold throughout the longest Summer day.

Dr. R. F. C. Browne, of 176 Broadway, Providence, R. I., writes us May 31st, 1904, as follows:

"The Hawkeye Refrigerator Basket that I purchased from you was one of the best investments I ever made. It is simply great! For fishing, picnicking, touring and yachting it fills a long-felt want. If I could not get another, I would not take \$100 for the one I have. Wishing you all success, etc."

Further comment is hardly necessary.

No. 1 size, 18-10-8 in. deep, \$8.25. No. 2 size, 20-15-10 in. deep, \$8.50

ORDER ONE TODAY, test it for ten days, and if you do not find it perfectly satisfactory return it at our expense, otherwise send us your check for the amount.

DESCRIPTIVE BOOKLET FOR THE ASKING

BURLINGTON BASKET CO., - 33 Main Street, Burlington, Iowa

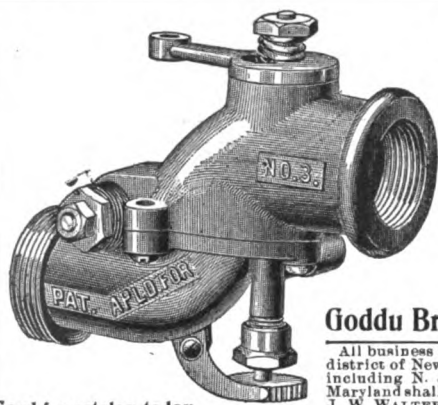
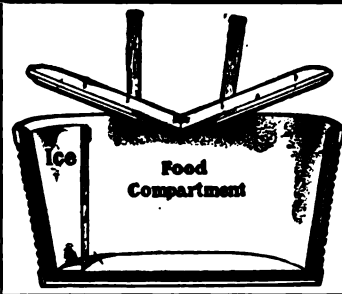

INVESTIGATE The Construction of the **IDEAL MIXING VALVE**

and you will then understand why it increases the power of your ENGINE from 10 to 20 per cent.

Goddu Bros. Winchester, Mass.

All business and correspondence in the district of New York State and westward, including N. J., Penna., Delaware and Maryland shall be done through our agent, J. W. WALTERS & Co., 12 Park St., Jersey City, N. J.

Send for catalog today

The Tire Question Solved

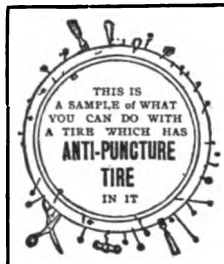

We manufacture the only Puncture Proof Inner Tube Tire in the world. It can be fitted into any pneumatic tire by the owner or at our factory, 132 West 49th Street, New York City. It saves money, anxiety and trouble. Has withstood the most severe tests for years, and is guaranteed to do all we claim for it. Write for circular, prices, etc.

Agents Wanted

N. Y. Anti-Puncture Tire Co.

Telephone 6921 38th Street

The CRANDALL MECHANICAL LUBRICATOR ENDS YOUR TROUBLES

It is the very best thing of the year. Can be applied to any car, and will increase the efficiency of any motor. *The only oiler that oils*

**National Sewing Machine Co.
Belvidere, Ill.**

New York Chicago San Francisco

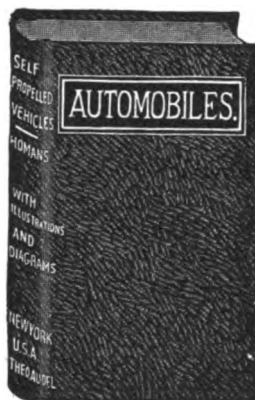

OWNERS OF AUTOMOBILES
SHOULD HAVE

Self-Propelled Vehicles IN THEIR LIBRARIES

IT'S a new book by J. E. Homans, A.M., tells the whole story. It explains in simple, non-technical language the mechanism and management of every type of automobile. 640 pages; 500 illustrations; complete diagrams; ready reference index. \$2.00.

ADDRESS

BOOK DEPT., CLASS JOURNAL CO.
Flatiron Bldg., Madison Sq., New York

COL. SPRAGUE'S CANOPIES

... FOR ...

Automobiles,
Touring Cars,
Surreys,
Stanhopes,
Runabouts, Etc.



Wagon Umbrellas,
Lawn Canopies,
3-Bow Tops,
Advertising Umbrellas.

Send For Price List
and Catalogue.

COL. JAS. H. SPRAGUE.

The Sprague Umbrella Co.

NORWALK, OHIO.

The Apple DON'T WAIT

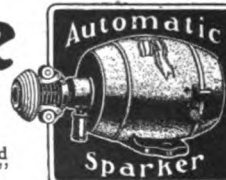

until your battery fails you and you have had the annoying experience of being "towed back" before you investigate the

Apple Automatic Sparker

A neat, compact little dynamo that gives a steadier, more reliable and hotter spark, increasing the speed and power of your engine. For Automobiles, Motor Boats and Gas Engines of all sorts.

Always ready to start; dust, oil and water proof. You should know more about it. Why not write for full information regarding our ignition apparatus to-day?

THE DAYTON ELECTRICAL MFG. CO.

90 Reibold Building,

DAYTON, OHIO

"A stitch in time saves nine."

We insure your
AUTO
 for \$1.00

 ACTUAL
 SIZE

AUTO FIRE EXTINGUISHER
 ESPECIALLY COMPOUNDED FOR USE ON
AUTOMOBILES

A SURE DESTROYER
 of fires originating from
 NAPHTHA, GASOLINE,
 OIL or ELECTRICITY.

DIRECTIONS.
 Simply take a quantity
 of the powder in the
 hand and throw forcibly
 at base of fire.
 Guaranteed not to affect
 or injure the finest ma-
 chinery.

"It Works Like Magic."

PRICE \$1.00
 (8 lbs.)
 MANUFACTURED BY THE
NATIONAL COMPOUNDING CO., Worcester, Mass.
DRY POWDER COMPOUND

Convenient to carry.
 Always ready.
 Sure death to fire.

ACTUAL
 SIZE



Put up in tin boxes 5 1-2
 in. diameter x 3 in. deep.

Sent *prepaid* during July on
 receipt of \$1.00.

Above cut shows our
water cooled, four cycle

MOTOR

guaranteed to be
 free from defects
 in workmanship
 and material.

Bore, 3 3/4",
 Stroke, 3 1/2",
 giving 4 H. P. at
 1,600 R. P. M.

PRICE,
\$45.00.

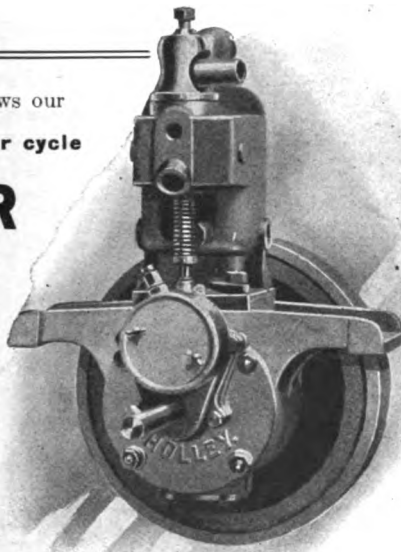

WE ALSO HAVE
 FOR SALE:

- | | | |
|---------------------------------|----------------------------|------------------------|
| Running Gear
\$45.00 | Bodies
\$7.50 | Hoods
\$3.00 |
| Carbureters
\$10.00 | Chains
\$3.50 | |
| Transmissions
\$45.00 | Radiators
\$5.00 | |

Write for Catalog and Price List.

BRADFORD MOTOR WORKS,
 SUCCESSORS TO HOLLEY MOTOR CO.,
 BRADFORD, PA.

TO Owners who pay from \$10.00 to \$100.00 per month for repairs to
 their autos, it will pay to investigate this.

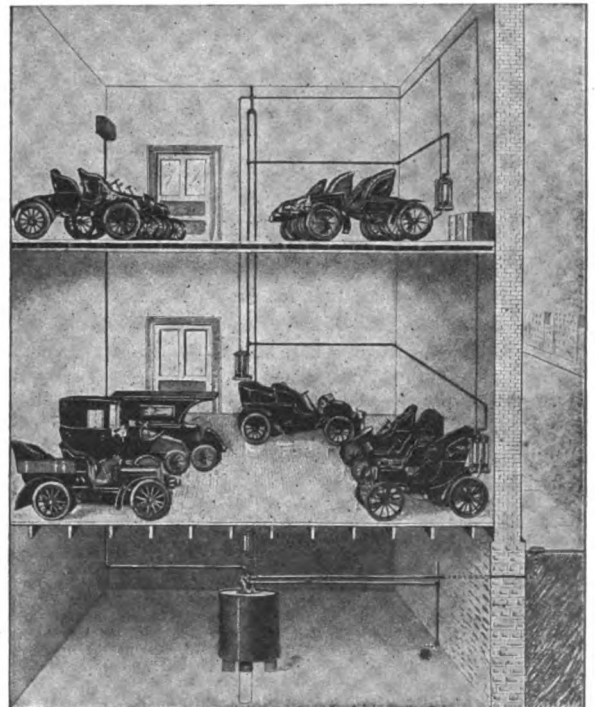

It is the **ONLY** system for storing and handling gasoline, which **CAN NOT BE EXPLODED**
 by fire, electric spark or lightning.
 It is the **ONLY** system that is **ENTIRELY EVAPORATION PROOF.**
 It is the **ONLY** system that needs **NO PUMPING**; simply turn the faucet same as water,
 and the flow begins.
 It is the **ONLY** system that feeds **PURE, CLEAN GASOLINE FROM TOP OF TANK.** The
 danger of getting water and dregs, quite common with other systems, with your gasoline
 when drawn from the bottom of the tank, which causes a large percentage of your repair
 bills, **IS ENTIRELY OBLIATED** in our system.
 Our prices are a little higher than some of the other systems, but only the best material,
 tanks and valves are used in our system.
 We guarantee all we claim. For further particulars apply
VAN HUSAN & FARR CO., Sole Licensees for Snell's Systems (patented).
 General Offices: 518-521 Hammond Building, **DETROIT, MICH., U. S. A.**

ANDERSON'S IGNITION PLUGS

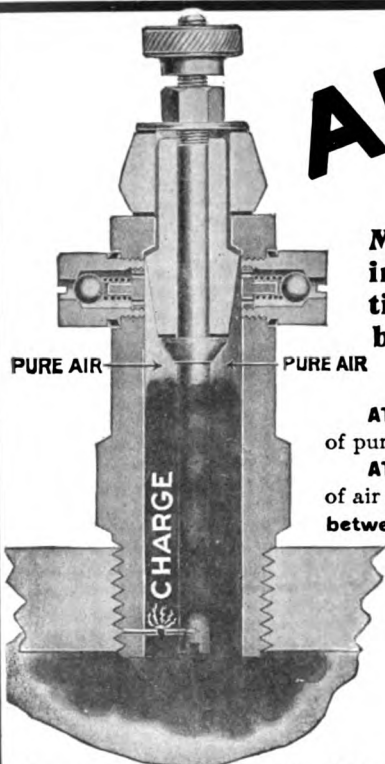

Note the relative position of insulation, pure air, charge, and spark at the instant of explosion.

Maintain a covering of pure air over the interior insulation during the entire operation of the engine, which serves as a barrier between the charge and the insulated surface, and effectually prevents short circuiting.

AT EACH SUCTION STROKE OF THE ENGINE a very minute quantity of pure air is drawn into the base of the plug through suitable air inlets.

AT EACH COMPRESSION AND EXPLOSION STROKE this small quantity of air is forced back against the insulated surface, and remains interposed between the charge and the insulated surface.

AT EACH EXHAUST STROKE the pure air expels the products of combustion from the body of the plug.

Extended use with various mixtures under various conditions has shown that the forward end of the plug may become heavily coated with a deposit of carbon, but the porcelain remains free from such deposit.

Patents covering the principle and construction of this plug are pending in the United States and Foreign Countries.

1/2-inch standard pipe thread...\$3.00	1/2-in. standard pipe thread.....\$3.25
18 M.M. METRIC thread 3.00	AUTOCAR " " 3.25
WINTON SPECIAL 3.00	LOCOMOBILE " " 3.50
1/2-in. pipe thread with shoulder 3.25	KNOX " " 3.50

DISCOUNTS ON QUANTITY ORDERS.

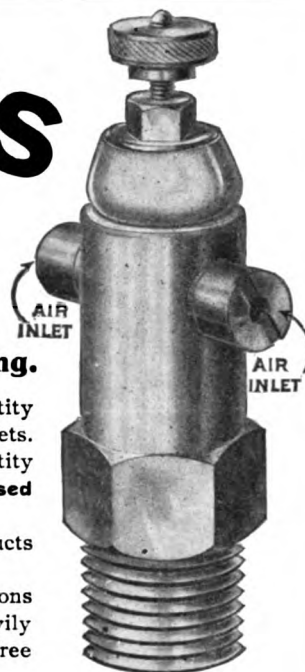

The fact that a plug sparks in oil signifies nothing; oil is an insulator, whereas carbon deposit is a relatively good conductor of high tension currents

Some plugs are claimed to be soot-proof, some to spit fire, some have so-called compression chambers, but ours is simply

A SCIENTIFICALLY DEVELOPED PLUG, WELL CONSTRUCTED.

Manufactured by **The J. C. Anderson Mfg. Co., Inc.,** 110 & 112 Cambridge Ave., Jersey City, N. J.

THE "COUFFIELD" GRAND RAPIDS, MICH. U.S.A.

(Rapid
Transit in
Your
Office)

Vertical System of Filing Letters

Is an advanced idea in office work—an improvement over the common "flat sheet" method. Letters can be referred to instantly without any sorting whatever, and mistakes in filing are a rarity. Once a "Couffield" Sectional Vertical File is installed, it becomes a "fixture"—it need never be discarded for lack of capacity. Additional filing space can be added as required without any inconvenience. There are many other exclusive features which mean a real saving of valuable time and which make the purchase of a "Couffield" File a most profitable investment.



HERE IS OUR EVIDENCE!

The International Harvester Co. of America write: "The file has been in service now for some time, and we find it serves our wants to perfection. You are certainly giving the best values of anyone in the same line of business." Bering-Cortes Hdw. Co., Houston, Tex.: "We find your system very satisfactory, as is evident by our ordering four more sections." C. H. Perkins Co., Newark, N. Y.: "Should we be in the market at any time for additional requirements in your line, you may be assured that we shall look to you for our supplies." Gauley Mt. Coal Co., Ansted, W. Va.: "Your vertical files have proved very satisfactory."

A request on your business letter-head will bring our catalogue "A-45," with full information. And remember, that

"Couffield Pays the Freight"

H.L. COUFFIELD CO., 233 O St., Grand Rapids, Mich.
MAKERS OF UNIT SECTIONAL FILES AND CARD SYSTEMS



COMPLETE FRONT AXLES
 COMPLETE REAR AXLES
 ARTILLERY WHEELS
 CHANNEL RIMS
 GUARANTEED FOR 2 YEARS

See Our Exhibit at World's Fair, Transportation Building

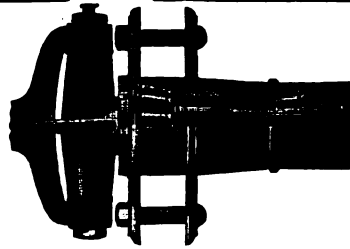

The most prominent Auto builders are using our bearings. Only Roller Bearing capable of taking up all wear.

Timken Roller Bearing Axle Co.
 CANTON, OHIO

ALUMINUM

THE PITTSBURG REDUCTION CO.
 PITTSBURG, PA.

Aluminum Automobile Parts a Specialty

SPROCKETS

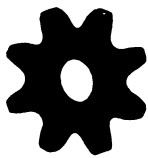

AND EQUALIZING GEARS
 In Stock or to Order
 Standard Makes of Chain on hand. Prompt Delivery.
 CATALOGUE FREE.

CULLMAN WHEEL CO.
 526 Larrabee St., CHICAGO.

RADIATORS

Hoods, Mud Guards, Tanks
 ALL STYLES, ALL SIZES

Telephone 185 Jersey City Orders filled on short notice for repairs

W. J. KELLS, Jersey City, N. J.

TRANSMISSION GEARS

UPTON MACHINE CO.
 WORKS: BEVERLY, MASS.



Nuttall Cut or Planed Gears
 eliminate noise and require least power

R. D. NUTTALL COMPANY
 Duquesne Way, - Pittsburg, Pa.

Before Ordering your

TUBING

Write us for Samples and Prices
 THE LAMINATED TUBE COMPANY, Columbus, O.

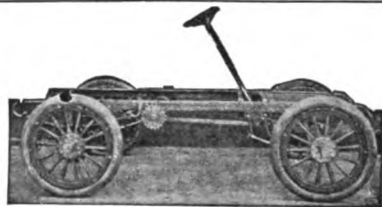

The World's Largest Manufacturers of Automobile Parts and Supplies

RUNNING GEARS, BODIES, ENGINES AND SUNDRIES

Ask for our Catalogue and new prices.

J. H. NEUSTADT CO.
 826-28-30 South 18th Street, St. Louis, Mo.

THE ALLYNE
 BRASS FOUNDRY CO.
 Cleveland, Ohio

ALUMINUM BRASS AND BRONZE CASTINGS

Largest producers of Aluminum Castings in the United States

BALDNER MOTOR VEHICLE CO.
 MANUFACTURERS OF
GASOLINE AUTOMOBILES

TWO CYLINDER } From 10 to 40 H. P.
 THREE " }
 FOUR " }

RUNABOUTS AND TOURING CARS.
 ZENIA, - OHIO.

IRON CASTINGS

For Gas Engines. Cylinders a Specialty, made only from CUSTOMERS' PATTERNS.

HOPSON & CHAPIN MFG CO., New London, St.

TRANSMISSION GEARS

Sliding Gears and Connecting Clutches

COLCORD UPTON

Office: 144 West 39th St., - New York City



New Construction Patent Pending

The Whitney Mfg. Co.
 Hartford, Conn.

THE NEW "WHITNEY" COTTER DETACHABLE ROLLER CHAIN WILL SURPRISE YOU. "Whitney" Cotter Detachable Links can be distinguished from all others by location of Pins and shape of Rivets.



THE WHITLOCK COOLER

has been TESTED and ADOPTED by the LEADING AMERICAN MANUFACTURERS of TOURING CARS. It is the STANDARD

THE WHITLOCK COIL PIPE CO., Hartford, Conn.

Patented in England, France and Belgium. Patents pending in United States. GET OUR NEW CATALOGUE.

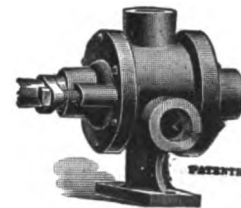

IMPROVE YOUR CIRCULATION BY USING A
Lobe Rotary Pump
 The most efficient for circulating water or oil on all Gasoline Motors. This pump is patented. Beware of infringement. **LOBE PUMP AND MACHINERY CO.**
 230-44 Terrace, Buffalo, N. Y.

AUTOMOBILE RUNNING GEARS

WE BUILD ALL STYLES AND BODIES



Bevel Gear or Chain Drive, Hoods, Steering Devices, Wheels, Bearings, etc.

H. F. BORBEIN & CO.
 2108 N. 9th St., St. Louis, Mo.

INTREPIO MOTOR

Gasoline Single Cylinder

NO VIBRATION

From any source, torque reaction or reciprocating parts.

ROTARY MOTOR VEHICLE CO.

45 Columbus Ave., Boston, Mass.

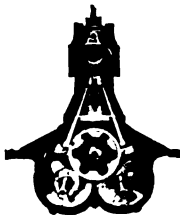

UP-TO-DATE ENGINES

Equal to the very latest French productions
Water Cooled 2-4-6-8 Cylinders
Air Cooled 1-2-4 Cylinders
TREBERT GAS ENGINE CO.
160 Main St., Rochester, N.Y.
BRANDENBURG BROS. & ALLIGER
Selling Agents, 136 Lake St. N. Y., 85 Lake St., Chicago

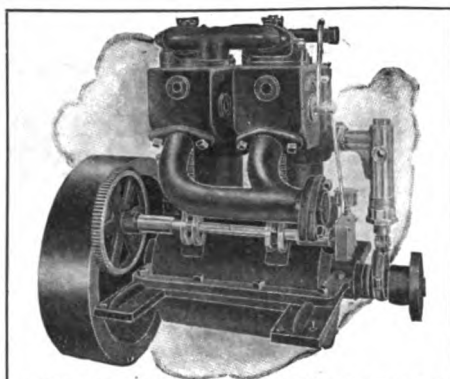

AUTOMOBILE and MARINE MOTORS

Simple, compact and powerful. Best material, perfect workmanship. Send for prices.

ALEXANDER & CROUCH, 69 W. Monroe St., Chicago, Ill.



GASOLINE MOTOR

CYLINDERS,
4 by 4, 5 by 5, and 6 by 6 inches
Rough or Machined
LOWELL MODEL CO.
Drawer 1213
LOWELL, MASS.

WHEN WRITING TO ADVERTISERS PLEASE MENTION THE AUTOMOBILE.



THE RUTENBER MOTOR

THE RUTENBER MOTOR

More Power, Less Parts
and No Vibration
Superbly Built, and of
the Best Material
THE
Western Motor Co.
Logansport, Ind.

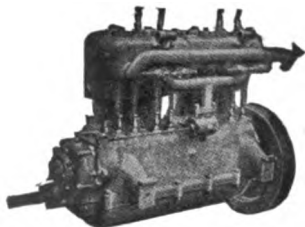

ASTER MOTORS IN U.S.

We have taken the exclusive agency for the Aster Motors made by the celebrated French firm L'Aster. We will keep in stock all sizes from 2 1/4 h.p. to 60 h.p.

See Our Exhibit at the St. Louis Exposition

Send for Circulars

A. J. MYERS, - - 307 WEST 44th STREET, - - NEW YORK

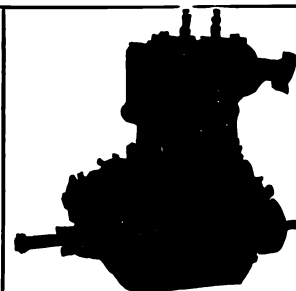

A SUBSCRIPTION FOR THE AUTOMOBILE WILL COST YOU BUT \$2.00 PER YEAR, ABOUT 4 CENTS A COPY, PUBLISHED WEEKLY



Motors for Autos and Boats

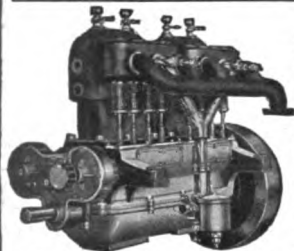

Our "Continental" Motors, 2 cylinder, 12 HP., (weight, 207 lbs.) and 4 cylinder, 24 HP., (wt., 340 lbs.) are of latest foreign design, and at one-half their price. Cylinders cast in pairs with water jacket; interchangeable mechanically operated valves; aluminum crank case; all refinements.

Our "Continental" Carburetor is Perfection
CATALOG EXPLAINS ALL. WRITE US

Auto Car Equipment Co., 160 Bunker St. Chicago, Ill.

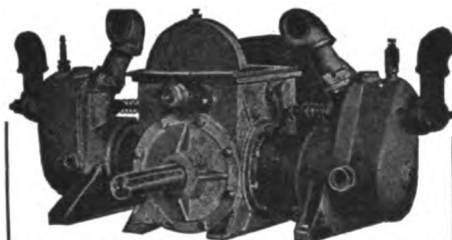

MOTORS—10 horsepower opposed.
TRANSMISSIONS—Planetary and Sliding; 2 or 3 speeds.
CARBURETERS—Float-Feed.
WHEEL STEERING DEVICES.
SIDE LEVER CONTROLS.

We are prepared to contract with manufacturers for specified deliveries and give prompt service.
CHAS. KAESTNER MFG. CO., - South Bend, Ind.

"Quick Action" Igniting Dynamos Excel All Others!



The only generator that cannot lose its magnetism for either make and break, or jump spark work. Also spark coils.

Send for Catalogue.

The Miller-Knoblock Electric Mfg. Co.
South Bend, Ind.

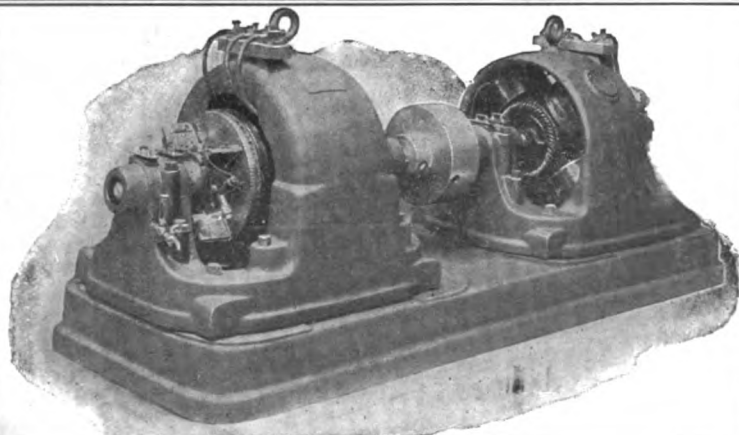

Battery Charging Sets

For Charging either ALTERNATING or DIRECT Current to suitable Battery Current.

—ALSO—

SWITCH-BOARDS FOR SAME

With Automatic Controlling Switches by which Equipment will take care of itself while charging

WAGNER ELECTRIC MFG. CO., St. Louis, Mo.

Contracts with Vehicle Manufacturers and Dealers especially solicited.

GORDON-BENNETT-RACER

ENDORSES THE WELL KNOWN

BRUCK SOLIDIFIED OIL

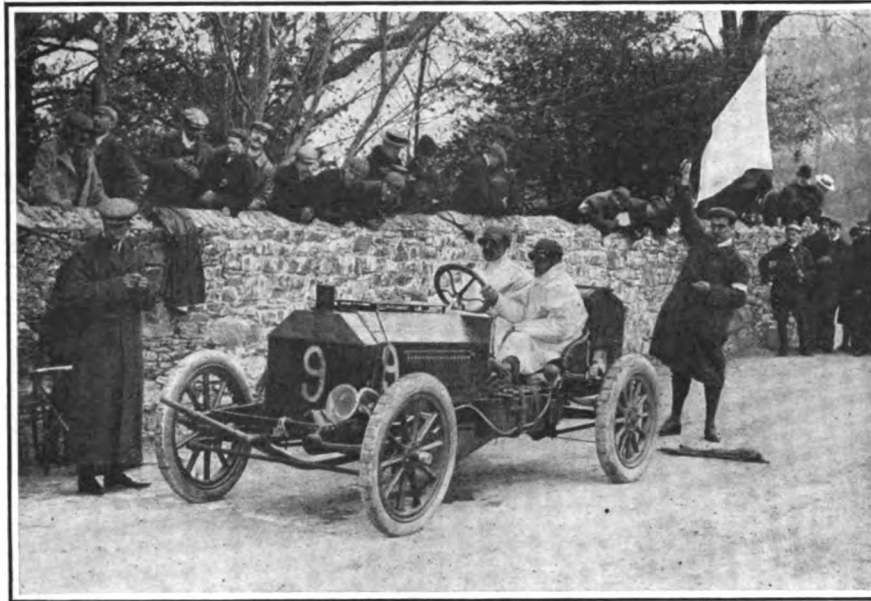

S. F. EDGE IN THE NAPIER GORDON BENNETT RACING CAR



Bruck Solidified Oil Co.
Boston, Mass., U. S. A.

May 25, 1904

Gentlemen:--I have tried your Solidified Oil on the Napier Machines. It has given great satisfaction, and I can cheerfully recommend it to anyone needing a lubricant for autos.

Yours truly (Signed) S. F. EDGE,
Napier Co., London, Eng.

27 Kings Road, Kingsbridge, London, S. W.

Send for Sample Can and be convinced of its superior merits over all other so-called "Motor Car Lubricants." We have experimented with Automobile lubrication for the past three years, and our goods are shipped with our guarantee.

UNAFFECTED BY HEAT, WATER OR COLD

Put up in Cans varying from 1 lb. to 400 lb. packages. Write for prices.

BRUCK SOLIDIFIED OIL CO.

252-254-256 DOVER STREET, BOSTON, MASS.



Hotel from N. W. corner, showing Regent Circle entrance to Auto Garage.

Tourists visiting Boston will find The Beaconsfield easy of access and the hub of all points of interest.

Ideal permanent home, open the year round, offering an enjoyable and healthful alternative to seashore residence. Beautiful parks, tennis courts, etc.

Surrounded on all sides by the famous Massachusetts State roads. Especially attractive for semi-country life. Large modern stable.

THE BEACONSFIELD

BEACON BOULEVARD,
BROOKLINE, BOSTON, MASS.

Largest Summer and Winter Hotel in Boston. Situated on the Beautiful Beacon Boulevard. Ten minutes ride from city by auto, 20 minutes by electric cars. Automobile garage with capacity of 100 cars. Electric charging plant and repair shop. Full line of supplies.

Among its permanent patrons is Mr. Chas. J. Glidden, the well known Automobilist, now touring the world.

Write for particulars and descriptive booklet to Manager

Magnificent banquet hall with every facility for catering to club diners, etc. Rates reasonable.

THE BEACONSFIELD
BEACON BOULEVARD,
BOSTON, MASS.



Interior view of Auto Garage.



TO KNOW!

WHAT TO DO AND HOW TO DO IT . . .

When your gasoline motor or gas engine gets stubborn, can be quickly learned by owning a copy of the

PRACTICAL GAS ENGINEER

A Book of 150 Pages Neatly Bound in Cloth

By E. W. LONGANECKER, Twelve years' constant experience with Hydro-Carbon Engines

Third Edition Just Out and selling rapidly. First and Second Editions exhausted in thirteen months

How to start, how to operate, and how to care for all classes of explosive motors or engines using gas, gasoline or similar fuels.

A full and exhaustive chapter on electric and other systems of igniting.

Also chapters covering in a thorough manner troubles and remedies encountered in operating engines in motor vehicles, launches, shops, or on the farm.

Every line tells something. Every page full of interest.

Sent postpaid on receipt of price, \$1.

BOOK DEPT., THE AUTOMOBILE,

Flatiron Bldg., Madison Sq., N. Y.

Every Day in the Year

THE

SUNSET LIMITED

OF THE

SOUTHERN PACIFIC

leaves New Orleans en route to CALIFORNIA through LOUISIANA, TEXAS, NEW MEXICO and ARIZONA.

For further information, free illustrated pamphlets, staterooms reserved, address any agent of the Southern Pacific.

NEW YORK: 340 Broadway

NEW YORK: 1 Broadway

BOSTON: 170 Washington Street

L. H. Nutting, General Eastern Passenger Agent, New York City.

E. O. McCormick, P. T. M. San Francisco, Cal.

PHILADELPHIA: 109 S. Third Street

SYRACUSE: 120 S. Franklin Street

BALTIMORE: 109 E. Baltimore Street

T. J. Anderson, G. P. A. Houston, Texas.

WARNING

Gasolene Automobiles

The following Manufacturers and Importers are licensed under the Pioneer Patent Number 549,160, granted to George B. Selden, dated November 5th, 1895, on

In view of their license agreement they and their agents will not sell, keep on hand or in any manner dispose of or deal in directly or indirectly any unlicensed new or second-hand gasolene vehicles, infringing said Selden patent.

Both the basic Selden patent and more than 400 other patents owned by members of this Association will be enforced against infringers. Manufacturers, Importers, Dealers and Agents, also Users of unlicensed machines are liable.



MANUFACTURERS

- | | |
|---------------------------------|----------------------------|
| Electric Vehicle Co. | Pope Motor Car Co. |
| Winton Motor Carriage Co. | Smith & Mabley, Inc. |
| Packard Motor Car Co. | The Commercial Motor Co. |
| Olds Motor Works | Berg Automobile Co. |
| Knox Automobile Co. | Cadillac Automobile Co. |
| The Haynes-Apperson Co. | Northern Manufacturing Co. |
| The Autocar Co. | Pope-Robinson Co. |
| The George N. Pierce Co. | The Kirk Manufacturing Co. |
| Apperson Bros. Automobile Co. | Elmore Manufacturing Co. |
| Locomobile Co. of America | E. R. Thomas Motor Co. |
| The Peerless Motor Car Co. | Buffalo Gasoline Motor Co. |
| Standard Motor Construction Co. | The F. B. Stearns Co. |
| Waltham Manufacturing Co. | Pope Manufacturing Co. |
| J. Stevens Arms & Tool Co. | Sandusky Automobile Co. |
| H. H. Franklin Mfg. Co. | Crest Manufacturing Co. |
| | Studebaker Automobile Co. |

IMPORTERS

- | | |
|-------------------------|---------------------------------|
| Smith & Mabley, Inc. | E. B. Gallaher |
| Central Automobile Co. | Auto Import Co. |
| Alexander Fischer | F. A. LaRoche Co. |
| Hollander & Tangeman | Sidney B. Bowman Automobile Co. |
| Standard Automobile Co. | |

Association of Licensed Automobile Mfrs.
No. 7 East Forty-second Street, New York

WE HAVE THE FOLLOWING NOW ON OUR HANDS, WHICH WE WISH TO DISPOSE OF AT VERY REASONABLE PRICES:



**KEYSTONE
 MOTOR CAR
 COMPANY**

238 North Broad St.
 Philadelphia, Pa.

- One Decauville, 12 x 16 H.P., 1904 model, new, never been used
- One Decauville, 10 x 15 H.P., 1904 model, has been run about 1000 miles, in good condition
- One Stearns Touring Car, 1904 model, new, never been used, with canopy top
- One Stearns Touring Car, 1904 model, run about 800 miles, in good condition
- One Reber Touring Car, 1903 model, in good condition, run about 1200 miles
- Several Orient Buckboards, new, never been used, 1904 models
- Several New Rambler Runabouts, 1904 models, new, never been used
- One Double Cylinder Touring Car, model "K", run about 800 miles, in good condition, 1904 model
- Two Santos Dumonts, four cylinder cars, only run about 50 miles, in first class condition, as good as new
- One 1903 Phelps car, new or almost new, has only been run about 50 miles
- One Phelps Car, 1903 model, in good condition
- One Baker Electric Stanhope, never been used
- One Electric Runabout, seating two extra people on dash board seat and two extra people back, on dos-a-dos seat, has been run about 800 miles and in good condition, but will need new battery and very cheap
- One Northern Runabout, new, never been used
- One Northern Runabout, slightly used, in good condition

We have catalogs of most of the above which we will be glad to send you upon request of any one, or give any information in regard to them. The prices at which they will be sold will be low enough to interest those desiring cars, or dealers who wish to sell them again.

STEARNS CARS
 are things of beauty and joys forever
 ASK FOR CATALOGUE
THE F. B. STEARNS CO.
 Euclid Ave. & N. P. Tracks CLEVELAND, O., U. S. A.

FREDONIA CARS
 —FOR—
DAILY USE
THE FREDONIA MFG. CO.,
 Send for catalogue YOUNGSTOWN, OHIO.

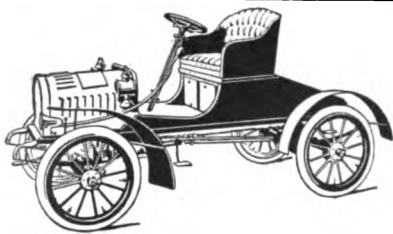

The Sturdy Cameron
 Air Cooled, Shaft Drive, Sliding-Gear Transmission
\$650 **TRIE**
ESTED
RUSTED
 No Competition at the Same Price
UNITED MOTOR CORPORATION - Pawtucket, R. I.

—THE—
GLIDE
GASOLENE CAR

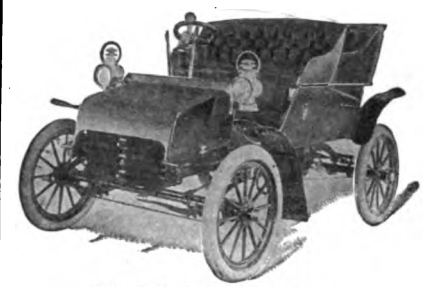

STYLE A, WITH TONNEAU

Runs so smooth and easy we say it glides. The mechanical construction is new and reliable. Third year on the market. Built for service anywhere. Handsome in design and finish. It is a genuine family pleasure car. Some good agencies open on fair proposition. Write to-day for full information.

THE BARTHOLOMEW CO.
 110 BRADLEY AVENUE
 PEORIA, ILL.

The Queen Runabout, \$650
The Queen Touring Car, \$750
 EITHER SINGLE OR DOUBLE CYLINDER
 Manufactured by
THE F. H. BLOMSTROM MOTOR CO.
 River Street and Clark Avenue, DETROIT, MICH.
 Get Dealers' Discounts

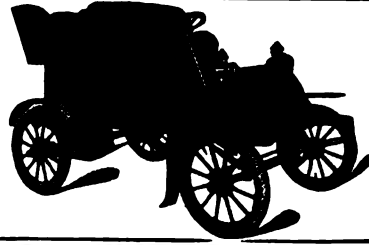

WINTON

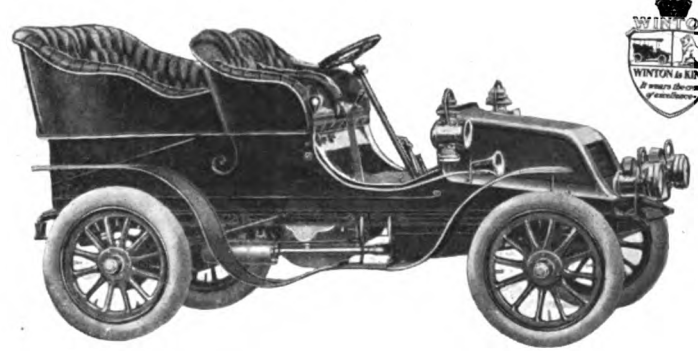

THE WINTON MUST BE GOOD TO DO THE THINGS IT DOES

First across the continent under its own power. First from Mexico to Puget Sound under its own power.

Whether there be roads or not, the WINTON takes you anywhere you want to go. Lastingly reliable under any hardship.

Completely equipped with canopy top, lamps, horn, tools, etc., \$2500; without top, \$2300: f.o.b. Cleveland, Quick delivery.



The Winton Motor Carriage Co.
 MEMBER A. L. A. M.
CLEVELAND, O., U. S. A.

Branch Houses in New York, Boston, Philadelphia, and Chicago. Winton Agencies Everywhere.

THE "ST. LOUIS"
"Rigs that Run"



These vehicles are the most simple and easily controlled machines on the market

Simple Mechanism
Instant Accessibility
High-Grade Materials
Expert Workmanship

These points combined with money, brains and experience produce the acme of perfection, realized only by the operators of the "Rigs that Run."

WRITE FOR CATALOG

St. Louis Motor Carriage Co.
 1211 to 1219 N. Vandeventer Avc.
 ST. LOUIS, MO.

The White Sewing Machine Company at this season find that they are so far behind in orders for the 1904 Incomparable White Steam Touring Car that it is undesirable to do more in the way of advertising than just this card.

Cleveland, Ohio, June 18th, 1904.

—SOLE AGENTS FOR—
MORS, VINOT et DEGUINGAND and NAPIER
 —CARS IN STOCK—

See Our Large Advertisement in Next Issue

CENTRAL AUTOMOBILE COMPANY, LICENSED IMPORTERS, 1684 BROADWAY, NEW YORK

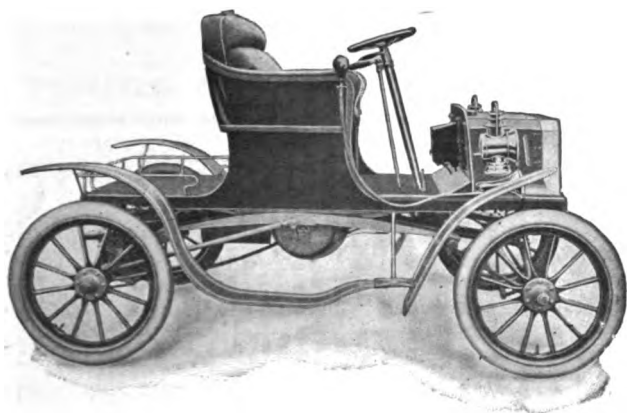

THE BUCKMOBILE
 "For Ease of Riding Without a Peer"

PRICE, \$1,200

Motor, 2-cylinder, vertical, 15 H. P. actual; all mechanically operated valves. Running gear, buckboard construction. Catalog on request.

We are now equipped to make shipment within five days after receipt of order.

BUCKMOBILE CO., UTICA, N. Y., U. S. A.
 New York Agency - 1900 Broadway, cor. 63d St.

Automobile Accidents paid for.

Automobile Liability, Fire Marine Insurance protects you from all liability, and no matter where your machine may be it is protected even from fire originating in the machine itself.

E. G. SAVIDGE, 141 Broadway, NEW YORK.

The Overland
CAR

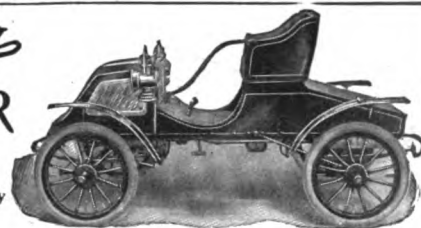

\$600 F. O. B. Factory

Six Horse Power MODEL 15
 Double Cylinder Vertical Motor
 Mounted in Front—Not Under the Seat
 Bevel Gear Drive
 Simple—Noiseless—Efficient

AN OPPORTUNITY FOR LIVE DEALERS ASK FOR BOOKLET 15

—MADE BY—
STANDARD WHEEL COMPANY, 721 Ohio St., Terre Haute, Ind.

The UNION

THE FAMOUS FRICTION DRIVE MACHINE



"In Union there is Strength."

The UNION Tonneau cars have two opposed four-cycle engines with a 5-inch bore and a 4-inch stroke. Artillery wheels. Wheel base 78 inch with standard 56-inch tread. If you want a machine that you can depend on whenever and wherever you want to go, you must get a Friction Drive UNION.

Tonneau, \$900 Runabout, \$825 Send for catalogue.

UNION AUTOMOBILE CO., Union City, Ind.

The Simplest—Most Efficient—Strongest

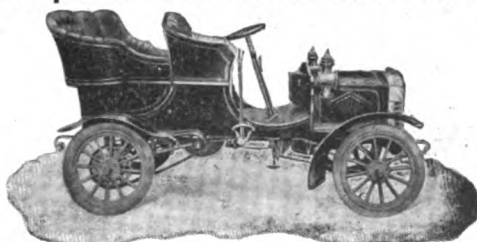

Workmanship and material high grade, with high power, 100 pounds per horsepower. No more transmission gear troubles. No equalizing gears used. No cog gears and no noise. \$5.00 will cover the repairs on our transmission gear for five years.

Manufactured by
THE MARBLE-SWIFT AUTOMOBILE CO., Aldine Square, CHICAGO.

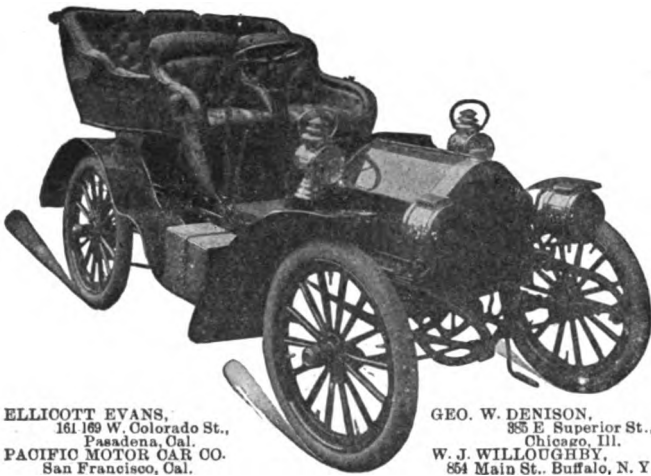

ELLIOTT EVANS,
161 169 W. Colorado St.,
Pasadena, Cal.
PACIFIC MOTOR CAR CO.
San Francisco, Cal.

GEO. W. DENISON,
855 E Superior St.,
Chicago, Ill.
W. J. WILLOUGHBY,
864 Main St., Buffalo, N. Y.

— THE —
JONES-CORBIN CAR

It's Fast and French

JONES-CORBIN AUTOMOBILE CO.

Main Office and Factory:

CHESTNUT and THIRTY-FIRST STREETS

Philadelphia, U. S. A.

H. ALLEN DALLEY, - - New York Agent,

Send for Descriptive Catalog

Show Room, 133-39 W. 38th St.

12 DUANE STREET

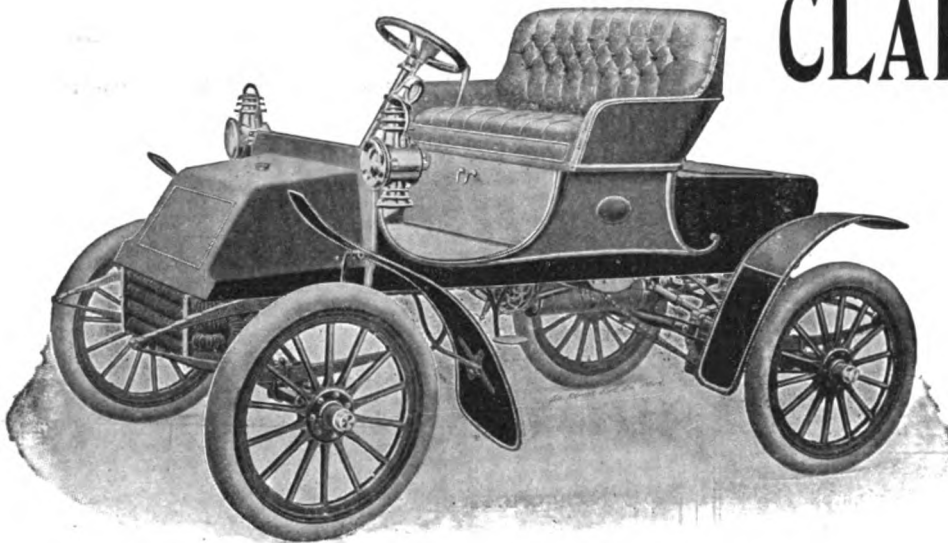

CLARKMOBILES

are being delivered into purchasers' hands NOW and not promises

"THEY GO AND GO RIGHT"

Ready for prompt shipment. 78-inch wheel base, 30-inch, fourteen spoke artillery wheels, 3-inch detachable tires, 7 horse-power motor, widest seat on any Runabout. Luggage space in hood. Finest dark red body and lighter red gear. **Price \$650**

THE CLARKMOBILE CO.

LANSING, MICH.

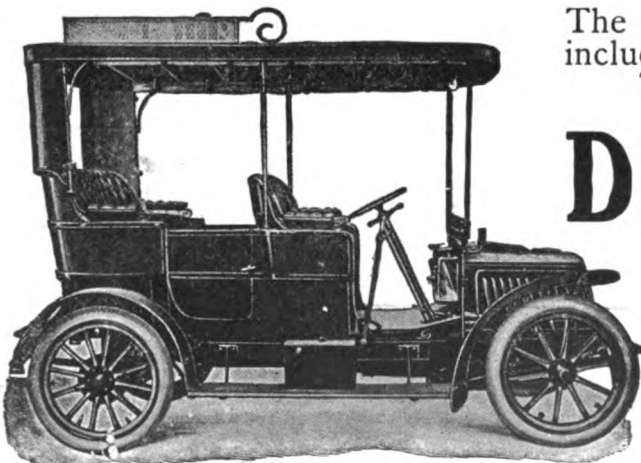

The most beautiful and novel designs in bodies, including both Swinging Front and Side Entrance Tonneaus are this year seen in the

DARRACQ MOTOR CARS

12, 15-20, 24, 30-35, Horse Power.
The Darracq holds more speed records than any other car. . .

F. A. LA ROCHE COMPANY

Sole Agents

Nos. 652-664 Hudson St., and 147 W. 38th St.

NEW YORK

Double Phaeton—1904 Model—4 Cylinders
In 15-20 or 30-35 H. P.—with Cold Pressed
Steel Frame (One Piece)

THE VINGT-ET-UN No. 2

FITTED WITH THE

S. & M. SIMPLEX MOTOR

WINS THE \$2,000 GOLD CUP RACE

The Vingt-et-Un having a S. & M. Simplex Motor (American) beat its rival fitted with an imported motor by 22.34 minutes over a 30-mile course and, notwithstanding a heavy swell, made the remarkable average time of 22.45 miles per hour. The Vingt-et-Un was fitted with the same type motor as the S. & M. Simplex Automobiles, which are built in our factory in New York City.

Smith & Mabley

Incorporated.

511-517 Seventh Avenue, - - NEW YORK.

Members Association Licensed Automobile Manufacturers

Digitized by Google

National Motor Vehicle Co.

BOTH POWERS



Electric

Ample Battery
Large Tires
Efficient Motors
A Complete Line
Western, Exide
or Edison Batteries
Runabouts, Stan-
hopes
Traps, Etc.

Gasoline

Four Cylinders at price of two. Bevel Gear at price of chain. Pressed Steel Frame. Double Steering Connection. Roomy Tonneau.
4 Cylinder, 3 3/4 x 4, \$2000 4 Cylinder, 5 x 6, \$3000

National Motor Vehicle Co.

2100 East Twenty-second Street

Get our Catalogue and Circulars INDIANAPOLIS, IND.

"STEVENS-DURYEA"

GASOLINE AUTOMOBILE

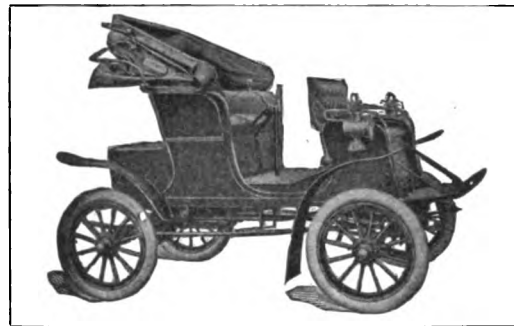

"IT STARTS FROM THE SEAT"

The external appearance of our runabout indicates its Beauty and Grace. The possibilities of the Driving Power are demonstrated by the recent notable performances in Speed and Hill Climbing contests. Seven horsepower motor, two cylinders of opposed type; has three speeds and reverses, all operated by the same lever. Seats two or four passengers. Easily operated by a lady.

Send for Illustrated Catalog and Name of Nearest Agent

J. STEVENS ARMS & TOOL CO.

900 MAIN STREET,

CHICOPEE FALLS, MASS., U. S. A.

Member Association Licensed Automobile Manufacturers.

PROGRESS IN
LOCOMOTION

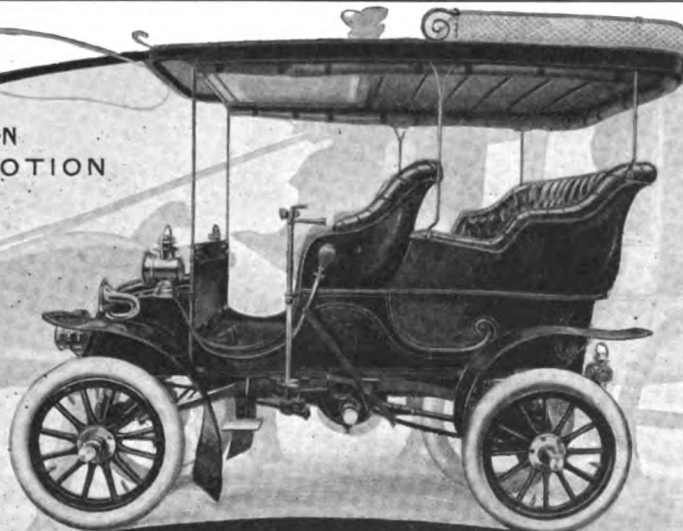

KNOX WATERLESS GASOLINE CARS

ARE THE LAST WORD IN LUXURY

ANYBODY CAN RUN THEM.

KNOX mechanism is immensely practical—not complicated. Designed to serve—not to bother. Steering device is perfect in control—found only on a KNOX. KNOX has the only high power engine **successfully** cooled by air automatically. No water to freeze in winter—no heating of cylinder in summer. If you want a car for the most exhilarating riding, in winter and summer, over all kinds of roads, **select a KNOX and feel satisfied.** Tonneaus; Surreys and Runabouts, 6 styles Passenger, 6 styles Commercial. Catalogue free at agencies or of us.

KNOX AUTOMOBILE CO.,

SELLING AGENCIES IN ALL PRINCIPAL CITIES.

SPRINGFIELD, MASS.

Members Association Licensed Automobile Manufacturers.



The THOMAS

Absolutely without argument conceded by every owner to be the handsomest, strongest, simplest and best Automobile in existence.

See what one pleased owner says:

BEATTIES' MACHINE WORKS.

W. Beattie & Son.

Loopers, Collar and Cuff Turning Machinery.

Cohoes, N. Y., U. S. A., May 6, 1904.

E. R. Thomas Motor Co., Buffalo, N. Y.

Gentlemen:—We have now run the Thomas Car over 1,000 miles without any trouble whatever. We have had no difficulty in climbing all the hills in Cohoes and Albany on the high speed with five people in the car. The car has plenty of power and speed and, taking into consideration the many valuable features which the car alone possesses, we consider it the best car on the market today for the money.

A recent purchaser of a high priced four-cylinder car told me that the Thomas has just as much power and speed as his, and if he had known this before purchasing, he would have certainly bought a Thomas in preference to his. We are well pleased with the car, and so is everyone who has ridden in it. In closing, we wish to congratulate you on the marked success which your three-cylinder cars have attained in such a short space of time.

Yours truly,

W. BEATTIE & SON, per W. Beattie.

The Thomas will please you just as well

E. R. THOMAS MOTOR CO.

1209 NIAGARA STREET, BUFFALO, N. Y.

Members of Association of Licensed Automobile Manufacturers.

The Pierce-Racine.

A RUNABOUT AND LIGHT TOURING CAR

Its motor is the heart and life of an automobile. Without a powerful and reliable motor, the car will prove unsatisfactory and of no service.

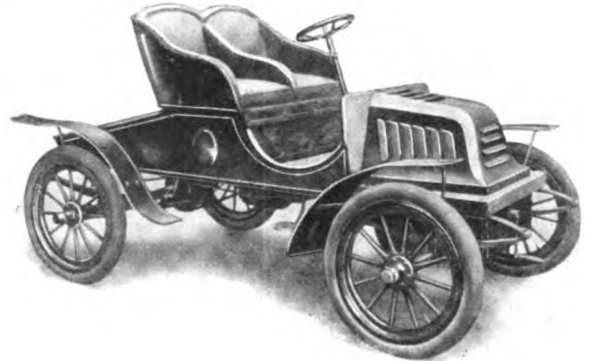

\$750

19 Years Making Gas & Gasoline Engines

Our 800 motors, aggregating 50,000 h.p. doing business all over the world. Send for booklet.

8 h.p.; mechanically operated valves; transmission, 3 speeds forward and reverse; capacity, 180 miles without recharging

PIERCE ENGINE CO.

Box 86

\$850

WITH TONNEAU

Facts are our Endorsements

We manufacture a strictly high grade, up-to-date, reliable car thoroughly covered by our guarantee

RACINE, WIS.

Let us tell more about the Elmore WITH TONNEAU



\$850.00

One difference between the Elmore and other cars is that the Elmore combines the luxuriousness, beauty and comfort of the highest-priced touring car with the price of ordinary runabouts. Another very important difference is in the efficiency of the motor. This is of a special two-cycle type in which all the disadvantages of ordinary two-cycle engines have been eliminated, and our motor has been pronounced by a gas engine expert "the nearest thing to a steam engine in the whole vapor-engine world." We wish you knew more about our motor and would like to put into your hand a little book which puts the whole matter clearly, under the title of "One Long Jump and Two Short Steps." Our catalogue will be mailed free.

THE ELMORE MFG. CO. 1304 AMANDA STREET CLYDE, OHIO.

Members of the Association of Licensed Automobile Manufacturers

The FORD MOTOR CAR



HAS THE CENTER OF THE STAGE

There is no automobile sold at less than \$2,000 which equals the Ford at \$900.

Its smooth, easy running motor with two opposed cylinders gives more power with less vibration than any single cylinder machine.

Buy a car with a Reputation. What's the use of buying an untried experiment?

Thirteen years ago Henry Ford built one of the first successful automobiles in America, so when you buy the Ford you are buying experience combined with guaranteed material and workmanship.

FORD MOTOR CO., Detroit, Mich.

PERHAPS YOU DON'T KNOW

THAT THE CRESTMOBILE
—IS—
THE HIGHEST POWERED
CAR SOLD AT THE PRICE

At the hill-climbing contest in Boston on April 19, 1904, two stock Crestmobiles went up on high gear in the same time made by the largest stock touring cars.

THE CRESTMOBILE
HAS THE POWER



\$800 for Two Persons

\$900 for Four Persons

YOU CAN GET A CREST
WHEN YOU WANT IT

For the Crest Company has made Three
additions this year

CRESTMOBILES CAN BE
DELIVERED PROMPTLY

The Crest factory has ample facilities, and
by enlarging to meet the demand, is enabled
to fill rush orders.

FOR FULL INFORMATION WRITE TO

CREST MFG. CO.
CAMBRIDGE, MASS.

Member Licensed Association

THE VERDICT OF THE USER IS WHAT COUNTS

Herewith a verdict from an owner of a

Locomobile

GASOLENE CAR

New York, May 6th, 1904

THE LOCOMOBILE CO. OF AMERICA,
Broadway and 76th St., New York City.

Gentlemen:—I have run the four-cylinder Locomobile purchased from you last November about five thousand miles.

About four thousand miles of this was through the mountains in California, and in all that distance the engine never stopped of its own accord, and have had no repairs excepting a few spark plugs and punctures.

I do not think any machine could give better satisfaction. Yours truly, D. H. G.

THE LOCOMOBILE CO. OF AMERICA
BRIDGEPORT, CONN.

BRANCHES: NEW YORK, Broadway and 76th St.; PHILADELPHIA, 249 North Broad St.; CHICAGO, 1354 Michigan Ave.; BOSTON, 15 Berkeley St.

Member Association of Licensed Automobile Manufacturers

Columbia

ELECTRIC and GASOLENE
AUTOMOBILES

*Electric
Victoria
\$1600*



Present the most perfect combination of the arts of vehicle and motor building. The body and furnishings of each COLUMBIA, no less than its locomotive parts, reflect the best ideas of the best designers and the highest order of skilled workmanship.

Our artistic catalogue of Columbia High and Medium Powered Gasoline Cars and Electric Pleasure Vehicles will be sent to any address on application; also separate catalogues of our Electric Town Carriages of the coach class, and Electric Commercial Vehicles.

ELECTRIC VEHICLE CO.
HARTFORD, CONN.

NEW YORK
134-138 West 39th St.

CHICAGO
1413 Michigan Ave.

BOSTON
74 Stanhope St.

Member Association of Licensed Automobile Manufacturers

WATERLESS KNOX

COMMERCIAL CARS STAY THE ROUTE!

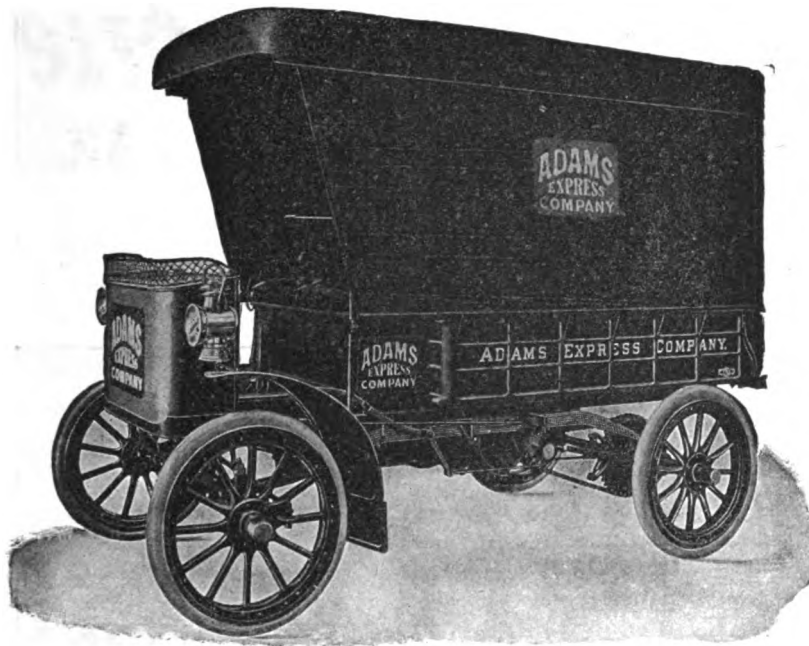

The New York Week's Test Proves It

“**N**OTHING succeeds so well as success.” Nothing proves the worth of a commercial car so well as the success of it in actual road test. Three Knox Cars entered the New York “Commercial Vehicle Test” for the week ending April 9th. They were employed by the American Express Co. and the Westcott Express Co. all over New York City and to Long Island for general deliveries. Each car accomplished about three times as much as each horse drawn vehicle and

Went the Entire Test Week Without a Single Interruption.

THE MORAL IS PLAIN:

If you want the Commercial “Car that obviates the tow” select the KNOX

You see the Knox has the only high power engine successfully and automatically cooled by air. No water to freeze in winter and no overheating in summer. The Knox air cooling system does it. What others *attempt* to do, the Knox *does*.

TONNEAUS, SURREYS AND RUNABOUTS: 6 STYLES PASSENGER, 6 STYLES COMMERCIAL.

Better send for our beautifully illustrated catalogue and learn why.

Members Association of Licensed Automobile Manufacturers SELLING AGENCIES IN ALL PRINCIPAL CITIES.

KNOX AUTOMOBILE CO., SPRINGFIELD, MASS.



IT Rides Like a Pullman

AND FOR

Simplicity, Reliability, Power and Speed

IS

EXCELLED BY NONE.

Single Lever Control, 5 to 50 miles per hour on direct drive, hardened steel on bronze, multiple disc clutches running in oil bath, engine self starting, four cylinder vertical, 30-36 H. P. Interchangeable mechanical valves, jump spark ignition, automatic and hand controlled, throttle foot and hand controlled. Large valves and small cylinder wall surface giving great economy. direct gear used 99 per cent. of the time, leaving transmission idle. Welch true honeycomb radiator and pump, giving both thermal and forced circulation

WELCH MOTOR CAR CO. DETROIT, MICH.

FACTORY: PONTIAC, MICH.

REAR AND SIDE ENTRANCE TONNEAU-LIMOUSINE AND CARRY-ALL BODIES.

ASK FOR CATALOGUE.

IT HAS NO EQUAL

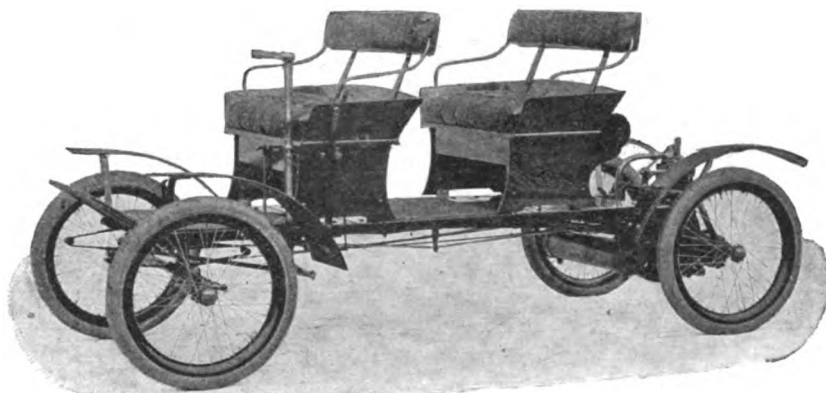

THE ORIENT SURREY

SPEED, 13 to 20 MILES PER HOUR **Price, \$450** **WEIGHT, 550 POUNDS**

It will climb all grades, and carry four people anywhere they wish to go.
Write for catalogue and agents' terms.

WALTHAM MFG. CO.

WALTHAM, MASS.

The "MARION"

**AIR COOLED
LIGHT WEIGHT
POWERFUL
ROOMY TONNEAU**

Side chain drive; 16 horse-power; Weight, with tonneau, 1400 lbs.; Wheel-base, 92 in.; 4-cylinder vertical engine, air-cooled; Bore, $3\frac{1}{2}$ in.; Stroke, 4 in. Aluminum crank-case, enclosing two to one gears.

**Our Engine Marks a
Distinct Advance in the
Art of Air-Cooling.**

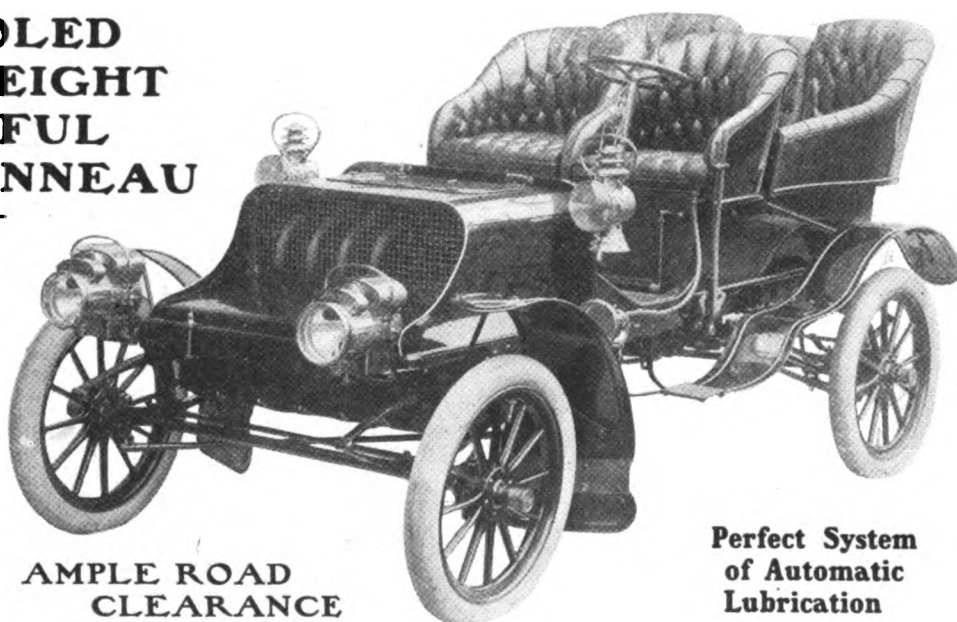

**AMPLE ROAD
CLEARANCE**

**Perfect System
of Automatic
Lubrication**

MARION MOTOR CAR CO.,

INDIANAPOLIS, IND.

YOU DO NOT NEARLY REALIZE

how many points of merit and superiority there are in

ACME TOURING CARS

STUDY
IT
CAREFULLY.

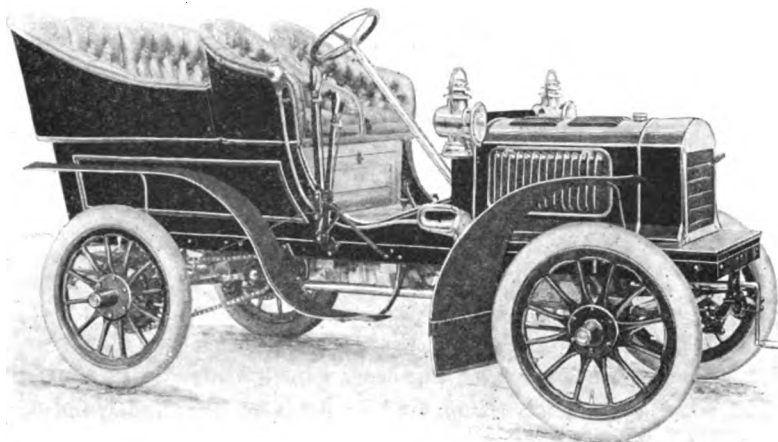

It is much
better than you
thought would
ever be possible.

Type VI, \$1650. With Canopy Top, \$1800.

ACME MOTOR CAR CO., READING, PENNA.

NEW YORK, THE DUBRR-WARD CO., NO. 1787 BROADWAY
BOSTON, HERBERT M. SNOW, NO. 43 COLUMBUS AVENUE
CHICAGO, M. E. COOKE, NO. 394 WABASH AVENUE

PHILADELPHIA, TITLOW & SYKES, 3425 N. BROAD STREET
WASHINGTON, CHAS. E. MILLER & BRO., NO. 1105 14th St. N. W.
BROOKLYN, J. W. MEARS, NO. 754 BEDFORD AVENUE

THE CHEAPEST CAR IN AMERICA

TO RUN AND KEEP RUNNING!

THE ROYAL TOURIST

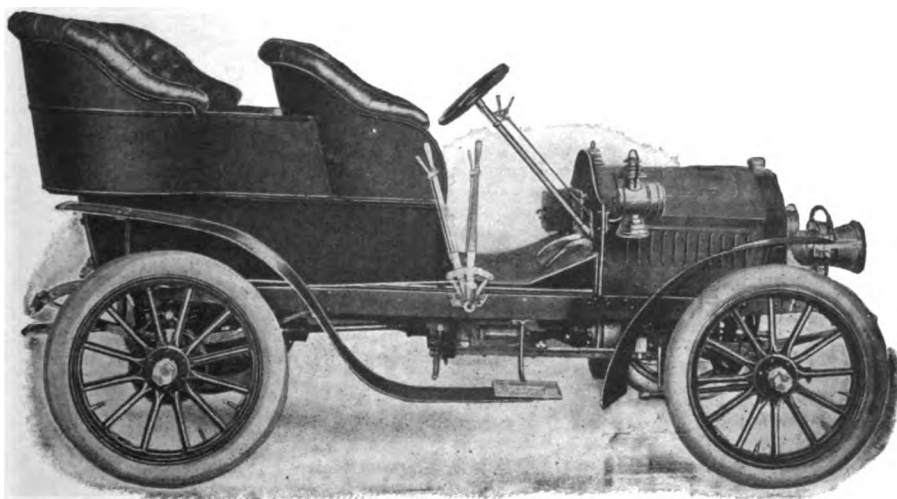

Will you allow us to prove it?

\$2,300 Model "O"

16—18 H.P.

\$3,000 Model "K"

32—35 H.P.

Enameled Aluminium Bodies.

Complete Equipment.

The Royal Motor Car Co., Cleveland, O.

The Duerr-Ward Co. New York Representatives.

THE NAME **BAKER**

Stands for Distinctive Quality
Classification, the Highest Type
of Electric Carriages

SIMPLE,
SILENT,
SAFE,
CLEAN,
SATISFACTORY

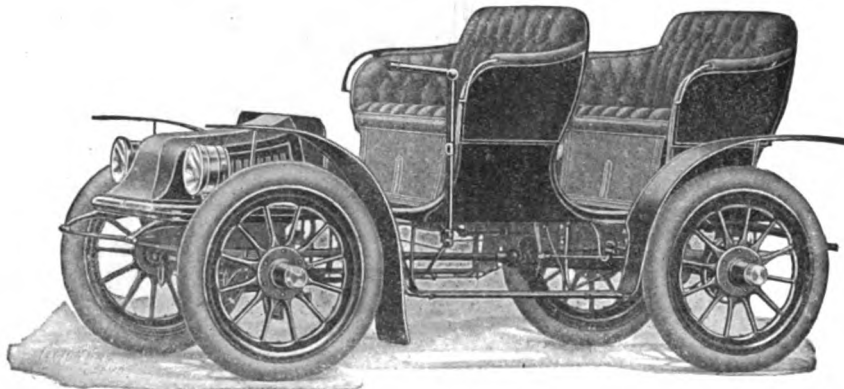

Costs Less
to Maintain
Than Any
Automobile
Made

THE BAKER SURREY

**WEIGHT, WITH PASSENGER LOAD, 2200 POUNDS
MOTOR, 2 1-4 H.P.; BATTERY EQUIPMENT, 24 CELLS**

This motor is the same size and possibly less and the battery is the same weight and size and possibly less than other electric require for two-passenger Stanhope or runabout that speed no faster nor make more miles on a single charge of battery. **NOTE**—This as an illustration of what we mean by superior practical efficiency of Baker construction.

**WE MAKE RUNABOUTS, STANHOPES, DOCTORS' CARRIAGES
BASKET SEAT CANOPY TOP ELECTRIC** *Send for Catalog*

THE BAKER MOTOR VEHICLE COMPANY
CLEVELAND, OHIO

Peerless

PEERLESS MOTOR CAR CO. CLEVELAND, O.

Superiority
again
Demonstrated

Another
point of
interest—
We can make
immediate deliveries.

At Boston May 30 and June 11, A.E. Morrison in a 24 H.P. stock car, won the five-mile touring Car race, defeating easily a large field of Foreign and American machines

THE 10% ANNUAL HILL CLIMB

open to the world, given by the Minneapolis Automobile Club, was held on Kenwood Hill, Saturday, June 11th, and was again won by the

Rambler

The course is 2680 feet long, the grade ten per cent, and the best time for stock machines, 1 minute .07 3-5 seconds, was made, and first prize won for the second time by the

Rambler

beating cars selling at three times its price. It is on the road, not the race track, that power counts and tests become of value. The

Rambler

HAS THAT POWER

Send for our illustrated catalogue "A," which contains the reasons therefor. We also have "A Little History" of another notable performance.

THOS. B. JEFFERY & CO.
KENOSHA, WISCONSIN

BRANCH HOUSES: BOSTON, MASS., 145 COLUMBUS AVENUE; CHICAGO, ILL., 304 WABASH AVENUE

That Decauville Car

Has the best record it is possible for a car to hold

It is good all around---in speed, in strength and in reliability.

The first mile may "demonstrate" but it is the thousandth and first mile that proves Decauville superiority.

The Société Decauville, the builders of That Decauville Car, are renowned among engineers the world over.

STANDARD AUTOMOBILE CO. of New York

SOLE AMERICAN AGENT

136 West 38th Street, NEW YORK

Licensed Importers Under Selden Patent

AGENTS:

Philadelphia: H. S. Lane Motor Car Co.
242 N. Broad Street

Boston: The Lewis & Matthews Co.
66-70 Stanhope Street

New Jersey: Burt & Co.
346 Halsey Street, Newark

Chicago: Edmund F. Dodge
1303 Michigan Avenue



We will appoint desirable agents in unoccupied territory

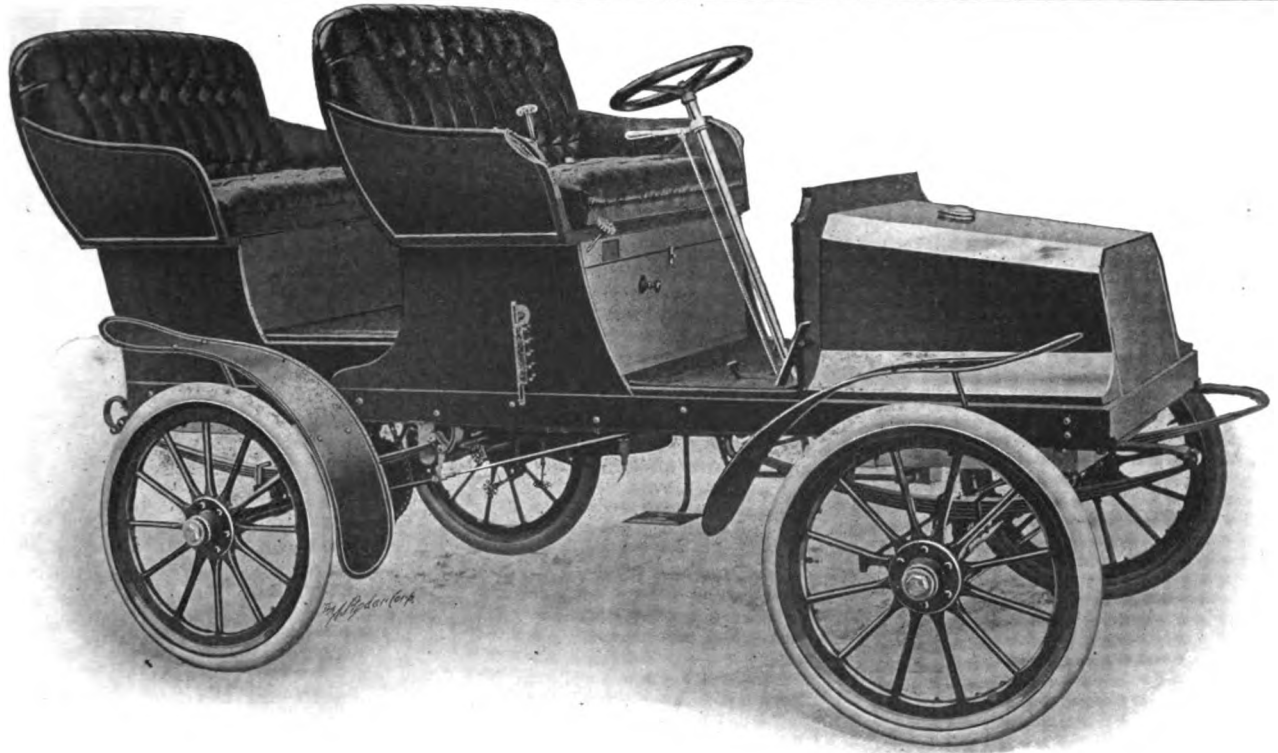

\$650 Model with Detachable Surrey Seat.

THE EXCELLENT
GROUX
STEAM
MOTOR CAR

SEE Our Exhibit at St. Louis Exposition. Demonstrations given on the grounds. New Illustrated Catalog, showing all styles, mailed on request.

GROUX BROS. AUTOMOBILE CO., Orange, Mass., U.S.A.

BOSTON GARAGE and SALESROOM: 151-153 Columbus Ave., Boston, Mass.

STUDEEBAKER



“The Automobile with a Reputation Behind It.”

WITH an eye to long-continued usefulness, the careful purchaser will appreciate the value of Studebaker design, materials and workmanship. Even were other considerations equal, the comfort, elegance and DURABILITY of Studebaker Automobiles guarantee unequalled satisfaction. Our agents will gladly give further particulars, or catalogues will be sent on request.

The Studebaker Electric Car

has been thoroughly tested by actual use, and the fact that we are constantly receiving orders to duplicate shipments proves that it is eminently satisfactory as a convenient, easily-run automobile for local use. Equipped with Edison or Exide batteries and made in a variety of types.

The Studebaker Gasoline Touring Car

is designed for long-distance touring. It is a light, noiseless and powerful car, which incorporates the most modern improvements. Made by a concern whose name is a synonym for reliability, and sold at a price which makes it an unusually profitable purchase.

Studebaker Automobile Co., - - South Bend, Ind.

BRANCH HOUSES.

NEW YORK CITY: Broadway, corner 48th Street.
CHICAGO, ILL.: 378-388 Wabash Avenue.
KANSAS CITY, MO.: 810-814 Walnut Street.

SAN FRANCISCO, CAL.: Corner Market and 10th Streets.

PORTLAND, ORE.: 330-334 East Morrison Street.
DENVER, COL.: Corner 15th and Blake Streets.
SALT LAKE CITY, UTAH: 157-159 State Street.
DALLAS, TEX.: 317-319 Elm Street.

AGENCIES IN OTHER PRINCIPAL CITIES.

AUTOMOBILES

THE AUTOMOBILE

WEEKLY

NEW YORK—SATURDAY, JULY 2, 1904—CHICAGO

10 CENTS

CLUB INFLUENCE IN SOUTHERN CALIFORNIA.

ACCUSTOMED as we are to think of the East as the center of automobiling, some unusual event occurring west of the Sierras every once in a while forces upon attention the fact that the automobile has secured a strong hold on the Pacific slope. Race meets, parades and tours

Southern California. This is to come off in July.

The club spirit of co-operation among automobilists is no more dormant in the land of the setting sun than in the Atlantic Coast States. The Automobile Club of Southern California, which started a year

ago with fifteen members, now has a roster of 112, and has its exclusive quarters in a new building occupied below as a garage. A peculiarity of the organization is that its by-laws exclude from active membership any person directly interested in the manufacturing or selling of automobiles. The club takes the position that, while the value of the active services of members of

the trade in promoting various events is not to be ignored, the entire independence of the organization makes its influence greater for the accomplishment of the objects of organization—improvement of the streets and roads, defeat of unjust and burdensome legislation, propagation of interest in auto-

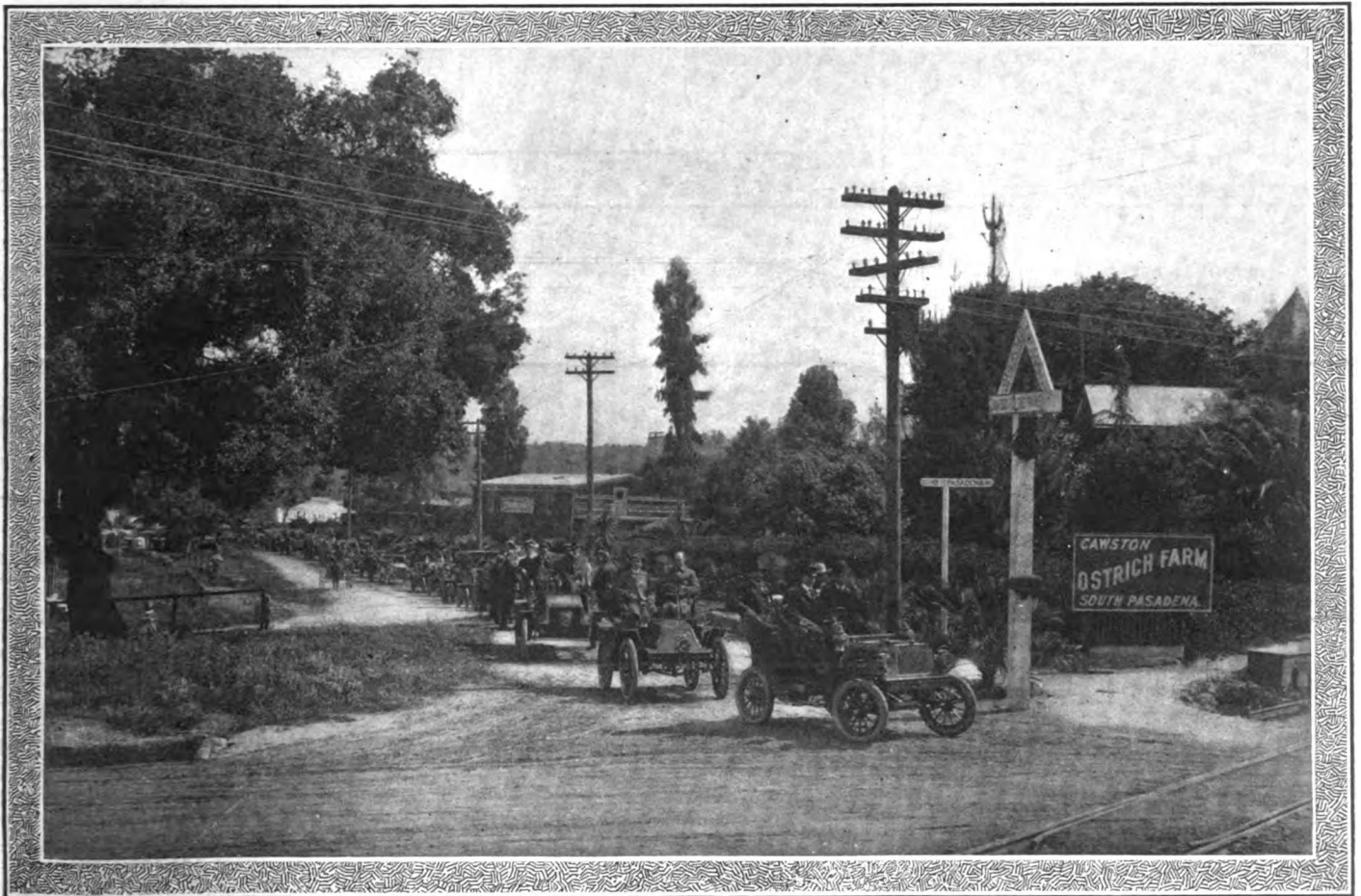

MEMBERS OF THE A. C. OF SOUTHERN CALIFORNIA AND GUESTS VISITING CAWSTON OSTRICH FARM ON THEIR RUN TO POMONA.

are held in San Francisco, Los Angeles and Pasadena and surrounding territory just as they are in New York, Boston, Buffalo, Syracuse, Cleveland and Detroit. The latest event scheduled in California is an endurance run between San Francisco and Los Angeles under the combined auspices and management of the Automobile Club of California and the Automobile Club of

ago with fifteen members, now has a roster of 112, and has its exclusive quarters in a new building occupied below as a garage.

A peculiarity of the organization is that its by-laws exclude from active membership any person directly interested in the manufacturing or selling of automobiles. The club takes the position that, while the value of the active services of members of

biling and the development of the automobile as a pleasure and business vehicle.

To dissipate as early as possible such prejudices as were forming against the automobile, the club seized the opportunity last April, when the associations of supervisors and sheriffs of the State of California assembled in Los Angeles, to extend an invitation to the delegates to be its guests on a

run to Pomona, forty-one miles east of Los Angeles. About 140 persons accepted the invitation, and forty-two vehicles made the trip. A banquet provided by the Board of Supervisors of Los Angeles County was served at Pomona. On the outward trip a stop was made, upon the invitation of Mr. Cawston, one of the enterprising members of the club, at the Cawston Ostrich Farm at South Pasadena, one of the unique points of interest on the Coast. The entire party was royally entertained there by the proprietor. The photograph reproduced on the preceding page was taken while the guests were viewing the farm.

Of the forty-two cars that started on this run, only one failed to complete it—a pleasing contrast with the club run to Redlands about a year before, when nineteen cars started and only six succeeded in making the round trip. The drivers of the cars on the Pomona run were leading citizens of Los Angeles who voluntarily gave their time and money to make the demonstration.

Last month the club held a parade in Los Angeles as a demonstration against a proposed ordinance fixing the speed limit at eight miles an hour throughout the city. Invitations to be guests were sent to the mayor and other officials of Los Angeles and Pasadena, and to members of the local business men's organizations. These responded generously and there were 211 well-filled automobiles in the procession that moved through the leading streets. The demonstration ended with exhibitions of cars moving at various speeds, and the universal opinion was that as a result a more liberal speed ordinance would be passed.

Perhaps the most important work that the club has yet undertaken is that of furthering the grand project of El Camino Real—the Royal Road connecting the twenty-one old Spanish missions of California. This will stretch its meandering length for 550 miles from San Diego on the south to San Francisco and the Solano Mission on the north. Secretary A. P. Fleming, of the Automobile Club of California, was elected president of a State association organized by 100 patriotic Californians at Santa Barbara to undertake the building of this unique highway. The president, assisted by an executive committee and secretary, is now organizing local associations throughout the State to work in conjunction with the State association. When finished this road will be one of the best in the country for automobile touring, owing to its scenic beauties, its delightful winter climate and the historic associations of its ancient missions.

PARISIAN chauffeurs will, it is reported, be compelled in future to pass an examination in the driving of automobiles, knowledge of the various parts of the machines, care and maintenance, repairs, police regulations and signals, and lastly, they will be examined as to their physical soundness and morality.

Hints to Touring Car Purchasers.

Proper Care and Adjustment of a Car Upon Its Delivery from the Builder's Factory, with Explanatory Photographs.

By JOSEPH TRACY.

MANY owners who purchase a car for the first time, or who have graduated from the runabout class to that of the touring car, are at a loss to know just what to do and what not to do when their car first arrives. Those who live in the larger cities, of course, have the advantage of being able to discuss matters of detail with the manufacturer's representatives. There are, however, many purchasers who live at considerable distances from the builder's shops or even of district agencies, and for the benefit of such, chiefly, the suggestions here given are intended. The true automobilist really finds as much pleasure in learning the how and the why of his car and in

for nails which might puncture the tires. If one or more tires are flat when the machine arrives it is advisable to examine the inner tubes. In removing these from the shoes or outer covers use great care in manipulating the tire levers so as to avoid pinching or cutting the tubes—a thing that frequently happens with novices. The tube can now be pumped up to a light pressure and immersed in a tub, or other suitable vessel, of water when leaks, if they exist, will be detected by air bubbles rising from the tube. If the tires are not badly deflated, however, they should be pumped up so that the length of the contact between the tire and floor will be from 2 to 4 inches, according to the wheel diameters, and number of persons to be carried.

The tire manufacturers usually specify the pressure to be used, and it is well to be guided by their instructions. If after being pumped tight the tires gradually lose air—say it takes an hour or more before a tire is flat—the valve is doubtless to blame and should be taken out and examined. If the rubber head on the valve plunger is found to be in bad condition it should be replaced by a new one, and the valve put back and tested for leakage. This is accomplished by turning the wheel until the valve stem is at the top and in a vertical position. If the tire is now inflated, the pump connection removed, and a glass full of water placed under the valve stem (see Fig. 1), and close enough to the wheel rim to allow the end of stem to be immersed in the water, bubbles will rise through the water if the valve is not tight. In putting a tube back which has been in water, see that it is thoroughly dried before it goes into the "shoe."



FIG. 1.—TESTING TIRE VALVE.

keeping it up to the top notch of efficiency as he does in driving it along the roads. And it is without doubt the desire of all to drive well. A little patience added to a lively interest will soon make the owner a skilled automobilist, and though the details may appear multitudinous in print, yet in practice they soon spread themselves into an interesting programme of easily mastered realities.

Upon purchasing a touring car it is well for the owner to procure and carefully study all the literature on the subject issued by the builder. We may assume therefore that the reader has done so, and has received his new car in good condition from the local freight agent.

In taking the car from the crate look out

The wheels should now be examined by jacking up each separately and taking the hub caps off, noting whether each wheel revolves freely and yet does not shake, or is not too loose. Satisfy yourself that the fastenings which hold the wheels on the axles are well secured, as a wheel coming off at any but the slowest speed is sure to cause a bad accident. Don't forget to grease or oil the hubs thoroughly before putting on the caps.

See that the steering gear is free and oiled in its working parts, and that it can be operated easily with one hand when the car is rolled over the floor. It is good practice to cover the various joints in the steering mechanism with leather envelopes, which are filled with grease and held on by straps, and so prevent mud and dust from working between the moving parts.

The water, gasoline and oil tanks may now be filled, and the piping, valves and stopcocks connected with them, especially

the gasoline pipe, carefully examined for leaks. In filling up, it is a good plan to have separate funnels for gasoline, oil and water, and to have all funnels fitted with strainers. Although the filling of a tank is a very easy matter, yet there are more ways of doing it than one—the right and the wrong. When filling the gasoline tank out of one of the regulation gasoline cans do not hold the can with the opening at the lowest point, as shown in Fig. 2. In



FIG. 2.—THE WRONG WAY.

this position the air rushing in to fill the space occupied by the gasoline poured out causes the fluid to come out in a very jerky manner—not only wasteful but unsafe. The

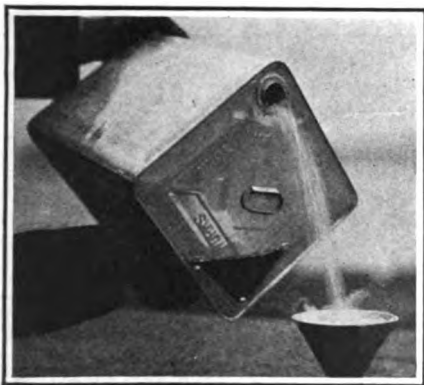

FIG. 3.—THE RIGHT WAY.

correct way is illustrated in Fig. 3. By holding the can with the opening uppermost the air can rush in above the descending stream of gasoline, and with a little practice not a drop need be wasted.

In filling the oil reservoir on the dash many drivers thoughtlessly hold the can over the footboard, as shown in Fig. 4. In this position any oil that happens to drip falls on the rubber mat and in a short time causes soft spots. It is just as easy to hold the body of the can over the bonnet so that any dripping can be easily cleaned off with waste and do no harm. (See Fig. 5).

If the motor jackets, water tank and

pipes have been drained completely, it will usually be found impossible to entirely fill the circulation system, as air may be pocketed in the pipes and jackets. If no vents are provided the motor must be turned smartly by hand or started and run for a few minutes, when the water level will be found to have dropped in the tank. This should now be filled to the top or until the water escapes through the overflow pipe, which shows that the latter is clear.

After turning on the gasoline examine the carbureter to see that the gasoline escapes from the spray nozzle when the float is depressed, the nozzle being exposed for this purpose, also that the small hole which is provided to carry off the overflow from the nozzle is not stopped up. When the motor is not running the gasoline should not overflow at the nozzle. If it does it will probably be found that the float-needle valve is off its seat, or something has caught between it and the seat, or the needle may be bent, or may need grinding in. Again the float may be punctured and full of gasoline, so that it sinks and always holds the needle valve open, or this valve may be set "late" so that it does not entirely cut off the gasoline when the float rises, or it may not rise and fall freely on account of sticking or rubbing against the sides of the float chamber.

The machine may now be oiled, beginning with the crank-case, which should be emptied and washed out with kerosene before fresh oil is introduced. The quantity of oil to be put in the crank case should be that which the manufacturer recommends. It is better, however, to err by using too much rather than too little. In the latter case the cylinders may become badly scored and the efficiency of the motor seriously impaired, while in the former case fouled spark plugs will probably be the extent of the trouble. In every instance sufficient oil should be put in so that the lowest parts of the connecting rods are immersed, about half an inch, when at the bottom of the stroke.

The proper kind of oil to use is a high grade gas engine mineral oil, not too thin, as thin oils usually contain animal or vegetable matter which causes them to smoke a great deal and carbonize at comparatively low temperatures. The oil should not be so heavy that it will not flow through the drips, or that it cannot be pumped.

Oil can be put into the crank case by the hand-pump usually provided, or if there is no pump it may be injected by a "squirt-gun," or oil syringe, through the pipes which carry the oil from the tank to the base. These pipes may be uncoupled at the fitting on the crank case, and the nozzle of the syringe introduced through the opening in the case. The syringe should be a large one, otherwise a good deal of time will be lost in getting the proper quantity into the crank case. If there is an opening provided in the base sufficiently large to admit a small funnel, the oil can be poured

in more easily than it can be "syringed" in.

The gear box may now be partially filled with a light cylinder oil or a mixture of good machine and medium heavy cylinder.

If the car has a bevel drive case, the differential may be half filled, with the same kind of oil as the gear box, or thicker oil, as there is generally more chance for the oil to escape from the differential case than from the gear box. The reason for this is that in a car with bevel gear drive the

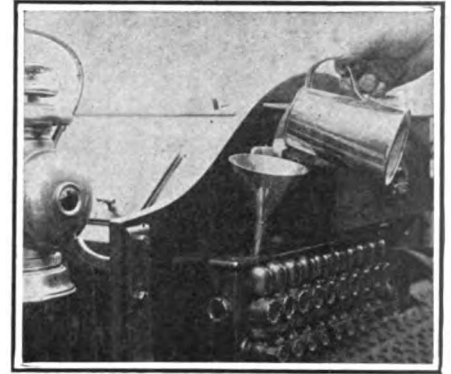

FIG. 4.—THE USUAL METHOD.

back axle is usually fitted with ball bearings, which allow the oil to flow to waste more readily than plain bearings—the latter are commonly used in the gear box.

The joints in the "propeller shaft" should next be washed out by syringing with kerosene and then injecting thin cylinder or good machine oil. These joints should be protected from dust and grit by canvas or leather covers. The foot and hand brake



FIG. 5.—THE CORRECT METHOD.

gear should now be oiled, and then the lever and connections which move the gears.

The "tail" shaft on which the clutch cone runs, the thrust bearings, and clutch actuating mechanism, should all receive their share. Care is necessary in oiling the "tail" shaft, because if too much is injected it will trickle through the bearing, and finally, on account of centrifugal action, lodge on the leather and cause the clutch to slip. For this reason when the tail shaft has been oiled the clutch leather should be well washed with gasoline, using the syringe to inject it.

The governor mechanism, the two to one

gears where they are exposed, the spark, throttle and accelerator connections and the starting crank should also receive a little oil.

TREATMENT OF THE CHAINS.

If the car is chain driven, the chains should be taken off, thoroughly washed in kerosene, dried, and then dipped into melted tallow, mixed with graphite, and allowed to drain before they are replaced. After being treated in this way the chains will probably run from 300 to 500 miles before squeaking or rattling—more if the sprockets are large or the reduction small; less if the sprockets are small or the reduction great. All grease cups on the machine should be filled with thin or soft grease if the weather is cold, or if the cup is at a distance from its bearing, or if the grease pipe is small in diameter. Thick or hard grease should be used if the weather is hot, or the cup close to its bearings. Where the magazine system is fitted, that is where all bearings are fed from a common cup which contains a piston, actuated by a screw, to force the grease through the various pipes, a thinner grease should be used than where separate cups are employed. The reason is this: On account of the large diameter of the magazine piston, the pressure against it is so great that it will be almost impossible to screw it down by hand unless a thin grease, which flows easily, is used.

It is well to examine the couplings and fittings on the oil and grease pipes to see that there is no escape which would rob any bearing of its due and so cause overheating. A leak in a pipe of a magazine grease system is much more serious than a leak in a separate cup system, because it allows the reserve supply of grease to flow out and thus prevents sufficient pressure being applied to force the grease to the other bearings, which suffer in consequence.

BEFORE STARTING THE MOTOR.

After a little kerosene is put into the cylinders, either through the compression taps or, where none are provided, through the spark plug holes, or by means of a special pump which is fitted on some cars, the motor should be started and run for five or ten minutes before the car is moved. This is necessary to ascertain that the motor does not "miss," that the governor acts promptly, that the throttle functions properly, that the motor speed responds to the spark and throttle manual control and also to the accelerator pedal, that the oil feeds or pumps are operating, that the water pump is working and the water circulating in good volume, and that the proper "mixture" is being fed by the carbureter, also that the motor does not "pound" or "knock."

Before cranking the motor see that the ignition is retarded so much that the charge is not fired till the piston has passed the top dead center. This can be ascertained by inserting a wire through the compression tap or plug hole on top of the motor and finding when the piston is exactly on the top cen-

ter—care must be taken that the piston has just completed its compression stroke—this is the second time that the piston is at the top center after the exhaust valve has closed. When in this position the contact piece on the revolving primary "make and break" disk should just touch the brush which is connected with the cylinder under examination.

IGNITION EQUALLY RETARDED.

If the ignition is retarded sufficiently on any one cylinder it will be found to be equally retarded on all the others, unless the brushes are not spaced the same distance from each other, which is very unlikely. A more frequent defect is that one brush is a little longer than the others, thereby causing it to make contact sooner than the others, where the fibre disk turns toward the brush, and later where the disk turns away from the brush.

If not sure about which direction the control handle moves to advance the ignition, it can be found as follows: Turn the motor by hand in the direction which it will run when in operation, and note the way the make and break disk runs. When the brushes are moved in the same direction as the disk turns ignition is retarded, when moved in the opposite direction it is advanced.

(To Be Continued.)

Mail Collection at the Fair.

The 6-horsepower Knox mail car in use at the World's Fair is making a record for itself as compared with horse service. One

automobile and one horse are employed to gather and distribute mail on the Fair Grounds. With the automobile six daily collections are made through the Plateau of States and the part of the grounds called "The Picture," which includes all the exhibit palaces. The mounted horseman collects four times a day through the southern portion of the grounds.

In the morning at 8 o'clock the motor car takes carriers to the several points where they begin distribution. Four men are carried on the first trip and three on the second. This consumes about half an hour. At 8:30 the car, returning from its second trip, stops for the first collection at the Ininside Inn. The automobile carries 800 letters to this immense inn at each delivery five times a day. The papers carried by the automobile to the Ininside Inn average 1,000 pounds daily. So heavy are the collections which are brought from the hotel that they are unloaded at the postoffice in the Government Building before the car makes any other collections. Each motor car collection through the grounds requires from fifty minutes to one hour. There are fifty boxes on this route. The mounted horse collection requires two hours for thirty boxes.

A \$7,000 private automobile house that is being constructed in Columbus, O., for J. W. Kaufman, is nearing completion. It stands in the rear of his residence on Bryden road at the corner of Champion avenue. Mr. Kaufman owns a Pope-Toledo four-cylinder touring car, a Franklin air-cooled machine, and a Baker electric stan-

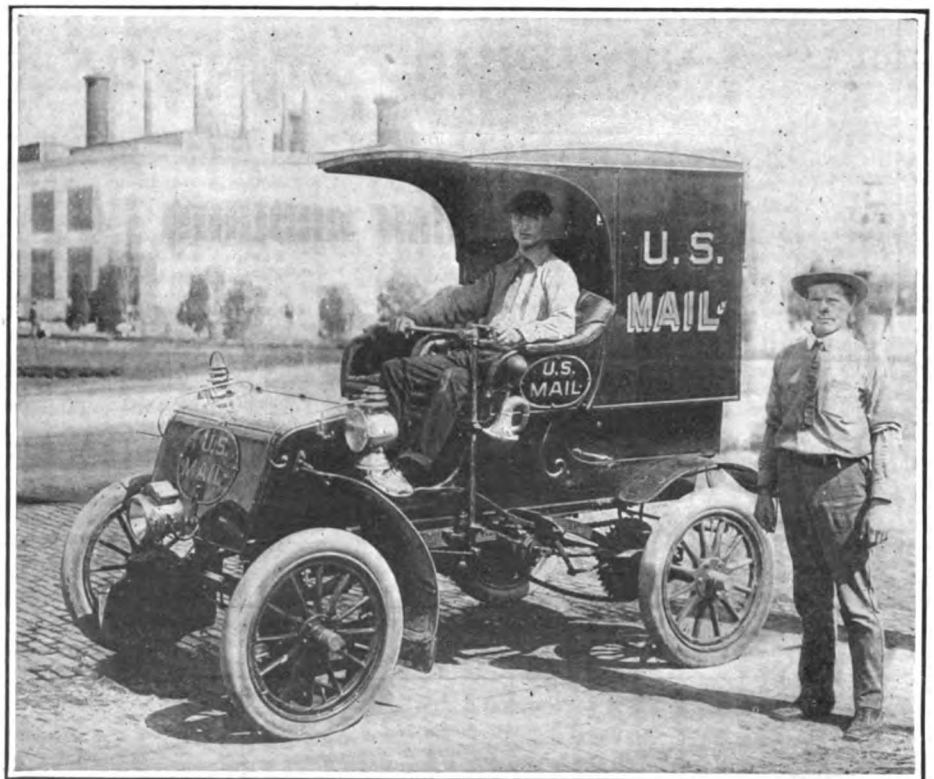

KNOX UNITED STATES MAIL DELIVERY WAGON AT THE SAINT LOUIS EXPOSITION.

American Harmsworth Cup Challenger.

Details of Construction of Auto Boat Challenger Built by Smith & Mabley for International Power Boat Race.

THE auto boat *Challenger* was completed in the shops of Smith & Mabley on the East River in New York, Saturday last, and was subsequently turned up so as to be in racing condition in time for shipment to take part in the Harmsworth cup race. The *Challenger* was designed by Naval Architect C. H. Crane, of New York, and was built in the new Smith & Mabley automobile factory, the main floor of which is at present being used as a boat shop. The smaller auto boat *Vingt-et-Un II* was previously launched from the same place, and there is also a third boat nearly completed, a speed boat of 38 feet over all with a 75-horsepower motor, for M. C. Hermann.

Nearly all American auto boats designed with a view to speed are of one of two types, with a sharp V-section to the entire length of the run, as followed by the Herreshoffs in many torpedo boats and the well-known speed launches *Vamoose*, *Javelin*, *Mirage* and *Scout*, the after end of the load water line running to a point; or the so-called "torpedo stern" type used in the Mosher boats *Ellide* and *Arrow*, the Leighton and many other fast boats. Mr. Crane's studies have led him to follow a modified type, that developed by the noted French naval architect, J. A. Normand, one of the recognized authorities on torpedo boats and whose ideas of construction have been embodied in some of the torpedo boats of the U. S. navy.

The new Harmsworth cup challenger is of the same general type as the *Standard* and the French boat *Lutece*, designed by

Tellier. As the limit is 40 feet over-all length, the new boat has a plumb stem, a hackmatack knee faced with sheet brass and brought to a fine edge, the depth from bottom of keel to deck being apparently about 3 feet 6 inches. There is a deep square forefoot, the keel running along straight to the midship section and then rising gradually until it meets the sharp angle of the transom at a depth of several inches below the water. There is apparently a good amount of freeboard, the sides flaring out at the bow and to a point abaft the midship section and then tumbling in until the deck ends in a sharp point at the angle of the transom. The load water line seems rather full forward, but the breadth is carried very far aft, making a long but not specially fine entrance, and this breadth is then held almost to the transom. The transom is vertical, but instead of being square like the end of a box it shows two vertical bevelled faces, the horizontal section being a flat V.

The forward sections are round, deep and quite full below water, with an easy flare above to the deck, these growing into a midship section with quite a marked deadrise, the bottom slightly rounded and merging into an easy bilge and flaring topside. All the after sections are of flat V form out to the transom, the round just below the waterline and again in the topsides making them approximately of elliptical form toward the extreme after end. The whole form of the boat is fair, with no lumps and hollows, such as are apparent in most "whittled" models, and the lines are round and full rather than excessively fine. As



SMITH & MABLEY AUTO BOAT "CHALLENGER."

befits the large and powerful motor which she carries, the boat is able and powerful in model, with a moderate amount of wetted surface for her displacement.

The forward deck shows a well-crowned turtleback, then there is a single long cockpit with a flat after deck. The motor, of 150-horsepower, already described in THE AUTOMOBILE of June 11, is about 8 feet long over all, the after end being a little abaft the center of the hull. Here there is a bulkhead of 1-8-inch bronze, lightened by various circular holes from four to six inches in diameter where strength is not specially required.

This bulkhead is stiffened by several small steel angle bars. Just ahead of the flywheel, on the forward end of the motor, is a similar bulkhead so cut away to admit of the removal of the flywheel as to form really two deep web frames, also stiffened by angles. Running fore and aft and raking upward at their fore ends are two built-up channel beams about 6 inches deep, and two feet apart, their after ends secured to the bulkhead and one fore end to each of the web frames. The weight and strain of the motor is carried entirely on these channel beams and from them transferred to the bulkhead and half-bulkhead and thence to the hull proper.

The keel is of oak, rabbeted for the planking, which is of $\frac{3}{8}$ inch mahogany below the waterline and white cedar of the same thickness above. The frames are spaced about 6 inches on centers, every third one being a deep frame, about $1\frac{3}{4}$ by $\frac{1}{2}$ inch, with the two adjoining frames, each about $\frac{1}{2}$ inch square. Inside each seam is laid a fore-and-aft ribband of oak or other hard wood, about 1 inch wide and 3-16 inch thick, thus making a lap of $\frac{1}{2}$ inch on each plank, to which it is well fastened. These ribbands run under the frames, which are jogged to fit over them. There is a light shelf, about 1 by 2 inches, and one bilge stringer of about the same dimensions, on each side. The forward deck is of thin wood covered with painted canvas. The coaming is set in some three or

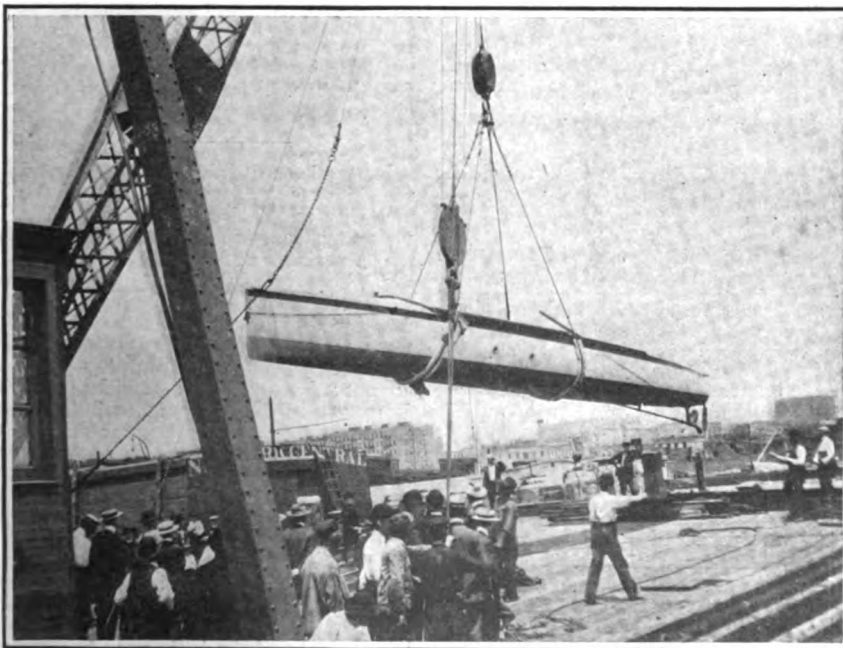

HUGE FLOATING DERRICK LAUNCHING AUTO BOAT "CHALLENGER" IN EAST RIVER.

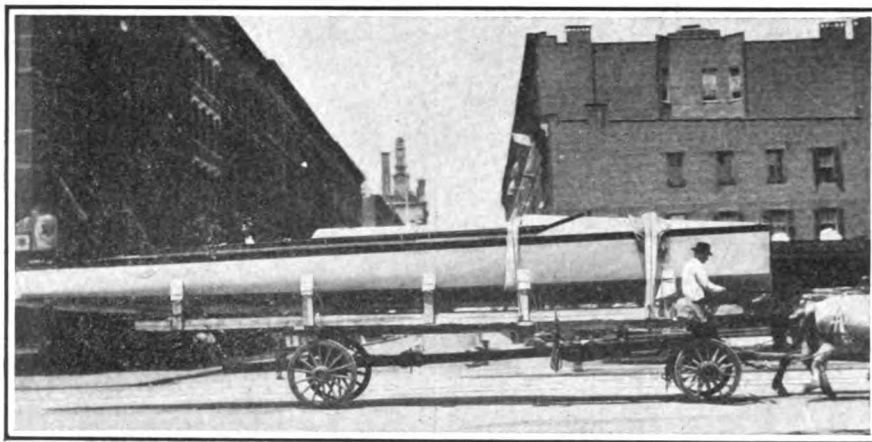

MOVING AUTO BOAT "CHALLENGER" FROM BUILDER'S SHOPS TO LAUNCHING PLACE.

four inches from the gunwale and is of mahogany, about 6 inches high.

The motor occupies the greater part of the forward half of the cockpit, but there is ample space for one man to stand just abaft the fore deck. Here, forward of the flywheel, are located the rotary water pump, for circulation and clearing the bilge, the two rotary oil pumps for the crankcase and cylinders, and the air pump, also rotary. About two feet abaft the middle bulkhead is a second bulkhead of mahogany, making a place for the engineer, and abaft this is a cockpit about 4 feet long, for the helmsman. The steering is thus done from a point well aft in the boat, clear of much of the spray and with every chance to hold the boat steady by a long sight over the stem on an open course. The wheel is of the car type on a vertical shaft.

The mechanism for cranking the motor consists of a long shaft on the starboard side of the motor, carried on two brackets from the channel frames, the fore end fitted with a sprocket and chain connection to another sprocket on the main shaft which carries pawls engaging in a ratchet wheel connected with the flywheel. A crank on the after end of the fore-and-aft shaft is operated by the engineer. The reversing gear is large and powerful, with four heavy beveled drums of hide, it is also operated by a crank, shaft and sprocket from the engineer's cockpit.

The motor is placed slightly to starboard of the centerline, the shaft is of steel, about $1\frac{3}{4}$ inches in diameter, supported by a short bracket just outside the hull and a longer one just forward of the wheel. The bearings in both of these brackets are positively lubricated by tubes from inside the hull passing down through the brackets.

The rudder is hung outside the hull at the apex of the V transom, the stock is of forged bronze with a blade formed of two thin sheets of bronze riveted together on the edges—the construction generally followed in racing 20 and 25 footers. The boat builders have turned out a beautiful piece of work, the hull being fair throughout and perfectly smooth; the bottom is finished in copper bronze and the topsides in white enamel.

Though the Smith & Mabley factory at the foot of East Eighty-third street, New York, is built on the river, the conditions are such that the boat could not be launched at that point. A cradle of heavy timbers was built under the craft, and the whole placed on a truck and hauled to a pier at the foot of East Ninety-sixth street. Here a huge marine derrick was in readiness. The boat was placed in a double loop of heavy rope, one bight coming just forward and the other just aft of the motor space, and was hoisted clear of the truck, swung across the deck of the derrick scow and gently dropped into the river on the other side, the whole operation taking but a couple of minutes after the sling had been adjusted. Extreme care was necessary in handling the racer, as the motor weighs 1,800 pounds, while the hull is little, if anything, over 900 pounds.

EARLY TOURISTS REACH THE FAIR.

Special Correspondence.

ST. LOUIS, June 25.—A number of automobile tourists have arrived at the World's Fair. Mr. and Mrs. G. H. Wilson, of New York City, came overland and are now using their Darracq car to and from the Fair and in touring the suburbs of St. Louis. Their trip was made over the route mapped out by the American Automobile Club through Kingston, Binghamton, Buffalo, Cleveland, Chicago and Springfield, Ill. Tools and baggage for the trip were carried in the tonneau. Only one set of tires was used and these are still good for several hundred miles of service. The only bad roads encountered were between Chicago and St. Louis.

Regarding the trip Mr. Wilson said: "We enjoyed it immensely. At the close of each day's run lodging was secured at places recommended by the A. A. A. committee. Our trip covered just sixteen days, and if business did not prevent I should like no better sport than to go home the way we came."

A STATUTE mile is 5,280 feet; a nautical mile is 6,080 feet. A knot is a measure of speed, not of distance, and is equal to one nautical mile per hour. To reduce knots to miles per hour, multiply by 1.1515.

MAGISTRATE'S DECISION REVERSED.

A decision handed down Wednesday by Judge Newburger in Part I., General Sessions Court, New York, is of importance, for it strikes a blow at the practice of fining automobilists for speeding, upon the unsupported testimony of a policeman. Dr. J. Ralph Jacoby, of New York, was recently fined \$25 by Magistrate Crane for alleged speeding of his automobile in Central Park. The officer making the charge declared, as usual, that the machine was running 18 miles an hour, Dr. Jacoby denied the charge, stating that as he was following a horse-drawn vehicle and several other vehicles had overtaken him, such speed was impossible. Magistrate Crane ignored the denial, however, and, saying that he believed the officer, imposed the fine. Dr. Jacoby paid the fine under protest and appealed, claiming that he had not been proved guilty and that in other respects the proceedings had been irregular and illegal. His contention was upheld by Judge Newburger, who ordered the fine returned.

CHAUTAUQUA COUNTY PARADE.

DUNKIRK, N. Y., June 23.—Fifteen cars were in line in the automobile parade held jointly by Fredonia and Dunkirk automobilists. The caravan was composed chiefly of runabouts, though one large French touring car took part. The line of march led through Dunkirk, along the shore of Lake Erie and then to Fredonia. A decided novelty in automobile parading was the finale, which consisted in the christening of a baby at the Dotterwich mansion. The parade was the first of its kind held in Chautauqua County, and was a great success. After it was over a canvass was made and it was found there were twenty-four automobiles owned in the two neighboring towns. It was at once determined that a club should be formed, and a committee was appointed to arrange details of organization.

COMMERCIAL VEHICLES IN BUFFALO.

BUFFALO, June 27.—Automobile trucking will be entered into in this city by a company being organized by F. R. Corbett, 66 York street. George Miner is also interested in the enterprise. Large trucks will be put in service for heavy freighting and smaller vehicles for light parcel and package work, while two heavy trucks will be available for public hire. The motive power for these vehicles has not yet been decided upon.

It HAS been definitely decided that an automobile race meet will be held at the Empire City track, Yonkers, on Saturday, July 16, and a sanction has been secured from the American Automobile Association, under whose rules the meeting will be held. The program of events includes a 15 mile free-for-all, for machines weighing from 1,432 to 2,204 pounds; ten mile race, for machines weighing from 881 to 1,432 pounds; five miles, for machines weighing from 551 to 881 pounds; and the Empire City Handicap, five miles, for machines of any class, weight or motive power. Match races and record trials will also be run, and some good sport is anticipated. It was rumored that the Buffum 8-cylinder racer, styled the *Central Greyhound*, would be entered in some of the events, but inquiries at the Central garage elicit the information that there is no intention, at present at least, of disturbing the repose of this untried giant. Alfred Reeves, Secretary of the Empire City Track Association, will receive entries up to Monday, July 11.

Vingt-et-Un II Defeats Fiat III.

Match Races are Held From Larchmont Yacht Club in Long Island Sound—Winner Attains Speed of 19.46 Knots.

A NOT very satisfactory ending came of the long talked of auto boat match between the New York firms of Smith & Mabley and Hollander & Tangeman during the week. However, it demonstrated that even a modern auto boat cannot run on air alone, but requires for the operation of its motor some inflammable vapor.

The match was to be the best two out of three and on the showing made the decision was given *Vingt-et-Un II*. After months of preparation and the expenditure of much time and money in the production of two extreme racing machines, the first race proved a failure, the *Fiat III* stopping within seven or eight miles of the start and the *Vingt-et-Un II* barely drifting over the finish line under her own momentum before she too was dead. The trouble in each case was due to the lack of gasoline, a matter of sheer carelessness.

The two launches were at Larchmont, on Long Island Sound, over Sunday, and on Monday morning they were measured and examined by the technical committee specially appointed to manage the match. Both are new and untried, built especially for this contest, the *Vingt-et-Un II* having been launched on June 18 and the *Fiat III* on June 24.

The former was designed by C. H. Crane and built by Smith & Mabley at their Eighty-third Street shop, in New York, the model being of the Normand type. She is 39 feet 11 inches over all; 39 feet 9 inches on the water line, and 4 feet 9 inches in breadth. The hull is of ribband-carvel construction, finished in white above the water and bronze below, with mahogany deck. There is a single long cockpit, with turtleback forward and movable hatches over the motor. The helmsman stands abaft the middle of the boat. The motor is the new Smith & Mabley 75-horsepower already described

in THE AUTOMOBILE; its official rating at 800 revolutions is 59.7-horsepower; the rating of the boat being 84. C. M. Hamilton was at the wheel.

DETAILS OF FIAT CONSTRUCTION.

The *Fiat III* was designed and built by the Electric Launch Company, at Bayonne, N. J., and is of double-skin construction, with outer planking of mahogany. She is 39 feet 11 inches over all; 38 feet 4 1-2

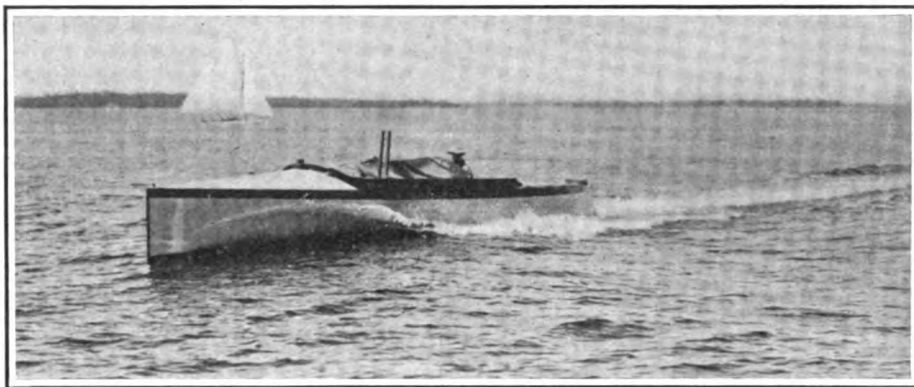

VINGT-ET-UN II REELING OFF MILES IN LONG ISLAND SOUND AT THE RATE OF 19 KNOTS.

inches on the waterline, with stem raking forward and the "torpedo stern" of the first *Fiat* launch. The turtleback extends about to the center of the boat, entirely covering the motor, the engineer occupying a small cockpit just abaft the motor, the deck from here aft having only a moderate crown. The helmsman has a small cockpit forward of the motor, his head just showing above the turtleback. The motor, a four-cylinder, is from a F. I. A. T. car, made in Turin, Italy. It was tested on the blocks to 97-horsepower at 1,800 revolutions, but its rating was taken at 1,250 revolutions, at which speed the horsepower was 66.25, making the rating of the boat

85.6. At this rating she allowed *Vingt-et-Un II* 1 minute 39 seconds in thirty miles.

CHARTERED STEAMER FOR SPECTATORS.

The passenger steamer *William Storie* was chartered by the two firms to follow the racers, the tug *Unique* being chartered for the race committee. The *Storie* left New York early on Monday morning with a party of guests and ran up the East River and over the course of the ill-fated excursion boat *Slocum*, arriving off Larchmont, N. Y., about 11 o'clock. Although this was after the announced hour, there was no sign of the launches as the *Storie* lay outside Larchmont Harbor, the tide being out. After a long delay the Larchmont Yacht

Club launch brought out more guests and in course of time the racing boats ran out, the *Fiat III* first, Mr. Tangeman's yellow head showing through the turtleback as she chased about the Sound at speed.

Even with the boats at hand there was no attempt to start until 2 o'clock, though it was intended to get off two races in the course of the day. The *Fiat III* seemed to be running well, in spite of a bad discharge from her exhaust, which led up into the air over the port gunwale. The *Vingt-et-Un II*, however, was idle at times alongside her tender, the crew evidently busy with her motor.

COURSE WAS A TRIANGLE.

The course was a triangle, the first leg from off Larchmont across to the mouth of Hempstead Bay, 3 nautical miles, the second down the Sound, 6 miles, and the third of equal length to the line, 15 miles in all, to be covered twice. The start was given at 2-35-30, Mr. Tangeman as usual getting away very smartly within 11 seconds of the gun, while the *Vingt-et-Un II* was a little late, there being 23 seconds between the two as they crossed the line.

As they ran across the Sound, the angle of view constantly changing, it was impossible to gauge the difference, but when near the first mark *Vingt-et-Un II* went suddenly to the front, and after they turned she quickly opened out a long lead. She continued to gain as they crossed Hempstead Bay, running smoothly and steadily on, while *Fiat III* stopped. They were lost to sight for a long time, the *Storie* return-

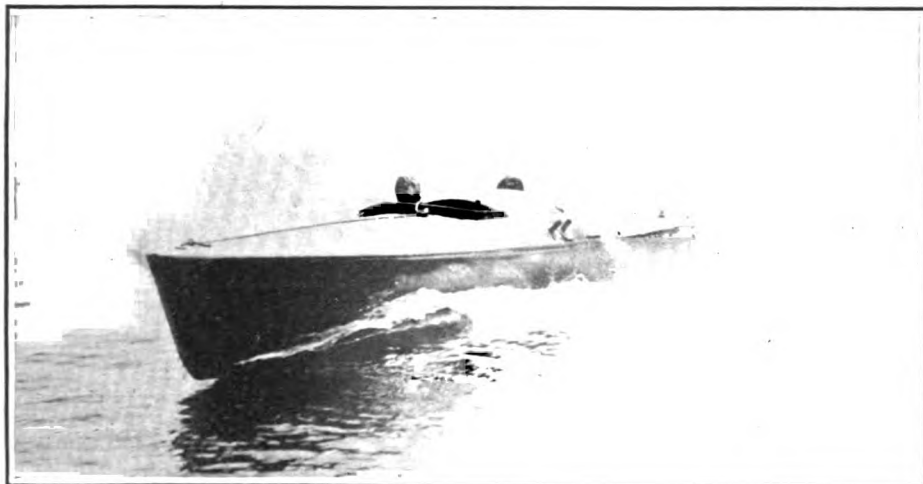

AUTO BOAT FIAT III CROSSING THE LINE IN THE MATCH RACE AT LARCHMONT

ing to the starting line. At last *Vingt-et-Un II* was sighted well down the Sound and heading for the line, where she finished the first round at 3-39-07 o'clock.

FIAT III NOT IN SIGHT.

As nothing was to be seen of *Fiat III* the *Storie* started on a search which ended off Matinnicock Point, where the launch was lying idly on the glassy waters, the sun beating down on her two unhappy passengers. A hail from the steamer brought back the news from Mr. Tangeman that they had run out of gasoline, this being the sole cause of the trouble.

At this the weary and disappointed spectators of an up-to-date "auto-boat" race revived, and a fire of heated comments was wafted over the Sound, Mr. Tangeman being advised to "Go git a hoss" and to perform other impossible feats. A line was passed to the launch and she was made fast astern of the *Storie*, then refreshments were passed to her hungry crew; they were pelted with biscuits and oranges and by means of a life line a couple of bottles of beer were wafted across the intervening waters. As the *Storie* neared the finish *Vingt-et-Un II* was made fast to one of the markboats, having finished at 4-33-40 o'clock, or at a rate of speed of nearly 15 knots for the course. It further transpired that she too had run out of gasoline within a short distance of the line and only by good luck had held sufficient way to carry her over against the tide.

The *Fiat III* had taken on no gasoline during the day, though Mr. Tangeman was instructed by the committee to so do, just before the start. With the knowledge that her tank, of 30 gallon capacity, was only partly full in the morning, she had run at a high speed for miles before the race was started and yet had neglected the ordinary precaution of filling her tank at the last moment.

MISTAKE IN MARKING COURSE.

Through a mistake on the part of the boatman charged with laying the marks, the second mark of the triangle was a dory with a small flag, not easily seen. Clare Hamilton, who steered *Vingt-et-Un II* failed to find the mark on the first round and ran some distance beyond it before discovering his mistake and returning.

COURSE FOR SECOND RACE.

The course for the second race was 15 miles, to the buoy off Eaton's Neck and return, the tug *Unique* being sent away early Tuesday morning.

There was a moderate N. E. breeze and quite a sea out in the Sound, the sky being cloudy with a promise of rain. The crews of both launches were busy with the motors until after 12 o'clock, when *Vingt-et-Un II* ran out to the line where the *William Storie* with a very small party on board was awaiting the start. Meanwhile *Fiat III* lay at the float of the Larchmont Yacht

Club, her crew busy with the electrical equipment, as the motor would not work properly.

Some time after 1 o'clock the word came out that the race was off for the day, and *Vingt-et-Un II*, which had been running at speed through the seas, went into the harbor. A few minutes later there was a roar and a rush of waters and the *Fiat III* came flying out, leaping half out of water as she breasted the seas. It seems that after spending the whole morning in a search for electrical troubles the happy inspiration came to look at the carbureter; this was found to be badly clogged with dirt. As soon as it was cleaned and replaced, the motor was started and ran properly.

COMMITTEE NOW CAME OUT.

The committee now came out and in passing notified those on the *Storie* that it was ready to start the boats if they wanted to race. By this time a little rain had fallen, the wind was lighter and the sea had gone

Vingt-et-Un II fourteen seconds later. The latter boat took the lead almost immediately and as events proved continued to gain for the whole distance. By this time the tug *Unique* had left the turning buoy, so no times were taken; after a wait of an hour and a half *Vingt-et-Un II* was visible from the starting line and she finished at 6-32-50 o'clock, *Fiat III* following at 6-53-44 p. m.

The official times were: Start: 5-00-00.

Finish Elapsed Correct.

<i>Vingt-et-Un II</i>	6-32-50	1-32-50	1-31-10
<i>Fiat III</i>	6-53-44	1-53-44	1-53-44

Vingt-et-Un II wins by 22 minutes 34 seconds corrected time. Her average speed for the 30 nautical miles was 19.46 knots, or 22.45 statute miles per hour.

A. D. Proctor Smith sailed on the liner *Oceanic* for Liverpool on Wednesday and the two launches, the *Challenger* and *Vingt-et-Un II* will be shipped by the *Minnetonka* to London on Saturday. C. M. Hamilton will handle *Vingt-et-Un II* in England, and



PANHARD BOAT "LA MANOLA" WITH PARTY OF ONLOOKERS AT THE MATCH RACES.

down. There was a rushing about of launches in and out between the starting line where *Fiat III* was lying after some runs back and forth outside, and the club float where *Vingt-et-Un II* was tied up. At 3 o'clock a launch came out and notified the *Storie* that the race was indefinitely postponed, owing to the heavy sea.

The *Storie*, with a few guests and several newspaper men on board, started back for the city, leaving both launches safely tied up to the Larchmont floats.

An hour later it was decided to start the race, as the sea was much smoother and there was no rain. After the experience of the first day both boats had been fitted with wind shields for the helmsmen. On *Vingt-et-Un II* a couple of pieces of thin pine were fitted in the forward corner of the helmsman's cockpit, on the port side, each projecting a foot above the deck, to give some shelter from the spray. On *Fiat III* a piece of pine was fitted fore and aft in the center of the deck, the helmsman's head finding a partial lee on one side or the other.

The start was given at 5-00-00 p. m., *Fiat III* crossing within five seconds and

Mr. Smith will probably pilot the larger boat.

PHILADELPHIA CLUB RUN AWARD.

Special Correspondence.

PHILADELPHIA, June 27.—The special committee in charge of the recent Camden-Atlantic City run of the Automobile Club of Philadelphia has finally awarded the Lippincott Cup to Horace A. Beale, Jr., whose Locomobile was the first to report at the finish. Rumors that he had been stopped en route for too fast traveling caused the committee to withhold the cup until an investigation had been made, one of the rules of the contest providing for the disqualification of any entrant who so offended. The investigation failed to develop any such transgression on Mr. Beale's part, and he was finally awarded the prize.

THE number of accidents reported during the last few weeks caused by derangement of steering gears is a sharp warning to automobilists to watch this vital part of the machine and keep all its components in perfect condition.

Isle of Palms Beach as Speedway.

ATTENTION of the Automobile Club of America has been called to the suitability of the beach on the Isle of Palms for automobile straightaway speed trials and races. The Isle of Palms, formerly known as Long Island, is situated immediately on the Atlantic Ocean, just outside of Charleston harbor, South Carolina. It is densely

wooded and takes its present name from its magnificent growth of palm trees. On the western end of the island there is a beach seven miles in length with an average width of about 150 feet. Its least width is 75 feet, which occurs only in a few places, and its maximum width is 250 feet. The beach is composed of white sand packed by the action of the tides so that it presents a surface practically as hard as a billiard table. It is free from quicksand and soft spots, and there is claimed to be no part of the beach on which the heaviest automobile could not stand indefinitely without the wheels sinking. The beach shelves almost imperceptibly into the ocean and is almost absolutely free of wreckage of any kind. At either end of the island the beach is from 250 to 300 feet wide, giving ample room to turn.

way, Gas & Electric Company, and also president of the Long Island Improvement and Construction Company, which owns the Isle of Palms, with an Orient Buckboard, for the purpose of ascertaining whether the beach was suitable as a speedway for automobiles.

The beach was found to be so hard that



HOTEL ON THE ISLE OF PALMS BEACH OFF CHARLESTON HARBOR.

no rut whatever was made by the machine, and only a slight mark was left on the beach by the wheels. At the eastern end of the island the turn was made at full speed; and in returning, although no special effort was made to speed the machine, very fast time was made. For several miles it was difficult to find the wheel marks on the beach made only a few minutes before.

The Seashore Improvement Company has developed a summer resort on the western end of the island, erecting a pavilion 300 feet long by 80 feet wide, bath houses, restaurants, cafes, carousal and steeplechase, and a hotel known as the Seashore Hotel, a photograph of which is shown herewith.

The Seashore is a modern hotel of sixty rooms, and in addition to the dining room in the hotel, there is a fully equipped restaurant at the pavilion to accommodate tourists. With the exception of the buildings mentioned there are none of any nature on the island, so that the beach is absolutely free for racing.

The Isle of Palms is reached by a double-end ferry from Charleston to Mount Pleasant, a distance of about three miles, and from Mount Pleasant by the electric road of the Charleston Consolidated Railway, Gas & Electric Company, eight miles. The tracks extend within a few feet of the beach. Automobiles can be taken over on the ferry and transferred from Mount Pleasant to the Isle of Palms on flat cars provided for that purpose, or they can be loaded on lighters at Charleston and taken direct to the Isle of Palms on the lighter.

An inspection of the beach, whose smooth expanse is shown in one of the photographs reproduced herewith, was made last month by J. H. Kast and J. J. O'Connell, manager and secretary respectively of the Army Cycle Company, and P. H. Gadsden, president of the Charleston Consolidated Rail-

road and fifteen from Washington, by rail.

During the summer the C. C. R., G. & E. Co. operates trains to and from the island practically every hour, the trip being made in 55 minutes. The railroad company stands ready to cooperate in any practicable way to make an automobile tournament on the Isle of Palms a success.

Charleston is on both the Atlantic Coast Line Railroad and the Southern Railway, and is reached from three to four times a week by the Clyde Line of passenger steamers from New York and Boston. It is twenty-one hours from New York and fifteen from Washington, by rail.

Up Snowdon in an Olds.

Up Snowdon in an Olds.

THE rack railway of Snowdon, the "monarch of Welsh mountains," seems likely to become to English automobilists what Mount Washington is in our own country. On January 26 last, it will be remembered, an attempt by Harvey Du Cros to drive a 15-horsepower Ariel car up that rocky road to fame was balked by an impassable snowdrift. The same man and the same car tried again May 26, this time successfully. Not quite four hours were spent in making the ascent of five miles, a delay due to shearing of the water pump connecting pin being partly accountable for the length of time spent. The car carried two passengers all of the way, and on the steepest grades—said to be 20 per cent.—from one to three more, two standing on the back of the car to give the tires the needed traction in the loose ballast.

Now the feat has been repeated, this time by an Oldsmobile runabout, driven by W. M. Letts, of Jarrott & Letts, in the total time of eighty-seven minutes and net time of fifty-seven minutes, after deducting stop-

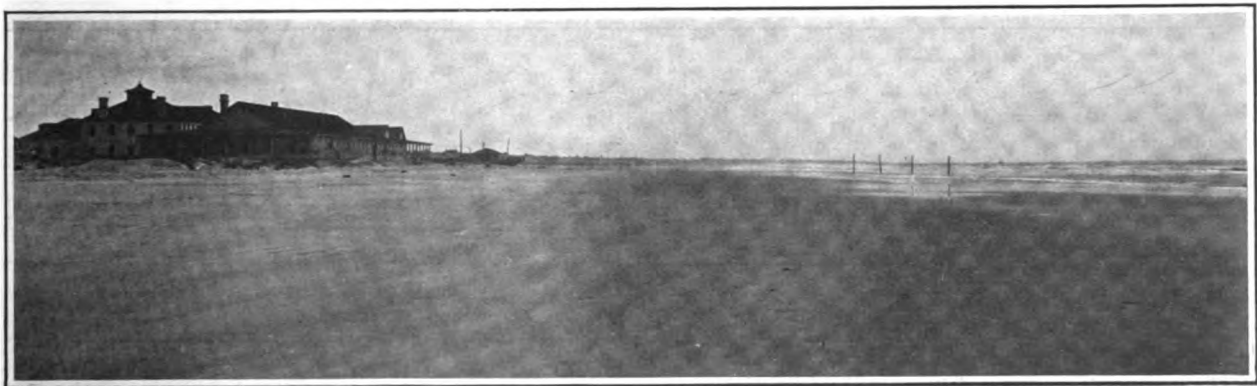

GENERAL VIEW OF THE ISLE OF PALMS BEACH PROPOSED AS A SPEEDWAY FOR AUTOMOBILE RACES.



The Detroit Automobile Club last month opened to its members the country clubhouse shown in the above engraving, from a photograph. This house is located on the Pontiac road, near Birmingham, fourteen miles northwest of Detroit. It stands well back from the road with an orchard on one side and a grove of oaks on the other. The building, which is an old residence, has been entirely renovated, redecorated and refurnished. The rear rooms are occupied by a steward and his wife, while the parlors and the second story front are reserved for club uses, the second story room being decorated and furnished in white for the use of the wives and daughters of members. The Ford Motor Company and the Peerless Motor Car Company have loaned the two tents seen in the grounds for use during the summer months.

pages to take on water and to lift the car over the various switches encountered along the way.

Mr. Letts writes that he first conceived the idea of driving an automobile up Snowdon four years ago, and, though owing to



DRIVING ON THE RACK RAILROAD.

a visit to the United States he missed the credit of actual priority, he thinks that his present record is likely to stand for some time. The car was a regulation Olds runabout, which had previously been driven about 50 miles, but which had not been specially prepared for the test. It carried about three gallons of gasoline and four of water. By its lightness it was well adapted to such a test, though the width of its gauge, as the wheels straddled the 31-inch gauge of the railway, and the low position of the differential on the axle, which at one time actually scraped the rack teeth between the rails, demanded both skill and coolness of the driver.

Following Mr. Du Cros' lead, Mr. Letts obtained permission from the directors of the Snowdon Mountain Tramroad Co. for the proposed use of their tracks, and Mr. Atchison, the company's manager, followed the trial in a special train. The start was

made at 6.57 a. m., and the climb was made on the low gear through at an average speed of a little under six miles an hour. Two brief stops were made to lift the car over switch points, which, by the way, the Ariel had to pass by driving over planks laid for the purpose. Halfway House was reached at 7.33 by Mr. Letts, the special stopping meanwhile to take on water. At Bwlch Penn Llyn Mr. Letts stopped ten minutes to let the special overtake him, and five more to give the photographers a chance. At 7.55 a stop was made to draw off the hot water in the tank, very little of which had actually evaporated, and replenish with cold. Two more stops were made to lay planks over the ties of open culverts, and at 8.24 the Oldsmobile drew up at Snowdon Summit to await the laboring special train.

Inspection of the photograph shows that the ties were well covered with ballast, but the latter was so coarse and loose as to jolt the car considerably; and, at the point above noted, where the differential case struck the rack, the car narrowly missed being sent over the edge of a thousand-foot precipice before its driver could bring it into the straight again.

We are indebted to the courtesy of Mr. Letts, of London, for the excellent photo-

graphs taken during his record-breaking trip.

COLONEL HUNTER'S AUTO CAR.

The following verses were recited upon the felicitous occasion of the presentation of an automobile runabout to Col. John G. Hunter, the venerable and respected secretary of the Dallas (Texas) Commercial Club, by his confreres in affectionate recognition of his valuable services:

No more will Col. Hunter walk, for friends, who feel for him,

And know the fearful pain incurred by each rheumatic limb,

Have given him an auto car to show the love they feel—

A vehicle whose parts embrace old overshoes and steel.

Down to his work henceforth will ride the Colonel debonair,

The breezes he creates will stir his wildly flowing hair,

And goggles made of bottle glass upon his nose will ride,

While whiskers like a split cascade will float on either side.

And people who appreciate his gentle, harmless soul,

Will dig a hole and climb inside, and then pull in the hole,

For, covering with mighty swoops the streets well paved and wide,

Will come the screaming auto car, the Colonel shrunk inside.

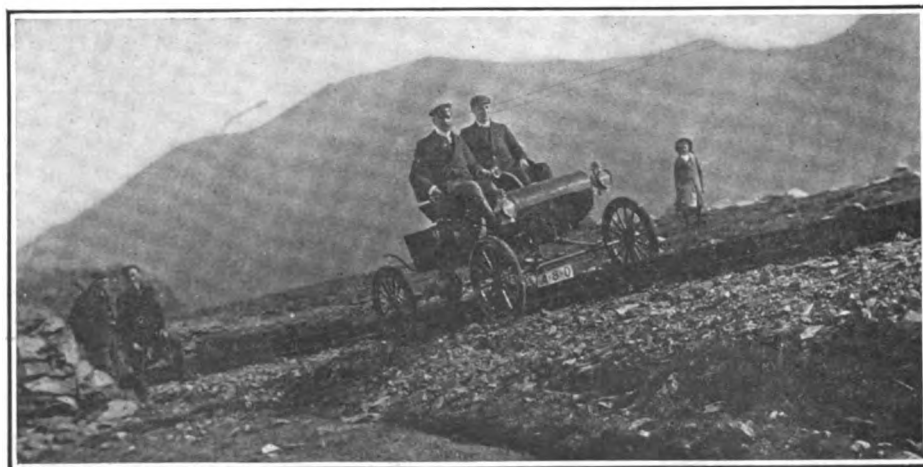

W. M. LETTS, OF LONDON, CLIMBING MT. SNOWDON IN AN OLDS RUNABOUT.

Challenge Cup Races for Auto Boats.

Auto Boat Standard Attains Maximum Speed of 23.68 Miles an Hour in C. Y. C. Races on the Hudson River.

AS a result of the races held June 23, 24 and 25, under the auspices of the Columbia Yacht Club, the gold challenge cup of the American Power Boat Association was won by the well-known racing launch *Standard*. The *Standard* showed remarkable form, beating her own record on the first day, and showing a little better speed on each of the two succeeding days. On the return stretch on the third day, against a flood tide and a strong head wind, she covered the distance from the stake boat to the starting line at the rate of 20.59 knots or 23.68 statute miles per hour. As her best previous average speed had been but 20.53 knots or 23.64 miles per hour, it seems altogether likely that the *Standard* has not even yet been put to the limit of her speed possibilities. What this rate of travel means for a launch just under 59 feet long on the water line may be realized from

Piermont. The races were under the management of the executive committee of the A. P. B. A., represented by Messrs. W. H. Ketchum, Anson B. Cole and J. H. McIntosh. The starting and timing at the finish were in the hands of the first two, while Mr. McIntosh, on board the gasoline yacht *Queen Bess*, acted as judge and timer at the turning mark.

DESCRIPTIONS OF THE COURSE.

This portion of the Hudson River averages just about one mile wide, expanding to double this width just above the turn. The tides are strong, and with the Palisades on the west bank and generally high ground on the east bank a wind up or down the river rolls up quite a sea. The start of the first race was made with more than half the flood tide run; so that all the races were on a strong flood tide, with the auto

The start was made at 3:05 p. m., an hour later than the official announcement specified. Each boat had her owner at the wheel, the *Standard* carrying also C. C. Riotte and an engineer; the *Water Lily* had three all told, and the *Fiat I.* had an engineer, crowded on to the forward thwart beside Mr. Tangeman.

The *Fiat* made a very sharp start, but the *Standard* very quickly overhauled both the others and took the lead, increasing it as long as the three were in sight. After the first few minutes the sport lagged for those on shore and it was some time before the monotony was broken by the return of *Fiat I.* Mr. Tangeman explained that she had struck a floating log, which stove a hole in her and also injured her wheel. The *Standard* rounded the mark at 3:53.40, having averaged 19.72 knots over the first half of the course. At the same time the *Water Lily*, 6 minutes 15 seconds astern, had more than saved her time over the first half of the course. On the way down the head tide and wind told against the shorter and less powerful boat, and the *Standard* finished nearly 23 minutes ahead, winning by 5 min-

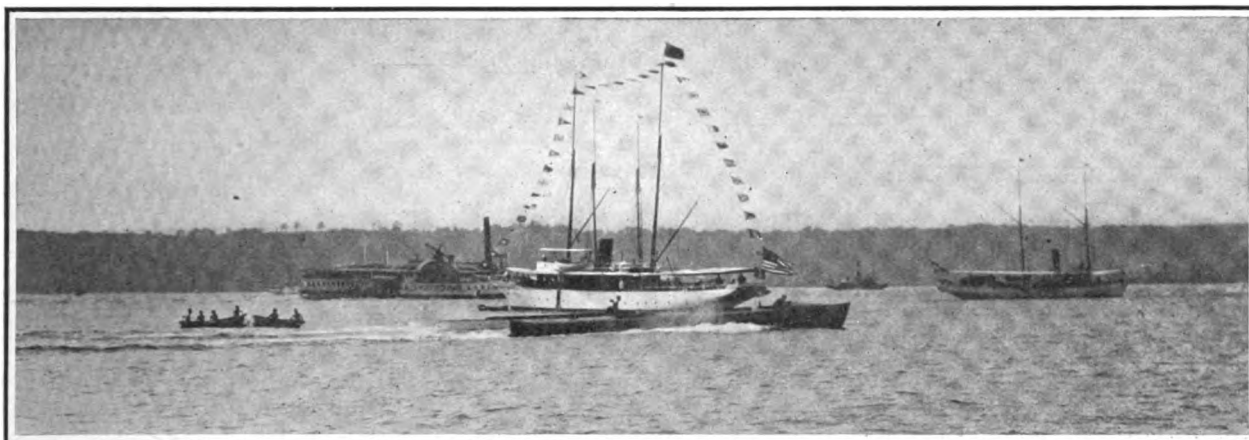

AUTO BOAT "STANDARD," WINNING GOLD CHALLENGE CUP OF AMERICAN POWER BOAT ASSOCIATION IN HUDSON RIVER.

the fact that it is better by .69 of a knot than the speed made by H. H. Rogers's steam yacht *Kanawha*—192 feet water line length—in her victorious contest for the Lysistrata Cup only a week before.

STANDARD AND WATER LILY.

The *Standard's* only staying competitor, the *Water Lily*, a 40-horsepower launch entered by Frank Seaman of the Yonkers Corinthian Yacht Club, made average speeds of 18.35, 19.25 and 18.68 miles per hour on the several days, the low average on the first day being due to her striking a floating log and bending the propeller shaft bracket. By hard work all night this damage was repaired in time for the start the next day. Under the allowance given the *Water Lily* by the *Standard* the former lost the race by margins of only a few minutes each time.

The three races were sailed over a course of sixteen nautical miles up the Hudson River and return; the start being off the Columbia Yacht clubhouse and the turn off

boats on the upward journey and against them on the return. The wind was also up the river on each occasion.

The cup was expected to bring out a very large fleet of the fashionable auto boats of which so much has been printed during the past six months, but in this respect it was a complete failure, only three boats starting in the first race and one of these soon withdrawing permanently. The starters on the first day were:

Boat	Owner	Motor	L.W.L.	H.P.	Rating	Allowance
Standard	E. A. Riotte	Standard	58.90	125.65	79.20	Allows
Water Lily	Frank Seaman	Speedway	43.60	37.20	67.65	17 min. 14 sec.
F. I. A. T. I.	C. H. Tangeman	F. I. A. T.	31.90	35.02	69.03	14 min. 26 sec.

The first day was clear and warm, with a moderate southwest breeze diagonally up the river; there were present a number of steam yachts anchored off the clubhouse and a rather small number of spectators ashore. Among these were some sailing yachtsmen who were out to take the measure of the new sport of auto boating.

utes 24 seconds, corrected time. Mr. Seaman reported that the *Water Lily* had also struck a log, injuring her wheel, and as it proved, the shaft bracket as well.

The Speedway launch *Alert*, seen in the Columbia Yacht Club regatta of June 11, was present during the afternoon, but with her name removed. She was in company with a newer launch of similar model and dimensions and also named *Alert*; the latter, steered by C. L. Seabury, doing some

fast running, though neither was entered.

The weather was again favorable on Friday, there being only a light southerly wind up the river. The start was made as before at 3:05, only the *Standard* and the *Water Lily* being present. The *Standard's* speed up the river, averaging 21.33 knots, represents her highest public performance.

After finishing the 32-mile run she sped Charles R. Flint's steam yacht *Arrow* bound up the river and made out to meet her, running for a couple of miles in close company with that notably fast boat.

RESULT A FOREGONE CONCLUSION.

Though the result was now a foregone conclusion, there was a large party of spectators for the final race on Saturday. The weather was much warmer, but there was a fresh breeze up the river. Before starting the *Standard* was remeasured, on the protest of Mr. Seaman, but the result was not made public. On nearing the markboat Mr. Riote mistook another anchored boat for it and made the turn, afterward returning and following the correct course at the cost of some little time, the average speed up being less than on the return against wind and tide. The *Standard* finally finished with a lead of 24 minutes, winning by 6 minutes 51 seconds corrected time. The races were scored by points, one for each start made by a competitor and one for each boat defeated; thus the *Standard* scored three on the first day and two on each of the following days, seven in all. The *Water Lily* scored two points on the first day and one on each of the other days, four in all. The complete times of each race, with the average speeds in knots over each half of the course and also over the whole course of 32 nautical miles, are as follows:

SUMMARY OF THE THREE DAYS' AUTO BOAT RACES.

First Race, Thursday, June 23. Start 3-05.								
Outward Course.			Homeward Course.			Whole Course.		
	Turn.	Elapsed.	Knots.	Finish.	Elapsed.	Knots.	Elapsed.	Knots.
Standard	3-53-40	48-40	19.72	4-42-48	49-08	19.54	1-37-48	19.63
Water Lily	3-59-55	54-55	17.48	5-05-26	1-05-31	14.65	2-00-26	15.94
Fiat I withdrew.								
Standard wins by 5 minutes 24 seconds, corrected time.								
Standard 3 points. Water Lily 2 points.								
Second Race, Friday, June 24. Start 3-05.								
Standard	3-50-00	45-00	21.33	4-38-30	48-30	19.79	1-33-30	20.35
Water Lily	3-57-30	52-30	18.27	4-59-40	1-02-10	15.43	1-54-40	16.72
Standard wins by 3 minutes 56 seconds, corrected time.								
Standard 5 points. Water Lily 2 points.								
Third Race, Saturday, June 25. Start 3-05.								
Standard	3-52-43	47-43	20.12	4-39-21	46-38	20.59	1-34-21	20.35
Water Lily	4-03-31	58-31	16.51	5-03-26	59-55	16.02	1-58-26	16.22
Standard wins by 6 minutes 51 seconds, corrected time.								
Standard 7 points. Water Lily 4 points.								

The cup is now held by the *Standard*, subject to challenge on six months' notice, but as a thorough trial of all the new boats of the year is in every way desirable, it is probable that this notice will be waived and another race run later in the season. Though without a competitor of her own class, the *Standard* has made a most creditable showing in these races, running very regularly and evenly, without mishap of any kind, and making an average of over 20 knots, or 23.20 statute miles, for the three races.

PARISIAN boys have, it is said, begun to emulate the American boys in throwing stones at automobiles. A boy recently arrested in Paris for this offence said he hated all automobilists.

PUBLIC CAB FARE REDUCED.

New York Transportation Co. Issues New Schedule for Electric Vehicles.

Electric cabs and other public vehicles have been operated in New York City for a number of years by the New York Transportation Company, and while it was intended that these vehicles should take the place, to some extent, of horse-drawn vehicles, the prices charged prevented any great inroads into the field of the time-honored "hay-motor," the electric brougham remaining largely the conveyance of the comparatively wealthy. Up to the present time the New York Transportation Company has not seen its way clear to reduce its prices to a popular level owing largely to the fact that the business was a new one, comparatively speaking, and the company was spending time and money in perfecting the details incident to the effective and economical handling of a large number of mechanically propelled vehicles.

Believing that most, if not all of these problems have been satisfactorily solved, the New York Transportation Company has drawn up and issued a schedule of rates for electric vehicles which has caused widespread comment and no little astonishment owing to the wholesale reduction of prices

The mileage rate has been reduced from 50 cents to 40 cents per mile, or fraction,

Washington square, including the Christopher street ferry. This covers an area about 5 miles long and over 2 miles wide, and embraces all the principal retail stores and a large and fashionable residential section. If these boundaries are crossed, regular mileage charges are added while the vehicle is out of the prescribed district.

There is, however, an important provision in the new schedule, and one that considerably modifies its scope. The reduced rates will not be in force between the hours of 1 P.M. and 6 P.M., when the old charges will apply. The reason for this is that the company has all the business it can handle, with the present equipment, during that part of the day, and to reduce the rates would simply create a demand which could not be supplied.

Some of the rates for regular trips of various kinds are interesting. For instance, to be taken to the theatre in a hansom, brougham or extension brougham, and brought home again afterward, costs \$2.50 as long as the trip is in the district below Seventy-fifth street and above the Christopher street ferry, this section being about 4 1-2 miles long and 2 miles wide. A single brougham can be hired to go to Coney Island and return, about 28 miles altogether, for \$10, or a hansom or extension brougham for \$12, and the same rates apply to the trip to and from the Morris Park race track, a total distance of 29 1-2 miles, which includes waiting for the conclusion of the races.

Many reasons have influenced the officers of the Transportation Company in its action in this matter, chief of which is the desire to build up an enormous business, paying small but quick profits. The business during the afternoon, when the regular rates are charged, is, as has already been said, almost more than can be handled; but during the morning and evening it is not nearly so lively, and the reduced rates are expected to keep the vehicles busy all the time. There are other reasons as well. The running expenses of plant and vehicles have been largely reduced during the past few years. The tire problem, which at one time seemed likely to swamp the enterprise, has been brought down to a practical basis, and the same is true of the battery. Electric current, of which an enormous quantity is consumed, becomes cheaper per unit the more it is used. And so on, until it becomes evident that the reduction is simply the natural course to take under the circumstances.

A feature that removes one of the extremely disagreeable possibilities of cab hiring is the manner in which the fare is paid and checked. The driver enters in a book the amount received and gives the passenger a duplicate as a receipt. If the passenger is overcharged, he can go to the offices of the company and have the overcharge refunded without the necessity of the wrangling with the driver which is too frequently seen in the street.

for a single brougham, and 50 cents per mile or fraction for an extension brougham, carrying three or four people. A hansom also costs 50 cents per mile, while the highest mileage rate is that charged for a victoria or surrey—75 cents per mile. The waiting rates are 50 cents per half hour or fraction thereof for any of the above-named vehicles except the hansom, the waiting charge for this being 50 cents per hour or fraction.

The hourly rates, which apply to shopping trips, making calls or other service where there are numerous short stops, are \$1 per hour or fraction thereof for single brougham, \$1.30 for a hansom or extension brougham, and \$2 for a victoria or surrey. This class of rates applies only in the district between Eighty-seventh street and

Buffalo Club's New Rooms.

Special Correspondence.

BUFFALO, June 27.—The four hundred eighty odd members of the Buffalo Automobile Club now have the incentive of charming clubrooms for their exclusive use to draw them together frequently in social conclave. The new quarters were formally opened a fortnight ago with a smoker and lively entertainment, and they give promise of being largely used by the members every day when they have been completely fitted up.

The rooms are centrally located at 59 Franklin street, only one square from the city hall and two blocks from the business center of the city on Main street. They comprise all of the second floor of the new buff brick two-story building just com-

partially cover the polished maple floor.

Near the middle of the long side wall is a huge fireplace of light red stone. Between this and the front windows stands an upright piano and in front of the piano is a large reading table covered with the latest issues of all the automobile publications of the country. The members—especially the house committee—are considering the advisability of adding a billiard table, a pantry and cigar stand to be placed in charge of the steward.

But the feature of the rooms that promises to be most popular with the members is the delightful balcony extending halfway across the front of the building. This is roofed over, spread with a rug and furnished with half a dozen rocking chairs. Here on hot days and evenings will be a

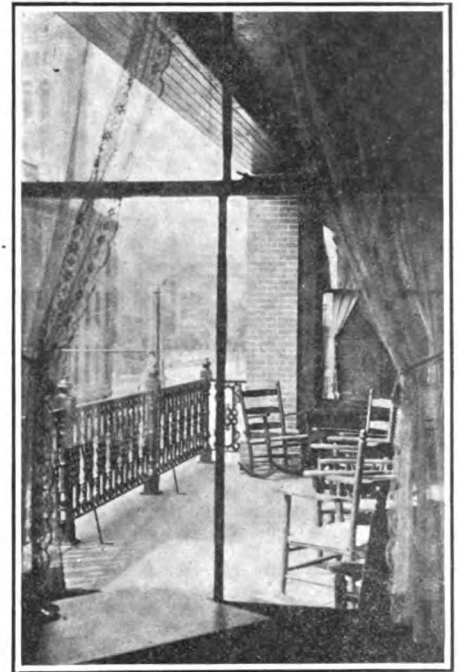

LOOKING OUT ON THE BALCONY.

pleasant place to congregate to smoke and talk, while keeping cool and watching the passing traffic in the street, with the trees and lawns in front of the city hall as a restful background for eyes smarting perhaps from the dust of a day's riding.

MORE than 1,800 automobiles have been registered with the Connecticut Secretary of State since the license became effective about a year ago.

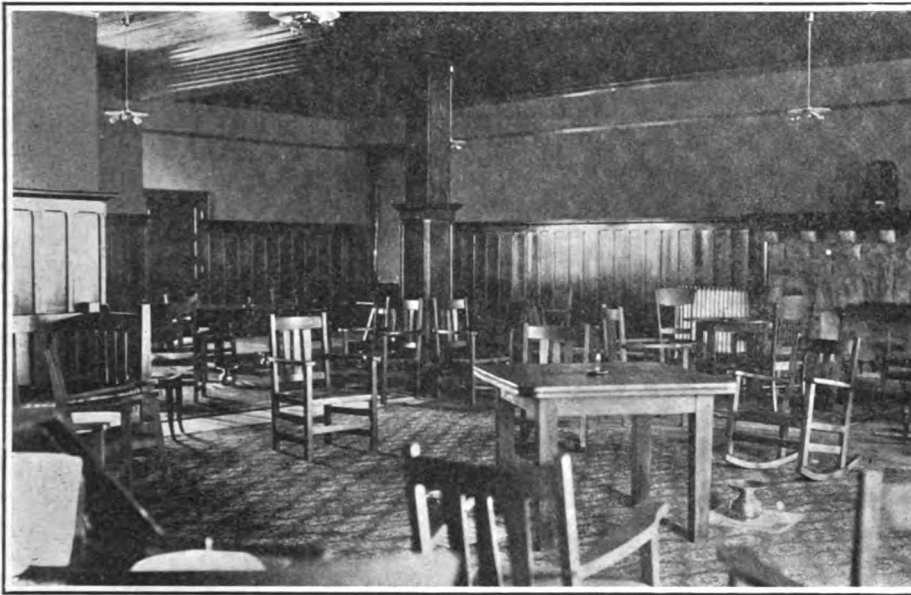

ASSEMBLY ROOM IN THE NEW QUARTERS OF THE BUFFALO AUTOMOBILE CLUB

pleted, and occupied by the Centaur Motor Company, in the rear of its Pearl street factory building where Centaur automobiles were formerly built, but which is now used for repair work. The ground floor of the new structure is used as a sales room for several leading makes of cars in the central territory from Syracuse west to Detroit. At the right a broad passage bricked off entirely from the show room gives access to a garage where members may store their cars and have repairs made. A stairway on the left leads to the clubrooms. These consist of one very large assembly room, well lighted from the front and having two large rear windows. At the head of the stairs is a fair sized room for the secretary's office, wash room, coat room, and a retiring room for women.

The rooms are finished in Flemish oak wainscoting half the height of the walls, above which the walls are kalsomined in old rose. The assembly room is liberally furnished in mission style furniture, and the windows are hung with lace curtains. Four or five rich toned rugs of large size



BUILDING ON FRANKLIN STREET, BUFFALO, IN WHICH CLUB ROOMS ARE LOCATED.

On the Road to St. Louis—VI.*

Sand Embankment on Turn of New Macadam Road Nearly Causes Disaster—Chicago Automobile Club Hospitality.

Special Correspondence.

PONTIAC, Ill., June 25.—The run from South Bend, Ind., to Chicago, 102 miles, which is scheduled to be made in one day on the St. Louis tour, is easily accomplished. The roads are good and the country level; the only trouble is an occasional patch of sand which requires some careful manipulation to get through. While mentioning sand, let me tell of a little experience we had last Sunday. We made La Porte late Saturday night and spent Sunday there. Finding a clever lot of boys among the automobile enthusiasts of that city, we crowded three of them into *Pathfinder* and set out Sunday evening for Michigan City, Ind., with six persons aboard.

There is a fine macadam road from La Porte to Michigan City, fourteen miles, and had we stuck to it all would have been well, but we took the wrong road and struck sand in the darkness. It was down hill and the automobile, on low speed, ploughed through it for a half mile and then refused to go further. There was power to spare and the rear wheels spun around, throwing sand higher than our heads, but the car stood stationary. We got out and looked around. Sand was everywhere—soft, light sand that had been shifted and piled up by the wind. Then the advantage of having a light car became evident again, for with five of the passengers putting their shoulders to the rear and the lightest man starting the engine, we once more started, this time in the direction of the macadam we had left.

ALMOST OVER A BANK.

The road between the towns of Otis and Durham, and about nine miles west of La Porte, was being "worked." Indiana road making is very different from York State road building. In New York a very firm rock foundation is laid down before any attempt is made at macadamizing. In Indiana crushed stone is simply shoveled into the middle of the road and loose dirt piled up on each side to keep it in place. While running on low speed over a lot of this crushed stone, expecting a puncture at any instant, we came to an unexpected sharp curve in the roadway with a deep ditch on either side.

Our Elmore car is supposed to weigh about 1,200 pounds, but we have it filled with baggage, including a sixty-pound typewriter, many pounds of tools and extra parts, an extra gasoline tank, two hampers filled with luggage, and three tourists, each weighing in the neighborhood of 160 pounds. When this load, aggregating a ton, struck that curve the loose dirt on the outer side gave way and the crushed stone roadbed, the car and its occupants began to slide

over the edge of the embankment. Two of us jumped, but the steersman, held in by his wheel and levers, could not do so, and for a full two seconds it looked as though our St. Louis trip would end right there.

With two wheels over the bank and the axles resting on the brink, the car came to a standstill, while a frightened driver crawled out from the off side of the car and surveyed the scene with a sigh of relief. Our first move was to rope the rear wheels securely to a tree on the opposite side of the embankment. Then by united efforts we lifted the front end of the car up into the roadway and tied the front wheels

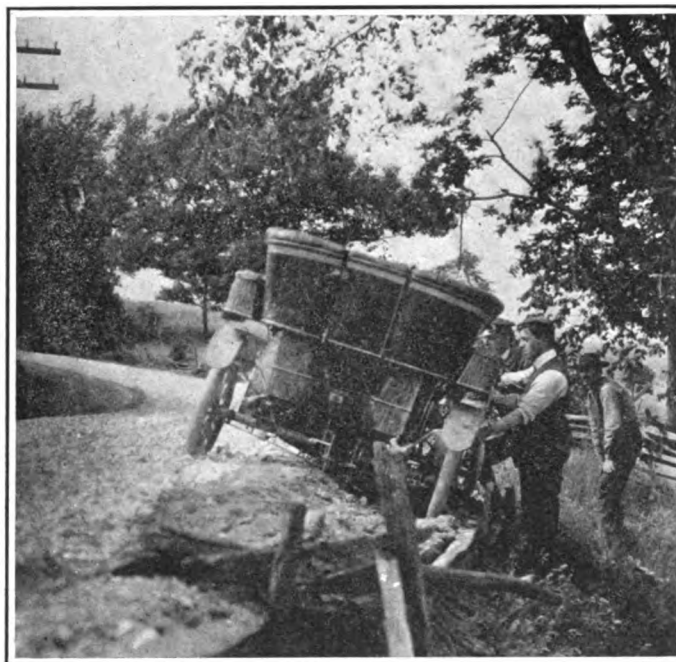

TROUBLE CAUSED BY LOOSE EMBANKMENT NEAR LA PORTE, IND.

to a tree until we had shifted the rear end. After a careful examination of the engine and running gear we once more moved westward, none the worse for the adventure. Further on we were informed that a team of horses, wagon and two men had gone over the same bank a few days before, both horses and one of the men being badly injured. A stone wall and a guard rail are to be erected at this place soon.

HORSES TAKE FRIGHT.

The horses throughout Indiana and Illinois show great fear upon the approach of an automobile and it is claimed that this is due to careless driving on the part of several owners of automobiles residing in the small towns, who consider it the acme of fun to drive a noisy touring car at high speed when passing horses or cattle in the highway, causing runaways and crippling

stock all through the section. The damage and trouble caused by these irresponsibles is laid at the door of automobilists in general and all suffer the ill-will of the rural inhabitants as a consequence. There is no Illinois automobile license law, and as the cars do not carry numbers it is impossible to identify the reckless ones.

The exercise of care and consideration when meeting teams along this route means considerable lost time, but the grateful expressions of thanks from the drivers more than compensate for the delays. One old Irishman driving a team of big western horses is remembered in particular. We stopped the car when near him, but the engine was still running and his horses were crowding to one side and getting ready to turn, upset the wagon and bolt. "Will ye stop the noise of it?" asked the driver. We shut off the engine and our friend with the brogue drove up to the

Pathfinder and stopped to allow his team to smell the automobile. "Now I give ye fellers credit for the civilization ye have. D'ye see that off hoss and the scratches on her back? Well, sure that's where she wint through a barb wire fence day before yesterday upon seeing the likes of a machine liken yours. And d'ye mind that cut on me nose? That's where I wint through the same fence after me mare."

WANTED TO SEE HIS PICTURE.

Near the town of Morris, in Illinois, we stopped to take a picture of a bad bridge that had all but ditched the *Pathfinder* and her crew. An old farmer coming along the road was invited to be a feature of the picture, and after carefully parting his hair, dusting off his cowhide boots with a red handkerchief and cracking a smile from ear to ear, he was snapped. When told "That is

*Continued from Page 686, issue of June 15.

all," he inquired: "An did you take the picture?" The affirmative answer promptly brought the demand, "Wall, let me see it." He is still trying to get through his head the reason why he could not see his photograph there and then.

The dog problem has been solved at last after five weeks on the road, during which we sought in vain a means to drive dogs from in front of the car, where they persisted in running and barking, occasionally falling and getting run over. A farm lad shooting at birds with a sling-shot and fine bird shot gave us the happy idea, and the writer is now redeveloping the skill with a sling-shot that he possessed as a school-boy a decade or more ago.

CHICAGO CLUB EXTENDS COURTESIES.

A number of automobilists awaited our arrival at Chicago, having followed the cruise of the *Pathfinder* in the papers. We struck the Windy City during the Republican National Convention and the hotels were crowded. The Chicago Automobile Club came to our rescue and insisted that we occupy sleeping quarters in the clubhouse on Michigan avenue.

Pleasant rooms on the second floor were assigned to us and we found the restaurant in the basement well conducted and moderate in prices. Visitors' tickets entitling us to the use of the clubhouse and all privileges for a period of ten days were issued to our party, but we limited our stay in Chicago to two days, running on to Joliet, the city scheduled for the noonday stop of the big run on August 8, the thirty-seven miles being covered easily before dark.

While leaving Chicago over Jackson boulevard, we overtook a gentleman driving a Cadillac, who kindly offered to pilot us out of the city and we followed his lead. A large Newfoundland dog took offense at the foremost car and made a dash for the front wheels. He disappeared for an instant, and when that dog emerged from underneath the rear axle of the Cadillac and scampered yelping to one side of the road where his master was awaiting him, he looked as if he had escaped from a hair-clipping machine, only to pass through a mangler. It's a safe surmise that he will be less impetuous about automobiles in the future.

ILLINOIS ROADS CAREFULLY MAPPED.

Chicago is planning a big turnout for the St. Louis tour next August, as well as an interesting programme of entertainment for the visitors who arrive there on Saturday night, August 6, and spend Sunday in that city as the guests of the Chicago Automobile Club. Frank X. Mudd, chairman of the local touring committee, has carefully mapped out the roads between Chicago and St. Louis. He furnished us with such explicit information regarding the nature of the country and roads between his city and the exposition, that getting off the trail seemed impossible. Mr. Mudd said that he was giving about two hours a week to

his business interests and all the rest of his time to automobile work, the St. Louis tour taking up the greater part of it.

BRIDGE APPROACHES BAD.

The roads from fifty miles east of Chicago to Lincoln, Ill., nearly 200 miles south, are almost perfect, and a speed of twenty miles per hour can be kept up all the way by cars of even moderate power. The only trouble encountered on this run is the approaches to bridges. No matter how small the bridge, these are bad. So fearful are the bridge builders of floods—and not without good reason—that they build all bridges from one to four feet higher than the level of the roadways, and the approaches to these bridges are not always properly made. If taken too slowly in an automobile the wheels strike the bridge and the vehicle stops. If taken at high speed the chances are that wheels, tires or springs will suffer. Especial care must be exercised in night running, as the lamps throw a very deceptive light and what looks like a smooth approach to a bridge often causes a bad jolt.

ESTEEM OF LIGHT CAR GROWS.

In almost every town we pass through we meet automobilists who have followed the trip of the *Pathfinder* from New York City with interest, and our little car attracts more attention than do any of the big ones when we pull up in front of the postoffice or hotel.

"Do you know, since reading the account of your trip I have decided to enter my little car in the St. Louis tour next month," is the final sendoff we get in many places, where the general opinion is that nothing short of a \$2,500 automobile with at least 20-horsepower could make such a tour as we have nearly completed. And when we tell them that our bill for repairs thus far has been less than \$1, the esteem of the small car goes up with a bound.

Diving for an Auto.

It is not often that the services of a diver are required to put an automobile into commission; but at least one case of this kind is on record, having occurred at New Orleans, La., recently.

A party of three gentlemen and a lady went for a spin in a touring car, driving along a fine shell road that runs from the West End Pleasure Resort to the city. The car was clipping along at a 35-mile gait, so 'tis said, when two of the men, each wanting to steer, got hold of the wheel together. The result was a sudden swerve of the car out of the road, over a five-foot bank, knocking down two heavy posts and a wire fence, and into a canal with a mighty commotion of the ordinarily placid water. The luckless four were rescued by boats and rowed ashore, where they got into a carriage and drove home, quite uninjured.

Next morning Charles U. Kennedy, of the Automobile Company, Limited, hired a

schooner and a diver and went to the rescue of the car. The boat was anchored close to the machine, whose position had been marked by lights hanging on a stake, and the diver attached hoisting tackle, having to make four trips below to do so. The schooner's derrick then hauled the car out



RESCUING A SUBMERGED AUTOMOBILE.

of its unwonted position and deposited it on the shore, where it was subjected to the additional humiliation of being towed to the station by a mule team. The machine suffered no serious injury beyond the warping of the woodwork and the damage to the upholstery, and is now on the road again—this time, it is safe to assert, in charge of one man at a time.

AN AUTOMOBILE exhibition has been suggested as an attractive feature for the annual fair to be held August 30 to September 1, inclusive, at Brandywine Springs Park, four miles from Wilmington, Del., under the auspices of the Pomona Grange of New Castle County. The fair is to be a State event this year, instead of simply for the county, and elaborate plans are being laid to make it larger and more attractive than ever. It is estimated that with fair weather



HUMILIATION OF NEW ORLEANS AUTO.

the attendance will reach 150,000, people coming from all parts of the State and from Pennsylvania, Maryland and New Jersey, and in view of its wide scope especial interest is being taken this year in the mechanical features.

HINTS ON OPERATING A RUNABOUT.

When starting out for a run take a glance over the various parts of your car, even though you know positively that the machine is in good mechanical condition.

See that your tires are all standing up. A nail or other sharp-pointed object might puncture and deflate a tire without your noticing it. Also see that the caps are screwed on the valves. It is easy to forget them when pumping up tires.

See that you have shut off all drain cocks in the water, gasoline and oil systems, so that you will not distribute your supplies along the road as you travel. Also be sure that such cocks are tight enough to stay closed notwithstanding the vibration of the machine and the occasional rough jolts it is pretty sure to receive.

See that the porcelain in your spark plug is not cracked, and that you have a spare plug or two along, or at least an extra porcelain.

See that you have replenished the tire repair box with rubber solution and tape which you used up during the last trip. A tire repair outfit without puncture solution and tape is about as useless as a tire without air.

See that you take your starting crank along, if it is of the detachable kind. This advice may seem a little superfluous, but if you ever witness the desperate struggles of a man trying to start his motor with a monkey-wrench you will value it at its true worth.

Do not use gasoline that has been subject to evaporation for a long time, or what is called stale gasoline. It will not work satisfactorily.

* * *

If you think there is any leak anywhere in your gasoline system, find it and repair it at once; but do not go hunting for it with a match, or candle, or open flame of any kind. If you do this, and there is a leak, you will run a good chance of finding it prematurely and at the same time setting the machine on fire. The best light for this purpose, or, in fact, for any work in the immediate vicinity of the machine, is an electric lamp of some sort. If you have your automobile house fitted with electric lights the proper thing to use is a lamp on an extension cord. If not, about the handiest thing for lighting up corners is a little battery lamp, which can be worked from a set of dry cells. For road work such a lamp may be worked from the ignition cells; but this is not advisable, as it is very hard on the batteries. It will be found better to carry one of the convenient pocket electric lamps, of which many are on the market. One of these lamps, with reflector and lens, will be found most useful, and extra batteries, to be used when the original ones are exhausted, are inexpensive and can be carried very easily.

The statement is frequently heard that the useful life of a car, especially a small car, such as a runabout, is one, or at most, two seasons. There is no reason why this should be the case, and, as a matter of fact, any well made car will last for a much greater period if it is properly taken care of and repairs and renewals made when necessary. It is all in the manner in which the machine is treated—barring bad smashes, of course—and there are many small cars running to-day, and running well, that have been in active service for four or five years, and even more.

* * *

A very good way to keep tires in good condition is to carefully fill up cuts with rubber solution and bind them with tire tape until the cement has thoroughly set. Bits of stone or dirt will enter even small cuts and enlarge them, and prepare a soft spot for a puncture, as well as admitting water to the fabric of the tire. If the machine is not to be used for a considerable time, as, for instance, when laying up for the winter, take the weight off the tires by means of jacking, blocking or any other convenient method, and you will avoid considerable injury to them.

* * *

As a nail will often pierce a tire and remain in it, temporarily preventing leakage of air, tires should be examined frequently for injuries of this kind. A tire may suddenly "fizz" and go flat owing to the loosening of a nail picked up on a previous run. A nail is also apt to injure the parts of the tire adjoining the original puncture. A rather curious case of this kind occurred when a 3 1-2 inch tire was punctured by a horse-shoe nail. The nail went through the tire at the tread, and as the tire began to deflate it punched about a dozen small holes on the opposite side of the inner tube and finally got a blow strong enough to send it clear through to the steel rim, upon which it bent over, hooking itself between the rim and tire in such a way that considerable difficulty was experienced in getting it out. When found the nail was inside the tire, the head having pulled through the tread when the point became clinched.

* * *

In descending long hills where brakes are apt to become much heated, or if for any reason it is desired to relieve the brakes, the speed of the car may be checked by letting it coast with the low gear engaged and the spark shut off. Many cars may be started on a down grade in the following manner: Release the brake, and as soon as the car has required a little momentum throw in the high speed clutch, passing quickly through the low gear. Have your spark set as for starting with a crank, and the motor ought to start up promptly. If neatly done this makes quite a "grand-stand play" and

looks very mystifying to one who is not "in the know." If the motor is cold it will have to be primed, just as in starting with the crank.

* * *

In attacking a steep grade, go at it on the high speed, and as soon as the motor becomes overloaded and slows down, change quickly to the low gear. This is much pleasanter than throwing in the low gear at once, and a good deal of time may be saved, especially if there are many hills to be climbed. But do not wait too long before changing, and do not let the car start backward, as, if the hill is very steep, the motor may be stopped by the sudden strain, which is not good for the car in any case. Make the change while the car still has enough momentum to give the gear a chance to take hold.

* * *

The following method of applying asbestos gaskets is sometimes adopted by repair men, and with good results. The gasket is soaked in strong brine, the surfaces of the joint brightened and the wet gasket put on and tightened down. The salt causes a film of rust to form on the clean metal surfaces, which causes the gasket to adhere strongly. While this method is hardly as mechanical as it might be, still it answers very well. Of course, the breaking of the joint means the destruction of the gasket, whereas a gasket put on with graphite on one side and red lead on the other, if carefully handled, stands several removals, especially if the gasket is made of the copper wire gauze and asbestos combination.

* * *

It is not necessary to prime a hot motor. In fact, if you do you will have to work out the over-rich gas with the starting crank. The mixture will be too rich to ignite, and you cannot get an explosion until it is reduced to the proper proportion.

* * *

Do not try to economize in batteries by using old cells with new ones. The weak cells will reduce the strength of the current, so that the battery will work almost as if it was composed entirely of old cells. If you have two sets of cells, and have pretty well used up both, you may help matters along by wiring both sets together; but when you get to this point it is high time to put in new batteries all around.

* * *

Lubricating oil frequently contains impurities that clog pipes and oil-ducts and reduce the supply of oil. Therefore, it is a good thing to strain your oil through cheesecloth. By straining gasoline through chamois, oil through cheesecloth and taking care that water is clean, you will be in a position to know that trouble from these sources is not likely to occur.

The Vanderbilt Cup.

The challenge trophy offered as a prize for the William K. Vanderbilt, Jr., cup race has just been completed by Tiffany & Co., of New York, and has been placed upon exhibition for a few days in their Union Square store. This massive silver trophy is classical in form, as shown by the accompanying reproduction from a photograph. The ornamentation is simple, consisting of a laurel wreath encircling the brim to signify success and a fine portrait in bas relief on one side of Mr. Vanderbilt in his 90-horsepower Mercedes at Ormond Beach. On the opposite side is engraved the following:

"Challenge Cup Presented by W. K. Vanderbilt, Jr., to the American Automobile



VANDERBILT SILVER CHALLENGE TROPHY.

Association, under deed of gift, to be raced for yearly by cars under 1000 Kilos. Won by _____."

The cup stands 31 inches high, including the wood base, and has a capacity of 10 1-2 gallons. The bowl contains 481 ounces of sterling silver.

Pope-Toledo Racer.

Additional information regarding the Pope-Toledo 60-horsepower 4-cylinder gasoline racer, which will be a candidate for the Vanderbilt cup, indicates that in its general features the car partakes largely of the design of the Pope-Toledo 24-horsepower touring car. The motor, however, is of course much larger, the cylinders having a bore of six inches and a seven-inch stroke. The normal speed is 1,200 revolutions per minute. The intake valves

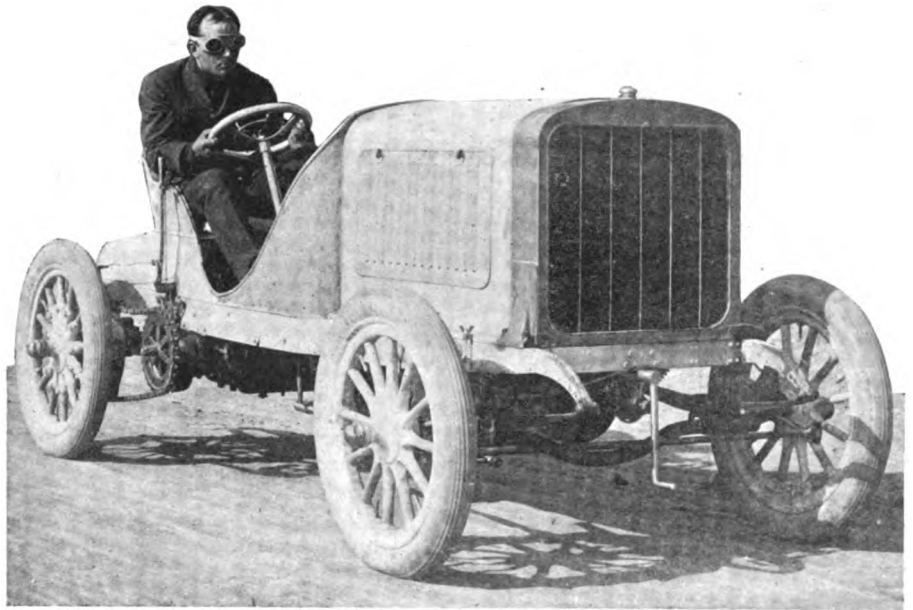

O. F. WEBER'S NEW POPE-TOLEDO 60-HORSEPOWER VANDERBILT CUP RACER.

are automatic, and the cylinders are jacketed with copper. The engine lugs are bolted directly to the side members of the channel steel frame, which is bent inward at the front. The makers state that the transmission is the same as that used in the Pope-Toledo touring cars, "giving three speeds forward and reverse." Just how the changes of speed are made is not apparent, as no control lever is visible in the accompanying photograph. The cone clutch is of aluminum. Axles, spring-hangers and other parts subject to great strain are made of nickel steel. Outside chain drive is employed. Wheels are 34 inches rear and 32 inches front, with 4-inch special racing tires. A slight pressure is maintained in the fuel tank to insure a regular flow of gasoline to the carbureter, which is of the regular Pope-Toledo construction, enlarged

to meet the demands of the larger motor. The car is equipped with a muffler and is said to be very quiet in operation, and to have a control on the high gear by which speed can be cut down by throttle to "eight or ten miles an hour." The speed on the high gear is normally 76 miles an hour. The wheel base is 11 feet, and the car is lighter than the touring car by 200 pounds. O. F. Weber, of the firm of O. F. Weber & Co., Chicago, is the owner of this new racer, it having been built to his order.

THE signal corps of the U. S. Army, Department of California, is to employ automobiles. Major Parker W. West, aide-de-camp of General Arthur McArthur, has been ordered by General A. W. Greeley, chief of the signal corps, to purchase two cars in San Francisco.

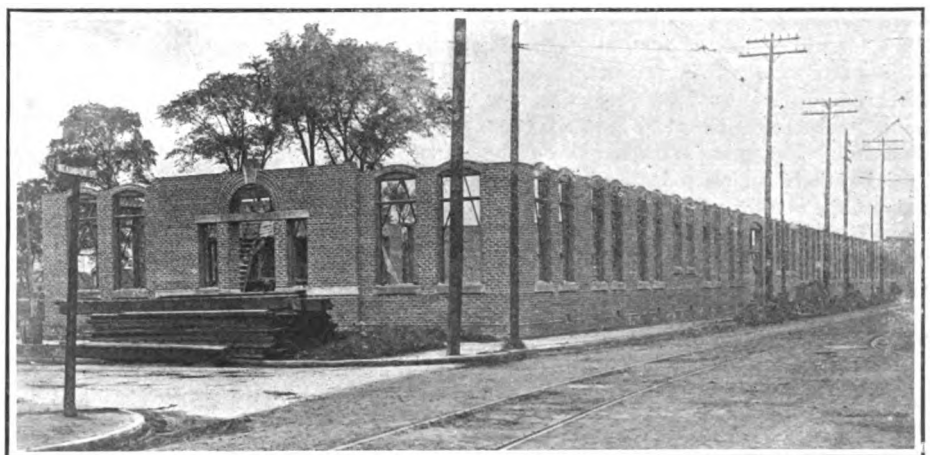

Ground was broken less than a month ago at Beaubien and Piquette streets, on the northwestern outskirts of Detroit, for a new factory building for the Ford Motor Company. Already the structure has reached the stage of construction shown in the above picture, which shows the first of the three stories called for by the plans. The building is 400 feet long and 50 feet wide. The rear end abuts upon the Lake Shore & Michigan Southern Railroad, so that the company will have excellent shipping facilities. With such a narrow structure, it is evident that all departments of the plant will be well lighted. The plant will be completed in August and manufacturing operations for the season of 1905 will begin in it this fall.

HOW THE INTERNATIONAL RACE WAS RUN.

Personal Impressions of an Eyewitness of the Gordon Bennett Cup Contest— Scenes and Incidents on the Taunus Course in Germany.

BY OUR SPECIAL CORRESPONDENT, RENE M. PETARD.

SAALBURG, June 17.—It is now six o'clock in the morning, and soldiers are guarding the entrance to the enclosure and no one is able to get in. All the press representatives are complaining. The employees of the German Automobile Club are being given their final instructions. There are soldiers everywhere and many are complaining that the organization was made more for the convenience of the organizers than for that of the public. The grand stands are filling very slowly.

An hour later Jenatzy is cranking for the start, which takes place 200 yards from the starting line between the stands. As he crosses the starting line at high speed his time is taken. All the drivers are standing around the line awaiting their turn to go. Edge and Jarrott have forgotten the rivalry between the Wolseley and Napier and are conversing in a friendly way. Jenatzy has disappeared. His Mercedes started smoothly without strain on the tires and fourth speed was thrown in within 100 yards of the starting line.

"Hello, old chap; don't get hurt; we can't spare you," calls an English photographer to Jarrott, who replies: "Hope to get through all right; thanks." A comforting greeting.

Edge is now on the line and seems to be calm. His engine does not sound as fast as Jenatzy's; it is very puffy, and the regulator seems too sensitive; apparently the car will have to run all the time on the accelerator. The noise sounds very much like that made by the old Panhards. Edge starts slower than Jenatzy.

Warden, in the Austrian Mercedes, now comes to the line. The start is at the crest of a hill. The grand stands are on the level, but there is a steep descent beyond the ends of the stands, where an accident took place yesterday. Between the start and the stands there is a very slight turn to the right—not enough to interfere, however, with a full view up to the top of the descent. Warden started well on the second speed

and jammed in the fourth at the 100-yard mark without passing through the third speed. He started better than Edge, but had difficulty in adjusting his spark.

An amusing sight is that of the bugler waiting for the starting of each car with the trumpet to his mouth for the full five minutes, his cheeks puffed out and his eyes glued to the wheels of the car so as not to miss the start.

The Italian driver Cagno, who is at the starting line in his F. I. A. T. car, turns the crank about a dozen times before getting a spark out of the magneto. His engine is remarkably smooth running, the smoothest of the first four starters, in fact. He fails to use the accelerator before getting away and as a consequence makes a very slow start—slower than Edge.

Théry is now on the line with his 80-horsepower Richard Brasier. He looks as happy as if he were sitting down to a good dinner—a picture of perfect bliss. M. Michelin watches with affection the car which he expects to bring him lots of advertising for his famous tires. The engine is running at very high speed and very smoothly. Always smiling, Théry tightens the tire bolts for the last time. Now he is off. He does not smile any more. There is a nasty noise in the gears as he changes speed, but the car picks up fastest of all.

The Pipe Belgian car, No. 6, driven by Baron de Crawhez, instead of Hautvast, who took the Baron's car, now comes to the line. The driver and mechanic seem rather nervous, although both are smoking. The engine seems hard to start. There are many handshakes and last words of advice to the driver and mechanic, who appear to be very popular or to have brought all their friends to the race. The start is slow, almost false, but the car gets away at fair speed. The springs seem too elastic, as the car rocks a great deal lengthwise as it disappears.

Defaux, in the 90-horsepower Defaux Swiss car, does not start, for reasons ex-

plained elsewhere. Baron de Caters was the next to come to the line with his 90-horsepower German Mercedes. It is noticed that all of the German cars have clips on the springs holding the two longer leaves together. De Caters' engine is hard to start. It is very noisy and stops. Anxiety is written on all faces, including the driver's. The trouble is with the ignition. This is fixed up, although in a very hasty and crude way. When the engine starts again it runs with a great deal of vibration and stops. Now the word for the start has been given. The bonnet is opened and the engine started again. The driver has become much excited. The mechanic fumbles awkwardly and accidentally stops the engine for the third time. Then De Caters gets out and cranks the motor himself, but it is impossible to start and there are no explosions. The machine is backed out of line and it is explained that the trouble is lack of pressure on the fuel feed tank.

Next comes to the line S. Girling, in the 72-horsepower Wolseley. The engine is running well and the silencer is cut off. There is considerable vibration, notwithstanding the engine is horizontal. Girling makes a very good start. Now the engine of De Caters' Mercedes is heard starting 200 yards below the starting line, then stopping. This is repeated several times and the car comes a little way up the hill and stops again. Decidedly there is fuel feed trouble.

Werner, of the Austrian team, comes to the starting point in his 90-horsepower Mercedes, cracking jokes with his friends. His engine runs smoothly and very regularly and he makes a fair start. De Caters finally gets off and now passes at fine speed, receiving many cheers. His car seems to run all right, but he lost 14:29 as the result of his feed troubles.

The F. I. A. T. Italian challenger, No. 11, now comes to the start with an engine that is not so quiet as that of the other F. I. A. T. and with a very excited Italian

STARTERS IN THE RACE, COUNTRIES AND CARS THEY REPRESENT, AND ORDER OF DEPARTURE.

GERMANY.

- No. 1 Jenatzy, 90 H. P. Mercedes.
- No. 8 De Caters, 90 H. P. Mercedes.
- No. 14 Opel, 80 H. P. Opel-Darracq.

ITALY.

- No. 4 Cagno, 65 H. P. Fiat.
- No. 11 Storerio, 65 H. P. Fiat.
- No. 17 Lancia, 65 H. P. Fiat.

FRANCE.

- No. 5 Théry, 80 H. P. Richard-Brasier.
- No. 12 Salleron, 100 H. P. Mors.
- No. 18 Rougier, 100 H. P. Turcat-Mery.

AUSTRIA.

- No. 3 Warden, 90 H. P. Mercedes.
- No. 10 Werner, 90 H. P. Mercedes.
- No. 16 Braun, 90 H. P. Mercedes.

ENGLAND.

- No. 2 Edge, 80 H. P. Napier.
- No. 9 Girling, 72 H. P. Wolseley.
- No. 15 Jarrott, 96 H. P. Wolseley.

BELGIUM.

- No. 6 De Crawhez, 60 H. P. Pipe.
- No. 13 Augieres, 60 H. P. Pipe.
- No. 19 Hautvast, 60 H. P. Pipe.

driver, Storero. The start is slow, the F. I. A. T. machines seeming to be slow in picking up speed and difficult to get under way.

Salleron, of the French team, appears nervous as he comes to the start in his 100-horsepower Mors, No. 12. Many friends shake his hand before he starts and wish him good fortune. His engine runs well and the explosions are very regular. There is slight vibration. He makes a good start. Now the dust is beginning to rise and there is lots of smoke from the burning oil. Many spectators predict that Salleron will be among the first three to finish.

Happiness is written all over the face of Augieres, of the Belgian team, as he comes up for the start in his 60-horsepower Pipe, No. 13. The Belgian drivers do not seem excited; they say they are not looking so much for the cup as a good reliability showing and do not intend to break their necks. The engine is started from the seat within any reasonable time after the engine has been turned over to draw in its charge of gas and compress it. By this means the drivers expect to save a good deal of time when starting at controls. Augieres makes a very poor start, however, getting away slowly, like a touring car.

Opel, of the German team, appears much disconcerted as he comes to the line in the Opel-Darracq 80-horsepower car, No. 14, and stares steadily at the foot of his steering post, not knowing where else to look. The bonnet doors and accessories have been removed to reduce the car to the weight limit. The machine looks dirty and heavy and not like a winner.

A four-leaf clover cut out of sheet iron is fastened on the bonnet of Jarrott's 96-horsepower Wolseley, which now comes to the line. This is for good luck. Jarrott is in a happy frame of mind and takes things unconcernedly. He has been standing around since the beginning of the race chatting and joking with his friends. The wheels of his car are stiffened laterally by wire spokes from the outer ends of the hubs. His mechanic is built like a jockey and is wearing two pairs of goggles. The engine starts easily, but there is much vibration. Jarrott's engine runs better, however, than Girling's in the other Wolseley. He makes a beautiful start, almost running over the starter.

The Austrian driver, Braun, in his 90-horsepower Mercedes, looks like a monk, dressed all in brown. He goes to the line quite confident and satisfied. He is the most silent of all who have yet started. He did not speak two words. His engine runs beautifully. He shakes hands before his departure. His mechanic looks as unhappy as the driver does pleased. The start is bad. The car picks up speed rapidly, but slows down as the high speeds are thrown in.

Lancia, on the Italian F. I. A. T., No. 17, comes to the start resigned to die, judg-

ing by his expression. Evidently he is prepared for the worst. Several flies and wasps are caught in the radiator, jammed there by the rush of air against the car moving at high speed. The engine runs quietly. Lancia himself takes charge of the horn. He is the only one of the drivers who does so. He makes an exceedingly slow start, but a regular one.

The most self-possessed driver of all is Rougier, of the French team, as he prepares for the start in his 90-horsepower Turcat-Mery. Clearly he is used to the business. While waiting to get away he talks of his previous racing experiences. His engine is noisy, but has a powerful, deep sound—more of a roar than a rattling noise. He makes a fine, smooth start, fairly fast, and picks up speed very quickly.

Hautvast, who took Baron De Crawhez's place in the Belgium car, No. 19, wears the same expression of quiet and "sang froid" as De Crawhez and Augieres in the other Pipe cars. He makes a better start than either of his team mates.

The substitute Wolseley car, No. 20, comes to the line after No. 19, the last of the racers, has departed and the driver wants to run the race unofficially "for fun." He is ignored until a big German officer, at the request of the race officials, does a lot of swearing and almost pushes the car off onto a side road.

The car left at the following times, in order of number: 7, 7:07, 7:14, 7:21, 7:28, 7:35, 7:42, 7:49, 7:56, 8:03, 8:10, 8:17, 8:24, 8:31, 8:38, 8:45, 8:52, 8:59.

Jenatzy has just passed, having made his first turn in 1:26:56, soon followed by Edge in 1:31:44. It is likely that neither had any involuntary stop. We consequently think that England's best is out of it, if mere speed counts. It is well known that Napier cars are very hard on tires, and that English tires are not as good as the French, although it is necessary for the English to follow the rules of the race, and use their own make.

At the start it was noticeable that most of the drivers saluted the Kaiser while passing, although at full speed. Some of them went even so far as putting on the muffler, or what was supposed to be it, when passing before the grand stand. Salleron instead sent a little oil into his engine, which instantly changed into a blue cloud of the most nauseous character.

Théry just passed in beautiful shape, having made his turn in 1:26:57, one second more than Jenatzy. This is most encouraging for the friends of the French team, as when considered the regularity his engine showed in the previous contest and his skill as a driver, he is thought to stand a better chance than Jenatzy, as he has a lighter and more handy car of equal speed. Unless bad luck in tires turns up he will more than likely warm up to the work and his following turns are expected to be faster.

Warden passed next in 1:58:41. He is not remarkable neither in speed nor in fine

driving, and does hardly stand any chance unless luck comes in. This also was the impression made by Cagno, whose time was 1:54:58.

Girling just passed in splendid shape, but rocking most awfully lengthwise and going very jerkily, the horizontal engine for such powers and speed seeming to be inferior to the vertical in general balance. His time was 1:32:55, very favorably comparing with Edge's. Will Jarrott do better on the same make of car? is the query. Next to follow was De Caters on the German Mercedes. His time, 1:43:15, is very satisfactory if the delay which he experienced in starting is taken into account. However, with cars as closely matched as the best of the cars entered seem to be, this is a pretty dangerous handicap.

Great cheering marks the passage of Salleron on his Mors, he saluting some friends at his passage. His machine is running beautifully and with great regularity and steadiness. Time, 1:36:53.

Braun passed shortly after, having been just passed by Salleron. He was most anxious to get again ahead of the latter and flew past the grand stand probably faster than any other competitor. It was simply fearful the way in which he started down the hill. His car positively left the ground at the top in a leap, such was the momentum he had acquired on the level. His time was 1:56:53. Following, completing their first round, and without any special feature, came:

Cagno (Fiat).....	in 1:54:57
De Crawhez (Pipe).....	in 1:28:32
Jarrott (Wolseley).....	in 1:35:18
Storero (Fiat).....	in 1:42:24
Hautvast (Pipe).....	in 1:46:47
Augières (Pipe).....	in 2:23:07
Warden (Aust. Mercedes).....	in 2:07:14
Rougier (Turcat-Mery).....	in 2:06:24

Thus we find the only car having given up the first round is the Opel Darracq, thus proving once more, after the French and English trials, in which cars by the same engineer and of the same pattern were entered, that the 1904 Darracq racing design is unsuitable for the strains of long-distance road racing.

Jenatzy passed first on the second round in 2:55:29. As far as one can judge of the speed at which the racers pass he seemed rather tired, but, however, was keeping a very good pace. It is to be believed by the spectators that his first turn will be his fastest unless his mechanic can encourage him on passing the line for the third time by telling him that Théry, who followed him rather closely, had completed the second round in 2:53:49, beating him by almost two minutes. Théry consequently passed second on the second turn, although having made the best time. Jenatzy's lead over Théry is still more than 26 minutes gross time, so that it may be possible that Théry wins the race without overtaking Jenatzy. The third to pass was Girling, on his Wolseley, in 3:07:21, such

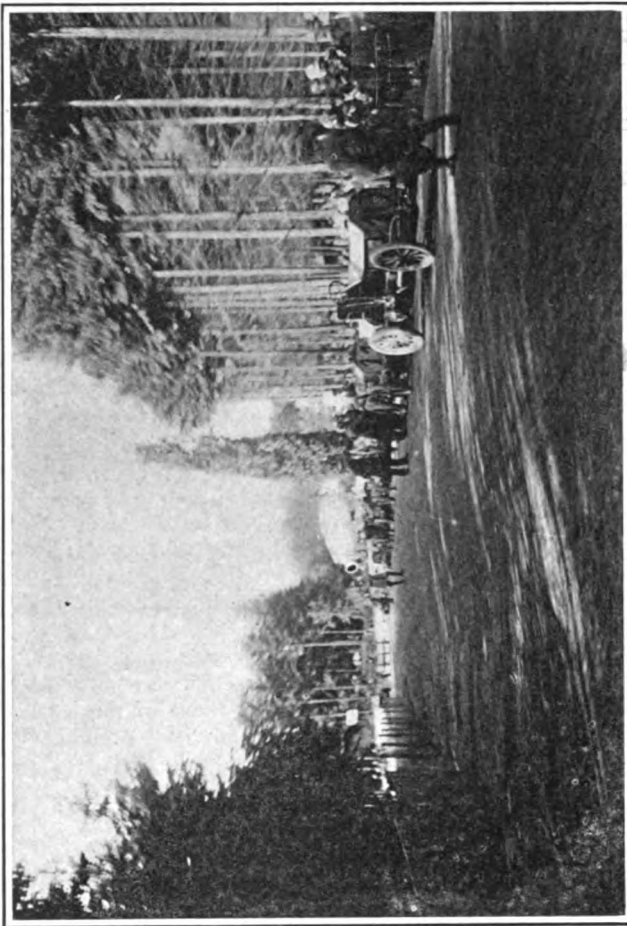

Machines in Line Waiting Their Turn to Start in the Race.



Cars Ready for Weighing In at Homburg the Day Before the Race.

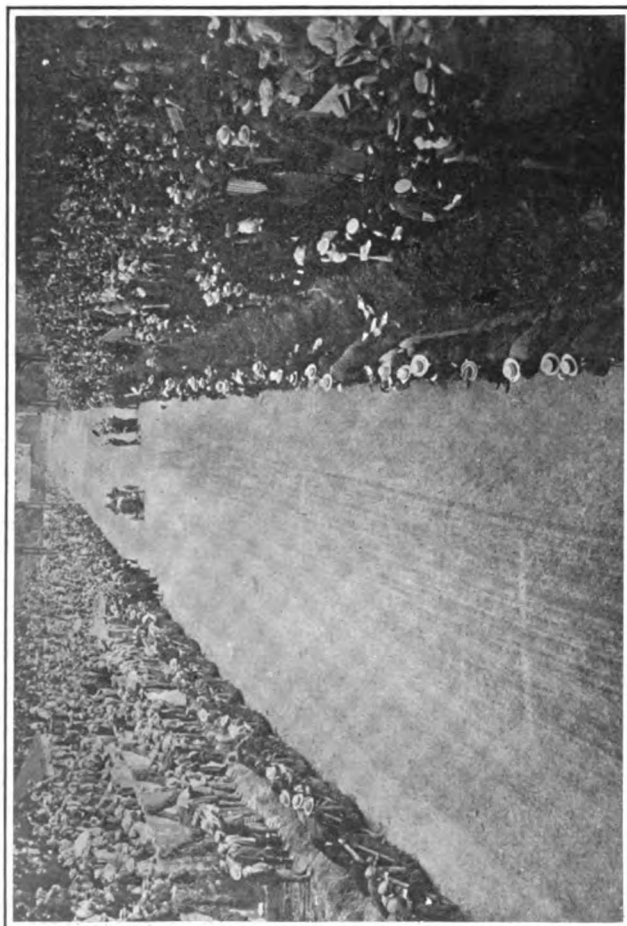

Looking Up the Course at the Moment They Won the Race for France.

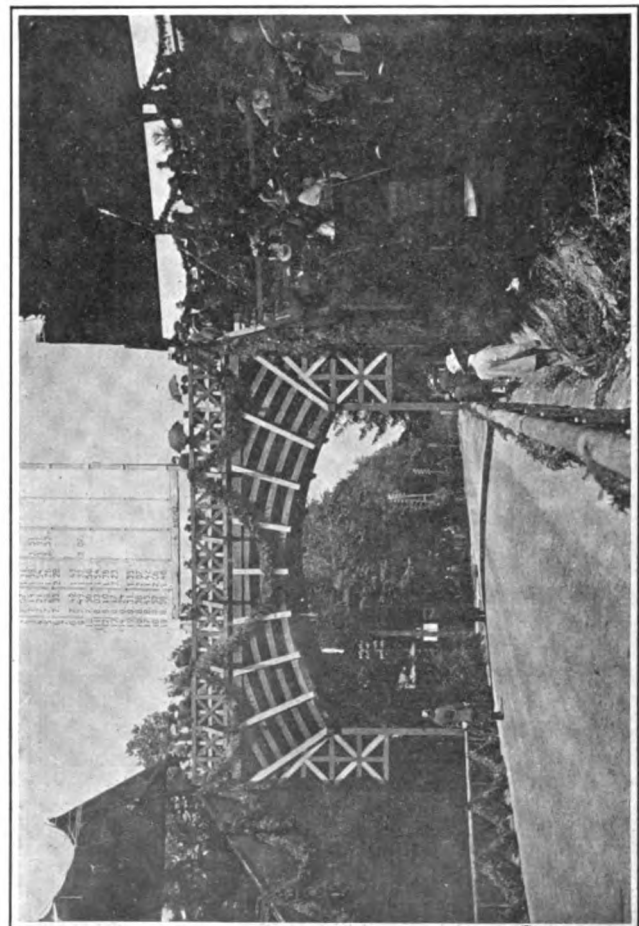

Time-Keeper's Board on Bridge Connecting Grand Stands at the Saalburg.

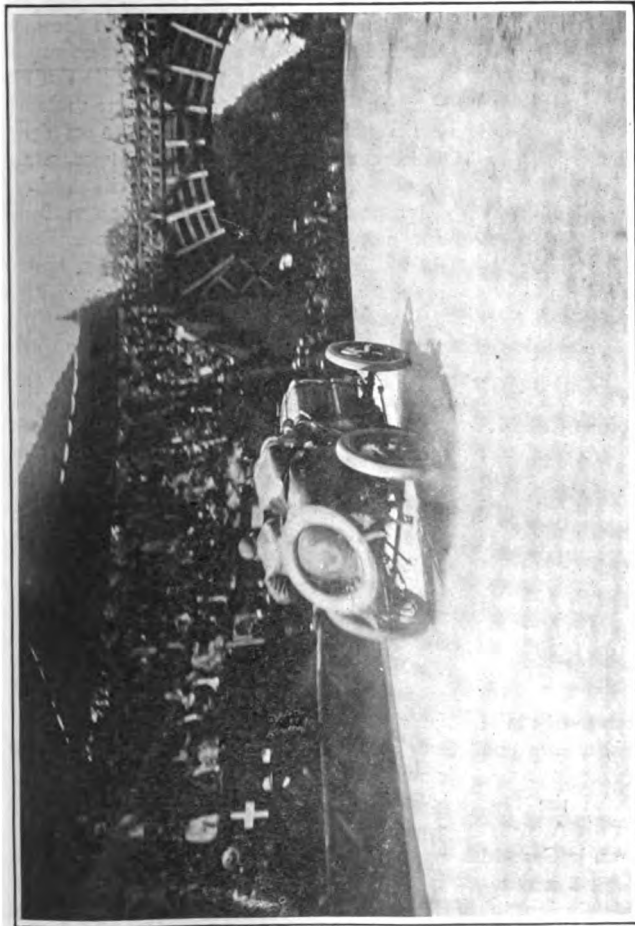

They, the Winner, Passing the Grand Stand on the First Round.

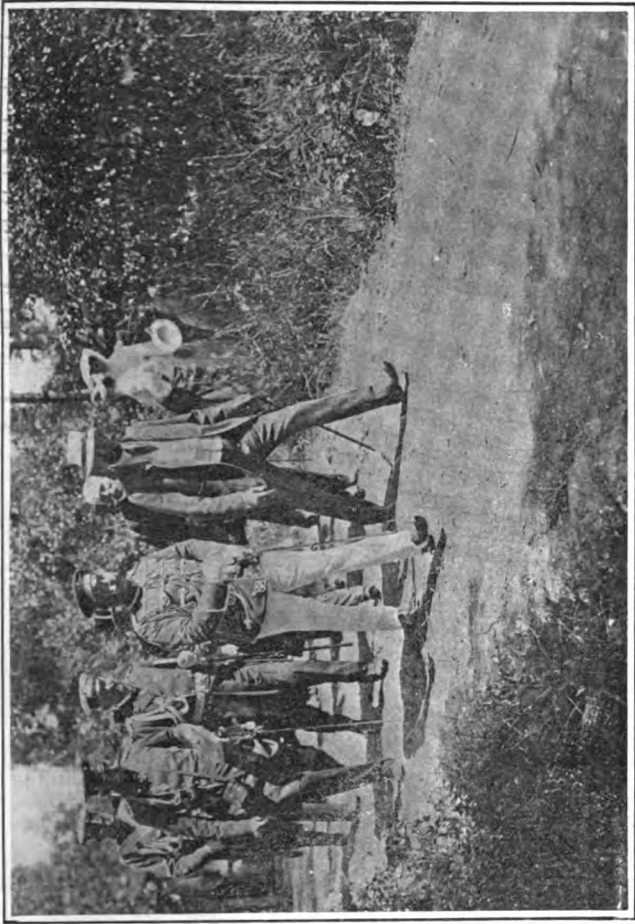

Emperor William and Escort Leaving the Enclosure at the Saalburg for Luncheon.

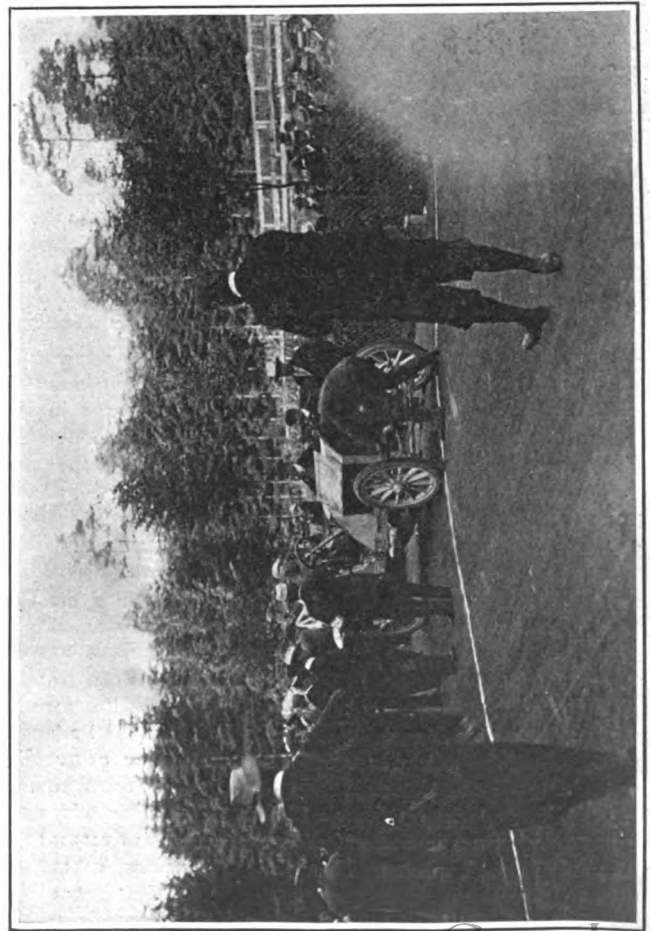

First at the Starting Line—Jenatry's Mechanician Cranking the Mercedes Car. INSTANTANEOUS PHOTOGRAPHS OF STRIKING AND INTERESTING INCIDENTS CONNECTED WITH THE 1904 GORDON BENNETT CUP RACE MEETING ON THE TAUNUS COURSE IN GERMANY.

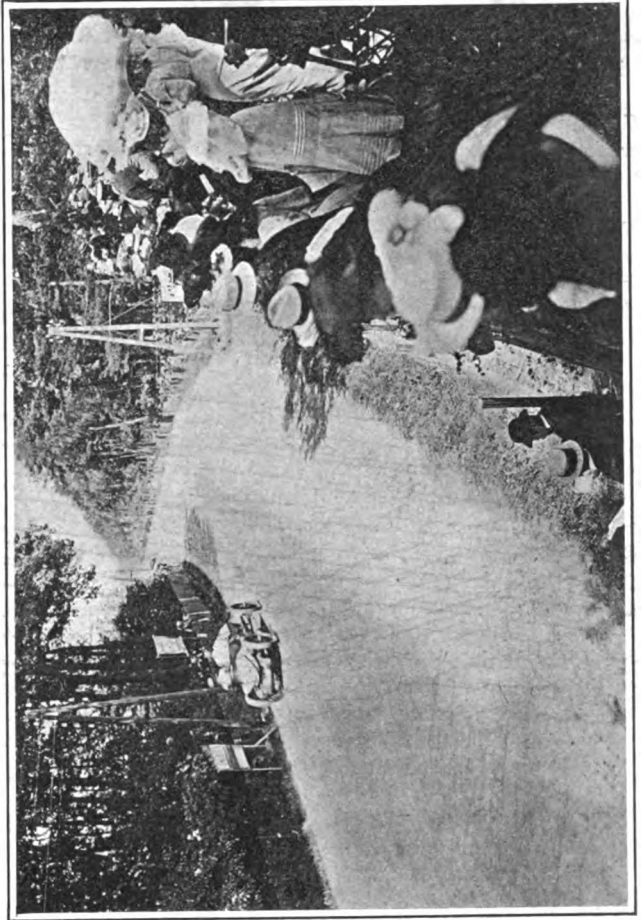

Contestant Taking a Corner at High Speed. Note Temporary Fences Along Roadside.

a speed being quite unexpected from him.

Following in order were: Lancia, on a Fiat, in 3:37:03; Werner, on an Austrian Mercedes, in 3:51:29; De Caters, on a German Mercedes, in 3:32:52. Edge's Napier followed the latter quite closely, less than 50 feet away, the English car having made the two first turns in 4:07:54. This chase creates some excitement, and all are anxious to know by the result of the third round whether or not Edge will have overtaken his rival, whose fame as a driver is at least equal to his own.

Soon these go by: Braun, in Austrian Mercedes, in 3:38:04; Salleron, in Mors, in 3:40:44; Jarrott, in Wolseley, in 3:32:51; Sterero, in Fiat, in 3:26:44; De Crawhez, in Pipe, in 3:51:29.

The third round was finished by Jenatzy in 4:33:15. Hautvast, in the Pipe, and Rougier, in Turcat-Mery, finishing their second round in 3:31:11 and 3:43:24, respectively. In a short distance Théry passed, always fresh. His time was 4:23:40, making the fastest time and being the winner of the three first rounds by 10 minutes. If he keeps up, without bad luck, the cup is French again. Jenatzy, his only real competitor, being visibly tired.

By 3 o'clock the interest in the rest of the race has dropped a great deal, as a wide space of time now separates the cars in two classes. The superior cars have a good chance to win and between them, although there are ten minutes interval, one cannot well tell which will win, so great is the part played by luck in such contests. The other class, now far behind, consists of the lower grade cars and drivers, sometimes handicapped by luck, sometimes by internal construction or lack of daring. No cars are seen for a very long interval.

At last Lancia in a Fiat comes in 5:25:35 for the three first rounds. He is soon followed by De Caters, in the second Mercedes, who made the run in 5:06:25 and starts on his last turn well anxious to finish in fair rank. The mass of the less lucky cars seems to come in now. Edge appears ending his third round in a mad rush and going on his fourth with more speed than ever. A last desperate hope seems to have taken possession of all late cars on the course, as what cars pass go by much faster than in previous rounds. Werner passed closely after Edge, in 5:45:25. Then, a long while after, Girling's machine seems to go painfully, so to speak, while Braun follows less than a hundred yards behind, going beautifully on his Austrian Mercedes, their times being respectively 5:23:15 and 5:16:33.

Then, when all were anxious to know who would at last win this awful speed duel, Jenatzy appeared, all German onlookers shouting *Erste*, in a tremendous voice of triumph. The glorious winner of last year's cup made his run in 6:01:28, slightly better than had been expected. Then Jarrott put in an appearance where all expected to see Théry. The happy English driver

seemed to enjoy thoroughly his last race, since he said that this is his last appearance at the wheel of a racing car.

The dejection of the French side when they found that Théry had changed into Jarrott was, however, not very lasting, as it was soon announced that a new car was coming. This soon turned out to be Théry. His time was 5:50:03, more than 10 minutes better than Jenatzy. He had started at 7:28 a.m. A tremendous cheer then saluted the winner of the day.

I had the luck of escaping the careful eye of a German soldier, and, jumping over the fence, was able to steal into the grounds reserved for the drivers on their arrival. My example was soon followed, and we had the pleasure of greeting first the French winner on his arrival. To say that he was perfectly clean would be exaggerating things. He was very dirty, indeed, and so was Jenatzy, who, in a very sportsmanlike manner, came and shook hands with him, congratulating Théry on his success.

That the defeated man was genuine in his greeting I am certain of. A man's face does not lie in such circumstances, and no one found a smile even when it could be seen that after having left the winner the noble Belgian could hardly keep his tears at the thought that he had lost his glorious trophy.

I had then the honor of shaking the thumbless hand of the great driver, and of telling him in two words what I felt: *Bien couru*, well run.

Théry having received Jenatzy's greeting, was carried more than led by the crowd waiting for him at the end of the racers' quarters to the rear of the Kasier's tribune. Having been first of the newspaper men to greet him, and having helped him out of his car, I was at his left arm at that time. When we reached the rear of the Kasier's box the president of the German Automobile Club came out and beckoned negatively, meaning that the Emperor refused to see the winner. Théry personally did not seem to care anything about it. He was filthy, dirty, greasy, dusty, and all he knew how to say was: *Qu'on me fiche la paix*, which means in French slang, "Let them chase themselves and leave me alone." Jenatzy was then about to leave the quarters so I went to greet him a last time. Three cheers were given in his honor, and, taking on board M. Tampier, son of the famous timer and assistant to his father, he went away behind the Roman ruins in Saalburg, where it was said that the Emperor would greet him. Théry also went shortly after, although he had taken the useful precaution of washing before leaving.

After the leaders the others arrived in the following order: De Crawhez, at the end of his third round, who gave up then; Lancia, on his Fiat, who made the four rounds in 7:17:54; Werner, in his Austrian Mercedes, in 7:32:14; De Caters, in German Mercedes, in 6:46:31—a very good race, indeed, considering his bad luck. Girling fin-

ished in his Wolseley in 7:22:54, and Braun, in Austrian Mercedes, in 6:59:49.

All these times given here for the cars are the times as supplied by M. Tampier, in quick figuring. They are subject to slight alterations, as they take the time spent in the controls as 56 minutes, which is the time settled by the regulations of the German club; but this time may vary for the different competitors, although very slightly.

Before the Race.

HOMBURG, June 16.—Probably there is nothing in the world better calculated to increase one's love for glorious sport and to transform that love into the keenest enthusiasm than to witness the supreme effort made by several great nations, all striving for the leadership in a young but immense industry, to acquire a trophy of no intrinsic value when compared to the amount expended to win it, but the possession of which indicates almost certainly which is the best of the motor car builders of the world.

Although the race is yet to be run, pages and pages might be written on the 1904 Gordon Bennett race and the preparations made for it. However, space forbids.

Arriving late Monday night in Frankfort, the writer had great difficulty in securing lodging at a hotel at which the proprietor was willing to take a guest without a mortgage on his future. An early journey to Homburg the following morning found that place rejoicing and ready to welcome (at shameless prices) the lovers of the sport attracted by the coming event. The rest of the day was spent in talking Anglo-French-German—a language for which no grammar has yet been written—to a lot of dense waiters and others in order to find the representative of the Automobile Club of Germany, who has charge of the press men, and more especially the press cards. When finally located, however, this gentleman proved as agreeable as he was difficult to get at, and very courteously provided the writer a place in the enclosure and a ticket of free circulation everywhere.

The next move was to find suitable quarters in Homburg, if possible, at a price within the reach of ordinary mortals. Having succeeded in this search, I returned to the station and got my faithful old motor cycle. You should have seen the expression on the face of the boniface when he saw me push the machine into his courtyard. Disappointment, regret and ill-concealed anger were written in it. Then I understood my Paris friend's advice that no man who owned anything on wheels, from a perambulator to an automobile, should show his machine before arranging the price of accommodation, unless he were a millionaire.

Early Thursday morning the writer made a run over the race course on the motor cycle. It was found that the course is at the same time a most beautiful and probably the most hilly and sinuous course

that could be found. The scenery is wildly magnificent, with majestic hills rising on both sides and dense woods bordering close upon the road in many places. But there is hardly a level or straight stretch in the entire course and very few places where the most powerful cars will be able to show their full speed capabilities. This explains why the average speed expected to be made in the race is so low.

Although the hills will considerably decrease the average speed, they offer no real dangers in themselves. The danger to the contestants lies in the many sharp turns, most of them being of such a nature that the driver cannot see the road beyond the turn until he is fully upon the curve.

An accident occurred to-day within a mile of the starting point, on a steep descent at one of the sharp turns. A touring car, leaving Saalburg, was descending the hill at a lively rate and did not slow up to take a curve half way down the hill, and the car capsized. The chauffeur had to be taken to the hospital for treatment for concussion of the brain.

A curve which the Germans appeared to fancy very much is the double or S-shaped curve—the greatest possible nuisance to the motorists. Again, in addition to the ordinary turns, which are bad enough, a number of curves have been placed in the most awkward and unexpected locations, such as in the middle of a bridge, midway through a densely inhabited village, where children and domestic animals play all over the street.

Passing now to the cars which were entered for the race, it is to be related that M. Dufaux, builder and driver of the only Swiss competitor, a car which appeared to have a very good chance indeed, broke his steering gear almost beyond repair this morning, thus putting him out of the race. M. Dufaux unhesitatingly charges that the breakage was the result of pernicious ill-will and jealousy of some competitor, whose identity he does not appear to know.

Another incident that proved more exciting and might have resulted seriously occurred at the weighing in of the cars. Mr. Edge, of the English team, was emptying the gasoline tank of his car very carelessly into the street before running his machine on the scales, when sparks from his own cigarette, some persons state, dropped into the pool of fuel and started a fire. This soon communicated to an adjacent house, which was, fortunately, the fire company's station. The flames were soon extinguished and the racing machine escaped injury, which was doubtless a more important consideration than the safety of the building.

Edge was perfectly happy, but not so were the drivers of the Pipe cars. The engines in one of these refused absolutely to start. It was found necessary to change the cams and the work had not been completed at 9 p. m. and will have to be resumed to-morrow, the race morning. A

not very pleasing feature of these cars, which appear to be merely touring cars fitted with more powerful motors and cut down to the limit in weight, is that the contact breaker is of such delicate construction that it does not look as if it would stand more than 200 kilometers of running. Complete sets of spare parts for this part of the car, as well as for the circulating pump, are to be carried on each car. It is difficult to see the advantage of saving a pound of weight on a pump and being obliged to carry twenty pounds of spares.

NEWARK AUTO PARADE.

More Than 150 Machines Take Part in Twenty-two-Mile Run.

Special Correspondence.

NEWARK, June 27.—The first automobile parade under the auspices and management of the New Jersey Automobile and Motor Club was held here last Saturday afternoon. More than 150 machines were in line, and crowds of spectators were gathered all along the route to see the passing

panied by Mayor Bruen, of East Orange, and Chief of Police Hopper, of Newark. After them came the other officers of the club and their invited guests.

Cars of every kind were in line, from motor cycles to touring cars. There were gasoline, steam and electric vehicles. Some were trimmed with American flags or bunting and others were decorated with flowers.

BRIDGEPORT RACE MEET.

A race meet was held at Nutmeg Park, Bridgeport, Conn., on July 25, under excellent weather conditions, and although the half-mile track was not in the best condition and the times were slow, the 800 spectators enjoyed the sport.

Special five-mile race.—A. L. Riker (gasoline Locomobile), first; H. A. Budlong (Buffum), second. Time, 9:15.

Two-mile race, steam cars.—Dr. E. Perry (Locomobile), first; D. C. Carson (Locomobile), second; W. H. Baldwin (Stanley), third. Time, 2:11 1-2.

Three-mile race, two-cylinder gasoline runabouts.—Mr. Kellogg (9-horsepower Locomobile), first; T. H. McDonald (20-

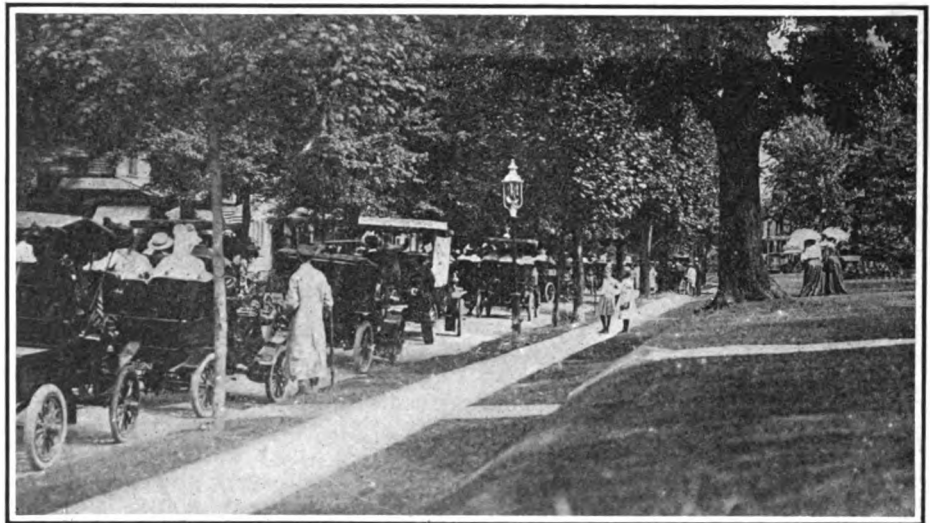

CARS OF NEW JERSEY CLUB MEMBERS LINED UP FOR NEWARK PARADE.

procession. The cars began assembling at 1 o'clock at Lincoln Park and continued to arrive until the signal to start was given at 2 p. m.

Dr. Clement Morris acted as grand marshal and made an attempt to line the vehicles up in divisions, but it was impossible to get them completely classified. The parade started north on Broad street, headed by a squad of bicycle police, who were followed by the division of motor cyclists. The spectators were kept in order by mounted policemen.

The parade covered a distance of twenty-two miles, moving at a lively pace through the business and best residence sections of the city and westward through Orange, where the only stop was made, to allow the gaps to be closed. The line of automobiles was headed by Chief Marshal Frederick R. Pratt, president of the club, accom-

panied by Mayor Bruen, of East Orange, and Chief of Police Hopper, of Newark.

One-mile speed judging contest.—Won by A. L. Riker (gasoline Locomobile), who finished within one second of the six minutes allowed for the distance.

Five-mile free-for-all.—A. L. Riker, first; J. Murray Paige, second; Archibald McNeil, Jr., third. All cars gasoline Locomobiles. Time, 9:32 3-5.

Five-mile motor-cycle race.—Won by Oscar Hedstrom. Time, 8:43 2-5.

On Thursday, June 30, the Smith & Mabley automobile boats *Vingt-et-Un* and *Challenger*, which have been entered in the races for the Harmsworth Cup in England, were tried by a committee of the Automobile Club of America, consisting of Messrs. Bostwick, Brokaw, Butler and Carpenter. The racers are to be shipped across the Atlantic to-day (Saturday).

Correspondence

Jack Frost and a Cylinder Jacket.

Editor THE AUTOMOBILE:

Sir:—It is a good deal easier to break a light castiron water jacket than it is to repair the same, and perhaps an experience of each sort, both equally successful, will interest your readers.

Given a 6-horsepower DeDion cylinder with jacket cast integral; water in the jacket; a thermometer at or around zero; and a fool garage employe who "didn't know 'twas loaded" and forgot both water and fire. The result was easy and quite mathematical. The cylinder jacket was burst in a most artistic and complicated manner. A piece some 4 inches long and 3 inches wide, of somewhat oval shape, was lifted cleanly out on the side and curved top of the jacket, and several radiating cracks from angles of the clean break, each an inch or more long, were added by way of trimmings.

The jacket was thin, 1-8-inch perhaps, and the vibration of the cylinder in motion considerable. But a new cylinder was expensive; sixty dollars was the modest price asked by the makers, and the owner and his expert mechanical friend decided to repair.

The broken piece was carefully treated on its edge with strong sal-ammoniac solution and dusted with fine iron filings very sparingly. It was then driven flush into place with a wooden mallet, clamped in and allowed to stand a week; then several screws were tapped into the cracks at the angles of the break, the jacket filled and the engine started. For a time the job seemed complete, but later the vibration combined with the expansion and contraction of the metal opened the seam in spots, breaking the "rust joint," and the jacket leaked in a slow, exasperating and tearful manner.

A council of war was held by the owner and his expert friend and a second operation decided upon. The cylinder was removed and a line of small holes drilled in the crack around the broken piece, and out along the lines of the radiating cracks. Each hole was about 1-8 inch in diameter and the holes were placed as close together as was possible without cutting into each other. Each hole was then tapped with a fine forty-thread tap and short lengths of soft iron wire were threaded and screwed into each hole, cut off, set with a gentle tap of a hammer and filed off smooth. Each hole was tapped, threaded and filled before the next was cut, as the jacket seemed too fragile to proceed otherwise. In all, one hundred and ten wire screws were put in, and when dressed down the job looked smooth and solid. The cylinder was then inverted and the repaired portion placed in the strong solution of a copper-plating bath and given a heavy coat of electrically deposited copper. A soldering iron and blow pipe were then called into play and a thin film of solder run along the line of the 110 visitors.

The copper plating greatly assisted the solder in holding to and covering every suspicion of a crack or crevice which mechanical means had failed to fill. When complete the jacket was dressed down with first a coarse, and then a fine file and all surface solder removed. A coat of aluminum paint finished the job and the break and the repairs disappeared permanently from view.

The motor has been in constant use since the last operation and has driven the car to which it is attached several thousand miles. The break is absolutely closed, has never leaked a drop and cannot be discovered except by scraping off the aluminum paint and hunting most industriously.

E. N. BOWEN.

Agricultural Motor Needed.

Editor THE AUTOMOBILE:

Sir:—The enclosed letter has been forwarded to us by the Cadillac factory, and you may think it worth publishing.

FOSTER AUTOMOBILE CO.

Richmond, Va.

RICHMOND, VA.

The Cadillac Automobile Co.,

Detroit, Mich.

Gentlemen:—

I want some information on motors. Am owner of a large plantation in ——— county and have farmed enough to know what we need to make it a successful and respectable business. We need power, a cheap, substantial motor that we can hitch to a plow, harrow, wagon, or anything we now have to use horses and mules for. Horses are easily worked out and cost considerable at the start, and to feed. Now a gasoline motor, of say 4-horsepower, would do—one that could be sold at say \$75 per horsepower—or a smaller motor would do for a start. Price will go according to the amount of rigging. We don't need anything but the motor gear with motor, and no fine finish, either; we will just hitch on to plows, wagons, etc., as we have them.

Farmers are the poorest paid of any class I know of, not because the stuff we grow does not sell high enough, but because we can't grow enough of it. We can't do that for the reason we can't properly work the land. Labor costs too much, and we can't do enough of it. A plow team of 2 horses, which is only half the power we need, costs with horses, rig, etc., at least \$300. To feed them so as to keep them up costs at least 75 cents a day, and the man that holds the plow 75 cents a day more; they can only plow two acres a day, and only half as deep as it should be; so to plow deep enough four horses are required. We ought with a motor of 4 horsepower to do twice as much per day and plow it good and deep. Gasoline costs considerably less than corn and oats. This will solve the farmers' problem, and furthermore farming will become a respectable and profitable business. Capital will seek it and the farmer will be somebody. Can't you do something for us?

All the machine men seem to run to a new kind of plow; it is not the kind of plow, it is the force or power we need. We could do just as good work with the old-time grandfather's plow and harrow if we had the power to move it quicker and deep in the ground, turning up the stuff that the crops feed on and which is now exhausted on top; then with deep loose soil to hold large supplies of water for crops no dry weather could affect them.

I have been a farmer but five years now, having been a railroad man all my life. I lost my hearing so that I could not hold a profitable position, and, having saved my earnings instead of blowing them in, I invested them in one of these old-time plantations. I soon saw that the less plowing done as it is done, the better, so I put by the plow and went to raising cattle, as these improve the land and make a man some money with less labor. I now have land good for from 75 to 100 bushels of corn if worked properly, and that I can't do with horsepower so costly. H. H.

There is unquestionably a good market for a cheap and efficient agricultural tractor, with a motor—it need not be light, but it would better develop at least 6-horsepower—and a simple two-speed gear, mounted on a running gear capable of hauling plows or two or three market wagons. Such a tractor would do its heavy work on the low gear, and return light on the high gear, making respectively say 3 and 8 miles per hour. One such tractor, like one threshing machine, would do the hauling for one big or several small farms, and would be a most profitable investment for its owner. The Ivel tractor, made in England and described in THE AUTOMOBILE of November 21, 1903, would be about the right kind of machine.

Early Spring Navigation in Maryland.

Editor THE AUTOMOBILE:

Sir:—Leaving Washington on Sunday morning one bright sunny spring day, we followed the fine macadam road through Brightwood (5 miles), on past the well known town of Sligo, well known from the song, and through the historic spot at Leesboro (11 miles), and on to Olney (10 miles). We chose this long route to Baltimore in order to have all but six miles on the Pike. Part of those six miles is nearly done, but not quite, as you will see later. At Sandy Springs (23 miles) the Pike or stone road suddenly stopped and the outlook was anything but inviting, suggesting aquatic rather than land travel. However, it was nearly noon and only six miles to shore, so in we plunged. The first part of the road that was really soft happened to be on a slight downgrade, and the sliding was in the right direction. How the spray dashed over the bow when we went through the water over the heavy ground swell! It reminded me of the pictures of *Mercedes I.* or *Vingt-et-Un* at full speed. As we approached the northern shore we passed by what might have been and did resemble an

ocean breakwater, although it simply made a good sidewalk, as you will see in the picture, and prevented the natural drainage of the water into the ditch, making it a fine deep channel for the unsuspecting navi-



NAVIGATING MARYLAND ROADS.

gator. With the hard fine "pike" in the distance, and the twin screws churning up the terra cotta in our wake, on we went through the bottom, where we were told for miles in advance by farmers and men driving in buggies that we could not get through but had better go back. They did not know we could not turn around. At length, as Fate would have it, we fetched up solid on the bottom of the engine case front, and on the axle case in the rear, and the wheels were supported by many props to keep the car from falling over. The wagons coming in the opposite direction rolled off the stone road and just sank down into this hole, making it deeper and deeper, and by working the wheels from side to side they had made quite a respectable hole.

With the assistance of some colored men, who I learned were surveying the situation with the idea of going through the next day on a traction engine, I built something of a foundation under each wheel, while the fence rails were used as levers to raise them up, thereby destroying a considerable portion of the breakwater, which in this manner served a more useful purpose. With this ten-foot stretch negotiated in this manner, the rest was plain sailing, and we had a very pleasant ride into Ellicott City, where we joined the old Cumberland road, more familiarly known as the National Pike, built over a hundred years ago, with fine stone arch "S" bridges and fine smooth surface all the way to Baltimore, ten miles or more. Here we filled our gasoline and water tanks, and after looking at the ruins of the great fire, we took on a pilot in the person of Dr. Chandlee and went out over the old Pimlico Road to an inn, where we had a pleasant supper. After supper we continued our journey on this famous road, where the horsemen have their trotting matches and their speedway, past Pikeville (9 miles) over the Reisterstown Turnpike (18 miles), where you are charged over five cents a mile to drive your own car over part of the way, more than trolley

fare, to Westminster (30 miles). Here is a splendid new hotel with very excellent accommodations and very hospitable. We slept well and were up early to enjoy the fine ride through Hanover (23 miles) to York (43 miles), over the oldest turnpike road in the United States, the "Old York Road," constructed in 1711, nearly two hundred years ago.

From York we followed the old Pittsburg Pike, crossing the Susquehanna River over a railroad bridge nearly a mile long, on to Columbia (56 miles), to Lancaster (67 miles), and from here for a distance of something over 60 miles to Philadelphia, over the first macadamized road which was so reconstructed in 1792 and known at that time as the best road on this side of the ocean. They were building a trolley just beyond Coatesville, however, and I failed then to recognize it. The road runs through the towns of White Horse, Coatesville, a good place for lunch; Downingtown, Malvern, Wayne, Bryn Mawr, Ardmore, and in through Lancaster avenue and Market street. Here we again refitted and had supper. We then crossed the ferry to Camden and over on to Burlington to spend the night. The next day we enjoyed a pleasant ride home over the good roads in New Jersey. One farmer remarked, "When you see one of those gol darned things on these kind of roads, it makes you think there's something in 'em."

New York.

AUGUSTUS POST.

Electric Automobile Operation.

Editor THE AUTOMOBILE:

Sir:—I have read with much interest the very illuminating article on the subject of the abandonment of electric ambulances by Roosevelt Hospital.

It is a great pity, but none the less a fact, that "The world marks the hits but not the misses."

Your representative's interview with Mr. Lathrop indicates that, as usual in such cases, the electric automobile was not at fault, but was the victim of unsuitable organization and unfamiliar attention.

Experience elsewhere amply justifies the statement that a good grade of horse drivers are perfectly competent to drive electric vehicles, and had the manager of the hospital made an arrangement with some competent man manually familiar with storage batteries, to visit the hospital every day or so and look over the batteries, and had used over-voltage circuit-breakers in charging them and kept away from the battery, any electrician, however able, who was not manually familiar with the care of storage batteries, I think Mr. Lathrop would have found the electric ambulance a most gratifying solution of the undoubtedly trying conditions which he is called upon to meet.

All this is, of course, assuming that the ambulances as used by him were properly proportioned and adequately battered, which I assume they were.

When operated with a proper knowledge of their requirements, the electric automom-

bile has given such a wonderful account of itself commercially within the last three or four years that it is entirely past the explanatory stage, but, nevertheless, those interested in improved methods of transportation cannot fail to appreciate Mr. Lathrop's very frank avowal of the extraneous causes of the undue expense of his attempt.

In a considerable and very intimate observation I have noted that in the relatively rare cases in which business transportation by electric vehicles has been reported a failure it has been due to one of two causes:

First: Self-confident but inexperienced care; and

Second: Insufficient proportion of battery for the original design of the vehicle.

HAYDEN EAMES.

Cleveland, O.

To Whom is License Issued?

Editor THE AUTOMOBILE:

Sir:—When an owner gets a license for his car is he the only one having a right to run it? Is it the car or the operator that is licensed, or both? Should a man teach his wife, for instance, to run his car, would she be allowed to operate it, according to law, without also having a license?

G. E. P.

New York.

In most instances the license is issued to the owner of the vehicle under the supposition that he will both use and drive the car. If he employs a hired man in New York State this man would have to procure a chauffeur's license and wear a badge while on duty.

No doubt many owners permit their relatives and friends to drive, and it is not likely, if the car is properly tagged and is going along the street at a legal rate of speed, that any policeman or peace officer will halt it and demand by what authority a person drives it.

In case of accident or arrest for any speed infraction, it would, of course, place the owner at a disadvantage if the car was being driven by any one without proper legal authority.

THE Bavarian ministry of transportation, according to the U. S. Daily Consular Reports, has issued tenders to a large number of firms for the supply of railroad motor cars. These are to be built in different sizes, according to the service required, whether main line or branch work. The larger cars will be fitted to accommodate the entire freight, passenger and mail traffic of small branches. The speeds required of the various cars range from about 31 miles an hour to 46 miles an hour.

It is generally known among automobilists that most of the accidents which the dailies refer to as automobile explosions are simply fires caused by the ignition of gasoline oozing through leaks in tanks. As long as the gasoline tanks and pipes are in perfect order no gasoline can be ignited.

THE AUTOMOBILE

VOL. XI.

No. 1

Published every Saturday by

THE CLASS JOURNAL CO.,

Flatiron Building, Madison Square,
NEW YORK CITY.Cable Address - - - Autoland, New York
Long Distance Telephone - 300 Gramercy, New York

SUBSCRIPTION RATES:

United States, Canada and Mexico, - One Year, \$2.00
Other Countries in Postal Union, - One Year, \$3.00To Subscribers—Do not send money by ordinary mail.
Remit by Draft, Post-Office or Express Money Order,
or Register your letter.

FOREIGN SUBSCRIPTION AGENTS:

ENGLAND:—Iliffe & Sons, Limited, 3 St. Bride Street,
Ludgate Circus, London, E. C.FRANCE:—Boyveau & Chevillet, 22 Rue de la Banque,
Paris.

GERMANY:—A. Seydel, Mohrenstrasse 9, Berlin.

To Advertisers—Copy or changes in orders for ad-
vertisements should reach us not later than 5 o'clock p. m.
Monday for the issue of Saturday following.Copyright, 1904, by The Class Journal Company.
Entered at New York, N. Y., as second-class matter.The Automobile is a consolidation of The Automobile
(monthly) and the Motor Review (weekly).

Copies Printed This Issue, - - 12,500

Horse Drawn vs. Power Driven. The July number of *Country Life in America* has a short article on the comparative expense and what it calls "efficiency" of the horse and the automobile. In this article the cost of keeping a \$2,500 car is compared with that of a pair of horses, and the cost of keeping a \$1,000 car with that of one horse. In the former comparison, the automobile's mileage is assumed as 4,000 per year, and the depreciation as 50 per cent. in two years; and the chauffeur's wages are reckoned at \$1,300 per year. The total annual expense for the automobile foots up, for depreciation, tires, gasoline, minor supplies, repairs and chauffeur, to \$2,405. Against this is a bill, for depreciation, feed, shoeing and clipping, and veterinary charges on two horses, depreciation on two carriages and harness, and coachman's wages, of \$1,257; a balance in favor of the horses of \$1,148. In the second comparison the chauffeur and coachman are omitted, and the mileage is put at 2,500 annually; depreciation the same as before. The respective accounts stand: for the automobile, \$525; for the horse, \$448.

To offset the difference in expense, the automobile is said to have a "radius" of forty miles for the higher-priced car, against fifteen for the horses, and of thirty miles for the other car, against ten for the horse; and the "efficiencies" are computed as proportional to the areas of circles of those radii; or, roughly, as seven to one for the

larger and nine to one for the smaller outfits.

A study of the estimated expenses in detail for the automobiles has convinced us that they are liberal, at least, though not perhaps actually extravagant for men who bring no personal attention or skill to their machines. Tire expense, for example, is taken as five cents per mile for the large and four cents per mile for the small machine; and the latter figure is certainly higher than necessary with any degree of care bestowed on those members. The repair allowances, of \$100 and \$75, respectively, are probably fair averages, though an intelligent owner with a good car can come away inside of them for the first few thousand miles of the car's life, which are all that this article considers. At twenty cents per gallon, the gasoline bill for the light car is taken as \$50 for 2,500 miles, or ten miles per gallon—a generous figure, certainly, suggesting a bad carbureter or a burner "on the bum." Half that would be ample for a gasoline runabout carrying, as the article assumes, but two people.

But a more vital criticism to be made of all such comparisons is that they assume that the horse and automobile are comparable things. The "efficiency" plan of comparison above noted is foolish, of course, for vehicle service is measured by mileage, not by the square of the mileage; but nevertheless the functions of horse and automobile are so wholly different that no one thinks of comparing them, except the business or professional man and the man of small purse, who thinks of substituting the one for the other. The physician who purchases an automobile soon finds his practice so increased by his greater ability to respond to calls that the difference in cost for equal service becomes a bagatelle. The man of means finds in the automobile an exhilarating means of out-of-door recreation such as no horses can replace. The economical man will be likely to find the automobile more costly than the horse, by the year, but much less so by the mile; and if he uses it more it is because the pleasure of it is worth more to him than the money.

A point sometimes overlooked in this connection is the much greater liability of horses to serious or prolonged disablement. An automobile, when it wears out or goes wrong, can be repaired in a reasonably short time and made for most purposes as good as before. It is a machine, and responds perfectly to the intelligence that directs it. The horse has a long list of possible ailments, any one of which may send him out to grass for weeks or months; and he may be ruined in a day by bad driving.

Again, it may be pointed out that, whereas the cost of keeping a horse is quite as much when the animal is not being used as when he is in service, that of the automobile is reduced to little more than interest on the investment. Another advantage of the machine, equally real, but quite impossible to express in figures, is the fact

that it does not tire and can be driven, with only the usual wear and tear, steadily all day, and day after day. This makes it possible for its owner to cover in a vacation tour five to ten times the ground that he could cover with a horse.



Irresponsibility in Racing.

The rather absurd termination of the first of the much discussed *Vingt-et-Un—Fiat* races only serves to emphasize the striking lack of seriousness which seems to characterize many public contests in this country in which auto boats and automobiles, owned in the trade and out, engage.

The national endurance runs and most of the large shows have been managed most creditably, but one would have to think rather hard to name a track race which has not been more or less marred by delays, erratic changes in the program, and lack of organization at one or more vital points, whose going wrong resulted in confusion elsewhere as well. Men experienced and capable in other lines have shown themselves almost painfully at sea when confronted with the problem of effectively managing a race meet.

The same incorrigible amateurishness has had some conspicuous examples in the recent races between autoboats, where lack of management has been less excusable owing to the fact that most of these events have been conducted by presumably experienced clubs. The failure to provide men at the stake-boats, for instance, is hard to excuse on any grounds. Almost as bad is ignorance of the course, such as is frequently displayed by competitors; and the failure of half or three-quarters of the entered boats to start is a phenomenon so common that it may soon call for drastic treatment.



Railroad Crossing Accidents.

An amazingly large proportion of the serious automobile accidents that have been chronicled during the last two months have occurred at railroad crossings and on street car tracks. This is true of different sections of the United States and European countries as well. Recent cases that are very fresh in the mind are the collision of a Chicago, Elgin & Aurora electric interurban car, running at about sixty miles an hour, with the Dixon automobile party from LaGrange, at Austin, Ill., resulting in the death of both Mr. and Mrs. George E. Dixon; the disaster to the Noakes party at the Van Cortland Park crossing of the New York Central Railroad, resulting in serious injuries to several of the occupants of the automobile; the collision of the Jaeger touring car with the sidewalk on 86th street, in Central Park, which caused the death of Miss Maas, at the end of last March; the running down of a party of five

in an automobile at Milford, Mass., by a New York, New Haven & Hartford train last Saturday, which resulted fatally to the owner of the car, I. S. Wood, and serious injuries to his wife, son and a friend.

These are not a tenth of the accidents of similar nature reported since the present riding season opened. The immediate causes leading up to these deplorable accidents vary with the cases and the testimony of the witnesses, but whatever the circumstances surrounding each accident, there can be no question that the primary cause in most cases is inexcusable negligence to observe proper precautions at crossings. Any driver to whom several persons, particularly relatives and friends, have entrusted the safety of their lives, ought to have sufficient sense of responsibility to take no chances whatever of an accident. Any man with ordinary sense knows that the danger at railroad and street car crossings is increased for passengers in an automobile by the noise and speed of the vehicle itself, and this should cause him to take more than the usual precaution in approaching and crossing the tracks.

Operators of motor cars are disposed to rail at pedestrians who fatuously start to cross the street without first looking in both directions to assure themselves that there is no danger of being run down by a vehicle, yet many of them neglect to observe the same precaution themselves when crossing car tracks, as is proved beyond controversy by the frequent accidents. There is only one safe rule to follow, and that is to stop the car and have some one get out and walk ahead to see that the crossing, at the time, is safe.



Isn't it about time that the people who organize track races did something to abate the dust nuisance in those events? It is not only annoying, but a serious peril to those engaged, as well as to the spectators, for a thick dust cloud to hang over the turns of a track, preventing, as it often does, any clear view of these turns, till one is actually upon them. If oil, tar, westrumite, or any other dust preventer, even if it be but temporary in character, can be used on the tracks without injuring them for horse racing, nothing should be allowed to interfere with its general application.

Resolutions were adopted by the Board of Governors of the Automobile Club of America, at a meeting held June 28, calling the attention of Mayor McClellan, Borough Presidents Ahearn, of the borough of Manhattan; Haffen, of the Bronx; Cassidy, of Queens, and Cromwell, of Richmond, to the numerous grade crossings in their respective boroughs, and requesting that they use their influence to secure adequate protection. A resolution was also adopted thanking President Haffen for his work in having paving and other road work done. The condition of certain parts of Jerome avenue was pointed out, and the request made that repairs be made so that a continuous good road will be available from New York City to Westchester County, by way of Jerome avenue.

New Turn in Hoodlumism.

The publicity given to the practice of throwing stones and other missiles at automobilists by the hoodlums of New York by the recent Gottshall case seems to have stimulated this form of amusement throughout Greater New York and the towns across the Hudson. There has been much discussion of the cause of the practice and of possible remedies, and not a few persons have sought relief for their feelings on the subject in the correspondence columns of the daily press. Prominent among these open letters are many from apparently well-meaning authors whose explanations and criticisms are plainly biased by their own prejudices. By these the stone-throwing practice prevalent in certain sections of the East and West Sides is attributed to a desire on the part of the throwers to defend, or to avenge the real or fancied wrongs of the children playing in the streets. While this seems plausible, in theory it is not proved in practice. The fact of the matter is that the young rowdies are ever on the alert to amuse themselves at the expense of victims who can be attacked while defenseless and unable to retaliate.

This was forcibly exemplified by an attack of Policeman John Nevill on June 24. Nevill took his wife and children out for a drive on that day, and, while passing near the place where Mrs. Gottshall was stoned a little more than a month ago, a gang of boys began throwing stones at the carriage. Nevill jumped out and seized the biggest tough in the gang, intending to take him to the station. In less time than it takes to tell a mob had surrounded the party and began stoning in earnest. In spite of Nevill's efforts to defend his family, all were struck a number of times, and it was only with the greatest difficulty that the policeman managed to get his prisoner into the vehicle and start to drive off. No sooner had he started, however, than a man in a cart drove alongside the carriage and attacked Nevill with his whip. Nevill defended himself with the same weapon, but while the strange duel was going on a tough from the mob got into the wagon with a heavy piece of wood and, slashing at the overmatched policeman, nearly broke his wrist. Thus beset, Nevill was compelled to release his prisoner and make his escape, followed by the mob with stones and curses. He made his report at the station and went to a hospital for treatment.

In a far more attractive and orderly district of New York the same idea—that of doing malicious mischief from a safe distance—is being manifested. The drivers of fast horses who throng the Harlem Speedway on Sundays are frequently made the targets for stones thrown by boys on High Bridge, and the oarsmen and other frequenters of the Harlem River are also used as marks. Several painful injuries have been inflicted, and nothing but the height and the difficulty of hitting a rapidly moving object prevents the infliction of a larger number of injuries. The young cowards know well that they are safe so long as there is no policeman in sight on the bridge.

A clergyman, writing to a daily paper notorious for its anti-automobile sentiment, after dilating upon the recklessness of cabbies, motormen and automobilists, asks: "What more natural, then, than that the hoodlum of the street should blindly strike at the hoodlum of the automobile?" This naive query raises visions of the good minister of the gospel taking his family for a quiet drive in his surrey through "Little Italy" on a Sabbath afternoon and meeting gangs of lawless youths lying in wait with

stones, bricks, dead animals, decayed vegetables and dilapidated washboilers to avenge themselves for his invasion of their playground. The situation certainly has its humorous side, as displayed in the daily papers; but somehow the funny side does not seem to appeal to the victims of these assaults.

NEW YORK-BOSTON NON-STOP RUN.

A 16-horsepower Darracq touring car, driven by A. J. Picard, left Heald Square, New York, at 6 o'clock Sunday evening, June 26, to attempt the feat of running at least 1,000 miles without stopping the motor and without breaking any law. Shortly after 1 o'clock p. m. on Wednesday, June 29, the same car rolled smoothly up to the same spot, having, according to M. La Roche, the New York agent, accomplished all that was intended and something to spare.

"We ran 1,053 miles before the motor stopped," said Mr. La Roche, "and it would not have stopped then if we had not turned into a barbed wire fence to avoid running down a woman. One of the fence wires sheared off a wire of the ignition system, stopping the motor, but a hasty temporary repair was made and the motor re-started after a delay of less than a minute. We had made our distance, however, and a little more, and were satisfied. The motor did not give a minute's trouble, and in all the distance traveled we had only one puncture in our Michelin tires. We were particularly careful not to exceed any legal speed limits, and were complimented more than once on our running by constables who knew what we were doing and were on the lookout for us."

A. J. Picard took the first trick at the wheel, leaving New York at about 6 o'clock Sunday evening and arriving at the Westminster Hotel, Boston, at 9:45 o'clock the following morning, stops having been made at New Haven and Springfield for gasoline, the motor being kept running. Twenty minutes later Mr. La Roche took charge and started back for New York. Ten-minute stops were made for gasoline and oil at Worcester, Springfield and New Haven. New York was reached at 11:55 o'clock Monday night. Both these sections of the run were entirely devoid of incident, the operators state, and the motor worked smoothly at all times. At 12:25 o'clock Tuesday morning, half an hour after the arrival of the car, it was started for Boston again by Mr. Picard, who had returned to New York by train. Gasoline was taken on at New Haven. The only puncture of the trip occurred just outside of Hartford, and was repaired in twenty-one minutes. Another stop for gasoline was made at Springfield and the run continued to Boston, which was reached at 4:25 p. m. Here Mr. La Roche again took charge and began the return trip at 5:05 o'clock. Stops for supplies were made at Worcester and Springfield. It was in this section of the run that the motor was stalled. A woman driving a horse and buggy got in the way and forced the car into the ditch, Mr. La Roche stating that he either had to do this or run into the woman. At this point the cyclometer read 1,053 2-3 miles. After getting under way again the run was completed and New York reached at 1:15 p. m. Wednesday, June 29, the total distance covered, according to the cyclometer, being 1,333 1-3 miles. Neither of the operators was greatly fatigued by the task and state that the fine running of the car saved them much discomfort.

TO INSIST UPON EXCLUSIVE AGENCIES.

Licensed Manufacturers Decide to Enforce Demand that Agents for Cars Built Under Selden Patent-Grant Handle no Independent Maker's Product.

Special Correspondence.

BUFFALO, June 27.—Trade matters of an important character were discussed at the annual meeting of the Association of Licensed Automobile Manufacturers, which was held at the Iroquois Hotel on Tuesday, June 21. The meeting was called to order by J. R. Smith, of Detroit, president of the association. About twenty-five prominent automobile manufacturers were present. The meetings were executive and such business as was transacted was made known to the public only in a general way. Technical questions dealing with the automobile are said to have been considered.

The matter of agencies for the year 1905 was the principal topic of discussion and action. Agents controlling the output of automobile factories not allied with the association will not be permitted to handle the licensed products. This subject was thoroughly considered and the necessity for the enforcement of such an order was explained by several members. A similar ruling was in force last year, but it was not strictly enforced and the agents managed to evade its purpose in many ways. Next year, however, measures will be taken to compel the agents to accept exclusively either the licensed automobiles or the non-licensed manufacturers' products. It is said that formal notice to this effect will be given to the agents at the beginning of next year.

The visiting manufacturers were entertained by the local dealers. The automobiles were provided and the visitors were taken on a tour of the city over some of Buffalo's best roads and boulevards. Tuesday evening the manufacturers were given a luncheon at the fashionable Buffalo Club.

An interesting fact which developed at the meeting of the Association of Licensed Automobile Manufacturers at Buffalo is that practically all of the 1905 models will be actually on the market by January 1. This is owing to the fact that most of the makers who are in the automobile business to stay have settled down to the types they consider best, and only very minor changes will be made in cars for next season, according to General Manager George Day of the association.

"The changes in next year's cars," said Mr. Day, "will be very much less important than the changes made in this season's output. The manufacturers all have good cars and do not need to make important changes. A very large proportion have made up their minds just what next season's cars will be, and preparations to manufacture are already under way. Cars with one, two, three and four-cylinder motors will be manufactured by members of the association.

"An exceedingly pleasant feeling was found to exist between the members of the association and the agents, which, of course, is very desirable, as the best results cannot be obtained except by the co-operation of all concerned."

SHIPPING FOUR-CYLINDER WINTONS.

Staff Correspondence.

CLEVELAND, June 27.—The Winton Motor Carriage Company is making its first shipments this week of its new four-cylinder touring cars. There have been rumors for many months that the Winton people would

build a four-cylinder car this season, but the advertising and sales department has never officially admitted it and even at this writing the company is unwilling to make public the details of construction, preferring to wait until samples have been thoroughly tested in the hands of agents. It is understood, however, that the motor is placed horizontally across the center of the frame at the front with practically the same arrangement of mechanism as was shown in the smaller Gordon Bennett racer built last year.

Sales Manager Shanks states that his company has built and sold 800 two-cylinder cars as originally planned for the season, and is now at work on a number more to take care of orders in sight. Work is also being pushed on 200 of the four-cylinder cars.

SCHEDULE OF LOCAL SHOWS.

Dates for Local 1905 Exhibitions Decided Upon at Promoters' Meeting.

The promoters of local automobile shows recognized by the National Association of Automobile Manufacturers held a joint meeting with a committee from the Association at Buffalo on June 22, at which were present William Metzger, of Detroit; George Collier, of Cleveland; F. J. Wagner and D. H. Lewis, of Buffalo; George L. Lowe, of Boston; H. D. LeCato and H. W. Schlichter, of Philadelphia, and B. C. Washington, Jr., of Washington, representing the recognized associations which have heretofore promoted local shows; and H. J. Budlong, Charles Clifton and S. A. Miles, representing the Association.

The following schedule of dates for shows was fixed upon:

New York—Jan. 14 to 21.

Chicago—Feb. 4 to 11.

Detroit—Feb. 20 to 25.

Cleveland—Feb. 27 to March 4.

Buffalo—March 6 to 11.

Boston—March 13 to 18.

Philadelphia—March 20 to 25.

Washington—March 27 to April 5.

The N. A. A. M. was requested by the show promoters to send a representative to each show, the promoters to bear the expense. It was agreed that the same method of space allotment adopted for the national shows shall be adopted for the local exhibitions.

KONIGSLOW BOUGHT OUT.

Staff Correspondence.

CLEVELAND, June 27.—The Globe Machine & Stampings Company, 970-972 Hamilton street, this city, has acquired the plant and business of Otto Konigslow, 31 Michigan street. Mr. Konigslow will go with the company as stockholder, director and superintendent. The company will occupy the Hamilton street factory, which will be enlarged. Mr. Konigslow has been closely identified with the automobile business for a number of years through the manufacture of a line of special parts and of the Konigslow gasoline car. These lines will be continued.

THE Board of Directors of the recently organized Motor and Accessory Manufacturers held a meeting at the Marlborough Hotel, New York, on June 23, when three new members were admitted, viz.: the Detroit Steel Products Company, Detroit; C. A. Mezger, New York; and the George R. Taylor Co., of Springfield, Mass. Negotiations are in progress with the N. A. A. M. regarding the allotment of space at the various automobile shows.

WIDESPREAD INTEREST IN FAIR EXHIBIT.

Buyers from All Quarters Visiting the Automobile Display in St. Louis and Leaving Orders—Demonstration Cars Used on the Grounds.

Special Correspondence.

ST. LOUIS, June 18.—The interest shown in automobiles at the World's Fair is remarkable, even to the National Association of Automobile Manufacturers. Those who come and give their time for hours to look over the various makes of cars, when there is so much else to see at the Fair, are interested beyond question, and they prove it by leaving orders.

The sightseers are a cosmopolitan crowd to look upon. The Japs study the American steam cars and the French racers. The Germans go through the American section very carefully. Inhabitants from Australia and New Zealand have ordered several automobiles to be shipped to their antipodean homes. Westerners through the place and ask all manner of intelligent questions.

DEMONSTRATION CARS IN THE GROUNDS.

Grout Brothers were the first exhibitors to complete their display and they are doing a rushing business. They make their great hit with the \$650 runabout, which comes within reach of the many as to price and is built on strong, practical lines. The manager has made arrangements with the World's Fair officials to keep cars outside the Transportation Building to be used for demonstrating purposes. Prospective purchasers can step from the exhibit out to the car in waiting and see for themselves the concentration of power at small cost which is claimed for the Grout. This company also exhibits a high-priced touring car, but the little model has so far proved the more attractive to purchasers.

The official photographer at the Fair has purchased a Grout car, which he uses about the grounds. A sixty-passenger Columbia electric break is in use by the Blanke Tea and Coffee Company in taking care of its friends during the Fair. Many private gasoline cars have been permitted on the Exposition grounds by the World's Fair management.

FEATURES OF SOME EXHIBITS.

The Oldsmobile manager reports a brisk trade. He is securing agencies all over the world. Foreign visitors examine his cars daily and he has taken many orders for individual machines to be shipped in August. The youngsters as well as older sightseers like the Oldsmobile section, because souvenirs in the form of tiny relief figures of the Olds car mounted on stick pins are given away.

The exhibit of White steamers is very attractive. Half a dozen cars, all that can be disposed of, as the output for the season is sold, have already been purchased by visitors at the Fair.

The Pierce display is also good, and orders are being taken for Pierce stanhopes, although deliveries cannot be promised until August. The Arrow touring car is attracting much attention.

In the Haynes-Apperson display is a fine aggregation of tonneau cars. The new tonneaus are 250 pounds lighter than last year's models, notwithstanding the horsepower has been increased from 12 to 14 and the rear axle is now made of 1 1/2 inch nickel steel. Roller bearings are also used.

Among the machines shown in the Ford booth is one said to be the first automobile built in Detroit and the third one built in the United States.

MT. WASHINGTON CLIMB AND TOUR.

Fast Time Made by Investigating Party Up 7½-Mile Ascent—Road Closed to Automobiles Except During Week of July 11—Fine Touring Country.

A preliminary "climb to the clouds," up the road to the summit of Mount Washington, has been made recently by a party including Harlan W. Whipple, in his 60-horsepower Mercedes; Harry Fosdick, of Boston, in a Winton 20-horsepower touring car; L. J. Phelps, of Stoneham, Mass., in a 20-horsepower Phelps, and Otto Nestman in a 7-horsepower Stevens-Duryea. The same party also went over the route of the proposed two-day tour to follow the hill-climbing test scheduled for July 11 and 12. All of the machines made the ascent and acquitted themselves surprisingly well. Nestman, in the Stevens-Duryea, eclipsed the former record of the Phelps touring car by nearly an hour, his time being 48 minutes 30 seconds, while Fosdick in his big Winton made the 7½ mile journey in 1

hour 40 minutes, accompanied by Mrs. Fosdick and a mechanic.

highway is operated under a rigid state charter, and as the owners are dependent upon horse-drawn vehicles for the major part of their income, it is not surprising that they have closed the road to automobiles except for the week in July during which it is given to them exclusively. All records made during that week will, therefore, stand until July, 1905.

It is expected that a number of automobilists from New York, Boston and intermediate cities will drive to the White Mountains for the week's tournament. Messrs. Whipple, Fosdick and Phelps drove up in their cars from Boston and returned the same way. The tourist from Boston has a number of routes open to him to Dover, N. H. From Dover all routes direct into the mountains lead through Rochester, Ossipee and North Conway to Bretton Woods by way of Crawford Notch. Tourists starting from New York can take either the Springfield or the Shore Line routes to Boston, or ship their cars by water over this initial part of the trip. The Maine Steamship Company's boats run direct from New York to Portland, whence the White Mountains are less than 100 miles distant by way of Sebago Lake.

tor Corporation, Cameron; Prescott Automobile Co., Prescott steamer.

In addition, the following well known racers will participate: Nathaniel Huggins, 40-horsepower Decauville; Harry Harkness, 60-horsepower Mercedes; H. L. Bowden, 60-horsepower Mercedes; Harlan W. Whipple, 60-horsepower Mercedes, and a number of others.

WESTERN TOUR ROUTES.

Probable Courses of World's Fair Tourists Through Oklahoma and Kansas.

Additional details received by the St. Louis Tour Committee regarding road conditions indicate generally favorable conditions. The roads from Cleveland to Toledo and beyond have been inspected and found excellent, and it is believed that no road directions will be required for this section. The confetti trail being sufficient. The Hollenden Hotel at Cleveland will be committee headquarters and, as at other places, officials will be prepared to direct tourists to garages and repair shops.

At Toledo the tourists will be met east of the city by the local club, and will be assisted in every way. The route through the city will be marked with flags. Officials at the Toledo headquarters will wear red caps. The tour committee offers the suggestion that this plan be adopted at other places to facilitate matters.

The Kansas City committee is working on the routes west of St. Louis, and has made a number of suggestions which probably will be followed closely. Two roads across Oklahoma have been suggested, one following the Santa Fe Railroad and passing through Ardmore, Norman, Oklahoma City, Guthrie, Perry, Ponca, Newkirk and entering Kansas at Arkansas City, and the other following the line of the Rock Island Railroad through Terrall, Ryan, Marlow, Chickasaw, El Reno, Kingfisher, Enid, Pond Creek, Medford and entering Kansas at Caldwell. At Wichita, Kansas, these two routes should be united, the one from Arkansas City leading to Wichita via Winfield and the one from Caldwell via Wellington. The route through Kansas from Wichita to Kansas City is Wichita, Newton, Peabody, Florence, Elmdale, Cottonwood Falls, Emporia, Osage City, Ottawa and Olathe.

Iowa tourists to St. Louis are advised to join the Denver and Kansas City travelers by passing through Kirksville, Macon, Moberly, Centralia, Mexico and Danville, joining the main body at Warrenton.

The Touring Committee announces its intention of discouraging in every possible way anything approaching speeding, or any tendency on the part of the participants to turn the tour into a series of races or an endurance contest. No restrictions as to the length of time to be occupied will be made, and even the route selected for the tour need not be strictly adhered to. With regard to the awarding of certificates for perfect runs, the committee states that registration books must be closed at 10 o'clock p. m. each day, owing to the necessity for transporting the officials to the next stopping place. Any tourists who speed ahead of the main body will have to wait at the next stopping place until the registration books are opened, so they will gain nothing by their hurry.

GEORGE ADE, of fable fame, was recently arrested in Chicago for speeding. He proved an alibi, however, by showing the judge that his car was a red one, while the policeman who arrested him swore that the one he saw was blue.



IN THE WHITE MOUNTAINS—MT. WASHINGTON IN THE MIDDLE BACKGROUND.

hour 40 minutes, accompanied by Mrs. Fosdick and a mechanic.

As a result of this exploration trip the opinion is held by the experienced drivers named that the automobile that can successfully traverse the White Mountain roads of New Hampshire can safely be trusted to give a good account of itself in any section of the country. Not that the White Mountain roads are worse than the average country highways—some of them are much better—but the many hills of varying length and grade test the engine and running gear thoroughly. Mr. Phelps said that the observations he had made would be of importance to his firm and are likely to be reflected in next year's models. He also said that he believed it would be to the best interest of other manufacturers if they brought their machines into the mountains for trial runs, especially the new experimental models.

No other attempt to climb Mt. Washington by automobile will be allowed until the date of the first annual contest, July 11, and from that date no automobile will be allowed on the toll road until next year. This

The promoters of this midsummer contest and tournament are doing all that can be done to make the affair a success, and it is hoped that a large number of tourists will join with the hill climbers to make this an annual tournament of especial importance in New England. There is no better touring country in the East than the White Mountain region of New Hampshire, where the scenery is magnificent, the temperature cool and the roads good.

Among the entries received for the hill-climbing contest are the following: White Sewing Machine Co., White steamer; Ford Motor Co., Ford; Stanley Motor Carriage Co., Stanley steamer; Phelps Motor Vehicle Co., Phelps; Oldsmobile Company, Oldsmobile; Peerless Motor Car Co., Peerless; E. R. Thomas Motor Co., Thomas; J. Stevens Arms & Tool Co., Stevens-Duryea; Winton Motor Carriage Co., Winton; Waltham Manufacturing Co., Orient buckboard; Haynes-Apperson Co., Haynes-Apperson; Crest Automobile Co., Crestmobile; Consolidated Motor Co., delivery wagon; George N. Pierce Co., Pierce Arrow; Packard Motor Car Co., Packard Model L; United Mo-

RHODE ISLAND CLUB 270-MILE TOUR.

Delightful Three-Day Club Run from Providence to Portsmouth, N. H., Through Beautiful Mountain Scenery and Over Good Roads.

Special Correspondence.

PROVIDENCE, R. I., June 27.—The club run of the Rhode Island Automobile Club to Portsmouth, N. H., June 24 to 26, which was the first long run of any of the New England clubs, was eminently successful, and the tour of upwards of 270 miles has left such a favorable impression in the minds of the participants that in all probability long runs will be a feature of the Rhode Island club's future programs.

Eleven cars, carrying about forty persons, returned to Providence at a seasonable hour Sunday night, and the participants claim that the tour is the most notable of the year up to the present time.

The preparations made by the committee on runs and tours were ample to meet the demands of the tourists and not an unpleasant incident or accident of any kind occurred. The Rhode Islanders were ex-

committee communicated with the commissioners, asking permission for the party to pass through and received an affirmative reply. When the tourists arrived at the city line, Friday afternoon, they were met by the commissioners in an automobile and escorted all through the woods.

Hotel accommodations had been reserved at Magnolia, and the dusty travelers found rooms and refreshments awaiting them.

At a meeting of the members to lay out the route for the following day, complaint was made by some that it was difficult to follow the course of the pilot car; the several cars strung along the road for more than three miles in order to avoid the dust and turns the car ahead would be out of sight, causing confusion and loss of time in making inquiries as to the proper road. R. Lincoln Lippitt, who steered the pilot car, procured several bags filled with waste paper, which he had cut into small pieces, and during the next day's run from Magnolia to Portsmouth this improvised *confetti* was used to mark the route at turns and forks. The success was so great that it was continued during the remainder of the trip.

Friday night was spent in Magnolia and Saturday's journey was over the roads near

ter, Edward F. Parks, Henry A. Palmer, in Winton touring cars; W. P. Mather, Misses Ruth and Janet Mather, F. A. Ballou, Russell Knight, E. C. Longley, George T. Hall and F. A. Buckhout, in Pope-Toledo cars; Harry O. Potter, Harry G. Martin, F. L. Chase and Pardon Miller, in a Peerless; Mr. and Mrs. B. W. Barrows, Mr. and Mrs. Glen A. Tisdale and Miss Amey Allen, in a Thomas touring car; Mr. and Mrs. Eugene Sawin and son, in an Autocar; Mr. and Mrs. Howard Wilcox, Mrs. Elliot Flint and Duttee Wilcox, in a Searchmont; Mr. and Mrs. George W. Harris, who joined the party at Portsmouth, in a Columbia.

CALIFORNIA ENDURANCE RUN

Nine-Day Test Trip Between Frisco and Los Angeles Planned.

Special Correspondence.

SAN FRANCISCO, June 20.—The Automobile Club of California, in conjunction with the Automobile Club of Southern California, is making arrangements to hold an endurance run from San Francisco to Los Angeles and return. It is probable that



START OF RHODE ISLAND CLUB RUN FROM PROVIDENCE FOR BOSTON AND PORTSMOUTH, N. H., JUNE 24.

tended the right hand of good fellowship by the clubs throughout northern New England and the courtesies extended by the New Hampshire club and the Park Commissioners of Lynn added considerably to the pleasure of the trip.

The trip was made over some of the best roads in the country, and only those who have journeyed through the rugged New England hills and dales can fully appreciate the enthusiastic reports of the beautiful scenery brought back. The twelve-mile macadam road between Ipswich and Salem left a very favorable impression and the scenery at Beverley, Beverley Farms, and along the road from Magnolia to Gloucester was a pleasing contrast to the dusty and hilly highways encountered about Cape Ann.

The members intending to participate in the tour gathered at the club headquarters in the Crown hotel, Providence, Friday forenoon. The start was made soon after 10 o'clock and the party proceeded directly to Boston. Two hours were spent at the Hub, during which time dinner was served at the Lennox hotel, and in the afternoon the run to Magnolia was made. When the committee laid out the route the famous Lynn Woods, from which automobiles are excluded by order of the Park Commissioners, was regarded as an attraction. The

Cape Ann close to the ocean. The New Hampshire club, which had previously been notified of the contemplated run, sent a car to meet their Rhode Island brethren at Hampton Beach and escorted them to the club's headquarters at Boar's Head, where a clam dinner was served. The royal reception by the New Hampshire club was doubly welcome, as a severe electric storm broke during the repast. After dinner the storm cleared and the run to Portsmouth was made without trouble.

The return trip from Portsmouth to Providence was made Sunday. Lunch was served at Salem and the party arrived at their homes about 9 o'clock in the evening.

If the success of the run is to be measured by the amount of pleasure derived by the participants, the trip was indeed a success and the members of the committee as well as the members of the club are congratulating themselves upon the outcome of the venture.

The following persons participated: Dr. J. A. Chase, president; F. M. Barber, assistant secretary, and Mr. and Mrs. Lowell Emerson, in Stanley steamers; R. Lincoln Lippitt, chairman of the runs and tours committee; Dr. Charles D. Winsor, Elliot Flint, Mr. and Mrs. E. I. Rogers, E. I. Rogers, Jr., Morgan W. Rogers, Mrs. L. B. Witter, Henry A. Carpenter, Alva Carpen-

the event will be held in July. The San Francisco cars, after running to Los Angeles, will be joined by the southern contestants, who will accompany the San Franciscans home and then return south, thus completing the round trip. Speeding will be discouraged. There will be an observer on each car, who will see that all the rules of the run, including the one forbidding high speed, are observed. It is expected that the round trip will require nine days.

BALTIMORE RACES JULY 4.

Special Correspondence.

BALTIMORE, June 27.—The first series of automobile and motor cycle races of the season will be held at Electric Park on July 4, under the management of Howard French, and provisions are being made for a large attendance.

The American Wheelmen will be represented in the club contest by their crack team, W. H. Kanne, William Morris and Bob Shanklin. Howard Gill, of Baltimore, will be on hand with his new *Baltimore Cyclone*, and W. A. Schaum will drive a machine of his own designing, built in Baltimore. Bob French's new 16-horsepower motor car will make its first public appearance during the races.

INFORMATION FOR BUYERS.

TRANSMISSION.—A very neat planetary transmission, giving two speeds forward and reverse, suitable for cars with motors up to 8-horsepower, is that made for the Automobile Supply Co., Chicago. The outside diameter is 9 1-2 inches and the outside with 8 1-4 inches. The band brakes are 1 1-2 inches wide, and there are no gears in operation on high speed.

AXLE GRAPHITE.—The Joseph Dixon Crucible Co., Jersey City, has brought out a new compound, called Everlasting Axle Grease, the main ingredients of which are a high grade grease and flake graphite. The idea is that the graphite works into the pores of the metal, and not only improves the lubricating qualities of the grease, but forms a surface glaze which will not rust, corrode or wear even if the grease becomes exhausted.

PORTABLE TURNTABLE.—By the use of the Weber Portable Turntable an automobile can be turned in any place where there is room without the necessity for cutting the floor to install a regular turntable. This device consists of a pair of small trucks secured parallel to each other, and connected by a small steel platform hung between them. Two of these pairs of trucks constitute a turntable. Either the front of the rear pair of wheels is run on a pair of trucks, when the heaviest car may be pushed around by one man. They are made by the Weber Cycle & Supply Co., Colorado Springs, Col.

SKID PREVENTER.—Owing to the fact that the skidding of rubber tires on greasy or icy roads cannot, apparently, be prevented by corrugations or other irregularities in the tread of the tire, automobilists have commonly resorted to the expedient of winding their tires with ropes or chains when such



WEED'S CHAIN TIRE GRIP.

roads could be avoided. Weed's chain tire grip is designed to take the place of such windings, as being more convenient to handle and at the same time more effective in operation. The illustration shows the arrangement of the device clearly. This appliance is warranted by the maker not to injure the tire, and is said to be very easy to apply and remove. Manufactured by H. D. Weed, Canastota, N. Y.

EQUALIZING GEAR.—A spur equalizing gear is being manufactured by the Cullman Wheel Company, Larrabee street, Chicago, in three sizes, suitable for motor vehicles of all sizes. The special feature of this gear is that the pinions are solid, having no holes for axles, the ends being extended to form

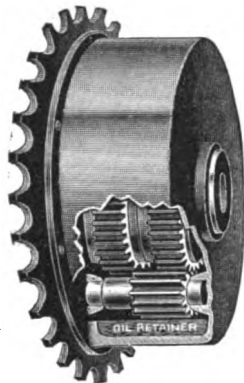

CULLMAN EQUALIZING GEAR.

bearings. This eliminates a source of weakness and reduces the number of parts. Better lubrication is claimed than with other methods of construction for the reason that oil can more readily reach the bearings. Special attention is given to making the gear case dustproof. The case and cover are of malleable iron and the pinions of steel hardened. The gears are also of steel. Sprockets are so attached that they can be removed at any time without disturbing any other part of the gear.

MICHELIN TIRES.—The Michelin tire has again made a grand showing of its fine qualities, this time in the recent French elimination trials for the Gordon Bennett cup race. The cars equipped with this famous tire made splendid runs, and there is no doubt as to what the French automobile experts think of the tire. The Michelin, owing to the scientifically correct manner in which the rubber is cured and the improved methods of laying on the fabric, possesses wonderful resiliency and at the same time is remarkably durable. In fact, durability is the point on which the makers and agents lay the greatest stress, for, after all, the durable tire is the one that will win out. The United States agency for the Michelin Tire Company, 140 West Twenty-seventh street, New York, is justly proud of the product it handles.

ANTI-PUNCTURE.—Ever since pneumatic tires began to be punctured, and that was as soon as they began to be used, inventors have been hard at work on all kinds of schemes to render them either proof against puncture, or self-healing. To the latter class belongs the compound manufactured by the New York Anti-Puncture Tire Co., 132 W. Forty-ninth street, New York. This material, which when cold is of the consistency of soft, spongy rubber, is melted in a water bath at a temperature of 212 degrees, when it assumes the consistency of thick cream. It is then pumped into the tire through the valve and the tire is rotated and moved about so that every portion of the interior is coated with the compound, the layer varying from 1-4 inch to 1-2 inch, according to the size of the tire. As it cools it returns to its original consistency and adheres strongly to the inner surface of the tire. The quantity required per tire varies from 3 to 10 pounds, according to size, the latter quantity being sufficient for the largest tires made.

HARRIS OILS.—The A. W. Harris Oil Company, South Water street, Providence, R. I., has made a specialty of grading lubricants according to their adaptability for use in water or air cooled gasoline motors, or in steam engines, whether using superheated steam or not, for sight feed or splash lubrication, electric vehicles and other work. The gas engine oil for water cooled motors is unusually fluid, thus permitting it to be fed with great regularity, and it is stated by the makers that it may, if necessary, be used for other than cylinder lubrication, and that when used in cylinders it will not carbonize and leave a deposit. Super gas engine oil for air cooled cylinders is heavier and less fluid. The Harris motor grease for compression cups and the graphite grease for chains are compounded for the special work they are expected to perform.

SPARK PLUG.—A new spark plug manufactured by Torbensen Gear, Incorporated, in which new features are embodied, is thoroughly well made. The insulation, of imported porcelain, is in one piece and is held in place by a single nut. Between the nut and the shoulder on the porcelain is interposed a packing gasket, making the plug gas-tight. The inner end of the porcelain core, which carries the central sparking point, is set into a very deep recess in the steel shell of the plug. The advantages of this arrangement are twofold. First, the distance to be traveled by the secondary current before it can establish a short circuit is considerable—about 1 3-8 inch—and secondly, the pumping action of the gases entering and leaving the recess assists in a large measure in keeping the points clean. Instead of the usual threaded rod and nut for securing the wire

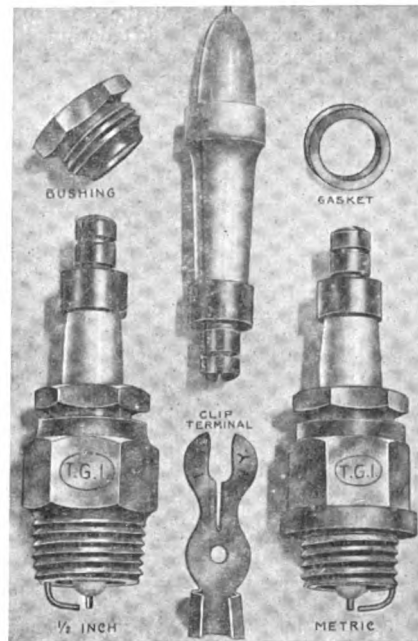

TORBENSEN PLUGS AND PARTS.

terminal, the T. G. I. plug is provided with a brass head in which a recess is turned. A spring clip, to which the wire is attached, snaps into this recess, being prevented from coming off by the closing of its jaws; but there is just a little play allowed so that there is no tendency to bend or twist the wire or clip. A small pamphlet issued by the manufacturers fully describes and illustrates the plug and terminal, as well as

the T. G. I. spark gap. It can be had on application to Torbenson Gear, Incorporated, Bloomfield, N. J.

AUTOMOBILE BARGAINS.—H. F. Borbein & Company, St. Louis, Mo., have bought out the business of the Brecht Automobile Company, and a lot of complete electric and steam automobiles, as well as a quantity of wheels, axles, knuckles, springs, etc., which cannot be used by the new proprietors in their styles of vehicles, will be sold at very low prices. A decriptive sheet gives prices and other information concerning the stock to be disposed of.

AUTO JACK.—A new automobile jack has been brought out by the Kenosha Jack Mfg. Co., Kenosha, Wis., which is said to be light, durable, powerful and positive in action. It is built of malleable iron of the best grade and has a rack and pinion movement, actuated by a worm, into which the T-handle, by which it is operated, is inserted. The rack can be pulled up to any desired height within the limits of the jack, the worm automatically disengaging and re-engaging, when the rack is dropped, by its own weight. Capacity, 1 1-2 tons.

STEERING GEAR.—A new steering gear has been placed on the market by the Automobile Supply Co., 1339 Michigan Boulevard, Chicago, suitable for and attachable to any automobile weighing not over 1,200 pounds. A socket for the foot of steering column is provided, and also a crank to which the connecting rods are attached, and between these two are the cut steel gears, which may be run in grease. This gear can be supplied with column and rigid or tilting wheel, or without either, as may be desired.

REFRIGERATOR BASKET.—Nothing is more disagreeable when automobiling on a hot day than to find a carefully prepared lunch all dried up and warm and the drinkables tepid from the heat. A basket designed to keep provisions cool throughout a hot day has been offered to the automobiling public by the Burlington Basket Company, 33 Main street, Burlington, Iowa, which is said to fulfil its mission admirably. It is styled the Hawkeye refrigerator basket, and is made in two sizes, the small one 18 inches long, 10 inches wide and 8 inches deep, and the large size 20 inches long, 13 inches wide and 10 inches deep. A small compartment is filled with ice, and the insulation of the basket and cover "retains the cold and keeps out the heat." The basket is of convenient shape and is substantially made. Handles are provided for carrying.

FAMILY AUTOMOBILE.—The Bates Automobile Company, Lansing, Mich., is manufacturing a car especially for a family vehicle, and in its design and construction this end has always been in view. It is a tonneau car with side entrance; the tonneau is detachable. The backs of the seats are high and comfortable, being well upholstered. The 30-inch artillery wheels are fitted with large tires—3 1-2 inches in diameter—and these, together with the easy springs and long wheel base (92 inches), make the car an exceptionally comfortable one to ride in. Wheel steering is fitted, and a single lever controls the two forward speeds and reverse without resorting to foot pedals. The drive is by bevel gear, direct on the high speed, when the car will make 75 miles on hour. The three-cylinder vertical engine develops 18-horsepower, and is lubricated by the splash system. The jump spark system of ignition is used, the commutator being placed on the dash. The car is sent out with mud guards, two oil side lamps and a tail lamp and a gas headlight, horn and kit of tools.

TENNANT TIRES.—We are informed by the Tennant Auto-Tire Company, of Springfield, Mass., that the Tennant tires are not guaranteed unless they are inflated so that they will stand up round under load, the same as any other pneumatic tire, and unless the instructions which accompany tires are followed closely. Tennant tires will stand up without air for a few miles when first put on, but of course will eventually flatten down and destroy the tube if not pumped up. This caution seems necessary because of the experiences of automobilists who have undertaken to use these tires without air in the tubes, and after coming to grief as a consequence, have felt inclined to lay the fault to the tire.

INDEX TO ADVERTISERS

A

Acetylene Gas Illuminating Co. 36
 Acme Motor Car Co. 67
 Alexander & Crouch. 54
 Allene Brass Foundry Co. 53
 American Automobile and Power Co. 34
 American Coll Co. 49
 American Machine Co. 35
 American Metal Polish Co. 36
 American Oak Leather Co. 46
 American Veneer Co. 42
 Anderson Manufacturing Co., J. C. 52
 Angullil, Luigl. 43
 Association of Licensed Automobile Mfrs. 57
 Atwood Mfg. Co. 43
 Auto-Car Equipment Co. 54
 Automobile Supply Co. 48
 Auto Supply Co. 49

B

Baker Motor Vehicle Co. 68
 Baldner Motor Vehicle Co. 53
 Bartholomew Co., The. 58
 Bay State Stamping Co. 35
 Beaconsfield, The. 56
 Berg Auto Co. Cover
 Berg & Leinbach. 42
 Biddle & Smart Co. 42
 Bliss-Chester Co. 36
 Blomstrom, F. H., Motor Co. 58
 Borbein & Co., H. F. 53
 Boston Gear Works. 38
 Bradford Motor Works. 51
 Briggs, W. H. 38
 Briscoe Mfg. Co. 49
 Bruok Solidified Oil Co. 55
 Brooklyn Automobile Co. 34
 Buckmole Co. 59
 Bullock-Beresford Mfg. Co., The. 37
 Burlington Basket Co. 50
 Byrne-Kingston Co. 37

C

Cadillac Co. of N. Y. 34
 Central Automobile Co. 59
 Clarkmobile Co., The. 60
 Coburn, R. F. 34
 Columbia Automobiles. 34
 Continental Caoutchouc Co. 47
 Couffield Co., H. L. 52
 Crane, George A. 34
 Crest Mfg. Co. 64
 Cullman Wheel Co. 53

D

Dayton Electrical Mfg. Co. 50
 Diamond Rubber Co. 46
 Diets, R. E. 44
 Dixon Crucible Co., Jos. 38
 Dow Portable Electric Co. 36
 Draper Bros. Co. 35
 Duerr-Ward Co. 34
 Dyke Auto Supply Co., A. L. 35

E

Electric Storage Battery Co. 49
 Electric Vehicle Co. 64
 Elmore Mfg. Co. 63
 Excelsior Supply Co. 35

F

Federal Mfg. Co. 49
 Fisher Special Mfg. Co., The. 35
 Ford Motor Co. 63
 Ford, Peter. 35
 Fredonia Mfg. Co. 58
 Funke, A. H. 43

G

General Auto and Repair Works 38
 Gilbert Mfg. Co. 36
 Goddu Bros. 50
 Gray & Davis. 44
 Grossman, Emil. 44
 Grout Bros. Automobile Co. 71
 G & J Tire Co. Cover

H

Hardy Co., The R. E. 49
 Harris Oil Co., A. W. 39
 Hawkeye Wrench Co. 42
 Hague & Co. 36
 Haynes-Apperson Co. Cover
 Herz & Co. 38
 Hine-Watt Manufacturing Co. 43
 Holtzer-Cabot Electric Co. 35
 Hopson & Chapin Mfg. Co., The. 53

I

Induction Coil Co. 49

J

Jeffery & Co., Thomas B. 69
 Jones-Corbin Automobile Co. 60
 Jones Speedometer. 38

K

Kaestner Mfg. Co., The Chas. 54
 Kells, W. J. 53
 Kent Manufacturing Works, Atwater. 35
 Keystone Motor Car Co. 57
 Knox Automobile Co. 62, 65

L

Laminated Tube Co. 53
 LaRoche Co., F. A. 60
 Lewis & Matthews Co., The. 34
 Limousine & Carriage Mfg. Co. 42
 Lobe Pump & Machinery Co. 53
 Locke Regulator Co. 36
 Locomobile Co. of America, The. 64
 Lowell Model Co. 54

M

Mason, Harvey & Co. 34
 Matheson Motor Car Co. Cover
 Manhattan Lamp Works. 43
 Marble-Swift Automobile Co. 59
 Marion Motor Car Co. 68
 McCord & Co. 36
 Meyrowitz, E. B. 36
 Mezger, C. A. 38
 Michelin Tire Co. 45
 Miller, Charles E. 42
 Miller Knoblock Elec. Mfg. Co. 54
 Morgan & Harding. 46
 Moss Photo Engraving Co. 40
 Motor Car Supply Co. 36
 Munsall, Eugene & Co. 37
 Myers, A. J. 54

N

National Compounding Co. 51
 National Motor Vehicle Co. 62
 National Sewing Machine Co. 60
 N. E. Rubberine Co. 36
 Neustadt Co., J. H. 53
 New York Anti-Puncture Tire Co. 50
 Northwestern Storage Battery Co. 49
 Nuttall Co., R. D. 53
 N. Y. & N. J. Lubricant Co. 36

O

Oakes & Dow. 35
 Olds Motor Works. Cover
 Ophthalmoscope Co. 37

P

Packard Automobile Co. Cover
 Packard Electric Co. 49
 Parish & Bingham Co. 46
 Pardee & Co. 34
 Pedersen, J. T. 37
 Peerless Motor Co. 68
 Phelps, E. T. 34
 Pierce Engine Co. 63
 Pioneer Automobile Co. 34
 Pittsburg Reduction Co. 53
 Post & Lester Co. 42

Q

Quinby Co., J. M. 42

R

Randall, F. E. 34
 Rattan Novelty Co. 35
 Reading Automobile Co. 43
 Riverside Body Factory. 42
 Rotary Motor Vehicle Co. 54
 Royal Equipment Co. 35
 Royal Motor Car Co. 67
 Rubay, Leon. 37
 Rushmore Dynamo Works. 44

S

Saks & Co. 33
 Savage, E. G. 59
 Schug Electric Co. 43
 Shaln, Chas. D. 35
 Skinner, K. A. 34

THE AUTOMOBILE

WEEKLY

NEW YORK—SATURDAY, JULY 9, 1904—CHICAGO

10 CENTS

AUTOMOBILING IN CANADIAN NORTHWEST.

AUTOMOBILING in the Canadian Northwest is by no means an unheard-of thing, as might be imagined by those who think of the towns out there as collections of wigwams and tents. Winnipeg, Manitoba, for instance, which is by far the most important city in the Canadian

comes in contact, like molasses, but is so slippery that it is a matter of no difficulty whatever for pedestrians to slide on it and fall, the sensation being exactly the same as that which accompanies a slip on a banana-skin. It can be imagined what this mud is in wet weather, and especially in the spring

ly asphalted thoroughfare, and is said to be equal, so far as the excellence of its road surface is concerned, to anything of the kind on this side of the Atlantic. This is a great contrast to the condition of the Winnipeg roads a few years ago, when the pioneer motorist of the city was forced to

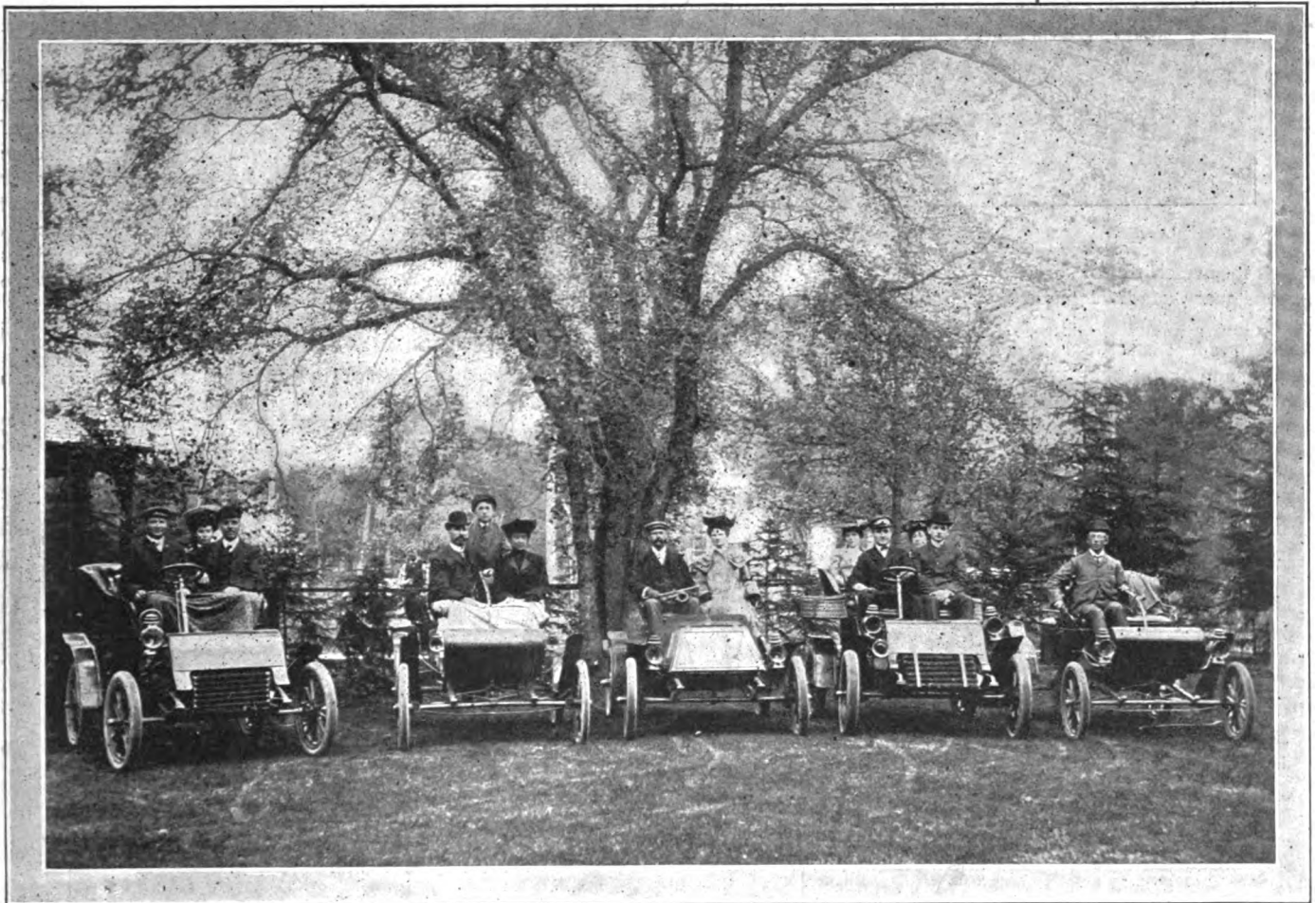

MEMBERS OF THE WINNIPEG AUTOMOBILE CLUB WITH THEIR MACHINES IN THE GROUNDS OF EX-MAYOR JOHN ARBUTHNOT.

Northwest, has a flourishing automobile club, though at first there were about as many discouragements to automobiling as could well be imagined. Probably the worst feature of all was—and still is, to some extent—the famous “Winnipeg mud,” a particularly gummy brand of red clay that not only sticks to anything with which it

when the snow is melting off. A large proportion of the country roads are simply tracks through this clay, and in really bad weather are absolutely impassable. In the city and its immediate vicinity, however, things are different, and there are now miles and miles of well-paved streets. Assiniboine Avenue, for instance, is a magnificent-

abandon the urban runs during muddy weather owing to the enormous quantities of clay that accumulated on the front wheel of his three-wheeler.

The illustration herewith shows some of the members of the Winnipeg Automobile Club with their machines in the grounds of ex-Mayor John Arbuthnot.

New Jersey Road Improvement.

Rapid Growth of Work Under State Aid Law that Is of Particular Interest to Automobilists.

THE little broken backed Atlantic seaboard state of New Jersey, ridiculed everywhere for her mosquitoes, but beloved for her sweet potatoes, has for the last decade

miles more, which are estimated to cost \$2,195,247. Therefore, automobilists of the metropolitan district and those from more remote sections may hope to be able to



CORLISS AVENUE, OCEAN GROVE, MONMOUTH COUNTY, BEFORE IMPROVEMENT.

created for herself and of her own volition a new and more admirable claim to national distinction. She was the first state of the Union to adopt state aid in public road building and under that system, although one of the smallest of our commonwealths, she has already improved more than twice as many miles of highway as any other state, and that at a comparatively low cost.

In the ten years since the original state aid law was passed New Jersey has rebuilt 952.08 miles of road in accordance with engineer's specifications for telford, macadam and gravel construction. In addition to this mileage, there was under contract or in process of construction last October nearly six miles more. The total amount expended or provided for this work was \$4,545,494, equivalent to an average cost of approximately \$4,740 per mile.

As compared with this excellent showing, New York state has built and has under construction 484 miles, at a cost of \$4,135,000, or an average cost of about \$8,543.50 a mile; Massachusetts has improved 480 miles at a cost of \$5,150,923, or an average of \$10,729, and Connecticut has rebuilt 454 miles at a total expense of \$2,233,000, or an average per mile of \$4,930.

BUILT 300 MILES IN TWO YEARS.

More than 155 miles of roadway has been rebuilt in New Jersey during each of the last two fiscal years ending with October, and the various counties have petitioned for the improvement of a total of 475.98

enjoy touring over a system of 1,500 miles of some of the finest and most picturesque roads in the country in another three years. Already New Jersey is one of the most popular states in the country for motoring,



CORLISS AVENUE AFTER IMPROVEMENT—A FINE STRAIGHTAWAY STRETCH.

especially for short trips, the Philadelphia to Atlantic City and the New York to Philadelphia runs being especially popular.

"There has been no cessation in the de-

mand for good roads," writes Commissioner of Public Roads Henry I. Budd, in his Tenth Annual Report for the year 1903. "Over seventy different improvements have been started, aggregating 190 miles, about 153 miles of which have been sufficiently advanced to command this year's appropriation. If the amount apportioned by the state had been increased to \$400,000, the sum allowed by the new law, it would all have been consumed and then would have come short of meeting the demands of the numerous petitions.

HINDERED BY WET WEATHER.

"In our ten years of road building, this has been the most difficult we have encountered, the progress of the work having been greatly delayed by the excessive rainfall in all parts of the state, and the scarcity of labor and teams, it being almost impossible at times to secure an adequate supply of the latter, owing to the great amount of municipal work. Consequently, construction was retarded to such an extent that it is in a more backward condition than in any previous year, and, owing to the great demand for labor and material of all kinds, the prices for the same were so much higher that many of our roads cost 20 percent. more than they did in previous years."

Despite these influences, the various counties together managed during the last year to rebuild a total of 155.29 miles of road, which is practically the same amount as was improved the preceding year and exceeded by more than forty miles the mileage constructed in any former year.

COUNTIES MOST ACTIVE IN THE WORK.

Since the original state aid law went

into effect, every one of the twenty-one counties in New Jersey has availed itself of the assistance of the commonwealth to improve its highways, with the single ex-

ception of Hunterdon, lying in the angle formed by the junction of the Musconetcong River with the Delaware, on the west side of the state. Burlington County, the largest

Bay, west and south of Staten Island, comes second in mileage, having reconstructed 97.1 miles. Closely following in order of mileage are Mercer County, in which Tren-

many of the seaside resorts, as Long Branch, Asbury Park, Monmouth Beach, Sea Bright and Ocean Grove; and Atlantic County, also on the coast, the principal in-

NEW BRUNSWICK AND BOUND BROOK ROAD AS IT APPEARS NOW.

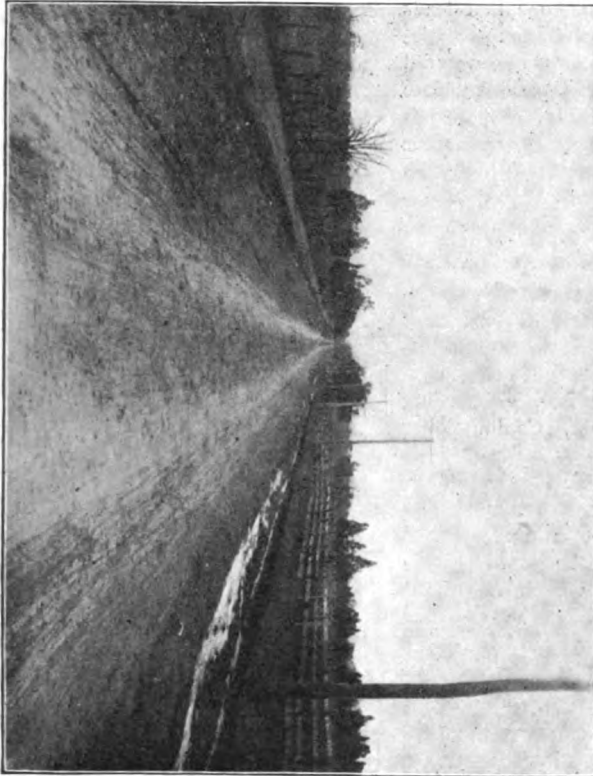

NEW BRUNSWICK AND BOUND BROOK ROAD BEFORE MACADAMIZING.

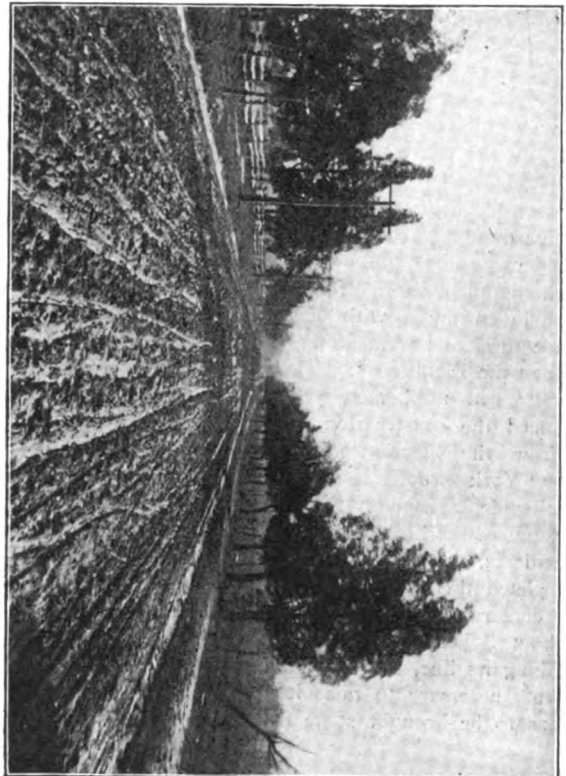

STANHOPE AND NEWTON ROAD, SUSSEX COUNTY, BEFORE IMPROVEMENT.

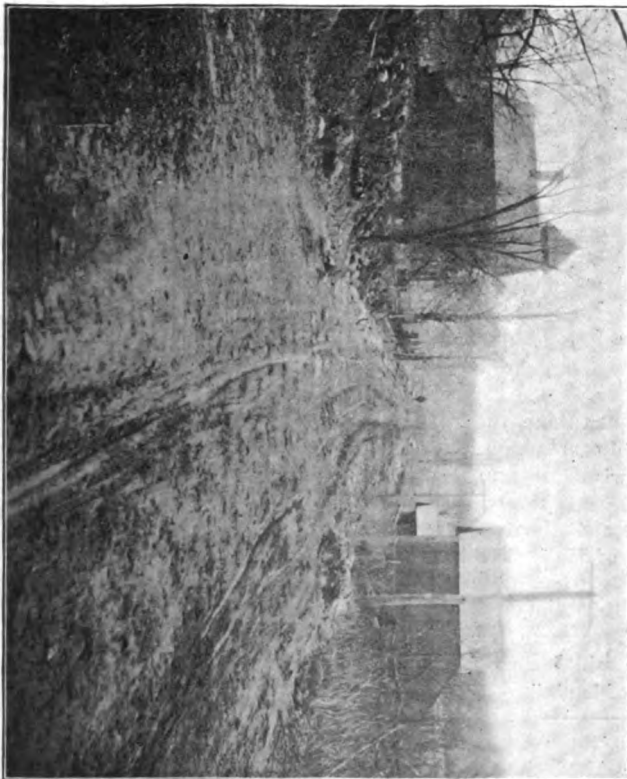

STANHOPE-NEWTON ROAD NOW—A FINE ROAD AND BEAUTIFUL SCENERY.

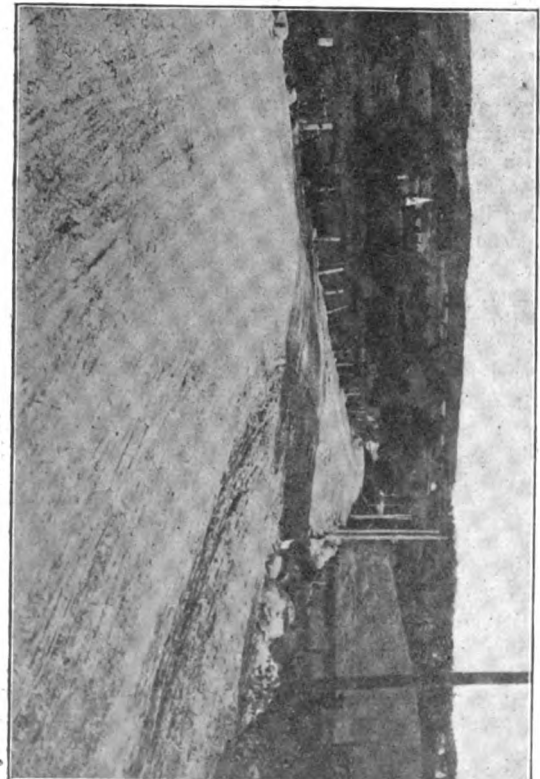

in the state, and lying east of Philadelphia, leads in the matter of rebuilding its highways, having improved 169.04 miles in the last decade. Middlesex County, on Raritan

ton, the state capitol is situated; Gloucester, south of Philadelphia and bordering like Mercer County, on the Delaware; Monmouth, on the Atlantic coast and containing

terest in which is centered in Atlantic City. Automobile owners of New York City, Newark, Jersey City, and all the great territory suburban to the metropolis, and also

of Philadelphia, Trenton and even a considerable section of New England are handicapped in the full enjoyment of the use of the many miles of superior road in New Jersey by the lack of one or more first-class roads across the great swamp separating Jersey City and all of the Bergen peninsula from Newark and the mainland west of New York. It will be of especial interest, therefore, to know what is the outlook for the construction of good roads across the meadows.

"Hudson County started out to build two expensive roads across the meadows between Jersey City and Newark," writes the commissioner in his report, "but not being able to agree with Essex County upon the kind of pavement that should be used upon the Plank road, the construction was postponed until next year. It has commenced the construction of the other road from the junction of the Newark and New York turnpike to Belleville, called the Belleville turnpike, 2.32 miles long. On account of the heavy floods and numerous accidents, only a very small part will be completed this year (1903). The cost of this construction will be in round numbers about \$54,000. As there is no material along its line, the earth for the embankments necessary to raise it above the tides has to be brought some distance by rail."

ROADS SHOWN IN THE ENGRAVINGS.

The engravings shown are from photographs of important pieces of road taken before and after improvement, and convey an excellent idea of the nature of the change that is being wrought at the rate of more than 150 miles a year throughout New Jersey. The views of the New Brunswick and Bound Brook road show a piece of new highway that forms the connecting link in a thoroughfare between two important places that was completed last year. Many motorists are familiar with this locality, and will have reason to appreciate the work done there. This new piece of road is 2½ miles long, of macadam construction 12 feet wide and 8 inches thick. It runs through a very pretty and picturesque country. The grades were heavy, but have been greatly reduced.

Ocean Grove, adjacent to Asbury Park, is a popular resort on the Atlantic coast, but is not accessible by road from the west, it being necessary to enter in a roundabout way from the north or south. Work was started last year, however, on a road that will eventually connect it with Freehold by a direct route extending northwesterly. Two of the views show the result of improvement work on a section nearly 4½ miles long extending out of Ocean Grove. Two miles of this is macadam 16 feet wide, and the rest is gravel surface of the same width.

OPENING NEW TERRITORY TO TOURISTS.

In the extreme northwestern section of the state very little road work has yet been

done, although the elevated and hilly country there is popular with summer resorters. Lake Hopatcong is one of the most popular places. At Newton, county seat of Sussex County, work has been started on a twelve-mile road to Stanhope that leads through very attractive mountainous country studded with huge boulders and watered by many springs. Country that heretofore has been almost inaccessible to motorists will soon be made the most charming for touring by the improvement of highways connecting with good roads that now extend from Newark to Lake Hopatcong.

FEATURES OF NEW STATE AID LAW.

A new state aid law passed by the legislature in 1903, which supersedes the former law, will stimulate the road work and permit of an increased mileage being constructed each year hereafter. Regarding the features of this act, Commissioner Budd says:

"The new law permits an increase of the state appropriation to \$400,000, and gives the counties the right to assess for road purposes upon their ratables to the extent of one-half of 1 per cent., exclusive of the state's appropriation, while the old law restricted the amount that could be raised for road improvement to one-quarter of 1 per cent., inclusive of the amount contributed by the state to any county, thus more than doubling the ability of the counties to build roads. The new law relieves the property holder from paying the 10 per cent. of the cost, and allows the freeholders instead the privilege of requiring the townships to pay the said 10 per cent. before accepting the petitions. The freeholders can also anticipate the appropriations to be made from the annual tax levy and award contracts at any time during the year, thus enabling them to prepare for road building during the winter months, and begin construction as soon as the weather permits, thus lengthening the road-building season. Formerly many of the most valuable months were wasted in getting ready. The new law also permits more liberal borrowing and lengthens the time of payment, gives the power to the commission to withhold the state money from those counties which do not keep their roads in perfect order, which we think will be a strong incentive to cause the roads to receive proper repairs, and simplifies the process of acquirement of land. We have often been troubled in getting possession of the requisite amount of land to straighten or widen roadbeds. A separate law has also been passed which still further facilitates the condemnation of lands."

MOTORCYCLES are vastly more popular in England than in the United States, and on holidays the roads fairly swarm with them. Doubtless one reason is that the English roads are much superior to the average American highway. Motorcycles can be purchased in most English cities on the easy payment plan.

INTEREST IN BIG TOUR.

Cleveland Motorists Expect to Make St. Louis Trip—Toledo Section Inspected.

Special Correspondence.

CLEVELAND, July 4.—There is every probability that Cleveland will furnish a very fair representation in the A. A. A. tour to St. Louis, which will pass through here August 3-4. George S. Waite, Cleveland member of the National Tour Committee, reports that Clevelanders are taking a great deal of interest in the event and that a number have promised to take part.

Another inspection was made of the section of the route between Cleveland and Toledo last week, and it was found to be in considerably better shape than was the case three weeks ago when Mr. Waite and party went over it. Four cars took part in the last inspection trip, those participating being George S. Waite, E. Shriver Reese, Hobart M. Adams, George Collister, William McKay, Merton Phillips, Harry Edwards, Louis Newman, Jack Pechin, William F. Sayle, and F. W. Smith. The party ate breakfast in Norwalk, where a stop of two hours was made. Fremont was reached at noon and there the Clevelanders were met by members of the Toledo Automobile Club as follows: Ezra Kirk, William Van Wagner, J. P. Jackson, Jack Utz, Frank Blair, Roy Carter, Joe Duck, Benjamin Chapman, and Louis Hammersmith.

This division of the route is 121 miles long, one of the longest day's runs on the schedule. Much of it is pike road and a considerable portion macadam. A slight change has been made on the portion of the route from Cleveland to Norwalk, and instead of going through Oberlin the tourists will take the more direct route by way of Amherst. In addition to the *confetti* which will be scattered along the route, Mr. Waite will have cards printed to point directions and mark dangerous points. Arrangements have been made to provide flagmen at all grade crossings. The noon meal on this portion of the run will be served at Norwalk by several churches acting under the management of the Sprague Umbrella Company. Ten miles out of Toledo the tourists will be met by members of the Toledo Automobile Club, and that club will have charge of the run from Toledo to South Bend, Ind.

The Touring Committee announces its intention of discouraging in every possible way anything approaching speeding, or any tendency on the part of the participants to turn the tour into a series of races or an endurance contest. No restrictions as to the length of time to be occupied will be made, and even the route selected for the tour need not be strictly adhered to. With regard to the awarding of certificates for perfect runs, the committee states that registration books must be closed at 10 o'clock p.m. each day, owing to the necessity for transporting the officials to the next stopping place.

Hints to Touring Car Purchasers—II.*

Proper Care and Adjustment of a Car Upon Its Delivery from the Builder's Factory, with Explanatory Photographs.

By JOSEPH TRACY.

IF the motor misses, find which cylinder or cylinders are not functioning properly, either by short-circuiting the ignition plugs, on all cylinders except the one being tested, or by holding down with the fingers the tremblers on the induction coil, allowing only one trembler to act at a time. Fig. 6 shows the coil box on the dash opened and the fingers holding down the tremblers for cylinders one, two, and four. The coil is invariably connected so that counting from left to right the tremblers are connected with the cylinders from front to rear of the motor in sequence. Thus the trembler at the extreme left is connected with cylinder No. 1 at the front of the engine, and so on. By testing each cylinder in this way we can certainly find which one misses.

COILS WITHOUT TREMBLERS.

In machines fitted with coils without tremblers the plugs must be short-circuited in order to make the test. When short-circuiting the plugs, say with a screw driver blade, be sure to touch the metal of the motor at the base of the plug first, and the insulated terminal on the ignition plug afterward. See Fig. 7. It is best to form the habit of doing this, as should a file or spanner be used to make the test, instead of a wooden handle tool, an unpleasant shock would be received were the insulated terminal touched before making connection with the cylinder casting. See Fig. 8.

Having found the cylinder which misses or does not run at all, as the case may be, we must find the cause of the trouble, which may be chemical, electrical or mechanical, each of which we will consider in turn.

CHEMICAL TROUBLES CONSIDERED.

Chemical troubles.—Non-explosive mixture due to too much or too little gasoline being fed by the carbureter, or to a leaky induction pipe, which may admit surplus air, sufficient to make the charge too weak to explode. Impure and non-explosive mixture due to exhaust gas being sucked in through the induction pipe, caused by its proximity to a leaky exhaust pipe. This is usually very difficult to detect, as it is not often suspected. In many motors the open end of the pipe that supplies the air to the carbureter is located close to the exhaust pipe, in order to heat the air fed to the carbureter. This open end is often placed close to a flange or brazed joint of the exhaust pipe where leaks are likely to develop by the jarring of the machine. The escaping inert exhaust gas is thus drawn into the carbureter air pipe.

A non-explosive mixture may be due to

the presence of water in the gasoline, or in the induction pipe leading to the carbureter. If two or more cylinders are supplied from the same nozzle all will be affected alike by any of the foregoing conditions, the remedies for which are obvious.

POSSIBLE ELECTRICAL TROUBLES.

Electrical troubles.—When a motor misses or stops, it is in nine cases out of ten due to defective electrical ignition. This being the case, it is always best to assure one's self that the ignition is right before looking for troubles elsewhere. When there

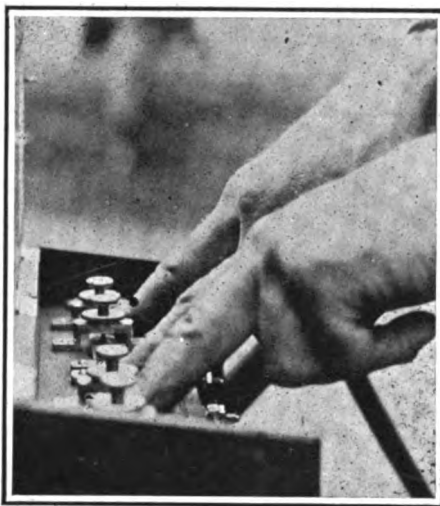

FIG. 6—TESTING THE IGNITION.

is no spark, a weak one, or a spark missed, or produced at the wrong time, it is evident the motor will not work properly.

When a cylinder refuses to explode the ignition plug should be unscrewed and cleaned, by using a stiff tooth brush dipped in gasoline. Do not use a knife or emery cloth, anything you are told to the contrary, notwithstanding. Be very careful not to bend or break the platinum points of the plug. Always take special care of a plug, recollecting that it is a piece of electrical apparatus and not intended to be handled as a rough bolt or mechanical fitting.

ADJUSTMENT OF SPARK PLUG.

When cleaned the points should be adjusted to about the thickness of a ten-cent piece for a strong battery and closer for a weak one, and then the plug connected to its proper wire and laid on the cylinder in such a way that only the metal shell—not the terminal to which the wire is attached—touches the cylinder. The switch should now be put on and the motor turned over by hand till the metal segment on the fibre disk on the cam shaft touches the brush of the cylinder under test. Before

turning the motor over, in this test, open the compression taps, or where none are provided ground the wires leading to the plugs on the other cylinders by disconnecting them from the plugs and laying the free ends in metallic contact with the cylinder castings. If this precaution is not taken it is manifest that the motor, when turned over, will commence to run on the cylinders not under examination.

NOTE CONDITION OF DISTRIBUTER.

Returning to the "missing" cylinder, note when the brush of this cylinder on the distributor (commonly and erroneously called "commutator") is in contact with the segment in the fibre disk. Then the spark should jump at the points of the plug. If not, and if the trembler on the induction coil is not buzzing, the electrical circuit is obviously interrupted somewhere. If the trembler is going and no spark results at the plug, either the plug is defective or there is a short-circuit somewhere on the high tension or secondary wire. This should be examined carefully, beginning at the plug and working back right to the binding post on the induction coil. The insulated secondary wire should not touch any metal part between its extremities, one of which is connected to the terminal on the spark plug, and the other to the binding post on the induction coil. The secondary wire should be mounted on wood, fibre or vulcanite supports. If there is no short-circuit on the exposed insulated wire, the trouble lies inside the coil box. Unless one has had a thorough electrical training, he should not attempt to repair the coil. The best course to pursue is to remove it from the machine, carefully marking each wire with a tag, and send it back to the makers. As a coil is a delicate piece of electrical apparatus it should be carefully packed in a water tight box when shipped.

WHEN TREMBLER REFUSES TO BUZZ.

When the trembler refuses to buzz on closing the switch, and the brush is on the segment of the fibre disk as already described, we must look for a break or disconnection in the primary circuit. The trembler may, however, be stuck up, or, more likely, down. A weak battery or dynamo, which is unable to magnetize the core of the induction coil sufficiently to pull it down against the spring action will cause the trembler to stick up. Again it may stick up on account of the platinum contact points fusing together, due to a too powerful battery or dynamo current.

Tremblers stick down, if the iron wire core of the induction coil is not thoroughly annealed so that it demagnetizes rapidly. The same is true of the round "armature" on the end of the trembler spring. If the trembler is free a systematic search is necessary. Begin at the brush on the fibre make and break disk. See that this brush is pressed well against the metal segment, that there is no grit or foreign matter be-

*Continued from page 4, issue of July 2, 1904.

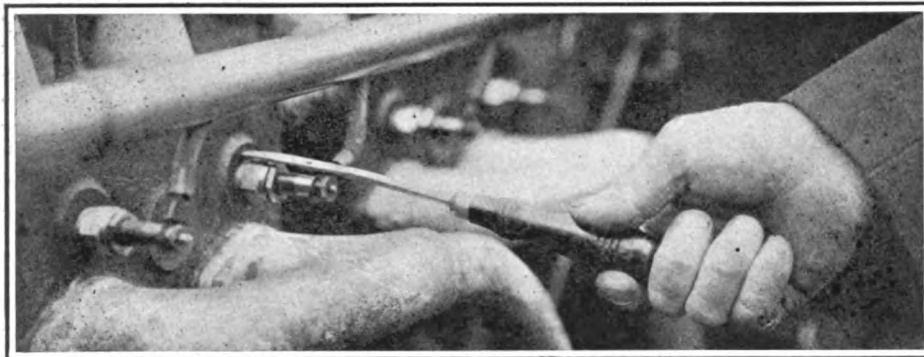

FIG. 7.—SHORT CIRCUITING PLUGS SO AS TO AVOID SHOCK.

tween it and the segment, also that the binding screws, or nuts, which connect the brush with the wire leading to the coil and battery, are tight, clean and bright, and that the wire itself is clean and bright where it is held by the binding screw or nut. Now follow the course of the wire carefully from the brush all the way back to the coil, to see that it is not broken, or that it has not shaken loose from its connection at the coil-binding post.

UNEVEN WEAR OF FIBRE DISK.

Another cause of missing in cars having jump spark ignition, is the uneven wear of the fibre disk on the cam shaft, though, of course, this is not likely to be the case in a new car. When the brushes press too tightly or when mud or sand gets between the fibre and the brush, the fibre wears faster than the metal segment or contact inserted in its periphery. When this occurs the segment stands above the fibre, and when the disk is revolving rapidly the segment strikes the brushes a blow which throws them clear, and does not give sufficient length of contact to produce reliable ignition. To find whether missing is due to this defect, it is necessary to examine the disk and the segment to see that they are of equal diameters. If the fibre is worn as described it should be turned down true in a lathe, or if badly worn should be replaced with a new disk.

METHODS OF TESTING BRUSH TENSION.

To test whether the brushes are pressing sufficiently hard on the disk, it is necessary to have the motor running on one cylinder at a time. If the cylinder is missing force the brush connected with this cylinder against the revolving disk, by pressure with the finger; the cylinder will then fire

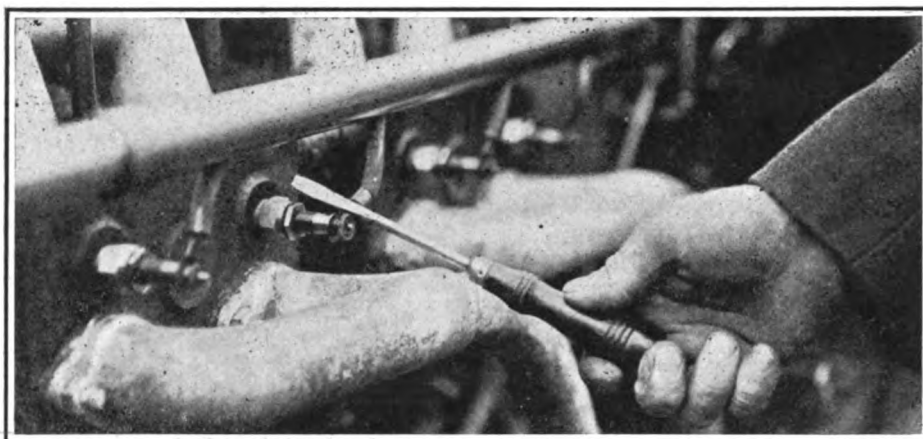

FIG 8.—INCORRECT WAY, TOOL TOUCHING PLUG TERMINAL FIRST.

regularly if the missing is caused by insufficient brush pressure. If not, the trouble is elsewhere. If the brushes do not bear firmly enough to insure regular ignition, they should be readjusted to give greater pressure on the fibre disk, taking care, however, not to put on too much

tension, as this would cause rapid wear of the fibre disk. A good indication of faulty brush action is excessive sparking when the motor is running. Where the brushes are round and made from copper gauze, similar to small electric fan motor brushes, it is necessary to see that they are not stuck in the tubes in which they slide, and that the helical springs which push them against the revolving disk have sufficient tension to insure good electrical contact.

NON-VIBRATING COILS.

Motors fitted with a non-vibrating coil and mechanical trembler instead of the fibre disk and brushes will miss if the trembler has not sufficient length of contact, especially at high speeds of revolution. The proper length of contact to prevent missing can be found, when the motor is running, by moving the adjusting screw toward the trembler blade until the missing ceases. Do not get the latter too close, or it will make

matters worse. The thickness of a visiting card will be found about the proper distance. When adjusting mechanical tremblers bear in mind that every change in the distance between the blade and the contact screw alters the time of ignition, because with mechanical trembler systems the spark is produced at the "break" while with others, which have tremblers on the coils, the spark is produced at "make."

EXAMINING ALL SPARK PLUGS.

After locating and correcting the trouble in the cylinder which has fired irregularly or "missed" fire altogether, it is well to examine visually the sparking of the plugs of all the cylinders. In Fig. 9 the method employed in examining the plugs in a four-cylinder motor-in-front car is shown. It will be noticed that the plugs are laid on the exhaust pipes and connected as though they were in place on the cylinders. They are laid out so that neither the terminal, nor sparking ends make contact with the metal of the motor. The current is thus free to follow the same path as it does when the motor is running and is not short-circuited. When the plugs are in

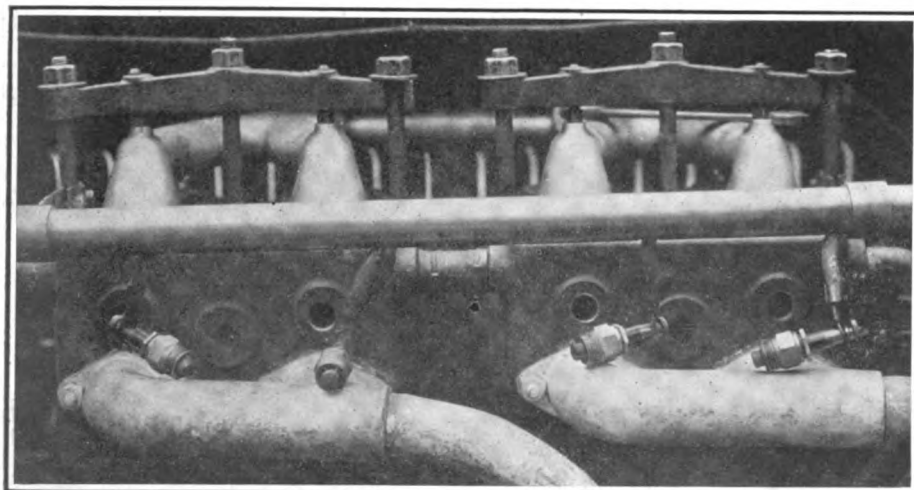

FIG. 9.—PLUGS LAID OUT FOR INSPECTION OF JUMP SPARK.

this position, and after the ignition switch has been turned on, the motor should be turned over by an assistant, and the time and strength of each spark noted. This test should, of course, be made in a shaded place so that the spark can be readily seen.

PROBABLE MECHANICAL TROUBLES.

Mechanical troubles.—Weak or broken springs on either exhaust or intake valves will cause missing. Bent valve stems will also cause it, or pieces of grit or metal which may get between the valve and seat. Leaky gaskets on the ignition plugs, or on the plugs which close the intake or exhaust valve chamber may not cause missing, but will greatly reduce the power of the motor. These gaskets or joints can be tested for leakage by pouring a little kerosene on them, and then running the motor. If bubbles show it is clear that there is a leak.

(To Be Continued.)

OPPRESSIVE REGULATIONS.

St. Louis Limits Speed to Six Miles and Prohibits Dripping Oil.

Special Correspondence.

St. Louis, July 2.—Owners whose machines are not provided with receptacles for catching dripping fuel oil will be dealt with by the law. An order has been issued calling attention to the ordinance requiring that all machines using gasoline, kerosene, benzine or similar oils be so provided. The authorities hold that such oils dripping on to the asphalt not only cause disintegration of the pavement and make repairs necessary, but make the surface as slippery as ice, so that a horse is likely to be thrown. The penalty for violating this ordinance is a fine of not less than \$5 nor more than \$100. It is said that many St. Louis motor cars are not provided with oil receptacles, and as a result complaints of violation have been made frequently by the street department.

St. Louis motorists say they will be ashamed of their laws when the hundreds of visiting autoists come in August. They hold that the law fixing speed limit at six miles is unjust and that it is ridiculous to think of going through the parks and boulevards at a pace that a good walker can almost equal. The fight for better legislation is being pushed energetically. The large blue enameled license tags which must be suspended from the rear axles of automobiles are another bone of contention.

There is much opposition to the state law which requires an owner to take out a license in every county through which he wishes to drive. If one should desire to make a tour through five counties it would be necessary to have five different licenses.

One thing which the World's Fair will do for Missouri is that it will bring about more equitable auto laws and establish the touring car in the West.

ENGLISH automobilists are taking considerable interest in the forthcoming Vanderbilt cup race.

On the Road to St. Louis—VII.*

"Pathfinders" Reach World's Fair City After Experiences in Southern Illinois—Will Return by Southern Route.

Special Correspondence.

ST. LOUIS, July 2.—Having been told what kind of roads to expect in southern Illinois and Missouri, we were not disappointed when we encountered the black, sticky mud that has made these states famous, especially as it added another and interesting chapter to our experiences en route from New York to St. Louis.

From Pontiac to Springfield, marked on the endurance run map as 94 miles and measuring that distance by the railroad, is in reality 121.3 miles and from Springfield to St. Louis, railroad distance, 91 miles, measures by odometers (we used two of different make) 111 miles. These runs are for the most part over level dirt roads and can be made easily on scheduled

mud that threatened to engulf the car and cargo within an hour. The engine was started, the wheels spun around and we pushed behind, but with both axles buried in mud the car remained stationary. Finally the jack was resorted to and with its aid we jacked up one wheel after another and inserted planks underneath them. But the only two planks we had were soon buried in the muck. As a last resort, tackle and blocks were gotten out and by attaching the double pulley to a telegraph pole and the single pulley to the front axle, we were able, with all three of us applying our strength, to haul the *Pathfinder* foot by foot through this bog, with axles and machinery dragging in the muck and finally



PROGRESS STOPPED BY A MUD HOLE IN THE ROAD NEAR LITCHFIELD, ILL.

time if the weather is dry. Should it rain hard for a day or two, however, no automobile ever made could get through on schedule time.

MIRIED IN AN ILLINOIS TOWN.

The worst stretch of roadway we traversed on this entire trip was the city streets of Litchfield, Ill. Two hours were spent in extracting our car from mud holes within the city limits. Monroe street especially was a mire apparently without bottom. We dodged the worst places and rushed the mud holes, two of us frequently getting out and applying our shoulders to the rear of the car. In this way we got along without getting stuck until just as we entered the city limits, when we landed fair and square in a patch of black Illinois

reached a hard spot where we were able to resume our places in the car.

Constantly alert to jump out and push, we ran within sight of the hotel, when in we went again in mud inches over the hubs. Most of the inhabitants of the town assembled to watch us extract the car, no one offering any suggestions or volunteering aid, which would have necessitated their getting in the mud over their shoe tops. Once more we rove our tackle, a stone hitching post offering a convenient anchor, and again dragged the little machine to firm ground.

When we finally pulled up in front of the Litchfield hotel our twenty-eight inch wheels were completely filled between the spokes with black mud, and the car attracted more attention than a circus wagon, while the blocks and tackle, searchlight,

* Continued from page 15, issue of July 2.

speedometer, odometer, all came in for a full share of attention.

AUTOMOBILES ARE A CURIOSITY.

Automobiles are rarely seen in the region between Springfield and St. Louis, the roads, as a rule, prohibiting their usage. In several of the little towns the inhabitants gathered around us and looked over the machine with a great deal of curiosity, telling us that it was the first automobile that had ever stopped at that place, although an occasional one passed through that section. The inhabitants were very ignorant regarding an automobile and its equipment. The suggestion by one village sage that the extra tire in the black tire case strapped on in front was a life preserver and that the goggles strapped across the visors of our caps were lamps to be used at night were generally accepted as facts by the rural populace, while it seemed to be the general verdict that our tires were solid rubber, our speedometer a patent clock and that our car or any other automobile was capable of traveling sixty miles an hour easily.

ROADS LAID BY COMPASS.

Roads in the level West are run straight east and west and north and south, and as St. Louis is a little west of south from Chicago, we had to travel a zigzag course, necessitating covering much more mileage than if we had been able to find a road running southwest.

Illinois fences differ from any we had previously seen. In the Catskill region the fences were stone walls; in Western New York we found stump fences; in Ohio we passed miles of wire and barbed wire; in Indiana the fences were made of oak rails, and in Illinois they are hedges. For mile after mile the farms on either side of the highway are hemmed in by hedges—great thorny barriers that keep the most fractious horses or cattle out of the grain and completely hide the fields from view.

Fifteen miles south of Springfield bog holes covered with water brought us to an abrupt stop, making further traveling over that road with an automobile an utter impossibility. Where a team of horses cannot haul a single buggy, an automobile has no business to venture. A detour of a mile took us around this spot and put us back on the road once more.

FIVE-FOOT WAGON TREADS.

Throughout southwestern Illinois the tread of the wagons is about four inches wider than standard tread in the East. This means that touring automobilists must drive with the wheels on one side out of the worn track, which naturally means heavy wheeling. If the road is badly cut up, two of the wheels will sink deep in ruts while the other two remain on high ground, and if the axle is not very strongly trussed the wheels are likely to spread, springing the axle.

Too much cannot be said about the advantages of carrying a compass when tour-

ing. In the East one is directed to turn "right" or "left"; in the West it is always "north," "south," "east" or "west." Near midday, or when it is too cloudy for the sun to be seen, it is not always easy to tell the points of the compass.

Mules are more frequently met in southern Illinois and in Missouri than are horses and they act differently, either bucking in the harness or sitting down in the road when an automobile approaches. Several times during our trip mules wheeled so suddenly that before we could shut down the engine they had turned completely around in the harness and were facing their driver. Occasionally a mule that was being led behind a wagon or that was harnessed up loosely would kick at the automobile as we approached.

PRACTICE OVERCHARGING FOR STORAGE.

Overcharging for the night's storage of an automobile is a new wrinkle employed by liverymen to get even for the spoiling of their legitimate business, as they are pleased to term it. We have been asked to pay as high as \$2 for allowing our machine to stand under a shed during the night. Traveling motorists will do well to ask how much they are expected to pay before leaving their machines in a livery stable for the night. The usual charge for keeping a horse and wagon is twenty-five cents or half a dollar. Fifty cents is generally asked for storing an automobile, but some liverymen have no hesitancy in asking \$1 or even \$2, and if a price has not been fixed beforehand there is nothing to do but pay what is demanded. The liverymen at both Morris and Springfield, Ill., overcharge.

At Joliet, scheduled for the noonday stop, and Pontiac, scheduled for the night stop on August 8, the hotel keepers are making ample arrangements to take care of the tourists properly. At Litchfield, the noon stop on August 10, accommodations are fair, and at Edwardsville, about thirty-five miles nearer St. Louis, the Hotel Leland furnishes excellent meals, the proprietor being especially interested in automobiles.

ARRIVAL IN ST. LOUIS.

We went into St. Louis across a toll bridge, paying 35 cents for the automobile, and once more saw license numbers decorating the rear of automobiles, visiting motorists having special numbers. The regular license for automobiles in St. Louis is \$10 a year, with an additional \$2 if a county license is taken out. Dealers are obliged to take out licenses, but may use the same number on different cars, providing only one car bearing that number is in use at any one time. This heavy tax on the use of automobiles has hurt business to some extent. If the money went for the betterment of highways or even for lighting some of the thoroughfares used most by the autoists it would not be so bad, but no one seems to know just where this \$10 or \$12 tax goes. Thus far we have not

attached a visitor's number (fee \$5) to our car and trust we will not have to do so before leaving St. Louis next Tuesday morning to return to New York via Indianapolis, Columbus, Wheeling, Pittsburg and Philadelphia.

"PATHFINDERS" TO REPEAT THE TRIP.

So pleasant has been our trip that should the homeward run be completed without serious accident, the *Pathfinder* will enter the big tour and go over the same course again in company with the New York City division scheduled to start from Weehawken on July 26.

The trip over the Catskill Mountains, through Binghamton, Bath, Batavia, Buffalo, Erie, Cleveland, Toledo, Chicago and Springfield to St. Louis, registered just 1,424.4 miles. The day runs as scheduled by the American Automobile Association have been found to be proportionally right, and the fact that a little Elmore touring car of 8½-horsepower and 1,200 pounds weight has completed the journey when road conditions were far from their best clearly demonstrates that small cars can be entered in the July and August run planned by the A. A. A. with every chance of getting through every control on scheduled time. Our car, originally constructed for two people, carried a tonneau and third person in addition to about 300 pounds of baggage and equipment, bringing the total weight to nearly one ton.

The experiences of three newspapermen, the crew of the *Pathfinder*, as related weekly in these columns, show some of the pleasures and what hardships may be expected in a tour of this length and what supplies and equipment are essential for so long a journey. The fact that a return to St. Louis in the same car is anticipated after the homeward trip has been completed and that the tourists are willing to meet again face to face every obstacle encountered on the trip shows the fascination that there is in automobile touring.

PERCY F. MEGARGEL.

PROPOSED CHICAGO LAWS.

Special Correspondence.

CHICAGO, June 27.—The judiciary committee of the Board of Aldermen has decided that the speed limit for automobiles shall be ten miles an hour, that no person under eighteen years of age shall be allowed to drive a car, and that each machine must be numbered.

Two ordinances submitted, with these changes, have been recommended for passage. One measure abolishes the old automobile license and substitutes an identification card, which is to be taken out by the applicant after examination by the board of automobile registry. The composition of this board is to remain as at present, including the city electrician and engineer and the health commissioner. The first card is to cost \$3, and annual renewals \$1. Persons of reckless dispositions and those subject to the misuse of liquors or stimulants are barred from the control of automobiles.

The second ordinance provides for the numbering of automobiles with a sheet of aluminum stamped by the city with a number to correspond with the identification card.

Royal Touring Car.

The large touring car shown in the accompanying illustrations, which is built by the Royal Motor Car Co., successor to the Hoffman, is a good example of how an up-to-date car of high power can be built for a moderate price. It has a four-cylinder motor of 5 inches bore and stroke, rated at 35 horsepower at 1,000 r. p. m., and said to weigh complete less than 500 pounds. It has a pressed steel frame, shaft drive and sliding change gears, and is stated to weigh complete, with full tanks, a little under 2,800 pounds.

Coming to details, the frame is made by the Federal Mfg. Co., of the usual channel section with tapering ends, and has four cross members. Besides the front and rear cross members, there is one under the dash, and another is dropped to carry the rear end of the false frame, just back of the gear box. The front ends of the false frame members, instead of attaching to the front cross members, attach to the side members just back of the radiator. The rear spring hangers are formed by carrying the side members back and down, and reinforcing them by forgings riveted to the rear cross member and into the side channels. Semi-elliptic side springs are used, and the front springs are shackled at the front instead of the rear ends, an arrangement found in several other cars as well.

The motor cylinders are cast in pairs, and the inlet valves are automatic. The two bell-mouthed branched pipes which convey the mixture also hold down the inlet valve cages, and are released by slackening the three nuts on the yoke straps shown and giving the latter a quarter turn. The crank shaft has three long bearings with ring oilers and oil pockets in separate caps



FOUR CYLINDER THIRTY-FIVE HORSEPOWER ROYAL TOURING CAR.

above them, to catch the splash. By making the caps separate from the upper half of the case, the bearings can be fitted to the shaft

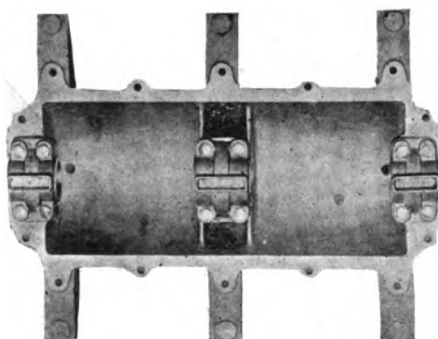

LOWER HALF OF CRANK CASE.

without assembling the whole case. A pinion and rawhide gear drive the cam shaft, and the pump and a Crandall lubri-

cator are also worked by pinions from the cam shaft.

A governor of the usual type acts on a throttle valve in a carbureter similar to the De Dion. By pressing an accelerator pedal the governor can be forced out of action altogether; and by shifting a small lever next to the spark lever on the steering column an auxiliary governor spring has its tension increased or reduced, thus necessitating a higher or lower speed to close the throttle.

The commutator, on the front end of the cam shaft just back of the radiator, is of simple and durable construction. It is so arranged that there is no contact between the brush and the internal fibre ring in which are set the four metal contact points. Thus there is no chance for current leakages or for "jumping" of the brush. The fibre case has a glass front, and is filled solid with grease. Storage cells and separate coils are employed.

The clutch is of the usual conical leather-faced type, without end thrusts when in action. The male portion of the clutch turns on an extension of the crank shaft, ensuring alignment of inner and outer clutch surfaces. A loose jaw coupling, allowing for spring in the frame, connects the clutch with the first gear shaft.

As the photograph of the change gears shows, the drive is direct on the high speed, the claw teeth projecting rearwardly from the driving pinion entering notches in the smaller of the two sliding gears. These latter are shown in their neutral position, whence a forward movement engages the second speed and a rearward movement the first. The rearmost position of all engages the large sliding gear with an intermediate pinion in constant mesh with the rearmost pinion on the jack-shaft. This gives the reverse.

The separate detail of the propeller shaft gives a good idea of the form of universal joint used. The square swivel blocks are

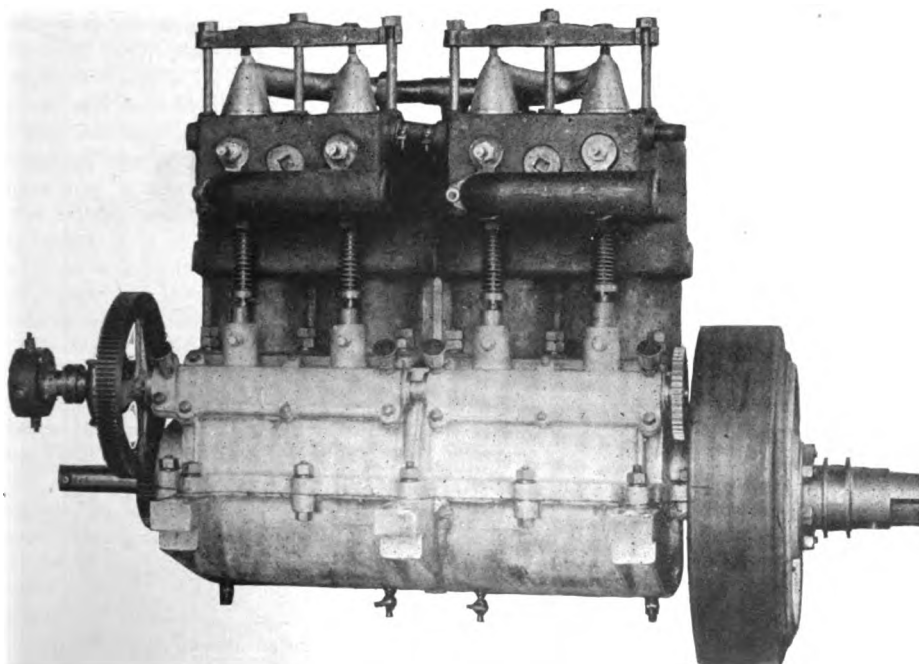

FOUR CYLINDER FIVE-BY-FIVE MOTOR OF ROYAL TOURING CAR.

slipped between jaws very like those of the first gear shaft, and the sleeve surrounding the jaws keeps the blocks in place. Thus no separate telescope joint is required, the blocks themselves slipping as needed in the jaws.

The casing in the center of the rear axle is divided horizontally, and has solid ends

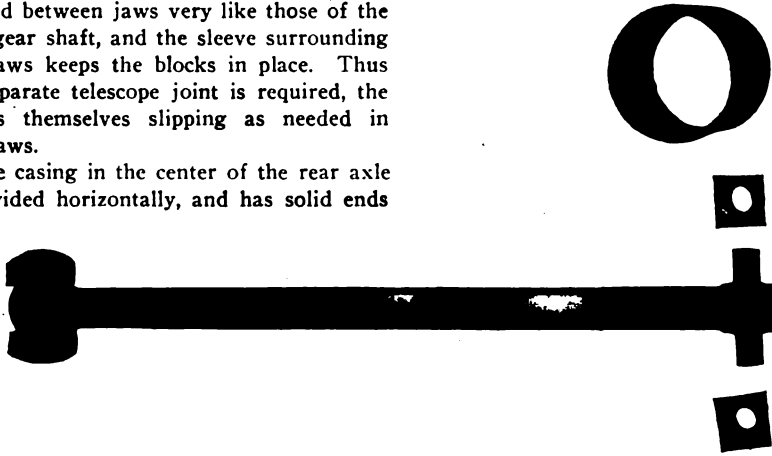

PROPELLER SHAFT AND UNIVERSAL JOINTS OF ROYAL TOURING CAR.

in which the axle sleeves are brazed. The short bevel pinion shaft runs in ball bearings fore and aft, and the axle shafts run in Timken roller bearings throughout. The rear wheel hubs are keyed on. Timken bearings are used also in the front wheels.

Both the pedal or service brake on the back gear shaft and the rear hub brakes are double-acting, bronze shoes acting on cast steel drums. A strut from the bottom of the axle casing to the cross member just back of the gear case steadies the axle and relieves the springs of a part at least of

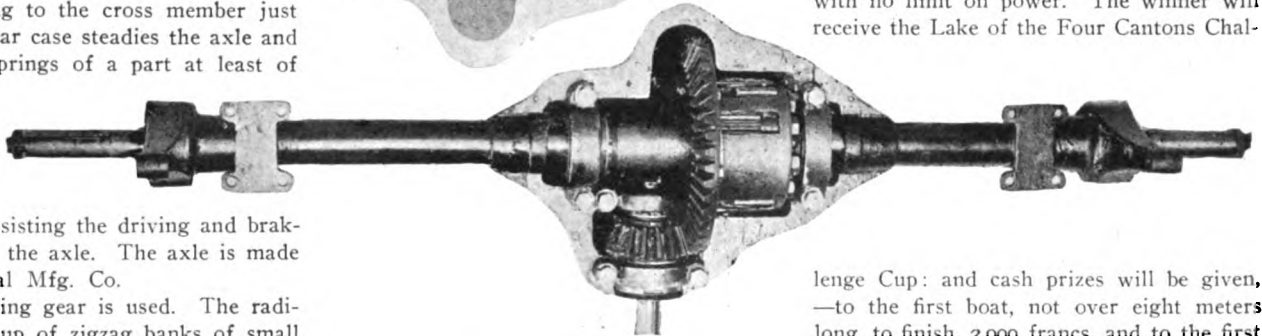
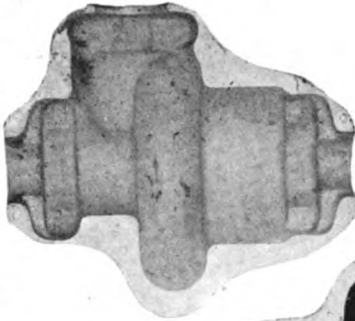

REAR AXLE AND BEVEL GEARS.

the duty of resisting the driving and braking tension of the axle. The axle is made by the Federal Mfg. Co.

Worm steering gear is used. The radiator is made up of zigzag banks of small tubes with corrugated fins, and should be very efficient. A belt-driven fan assists the cooling at low speeds. The wheels are fitted with 34 by 4 inch Diamond tires: the wheel base is 8 feet 6 inches and the gauge

54 inches. The gasoline tank is under the front seats, with the tool box below. It holds 15 gallons, and 10 gallons of water are carried.

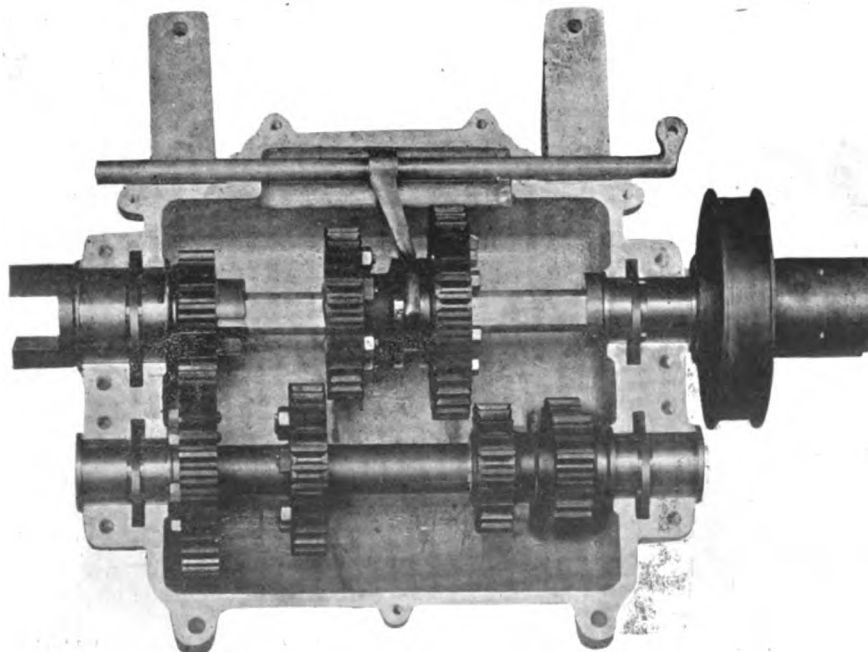

CHANGE SPEED GEAR BOX WITH COVER REMOVED.

SWISS AUTO BOAT RACES.

The Regatta Club of Lucerne will hold a series of races for auto boats on September 10 and 12, on the Lake of the Four Cantons. Since a year ago it has been investigating the merits and demerits of the different Swiss lakes for this purpose, and has fixed on the lake mentioned as by all odds the most suitable.

The course will be an irregular one, 114 kilometers in length, around the lake, and will be marked by fourteen buoys. The start will be from Lucerne.

On Saturday, September 10, will take place the races for cruisers. There will be two classes, one for boats not over eight meters (26¼ feet) long over all, of 30 maximum horsepower, and the other for boats not exceeding 12 meters (39-37 feet) and of 55 maximum horsepower. In the first event, the first prize is a cup and 1,500 francs in cash; the second and third prizes are respectively 500 and 200 francs in cash. In the second event, the first prize is a cup and 2,000 francs in cash; the other prizes are 600 and 300 francs respectively.

On the following Monday will occur a race for racers not over 12 meters long, with no limit on power. The winner will receive the Lake of the Four Cantons Chal-

lenge Cup; and cash prizes will be given,—to the first boat, not over eight meters long, to finish, 2,000 francs, and to the first boat, not over 12 meters long, to finish, 3,000 francs.

A TRICKLE of gasoline from the tank of an automobile standing near the Hotel Navarre on Seventh avenue, New York, attracted the attention of a small boy with matches and held it to the little rill of gasoline that meandered along the pavement, and his joy was great when he saw a line of flame flash up until it reached the automobile. But his happiness fled, and so did he, when the flame reached the tank and the machine became enveloped in roaring tongues of fire. A big crowd gathered to watch the blaze, and blocked traffic for a time. Hand fire extinguishers and showers of sand had no effect on the fire, which was finally extinguished by a powerful stream of water, an alarm of fire having been turned in.

The car, an expensive Panhard, belonged to H. C. Phipps, a Pittsburg millionaire. It was badly damaged, and will be an expensive piece of repair work. The accident points to a well-worn moral. Leaky gasoline tanks are an abomination always, and leaky tanks and matches are not fit company for each other.

CUP FOR HILL CLIMB CONTESTANTS.

The "Climb to the Clouds Cup" is the name given by the G & J Tire Company, Indianapolis, Ind., to the handsome silver trophy the firm will present to the machine making the best record in the Mount Washington climb, irrespective of class. The cup will be retained by the winner, and each year a similar one will be presented by the G & J Tire Company for the record maker of the year in this event. The cup, which stands nearly 12 inches high, is made of sterling silver and is emblematic of the mountains. The design is elaborate and the ornamental work embraces floral designs and etchings.

ITALIAN TOURING HANDBOOKS.

We have received from the Touring Club Italiano a copy of its handbook for the current year, a compact pocket volume giving for every town in Italy all such information as road tourists are most likely to need, as regards automobile and bicycle agencies



MT. WASHINGTON HILL CLIMB CUP.

and repair shops, hotels, physicians, photographers, the residence of the consul if any, etc. The towns are grouped by provinces, and a small map of the principal town in each province is given. The book has 696 pages, printed on thin paper, and measures seven-eighths of an inch thick.

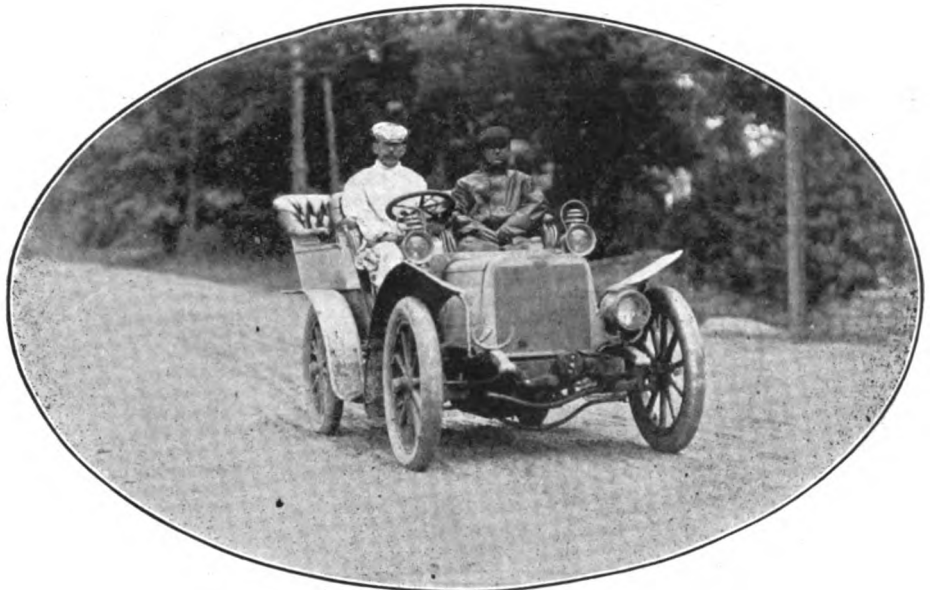

LA ROCHE AND MECHANICIAN IN DARRACQ NON-STOP RUN RECORD CAR.

The T. C. I. is also publishing for railway tourists a series of thin guide books of the principal Italian railways, describing in the conventional manner the historic and other points of interest in the several towns along each line. These are illustrated from photographs, and are sold at a nominal price. Each includes a good map of the country traversed by the railway in question, showing the leading highways. The first three, covering the lines from Milan to Verona, to Bologna, and to Turin respectively, have come to hand.

KNOX BANQUET TO THE PRESS.

The Knox Automobile Company, Springfield, Mass., royally entertained some fifty newspaper men on June 19 at an automobile trip and a banquet, and the whole party had the pleasure of inspecting the Knox factory and seeing Knox cars in all stages of construction. Incidentally there was an exhibit of samples of all the types of cars built by the concern, from the three-wheeler of 1901 up to the present day touring cars.

The occasion was the first annual meeting of the principal New England agents of the Knox concern, and the newspaper

men with whom business relations had existed were invited to be on hand. The latter were brought in Knox touring cars from New Haven, Hartford, Worcester, Middletown, Marlboro, Providence and Brockton. After going through the factory the city was explored in automobiles and the day rounded out by a banquet at Cooley's Hotel.

NON-STOP RUN RECORD HOLDERS.

The engraving at the top of the page is from a photograph of F. A. La Roche and A. J. Picard in the Darracq car used in the recent non-stop run between New York and Boston. La Roche is not content with the record of 1,053 3-5 miles without stopping the engine and says he will make another attempt should any one surpass this mileage.

An automobile parade in which nearly a score of cars took part was held in Amherst, Mass., last week, Tuesday.

C. G. Wridgway announces his intention of starting next Monday in an attempt to break the non-stop mileage record of 1,053 miles made by La Roche and Picard in a Darracq between New York and Boston. Wridgway will drive a Peerless.



NEWSPAPER MEN ARRIVING AT SPRINGFIELD AS GUESTS OF THE KNOX AUTOMOBILE CO.

Those Who Fell by the Way.

Mishaps That Prevented Some of the Gordon Bennett Cup Contestants from Finishing the Race—Analysis of Performances.

Special Correspondence.

LONDON, June 24.—The complete list of those finishing before the International cup race was officially declared ended is as follows, with the total times:

	H.	M.	S.
Théry	5	50	3
Jenatzy	6	1	28 3-5
De Caters.....	6	46	31 2-5
Rouquier	6	47	11 1-5
Braun	6	59	49 1-5
Hautvast	7	2	36 2-5
Salleron	7	15	15 3-5
Lancia	7	17	54 1-5
Girling	7	22	54 1-5
Cagno	7	23	36 3-5
Werner	7	32	15 3-5
Jarrott	7	36	52

Of those finishing late, Rouquier, who had a late start, classed fourth in the race. His time, as will be seen, was a scant hour slower than that of the winner. Jarrott came in just before the close, after an unusual series of misadventures.

The French team was the only one, all of whose members finished the race. Salleron lost twenty-three minutes fitting new links to a chain, and evidently had other troubles also, as his time was more than seven hours. The Belgian team, with cars rated at but 60 horsepower, professed to be more interested in making a record for reliability than in breaking their necks in futile attempts to match the speed of the 90 and 100-horsepower cars; nevertheless, Hautvast was alone of that trio to finish. Of the others, De Crawhez was said to have had ignition troubles, while the cause for Augieres' dropping out in the second round is not yet known.

The Opel Darracq, driven by Fritz Opel,

broke down in the first round, the reported cause being a broken cardan joint. It was the first car to retire. In the third round Cagno, the Queen of Italy's chauffeur, and Warden, the American driver of an Austrian Mercedes, also dropped out: causes not known. De Crawhez gave up at the end of that round, with his engine so hot that the gasoline boiled before it could reach the carbureter: and Edge failed to finish the fourth. The latter had had numerous troubles, which began the week before the race with a broken crankshaft, which was replaced by another taken from a duplicate engine immediately shipped from England. In the race itself a strained cylinder allowed water to leak into the crankcase, partly displacing the oil. During the second round the commutator chain came off, and bent the cam shaft in doing so. Later, owing to the bent shaft, the same thing again occurred and a new chain had to be fitted. In spite of these troubles, Edge's car was third fastest on the first round and fourth fastest on the third round. A tire puncture delayed him further, and on the last round a phosphor bronze bearing—the only one on the car—on the intermediate gear shaft seized, and he gave up at Wehrheim.

Jarrott broke a chain early in the race, and soon afterward the governor failed to work, so that his mechanic had to retard the engine by the spark when the gears were shifted, and the failure to accomplish this maneuver successfully every time led at length to one gear—the second or third speed—being stripped. An attempt to improve a governor connection failed, and, to make things worse, the radiator sprung a bad leak, necessitating taking on water at

every control, besides dashing water over the radiator to cool it. Part of the time, owing to a broken wire and bad plug, the engine was working only on three cylinders.

Girling, with the 72 horsepower Wolseley, lost time on account of dirt or waste getting into the carbureter and choking the spray passage; but in the end he made the best time of the English team, getting, however, no better than ninth place.

No accidents during the race itself involved personal injuries of consequence, for which the freedom of the course from intrusion, and the laying of the dust by westrumite, were no doubt to be credited.

Of the various contestants, Jenatzy was by far the most at home on the course. Since early spring he had gone over it again and again, till no turn or landmark was unfamiliar to him. It was said that he had been over it upward of fifty times: and he kept up his practice—presumably not at racing speed—to the very day before the race. Théry, on the contrary, had been over it but half a dozen times; and Salleron was overheard, as he arrived at Homburg only the Tuesday before the race, asking for a driver's map, so that he might study the course! Of interest in this connection was the care taken of Jenatzy's tires, squads of men at the controls meeting him with jugs of water, to be poured over the tires to cool them.

A graceful courtesy was that shown the Wolseley company by the White Sewing Machine Co., which at the Usingen control had made elaborate provision for the refreshment of the drivers and the replenishment of tanks.

The most remarkable thing, perhaps, about the race, was the astonishing regularity of Théry's running. He took on gasoline in the third round, consuming about three minutes in doing so: otherwise the variation of his time from lap to lap was a matter of seconds only,—not even of minutes, though each circuit was over 77 miles long.

The accompanying half-tone engraving is from an instantaneous photograph of Théry,

TABULATION OF PERFORMANCES OF CARS IN 1904 GORDON BENNETT RACE.

Place.	Official number.	Driver.	Description of car.	Tires.	Weight of car.	Country.	Actual hour of start.	UNOFFICIAL NET TIMES.					Average per lap.	Approximate speed.							
								A.N.	1st lap.		2d lap.				3d lap.		4th lap.	Official total.			
1	5	Théry	80-hp. G.-R.-Brazier	Michelin	kilogs 988	France.	7:28 2	h. m. s.	h. m. s.	h. m. s.	h. m. s.	h. m. s.	h. m. s.	h. m. s.	h. m. s.	m.p.h.					
2	1	Jenatzy	90-hp. Mercedes	Continental.	999	Germany	7 0 0	1:26:56	4-5	1:28:31	3-5	1:29:56	3-5	1:26:22	1-5	5:50: 3	1:27:30	4-5	53		
3	8	De Caters	90-hp. Mercedes	Continental.	1001	France.	7:42 1 4-5	1:26:56	4-5	1:28:31	3-5	1:37:46	2-5	1:28:13	4-5	6: 1:28 3-5	1:30:22	1-5	51.5		
4	18	Rouquier	100-hp. Turcat-Mery.	Michelin	1000	France.	8:52 2	2: 6:24	1-5	1:39 36	2-5	1:33 31	3-5	1:41: 6	4-5	6:46:31	2-5	1:41 37	4-5	45.5	
5	10	Braun	90-hp. Mercedes	Continental.	1001	Austria.	7:56 1 4-5	1:43:15	1-5	1:37: 0		1:30:53		1:33:54		6:47:11	1-5	1:41 47	4-5	45.5	
6	19	Hautvast	60-hp. Pipe	Continental.	994	Belgium	8:51 1 4-5	1:56:24	2-5	1:41 38	4-5	1:38:29	1 43:15	3-5	6:59:49	1-5	1:44:57	1-5	44		
7	12	Salleron	100-hp. Mors	Michelin	1001	France.	8:10 1 4-5	1:46:46	3-5	1:44:23	4-5	1:51:26	1 39:58	3-5	7: 2:36	2-5	1:45:39		44		
8	4	Lancia	65-hp. Fiat	Michelin	1005	Italy	7:21 1 4-5	1:36 57	3-5	2: 3:46		1:53 50	2-5	1:40:40	1-5	7:15:15	3-5	1:48:48	4-5	42.5	
9	9	S. Girling	72-hp. Wolseley	Dunlop	995	England	7:49 1 4-5	1:54 53		1:42:13	2-5	1:48:27	1-5	1:52:18		7:17:54	1-5	1:49:28	3-5	42.5	
10	17	Cagno	65-hp. Fiat	Michelin	1005	Italy	8:45 2 1-5	1:32:54	4-5	1:34:25	3-5	2:15:54	3-5	1:59:38	1-5	7:22:54	1-5	1:50:43	3-5	42	
11	3	Werner	90-hp. Mercedes	Continental.	998	Austria.	7:14 1 4-5	1:42:23	4-5	1:44:19	1-5	1:43:30	4-5	1:32:40	4-5	7:23:36	3-5	1:50:54	1-5	42	
12	15	C. Jarrott	96-hp. Wolseley	Dunlop	992	England	8:31 1 3-5	1:58:41	1-5	1:52:47	3-5	1:53:56	3-5	1:46:47	4-5	7:32:15	3-5	1:53: 3	4-5	41	
12	2	S. F. Edge	80-hp. Napier	Dunlop	988	England	7: 7 2	1-5	1:31 44		1:57:32	3-5	2: 0:20	1-5	2: 3:39	4-5	7:36:52		1:54:13		40.5
6		De Crawhez	60-hp. Pipe	Continental.	1001	Belgium	7:35 2	2:28:32	1-5	2:16:37	2-5	2:21:52	1-5	*							
11		Storero	65-hp. Fiat	Michelin	1006	Italy	8: 3 1	4-5	1:54:56	3-5	1:43: 5*										
16		Warden	90-hp. Mercedes	Continental.	1007	Austria.	8:38 1	3-5	2: 7:14	2-5	1:57:17	1-5	*								
13		Augieres	60-hp. Pipe	Continental.	1002	Belgium	8:17 1	4-5	2:23: 7	1-5	*										
14		Opel	80-hp. Darracq	Continental.	1005	Germany	8:24 4	2-5	*												

NOTE.—The total time for the four laps as given in the above table is that officially declared. The net times per lap are unofficial. The approximate speeds are based on a total distance of 309 miles actually traveled out of control. This is obtained by deducting the length of the controls (33 miles) from the over all length of the course as published in the official guide (342 miles).—From the *Automotor Journal*, London.

* Did not finish.

winner of the Gordon Bennett Cup race, traveling at a speed of about 80 miles an hour. The original negative is of unusual

screen of black cloth, which is placed as close as possible to the plate, and has a horizontal slit less than one-eighth inch

tion of the photograph gets the first posure, and between 1/100 and 1/50 second, roughly speaking, elapses bet

THEY, THE WINNER, GOING AT THE RATE OF 80 MILES AN HOUR IN THE GORDON BENNETT RACE.
This is a Direct Reproduction of the Largest Instantaneous Photograph of an Automobile Racer, at Such a Rate of Speed, Ever Taken and is not an Enlargement.

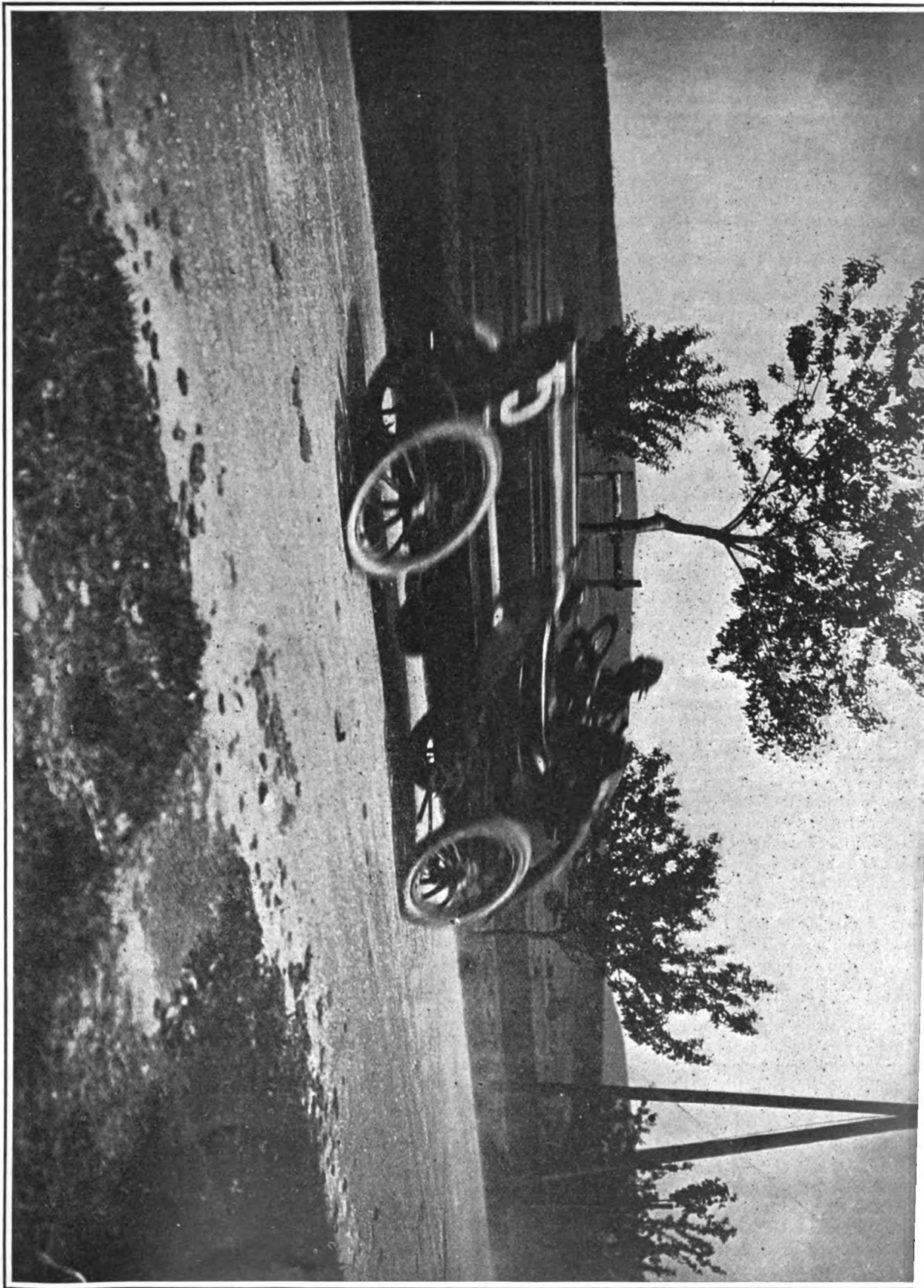

size for instantaneous work, measuring 6½ inches wide, which is made to travel swiftly from top to bottom of the plate. In the camera the image being inverted, the bottom por-

tion of the photograph gets the first posure, and between 1/100 and 1/50 second, roughly speaking, elapses bet

the photographing at close range bottom and the top of an object
(Continued on page 45.)



VOL. XI.

No. 2

Published every Saturday by

THE CLASS JOURNAL CO.,

Flatiron Building, Madison Square,
NEW YORK CITY.Cable Address - - - Autoland, New York
Long Distance Telephone - 300 Gramercy, New York

SUBSCRIPTION RATES:

United States, Canada and Mexico, - One Year, \$2.00
Other Countries in Postal Union, - One Year, \$3.00To Subscribers—Do not send money by ordinary mail.
Remit by Draft, Post-Office or Express Money Order,
or Register your letter.

FOREIGN SUBSCRIPTION AGENTS:

ENGLAND:—Iliffe & Sons, Limited, 3 St. Beide Street,
Ludgate Circus, London, E. C.FRANCE:—Boynveau & Chevillet, 22 Rue de la Banque,
Paris.

GERMANY:—A. Seydel, Mohrenstrasse 9, Berlin.

To Advertisers—Copy or changes in orders for advertisements should reach us not later than 5 o'clock p. m. Monday for the issue of Saturday following.

Copyright, 1904, by The Class Journal Company.
Entered at New York, N. Y., as second-class matter.

The Automobile is a consolidation of The Automobile (monthly) and the Motor Review (weekly).

Copies Printed This Issue, - - 12,000
“ “ Since January 1, 337,300**Hope for
Good
Roads.**

In view of all that has been said about them, it must be supposed that the character of the leading highways of New York State is as well known to the general public as it is unpleasantly known to the automobile tourist in the East. As these same roads have existed nearly as we know them now since they were first built, several generations ago, it is probable that the average man, hearing about their manifold terrors, is disposed to shrug his shoulders and say, "Oh, well, if the farmers and tourists don't care enough about having roads instead of mudholes to build roads, why should I bother myself about it?" Very likely, too, the same feeling of helplessness in the face of public apathy is the usual mood of most automobilists, even of those living "up the State," when highway improvement is mentioned.

And yet the situation, bad as it looks, holds promise of substantial reward for persistent effort properly directed. No situation is ever so bad that it might not be worse: and the highway situation of New York State is hopeful at least in the fact that the communities through which our disgusting caricatures of highways run are reasonably well supplied with this world's goods, and would profit measurably and immediately by road improvement. More than that, the numerous cities of the State, which are the principal customers of the rural districts, and as such have their own good reasons for wishing to see produce brought

cheaply to market, are well able to help the farmers to the mutual benefit. In these respects the outlook for highway betterment is far more promising here than it is south of the Mason and Dixon's line, where much of the country is too poor and too inert industrially to build and maintain stone roads.

No one can question that the benefit to the Empire State of a system of good local roads feeding the railways, coupled with a system of through stone roads connecting the principal towns, would many times repay its cost to the State as a whole. The only problem is to apportion that cost in some equitable manner on the beneficiaries of the roads. Do that, and even the much-abused but not quite calf-brained farmer will come gladly forward and pay his share.

Under the existing State aid law of New York, the only moneys available from the State treasury for road improvement are those uncalled for after the regular appropriations—including that for State aid in road maintenance—are provided for. This amounts to but a million or two a year, while the applications amount annually to much more. Unless the laws are so changed as to permit borrowing money for the purpose, New York will wait at least a generation before even one mile in ten of her 77,000 miles of highway is improved. The need is palpable, for it is a grotesque anomaly that the richest State in the Union should carry such an incubus for the simple lack of proper legislation. An amendment to the constitution, proposed by the Supervisors' Convention of 1902 to enable the State to make the necessary loan, has already been approved once by the Legislature, and if approved again next winter will be submitted to popular vote.

If the amendment is adopted the laws will have to be revised to save the money from being wasted on roads of local benefit only, or from becoming the prey of political freebooters. It will also be necessary to amend radically the laws relating to highway maintenance, to ensure that the millions spent in improving the roads shall not be lost by the neglect of the local bodies charged with their care.

Taken altogether, the situation is one which no automobilist of the Empire State, either as such or as a good citizen, can afford to ignore.

**Herr
Jellineck
Dissatisfied.**

If one may judge from an interview reported in the *Neues Wiener Tagblatt*, Herr Jellineck, of Mercedes fame, feels rather sore over the early disappearance of the Opel-Darracq from the International cup race, and the consequent failure of Germany to qualify for the Montagu trophy offered to clubs, all of whose representatives in that race should finish. After expressing his pleasure at seeing Mercedes cars get both second and third places, he said that another year, should the Deutscher Automobile Club compete for the cup, he

wanted to furnish all three cars. If the club did not concur in that view of the matter, he intimated that he might decline the partial honor, and let the club bestow it on whom they choose.

Such utterances as these do not savor of much of sportsmanship, and reflect little credit on those making them. Jellineck, threatening in advance to spoil the game for Germany if he cannot be "It," is not much more dignified than was Edge, threatening to sulk in his tent if the British eliminating committee did not do the eliminating to suit him, and giving vent to spiteful flings at his competitors on the same team. As Edge alone of the British trio failed to finish, he is doubtless now properly ashamed of his folly, and perhaps Herr Jellineck will be reminded of the obligations of a sportsman in some less mortifying way. But both incidents show the value of elimination trials about whose results there can be no chance for cavil. An out-and-out race is the most effective trial of that sort, and there can hardly be a question that France's recovery of the cup is due largely to her method of choosing the competing cars. Had two Panhards arbitrarily been put on the team, as was at first proposed, the cup would certainly now be reposing on the other side of the Rhine.

**Failure
of Dry
Batteries.**

It is not an infrequent experience with drivers of machines using dry batteries for ignition that just when thoroughly enjoying the pleasure of a trip in the country the batteries give out. If a reserve supply is not carried the driver usually waits until some more provident motorist comes along and then borrows a fresh set.

There is, however, a method by which the old batteries can be "resuscitated" which it is well to bear in mind. To accomplish this each cell should be disconnected and removed from the battery box or other receptacle in which the cells are carried. Holes should now be made in the tops of the cells, taking care not to fracture the carbons which usually project through the tops. These holes can be made with an ordinary punch or with the tang of a file or screw driver blade. Two holes on each side of the carbon will be sufficient. After the holes are made the cells should be immersed in water for ten or fifteen minutes. Stand the cells on their bases and see that the water covers them completely. After this soaking the cells can be replaced in the battery box and again connected up, taking the usual care that the connections are clean and bright and that the screws are well tightened. It will now be possible to start the motor without delay and it will run without missing.

It must not be forgotten, however, that the cells so treated will not be good for many miles, and no time should be lost in getting to the nearest source of supply of new batteries.

F. A. M. First Annual Motorcycle Meet.

An unusual number of accidents lately reported may be traced to the bad condition of the brakes. This is notably the case with touring cars out in the country, where the use of the brake can be largely avoided, but where the need for it in an emergency is likely to be great. If every tourist would take the pains each morning to see that both his emergency brake bands fitted properly, neither tight enough to drag nor too loose to utilize the greatest effort of the driver, and if, moreover, he made a practice of using the emergency brake till reaching for it became second nature to him, there would be few accidents of this sort to record. Those who contemplate long tours will find a sprag a serviceable addition to the car equipment. In cars fitted with the useful Cape cart hood this cover, whether up or down, usually prevents the driver from seeing the road back of the car. In case the brakes do not hold on a hill, and the car starts down backwards, this adds to the liability of mishap.



When touring the automobilist should be careful of whom he asks road directions. It is not safe to assume that because a farmer lives in a certain section he knows the best way to a town at some considerable distance, even if he knows the way at all. Usually his road knowledge is very limited when his opportunities are considered. The only safe plan is to inquire the way from persons of the professional classes or those engaged in trade in the towns whose business compels a knowledge of the roads. A good map is, of course, the best guide as to direction, and yet, in the nature of things, it must be unreliable as to road conditions, which depend on the weather and local activities or inactivities in road making. A little delay in procuring accurate information, when in doubt, will in the end often save a lot of time which would otherwise be spent in taking the wrong road and then retracing one's way.



Emperor William of Germany showed just the right mixture of patriotism, tact and sporting enthusiasm when, immediately after the result of the International Cup race was announced, he placed an order for a 28-horsepower Mercedes with the Cannstatt firm. It was a graceful way of telling his subjects that the loss of a few minutes in three hundred miles and more did not disgrace the finest German car.

AN auto-boat regatta has been arranged for Saturday, July 9, by the Seawanhaka-Corinthian Yacht Club, to be held in Long Island Sound over an 8¾-mile course. There will be special prizes for auto-boats making the fastest corrected time and the fastest actual time.

MOTOR boat owners at the Thousand Islands are planning the organization of a motor boat association embracing all the St. Lawrence territory. It is planned to affiliate with the American Power Boat Association and to hold races this season.

The first annual motorcycle meet of the Federation of American Motorcyclists was inaugurated on Saturday, July 2, by an endurance run to Albany, 135½ miles. There were twenty-three starters, as follows:

James White, Newark, N. J. (Light); J. M. O'Malley, Hartford, Conn. (Tribune); Walter Zeigler, Hartford, Conn. (Columbia); George M. Hendee, Springfield, Mass. (Indian); F. W. Tuttle, Hartford, Conn. (Columbia); N. P. Bernard, Hartford, Conn. (Columbia); E. M. Coates, New Britain, Conn. (Columbia); Edward Buffum, Boston (Yale-California); S. J. Chubbuch, Toledo (Yale-California); George B. Pieper, Boston (Indian); E. W. Goodwin, New York (Indian); J. J. McNevin, New York (Rambler); F. C. Hoyt, Springfield, Mass. (Indian); A. J. Banta, New York (Rambler); F. A. Baker, Brooklyn (Indian); George N. Holden, Springfield, Mass. (Indian); Oscar Hedstrom, Springfield, Mass. (Indian); G. H. Curtiss, Hammondspport, N. Y. (Hercules); J. Simonson, Mineola, N. Y. (Armac); W. Harris Latham, Brookline, Mass. (Yale-California); Frank M. Dampman, New York (Marsh); H. A. Gliesman, New York (Rambler) and G. A. Breeze, Newark, N. J. (Breeze).

At Peekskill, the first checking station, W. Simonson did not report; E. W. Goodwin retired, having met with trouble through running over a dog, and J. M. O'Malley dropped out owing to mechanical difficulties with his mount. The remaining twenty finished the run to Albany within the maximum time limit with the exception of H. H. Gliesman, who was 50 minutes late. G. A. Breeze was forced to retire on account of illness, however, leaving nineteen riders to undertake the return trip. Of this number fifteen completed the journey of 271 miles. They were as follows:

Edward Buffum, Boston; Walter Ziegler, Hartford; Geo. H. Hendee, Springfield; George B. Pieper, Brooklyn; Fred C. Hoyt, Springfield; A. J. Banta, New York;

Oscar Hedstrom, Springfield; Geo. N. Holden, Springfield; F. A. Baker, Brooklyn; James White, Newark; N. P. Bernard, Hartford; E. M. Coates, New Britain; W. H. Latham, Brookline, Mass.; Frank M. Dampman, New York; H. A. Gliesman, New York.

The run was not without its incidents and accidents, though nothing of a very serious nature was reported. H. A. Gliesman very nearly collided with a team, and in turning out to avoid the collision his machine tried to climb a tree. The attempt was unsuccessful, but the frame of the cycle was buckled, the front forks badly bent and the front tire punctured. Notwithstanding this mishap the plucky rider repaired his tire and managed to get not only to Albany, where he was 50 minutes late, but back again to New York, where, though the last to arrive, he was within the maximum time limit. Oscar Hedstrom was annoyed by a yelping dog on the outward journey, and tried to give the beast a dose of bird-shot from a revolver, holding the weapon in his right hand and aiming it backward under his left arm. Whether the dog got all that was coming to him is not known; but the wild-west shooter got part of the charge in his left arm. The wound was slight, however, and did not interfere with Hedstrom's performance in the least. Frank M. Dampman punctured a tire, but repaired it and got into Albany without penalization. Ten miles out of Poughkeepsie a number of local motorcyclists met the contestants and escorted them to the town, where a control was established.

The economy test, which was held on the glorious Fourth, was exceedingly interesting and the results attained appear to be nothing short of remarkable. Each of the seventeen starters was given one quart of gasoline and sent away from the New York Motorcycle clubrooms at 10 W. Sixtieth street, New York, over a route including the Boulevard Lafayette, at the termination of which the riders returned to the

Those Who Fell by the Way.

(Continued from page 43.)

height of an automobile. This explains the curious distortion seen in many photographs of this sort, and strikingly illustrated in the accompanying view, making it appear that the whole machine is leaning forward in the direction of travel. American expert photographers of instantaneous subjects avoid this effect by dexterously swinging the camera as the object goes by: this of course blurs the background while keeping the object photographed in its proper form.

Another point well illustrated is the blurring of the tops of the wheels, which are moving at double the speed of the car, while the points in contact with the ground are momentarily stationary. The original photograph gives the wheel a streaky effect, indicating the direction of movement of each point of the rim, but this is of course not so distinct in the reproduction.

On the Sunday after the International Cup race, the Frankfort Automobile Club and German A. C. held a race meet on the Oberforsthaus mile track at Frankfort.

Coming after the thrilling road race of two days before, the track events were decidedly tame. They were, however, enlivened by an incident not unlike many which have attended track races elsewhere, and which might easily have resulted in a number of fatalities. The race for the Peters cup had to be started thrice on account of Fritz Opel, the unlucky, and, as many thought, the incapable driver of the Opel-Darracq racer. After the start, Opel took a turn at too high speed, and when his car began to slip sidewise, instead of observing the usual precautions in such circumstances, he jammed his brakes on, and the car spun around like a top several times, breaking through the fence and nearly killing some ten spectators gathered at that point. The cup was won by Willy Poege, its then holder, who, having now won it twice, becomes its final owner.

A slow exhibition mile was made by Théry, the victor of Friday, on his second speed retarded, amid cheers.

starting point, and then went back over the same ground, repeating this until all fuel was exhausted. Edward Buffum, of Boston, riding a 2-horsepower Yale-California motor-bicycle, ran 55.3 miles before he used up his gasoline, and George N. Holden, Springfield, on a 1 3/4-horsepower Indian was second, with 49.4 miles to his credit. George M. Hendee, also on an Indian, covered 42.1 miles, which is a good showing in view of the fact that the rider weighs over 240 pounds. The expense for fuel to the rider of the winning machine was about one mill per mile. The course includes all kinds of roads, though most of them are very good, and there are some moderate grades. Buffum's record was made under difficulties, he having lost a pedal in collision with a cart, and having to ride the last part of the course with one foot in the air. The wide difference between the distance covered by the winner and that of the tailenders is quite instructive, standing, as it does, for the fact that skilful handling has a great deal to do with the performance of a gasoline motor. The entrants and distances covered follow:

Rider	Machine	Miles
Edward Buffum.	Yale-California	55.3
Geo. N. Holden.	Indian	49.4
W. H. Latham.	Yale-California	44.4
Geo. M. Hendee.	Indian	42.1
Oscar Hedstrom.	Indian	40.0
James White.	Light	*
Fred C. Hoyt.	Indian	*
F. A. Baker.	Indian	32.2
N. P. Bernard.	Columbia	30.4
H. Y. Bedell.	Indian	*
Geo. B. Pieper.	Indian	27.8
J. M. O'Malley.	Tribune	25.1
E. M. Coates.	Columbia	21.9 1/2
G. H. Curtiss.	Hercules	21.9
A. J. Banta.	Rambler	18.3
Walter Ziegler.	Columbia	20.5
H. A. Gliesman.	Rambler	13.1

* Distance not taken.

† Penalized one place for cutting course.

On Tuesday, July 5, competitions were held in hill climbing, quick starting and slow running, the hill climbing event being the most important of the day. The course was that used by the New York Motorcycle Club for its annual hill-climb on Decoration Day—Fort George hill, which furnishes as severe a test as could be desired, owing to the steepness, roughness and crookedness of the road. No pedalling was permitted, and four contestants were disqualified for infractions of this rule. Good time was made, the winner, Oscar Hedstrom, Springfield, Mass., making the climb in 1:3 3-5 on an Indian motorcycle of 1 3/4-horsepower. Hedstrom is the designer of this machine. The following are the summaries of the hill climb:

Rider	H. P. Mach.	Time
Oscar Hedstrom	1 3/4 Indian	1:03 3-5
J. M. O'Malley.	2 1/4 Tribune	1:07 4-5
H. Y. Bedell.	1 3/4 Indian	1:10 2-5
E. M. Coates.	2 1/4 Columbia	1:10 4-5
H. A. Gliesman.	1 3/4 Rambler	1:11 2-5
Fred C. Hoyt.	1 3/4 Indian	1:12
Geo. N. Holden.	1 3/4 Indian	1:13 1-5
A. J. Banta.	1 3/4 Rambler	1:15
G. M. Hendee.	1 3/4 Indian	1:25
N. P. Bernard.	2 1/4 Columbia	1:30 2-5
Walter Ziegler.	2 1/4 Columbia	1:35

James White, Newark, N. J., Geo. B. Pieper, Brooklyn, N. Y., W. H. Latham, Brookline, Mass., and F. A. Baker, Brooklyn, N. Y., were disqualified for pedalling.

The slow running contest had nothing slow about it, as far as interest was concerned. A smooth, level stretch of 110 yards at the foot of the hill was selected for this event, and the contestants did their

best to keep their machines going just as slowly as possible without stopping. It must have gone sadly against the racing instincts of the contestants. H. A. Gliesman, New York, made the best (or was it the worst?) record and won in 49 3-5 seconds. Summaries:

Rider	H. P. Mach.	Time, sec.
H. A. Gliesman.	1 3/4 Rambler	49 3-5
A. J. Banta.	1 3/4 Rambler	48 4-5
Fred C. Hoyt.	1 3/4 Indian	45
H. Y. Bedell.	1 3/4 Indian	44 4-5
W. H. Latham.	2 Yale-Calif.	43
Oscar Hedstrom.	1 3/4 Indian	42
Geo. N. Holden.	1 3/4 Indian	41 2-5
Geo. M. Hendee.	1 3/4 Indian	38 2-5
F. A. Baker.	1 3/4 Indian	35
Geo. Pieper.	1 3/4 Indian	34 2-5
James White.	1 3/4 Light	32 2-5
W. Ziegler.	2 1/4 Columbia	31 2-5
N. B. Bernard.	2 1/4 Columbia	31 2-5
R. M. Coates.	2 1/4 Columbia	28 2-5
J. M. O'Malley.	2 1/4 Tribune	26 3-5

In the starting competition competitors were required to start on signal, and time was taken from the signal to the first explosion of the engine. A maximum limit of 30 seconds was set, which, in the majority of cases, was more than ample. Each man was given two trials and his time taken as the average of the two. The times made were very satisfactory, a majority of the starts being made under four seconds, and quite a number between two and three seconds. Frederick C. Hoyt, on a 1 3/4-horsepower Indian, won, his average being 2 3-10 seconds. H. A. Gliesman, who was second in 2 4-10 seconds, made his second start in 2 seconds flat, but the first start in 2 4-5 seconds brought his average a tenth of a second higher than Hoyt's time. The following are the results:

Rider	Home	H. P.
Fred C. Hoyt,	Springfield, Mass.	1 3/4
H. A. Gliesman,	N. Y.	1 3/4
G. M. Hendee,	Springfield, Mass.	1 3/4
George Holden,	Springfield, Mass.	1 3/4
W. H. Latham,	Brookline, Mass.	2
F. A. Baker,	N. Y.	1 3/4
H. Y. Bedell,	Hackensack.	1 3/4
O. Hedstrom,	Springfield.	1 3/4
G. H. Curtiss,	Hammondspont, N. Y.	2 1/2
George Pieper,	Brooklyn.	1 3/4
J. M. O'Malley,	Hartford, Conn.	2 1/4
E. M. Coates,	New Britain, Conn.	2 1/4
N. P. Bernard,	Hartford.	2 1/4
A. J. Banta,	N. Y.	1 3/4
W. Ziegler,	Hartford.	2 1/4
James White,	Newark.	1 3/4

Edward Buffum, who made such a remarkable run in the economy test on Monday, July 4, was seriously injured in a collision with an automobile and instead of taking part in Tuesday's events was a patient in Roosevelt hospital, where he was taken after the accident.

On Wednesday morning at 5.30 o'clock the motorcyclists started on their long trip to Cambridge, Md., where they were scheduled to arrive at about 4 o'clock, Thursday afternoon. At Cambridge there will be track and road races, besides numerous social events which will make the meet a source of pleasure to the participants as well as a benefit to motor-cycling generally. A complete list of the Cambridge events was given in THE AUTOMOBILE of June 25.

One of the most interesting and important points in connection with the motorcycle week is that no repairs, other than roadside adjustments, are allowed during the entire week, the machines being placed each night in the custody of a referee. It cannot, therefore, be said that the machines were specially prepared for

any particular event, the same machines and equipments taking part in all events. The showing made thus far speaks well for the reliability of the motorbicycle and its ability to stand up under continuous hard work of all kinds.

MERGER FALLS THROUGH.

A. A. A. and A. M. L. Committees Fail to Agree on a Constitution.

There will be no affiliation between the American Automobile Association and the American Motor League, for the present at least. This announcement was made by the board of directors of the American Automobile Association after a meeting held Wednesday, in the following statement:

"The proposed merger between the American Automobile Association and the American Motor League will not take place, since the committees which were appointed to draw up a constitution did not agree, this agreement on a constitution having been made a condition precedent to the proposed merger. (Signed) H. W. WHIPPLE, "President."

The American Automobile Association secretaryship will be assumed by C. H. Gillette, who resigned that position during the early stages of the merger negotiations.

The Vanderbilt Cup deed of gift was signed at the same meeting, and Chairman Pardington, of the racing board, stated that the course for the race, which will be on Long Island will be announced September 8, the last day for making entries. The race will be run on October 8.

CLEVELAND-TORONTO CLUB RUN.

Special Correspondence.

CLEVELAND, July 4.—Fourteen cars oper-

Machine.	1st Trial.	2d Trial.	Av. Time.
	Seconds.	Seconds.	Seconds.
Indian	2 1-5	2 2-5	2 3-10
Rambler	2 4-5	2	2 4-10
Indian	2 2-5	3 1-5	2 8-10
Indian	3 1-5	2 3-5	2 9-10
Yale	3 2-5	3	3 2-10
Indian	3 1-5	3 2-5	3 3-10
Indian	4 1-5	2 3-5	3 4-10
Indian	4 2-5	2 4-5	3 6-10
Hercules	4 2-5	3 2-5	3 9-10
Indian	5 3-5	2 3-5	4 1-10
Tribune	3 2-5	6	4 7-10
Columbia	8 3-5	7	7 8-10
Columbia	8	14 3-5	11 3-10
Rambler	over	2
Columbia	3 1-5	over
Light	3 3-5	over

ated by members of the Cleveland Automobile Club left the Hollenden Hotel, headquarters of the club, at 8 A. M. Saturday on the longest run ever held by the club. The objective point was Toronto, Ontario, the party taking the main highway through Painesville, Erie, Girard, Buffalo and Niagara Falls.

Leaving Cleveland, the automobilists made their first stop at Painesville, where they waited until the entire party was assembled. After an easy jog to Ashtabula they had luncheon at the Stoll House. Going by easy stages and stopping for a short time at Girard, the tourists reached Erie, where they spent the first night. Sunday the run from Erie to Buffalo was made in good time, and after several hours at Niagara Falls the travelers went on to Toronto.

Several of the members who could not get away Saturday went to Buffalo by boat and joined the party there. Some of the party will make the return trip by road, while others will return by boat Monday evening. Many of the tourists are accompanied by their wives.

AMERICAN AND FOREIGN AUTOMOBILE AND MOTOR BOAT FIXTURES.

Automobiles and Motorcycles.

- July 8-9.—Annul Meeting Federation of American Motorcyclists. Cambridge, Md.
- July 11-16.—Mt. Washington Hill Climb and White Mountain Tour. White Mountain Roads Improvement Assn.
- July 15-23.—Automobile Week at Ostend, Belgium. A. C. C. of Belgium.
- July 16.—Race Meet at Empire City Track, Yonkers, N. Y. Empire City Trotting Club.
- July 25-26.—Circuit des Ardennes, Belgium. A. C. of Belgium.
- July 25-Aug. 10.—American Automobile Association Tour to St. Louis.
- Aug. 11.—Automobile Day and Parade at the World's Fair, St. Louis.
- Aug. 19-20.—Race Meet at Glenville Track Cleveland. Cleveland A. C.
- Aug. 21.—Summering Hill Climb, Austria. A. C. of Austria.
- Aug. 21.—World's Fair Race Meet St. Louis Fair Grounds Association.
- Aug. 22-Sept. 4.—French Industrial Vehicles Trials, Paris. A. C. of France.
- Aug. 27.—Motor Bicycle Non-Stop 100-Mile Run, British Motorcycle Club.
- Aug. 28.—Ventour Hill-Climbing Contest at Avignon, France.
- Aug. 29-Sept. 3.—Show and Track Races in Milwaukee. Milwaukee A. C.
- Sept. 2.—Chateau Thierry Hill Climb, France. A. C. of France.
- Oct. 5.—Dourdan Kilometer Trials. *Monde Sportif*.
- Oct. 8.—Vanderbilt Cup Race, Long Island, N. Y.
- Oct. 9.—Gallion Hill-Climbing Contests. France. *L'Auto*.
- Oct. 9.—Gallion Hill Climb, France. *L'Auto*.
- Oct. 16-25.—Leipzig Cycle and Motor Show, Germany.
- Nov. 20.—French 100-Kilometer Trials, Algeria.

Auto Boats and Launches.

- July 16-17.—Motor Boat Races. Ostend, Belgium.
- July 16.—Atlantic Yacht Club Races.
- July 17.—Motor Boat Run. Antwerp to Ostend, Belgium.
- July 23-25.—Motor Boat Races. Lucerne, Switzerland.
- July 26-27.—Reliability Trials for Motor Boats. England.
- July 30.—Harmsworth International Cup Race. The Solent, England.
- July 30.—Atlantic Yacht Club Races. Sea Gate, N. J.
- Aug. 5-11.—Paris-Decauville Motor Boat Race.
- Aug. 6.—Larchmont Yacht Club Races.
- Aug. 12.—Gaston-Menier Cup Race. France.
- Aug. 13.—Manhasset Bay Yacht Club Races. L. I. Sound.
- Aug. 13-14.—Calais-Dover-Calais Race. English Channel.
- Aug. 15.—Calais-Boulogne-Calais Race. English Channel.
- Aug. 18.—New York Yacht Club Races.
- Aug. 20.—Brooklyn Yacht Club Races.
- Aug. 27.—Larchmont Yacht Club Races. Long Island Sound.

ONE YEAR'S WORK.

Remarkable Accomplishment in Building up a Reputable Detroit Institution.

Special Correspondence.

DETROIT, July 4.—Twelve months ago last Saturday ground was first broken in Detroit for the new shops of the Packard Motor Car Company, then preparing for removal from Warren, O. The site where now stand buildings that give the company a floor space of more than 100,000 square feet was one year ago a vacant lot adjacent to Grand Boulevard and surrounded by acres of open prairie land. Now the new buildings of the Packard plant comprise, with their equipment of the finest machinery and tools made anywhere in the world, an ideal automobile plant that it is a positive pleasure to visit, not alone because of the systematic order of the place, but also for the superior character of the work observable in all the departments where the various parts of the automobiles are made.

It is with pardonable pride that the company looks back over its record of close onto 200 cars completed and delivered during the past twelve-month, when it takes into consideration all the difficulties it was compelled to labor under in starting their manufacture in a factory not quite complete and in perfecting an entirely new organization, in many cases looking to new sources of supply and starting the manufacture of an article different in many ways from anything that the company had previously built.

The fact that pleases the officers of the company most of all, however, is that out of all the cars that have been delivered to date from the new Detroit works, there is not one that is not giving satisfaction to its user. This is due to the untiring efforts of Henry B. Joy, of the company, early in the season. When outlining the policy of the company he decided to set the standard of quality a little higher than it had ever been placed before in this country. The first steps to procure the desired results were taken in the designing room, the next steps in the machine shops and the final steps in the inspection and testing departments, where Mr. Joy spent a large portion of his time personally superintending the work and examining the cars. Thus the product was so thoroughly looked after that all possibility of any difficulty was re-

moved. Although this was for the benefit of the purchaser, the extra testing of the cars delayed their delivery about one month behind the original schedule of the company.

The success of these first cars was so great in the hands of their owners that it was at once seen that it would be necessary to increase the organization and double the facilities to meet the probable demand. Therefore in February a night shift was started, and the day force operated until 8.30 P. M., and these have been kept going ever since. By working twenty-four hours a day the output has been increased until at the present time cars are being delivered practically upon the schedule laid out at the first of the year.

It is believed that the automobile institution which this company has developed in Detroit stands on a par for the excellence of its organization and facilities with any other motor car factory in the world, and that the product of the institution ranks with any other automobile made in the matter of design, excellence of material and workmanship and perfection of operation.

MT. WASHINGTON HILL CLIMB.

One of the features of the Mount Washington "Climb to the Clouds" is that manufacturers and dealers must sign an agreement to sell the vehicles entered by them, if desired, at the price placed upon them in making entries. The price of vehicles entered range from \$650 to \$15,000. Gold, silver and bronze medals will be given in each class, the total number of medals being seventy-two. After the hill-climbing contest a two-days' tour will take place, and medals will be given to the contestants making the best showing in point of reliability and freedom from involuntary stops. The hill climb proper commences at 6 o'clock Monday morning, July 11, and only one car at a time will be allowed on the course. Smoke rockets and telephones will be used for signalling.

ORGANIZING A. C. OF CANADA.

Special Correspondence.

MONTREAL, Can., July 4.—An organization to be known as the Automobile Club of Canada is being formed. There are now more than seventy automobiles in use on the island of Montreal and the object of the club is to educate the citizens to the

use of the machines and to secure more improved roads.

At a meeting held in the Windsor Hotel last night, the following committee was named to prepare by-laws: William Yuile, Dr. Irvine, J. H. Dunn, Frank Meighen, J. R. L. Ross, S. A. Bent, G. Boisvert, Dr. Mignault, F. C. Wilson, A. J. Dawes, Duncan McDonald, F. H. Anson, J. Pasquin, Gerald Birks, F. Redpath, George Simard, A. Berthiaume, and A. J. de B. Corriveau.

It was decided to call a general meeting in a few days, when permanent officers will be elected.

CHICAGO CLUB NEWS.

Special Correspondence.

CHICAGO, July 2.—Seven automobiles started from the Michigan avenue clubhouse of the Chicago Automobile Club this morning on the four-day run through Wisconsin. The weather was raw and chilly, and this discouraged several who had arranged to go. The run is 255 miles in length, and it is expected to finish at the country station in Evanston Monday night.

At the meeting of the Board of Directors it was decided to discontinue the special promotion committee and to charge new members henceforth admitted the full initiation fee of \$25 and semi-annual dues of \$15. During the past six months the dues of new members were remitted to July 1, the initiation fee only being required. The membership limit is again almost reached, although it was raised from 300 to 400 only a short time ago. The club is experiencing a remarkable growth, and it is rapidly taking its place as one of the most prominent clubs of Chicago.

The club is preparing to effect arrangements with some responsible firm to furnish club members with all kinds of automobile supplies at a substantial discount.

THE License and Orders Committee of the Board of Supervisors in San Francisco will probably report to the Board of Supervisors in favor of the proposed bill to establish a rate of \$2.50 for the use of a public automobile cab for the first hour for any number of passengers up to four, and \$1 for each successive half hour. The committee has had several hearings for and against the bill, in which Frank E. Hartigan, of the Mobile Carriage Co., and W. A. Scott, of the Scott-Blakeslee Co., took opposing parts, the former in defence of the charges made for the line of automobiles.

PLANS FOR AUTO DAY AT THE WORLD'S FAIR.

Parade and Luncheon Arranged for August 11—Remarkable Development of Automobiling in St. Louis This Year—Fine Cars in the Foreign Section Exhibits.

Special Correspondence.

St. Louis, July 2.—Mayor Wells, of St. Louis, and President A. B. Lambert, of the St. Louis Automobile Club, have completed arrangements for the big automobile parade which is to be held in St. Louis on August 11. The officials of the World's Fair have approved the schedule and promise to give it their support in every way possible. Resident motorists and automobile visitors are to meet at Twelfth street in St. Louis and the procession will move west on Chestnut street to Twenty-second, to Pine, and out Pine to Grand; over Grand to Lindell and out Lindell to the World's Fair grounds. A tour of the Fair grounds will be made, and the motorists will lunch at some concession restaurant, probably the Tyrolean Alps. The privileges of the Automobile Club will be extended to all participants in the A. A. A. tour. Policemen in motor cars will lead the parade.

The Louisiana Purchase Exposition officials are having three automobiles equipped with the De Forest system of wireless telegraphy, and a series of experiments will be made with them. The experiments to be made are similar to those made on ocean and lake steamers.

EXPANSION OF LOCAL TRADE.

At the opening of the automobile season this year St. Louis had three garages and 350 motor cars owned by private citizens. Of these 350 cars, 260 were light runabouts, and there was only one imported automobile in the city. Now there are fourteen repositories and nearly 1,000 motor cars, four-fifths of which are of the tonneau type. New automobile concerns are entering the field as a result of World's Fair demands. The World's Fair Auto Transit Company has two immense repositories and 200 cars. The Mississippi Valley Automobile Company has one of the oldest and largest garages in St. Louis. Its only difficulty is in getting cars for delivery. The Halsey Automobile Company experiences the same trouble. "We can sell everything we can get to sell; the only question is how to get the cars," said the manager recently. "The tonneau is the popular car in St. Louis this summer and our people will have nothing else." This company has this season sold 15 Wintons, 40 Cadillacs and has orders for 12 more cars if they can be delivered. It also sells a good many Packards. The St. Louis Motor Car Company is selling its "Rigs that Run" as fast as they can be manufactured.

The Western Automobile Company is putting up a new plant equal in size to its present headquarters. The Missouri Automobile Works, with the entire South Side to itself in the matter of location, has a substantial brick building erected for a permanent home. There is more than 10,000 square feet of floor space, giving storage room for 60 machines, as well as a completely equipped machine and repair shop. The company expects to build a car for the market next year, but this season is devoting itself entirely to World's Fair trade.

STORAGE FACILITIES INADEQUATE.

The question of storing visitors' machines this summer is occupying the attention of automobile tradesmen. The enter-

prising men who put up places for storing cars temporarily will reap a harvest during the month of August. Storerooms and repair shops are even now crowded to the limit and the present garages cannot begin to take care of the machines during August. The old De Honey dancing academy has been fitted up for a garage by the Mound City Automobile Company, and is now ready for occupancy.

FOREIGN CARS IN TRANSPORTATION BUILDING.

The foreign section shows some of the finest cars yet turned out. They are beautifully finished and perfect in details. The Mors company has five 1904 models from 12 to 24 horsepower, according to French rating. All the machines in this exhibit are fitted with Rothschild bodies. The best car is a tonneau coupé. A side-door double phaeton is also much admired. It is from 19 to 25 horsepower, has a canopy top and a glass front and back. A limousine 24 to 36 horsepower is exactly similar to the firm's demonstrating car which is kept just outside the Transportation Building. Prospective purchasers are taken through the Plateau of States and out of the grounds into Forest Park. The longer runs demonstrate the suppleness of the new automatic carbureter. Other cars shown by the Mors are a 20-horsepower tonneau which seats six passengers and a Victoria with side doors.

DE DIETRICH BERLIN LIMOUSINE.

The De Dietrich section is one of the handsomest. In it is a Berlin limousine 40-horsepower car exactly similar to a touring car built for King Edward of England. The interior of the car is finished in curly maple exquisitely inlaid. The seats are revolving leather chairs, and there is a writ-

ing desk and a folding dining table. Ten electric buttons are used to give directions to the chauffeur.

Other cars in the De Dietrich section are a 30-horsepower tonneau strongly built for American roads; one coupé limousine of 20-horsepower, a fine car for city work or travelling. Then there is a large touring car for hotel, country club, or general public service. It has accommodations for fifteen passengers and can carry 300 pounds luggage on the top. An interesting feature is a racing car built eighteen months ago for the Paris-Madrid race, in which it made a speed of 62 miles an hour, driven by Charles Jarrott. A demonstrating chassis shows all the machinery of the car and the finish of the French work. There is also a boat 27 feet long, a fine racer which is well known in Paris as the winner of eight French races.

ROTHSCHILD BODIES.

Rothschild and Sons' display is one of the features of the foreign section. All the bodies are shown on 24 to 36 Mors chasses. One coupé limousine has very ingenious disappearing seats. It takes but a second to open them and when not in use they can be put back so that the casual observer would not know of their existence. This car is particularly handsome, the interior being finished in grey Bedford cord, while the fittings and the speaking tube are of silver. The exterior is finished in majenta enamel with vermilion wheels.

Another car in this same exhibit has a King of the Belgians body with side doors and canopy top. It is painted dark brown and has claret upholstery. A landaulet limousine is shown, and so aristocratic is the car that it only needs a duchess stepping out of it to make the picture complete.

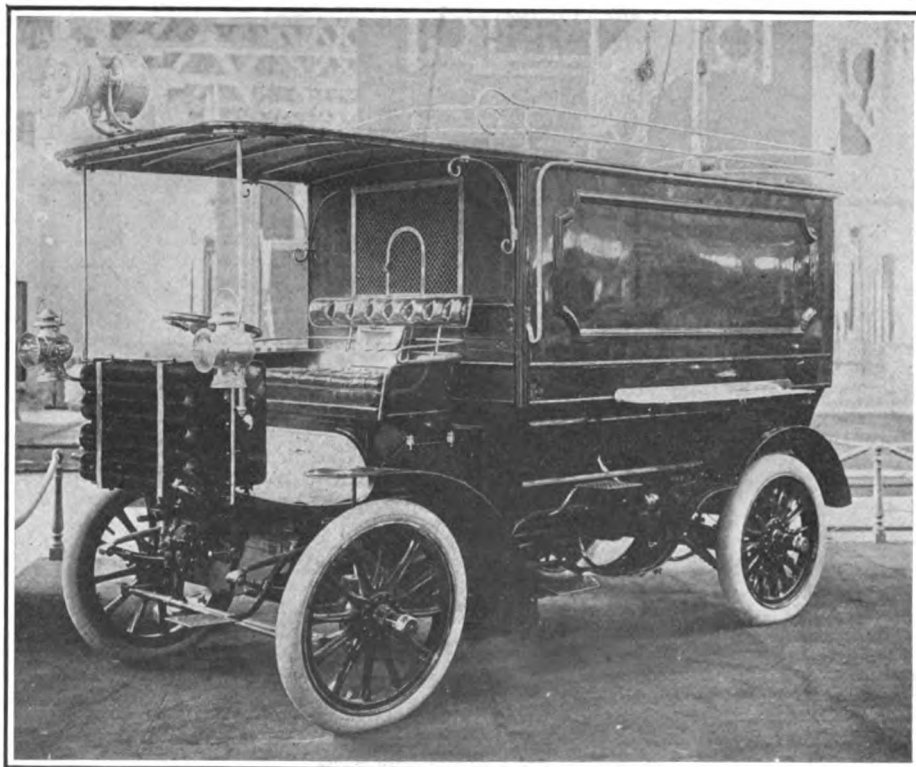

A novelty in the foreign automobile section at the St. Louis Exposition is the large Panhard bank wagon, or police patrol, shown in the accompanying reproduction of a photograph, made at the Fair. This vehicle is of a general type, useful, with slight modifications, as a police patrol wagon in city work, or a money or securities transport for banks and trust companies. It is very strongly built, and has a powerful searchlight on the roof in front.

WORLD'S FAIR RACE MEET.

Program of Events Arranged for St. Louis Fair Grounds August 21.

Special Correspondence.

ST. LOUIS, July 4.—The following program has been arranged for a World's Fair race meet to be held Sunday, August 21, on the track of the St. Louis Fair Grounds Association under the sanction and racing rules of the American Automobile Association:

First event, five miles, for vehicles weighing 881 to 1,432 pounds, for the Mississippi Valley prize, value at \$100.

Second event, five miles, for vehicles of all powers weighing 551 to 881 pounds, for the Press prize, valued at \$100.

Third event, five miles, for vehicles weighing 1,432 to 2,204 pounds for the Mound City prize, valued at \$100. Flying start.

Fourth event, five miles, for vehicles of all powers weighing 551 to 881 pounds, for the Jefferson prize, valued at \$100.

Fifth event, ten mile free-for-all, for vehicles weighing 1,432 to 2,204 pounds; first prize, the World's Fair Louisiana Purchase Trophy, valued at \$500; second prize valued at \$100. Flying start.

Sixth event, ten-mile lap race, open to all types of cars weighing 881 to 1,432 pounds. Prizes valued at \$5 to the first at the end of each mile and the Missouri Cup to the winner.

Seventh event, five-mile motorcycle race, open to all stock machines. First prize valued at \$30; second prize valued at \$15, and third at \$5.

Eighth event, pursuit race, open to all types of cars weighing 1,432 to 2,204 pounds, for the Greyhound stakes, valued at \$100.

The officials appointed for the meet are: Referee, R. W. Slusser; Judges, L. L. Fest, F. A. Nickerson and C. G. Bird; Timers, J. W. Haynes, R. E. Ingersoll and A. W. Shattuck; Clerk of Course, George W. Sherman; Assistant Clerk of Course, Charles B. Grout; Starter, E. C. Johnson; Umpires, R. D. Aldrich and E. G. Biddle.

CINCINNATI RACE MEET.

Large Crowd Applauds as Newkirk Rides Fast Exhibition on "999."

Special Correspondence.

CINCINNATI, July 4.—In spite of the fact that the brake casting on "Jed" Newkirk's 999 racer broke early in the races, Saturday afternoon at Oakley track, Newkirk risked the danger of a smash-up in his five-mile speed trial, and also took part in the five-mile handicap cup race with his injured machine. Using only two of the four cylinders, and with his dust and oil bespattered goggles laid aside, he covered the five miles, his exhibition, in 5:33 1-5.

His pluck and fast time won him rounds of applause from the largest crowd that has ever assembled at an automobile event in this part of the country. The attendance and success of the affair caused the promoters to decide to hold another race meet here in September. The directors of the County Fair, which opens at Carthage, O., have also decided to devote August 16, the first day of the fair, to automobile racing. The contests will be in charge of Charles Hanauer, who had charge of Saturday's races at Oakley.

The five-mile handicap for the Odell cup was won by Dr. H. C. Wendel in 5:37. He drove a Pope-Toledo and had a mile handicap over Newkirk, who finished third. Victor Emerson Jr., ran second in an auto-

mobile built by his father at his work shop near here.

Other events resulted as follows:

Two-mile race for motorcycles.—Frank Vormohr, first; Frank Haller, second; W. H. Ertel, third. Time, 2:58.

Two-mile open for runabouts, 1,500 pounds and under.—J. H. Stricker, first; E. C. Schumard, second; B. Donald, third. Time, 4:16 2-5.

Three-mile open for touring cars, changing passengers each mile.—Dr. H. C. Wendel, first; W. Witzenbocker, second; C. C. Walters, third. Time, 6:09.

Three-mile open race.—Dr. H. C. Wendel, first; J. H. Stricker, second; B. Donald, third. Time, 4:52.

Five-mile handicap.—Victor Emerson, Jr., first; Dr. H. C. Wendel, second; J. H. Stricker, third. Time, 8:16.

Exhibition mile against time on motorcycle.—Frank Vormohr. Time, 1:33 3-5.

The last race, a two-mile consolation, was declared off because of the lateness of the hour.

Officials of the day were: Referee, Val Dutenhofer, Jr.; Judges, Joseph Monfort, Dr. L. S. Colter and Wade Cushing; Scorers, Richard Bacon, Jr., Charles H. Waters; Clerk of Course, Sid Black; Assistant Clerk of Course, Allen W. Granger; Handicapper, Victor Emerson, Sr.; Timers, Robert Patton, S. L. Moyer, Jesse A. Lippencott; Starter, Judge T. Hodge.

RACING BOATS DAMAGED.

Bad Weather and Series of Accidents Mar American Y. C. Races.

Hard luck attended the power boat races of the American Yacht Club on Long Island Sound on Saturday, July 2, and not only the weather, but fate, seemed to be against the contestants. The wind blew and the waves piled up and slammed the light racers around unmercifully. No sooner was a delayed start attempted than William K. Vanderbilt's *Hard Boiled Egg* narrowly escaped having her shell cracked on the Scotch Cap rocks, being saved by anchoring and was unable to proceed. Then *Vingt-et-Un* took a round out of *Water Lily*, punching a hole in her just forward of the motor. This put both the colliding craft out of business for the time, the Smith & Mabley boat sustaining considerable damage to her knife-edged stem. This list of accidents was not quite long enough, however, for *Dolphin II* broke down shortly after starting and had to be towed home. This cleaned out the auto-boats entered, and the cruisers went over the course and fought it out among themselves. The damaged bow of *Ving-et-Un* was speedily repaired, but *Water Lily* was not so easily mended and is still on the stocks.

INDIAN HARBOR BOAT RACES.

The auto-boat races of the Indian Harbor Yacht Club, held on July 4, off the clubhouse near Greenwich, Conn., were a failure as races and not of much interest to the spectators, though there was doubtless plenty of excitement for the crews of the boats that had the hardihood to start. The stiff southwest wind started the white horses running and made it altogether too rough for the frail speed craft. In addition to this the *Standard*, which was expected to make a good showing, grazed Cormorant Reef while having a brush with Alfred Marshall's steam yacht *Levanter*, and knocked off a propellor blade, which, of course, put her out of the running.

Owing to the boisterous weather the course was reduced from twenty to fifteen

miles, and three boats, the *Vingt-et-Un*, *Challenger* and *Shooting Star*, lined up. First over the line was *Vingt-et-Un*, with *Shooting Star* only a yard behind and *Challenger* ten seconds later. Nothing like full speed was possible, however, and after some exhibitions of the unsuitableness of these craft for rough water, the *Challenger* and *Shooting Star* withdrew, half full of water, leaving *Vingt-et-Un* to finish the course alone, which she did in 1:6:44—good time under the circumstances.

The *Challenger* was handled by her designer, Clinton H. Crane, and *Vingt-et-Un*, by C. M. Hamilton.

JULY 4 RACES IN BALTIMORE.

Special Correspondence.

BALTIMORE, July 4.—Nearly 6,000 spectators gathered to see the automobile and motorcycle races at Electric Park this afternoon and the stands presented a gala appearance. Owing to some fault in the arrangements, the first event did not start until two hours after scheduled time, but the crowd was patient.

Howard Gill was on the ground early with his *Baltimore Cyclone*, but, to the general disappointment, he did not drive his latest steam racer, owing to the condition of the track, which he considered too heavy for his light machine. Later, in a steam runabout, he captured the one-mile race for steamers with ease in 2:19.

The five-mile motorcycle race was won by a slip of a boy, Raymond Thompson, who displayed remarkable ability in running his machine. Although his opponent had a fifteen-second handicap the lad passed him at 3½ miles, winning in 6:40 for that distance.

The motorcycle team contest between the American and the Patterson Wheelmen ended miserably. Shanklin, the best man on the American team, fell on the second lap and broke his machine. His mates refused to ride without him and the prize, therefore, went to the Pattersons.

Another cause of disappointment was the absence of William Schaum, who had intended driving an automobile of his own design and make. Many persons turned out especially to see him.

Robert Atkinson won the two-mile race for gasoline cars, best two in three heats, in a Rambler in 4:05.

ST. PAUL MOTORCYCLE HILL-CLIMB.

The first hill-climbing contest of the St. Paul Motor Club was held June 25 on Sixth street hill, St. Paul. This hill is 275 yards long, with a 12 per cent. grade for the first half of the distance and an 8 per cent. grade for the second half. It is paved with granite blocks. Each contestant was allowed only one trial, with a running start of 200 yards. The results were:

Rider.	Machine.	Time.
1st—A. J. McCollum.	Armac.	:18 3-5 sec.
2nd—E. W. Keller.	Armac.	:23 1-5 sec.
3rd—F. E. Hipkins.	Metz.	:27 sec.
4th—Arborn.	Thor.	:35 4-5 sec.

Other starters failed to finish. The Armac motorcycle ridden by the winner was a regular stock machine geared 4½ to 1 and ascended the grade at the rate of a mile in two minutes flat.

A DONATION of \$1,000 for prizes has been made by Com. H. B. Moore, of the Atlantic Yacht Club, for motor-boat races to be run July 16 and July 30 over a course of twenty nautical miles off Sea Gate, N. J., under the rules of the American Power Boat Association.



The Charleston Consolidated Railway Company has inaugurated an automobile service on the Isle of Palms.

The Detroit Motor Works, maker of the Sta-Rite spark plugs, has changed its name to the R. E. Hardy Co.

Labor Day sports in Montreal, Canada, will this year include automobile races, which will be run on the Delorimer Park track.

H. P. Grant, of the Seattle Automobile Co., Seattle, Wash., is at the head of a movement to organize an automobile club in that city.

The Montreal Automobile Exchange is a new concern in Montreal that has taken the representation of the Packard cars and is doing a rental business in addition.

Milton B. Pine and George Wolf have been appointed a committee in charge of reception and entertainment of automobilists who visit South Bend, Ind., on the St. Louis tour in August.

Receiver E. A. Potter has applied to the court for permission to advertise for bids for the sale of the assets of the Chicago Motor Vehicle Co., including the large plant at Harvey, Ill.

The Quebec legislature has fixed the rate of speed at which automobiles may travel in the province of Quebec at six miles in all cities, towns, and villages, and fifteen miles in the open country.

Twenty-two motor cars took part in a Fourth of July parade held in Allenhurst, N. J. Prizes offered by the Allenhurst club for the best appearing automobile were awarded to F. W. Woolworth and C. O. Burns, both of New York City.

Arrangements are being made for an automobile line from some point on the Sierra railroad into the Yosemite Valley. An automobile company has guaranteed to supply four cars that will make the journey at a rate of ten miles an hour. If the plan is successful, the journey from San Francisco to the famous valley can be accomplished in one day.

S. S. Olds, Jr., vice-president of the National Capital Automobile Co., of Washington, D. C., recently resigned to accept a position with the Olds Motor Works, of Detroit, and has been succeeded by E. C. Graham, president of the National Electric Supply Co. H. B. Mirick was elected a director to succeed William Hitts, also resigned. It is expected that the company will remove to its new Fourteenth street garage this week.

The Secretary of War has ordered two Winton touring cars, one for the Department of the Atlantic and the other for General McArthur, commanding the Department of California, for use in the maneuvers of the United States Army and the State National Guard in August. The car intended for the Department of California will be fitted for use as a traveling telegraph and telephone office. It will carry a folding table and complete telegrapher's outfit, including also block and tackle, six lance-poles, two box relays, one service telephone, two conductors' lanterns, eight dry battery cells, one field buzzer, two calcium carbide generators.

The Eclipse Machine Company, of Columbus, O., is getting out a new air-cooled motor, and within a short time several machines will be completed. The company is also completing a new garage on the South Side fifty feet long and two stories high. It is said that all the space has been engaged and the building may have to be enlarged at an early date.

The Maxwell & Fitch Company, of Rome, N. Y., incorporated recently with a capitalization of \$12,000, to make and sell gas and gasoline engines and automobile parts, has leased the factory building at 216 South Washington street, that city, where machinery has been installed and operations begun. The directors are: Harry B. Maxwell, Lauren M. Fitch and Christina Fitch, all of Rome.

A proposition from the Los Angeles-Pacific Electric Railway to construct the Playa Del Rey road, beginning at the Pacific Ocean end, for a distance of three and a half miles to Los Angeles, for \$8,000, has been accepted by the Automobile Club of Southern California. The road will be thirty feet wide, and the railroad company promises to complete it in ninety days.

The Federal Manufacturing Company, of Cleveland, is now employing more than 200 men in the manufacture of Berg and Meeter cars for the Berg Automobile Company, of New York. More than half of the Cleveland factory is being devoted to this work, and cars are now being completed at the rate of several a week. The Berg company has been pushing its business in the east and has made little effort to dispose of cars in the local field.

A 2,255-mile trip across the United States from south to north was completed last month for the first time in history by C. L. Joy and his chauffeur. They started from Lia Juana, in Mexico, and drove northward through mountainous and level country in California to Seattle, using a Winton touring car. Writing the Winton company under date of June 9, Mr. Joy states that they had no serious accidents and "the repairs amounted to practically nothing."

Rodgers & Co., of Columbus, O., have put through some handsome surreys fitted with two-cylinder, air-cooled engines made by the Buckeye Motor Co. The finish and upholstery are in the best style. The company expects to be prepared to supply them in considerable number this season. A drive shaft extends from the engine, which is located under the hood in front, to the rear axle. It is likely that a four-cylinder machine will be made also.

A Detroit company, styled the Detroit Steel Products Company, has been incorporated with a capital of \$50,000, and will at once engage in the manufacture of springs for automobile and railroad car use. A building, at 87-99 Fort street East, has been leased and is being fitted up in modern style for the company's use. The officers are Walter S. Russel, of the Russel Wheel and Foundry Company, president; John H. Avery, vice-president; John G. Rumney, secretary-treasurer. These officers, together with Henry Russel, president of the Olds Motor Works, and N. D. Carpenter, district manager for the Carnegie Steel Company, are the stockholders. The springs

manufactured by this concern will be dated when turned out of the shops and absolutely guaranteed for a year. While springs only will be made at first, it is expected that other parts for motor vehicles will be manufactured later.

The Cadillac Automobile Company, of Detroit, has so fully and quickly recovered from its recent fire that its shipments of cars averaged 200 a week during the month of June. Rebuilding operations are proceeding so fast that the various departments will all be settled in the new structures before fall, when work will begin on the output of Cadillac cars for next season. The Model B machine, with bonnet, has proved a very popular model this year.

The output of the Royal Motor Car Company, of Cleveland, for this year will reach 150 cars, of which about fifty will be of the large four-cylinder type. The company's success in getting out cars early has been due largely to its practice of using all aluminum bodies and baking the enamel on. The standard bodies and seats are made of sheet aluminum, which is of a smooth finish and requires no filling. The finish is brushed on and baked after each coat and it requires only from six to eight days to give the body a high and lasting finish. With the King of Belgians type of body the seats are cast. It is necessary to use a filler and the process requires about two days longer. The Royal company will build a number of four-cylinder cars of the surrey or side-door type, which is becoming popular. The wheel-base of this type will be somewhat longer than for the tonneau and the car will seat four passengers.

VEHICLE EQUIPMENT PLANT BURNED.

Fire destroyed the plant of the Vehicle Equipment Company at Thirty-seventh street and Church avenue, Brooklyn, early Tuesday morning, July 5, causing a loss estimated at \$350,000. A blaze in one corner of the one-story structure, said to belong to the Edison Company, was discovered at 4 A. M. by a watchman, who turned in an alarm from a nearby box and waited fifteen minutes before turning in a second alarm when the engines failed to respond to the first. By that time the plant was doomed.

RECENT INCORPORATIONS.

Crawford Automobile Co., Hagerstown, Md.; capital, \$35,000. Incorporators, Robert S. Crawford, Samuel B. Loose, M. P. Moller, ex-Mayor Henry Holzapfel, Jr., and J. Oscar Beard.

Lee, Cowan & Bowen Co., Syracuse, N. Y.; capital, \$50,000; to manufacture carriage, automobile and railway carriage springs. Incorporators, Edward H. Burdick and Charles H. Knapp, Syracuse, and Harold L. Stevens, Williamsport, Pa.

Mutual Motor Car Co., New York; capital, \$100,000; to deal in automobiles. Incorporators and directors for the first year, H. P. Winthrop, A. Iselin, F. C. Havemeyer, of New York.

Martin Auto Co., 208 Broad street, Elizabeth, N. J.; capital, \$50,000; to manufacture and deal in automobiles and auto-boats. Incorporators: Franklin D. Mooney, William Bryan and Geo. D. Willinger.

THE AUTOMOBILE

WEEKLY

NEW YORK—SATURDAY, JULY 16, 1904—CHICAGO

10 CENTS

CLIMB TO THE CLOUDS IN NEW HAMPSHIRE.

BRETTON WOODS, N. H., July 12.— In a chill driving mist that would compel cautious running even on a wide level road, Harry Harkness rushed Mount Washington in the Climb to the Clouds today and placed the record figures for this

pounds of mechanism up an 8-mile narrow mountain road, and to pull up just 4,600 feet above the starting point after averaging 20 miles an hour without a stop is a sure enough test of man and machine.

There were other splendid performances

magnificent performance. This he bettered next day with the same car stripped, lowering the American gasoline car record to 29:6 4-5.

Steam upheld its reputation for mastering grades when on the second day F. E. Stan-

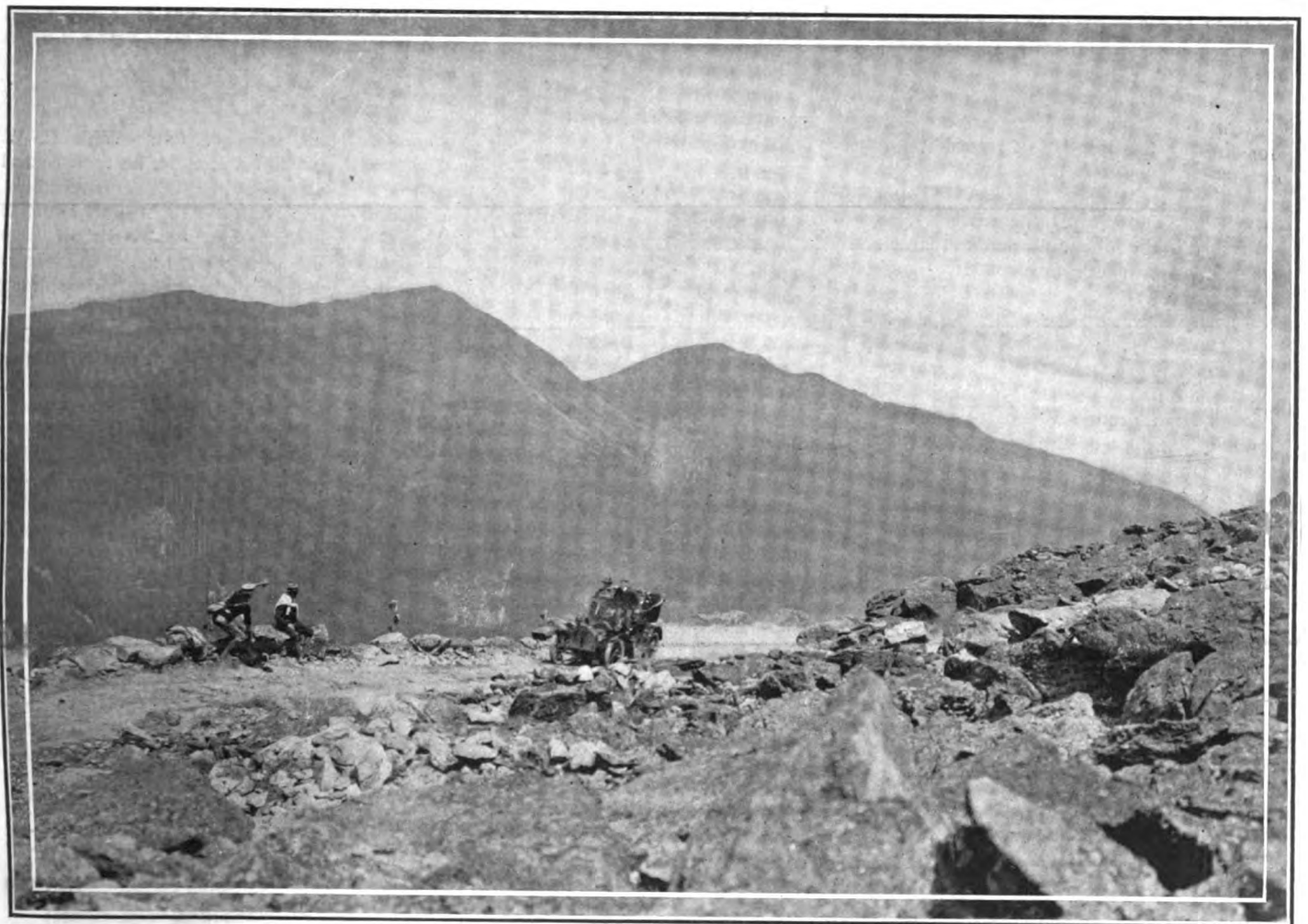

A. E. MORRISON OF BOSTON MAKING HIS REMARKABLE DASH UP THE MOUNTAIN IN A 24-HP PEERLESS STOCK TOURING CAR.

year at 24:37 3-5. Something more than the achievements of the drivers of American stock cars was to be expected from the 60-horsepower \$18,000 Mercedes, and from this comparative view the performance was not extraordinary. As a feat of driving, however, it was remarkable. To guide 2,200

that gained the cheers of the little group which gathered about the finish line in the clouds and gave the American built car a place high up in the reliability column. A. E. Morrison of Boston sent the 24-horsepower Peerless stock touring car across the lofty mark in the elapsed time of 36:44 1-5, a

ley dashed up to the line in 28:19 2-5, showing what seven horsepower can accomplish when it is put where it will do the most good.

Less spectacular and yet quite as great a mechanical triumph in its way was the performance of the Metz motorcycle driven by



JAMES L. BREESE IN HIS 40 HORSEPOWER MERCEDES ROUNDING THE TURN AT THE FINISH LINE ON TOP.

Arthur Batchelder of Lowell, Mass. When this slim, clean cut, gritty youth crossed the line in 34:11 3-5 he gave the poor man's car a more serious place in American road locomotion.

The week's program of contests and tours in the White Mountains opened on Monday with the first day of record-breaking hill climbing on Mount Washington. Delegations from New York and Boston arrived on Sunday and headquarters were established in the Mount Washington Hotel, in the pleasant valley at Bretton Woods. The Mount Pleasant House, about half way across the valley, also opened its hospitable doors to many who came down, and lying about midway between a spacious garage gave shelter to the contestants' cars.

To go from Bretton Woods to the Glen House at the foot of the eastern slope of Mount Washington meant a journey of thirty-six miles on the mountain roads for the contestants and those who wanted to see the start. A pleasant alternative for the spectators was the trip to the top of Mount Washington on the famous old rack

road, with which connection was made by the steam cars from Bretton Woods. Looking down from the top close to the finish mark, the Glen House was in view, 4,600 feet below, and a very short stretch of the road leading to the start. From the summit of the mountain a short turn in the road, less than half way down, was the only spot in the road where the cars could be seen until they were within a few hundred yards of the line.

Racing arrangements were simple, and the management good. S. M. Butler and A. R. Pardington, of the A. A. A. racing board, started and stopped the cars, alternating at the top and bottom on successive days. Timing was in the expert hands of the Chronograph Club, of Boston, and telephone communication was arranged between the start and finish, and the intermediate "two-mile," "half-way" and "six-mile" stations. Cars were usually sent away at half-hour intervals and at agreed times all those which had made the ascent were sent back to the start. To signal the start on the arrival of each car at the top smoke rockets

were to be used, but those on the ground turned out to be of the ordinary Fourth of July variety and did not push the clouds away so as to be seen from below. Charles J. Glidden, the world's touring record holder, however, established a signal service of his own invention, and so the need of visible signals was not felt. With C. W. Barron, of Boston, as aide, he took control of the telephone in the Summit House, about 50 feet above the finish line, and with a megaphone and a good pair of lungs bridged the distance between the timers' stand and the 'phone connected with the starting point.

Glen House, in the vicinity of which the start was made, stands at an elevation of 1,650 feet above the sea, and when the race is run the climber readily believes he is just 6,300 feet above high-water mark. A private road, from which automobiles are at all other times barred, is the connecting link. Its surface is sandy where the rocks do not show through and is broken in 350 different places by water bars or thank-you-mam's that bumped many a

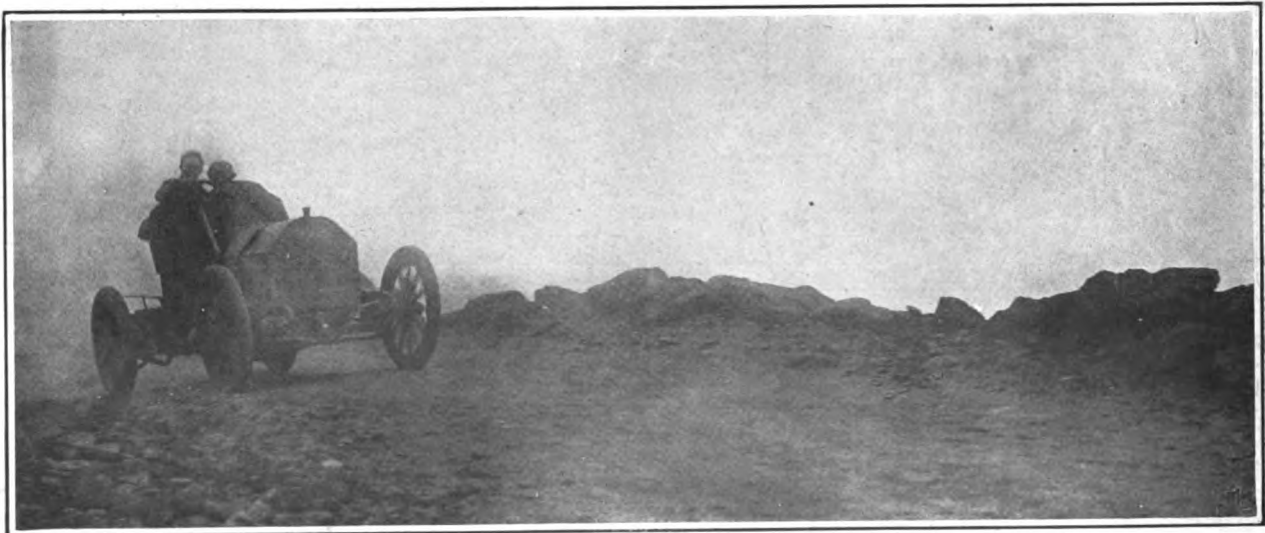

HARRY HARKNESS DASHING OUT OF THE CLOUDS WITHIN FIFTY FEET OF THE FINISH—RECORD TIME 24:37 3-5.

driver's heart out of place on the risky turns. It is a steady, motor-testing rise from the bottom to the top, with none of those convenient little down-grades that give a chance for gathering speed on the average mountain road. The stiffest grade is about twenty per cent., and the average for the eight miles of zig-zag and curves is seventeen per cent. Its average width is about twelve feet, though the surface is so uneven that it would be necessary to pull a car partly up on the inside bank to give safe passage to a car going at speed. When the timber line is passed the mountain side pitches off abruptly and a little error in steering would hurl a car and contestants several hundred or thousand feet below.

Few of the "natives" showed much interest in the trials, and, as the number of guests in the Summit Hotel was small, the "gallery" was composed chiefly of automobile enthusiasts, whose faith in the venture was highly rewarded by a succession of record-breaking feats.

HILL CLIMBING ON MONDAY.

Staff Correspondence.

SUMMIT HOUSE, Mt. Washington, N. H., July 11.—It was a dramatic moment this afternoon when F. E. Stanley, of Newton, Mass., rounded the sharp curve 100 feet from the finish line and put a record of 31:41 2-5 to the credit of his 7-horsepower steamer, nearly half an hour before James L. Breese, in his 40-horsepower Mercedes, had rushed into view and put the gasoline car figures at 34:09 4-5 the lowest of the day. Clouds had settled down on the Summit when at twenty minutes past 3 o'clock Mr. Glidden announced from the hotel platform overhead that Stanley had started up the hill. Would seven horsepower do better than forty? was the query, more sportsman-like than scientific, that caused the faithful few to group closely about the timers' table. In fifteen minutes he had passed the half-way house. Would he keep this speed to



OTTO NESTMANN IN THE STEVENS-DURYEA SWINGING ROUND A BAD CORNER.

the end. Another brief wait and then swinging around the pile of rock in a splendid flight of speed the steamer straightened for the line. In the background the jagged

who had driven down from Boston just to show how easily it could be done. A rousing cheer was given when the scorers megaphoned his time to be repeated by telephone to the crowd 4,600 feet below. He had cut the time made by his brother, F. O. Stanley, just five years ago, by more than an hour and a half.

Although Mr. Stanley's performance was the event which stands out in the greatest prominence, the series of demonstrations of hill climbing powers that led up to it served to make up one of the most remarkable competitions in automobile history. That fourteen of the sixteen cars that ascended the mountain during the day broke last year's record is an indication of the character of sport. These fourteen cars gradually lowered the mark by cuts of minutes from 1:48:00 to 31:41 2-5, giving an interest to the sport which was truly intense. Happy was the record breaker who could claim the title for a half hour.

Those who wanted to see the start had to be out of bed early, for the first car was sent up at 5 o'clock in the morning. From that time on until nearly 4 o'clock in the afternoon the cars were started by Mr. Butler without a hitch. The officials, including "Senator" W. J. Morgan, to whose initiative and persistence the splendid sport was due, were kept busy giving instructions as the score or more of competing cars arrived at the base. Local weather sharps promised a fine day, and the few showers of the day before had helped to pack the sandy course.

Record breaking began with No. 1, when Mr. Phelps left the start near Glen House in the valley and landed at the summit in 56:15 2-5. Not content with this performance, Mr. Phelps drove his car up a 25 per cent. grade to the platform in front of the Summit House and left it there as a challenge to all comers. The two cars that followed Mr. Phelps, the Cameron runabout and the Orient buckboard, met with difficulties and each took more than two hours on

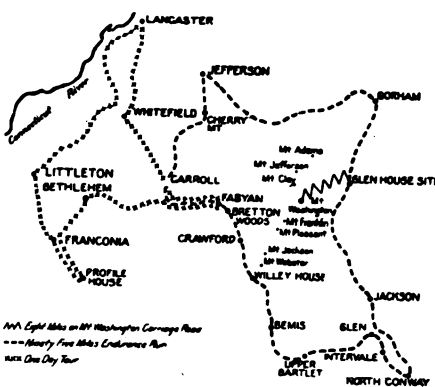

SKETCH MAP OF THE MOUNTAINS.

line of rocks that marked the edge of the precipice were silhouetted on dense and rolling masses of cloud, and at the tiller, with a smile of victory on his face, was the man



ARTHUR BATCHELDER, WHO MADE THE REMARKABLE TIME OF 34:11 3-5 ON A METZ.

the trip...As each of these cars is fitted with air cooled engines and of comparatively low horsepower the showing made was excellent.

The fourth car started was an Oldsmobile, driven by Benjamin Smith, which climbed in 1:25:14 1-5. This completed event No. 1, and the next car sent away was a Columbia gasoline entered in event No. 3. This car set the time for its class at 1:15:21 4-5. After the arrival of the Columbia at the summit, there was an intermission, Webb Jay puncturing the tire of his White steamer when half way up, and went back, and the Haynes-Apperson met with trouble in the shape of a broken valve. It kept the course, however, and finished in 1:32:25 2-5.

Just before eleven o'clock the real excitement of the day began. At 10:48:07 2-5 H. Ernest Rogers in a 24-horsepower Peerless whirled up the road and over the finish in 48:07 2-5, a serious cut in Mr. Phelps' figures. Twenty minutes later Harry Fosdick rushed in with his Winton touring car in 54:00 2-5, claiming an allowance of 4 minutes for being blocked on the road by the Haynes-Apperson car, and five seconds later Percy Pierce brought in the Pierce Arrow in 44:31 4-5, taking the laurels from Mr. Rogers. His triumph was brief, however, for in about seven minutes A. E. Morrison in a 24-horsepower Peerless touring tonneau reduced the time to 36:44 1-5. There the record remained during the forenoon. The Peerless performance kept the enthusiasts busy. The car was of the regular stock type with tonneau, and it came in grandly, the engine running with great regularity.

Alexander Winton had poor luck with his new 4-cylinder side entrance tonneau which he drove himself "to see what it could do," he afterward explained. Evidently the car had not been tuned up to record pitch, for it occupied 1:33:00 in the climb to the clouds.

There was now an intermission for luncheon at the Summit House on the top, and the Glen House below, and in this time the competing cars were sent down at short intervals, all being reported without mishap at the bottom. Brakes suffered a good deal and mechanics were kept busy wetting them down, and the strain on the drivers was even greater than coming up, the cars showing a natural desire to get out of control. As a test of mechanical construction the going down, while not as severe as the going up, was a good demonstration.

During the afternoon the interest centered on the 40-horsepower Mercedes of J. A. Breese, and the little Stanley steamer. Mr. Breese came up in fine style, but lost a trifle of time by mistaking the bend at the finish for the finish itself. His car was geared high and so he was compelled to stay on first speed, though he lost time in trying to get on second speed at several places in the road. His car reduced the record to 34:09 4-5. Mr. Breese had not enjoyed his honors much more than ten minutes, how-

ever, when they were snatched away by Mr. Stanley. Several other cars ascended the mountain during the day in slow time, and Mr. Stanley's record remained unscathed. The summary of the first day's contest follows:

RESULTS OF EVENTS CLASSIFIED BY PRICES.

SPECIAL—L. J. PHELPS OF EVENT NO. 4.

No. of Car.	Make.	Driver.	H.P.	No. of Cyl.	Weight	Price.	Time.
1	Phelps	L. J. Phelps	20	3	1,700	\$2,500	:56:15 2-5
EVENT No. 1—RUNABOUTS, \$650 OR UNDER.							
14	Olds	Benj. Smith	—	1	—	650	1:25:14 1-5
9	Cameron	E. S. Cameron	6	1	850	650	2:07:08 3-5
7	Orient	W. B. Jameson	6	2	650	550	2:09:38 4-5
EVENT No. 2—\$650 TO \$1,000							
2	Stanley	F. E. Stanley	6	2	800	670	:31:41 2-5
11	Prescott	A. L. Prescott	7½	2	1,400	1,000	1:08:34 1-5
12	Stanley	G. J. Peacock	7½	2	1,400	1,000	1:10:29 2-5
EVENT No. 3—\$1,000 TO \$1,800							
25	Columbia	H. W. Alden	—	2	—	1,750	1:15:21 4-5
5	Haynes-Ap.	Frank Nutt	12	2	1,500	1,450	1:32:25 2-5
EVENT No. 4—\$1,800 TO \$2,000							
24	Winton	Harry Fosdick	20	2	2,000	3,000	:50:00 2-5
1	Phelps	(run in special class)	—	—	—	—	:56:16 2-5
EVENT No. 5—\$3,000 TO \$6,000							
17	Peerless	A. E. Morrison	24	4	2,500	4,000	:36:44 1-5
8	Pierce	Percy P. Pierce	24	4	2,500	4,000	:44:31 4-5
18	Peerless	H. E. Rogers	24	4	1,900	3,700	:48:07 2-5
31	Winton	Alex. Winton	—	4	—	—	1:33:00
EVENT No. 6—\$6,000 AND UPWARDS							
26	Mercedes	J. L. Breese	40	4	2,200	—	:34:09 4-5

TUESDAY'S RACING EVENTS.

Staff Correspondence.

SUMMIT HOUSE, Mount Washington, N. H., July 12.—Record smashing was again a frequent occurrence to-day, and this was really the most exciting day's sport. The fastest time for the meeting, and a record that will probably stand longer than those broken this year, was 24:37 3-5 made by Harry Harkness in his new 60-horsepower Mercedes racer. He had driven by road to the base of the hill, and had punished his machine very badly. The front springs were down and on one side the upper leaf of the front spring was cracked. A good deal of time was spent getting the racer in condition and rough blocks of wood were tied to the inside of the springs to act as distance pieces. As Mr. Harkness had never been on the mountain road before it was suggested to him that he make a preliminary trial before going against time. This he said would not be necessary, and at 3:21 o'clock he was started from the bottom. His car had been fitted with suitable sprockets, and he was able to get away at good speed and held his second all the way up. He was reported at the 2-mile post at 3:27, and the half-way house at 3:32 1-2. Then the interest grew apace with various good guesses being made as to his probable time. At 3:41 1-2 the six mile post was passed, and the roar of the exhaust prepared the timers for his arrival at 3:45:37 2-5 in the record time of 24:37 3-5 for the eight miles of tortuous up grade. Some of those at the top feared that the heavy masses of cloud that seemed to envelop the entire mountain

would cause him to get off the road—to destruction perhaps. The run ~~summit~~ ^{out} an average speed of 45 miles an hour. On the way up the combination of water bars in the road and springless springs on the car made it rough going, and in places as the rear of the car slewed on the turns the wheels tipped large fragments of loose rock from the edge down the steep mountain slope. Later in the afternoon the cold fog was made more disagreeable by drenching rain and Mr. Harkness decided to go down to Bretton Woods with the other visitors on the rock railroad and send his mechanic alone down the hill with the car. In both this Mercedes car and that of Mr. Breese the dangers of descent were greatly increased by the peculiar clutch construction. Other big cars had gone down rather easily with the switch off and the low gear and clutch in, the cylinder compression making a very satisfactory addition to the braking equipment. In the Mercedes car, however, the coil spring clutch will not hold securely when the clutch shaft speed exceeds that of the crank shaft and it was necessary to water the brakes in these cars when going to the bottom.

Before Mr. Harkness had a try at the climb Mr. Stanley had set the record at a point where it appeared to be safe for some time to come. Mr. Stanley had been quoted as saying that a half hour was about the right time for his car, so when he stripped it for the open event to-day his trial was looked forward to with much interest. Leaving the base at 9:21 o'clock he was only 6:30 making the first two miles. In 13:00 he had reached the half-way house, bettering his previous record to that point by 2:00. Six miles, two-thirds of the climb, were covered in 22:00, and the last two miles were reeled off in 6:19 2-5, making his elapsed time 28:19 2-5, a cut of 3:44 in his record made Monday.

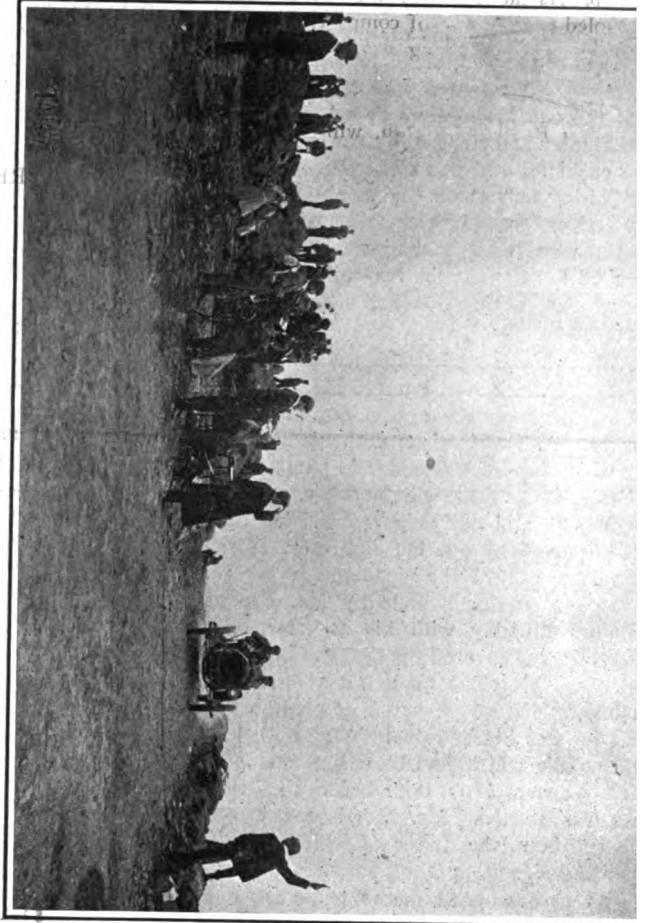

A. E. Morrison Reaching the Finish Line in the Peerless Touring Car Stripped Down.

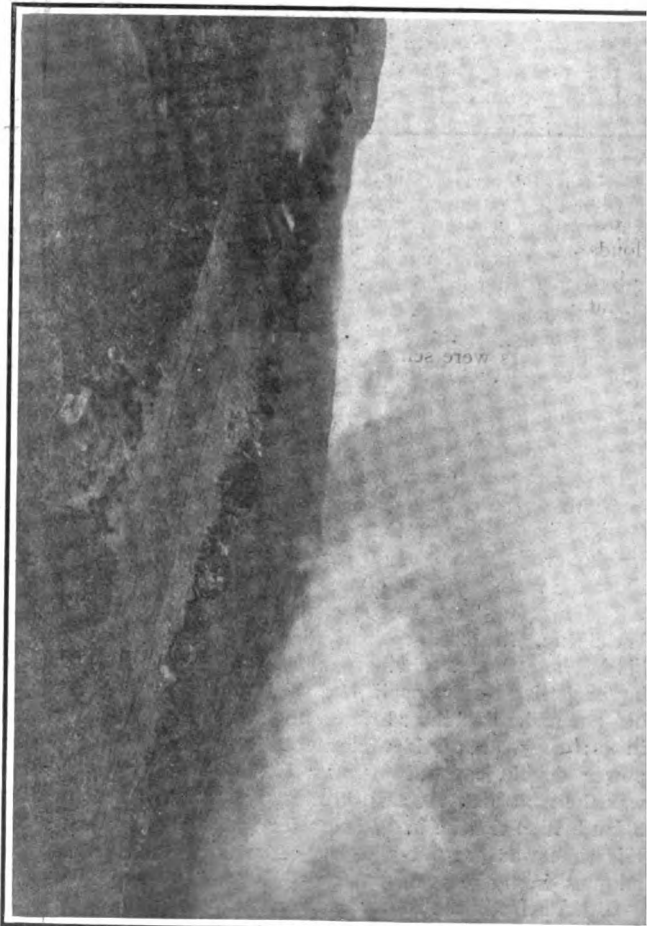

Stanley Rushing Along at an Average Speed of 17 Miles an Hour up in the Clouds.

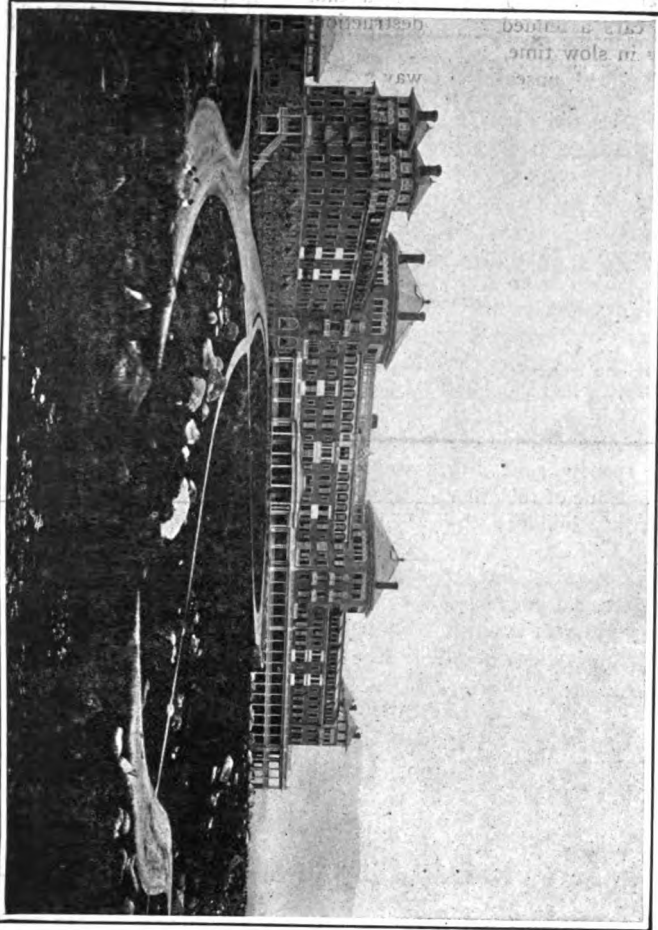

The Magnificent Mount Washington Hotel at Bretton Woods Used as Headquarters.

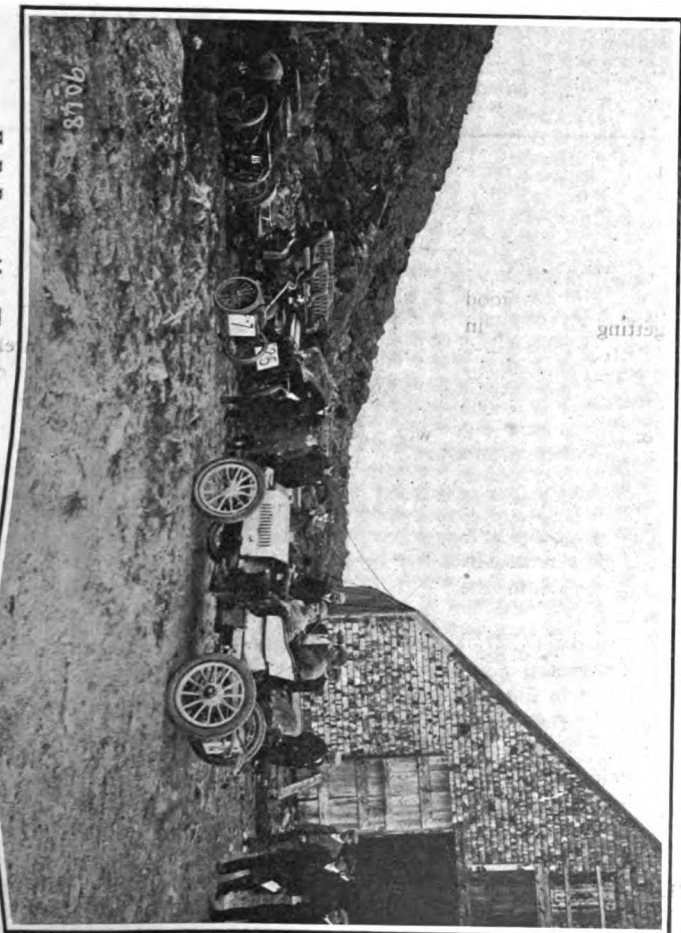

H. E. Rogers After His Arrival on Top in His 24-Horsepower Peerless Car. PHOTOGRAPHS OF CLOUD EFFECTS AND SCENES ON TOP OF MT. WASHINGTON (6,300 FEET), ON THE WAY DOWN, AND IN THE VALLEY BELOW

Mr. Stanley got a splendid welcome and was induced to run his car up skids to the platform of the Summit Hotel where it was photographed repeatedly with one of the rack railroad locomotives as a background. Mr. Stanley had stripped his car even of the seat cushions, and was rather used up with the jolting he got on the way. Both to-day and yesterday he was accompanied by a youth, who, with a stop-watch in hand, checked the time at the two-mile marks on the way up, so that they had a line on their performance.

Although none of the other contestants besides Mr. Harkness lowered Mr. Stanley's colors, there was record breaking in several classes. A. E. Morrison with his Peerless car which he drove Monday in 36:44 1-5 in full rig, essayed the climb to-day, stripped in class 8, and not only reduced his own record to 29:06 4-5, but until Mr. Harkness started held the gasoline car record. This was previously held by Mr. Breese, who on Monday with his 40-horsepower Mercedes car covered the distance in 34:09-4-5. Mr. Morrison made a fine effort for honors, and it was a matter of great regret that he was blocked on his way up by an Oldsmobile which had been sent up about three quarters of an hour before the Peerless was started. Mr. Morrison overtook the runabout, the driver of which did not hear the signals and the Peerless car was forced to stop until the Olds turned out. In getting past Mr. Morrison overran the edge and had to get assistance from some pedestrians to get the car on the road again. In this mixup he lost the bonnet, and a bolt in the radiator came loose, causing the cooler to get out of line with the fan driving pulley, and so the belt was lost. The remainder of the trip was made with imperfect radiation. When the Olds finally arrived at the top, the occupants corroborated Mr. Morrison's statement and he was allowed two minutes, which he accepted as satisfactory, though he figured the loss at four minutes. His official time therefore was 29:06 4-5.

James L. Breese made another try to-day in his 40-horsepower Mercedes, and cut his time down to 31:22 4-5. His car was geared up too high and he was unable to get out of first speed anywhere. He drove the car both up and down on both occasions. Coming up to-day he lost a kit of tools, which were jolted out of the car and strewn about the road.

The first to start in the morning was Webb Jay, who had repaired the tires on his White steamer. Owing partly to a delay in getting water supplies on the way he did not make any record time and finished in 42:19 4-5. Mr. Alden in the 12 horsepower double opposed cylinder Columbia was the next man up, and on the way lost a fan belt so that he had to stop for water. His time was 51:50 2-5, a cut of several minutes from the previous day's efforts.

L. J. Phelps in the 20-horsepower touring car had some minor troubles that also re-

duced his figures, and he got in in 47:20 2-5. F. H. Peabody of Boston came up in an Olds and cut the time of that machine from 1:25:14 1-5 to 1:20:46.

Both the Metz motorcycles did remarkable work. Arthur Batchelder, a young rider from Lowell, got up in 34:11 3-5. He had to dismount three times on the way, each time the cycle speed being too slow for the motor, which in consequence stopped. He did not seem nearly as tired as some of the automobilists who had backs to their seats, and he said he expected to go down more easily than he had come up, using the motor compression to brake. His machine appeared to be very fit and it got up in excellent condition. It was a remarkable exhibition of what could be accomplished with a two-horsepower motor. None of the other and better known motorcycle builders was represented in the race. F. R. Dickenson also started on a two-horsepower Metz at the same time as Batchelder, but consumed 52:42 2-5 in the ascent. He was a much heavier man and his machine was geared

By the time all these contestants had finished the clouds completely covered the mountain, and the rain began to fall very heavily. Word was telephoned up from the bottom that Mr. Morrison in the Peerless had again started up, but the combination of bad weather and a machine damaged by the mishap earlier in the day caused him to stop.

The Consolidated Motor Truck also made a start, but the roads had become rather dangerous and the driver, J. Mallon, was persuaded to return after reaching the two-mile mark.

To permit all of these events to be run off the special train on the rack railroad was held from 4 o'clock until 6:30 p. m., and by that time the weather on top had settled down to a steady rain, accompanied by dense fog. If the wind does not change it is doubtful if any other trials can be held to-morrow, the committee deciding to await weather conditions in the morning before making an announcement.

Following are summaries of to-day's races:

RESULTS OF EVENTS CLASSIFIED BY WEIGHTS.

EVENT No. 7—NOT OVER 1,000 POUNDS

No. of Car.	Make.	Driver.	H.P.	No. of Cyl.	Weight.	Price.	Time.
19	Olds	F. H. Peabody	4	1	875	\$650	1:20:46
21	Olds	B. Smith	7	1	1,000	650	2:16:55
14	Olds	Turner	—	1	—	650	2:25:51 2-5

EVENT No. 8—1,000' TO 2,000 POUNDS

17	*Peerless	A. E. Morrison	24	4	2,500	4,000	:29:06 4-5
3	White	Webb Jay	10	2	1,900	2,500	:42:19 4-5
1	Phelps	L. J. Phelps	20	3	1,700	2,500	:47:20 2-5
25	El. Veh. Co.	H. W. Alden	—	2	—	1,750	:51:50 2-5
15	Rambler	A. Gardner	16	2	1,650	1,100 (did not finish)	

*Elapsed time, 31:06 4-5, 2 minutes being allowed for delay.

EVENT No. 9—OPEN TO ALL

31	Mercedes	H. S. Harkness	60	4	—	—	:24:37 3-5
2	Stanley	F. E. Stanley	6	2	800	670	:28:19 2-5
26	Mercedes	J. L. Breese	40	4	2,200	—	:31:22 4-5
23	Stev.-Duryea	O. Nestman	7	2	1,300	1,300	:40:35

EVENT No. 11—MOTOR CYCLES, 2 H.P. OR OVER.

27	Metz	A. Batchelder	2	—	110	212.50	:34:11 3-5
28	Metz	F. R. Dickenson	2	—	110	212.50	:52:42 2-5

rather high. Twice on the way up the chain jumped the gears and had to be replaced.

Arthur Gardener, driving a 16-horsepower Rambler, was the only contestant whose machine was really disabled. When near the two-mile mark his transmission broke and he retired.

Benjamin Smith came up carrying "Senator" Morgan in an Olds and they had several kinds of trouble. On his arrival Mr. Morgan said he had graduated into the mechanic class on the way up.

Otto Nestman made his first official trial on the mountain to-day, doing the eight miles in 40:35, part of the time in fog and rain. He afterward claimed the right to be allowed to compete in No. 3 class then closed. This was for regular stock cars listed from \$1,000 to \$1,800. He based his protest on the ground that he had not been notified on what day that class would race, and had supposed that he could go in this class at any time after his arrival on the hill climbing contest days.

NOTES OF THE CONTEST.

Those who came to scoff remained to praise.

* * *

On Tuesday afternoon it was cool enough on the summit to have fires in the sitting room stoves in the hotel.

* * *

"Senator" W. J. Morgan is certainly entitled to one of the prize medals as "discoverer" of the grandest hill climbing course on the Continent.

* * *

The proprietors of the Mount Washington road, with characteristic native shrewdness, tied a string to the road permit by imposing a charge of \$2 for every machine that went up the mountain.

* * *

Many of the officials and participants brought their wives and daughters along, so the social features were not neglected, and

there were other subjects of conversation besides times and sprockets between events.

* * *

It was the intention to hold a series of dashes up the mountain against time on Wednesday. When morning came, however, the rain was coming down so heavily that the officials decided to hold an afternoon parade in the valley instead.

* * *

On Monday S. M. Butler started the cars up the hill and A. R. Pardington acted as the A. A. A. official at the finish line on top, with Augustus Post as an enthusiastic aide. On Tuesday the positions were reversed.

* * *

On several of the cars the mechanic got out and helped push the machine over the bad spots, and especially at corners. In one case both driver and mechanic got out and boosted the machine along. These cars did not make records. Any car that

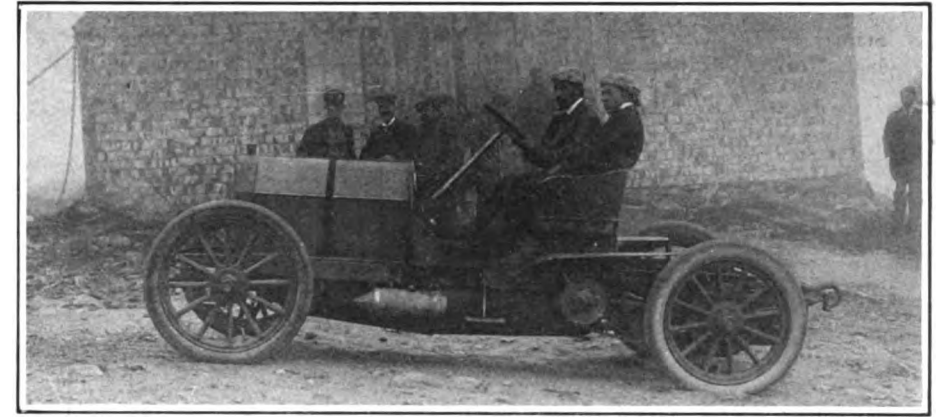

HARRY HARKNESS IN HIS 60-H. P. MERCEDES. PHOTOGRAPHED IN THE CLOUDS ON TOP

of comforts, and they were not disappointed. The new Mount Washington Hotel has accommodations for about 500 guests, and is one of the most beautifully fitted up vacation hotels in the country. The decorations and furnishings are in exquisite taste, with

ard. At the Mount Pleasant Hotel the surroundings are more homelike, and, indeed, a choice is difficult.

* * *

Gold, silver and bronze medals for the winners were on exhibition at the Mount



CONTESTANTS' CARS AFTER ARRIVAL AT THE FINISH. NOTE BARN CHAINED DOWN TO THE ROCKS IN BACKGROUND.

went slow enough for a man to push it didn't stand much chance of a medal.

* * *

Those who had attended the Ormond Beach races expected much of the hotel managers, Anderson and Price, in the way

not a vulgar note in the entire composition. The color scheme is white and green. An immense swimming pool and a ball room large enough for a State function are included in the facilities for enjoyment. The cuisine is quite up to the New York stand-

Washington Hotel. They are of generous size and artistic design, and will form valuable additions to certain manufacturers' collections.

* * *

Newspaper men were greatly interested in the complete daily plant on top of the mountain, where *Among the Clouds* is published during the season. Frank H. Burt, the editor, developed into an auto enthusiast and gave the contest lots of space and scare heads each day.

* * *

Owing to the unavoidable delay in getting consent from the owners of the carriage road up the mountain to open it to automobiles on the days of the contest, the time for spreading advance information about the meet was very short. As a consequence the promoters did not expect a large attendance either of contestants or spectators. Naturally enough, too, the contest had a decided Boston flavor. Few New Yorkers outside of the officials and those professionally interested were on the mountain.



COACH HOUSE USED AS A GARAGE NEAR THE STARTING LINE IN THE GLEN.

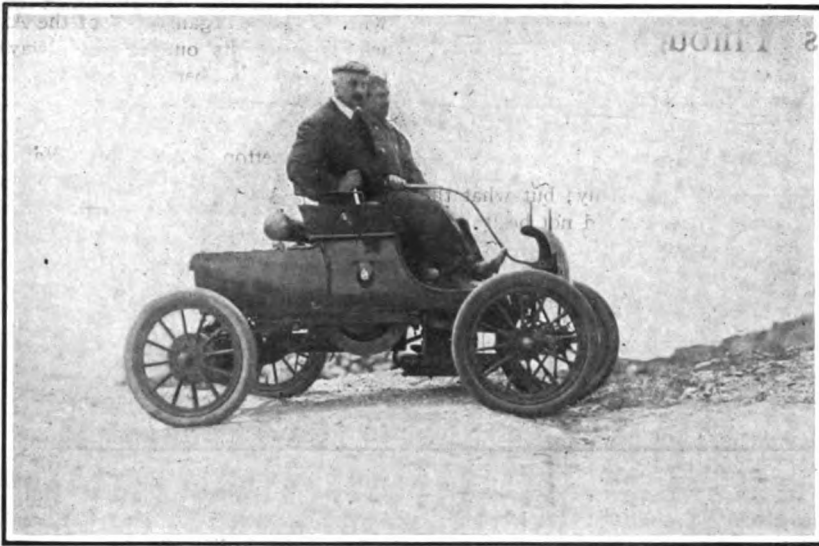

BENJAMIN SMITH IN AN OLDSMOBILE, ON HIS WAY UP THE MOUNTAIN.

Changes of light were so frequent and rapid that the photographers were obliged to guess at results, and constantly readjust lens openings and shutter speeds. Some of the most interesting pictures were made under the worst conditions of light.

* * *

A few of the cars have special equipments, but those that made records were of the ordinary stock types. A doubter who put a query to Mr. Stanley was instantly met by an offer to sell the car on the spot at the regular stock price. The critic did not buy.

* * *

Considering the shortness of time for preparations and the difficulties of the task the race management was remarkably successful. The solitary hitch in the two days' sport was the blocking of Morrison's Peerless by an Olds on Tuesday. Next year fast and slow cars will not likely be sent up in the same groups.

* * *

After forty years of steady uneventful work the old rack, railroad on Mount Washington woke up on Tuesday evening, and landed the passengers of the late special at the bottom in 50 minutes. It had been inoculated with the record breaking virus. The best previous time was 55 minutes from the summit to the base, a distance of three and a half miles.

* * *

Many little improvements will be made in the arrangements for the next meet. The finish line will probably be moved down around the corner to the last straightaway, so that there will be more room for the competing cars on top and no danger of collision when they arrive. Direct electrical connections between the top and bottom and intermediate points may be put in. The rocket signals are useless up in the clouds.

* * *

Absolute accuracy of timing within the limits of human powers of observation was

guaranteed when the Boston Chronograph Club was requested to hold the watches. The club representatives were John Kerrison, E. O. Windsor, Frank Ross and George Lowe. They worked in pairs at the start and finish, and so well was the work done that not a single difference occurred in the observations.

NASHVILLE RACE MEET.

NASHVILLE, July 11.—So successful was Nashville's first automobile race meet, held June 13, that another, on a much larger scale, is being planned for Labor Day. This meeting will be given under the auspices of the Cumberland Park Driving Club and there will be seven or eight events. The program committee is in correspondence with several owners of racing cars.

GOOD RUNS INTO NEW HAMPSHIRE.

Several excellent runs over the White Mountain roads to Bretton Woods were made before the Mt. Washington hill climbing contest came off. One of these was made by Herbert W. Alden, of Hartford, who drove the 14-horsepower Columbia gasoline car that was entered by the Electric Vehicle Company for the hill climb. Leaving Hartford Thursday morning Mr. Alden reached Lakeport, N. H., at 7 P. M., going through Springfield, Worcester, Nashua and Concord, covering 210 miles on the day's run. He arrived at Bretton Woods at 4 P. M. the second day, having averaged thirteen miles an hour over hilly and sandy roads.

Another excellent run was made by William F. Plant and Mr. Ross, of Boston, in a Model L Packard car that Mr. Plant had bought July 7 and which had never been run except in testing before leaving the factory, and in a brief tuning up before the start. A run of 230 miles from Boston to Bethlehem, N. H., over good, medium and very bad roads, was made in 14½ hours elapsed time, and 12 hours actual running time, with a gasoline consumption of 13 gallons, as recorded by Mr. Plant. Thus the average running rate was 19 miles an hour and the mileage per gallon of fuel 17½ miles.

A recent issue of the *Indian Sporting Times*, published in British India, contains an illustrated article describing the mountaineering feats of an Oldsmobile runabout driven by Dr. J. M. Tarachand. The machine was sent up the three Ghauts to Mahableswhar, India, from Khandakla, the same car having previously climbed the Bhor Ghaut.

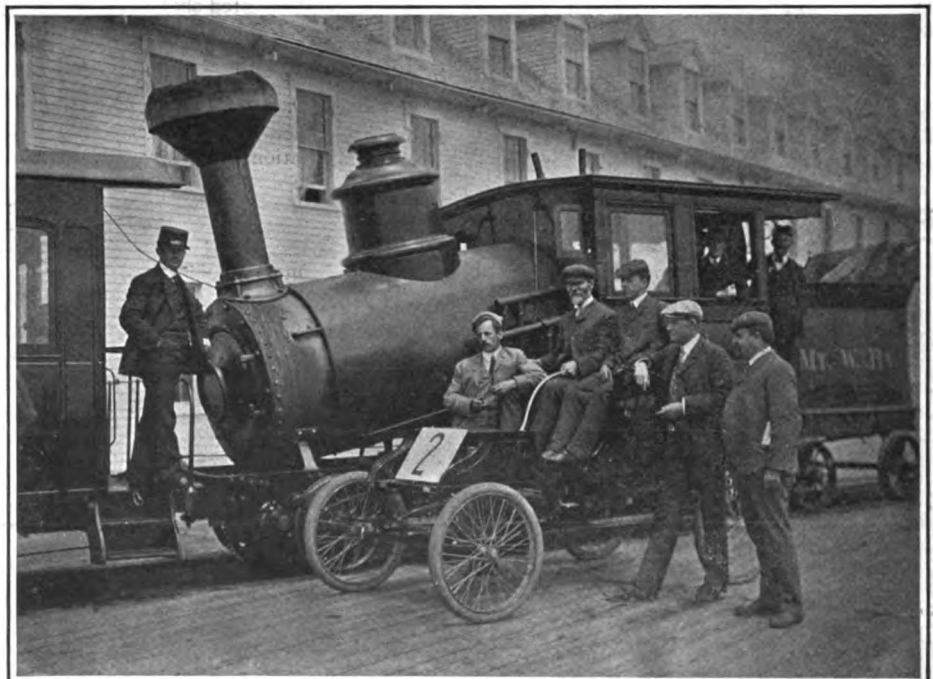

F. E. STANLEY IN THE RECORD BREAKING CAR ALONGSIDE THE RACK ROAD LOCOMOTIVE, IN FRONT OF THE SUMMIT HOTEL ON TOP OF MT. WASHINGTON.

Messrs. Kerrison, Windsor and Butler standing beside car.

Merger Plan Falls Through.

Failure to Agree on Proxy System Ostensible Reason—Officials of A. A. A. and A. M. L. Disinclined to Talk.

THE abrupt termination of negotiations for the amalgamation of the American Automobile Association and the American Motor League, briefly announced in these pages last week, came as a great surprise to the membership of both bodies, a large majority of which had voted favorably on the plan of merger drawn up and published early in April. The report a month ago that a hitch had arisen in the drafting of the constitution and by-laws, over the question of proxy voting for individual members, did not seem to presage failure, since the disagreement as reported did not seem to be insurmountable, and hardly justified the pessimistic tone taken by certain representatives of the A. A. A. as to its outcome. It is evident now that the difficulty was in reality much more serious, and it appears to have involved points of fundamental importance which were not mentioned at all at that time.

Exactly what these points at issue were is something of a mystery still, and the leaders of neither side have shown conspicuous willingness to state all the facts. This is particularly true of the A. A. A. officials, who for the most part contented themselves with quoting the formal statement given out by President Whipple of the A. A. A. after the meeting of the executive committee July 6. That statement was as follows:

"The proposed merger between the American Automobile Association and the American Motor League will not take place, since the committees which were appointed to draw up a constitution did not agree, this agreement on a constitution having been a condition precedent to the proposed merger."

That one, at least, of the points at issue was that of proxy voting seems to be made clear by the interview with Secretary Butler quoted hereafter. Although it might be unimportant, Mr. Butler points out that in reality the proxy system might be seriously abused, since the individual member, with only one vote and no way of using it except by proxy, would not be likely to inquire too carefully how his proxy would be used: and moreover it would be next to impossible to check and verify several thousand proxies at the annual meeting. One of the A. A. A. directors, who did not wish his name to be used, said that the A. A. A. committee had offered to recognize and give representation to clubs of even as few as three members, which would seem to confirm Mr. Butler's statement that the point objected to was not that of representing scattered members, but the manner of so doing.

It was learned from another source that the proxy suggestion was not a feature of the draft of constitution and by-laws submitted by Mr. Potter, but was made later

and in a tentative way only; but what the original proposal was could not be learned.

From conversation with other men in the A. A. A. it was inferred that the financial condition of the A. M. L., was not such as to make amalgamation on equal terms easy. None of them cared to be quoted on this point, which does not appear to have come up at all in the negotiations leading to the plan of merger, but all agreed that that organization would get much the best of the deal. It seems, in fact, to have been the general impression that the A. M. L. had more to gain and less to lose by consolidating than the A. A. A., and this impression was reflected in the greater indifference shown by the membership of the latter when the merger was voted on. Certainly, aside from such resentment as the A. A. A. membership may show over the refusal of their officers to explain matters, most of the disappointment seems to be felt by the other side.

On the face of the matter, the A. A. A. has put itself in the wrong by disregarding the agreement embodied in the plan of merger, under which the constitution and by-laws were to be drafted. On this point the plan of merger reads as follows:

7. A committee consisting of two members selected from the present membership of the A. M. L. and a like number selected from the present membership of the A. A. A. shall prepare a constitution and by-laws to serve the purposes of the united body and shall present the same to the governing board for its adoption. The constitution and by-laws so adopted shall remain in force until amended or suspended at a regular or special meeting of the united body upon due notice. Such constitution and by-laws shall among other things, make due provision for the continuance of clubs, local organizations and individual membership in the American Motor Association and shall harmonize as closely as practicable with the constitution and by-laws of the A. A. A. and A. M. L. as framed prior to the merger of the two bodies."

The governing board referred to is apparently that mentioned in section 3 of the same plan:

3. The general management and control of the affairs, funds and property of the united body shall be vested in the governing board, to be composed of ten directors to be appointed by the A. M. L. and a similar number to be appointed by the A. A. A. The directors so appointed shall include the officers named in paragraph 2.

Although the point is not specifically covered, President Potter contends with seeming reason that in case of disagreement each branch of the committee should report to its own section of the board of twenty, and should not in any case receive instructions from the board of governors of its organization. Mr. Potter's statement and interview deal chiefly with this point and

with the loose organization of the A. A. A., which, he points out, cannot always control its own members, and whose membership cannot control its officers.

President Whipple of the A. A. A., when seen at Bretton Woods, Mt. Washington, referred to his brief statement of July 6, and refused to be quoted further. He said, however, that the Board of Directors of the A. A. A. had acted in the matter with entire unanimity.

OFFICIALS ARE INTERVIEWED.

Secretary Butler, who with Emerson Brooks represented the A. A. A. in the conferences to draft a constitution and by-laws, expressed himself quite decidedly on the subject of voting powers, and declared that the A. A. A. never would consent to a system of proxy voting, which, he said, Mr. Potter wanted. When asked if any other methods of taking care of the individual members' votes, besides the proposal to give proxies and the A. A. A. suggestion that they become associate members of the nearest clubs, had been considered, he replied in the affirmative.

"We offered to consider any plan Mr. Potter might suggest," he said, "for connecting the individual members together in clubs, district organizations, or anything of the sort, no matter how slender their organization might be, so long as they sent regularly elected delegates. Our sole objection was to the proxy system. You see, when a club sends a delegate, the chances are that he is instructed, and at all events he knows the sense of his club and is responsible to it. If, however, we allow proxies, it will be the easiest thing in the world for someone to write around to all the individual members, and get several thousand proxies which he can vote in any way that suits him. As soon as that happens, we shall have all sorts of political dickers and wire-pulling, and men will be working for themselves, not for the good of the sport. The organization will lose standing and will rapidly go to pieces so far as real influence goes. There is an article in the constitution of the A. A. A., aimed to guard against that very thing by forbidding any representation by proxy.

"Again, a club is a responsible body. It has officers and books, and you can get at it. But how can you get at a lot of irresponsible individuals, scattered all over the country, who choose to give their voting power to the first comer?"

"The A. A. A. is made up of men and clubs of the very highest standing, who have no personal interest or profit to serve, and who are working shoulder to shoulder for the best interests of the sport. It has kept free of politics thus far, and it wishes to remain free. Its membership now numbers thirty-three clubs, with more being constantly added, and covers all told about 2,500 members. The dues for unattached members are \$1 initiation fee and \$1 annually, and the roll of these members is steadily

growing. They have all the privileges of the organization, except the right of representation; and if they attend an association meeting in person they have the right to vote. It is worth something, you know, to belong to an organization which includes all the strongest clubs and the ablest and most influential men in the automobile movement, instead of existing mainly on paper."

To a query regarding the financial standing of the A. A. A., Mr. Butler explained that the treasurer made a report at every meeting of the directors and that the minutes of every meeting were sent to every club in the association. "There are no star chamber proceedings about it," he said. "The clubs have a right to know, and they do know, just how the money is being spent."

GEORGE E. FARRINGTON TALKS.

George E. Farrington, treasurer of the A. A. A., and one of the members of the original committee which drew up the plan of merger, was much less communicative, though this might possibly have been due to the week-end rush in which the interviewer found him immersed.

"There is little to say," he said, "except to repeat President Whipple's official statement after the last meeting. We approached the subject of the merger, all of us, with the feeling that it was a great pity that there should be two bodies, dividing between them the abilities and strength of the automobile movement, working at cross-purposes, and we were absolutely sincere in our wish to bring the two together for the best interests of both. We felt that in such matters as putting up signs, preparing maps, working for good roads, and in law work—Potter is a crackjack at law work—a great deal more could be done by combining forces.

"But when we got together to discuss the constitution and by-laws, we found that the two bodies were so essentially different that no reasonable machinery could be devised that would take care of both and give them equal standing. Mr. Potter showed us a draft which he had prepared for the constitution and by-laws, closely modeled after those of the L. A. W. It was the most complicated thing I ever saw,—a whole lot of machinery involving districts, councils, lodges, and what not, which would have been utterly impracticable for us. He said it was necessary for his own organization. We conferred, and held meetings, and conferred, for three months, and couldn't get together after all. So we had to give it up."

"Was the main difficulty about the arrangements for voting?" was asked.

"That was one, but there were others as well, a lot of them. It would take a day to enumerate them all. The two bodies are essentially different; that is the whole story."

When asked if the membership and resources of the A. M. L. had been called in question, Mr. Farrington replied with a prompt denial.

"We did not care whether the A. M. L. had a hundred members or ten thousand," he said. "We took Mr. Potter's word for it that its membership was about so and so. We made no point of its resources, nor was any made of ours, further than that we have books which tell the whole story. No books were shown in the conferences, however. I wish to emphasize particularly that our sole wish was to get together on a basis of mutual equality. We were much disappointed when we found that this could not be done. The A. A. A. insisted on certain things which it deemed essential to its character as an association of clubs, and we gave the other side every opportunity to frame a plan which would accord with those essentials. This they failed to do."

Emerson Brooks, when approached on the subject, refused all information, beyond claiming that the A. A. A. had little to gain by amalgamation and much to lose, and that under the scheme of merger to which the A. M. L. would agree it would lose much more than it would gain. When asked for specifications he declined to talk.

ISAAC B. POTTER EXPLAINS.

Mr. Potter, when asked to state the matter from the standpoint of the American Motor League, expressed regret over the unforeseen turn affairs had taken, and requested time to prepare a written statement, saying that he did not wish to embroil matters further than had already been done. Accordingly he later handed the representative of this paper the following:

"The organized automobilists of America have declared unanimously and wisely in favor of one organization. They have unanimously approved a well-considered plan for the merging of two national bodies. They have entrusted to the officers of the A. M. L. and the A. A. A. the duty of executing the details of this plan, which the governing boards of both bodies had previously approved. It now appears that the work of merging has been interrupted, and for the time being, thwarted, and the rank and file of both bodies are entitled to a fuller explanation than can be compassed in a dozen words. Stated as briefly as the facts will permit, the situation is this:

"The merger agreement between the two organizations provides that each body shall appoint two members of a joint committee to prepare a constitution and by-laws, which shall thereafter be submitted to the approval and adoption of a governing board made up of ten members from the A. M. L. and a like number from the A. A. A.

"The two committee members from the A. M. L. were selected and met two members of the A. A. A., who were apparently clothed with power to prepare a constitution and by-laws, but as the work proceeded it soon became apparent that the A. A. A. members of the committee were mere delegates, acting under instructions, and utterly powerless to follow their own judgment, or to confer with their associates in most important matters where careful deliberation was needed. Not only was this true, but their instructions were of the most drastic and extraordinary nature. They stated in substance to the A. M. L. members, that the directors of the A. A. A. would not accept a constitution and by-laws which gave to individual members a right of representation at meetings of the national body

It was pointed out to them (a) that the merger agreement distinctly provided that the new constitution and by-laws should accord as closely as practicable with the constitution and by-laws of both the merging bodies; that the constitution and by-laws of the A. M. L. made distinct provision for the representation of individual members by delegates; and (b) that it was not for the directors of the A. A. A. or the directors of the A. M. L. to insist what should or should not go into the new constitution, but that questions of this kind must be decided by the joint governing board of twenty members as the merger agreement had provided. This argument had no effect. The A. A. A. members of the committee stated that they were under instructions and unable to act otherwise than they had stated.

"By invitation of one of the directors of the A. A. A., I appeared before that body and tried to dissuade them from a position so contrary to the agreement between the two organizations, and so obviously hurtful to the interests of the proposed new body. It is already well known that the A. A. A. directors refused, as I am told they still refuse, to observe the terms of the merger agreement, and from a careful examination of the conditions, I believe that no merger will now be perfected, and for the following reasons:

"1. There is no dominant or controlling force in charge of the affairs of the A. A. A., and by this I mean there is no executive having sufficient authority to carry out the terms of this agreement, or any other agreement which the individual directors of the A. A. A. see fit to repudiate. I say this with no wish to unkindly criticize, but rather to point out a weakness in the make-up of the A. A. A., which cannot be too speedily overcome. It does not seem to be, in the true sense, a national organization. The bulk of its membership is composed of clubs within the States of New York and Massachusetts. These clubs are formed into State associations, which are no part of the A. A. A., but are merely allied with it by some sort of agreement, which, for slight cause, might be quickly terminated. The New York association, for example, has a separate corporate existence, elects its own officers, adopts its own constitution and by-laws, which, by the way, contain no reference, immediate or remote, to the A. A. A. or to any connection between the two bodies.

"2. The Massachusetts association is, I am told, in many respects the same. Under these circumstances, the question of merger rests not between two national bodies, but between the A. M. L. and several component clubs and associations, each swayed by a desire to perpetuate the club feature, and by an unwillingness to recognize the great majority of automobilists who are not and never will be club members. Some important questions must be considered, therefore, before a combination of these bodies becomes possible. It must be settled whether the individual automobilist of the United States shall be entitled to the same rights as the club member or whether the entire body shall be dominated by a few clubs and a few club officers. It is, of course, proper that clubs should be encouraged and that local organizations should be recognized and supported, but it is neither convenient nor possible for every automobilist to become a club member, and it should be the aim of a national body to attract the support of all alike, and make the requirements of membership as easy, and the obstructions as few as possible.

"This is the aim of the American Motor League, and its work will now be taken up

and carried along more vigorously and more successfully than ever.

"ISAAC B. POTTER."

THE LEAGUE PRESIDENT TALKS.

Having given out the above formal statement, Mr. Potter submitted to be interviewed on some additional points. To a question whether the representatives of the A. A. A. had offered to care for individual members in any other way than by their joining clubs, he replied with an emphatic negative.

"Absolutely none," he said. "It had to be clubs or nothing."

"And did they admit specifically that they were instructed on that point?"

"They did, in so many words. After we had conferred at length without result, I said to them: 'Gentlemen, suppose that we were to propose an ideal system of representation for individual members—one which satisfied every possible objection—would you accept it?' And they said, 'Mr. Potter, we may say that we are instructed to consider no plan whatever of representation for individual members outside of clubs.' And when they admitted that, what more was there for us to say? We went to the committee meetings in good faith, only to find that we were meeting, not a committee, but instructed delegates whose will was not their own. What was the use of arguing when we knew in advance that no reasoning would avail?"

"From whom, do you take it, did their instructions come?"

"I suppose from the A. A. A. board of directors. Mr. Whipple himself said to me, in the presence of that board, 'It is with us a *sine qua non* that individual members shall not be represented by delegates.'"

"Did he use the words 'by delegates'?"

"Leave them out, if you wish. If the individual member joins a club he is no longer an individual member."

"Did you offer any suggestion as to ways of representing individual members as such, to meet their views?"

"We did not get at that. When we found that we were talking with delegates we put on our hats. It was time to go home. And what had the A. A. A. board of directors to do with the matter at all? Their committee was responsible to the special governing board of ten, and should have reported a disagreement to them. So far as I know, that special board never even met. It certainly never met our board."

"You did not, then, formally discuss a scheme of representation for individual members. But, of course, you had some plan in mind?"

"Well, our American Motor League plan is this: We divide each State by groups of counties into a certain number of districts. Delegates, resident in their several districts, are nominated by resident members, and ballots with their names, with blank lines below for 'scratch' voters, are sent to every member of the district. The delegates elected per district are in proportion to the

number of members, and they represent the district in the national assembly."

"The impression has prevailed that you favored a system of voting by proxy."

"We did not discuss it. How could we? The plan of the merger was being violated by the other side. We stood on our dignity and refused to deal with them."

"It is a little curious that after the officials of the A. A. A. had expressed themselves so cordially in favor of the merger they should have sent you a committee apparently instructed to block negotiations at the start."

"I would not say whether they intended to block negotiations, or expected that we would agree to their demands. Understand, I do not wish to say a word against the original committee which drew up with us the plan of merger. Mr. Farson and Mr. Scarritt are both very fine men, and we got on perfectly together. We did not always agree,—we disagreed on very many things; but we got together and reasoned them out. We had no suspicion that a hitch was impending till we met the instructed committee from the board of directors, and tried to draw up a constitution and by-laws."

"This latter committee would not accept your plan of voting by districts as meeting its idea of a club?"

"A district has no organization, no officers, no headquarters, no dues. Certainly it is not a club. Understand me, I believe in organization. I do not think one can help or hinder clubs much by artificial means, but I offered to argue to a discrimination between individual members and club members, in respect to representation. I even suggested that the former should be entitled to but one delegate per 100 members, against one delegate per 20 members belonging to clubs. But they wouldn't accept it. And that, too, in spite of the fact that our members would be paying, man for man, from two to four times as much in dues as theirs. "Our dues, you know, are \$2 annually, against \$1 per individual in the A. A. A., and in New York State and Massachusetts half of that dollar goes back to the State Associations, under the terms of their affiliation."

In response to a final question, Mr. Potter declined to "show his hand" by disclosing the A. M. L. membership, but conceded readily that the league has no funds worth mentioning at present. "We shall get \$6,000 in renewals this fall, however," he said, "and shall at once begin an energetic campaign for new members. The present low state of our treasury is due only to the fact that pending these negotiations we have let the spring and early summer, the best recruiting season of the year, go by unimproved."

MECHANICALLY operated valves are quite extensively used in motorcycle engines in England and on the continent, and seem to be gaining ground.

HORSE PUNCTURED HIS TIRE

Thought Pneumatic on Broadway Was a Brooklyn Rubber Plant.

Professional jealousy crept into the heart of a truck gardener's patient old horse yesterday afternoon in front of the Hotel Imperial, and he bit a piece out of the tire of a \$3,500 automobile, nearly getting his head blown off by the expansion of compressed air which accompanied the theft of the rubber tidbit.

The horse ran up Broadway, sprinkling enough carrots, beets and cabbages in the street to have routed all the actors off the boards, finally returning, of his own volition, to see Thomas Mulligan, owner of the auto car, and some of Mulligan's friends minutely examining the toothmarks in the tire.

The horse was owned by J. W. Fleming, a farmer who sells vegetables to several Broadway hotels. It is necessary to speak of the horse in the past tense, because he is likely to die of indigestion while this is going to press.

The animal had some words with the automobile and it is said the automobile spoke rather contemptuously. At any rate, blows were exchanged and then the horse resorted to mayhem.

Mr. Mulligan, who is a millionaire distiller of Philadelphia, with an office at 4 Christopher street, had gone into the Imperial with several friends.

When the horse bit the automobile the sudden escape of air almost lifted him off his feet. He was dazed, and instead of taking another bite, decided to show his mettle by challenging the automobile to a sprint up Broadway.

With a piece of rubber still between his teeth, like a football player, the animal ran madly up Broadway to Thirty-fourth street, then over to Fifth avenue, up to Forty-second street, across, and back down Broadway.

He was followed by Bicycle Policeman Debbs and a mounted roundsman, but neither could keep pace with him.

The most remarkable thing about it was that nobody except the automobile was injured. The horse wasn't angry at a soul on Broadway.

He slowed up and stopped in front of the Imperial, right where he was before. Farmer Fleming wouldn't have known anything about it but for the vegetables that were scattered along the route.—New York Telegraph.

THE Great Western Railway Company, in England, we learn from the Daily Consular Reports, has placed in service a number of motor omnibuses, which are used as feeders to the railway lines. The successful manner in which these have operated in carrying passengers and baggage has encouraged the company to use them for the distribution of the mails, a striking example of the advance made in the reliability of action of the modern motor vehicle.

The 1905 Winton Car.

In the new Winton car for 1905, which has just been brought out by the well-known Cleveland builders, previous Winton practice has been departed from along a line no doubt suggested by the *Bullet III*. The engine has four cylinders, but instead of being vertical it is horizontal, with all the cylinders on one side of the shaft. The familiar Winton aggregation of tank and radiator occupies the front of the car, and the motor lies under the footboard, with the inlet valve cages and hoods half projecting from below the right side frame member.

The speed-changing mechanism is still of the Winton individual clutch type, giving two forward speeds and a reverse; and propeller shaft transmission to the rear axle is used.

The side frame members, instead of being riveted up of plates and angle steel, are of channel-section pressed steel of varying depth, in accordance with the most modern practice. Near the middle the frame is 7 inches deep. There are three transverse members, one a tube 126 at the extreme rear, the second a tube 97 just back of the tank, the third a drop channel 48 at the front end of the radiator. At other points the motor and gear case, through wings bolting to the side members, lend the necessary support; and by this arrangement a false frame is avoided.

The motor cylinders are of 4 3/8 inches bore by 5 inches stroke. They are cast in pairs, with jackets and exhaust valve chambers integral, and separate inlet valve chambers bolted on and made tight with asbestos copper gaskets. The cam-shaft and exhaust valve mechanism, and most other moving parts as well, are enclosed, and are further protected from dirt by a pan beneath the motor. A pair of large hand plates give instant access to the interior of the crankcase through the footboard. The exhaust valve springs are reached by removing the plates 24 just below them; and the carbure-

ter, spark plugs, and circuit breaker or timer 6 are made accessible in the same way. The crank shaft and pistons may be removed by detaching the upper half of the divided crank case.

The familiar Winton system of pneumatic control is retained. The air pump 2 is at the front end of the motor, with a miniature piston and connecting rod worked from a crank at the front end of the cam-shaft. The air passes through a receiver 3, and the branches, one arm of a tee leading to the air connection 88, where the light piston 18, cushioning against the air, determines the lift of the inlet valve. The other arm of the tee leads to the foot button valve through which the air escapes. Another connection permits the air escape to be regu-

lated by pipe 125 and discharging finally to the rear.

Two views in section are given of the carbureter. The air enters partly through a fixed but adjustable opening in the top shutter 72 and draws down past the adjustable needle orifice and through the gauze mixing cones below. A diluting stream enters through a burlap filter and tube 73, traversing the holes in valve 74 before joining the main stream just below the needle valve. At high motor speeds valve 74 is opened more or less giving some passage around it, and this prevents too rich a mixture from being formed under such conditions.

The several clutches of the speed-changing mechanism consist each of a disc and a

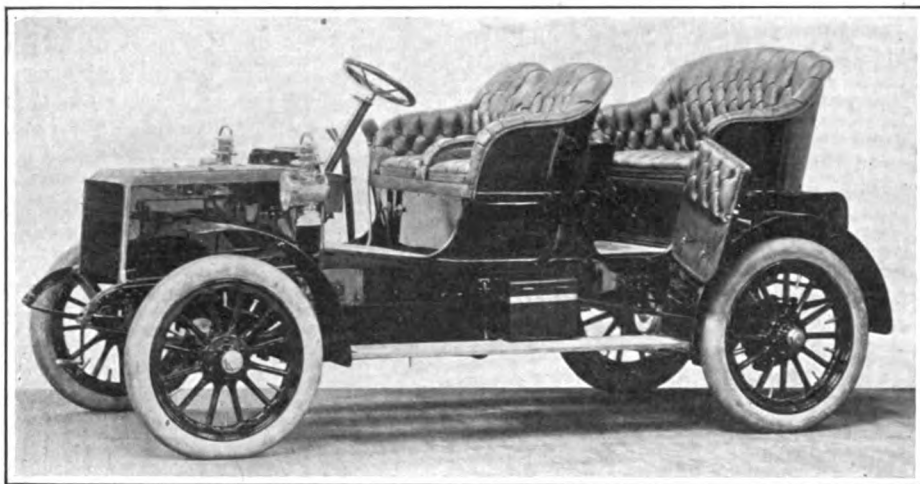

NEW WINTON CAR WITH FOUR-CYLINDER TRANSVERSE MOTOR IN FRONT.

lated by a small lever on the steering column, just above the spark advance lever. This lever gives a fixed escape opening so long as it is left untouched, so that the foot button will presumably be used mainly for sudden "spurts."

The exhaust is muffled by a pair of expansion chambers, one directly below the exhaust chambers, the other connected with

cone, gripping corresponding bronze surfaces of a gear between them. On the high gear the drive is direct, no gears being at work, though all are in motion. For the high speed, three dogs 117, acting against disc 118, force the loose pins 35 against cone 34, and the latter, which is slightly loose on its key, into gear 32. Further motion of the thimble draws shaft 33 to the left (forward)

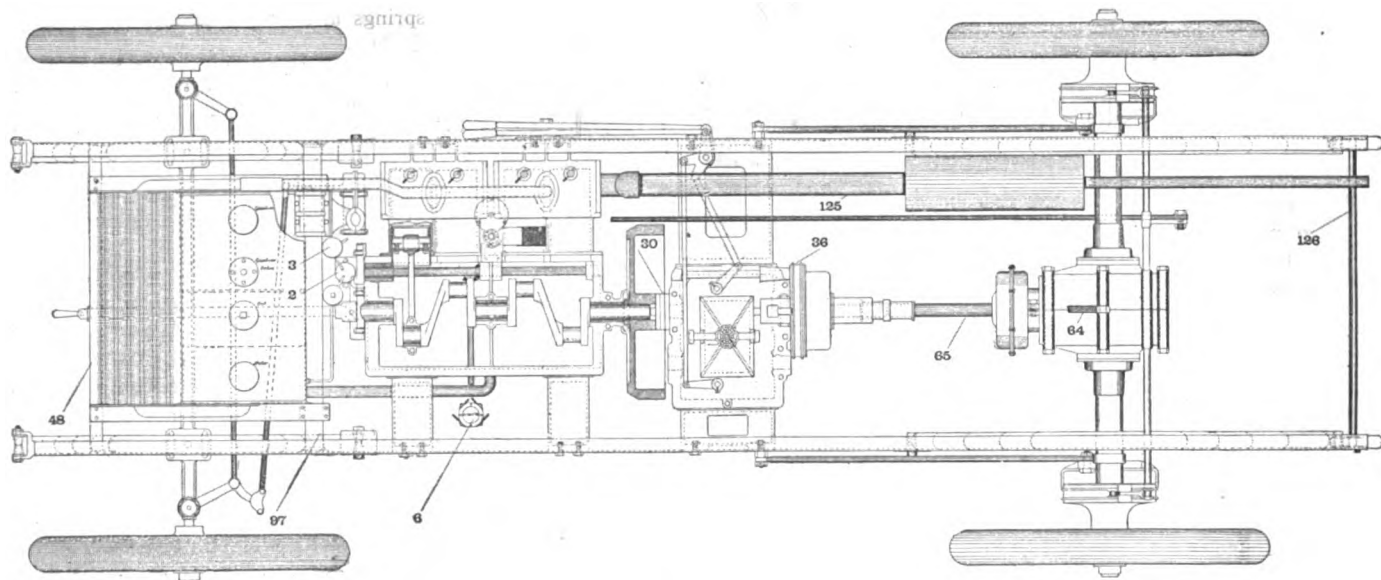

PLAN OF NEW WINTON TOURING CAR. SHOWING DISPOSITION OF QUADRUPLE ENGINE UNDER FOOTBOARD.

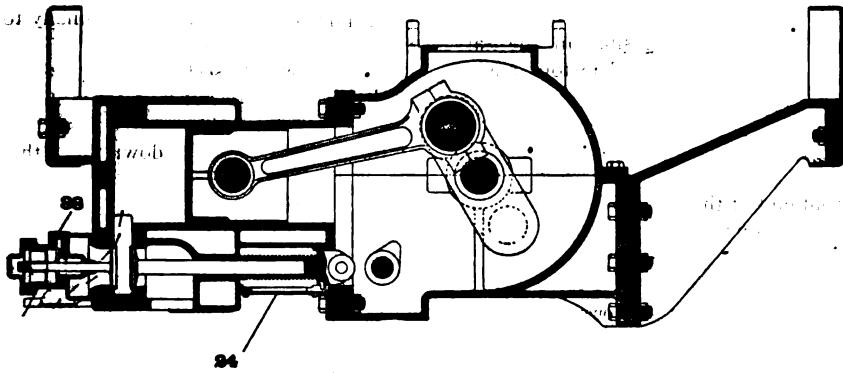

VERTICAL LONGITUDINAL SECTION OF ONE OF THE CYLINDERS.

till the thin fibre disc seen between disc 119 and the shell 120 is gripped fast. Thus the end thrust is taken up between the dogs and disc 119.

For the slow speed, dogs 121 are put in action, and the drive is through gears 40, 39, 42, and 32. An intermediate pinion between gears 44 and 45 gives the reverse. A slightly loose coupling 30 between the flywheel and shaft 33 allows for loss of alignment. A service brake band acts on the drum 36, attached to which is part of the front universal joint of the propeller shaft 65.

The bevel driving pinion in the rear axle runs in a plain bronze bushing. The differential is of the spur gear type, and the axle shafts run in ball-bearings with 1-inch balls. The axle is trussed below, and two struts, one (64) at the top of the case and the other below, are pivotally connected at their front ends to points on the speed gear box, thus relieving the springs of all stresses due to driving and braking.

The engine cylinders and shaft bearings are lubricated through sight feeds on the dash, the oil being put under air pressure by connection with the air pump through a reducing valve. The speed gear box is lu-

bricated by splash. By means of a cock opened from the seat, the crank-case may be drained. The oil in the latter is used but once, not circulated and used over and over.

For ignition one six-volt storage battery is used, and five dry cells, the latter being

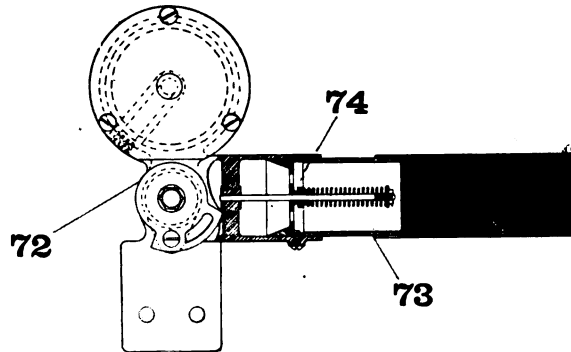

PART SECTIONAL VIEW OF CARBURETER.

held as a reserve. One vibrator coil is used for each cylinder.

A centrifugal circulating pump is used, gear driven and attached to the front of the crankcase. The course of circulation is

from the pump to the cylinders, to the bottom of the radiator, from the top of the latter to the tank, and from the tank through an auxiliary radiator, beneath the tank, to the pump again. The oil is separated by a partition from the water in a common tank, and the gasoline in another division of the tank has a heat insulating space between it and the water.

The control system follows previous Winton practice, one lever operating the high speed and the emergency brake, and another the low speed and reverse. The other items have been mentioned. The worm

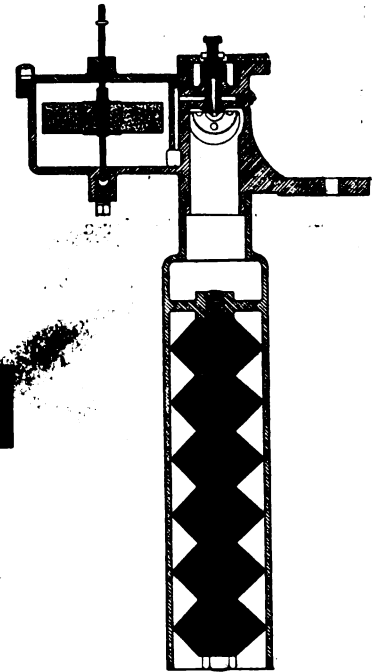

VERTICAL SECTION OF CARBURETER.

steering gear has provision for taking up wear.

The wheels have 32 by 4-inch tires in front, and 34 by 4 1-2-inch tires in the rear. The emergency brakes act on the rear wheel hubs. Wheel base is 104 inches, and the springs are 38 and 44 inches long, respectively.

The body is a new type of side entrance tonneau, with cast aluminum frame and laminated wood seats. Under the tonneau seats is a tool locker, reached from behind. The mud guards are laminated wood, and the upholstery is deep and luxurious.

White 1905 Touring Car.

Owing to the fact that it disposed of all of its 1904 cars before the end of June, the White Sewing Machine Co. has made a very early announcement of its model for next year, which will be called the Model E. This car, on which shipments will begin about September 1, is considerably larger than its predecessor, as the photographs show, having a longer wheel base, roomier and more graceful tonneau—King of the Belgians type—and considerably greater

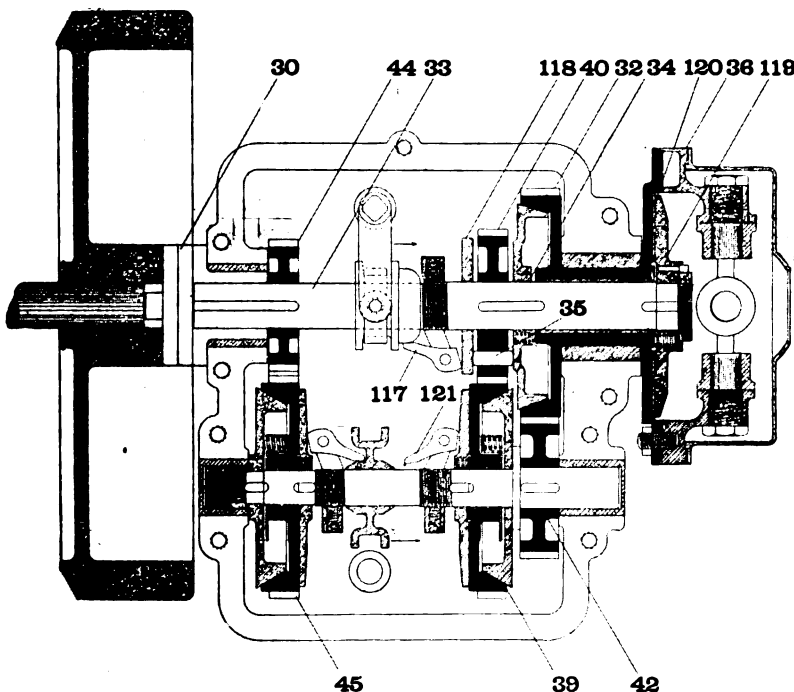

MODIFIED INDIVIDUAL CLUTCH CHANGE SPEED GEARING.

steaming capacity. The same engine is used as before, but the generator is enlarged about 50 per cent. The springs are now 40 and 44 inches long in front and rear, respectively, and the rear springs are attached to shackles at both ends instead of at the front end only, distance rods being added to pre-serve the axle adjustment. The rear wheels are 34 inches in diameter, with 4-inch tires, and the front wheels are 32 by 3 1-2 inches. With a 92-inch wheel base, the car rides with exceptional ease and smoothness even at high speed.

In the power plant all the essential features of the White system are retained, but a notable improvement has been added in the shape of a low gear for hill-climbing, a feature the absence of which from most steam touring cars has been somewhat remarkable, considering the economy in steam to be gained by being able on hills, as well as elsewhere, to work the engine on a short cut-off. Besides removing the necessity for "simpling" the engine for a stiff grade, this feature has in the White car another ad-

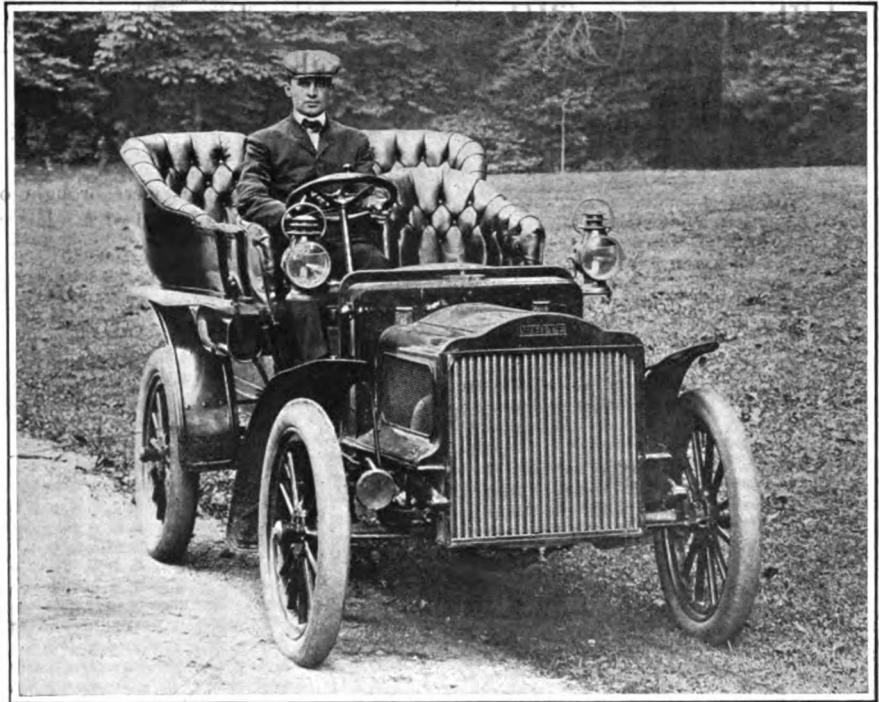

WHITE MODEL E STEAM CAR, FITTED WITH CHANGE SPEED GEAR.

of gasoline and water, and the mileage on one filling is given as 150. The weight of the car is about 2,000 pounds, and it is rated at 15-horsepower.

OMAHA LICENSES NON-TRANSFERABLE

It is given as the opinion of the city attorney of Omaha that the automobile license or permit issued in accordance with the automobile ordinance in force there is in the nature of a personal permit and is not transferable, that is, that a person who owns a

car and takes out a license in his own name to operate it may not legally allow another who is unlicensed to run the machine. If a person owns or operates for his own use or for hire more than one car he must have a permit for each person operating such machines. Dealers and manufacturers may transfer the license number from one machine to another that they are operating to exhibit or demonstrate for sale, but if they desire to demonstrate more than one at a time they must have a permit and number for each car they use.



REAR VIEW OF WHITE CAR.

vantage, in that it produces a proportional increase in the water supply, since the water pump is directly connected to the engine and runs only as fast as the latter. This renders it unnecessary to resort to the hand pump for long hills, a point to which more or less objection has heretofore been made.

The hill-climbing speed is obtained by a pair of sliding gears enclosed in a casing on the rear axle. Between the two speed positions is a neutral point, and this is in itself useful in several ways. It enables the operator to warm up the engine before starting by running it light, so that conditions may be right for speed as soon as he leaves the garage. In case of lack of water in the generator, a supply can be pumped up by power while the car is standing, since even a very small pressure will turn the engine over. In addition, the car is more readily moved about the garage by hand when the gears are out.

The tank capacity will be 15 gallons each

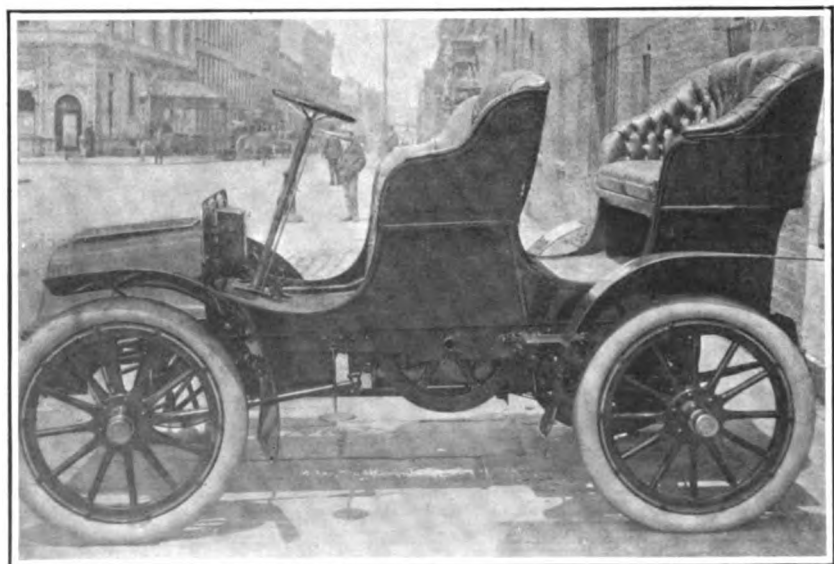

NEW CADILLAC SURREY, FITTED TO MODEL B CHASSIS.

The new Cadillac surrey differs from the regular model B in that it has a surrey body instead of a tonneau, the chassis being the same in every way. A feature of the surrey that will be appreciated by those who delight in touring is the ample stowage space under the rear seat.

Driving Eastward on the National Road.*

"Pathfinders" Returning East Over Southern Route Rejoice in Good Road After Traversing Illinois "Bottoms."

Special Correspondence.

TERRE HAUTE, July 10.—Last Wednesday evening the sights and sounds of St. Louis were left behind and we headed eastward across Illinois. Leaving the exposition city by way of Washington avenue, we crossed the Mississippi on the viaduct to East St. Louis, and, in spite of a heavy shower, made Collinsville that night. Thursday we ran from Collinsville to Vandalia, Friday we made Greenup, and Saturday we pulled into Terre Haute, Ind., where we spent Sunday at the Terre Haute House, designated as the stopping place on the night of August 8 for the A. A. A. touring division from Baltimore and Philadelphia.

On our run down to St. Louis from Chicago we thought we had sounded the depths of Illinois mud, but the mud between St. Louis and Terre Haute is just as black and just as sticky as, and, if possible, deeper

road. Tackle and ropes were brought out once more and with the aid of a telegraph pole—that homely but companionable and useful friend of the tourist—we eventually hauled our car to solid ground.

FORDING THE LITTLE WABASH.

We forded our first river at Effingham, and it is sincerely hoped that it will be the last. As usual, we rushed it, and to that fact alone is due our successful arrival on the opposite bank, for the water came up to the body and the battery was short-circuited in no time. Momentum carried the *Pathfinder* through, however, and we just made the opposite bank. Then the flooring had to be torn up and the battery dried out—an operation that required the greater part of two hours, when a thunder storm overtook us and added a final wetting to the

single car—a runabout or tonneau—but often it is a detachment of from two to five touring cars all loaded with tourists and their baggage and all bound for the big fair. Were the big St. Louis tour to be postponed another month it is doubtful if there would be any auto enthusiasts in the West or Middle West who had not already made the trip, judging by the parties we meet daily.

ON THE NATIONAL HIGHWAY.

Soon after leaving Collinsville we got on to the National Highway and the thought occurred: What an excellent automobile roadway from the East this would make, and how cheaply it could be repaired and put into excellent condition. This highway was constructed by the government in 1840 to aid in the settlement of the West before the railroads were built. The roadbed is about sixty feet wide, and at the time it was constructed this must have been an ideal road. Since the introduction of the railroad no attempt has been made by the government to keep up the National Highway.

If the representatives of the States



CHARACTERISTIC ROAD SCENE IN SOUTHERN ILLINOIS AFTER A HEAVY RAIN—BOTTOMLESS BLACK MUD AND STANDING WATER.

than any we had seen. It is very unusual for deep mud to be encountered in Illinois at this time of the year, say the old inhabitants, but there is more than sufficient of it now.

NAVIGATING ILLINOIS "BOTTOMS."

In the west swampy low lands are designated as "bottoms," and it was a constant succession of bottoms that we ran through between Collinsville and Greenup. The first one we approached we tried to rush as we had rushed many a mire and mudhole on the trip from New York to St. Louis. We struck it fair and square in the middle at about a twenty-five-mile clip. Then the mud struck us. It came up on both sides and over the front, first in streams, then in waves, until the body of the car and the leather suits of the occupants were covered with it. Then the car stopped, right in the middle and deepest part of as fine a frog pond as ever grew in the center of an Illinois

car and passengers. The river was the Little Wabash; the bridge was down, and the usually shallow ford was made deep by continual rains.

AN INTERRUPTED BAPTISM.

An amusing incident occurred just before the city of Terre Haute was reached. A Baptist pastor was holding baptism services in the river beneath a bridge we were obliged to cross. As the congregation, many of whom were in the water awaiting their turn to be immersed, caught sight of the automobile flying down the road, all thoughts of salvation were forgotten in the concern for the horses tied on the opposite side of the river. In less time than it takes to tell, the assembly—converts, sinners and all—had deserted the river and were running across the bridge to get at their horses' heads before the automobile came along.

Ever since leaving St. Louis we have been passing parties of automobilists bound for the exposition. Sometimes it is only a

through which this old turnpike passes would get together at Washington and pass a bill providing for the repair of this roadway by the government, it could easily be reconstructed into a pike sixty feet wide, extending the entire 1,100 miles from Philadelphia to St. Louis, making not only the finest roadway in America, but one of the longest good roads in the world. What a boon it would be to automobilists. This is not a dream; it could be realized if the automobilists of the States traversed would take enough interest in the matter to write their representatives at Washington urging such action.

PERCY F. MEGARGEL.

AN AUTOMOBILE fire engine has been constructed for the private use of Baron Alfred de Rothschild and is installed at Tring Park, his country home in Buckinghamshire, England. The machine can pump 500 gallons of water a minute and will carry eight men and supplies at a speed of thirty miles an hour. It cost \$5,000.

* Continued from page 38, issue of July 9, 1904.—
On the Road to St. Louis

Correspondence

A Little Tour in New England.

Editor THE AUTOMOBILE:

Sir.—Having just completed a little trip in New England under rather difficult conditions, I thought that perhaps a brief account might be of interest to those who contemplate tours in this section. Although I have covered many thousands of miles in my car, through every New England State, and a few outside of that territory, I never dreamt of encountering such roads in my own section of the country as I met in the four-day trip, during which time nearly 600 miles were covered without any attempt at speed.

It had been raining almost daily for two weeks previous, and was extremely cloudy and dismal the day I planned to go. Getting away at 8 o'clock Wednesday morning from Boston, Mass., I went to Worcester in two hours and there called on several automobile friends in the trade, getting away at 11 o'clock and stopping next at the Converse hotel in Palmer for lunch. The proprietor, seeing my car fitted out in touring form, asked if he could accompany me to Springfield, and, of course, he was a welcome passenger.

I had been following a thunder storm for some time during the morning, and when our start was made it was sprinkling, and before we had covered ten miles the rain came down in perfect torrents.

An hour's stop was made in a farmer's barn while the storm was at its height, and then the trip was resumed to Springfield, 100 miles away from the starting point, reaching there in five hours' running time from Boston. I passed the rest of the day with friends in the trade and started early next morning in a rain storm for Pittsfield, 50 miles away.

On reaching Westfield it was raining a little harder than what one cared to be out in with an open car, and I remained over for about two hours.

At Huntington I jumped out at the only hotel to inquire again regarding the roads, and learned that there were three ways of reaching Pittsfield, by going over the Berkshire Mountains. Opinion of choice was divided, so I took the center route, which was through Littleville, Dayville, North Worthington, Peru and Hinsdale.

A crowd in the small town of Huntington soon collected about my car. Some advised me not to continue until the weather cleared, as the roads were practically impassable beyond, they said, and the newspapers reported railroad bridges swept away. I wanted to reach Pittsfield that day, so made a start, while the spectators threw all sorts of questions at me, such as "When do you expect to get there? Got your nerve?" and the like.

A short distance out of Huntington I began to realize that I had been travelling

on good roads, for here I struck streams of water covering the roads about over the tops of my wheels, with mud up to the hubs. For about twenty miles it was almost continually up grade from a 3 to 25 per cent. rise, the top of the grade being the highest inhabited point in Massachusetts. Along the way farmers had been repairing and improving (?) the roads, although they were not working that day on account of the storm. This I appreciated because the roads were so narrow that it would have been difficult to pass a team in some places. Indeed, the road was only a ploughed piece of ground across a field.

Going up over the Peru Mountains I struck extremely sharp pitches, and in these places sod, peat or sawdust had been used in road dressing. In each case, near by was a farmer's house, and on his grounds was a team, all harnessed, waiting for the opportunity to give me assistance, in consideration of a two or three dollar fee. I was advised early in my tour by an automobilist that I would encounter this experience, and he added that one of these farmers had more than paid for his place by the fees he had received from automobile drivers.

But I fooled them. Having three new blankets, I took these out of the car and placed them under the rear wheels. In this way they got traction and I passed over the bad spots. Along level stretches I met some of these mud holes, and by tying rope around my rear wheels, then starting ahead and reversing in my own tracks and starting ahead again, gained a few feet at a time and passed through without assistance.

Pittsfield was reached in the middle of the afternoon, and as it was still raining I decided to remain at the auto station over night. Friday was a clear day, so I covered about 75 miles, giving demonstrations around the Berkshires. Saturday morning I decided to leave for Meriden, Conn., about 8 a. m.

The roads to Springfield had commenced to dry up, and, as the return trip was mostly down grade, although over rough roads, I covered the distance in a little more than three hours.

Leaving there at 3 o'clock I reached Hartford, 26 miles, at 4.15 p. m. Here I met some friends and took them to Meriden in an hour, so that again I covered 100 miles in about five hours' running time. Here I remained over night at Dr. Harold A. Meek's house, which has a garage attached. He is an automobile enthusiast, from the word go, and a friend of Connecticut's Governor, whom he has also interested in the sport.

Sunday I started at 6 o'clock for Boston, reaching there at 4 p. m. On the way I made an hour's stop in Springfield to give demonstrations and rested an hour in Worcester for luncheon.

That night in Boston I covered 60 miles about town, and during the entire trip not a single adjustment or repair of any kind had to be made. In fact, I have run this

Thomas triple-cylinder car since February, some 8,000 miles, without its being laid up five minutes for repairs. I attribute this remarkable record to the fact that I ran my car personally at all times, always keeping it properly adjusted and above all well oiled.

A French car which was run over the road from Pittsfield the day after I returned experienced considerable trouble by the fly wheel striking, and the exhaust pipe was knocked off entirely, going to prove that cars must be specially built for American roads.

CHAS. S. HENSHAW.

Boston, Mass.

Porto Rico Auto Passenger Service.

Editor THE AUTOMOBILE:

Sir.—We have now been operating our automobile stage line in Porto Rico for seven weeks and in that time have missed connections with the train for San Juan just once, which we think is a pretty good record for a start.

The railroad is built from San Juan to Camuy, a distance of sixty miles, and then at Aguadilla, twenty-seven miles east, it starts again and is continued for 100 miles around to Ponce. The completion of the railroad over the intervening space of twenty-seven miles is impractical because the country is very rough and hilly and the traffic would not justify the outlay. Heretofore, through passengers have been taken from one terminal to another in rickety old coaches drawn by miserable little horses hardly larger than "jackrabbits." We thought this offered a good opening for automobile service and, though our troubles have been many, we are satisfied that our venture is going to be a great success.

Already a Spanish company has been organized and a man sent to "the States" to buy machines to compete with ours, so before long there will be a continuous endurance contest going on in Porto Rico.

We are using three 8-horsepower, air-cooled Knox machines, fitted with wagonette bodies and Springfield tops and geared down to seventeen miles an hour. We made a great mistake in using solid tires instead of pneumatic. To the terrific vibration caused by the solid tires we attribute all of our breaks in the machinery and we have now ordered a full equipment of Tennant tires. Whether they will solve the problem or not remains to be seen.

This twenty-seven mile stretch of road was to have been macadamized by May 1, but when we arrived we found there remained about ten miles unfinished. Since May 1 about six miles have been completed and we still have four miles of sand, rocks, ruts, ditches and everything that goes to make a road bad. Another month, however, will see the end and we shall then have twenty-seven miles of Central Park, except that there are some fearful hills. One hill, one mile in length, has an average grade of 15 per cent.—not an auto-



OUR COMPETITOR FOR PASSENGER BUSINESS.



PORTO RICAN FREIGHTING METHOD.



THE NATIVES LEND A HAND.

mobile salesman's 15 per cent., but an actual grade. If you will stretch the Lexington Avenue hill at 102nd street out for a mile and give it a few curves, you will have some idea of this grade. Every day we take from three to eight passengers and from 100 to 500 pounds of baggage up this hill on one machine.

We meet the train from San Juan when it arrives in Camuy and take the passengers and baggage through to Aguadilla. By the time we reach Aguadilla, the train from the south is in and we return with the north-bound passengers, consuming just four and a half hours for the round trip.

Our service began on the first day of May. It was a hot, dusty morning when the train arrived at the little station in Camuy, with seven passengers and four trunks to go to Aguadilla. We loaded them into one machine and I took the wheel and started on our first trip. The barking of dogs, the cheering of the natives and the hiss of the little French engine blowing off steam made it sound like a diminutive Fourth of July.

For the first two miles the road was good and I "let her out," if you can call seventeen miles an hour "letting her out." It was record-breaking speed for the passengers and to see the "ji bara" take to the woods was great fun. Then the bad roads began—deep washes and boulders as big as a man's head covered the way and it meant very slow, careful driving.

The little towns of Quebradillas and Isa-

bella, through which we passed, turned out in full force to see us go through. We reached Aguadilla without a stop in two hours and fifteen minutes. By some mistake all the northbound passengers had been informed that the automobiles would not start running until the next day, so the wagonette went back empty.

Since that day we have had one machine and sometimes two making the trip daily, but on the third day's run our troubles began and for three weeks we had nothing else. As I was driving slowly over the worst stretch of road that day the engine stopped. Examination showed that the arm which holds the cylinder to the frame had snapped off short. There we were, stranded eighteen miles from destination with three passengers who had to take the boat for the United States the next day. At once I hired a coach to take them to Camuy and telegraphed the railroad company for an engine to carry them on to San Juan. The engine was sent and the passengers made their boat.

Mr. Hodges, being informed of my plight, came out from Camuy, bringing another cylinder. The disabled machine was hauled to Isabella, when we worked from 6 o'clock until 2 the next morning, putting in the new cylinder, and then started for Camuy. Imagine our feelings when, a few miles out of Isabella, the second cylinder broke in exactly the same place. This time we towed the machine into Camuy, arriving at daylight. After breakfast we looked over the

sound machine and, finding it all right, were ready when the train came in.

I made the run this day and had no trouble except to keep awake, but we had used our only extra cylinder and had one machine out of business entirely.

The coach drivers, "standing in" with the road builders, now commenced to put obstacles in our way, and in several places the road was blocked so that we had to drive through the fields or, if it was wet, be pulled through with a yoke of oxen to the next place where the road was passable. The oxdrivers also undertook to block the way and often refused to give us room to pass. That annoyance is over now, however, as Mr. Hodges (one of our drivers) is of a belligerent disposition and after he had gently but firmly thrashed a few of them, the drivers gave us all the room we wanted. The second week of our service there was some kind of a break nearly every day and all were traceable to the vibration. A truss rod broke one day and the back axle the next. But in every case we were able to bolster up the breaks and always got in on time for the train.

On one trip Mr. Hodges was running along all right on the good part of the road, when he and a passenger beside him were thrown over the baggage in front. Fortunately, they were not hurt and investigation showed that the trouble was only a broken spindle in the front wheel. It bent the front axle, the front mud fender, a lamp and the arm that holds the steering check



TREE-FERNS NEAR ISABELLA.

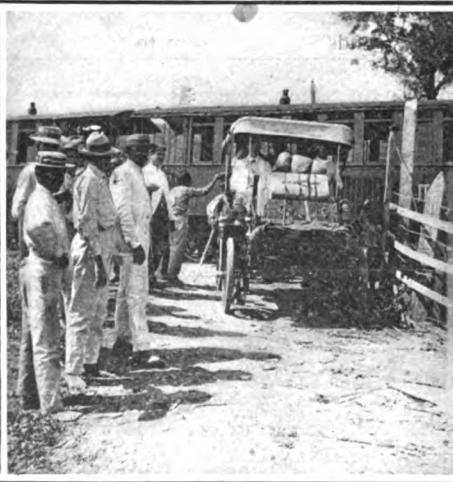

LEAVING CAMUY RAILROAD TERMINUS.



BREAKING STONE FOR MACADAM ROAD.

to the axle. In twenty minutes another spindle was in place and the machine on the road again. Camuy was reached in time for the train, but with a load of passengers who said "Never again an automobile for us."

We had feared this sort of a break from the first, as the vibration caused by running at good speed over bad roads with solid tires must tend to crystallize the metal in the spindle. There has been no trouble whatever with the working of the engines. With pneumatic tires, I think we should not have had a single break, but pneumatic tires are too expensive and uncertain for our work and we are waiting patiently for the man whose tire will solve the problem.

Our machines have not been in operation long enough to give any statistics on the wear of parts. The one most used registers 2,330 miles, and on this there is no play in any bearing and no part worn to any extent except the tires, and they are down to within an inch of the rim. We average burning out a brake-band every week, as the heavy loads and long steep hills make it necessary to use the brakes half the time; but the leather to cover them again costs but a few cents.

When it is remembered that the Spanish countries in South America have many miles of good roads and but few miles of railroad, this experimenting will be of value to manufacturers who are building cars for practical, commercial service rather than pleasure. For this work it is necessary to have cars that will run day in and day out without a break, as repair shops are many miles apart.

C. H. MARTIN.

Camuy, Porto Rico.

Automobile Drives a Shop.

Editor THE AUTOMOBILE:

Sir—On a recent afternoon, a lightning storm burned out the motor running the machinery in the shop of a local garage. As they were very busy at the time something

was done, as will be seen by the accompanying photograph, and has given good satisfaction. The car used was a Rambler runabout, and furnishes all the power needed in the shop until the repairs can be made to the damaged motor.

W. N. G. C.

Asbury Park, N. J.

Swinehart Solid Tire.

A representative of this publication had an opportunity recently to inspect closely the Swinehart "solid clincher" automobile tires, and found matter of interest both in their performance, as shown by a trial spin, and in the very ingenious means by which they may be attached to the standard pattern clincher rim. The general form of the tire, as shown by the illustration, is already familiar. Its special feature, by reason of which the makers claim that it is adapted not only to delivery wagons and electrics, but also to steam and gasoline pleasure vehicles of moderate speeds, is the unusual depth of section, which is combined with a slightly broadened tread to give durability. Owing to these features, coupled with the use of an elastic grade of rubber, the compressibility of the tire is much greater than that of the ordinary solid tire.

The mode of attachment is both simple and exceptionally rigid, and dispenses altogether with the customary circular tie wires. It depends primarily on the use of numerous short stiff cross-wires, each extending from the upper surface of the "clinch" or bead to the further side of a central groove in the base of the tire. The wires are spaced about an inch apart, and are "staggered" with respect to the right and left sides of the tire. A strip of canvas lines the base of the tire and the inside of the groove, and the wires, abutting against the sides of the groove, are prevented thereby from working away from the edge of the clinch. Creeping is pre-

quired to get it into the rim. The process of doing this is as follows:

First the tire itself is warmed, and the fabric painted with hot cement. Meanwhile the wheel itself, detached from the axle, is mounted on a horizontal stud in a frame and spun, while a torch is applied to the rim till the latter is hot. Cement is applied, and the warm tire stretched over the rim with one clinch in place. To get the other under the edge of the rim, the wheel and tire are gripped in the frame, and by means of a lever with a projecting notch the end of each wire in turn is caught and forced sidewise—i.e., along the length of the tire,

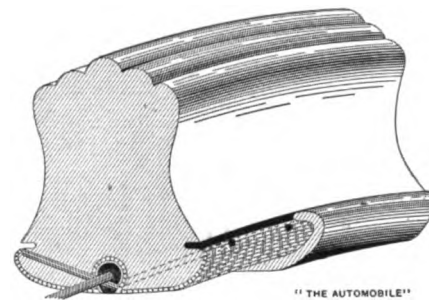

SOLID TIRE ATTACHED TO RIM.

—the surrounding rubber yielding with it, till the wire is sufficiently askew to go under the edge of the rim. With a long leverage this is quickly accomplished, and the pins are rapidly forced into place before the rim cools. The central groove becomes filled with cement, which on hardening prevents the inner ends of the wires from slipping past the edges of the groove.

The tire is removed by putting the wheel bodily into an oven and heating it till the cement melts, or by making use of the iron wire which runs centrally through the cement-filled groove. The ends of this wire are brought out through the disused valve stem hole, now filled by a $\frac{1}{8}$ -inch gas pipe plug which covers the ends of the wires. By taking out the plug and connecting the ends of the wire to a source of electric current, the wire is made to heat and melt the cement around it. When the cement is hot, the process of detachment is practically the reverse of attaching the tire.

The conclusion reached in the trial trip already referred to was that, although the Swinehart tire falls considerably short of the resiliency of pneumatics, it adds very measurably to the field of usefulness of the solid tire. So far as the passengers are concerned, there is not much to choose between it and pneumatics at moderate speeds and on fairly good roads, since the springs absorb most of the jar; but whether a live rear axle would long endure the jar would depend a good deal on its construction. With the side chain drive there should be little difficulty in getting good results, and the tires should be successful also on the front wheels unless possibly in motor-front cars, some parts of whose mechanism might suffer. Among business vehicles the tire should be most successful.



RUNNING MACHINERY IN A GARAGE TEMPORARILY WITH AN AUTOMOBILE.

had to be done and done quickly. After much discussion, some one suggested the experiment of attaching the main pulley belt to the flywheel of an automobile, which

vented and the canvas protected from rotting by cementing the tire solidly to the rim with gutta percha cement. As the base of the tire is quite stiff, some force is re-

HINTS ON OPERATING A RUNABOUT.

AN automobile is like any other machine in many respects, and should be treated accordingly. It should be used with due regard to the work for which the manufacturers designed and built it. A light runabout is not a touring car and is not, properly speaking, a four-passenger vehicle. There is no doubt that the light car will stand up under a good deal of touring, with proper care, but the wear and tear on the machinery is bound to be greater than when the car is used under normal conditions, and it should not occasion surprise if more than usual attention and more frequent renewals are required. Then there is the extra passenger question. Almost any runabout can be fitted with an extra seat for the accommodation of two passengers more than the normal capacity of the machine, and no trouble will be experienced on smooth roads; but on rough or hilly roads the matter assumes a different aspect. The same springs cannot be made to carry four passengers with the comfort and safety with which they will carry two. If they are built for four, they will not be entirely comfortable for two, and vice versa; for the overloaded springs will leave most of the work of absorbing shocks to the tires, and a rough passage may be expected. With a heavy car of the touring type it will, of course, be different, as the proportionate weight of the passengers is less and the springs are larger and have a greater range of movement. So if you want to take out a couple of extra passengers in your light runabout, stick to smooth and level roads, and do not overwork your engine or expect the car to do work for which it is not adapted. If much touring is to be done, or if it is desired to carry more than two passengers most of the time, a heavier type of vehicle should be used.

* * *

One of the laughable performances sometimes seen when a novice is handling a car is the attempt to speed up the car by pressing down the accelerator with one foot while the other is firmly holding down the brake. This is not such an uncommon occurrence as one might imagine; only it does not usually come to light, and persons who do such things are not, as a rule, the most anxious to talk about them. This is one of the things that may very well be left undone.

* * *

When you have become somewhat expert in the running of your car it will be found advantageous to gradually cut down the gasoline feed until you find the point at which the motor runs well, but will not stand a further reduction. The smaller the proportion of gasoline the more economically the motor will run and the cleaner it will keep. This can, of course, be carried to extremes and the efficiency of the en-

gine interfered with; but the proper feed can be determined without great difficulty. The same process should be applied also to the cylinder lubrication. When the gasoline and lubricating oil are feeding into the cylinder in the smallest quantities that will produce good results, the motor should run for a long time without fouling the spark plug and on the minimum amount of fuel.

* * *

The practice of doing everything possible to avoid frightening horses and causing annoyance to horse drivers is one that should be encouraged. The automobile is still in the minority on the road, and though it certainly has equal rights with other users of the highway, and the automobilist should not permit himself to be imposed upon, still it is the best policy to make as many friends as possible for the good of automobiling generally. The old saw concerning prevention and cure is exceedingly applicable to meetings between horses and automobiles. If you are a frequent traveller over the same roads you will soon see the result of your good work in this direction. One thing that should be avoided as much as possible is the continuous use of the horn. Use it when necessary, but do not be lavish in your solos, for it is a species of music that few are capable of appreciating.

* * *

If the porcelain breaks in the spark plug, or if a valve breaks, note very carefully whether any of the pieces have got into the cylinder. If so they should be removed before attempting to run the motor, as it does not take a piece of steel or a few chips of hard porcelain a very long time to so cut a cylinder that it must be renewed. As a rule, cylinder walls are not of sufficient thickness to permit reboring if it is necessary to take off more than the merest suspicion of a cut, and a few chips caught by the piston can make pretty deep grooves the entire length of the stroke.

* * *

A rather curious incident that occurred a short time ago well illustrates what effects may be produced by the constant vibration of an automobile, like the constant dropping of water on a rock. The owner of a runabout was making a new joint at the coupling of a gasoline pipe, and after finishing the job and screwing everything up tight found that he had left a small brass nut loose on the pipe, which had a single turn in it to prevent breakage by vibration. Thinking it would do no harm, and that it was not worth while to break the joint and remove it, he left it on the pipe and speedily forgot all about it. A few months later he sold the machine with the nut still where he had left it. The new owner ran the car for about a month, when a leak developed in the gasoline pipe, and it was found, upon

investigation, that the nut had worn a hole right through the brass tube, necessitating the purchase of a new one.

* * *

A metal pipe, if broken off, can be temporarily repaired by connecting the broken ends with rubber tubing or hose of the right size and binding the ends tightly with wire or twine. A mere leak may be stopped with tape, if small, or with a piece of patching rubber held down by tape, if larger. In making use of rubber cement, patching rubber, tire tape, rubber tubing or anything made of or containing rubber in any form, bear in mind that rubber is soluble in gasoline and will not hold it long.

* * *

If you have an inspection pit in your auto house, be very careful that it does not get filled with gasoline vapor, which will, if given an opportunity, accumulate in the pit and only a touch of flame or spark will cause an explosion that may do a great deal of damage. The vapor also has a very unpleasant physical effect upon any one who breathes it, causing dizziness and headache difficult to get rid of. An accumulation of vapor may be caused by drippings from the car, or gasoline spilled while filling the tank.

* * *

If battery cells are not secured against jumping around in the battery box there is a strong possibility of their short-circuiting, either momentarily or continuously. This may or may not affect the sparking of the motor at once, but will shorten the life of the battery. Keep the cells well packed or in some way secured against movement.

* * *

Dry batteries and induction coils should be kept as far as possible from heat. The cement used in sealing the dry batteries melts rather easily and if this is permitted mysterious troubles may result. In the case of the induction coil, the paraffin wax frequently used for insulation is very apt to melt and run out, and will not only leave the coil in bad shape, but will, if it gets on the vibrator or on any of the contact surfaces, interrupt the flow of electricity and so stop the motor.

* * *

A good way to make a guide for setting the sparking points of a plug is to insert the blade of your knife between properly set points, mark the place on the blade and use this as a gauge. This is usually more convenient than carrying a separate gauge, which may easily be lost or misplaced, while your knife is pretty sure to be at hand when wanted.

* * *

A rubber connecting pipe may be repaired, if leaking or burst, with a tire patch well bound with tape.

Patents

Compound Gas Engine.

No. 762,421.—A. Leingartner, of Milwaukee, Wis.

A compound gas engine of the type frequently proposed, having one vertical low pressure cylinder between two high pressure cylinders, the two latter exhausting alternately into the former. The especial feature of this engine is an arrangement of valves, the inlet and transfer valves on one side and the exhaust valves on the other, by which, through the simultaneous endwise shifting of the two cam shafts, the engine is converted from compound to simple acting.

Detachable Link Sprocket Chain.

Nos. 762,045 and 762,046.—W. H. Gates, of Worcester, Mass.

Chains with slotted side links 2 3 and means for preventing the escape of pins

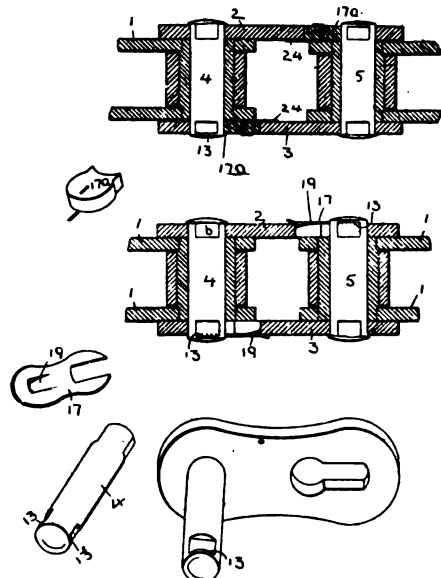

GATES DETACHABLE LINK CHAIN.

4 5 from the side links when assembled. In No. 762,045 this means consists of a flexible pad 17a of leather or felt, held in place by a bit of bent wire 24. In No. 762,046 a stamped sheet metal guard 17 is used, which is slipped under the lips 13 of the pins and held in place by the tongue 19. The pins and links have the same form in both devices, one end only of each pin being lipped, and the other riveted.

Battery Plate.

No. 763,322.—H. C. Porter, of Waukegan, Ill.

The grid is a lead casting having two continuous faces connected by narrow bridges B B at intervals. The active material is introduced either in a pasty condition or in the form of tablets, as seen in the detail at the left, and the sides of the plate are then perforated, the edges being forced into the active material.

Oil Can.
No. 762,300.—W. M. Fulton, of Knoxville, Tenn.

An oil can having a portion at the bottom or elsewhere formed with corrugated sides 3, and protected by the walls of the

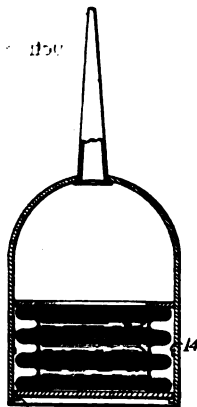

FULTON OIL CAN.

can and by the loose bottom 15, to which a stop 14 may be added. Thus pressure enough may be applied to the oil to feed it even if very stiff.

Lock-Nut for Spark Coil Vibrator.

No. 762,993.—C. H. Fischer, of Cincinnati, O.

In the drawing H represents the vibrator spring, whose tension is adjusted by the screw N at whose end are two collars n n' by which the spring is advanced or retracted with a screw. This screw is locked by a nut O, which screws over a projecting sleeve M formed integrally with the mounting L and split or slotted so that its tapered end is squeezed together on the screw by the nut O. The contact screw Q is locked in the same way by the nut R tightening up or squeezing together the ends of the sleeve P.

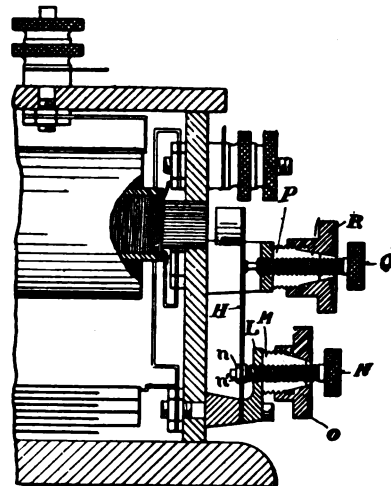

FISCHER VIBRATOR LOCK-NUT.

Mechanical Fuel Feed Device.

No. 762,965.—L. F. Washburne, of San Francisco.

A fuel pump actuated by the explosion pressure, and intended to distinguish auto-

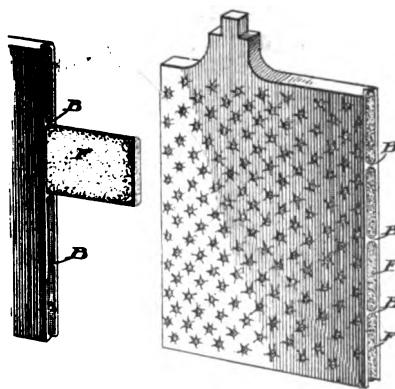

PORTER BATTERY PLATE.

matically between two weak explosions, one being weak from a lack of fuel and the other from an excess. In the drawings, 1 is the pump barrel and 2 the pipe connecting

to the combustion chamber. The piston rod 4 bears on a false bottom 5 instead of on the plunger head 7, to protect the fuel from the heat of the latter. Fuel is drawn in through ball check 27 and pumped to the vaporizer through check 29. In a general way the lift of the plunger and therefore the amount of fuel—which apparently is intended to be kerosene or distillate—is proportional to the force of the explosion. To differentiate between a weak explosion due to too little and one due to too much fuel, advantage is taken of the fact that the combustion in the former case is much more rapid, the explosion pressure being high, but falling off rapidly by cooling before the piston has time to expand the charge. Instead of allowing the plunger to go up freely, opposed only by the spring 17, like an indicator piston, it is made to accelerate a swinging weight 34 connected to shaft 14. This causes the movement of the plunger under the impulse due to a lean mixture to be less abrupt and more prolonged. It is claimed by the inventor that this device

works very well. The radius of the weight 34 may be adjusted by raising or lowering it on rod 32. The left end of pipe 2 opens into the air, and on the suction stroke a little air is drawn in through check valve 31 to cool the plunger.

Metal Wheel.

No. 763,145.—J. A. Brennan, of West Orange, N. J.

A disk-wheel comprising two pressed steel disks as shown with a cast or forged nut. The edges of the disks are flared outwardly at 23 and are then bent in again upon themselves and held by rivets 25 to form a smooth set for the tire. The frame thus formed is supported by bosses 29 pressed at intervals around the rim.

Storage Battery.

No. 763,321.—H. C. Porter, of Waukegan, Ill.

A battery having special devices for retaining the active material on the grids, and for catching the same in case of its

detachment from the grids in such manner that it will not short circuit the plates at the bottom of the cell. The inventor states that with the ordinary insulating supporting blocks under the grids, the latter object is not fully attained, as the material detached is slimy and adhesive, so that it clings to the blocks and eventually forms an electric bridge between the plates. To aid in retaining the active material the plate is surrounded by a casing *c*, of sheet lead, which is perforated with numerous small

the end of which, striking the cone *21*, they are again deflected backward into the cone by the plate *23* whose center is cut out at *24*. Thus the muffler acts by deflecting the gases back upon themselves instead of by numerous baffle plates.

bolts *16*. These wedges are backed by castings *7* riveted to ears *3*. Fig. 3 is a section on line III III.

THE LOCAL MANUFACTURE and use of automobiles are discussed by United States Consul Fleming, of Edinburgh, Scotland, in a report published in the *Consular Bulletin*. From this it appears that Scotland is slow to fall into line on the automobile question, and the early automobilists in that country had a pretty hard time of it. The

Frame Construction.

No. 761,690.—A. A. & L. H. Martell, of Elwood City, Pa.

A pressed steel frame intended chiefly for heavy trucks. The axles are guided by

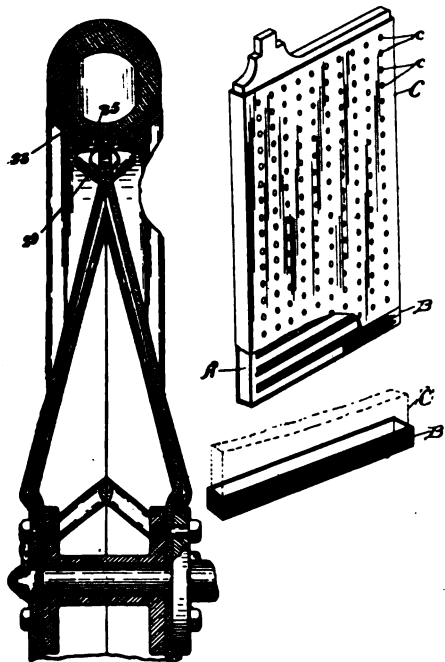

BRENNAN WHEEL. PORTER BATTER GRID.

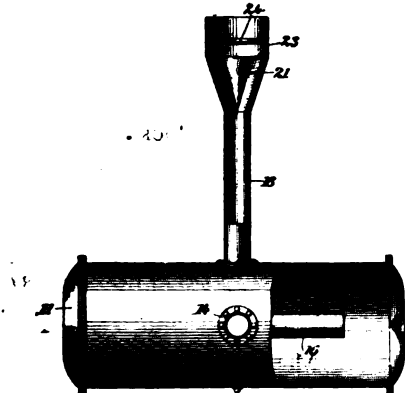

ULLOM MUFFLER.

holes *c*, the edges of the holes being turned inward into the active material. At the bottom of the plate is a pocket *B* of hard rubber or the like, which catches any detached active material. The customary insulating blocks are preferably retained.

Muffler.

No. 763,221.—I. B. Ullom, of Claysville, Pa.

The exhaust gases enter by the pipe *14* which has a tee branch inside the muffler, one arm *16* being seen. The gases issuing from *16* are deflected back by the dished ends *11* and pass out through pipe *18*, at

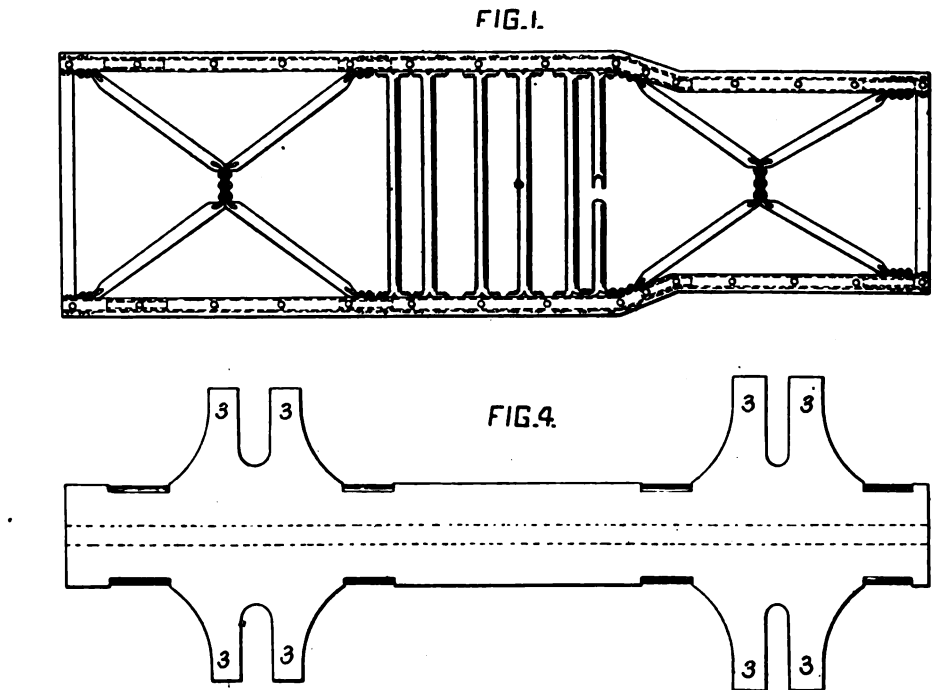

PLAN VIEW OF MARTELL PRESSED STEEL FRAME AND BLANK.

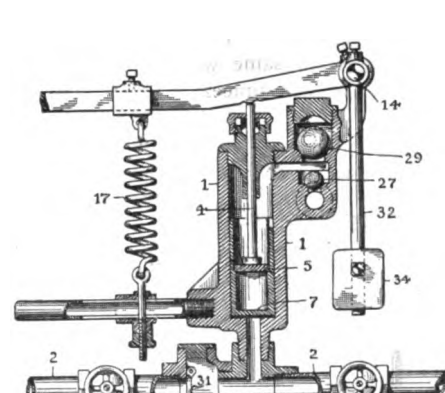

WASHBURNE FUEL FEED DEVICE.

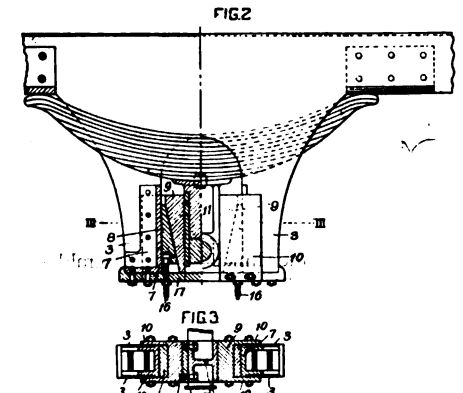

DETAILS OF MARTELL PEDESTAL.

pedestals, both ends of all the springs being free, and the pedestals are formed integral with the side members. The latter have the form of an inverted U, and the pedestals are formed of ears *3 3*. Figs. 1 and 4 show respectively a plan view of the frame and the blank from which the side members are pressed. Figs. 2 and 3 show details of the pedestal, spring seat and axle bearing. As seen, the spring seat *11* is an H-section casting, with the axle bearing in its base. It moves freely vertically between wedge guides *9*, having ears *10*, which keep them in place. Wear is taken up by adjusting wedges *8* by the

pioneers apparently had not much regard for the rights of other users of the road, or not as much as they should have had, and, being mostly tourists, generally managed to take themselves off immediately after any little unpleasantness, leaving the residents to vent their wrath upon automobilists to come. This practice has been followed regularly up to quite recently, when Parliamentary speed and other regulations somewhat cooled the anger of the wronged, and protected the unoffending motorists from being visited with the sins of their predecessors on the road. The speed allowed is 20 miles in the country and 12 miles in the city.



VOL. XI.

No. 3

Published every Saturday by

THE CLASS JOURNAL CO.,

Flatiron Building, Madison Square,
NEW YORK CITY.Cable Address - - - Autoland, New York
Long Distance Telephone - 300 Gramercy, New York

SUBSCRIPTION RATES:

United States, Canada and Mexico, - One Year, \$2.00
Other Countries in Postal Union, - One Year, \$3.00To Subscribers—Do not send money by ordinary mail.
Remit by Draft, Post-Office or Express Money Order,
or Register your letter.

FOREIGN SUBSCRIPTION AGENTS:

ENGLAND:—Iliffe & Sons, Limited, 3 St. Bride Street,
Ludgate Circus, London, E. C.FRANCE:—Boyveau & Chevillet, 22 Rue de la Banque,
Paris.

GERMANY:—A. Seydel, Mohrenstrasse 9, Berlin.

To Advertisers—Copy or changes in orders for advertisements should reach us not later than 5 o'clock p. m. Monday for the issue of Saturday following.

Copyright, 1904, by The Class Journal Company.
Entered at New York, N. Y., as second-class matter.

The Automobile is a consolidation of The Automobile (monthly) and the Motor Review (weekly).

Copies Printed This Issue, - - 12,000
" " Since Jan. 1, - 349,300**Climb to the Clouds.**

The poetic and the practical were very happily mingled in the "Climb to the Clouds" contest in the White Mountains last Monday and Tuesday. Never before has an automobile contest been held in this country, and probably not abroad, amid such majestic surroundings as the two days' hill climb on Mount Washington. The setting was a subject for a great artist, and worthy to go down to coming generations in imperishable oils rather than ephemeral words.

Starting from a little sheltered leafy glen in the deep folds of the range, the narrow road leads through the woods at the base up the pine-clad slope till the timber line is crossed. Here the storm-worn rocks shelter little alpine flowers that prettily color the barren ground. At each turn, and they are many, a noble view unfolds, and as one ascends the white drifting clouds pass silently by in dissolving view effects.

On the practical side the course is a demonstration ground that could hardly be excelled. From start to finish a steady drive is needed. There is no chance for jockeying, and the contestant knows that, watch in hand, the group on top is waiting. Nothing will help but progress—onward, upward. Motor and transmission and car must perform their several functions to the limit of endurance every foot of the way. It is a supreme test of man and machine.

Many manufacturers who did not enter cars will regret their decision. The honor

of record making in this climb is not empty, but will be surely measurable in dollars and cents when the purchasing public learns the facts.

There is no reason why the Mount Washington climb should not become a great international event. The place is easy of access, the course ideal, and the hotel accommodations are adequate in quantity and splendid in quality. With energetic management it is a combination that will win.

**Glidden Endurance Cup.**

Charles J. Glidden, the well-known Bostonian who has made several long-distance automobile tours in Europe during the past three years, has expressed his intention of offering an international cup for long-distance touring in this country. Although no details have yet been fixed on, it is understood to be Mr. Glidden's wish to make the contests distinctly of a touring character, in which reliability and not speed will win the prize. So far as possible, the private owner will be encouraged to enter, and it is hoped that this trophy will bear the same relation to touring contests that the Gordon Bennett cup does to speed contests.

Such a competition as the above is peculiarly suited to this country, where public sentiment is strongly opposed to extreme speed. With pure speed eliminated as a factor, the amateur will find it much easier to compete than when a special car must be built at enormous cost for that particular event; and the results, if the speed limit is not below that of ordinary touring, may be more valuable. Mr. Glidden deserves warm praise for his sportsmanlike and patriotic offer, the details of which will be awaited with great interest.

**Failure to Amalgamate.**

It must be confessed that the explanations, as published on another page, of the collapse of negotiations for the merger of the American Automobile Association and the American Motor League fall considerably short of being either complete or satisfactory. If we suppose, as has generally been assumed, that the American Motor League is at all strong enough to be a desirable partner, and if it is liable to be working at cross-purposes with the A. A. A. unless merged with the latter, the members of both organizations are entitled to a better reason for the failure to come to terms than is contained in the admirably non-committal statement of President Whipple. "There will be no merger because we can't agree." "But what were your differences, and were they really insuperable?" "Our word for it, they were. Trust us." Such in effect, if not in language, is the attitude of the A. A. A. Board of Directors. There is a humorous side, however, to this pose of Olympian impeccability, and one can at least imagine some things that would justify it, as well as some others which would not. It is at

least satisfactory to learn that the seemingly impossible original demand of the A. A. A., that only club members should be represented, was modified by giving the club a definition elastic enough to fit the smallest village.

On the other hand, President Potter's statements deal overmuch with the, after all, rather technical question of the instructions of the committee on constitution and by-laws, and leave the impression that if the A. A. A. officials were willing to put themselves apparently in the wrong by disregarding the letter of the plan of merger, there must have been some strong reason for it. The two most tangible hints as to the nature of this reason—that the A. M. L. committee wanted a plan of representation which would open the way to wire pulling and personal politics, and that the strength and standing of the League had been found to be overrated—are not satisfactorily covered in President Potter's statements.

The most plausible explanation of the deadlock is to suppose that some reason, unsuspected when the plan of merger was framed, arose to make amalgamation seem disadvantageous to the A. A. A. On the facts as known, either of the possible reasons just noted might have existed, and it would not be strange if both were true.

**Coachmen as Chauffeurs.**

It is a common observation among private owners who have discarded horses for automobiles that their coachmen can readily be taught the ordinary care of the latter, and that as drivers they are much more efficient and satisfactory than the chauffeur who has graduated from the factory or repair shop. Although at first blush this seems rather contrary to the natural order of things, and doubtless was so a few years ago, it is to-day perfectly logical. The total management of the car comprises the three separate heads of driving, ordinary care, and repair. The first named covers the ordinary road manipulation as to turns, hills, rules of the road, etc., and is very quickly absorbed by a horse driver of fair intelligence, because it is so closely related to his past experience. The second calls for a moderate amount of mechanical knowledge, and the third may call for a good deal.

The third item is, of course, the factory-made chauffeur's strong card; but the importance of this item is becoming less rather than more, as construction is each year improved and difficult repairs are less frequent. Against this is the fact that the ailment known as the "big head" is alarmingly epidemic among this class of drivers, and their willingness to drive with decent regard to other road users is correspondingly small. This, of course, reacts on the condition of the car, which loses by rough usage what it gains in expertness of subsequent repairs. As the demand for chauffeurs is greater than the supply, many men

calling themselves such have the arrogance of the class without the mechanical skill, and by their recklessness and extravagance make themselves simple nuisances.

The coachman, on the other hand, rates his really valuable driving experience below its true worth, and, confessing ignorance of mechanical things, is anxious to learn. He must, of course, have the mechanical instinct, but this is often latent when least suspected; and in addition his previous training has tended to make him steady and industrious, and has given him none of the conceit of the man who thinks he had a "cinch" on his "job." He is far more likely to be merciful to his car, and when he can have the right sort of instruction, the result is very apt to be most gratifying.



Harry S. Harkness, the millionaire law-breaker, is much disgusted because other people besides himself insist on talking about his late unedifying exploit in driving from Boston to New York at an average speed of 45 miles an hour,—and talking, too, in a tone by no means in keeping with his own. He says, what everybody knows, that the run was made early Sunday morning, when there were only a few people in the way of being run over, and he thinks that should excuse him. Some one should tell him that the laws are made to be obeyed early Sunday morning as well as at other times. That is a poor excuse to pacify a New England village.



The projected Iroquois Memorial Hospital, Chicago, is to have, not an automobile ambulance, but an automobile emergency hospital, if the hopes of its directors are not disappointed. It is planned to have about the biggest affair that can be put on wheels, with nurses and surgeons at hand, to answer a hurry call on the shortest notice. It is a large order, but there are builders who could fill it.



Farmer antagonists of the automobile in Wisconsin are reported to have dumped loads of gravel in the road to impede the progress of the members of the Chicago Automobile Club who participated in the recent club run to Waukesha and Cconomowoc. Tourists through the Illinois "bot-toms" would welcome such methods on the part of the agricultural population.



A Denver barber had his ear nearly torn off by collision with an automobile driven by a local doctor, who postponed a trip to Europe to perform a skin grafting operation upon his victim. This is a sort of automobile graft that few would care to share in.



Moonlight runs have become popular with automobile clubs in widely separated parts of the country.

CALIFORNIA ENDURANCE RUN.

Rules Provide Pleasant Touring Conditions So That Women May Compete.

Special Correspondence.

SAN FRANCISCO, July 2.—H. C. Brown, chairman of the racing committee of the Automobile Club of Southern California, was in San Francisco recently, and after discussing with Chairman L. P. Lowe, of the racing committee of the A. C. of California, the conditions for the proposed endurance contest between San Francisco and Los Angeles, came to an agreement with him. The date has not been settled because several high-powered cars ordered by San Francisco dealers and private owners have not yet arrived. The cars should, however, be in this city in the course of two or three weeks. In that case, the endurance run will be held in July. If the cars (as is highly probable) do not arrive in time for a July event, the run will be postponed until after the annual meet of the Automobile Club of California at Del Monte.

The managers intend to make stringent rules against speeding and to inflict severe penalties for their infringement. The maximum speed to be permitted is a mile in four minutes, or fifteen miles an hour. The route has been laid out in such a way that cars starting at 8 A. M. can reach controls as early as 3 P. M., or up to 8 P. M. A car that reaches a control before the time fixed will be disqualified.

On the run from San Francisco to Los Angeles the first control will be at Salinas, in Monterey County; the second at San Luis Obispo; the third at Santa Barbara, and the fourth at Los Angeles—all in the counties of the same names. The longest day's run will be about 140 miles. The start from controls will be made at 7 A. M. on one morning and at 8 A. M. on other mornings. All the cars can reach the controls without difficulty before dark; and it is probable that most of the party will complete the run by 4 P. M. each day.

It is calculated that, with the limitation of speed to fifteen miles an hour, the run from San Francisco to Los Angeles and back will occupy 3,600 minutes. Each car will start with a credit of 3,600 points, one point being deducted for each minute of each penalized stop. The car that has the greatest number of points on the completion of the run will be pronounced the winner.

In order to encourage the travelers to take photographs along the route, stops made for this purpose will not be penalized. Delay caused by difficulties with tires will not be penalized, it being thought that punctures and other mishaps to tires are a matter of luck, and that penalties for stops on this account are unfair.

A stop of half an hour at noon, one of a quarter of an hour in the forenoon and one of the same length in the afternoon will be allowed without penalty, with the idea of rendering the run more pleasant and to prevent it from becoming irksome, especially to any women who may make the journey. The conditions have been made such as to allow women to drive their own cars and to encourage them to take part in the event. Stops due to blocked railroad crossings will not be subject to penalty. Gasoline or water may not be taken on during the morning or afternoon stops, but are to be taken on at noon or at the controls reached at the end of each day's run.

The committees in charge of the run will appoint an observer on each car, observers to be selected, as far as possible, from men on the staffs of the daily newspapers. The

nature of every stop will be determined from the reports of the observers. Judges will travel from control to control by railroad, and upon their reports and those of the observers the winners will be determined.

The run of the Automobile Club of California will be from San Francisco to Los Angeles and return. The cars of the Automobile Club of Southern California will join the San Francisco machines at Los Angeles, and accompany them to San Francisco. The southerners' contest will be completed on their return to Los Angeles. The northern automobilists will spend an entire day at Los Angeles and will be entertained there by the members of the Automobile Club of Southern California. The southerners will spend a day in San Francisco as the guests of the Automobile Club of California.

Cars entering the endurance contest are to be touring cars carrying at least two passengers apiece and an equivalent of four passengers weighing 165 pounds each, or 660 pounds in all. A car that does not carry a complement of passengers must make up the required weight, without reckoning gasoline, water or other supplies. Cars will be divided into one-cylinder, two-cylinder, three-cylinder and four-cylinder classes. There will be prizes in each class and also a prize in the open class. Prizes will be given by each club individually and by the two clubs jointly; also prizes awarded according to the consumption of gasoline.

The entrance fee for each car is \$50, \$40 to be repaid if the car actually starts in the run. It is hoped that all the entries made will be in good faith, and with this idea the rebate has been fixed. The \$10 retained will be used in defraying the expenses of the judges, who are to be sent on to the controls by railroad.

PROGRAM OF NEWPORT BEACH RACES

Special Correspondence.

NEWPORT, July 13.—Reginald V. Vanderbilt, of the committee in charge of arrangements, has announced the programme for the automobile race meet to be held here under the auspices of the Newport Amusement Association on July 30. Silver prize cups have been offered by Mr. Vanderbilt, his brother Alfred G. Vanderbilt, and Clarence W. Dolan. The association will also offer several handsome bowls and cups. The races will take place on Sachusett Beach, beginning at 3 o'clock in the afternoon. At low tide there is a course sixty feet wide and about two miles long.

The programme as arranged by Mr. Vanderbilt is as follows:

Motorcycles, open to all; silver cup valued at \$75.

Electric machines, open to locals; silver cup valued at \$100.

Gasoline cars, not exceeding 10-horsepower, raced in road condition, open to locals; silver cup valued at \$100.

Gasoline cars, exceeding 10-horsepower and not exceeding 24-horsepower, open to locals; silver cup valued at \$100.

Gasoline cars, not exceeding 24-horsepower, open to all; silver cup valued at \$100.

Gasoline cars, exceeding 24-horsepower; open to all; silver cup valued at \$100.

Each of the races will be over a distance of one and one-half miles. The term "locals" refers to permanent and summer residents of Newport, Narragansett Pier and Jamestown.

An automobile passed through our town Sunday morning at a very early hour, but very few were up in time to see the most "wonderful of all wonders."—*Sigourney (La.) News.*

MOTORCYCLE WEEK ENDED.

First Annual Meeting of Federation Concluded with Races and Election.

Contestants in the first annual meet of the Federation of American Motorcyclists left New York City on Wednesday July 6, at 5.30 A.M., for Cambridge, Md., where the track events and road races were to be held. The road for the first 150 miles of the 271 miles was excellent, contrasting most agreeably with the condition of the route traversed in the endurance contest between New York and Albany. From New York to Wilmington, Del., there was nothing to trouble the travelers but punctures, which were rather numerous. A. J. Banta, of New York, suffering no less than nine times from tire troubles. This run was another reliability contest, and the points made and lost were entered up to the riders as part of their records in the week's motorcycle trials of the Federation.

Sixteen men started from New York, as follows:

Rider.	Home.	H.P.	Machine.
James White, Newark, N. J.	1 1/4	Light	
Walter Zeigler, Hartford	2 1/4	Columbia	
G. M. Hendee, Springfield	1 1/4	Indian	
N. P. Bernard, Hartford	2 1/4	Columbia	
E. N. Coates, New Britain	2 1/4	Columbia	
Fred. C. Hoyt, Springfield	1 1/4	Indian	
A. J. Banta, New York	1 1/4	Indian	
F. A. Baker, Brooklyn	1 1/4	Indian	
G. N. Holden, Springfield	1 1/4	Indian	
Oscar Hedstrom, Springfield	1 1/4	Indian	
W. H. Latham, B'kline, Mass.	2	Yale-Cal.	
H. A. Gliesman, New York	1 1/4	Rambler	
J. M. O'Malley, Hartford	2 1/4	Tribune	
G. H. Curtiss, Hammondsport, N. Y.	2 1/2	Hercules	
B. F. McDaniels, Wilm'ton, Del			
S. J. Chubbuch, Toledo, O.	2	Yale-Cal.	

Of the above, fourteen reached Wilmington, Chubbuch and McDaniels failing to make the control.

HARD DAY'S RUN THROUGH SAND.

The run from Wilmington to Cambridge was the last stage of the endurance con-

ONE PINT FUEL ECONOMY TEST.

Rider.	Machine.	Miles.	Yards.
F. A. Baker, Brooklyn	1 1/4 Indian	31 1/2	520
G. B. Gibson, Westboro, Mass.	1 1/4 Indian	28 1/4	
W. H. Latham, Boston, Mass.	2 Yale	22 1/2	520
S. Chubbuch, Toledo, O.	2 Yale	21	125
P. M. Smoot, Washington, D. C.	1 1/4 Reading Standard	17 1/2	245
J. F. McLaughlin, New York	2 1/4 Columbia	15 1/2	137
H. A. Rhine, Washington, D. C.	1 1/4 Reading Standard	15	358
G. N. Holden, Springfield, Mass.	1 1/4 Indian	11 1/2	782

test, and will never be forgotten by the contestants. Throughout this section the roads were found to be simply paths through deep sand, with here and there a piece of hard but rough road. Falls were frequent and the breakage of handlebars and pedals appalling, although the softness of the sand saved machines and riders many a serious injury. On several occasions machines ran into deep sand-holes, where they stuck and remained upright, throwing their riders to the ground. Some of the contestants actually took to the fields. That Holden, Hedstrom and Hoyt managed to stick to schedule time, calling for a speed of fifteen miles an hour, is remarkable. They arrived at Cambridge on time, Hoyt first and the other two a minute later. Nine others came in later, all within the ten-mile-an-hour limit, in the following order: Banta, Hendee, Baker, Gliesman, O'Malley, Zeigler, Bernard, Coates and White. Curtiss and Latham were delayed by punctures and broken handlebars, and later were caught in a

terrific downpour of rain. After wallowing around in sand and water for two hours, they took the train, utterly exhausted, to Cambridge.

Very remarkable was the ride of M. E. Toepel, president of the New York Motorcycle Club. Toepel has but one arm, yet he arrived safely at Cambridge. He went through with R. H. Nickerson as a companion, sustaining many falls, but no injury, and breaking only one pedal. Another tourist to make the trip was Dr. S. D. Bashore, of Palmyra, Pa. These three riders were all mounted on Indians.

TRACK RACES AT CAMBRIDGE.

The straightaway road speed trials had to be abandoned on account of the very poor condition of the road. This was a great disappointment to many of the riders as well as to the spectators, but excellent sport was enjoyed at the track. The track events resulted as follows:

Two-mile novice:—1, P. M. Smoot, Washington (1 1/4 Reading Standard); 2, J. McNevin, N. Y. M. C. Club (1 1/4 Rambler); 3, H. H. Wright, Cambridge, Md. (1 1/4 Indian). Time, 3:10 4-5.

Five-mile handicap:—1, J. McNevin; 2, P. M. Smoot; 3, H. A. Rhine, Washington (1 1/4 Reading Standard). Time, 7:38 2-5.

Quarter-mile slow race:—Geo. N. Holden, Springfield, Mass. (1 1/4 Indian). Time 2:44. Eight started, but all save Holden were disqualified for pedalling, "racing" of engines or stoppage of motors.

Five-mile team race:—Washington (Smoot and Rhine), 62 points; 2, New York Motorcycle Club (McNevin and Hor-enburger), 57 points. Time, 8:34. McNevin finished first on every lap, but Hor-enburger ran off the track and spoiled an easy victory for New York.

Three-mile handicap for F. A. M. members:—1, J. McNevin; 2, H. E. Walls, Cambridge, Md. (1 1/4 Reading Standard); 3, J. M. O'Malley, Hartford, Conn. (2 1/4 Columbia). Time, 4:38 4-5.

Five-mile pursuit race:—1, Robt. L. French, Baltimore (1 1/4 Indian); 2, H. A. Rhine; 3, J. M. O'Malley. Time, 8:08 3-5.

ECONOMY TEST.

Rider.	Machine.	Miles.	Yards.
F. A. Baker, Brooklyn	1 1/4 Indian	31 1/2	520
G. B. Gibson, Westboro, Mass.	1 1/4 Indian	28 1/4	
W. H. Latham, Boston, Mass.	2 Yale	22 1/2	520
S. Chubbuch, Toledo, O.	2 Yale	21	125
P. M. Smoot, Washington, D. C.	1 1/4 Reading Standard	17 1/2	245
J. F. McLaughlin, New York	2 1/4 Columbia	15 1/2	137
H. A. Rhine, Washington, D. C.	1 1/4 Reading Standard	15	358
G. N. Holden, Springfield, Mass.	1 1/4 Indian	11 1/2	782

One-mile for track record:—Fred C. Hoyt, Springfield, Mass. Time, 1:31 2-5.

J. McNevin (Rambler), H. A. Gliesman, N. Y., (Rambler), and Jas. Mayo, Pottstown, Pa. (2 1/4 h.p. Mayo), were disqualified for pedaling more than one hundred yards.

The figures in the one-pint fuel economy test excel the marks set in the one- quart economy test held in New York during the first part of the contest; but the Cambridge event was held on a level track under the most favorable conditions, there being no grade and no wind.

The diamond medal to be awarded to the contestant making the best showing throughout the week will, it is expected, be taken by either Holden or Hoyt; but the official figures will have to be compiled before it will be known which of the two scored the highest.

FEDERATION TO CONTROL RACING.

At the business meeting of the F. A. M., held at Cambridge, it was determined to

take over the control of motorcycle racing, which is at present in the hands of the National Cycling Association. This change will take effect on January 1 next. Another important move was the sustaining of the action of the executive committee in limiting the weight of motorcycles competing in open races to 110 pounds. Notwithstanding the criticism that has been called forth by this action, it is considered the wisest course to pursue, as it will encourage the construction of all-round serviceable machines and discourage the use of abnormally powerful track racers of no practical use on the road. It was considered that the manner in which the light machines acquitted themselves in the endurance run showed conclusively that they had ample strength for their work—notably, Hendee, who weighs 243 pounds, went through on a 110-pound machine.

Steps were taken toward the adoption of an official club emblem, and also of a suitable uniform of some sort of fabric, leather having been declared unsuitable.

The election of officers resulted as follows: President, R. G. Betts, New York; vice-presidents—Eastern district, Herbert L. Marsh, Hackensack, N. J.; Southern district, H. A. French, Baltimore, Md.; Pacific district, L. H. Bill, San Francisco, Cal.; secretary, Henry J. Wehman, Brooklyn; and treasurer, Dr. G. B. Gibson, Westboro, Mass.

ROAD INSPECTION TOUR.

Legislative Committee Making Trip Under A. R. Shattuck's Guidance.

A tour in the interests of good roads was commenced on Monday, July 11, when Albert R. Shattuck, chairman of the Good Roads Committee of the Automobile Club of America, started out in his car for Trenton, N. J., the first objective point, at the head of a cavalcade of automobiles in which were the following members of the State Legislative Committee appointed to investigate road matters: Senator J. P. Allds, of Norwich; Senator W. W. Armstrong, of Rochester; Senator F. C. Stevenson, of Attica; Senator G. R. Malby, of Ogdensburg, and Senator Edwin Bailey, of Patchogue, accompanied by W. Pierpont White, of the Interstate Road Commission; Henry A. Van Alstine, State Engineer; Charles Hotaling, sergeant-at-arms, and S. A. Church, court stenographer.

George F. Chamberlain and Robert L. Morrell furnished and drove cars for the party. Five automobiles in all were used. Trenton was reached after a leisurely run, several hours having been devoted to the examination of roads and some delay caused by a rainstorm.

The party was banqueted Tuesday evening at Trenton by New Jersey Road Commissioner Henry I. Budd and Frank Epelle, Road Engineer of Mercer County. Road matters were freely discussed after the dinner.

The road mapped out for Tuesday's run included a ride over the roads of northern New Jersey, through Orange County, N. Y., and Newburg. New England will be visited later, and Boston will probably be the most distant point reached on the tour.

From August 16 to 22 General McArthur, of the Pacific Coast Division, U. S. A., will be in camp near Santa Barbara with nearly 1,000 regular infantrymen to go through war maneuvers. The General will use a touring automobile in the maneuvers to test its merits as a desirable adjunct for government use.

MOTOR BOATS

MARBLEHEAD LAUNCH RACES.

Results of the Eastern Yacht Club's Auto Boat Events July 11 and 12.

Special Correspondence.

MARBLEHEAD, MASS., July 13.—A series of races for power boats was held off Marblehead, July 11, 12, and 13, by the Eastern Yacht Club, and some interesting contests occurred between boats ranging from the high-powered automobile boat to the small power dory. Six auto boats were present, as follows: *Mercedes III.*, H. L. Bowden; *Fiat I.*, Hollander & Tangeman; *Naughty Girl*, William Wallace; *Autowin*, E. S. Webster; *Sapho*, J. G. Hudson, and *It*, Howard Haskell. Not all of these appeared in any one race, and there were several breakdowns which prevented close finishes.

The course was triangular, 6¼ miles around, and was covered two or four times in each race. It was kept clear by torpedo

boats, *Fiat I.* and *Sapho* were started together. The former ran away from *Sapho*, doing the four rounds in 1h. 45m. 36s., or seven seconds less than the time spent by *Sapho* in making three rounds. In Class C *Autowin* started alone, and made the course in 2h. 7m. 4s.

The fastest time was that of the *Fiat I.*, whose average speed in the race on the second day was 14.2 miles.

OYSTER BAY LAUNCH RACES.

Vingt-et-Un II. and Queen, Win Best Elapsed and Corrected Time Prizes.

The Seawanhaka-Corinthian Yacht Club scheduled its first powerboat race for July 9, the courses being off Oyster Bay. The club offered prizes in each class and also a prize for the best elapsed time and one for the best corrected time. The day was clear and the water smooth. *Vingt-et-Un II.* made the run from New York to Oyster Bay, about thirty miles, in an hour and a half, at the same time the numerous fast launches about New York were conspicuous only by their absence.

The course was fifteen nautical miles, two

A statement furnished by the Automobile Club of America to Smith & Mabley and signed by J. Herbert Carpenter, chairman of the Motor Boat Committee, and by Secretary Butler, is in part as follows:

"As requested, we record the results of the trial as follows: Course—From the North Beach ferry dock to Throg's Neck Buoy, distance, 5¼ miles; four times over the course, a continuous run of 21 miles. Net time.

North Beach to Throg's Neck, 5¼ miles.	11:53
Throg's Neck to North Beach, 5¼ miles.	12:03
North Beach to Throg's Neck, 5¼ miles.	12:11
Throg's Neck to North Beach, 5¼ miles.	11:45

Total time for 21 statute miles.... 47:54 or an average of 26.5 miles per hour. The time of the turns at each end of the course were deducted."

NEW YORK Y. C. RACES.

The New York Yacht Club has this year introduced a decided innovation in the form of a series of races for yachts so

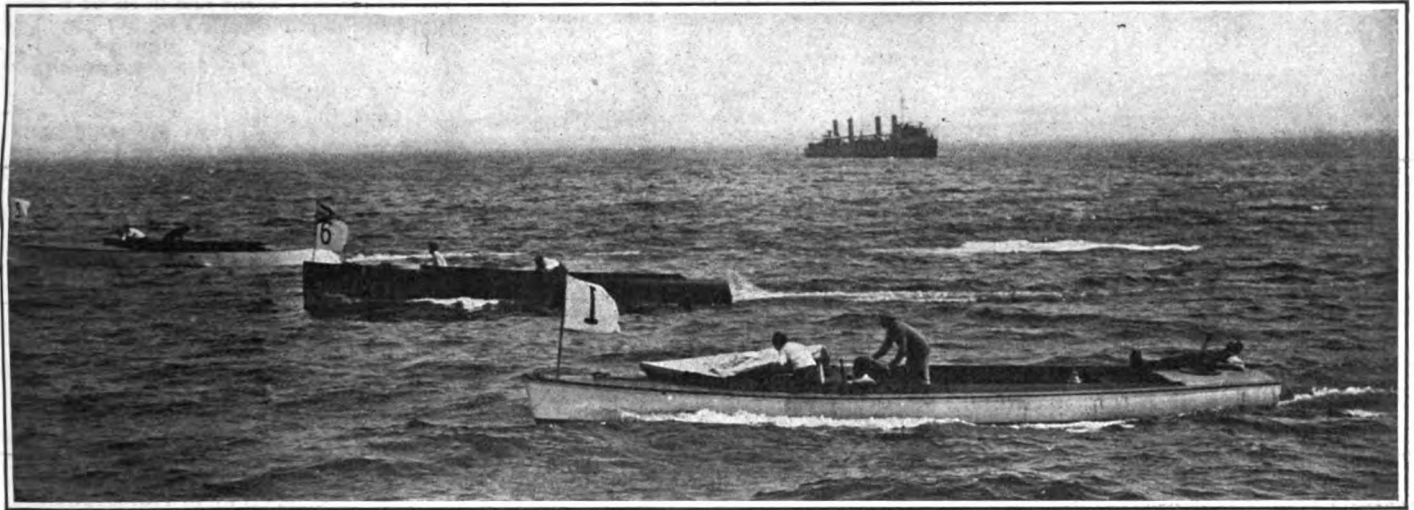

AUTO BOATS STARTING IN THE RACES OF THE EASTERN Y. C. OFF MARBLEHEAD.—U S. TORPEDO BOAT GUARDING COURSE.

boats detailed for the purpose. The auto-boat races were without time allowances, the elapsed time alone being taken into consideration.

FIRST DAY'S AUTO BOAT RESULTS.

On the first day *Mercedes III.* and *Fiat I.* both broke down in the first race, but the latter was repaired in time to participate on the second day, and *Mercedes III.* competed again on the third day.

The total times in the auto-boat classes for the first day were as follows:

Class C, 25 miles—*Autowin*, 2h. 22m. 56s. *Naughty Girl*, 2h. 28m. 17s.

Class B, 25 miles—*Mercedes III.* and *Fiat I.*, both disabled.

Special Race for the Gay Cup, 25 miles—*Autowin* 2h. 21m. 52s. *It*, 2h. 22m. 30s. *Naughty Girl*, 2h. 26m. 4s. *Sapho*, withdrew.

SECOND DAY'S RESULTS.

On the second day the fog which had proved something of a hindrance the day before lifted, and practically the whole course was visible from the starting point. There was a large attendance, more than two hundred yachts and launches being present among the spectators. The weather conditions were perfect.

In the first race for Class B automobile

rounds of a triangle. *Vingt-et-Un*, steered by Mr. Hamilton, was alone in Class R, while the cabin launch *Queen Bess* was alone in her class. Class H. included the two G. E. & P. launches *Queen* and *Tide*.

The times were as follows:

CLASS R.		(Start 12.35 P. M.)		Miles
Boat and Owner.	Finish.	Elapsed Time.	Cor'ted Time.	per Hour
<i>Vingt-et-Un II.</i>	Smith & Mabley.	1 23:05	0:48:05	21.90
CLASS H.				
<i>Queen</i> , J. J. Amory.		1:44:16	0:44:36	14.96
<i>Tide</i> , Colgate Hoyt.		2:08:00	1:33:00	11.16
CLASS C.				
<i>Queen Bess</i> , R. H. Stearns		2:23:40	1:48:40	9.54

The *Queen* received 24 minutes 40 seconds from *Vingt-et-Un II.*, which made her the winner on corrected time by 3 minutes 29 seconds.

"CHALLENGER'S" OFFICIAL TIMES.

The times made by Smith & Mabley's auto-boat *Challenger*, in her trials in Long Island Sound last week before she was shipped Saturday on the *Minnehaha* to compete in the Harmsworth cup race in The Solent on July 30, have been made public.

small that they are not entitled to enrollment in the club fleet. The first of three days' racing, on July 7, was for power boats, the course being off Glen Cove, in Hempstead Bay. Classes were provided for different sizes and types, but at the appointed time there were only two craft present, the new *Suis Moi* and the open launch *Javelin*. A heavy fog in the morning delayed the committee boat on her way up from the city; when she finally arrived at Glen Cove only the *Suis Moi* was to be found, so the races were abandoned.

AS THE automobile omnibus of the Hotel St. Francis, San Francisco, was going down Kearney street on the Fourth of July, carrying no passengers, a boy threw a lighted firecracker into it. The vehicle caught fire, but the chauffeur's attention was so much occupied in steering through the crowds on the street that he failed to observe the fire. A policeman and several people called to him without producing any effect. Smoke trailed out behind the car and soon flames appeared. A chemical engine went in pursuit of the burning automobile and the loud shouts of the crowd drew the chauffeur's attention. He stopped the motor car and the chemical engine stopped the fire. The automobile was damaged considerably.

DAYTON CLUB'S GOOD MEET.

Pleasant Gathering and Outdoor Dinner
Precede Interesting Track Events.

One of the most successful and generally pleasing automobile tournaments ever held in the Middle West was that of the Dayton, Ohio, Automobile Club on July 4. This was held at the Dayton Fair Grounds and was largely attended. There was a general gathering of motorists in the forenoon to enjoy themselves as they pleased, followed by a dinner in the shade of the forest oaks at noon. In the afternoon a most successful programme of track races was run off smoothly and without delays, special events being put on in place of several races that had to be omitted for lack of sufficient entries. Special attractions were Barney Oldfield in the Peerless racer, Carl Fisher, of Indianapolis, who drove the Premier *Comet* and his Mohawk racer, Earl Kiser in the Olds *Pirate* and J. J. Winchester, of Syracuse, in a Franklin. The best time made was a mile in 1:19 2-5, by Fisher in the *Comet*, who drove a two-mile exhibition in 2:40. A silver loving cup offered as a special prize for the car making the best time on Swinehart tires was won by Adolph Euchenhofer in a Stearns.

Following are the results:

Three miles, stock cars, stripped—J. D. Platt, Jr. (Franklin), first; C. C. Rooney (Marr), second; C. B. Wolf (Haynes-Apperson), third. Time, 5:03.

Special match race—J. J. Winchester (Franklin), first; Earl Kiser (Olds *Pirate*), second. No time given.

Five miles, open—J. J. Winchester (Franklin), first; Earl Kiser (Pope-Toledo), second; Barney Oldfield (Peerless), third; J. D. Pratt, Jr. (Franklin), fourth. Time, 7:27 1-5.

Special match race—Carl Fisher (*Comet*), first; J. J. Winchester (Franklin), second. No time given. Winchester's machine broke down.

Three miles, stock cars, stripped—A. M. Dodds (Franklin), first; H. M. Carr (Franklin), second; Harry Cappel (Cadillac), third. Time, 5:16 2-5.

Heavy touring cars, loaded, three miles—Carl Fisher (Pope-Toledo), first; Pierce Schenck (Winton), second; Barney Oldfield (Peerless), third; C. C. Rooney (White), fourth. Time, 5:43 2-5.

Stop and start, light touring, loaded, three miles—H. M. Carr (Franklin), first; Dodds (Franklin), second. Time, 7:15.

Special, two miles against time—Carl Fisher (*Comet*). Time, 2:40.

Special, touring cars, three miles—Emil Koeb, first; C. B. Wolf, second; Adolph Euchenhofer, third. No time given.

Stop and start, three miles, heavy touring, loaded—Carl Fisher (Pope-Toledo), first; C. B. Wolf (Haynes-Apperson), second; Adolph Euchenhofer (Stearns), third. Time, 8:12 3-5.

Light touring cars, three miles—H. M. Carr (Franklin), first; A. M. Dodds (Franklin), second; J. J. Gardner, third. Time, 5:46.

Pursuit race, 5½ miles—Carl Fisher, first; J. D. Platt, second. Time, 7:32.

ATTRACTIONS AT EMPIRE CITY TRACK.

The Empire City track races for Saturday, July 16, should furnish excellent sport if the weather is favorable. Thirty cars have been entered, including the 60-horsepower Mercedes of Alfred Gwynne Vanderbilt, which will be driven by his chauffeur, Paul Sartori, and the Central *Greyhound*, an 8-cylinder racer which has never yet been given a thorough trial. The latter

machine will make an attack on the track record of 55 seconds, established by Barney Oldfield with the Winton *Bullet*. H. S. Harkness will send his 60-horsepower Mercedes against the track record. Nathaniel Huggins has entered with his 40-horsepower Decauville, and Joseph Cowan with his Panther. The 90-horsepower Mercedes racer purchased from W. K. Vanderbilt, Jr., by J. M. Shanley, will probably be seen on the track, though it will not be sent after records. One of the chief events will be the Empire City Handicap, in which machines of all powers will be entered, from a light runabout to the 60-horsepower Fiat racer, which will be driven by Claude Fogelin.

CAUGHT IN KANSAS RAINS.

Rail Fences the Only Salvation of "Pathfinders" Seeking St. Louis.

Special Correspondence.

KANSAS CITY, July 9.—The "pathfinders" who left here Sunday morning to investigate the route for the St. Louis tour have met with many difficulties. E. P. Moriarty, who accompanied the party as far as Sedalia, Mo., the first night stop, left his car at Warrensburg and returned by train Wednesday morning, as mud made the roads almost impassable. He failed to go farther than Centre View, twenty-eight miles this side of Sedalia, on the first day, owing largely to tire trouble. He reports the roads very rough, but passable before the rains.

H. N. Strait, Henry Merrill, S. H. Merriam, Ralph Baker, W. G. Whitcomb and H. G. Blakley, in two White cars, pushed on to Sedalia after dark. Tuesday night they arrived in Boonville. Rain fell so heavily after Sedalia was passed that only twenty-eight miles were made in twelve hours. The tourists had to tear down rail fences and build roads in some places. The old Southern rail fence was their only salvation. A heavy rainstorm nearly swamped the party near Lees Summit, twenty miles from Kansas City. Both Mr. Strait and Mr. Merrill had tire trouble, and, after having used up the spare tires they carried, they wired to St. Louis for tires to be sent them along the road. The first of these were to reach them at Boonville.

Just before reaching Sedalia, the Merrill machine broke a front axle and had to be towed into town. Merrill is reported to have secured a new car, so that he could proceed. From reports received here, the trip is the hardest ever undertaken by Kansas City motorists.

ST. LOUIS TOUR ENTRIES.

The St. Louis tour entry list is beginning to assume goodly proportions as the time for starting approaches. About fifty entries had been received by the middle of the present week, of which the following is a partial list:

Boston to St. Louis—H. W. Whipple, Orange, N. J.; Elliott C. Lee, Boston; Charles J. Glidden, Boston; H. Frederick Lesh, Boston; Thomas B. Jeffrey, Kenosha, Wis.; Royal R. Sheldon, Boston; Dr. W. E. Rolfe, Boston; George H. Lowe, Boston; Cecil P. Wilson, Boston; A. P. Pendleton, St. Louis (may go from New York instead of Boston).

New York to St. Louis—C. H. Gillette, New York; W. T. White, Cleveland, O.; Augustus Post, New York; R. P. Scott, Baltimore (may go from Baltimore); James L. Breese, New York; A. J. Willis, Akron, O.; Haynes-Apperson Co., Kokomo, Ind.; Paul H. Deming, New York; Ray D. Lillibridge, New York; W. E. Metzger, Detroit, Mich.

Chicago to St. Louis—John Farson, Chicago; Frank X. Mudd, Chicago.

Providence to Albany—Dr. Julian A. Chase, Pawtucket, R. I.

Albany to Buffalo—Dr. W. E. Milbank, Albany.

Pittsburg to St. Louis—W. C. Temple, Pittsburg; R. H. Wallace, Freeport, Pa.

Columbus, O., to St. Louis—Wm. Monynny, Jr., Columbus.

Syracuse to St. Louis—W. H. Smith, Syracuse.

Cleveland to St. Louis—Geo. S. Waite, Cleveland.

Baltimore to St. Louis—Hart D. Newman, New Orleans; Sam Stone, Jr., New Orleans.

Bristol, Conn., to St. Louis—F. N. Mansro, Forestville, Conn.

Springfield, Mass., to St. Louis—Charles R. Greuter, Holyoke.

New York to Albany—A. R. Pardington, Brooklyn.

RESULTS OF PITTSBURG HILL-CLIMB.

The results of a hill-climbing contest held by the Pittsburg Automobile Club on Heberton Hill July 2, are given below. Thirty-five cars competed in eight classes, the events being run off in heats and finals. The course was about one-third of a mile long and the grade varied from 7 to 22 per cent, the steepest portion being paved with granite blocks. The first seven classes were for amateurs and in them all cars carried their full complement of passengers. Class 8 was a free-for-all for manufacturers and dealers. In the final of this event a record of 38 seconds for the course was made by A. C. Webb in a four-cylinder Pope-Toledo. In the heats Webb defeated W. F. Winchester (Franklin; time, 45 2-5 seconds), and O. E. Vestal (Richard-Brasier; time, 50 seconds), in 39 4-5 seconds.

Finals in three of the amateur events were won by H. C. Fownes.

Following are the times of the first and second men in the final of each class:

Contestant.	Car.	Time.
John A. Pietsch...	Stevens-Duryea.	1:31
O. E. Vestal....	Crest.....	1:44 4-5
Second Class—8 to 10-Horsepower.		
W. W. Murray....	Franklin.....	1:01 4-5
S. J. Adams....	White.....	1:27 3-5
Third Class—11 to 14-Horsepower.		
W. S. Mellon....	Pope-Toledo....	1:25 4-5
Fourth Class—15 to 20-Horsepower.		
W. L. Dixon....	Peerless.....	1:45
D. M. Kirk....	Pierce.....	2:08
Fifth Class—21 to 24-Horsepower.		
H. C. Fownes....	Pope-Toledo....	:52 2-5
F. F. F. Lovejoy...	Pierce.....	1:02 1-5
Sixth Class—Over 24-Horsepower.		
H. C. Fownes....	Pope-Toledo....	:52
T. B. Riter....	Pope-Toledo....	:54 1-5
Seventh Class—Free-for-all for Members of Pittsburg A. C.		
H. C. Fownes....	Pope-Toledo....	:53 2-5
T. B. Riter....	Pope-Toledo....	1:00
Eighth Class—Free-for-all for Agents and Manufacturers.		
A. C. Webb....	Pope-Toledo....	:38

A COIL of wire, left hanging from a pole at Forty-seventh street and Troost avenue, caught the top of D. E. Gudgell's automobile while he was driving past that point last night. The top and the seat were almost jerked off, leaving Mr. Gudgell and his wife sitting on the flywheel of the engine. Neither was injured. The wire had been used in construction work by the Metropolitan Street Railway Company. It had not been securely fastened to the top of the pole and hung only about six feet from the ground.—*Kansas City World*.



HUSTLING MOTORCYCLE CLUB. How the Philadelphia Organization Has Risen to Front Ranks in a Year.

Special Correspondence.

PHILADELPHIA, July 9.—Organized less than a year ago, the Philadelphia Motorcycle Club gives promise ere long of being one of the largest organizations of the kind in the country, not excepting the Metropolitan, and of ranking high in the councils of the Federation of American Motorcyclists, with which body many of the individual members are allied. A movement is on foot to have the organization join the F. A. M. as a club. The national body has already recognized the hustling abilities of this thriving young organization by appointing its secretary-treasurer, Charles Krauss, a member of the National Committee on Transportation and Facilities.

The membership of the Philadelphia Motorcycle Club has just about doubled in the eleven months of its existence, fifty-two names now being on the roll. The present officers are T. J. Kean, president; John O. Mohr, vice-president; Charles Krauss, sec-

is now fitting up a clubhouse on North Broad street near Venango, where all future meetings will be held and where facilities for the storage and repair of bicycles and motors have been installed.

A unique feature of the P. M. C. is its recruiting committee. This body keeps a record of all purchasers of motorcycles in the city, and within a reasonable time each new rider is invited and urged to join the club, an invitation being extended to him to take part in the next weekly run, when his experience is usually so delightful that he attaches his signature to an application blank within a short time.

The accompanying photograph shows a group of some of the members of the club just before starting on the Perkiomenville run. The attendance on that occasion was thirty-two, quite a number of the participants having already started before the photograph was taken.

The road officials of the club believe that motorcycling cannot become popular until each member thoroughly understands his motor and becomes sufficiently expert to repair and adjust the machine on the road. When necessary, the experts—and there are many in the club—coach the tyros, and the

greatest gathering of automobilists ever assembled in Toronto.

The Cleveland contingent arrived about 7 P. M. Monday, having left Cleveland at 8 A. M. Saturday. They made the distance from Cleveland to Erie, Pa., 102 miles, in six hours. One machine occupied by Archibald McLaren and Dr. McTaggart came to grief between Buffalo and Hamilton, and could not proceed.

The party was joined at Buffalo by thirty-four members of the Buffalo Automobile Club and their friends.

After enjoying the hospitalities of the Toronto Automobile Club, the American visitors left at 8 o'clock the following morning on their return journey.

NEWS NOTES OF THE CLUBS.

PITTSBURG.—The Automobile Club is taking steps to stop the practice of throwing stones and other missiles at carriages and automobiles in the city, and has offered a reward of \$50 for the apprehension of any one guilty of such an offense.

RIDGEVILLE, Ind.—The Randolph-Jay Automobile Club has been formed, with the following officers: J. O. Carpenter, president; J. A. Lay, secretary; H. H. Bragg, treasurer; F. R. Rohr, of Ridgeway; Frank White, of Portland, and Ed Koontz, of Union City, vice presidents.

DALLAS, Tex.—The Dallas Automobile Club has been formed, with the following



MEMBERS OF THE PHILADELPHIA MOTORCYCLE CLUB READY FOR START OF CLUB RUN TO PERKIOMENVILLE.

retary-treasurer; Harry Schleter, captain; Frank Shaw, lieutenant, and Albert Warrington, color-bearer.

One of the principal objects of the organization is the popularization of the sport of motorcycling, through the medium of club runs, which are scheduled for every Sunday and holiday during the riding season. A number of these outings are called for points so far distant from the city and over such roundabout routes, that 100-mile runs are becoming rather numerous. The present season was opened on May 8, with a fifty-mile run about Philadelphia. Then followed runs to Essington, Egg Harbor, Valley Forge, Atlantic City, Perkiomenville, Quakertown, Wilmington, Mt. Holly and Spring House.

At each monthly meeting the runs of the following month are announced. One of the features of the present month will be a "blind run," for which the participants have been warned to make complete preparations in the way of fuel supplies. No one will be aware of the objective point but the captain, and as he is a mileage fiend it is quite likely that he will lead his men over hill and dale for 150 miles or more—the start will be sufficiently early in the morning to allow of that before dark. More than half the members have already signified their intention of participating.

An evidence of the progressiveness of the club is the fact that it recently leased and

good results of this are noticeable on each succeeding run. An object lesson—a relic illustrating an ingenious temporary repair—occupies a place of honor in the clubhouse. Far from home one day Secretary-Treasurer Krauss was so unfortunate as to break the exhaust valve of his motor. It looked like a fifteen-mile drag until Krauss' eye happened to notice that the top pieces of an ornamental iron fence surrounding a suburban residence he was passing were just about the shape and size of the valve. Dismounting, he hunted up his file and in a few minutes had secured one of the ornaments. A quarter hour's work with the file sufficed to fit the improvised valve to his motor, and he was enabled to reach home without further mishap. His club-mates thought so much of the feat that they voted money to have the ornament handsomely mounted and installed in a prominent place in the meeting room of the club house.

TORONTO CLUB HOUSE WARMING.

Special Correspondence.

TORONTO, Can., July 9.—The Toronto Automobile Club opened its new club rooms in the King Edward Hotel on the evening of July 4. The affair was made the occasion of a banquet and smoker, at which about fifty invited guests from Cleveland, Buffalo and Hamilton were present. It was the

officers: John G. Hunter, president; E. J. Kiest, vice president; G. C. Scruggs, secretary, and J. D. Scofield, treasurer. Henry Garrett was elected manager and director, and Messrs. Leachman, Morgan and Dreeben were appointed a committee to draft by-laws. Nineteen charter members were enrolled.

HARTFORD.—The Hartford Automobile Club and the Automobile Club of Hartford have consolidated under the name of the latter organization, with the following officers: J. Howard Morse, president; Fred C. Billings, vice president; W. T. Plimpton, secretary, and A. W. Gilbert, treasurer. L. C. Grover is chairman of the membership committee; C. E. Walker, chairman runs and tours committee; L. D. Fisk, chairman racing committee; C. G. Huntington, chairman committee on rights and privileges, and Joseph Birmingham, chairman committee on good roads.

PHILADELPHIA.—October 1 has been set for the second annual run for the Cross-Country Challenge Cup of the Automobile Club of Philadelphia. Last year's run was to Phoenixville and return. This year the route will be longer and more difficult. The course will be in the shape of a rough square, the first leg being to Ambler, fifteen miles; the second, to Phoenixville, via Norristown, sixteen miles; the third, to West Chester, fifteen miles; and home.



A 1905 White car will this week be placed in the White exhibit in the Transportation Building at the World's Fair.

Thomas B. Jeffery & Co., makers of the Rambler automobiles, have recently opened a Chicago store at 302-304 Wabash avenue.

We are informed that the Olds Motor Works can now make immediate deliveries of Oldsmobile curved dash runabouts and light touring cars, having overtaken the orders for these vehicles.

E. J. Willis, 14 Park Place, New York, dealer in automobiles and supplies and accessories, has established a branch at 220 W. Thirty-sixth street.

John Wanamaker has opened a sub-agency for the Ford and Premier automobiles at 153 W. Thirty-eighth street, New York. This is subsidiary to the main agency at 140 E. Fifty-seventh street, and not a removal.

Justice Andrews has named John J. Brady as permanent receiver for the bankrupt Central City Automobile Co., of Syracuse, N. Y., and James S. Thorn, referee, before whom hearings will be had in the final winding up of the company's affairs.

The Moxie Company, of New York City, has recently received an Oldsmobile delivery wagon, making twelve of this make now in use in the service of this company. The wagon, which was delivered through the Boston agency, was sent over road via Providence.

It is reported that Colonel Albert A. Pope will next year begin the manufacture of a medium priced runabout in the Western Wheel Works factory in Chicago, which is to be refitted for this purpose. The plan, as outlined, is the manufacture of a gasoline machine that will retail at well below \$1,000. Announcement of this move is expected shortly from the Pope headquarters.

The Standard Roller Bearing Company, Philadelphia, Pa., has increased its capital stock from \$1,000,000 to \$2,000,000. A 250-foot addition to the machine shop and factory will be built and also a two-story office building, these to be devoted exclusively to the manufacture of roller bearings. The ball plant will also be increased by the erection of a large three-story addition.

A photographic contest has been started by Thomas B. Jeffery & Co., Kenosha, Wis. The contest rules stipulate that each photograph submitted must show a 1904 Rambler car; pictures to be not less than 4 by 5 inches; two prints to be submitted, one carbon and the other gelatine; pictures to remain the property of the company. Competitors may enter as many pictures as they like. The prizes consist of automobile lamps and horns, the first prize being a Solar searchlight valued at \$50.

The New York agency for the Crest automobiles has been established at 144 W. Thirty-ninth street, under the control of the Star Rubber Co., where a complete line of Crest cars will be handled, from the 5 1-2-horsepower air-cooled runabout to the 20-horsepower water-cooled touring car, the list including a delivery wagon. E. D. Cadwell is president of the company and F. P. Johnson, secretary-treasurer. Frank G. Dwight, Jr., who was formerly identified with the Cadillac and Winton concerns at different periods, is also connected with the new agency.

All the St. Louis repositories are providing for the storage of large numbers of cars, and arranging conveniences for motorists during their stay in the World's Fair city.

John D. Rockefeller has placed his order with the Knox Automobile Company, Springfield, Mass., for a 16-horsepower double-cylinder surrey. The Knox company is especially pleased with this order because it is the first large gasoline car purchased by Mr. Rockefeller.

The Michigan Automobile Co., Ltd., makers of the Michigan light touring car, of Kalamazoo, Mich., shipped its first carload of machines to the East on July 9. It went to the Newark Automobile Co., Newark, N. J., distributors of this car for northern New Jersey.

Sanction has been granted by the racing board of the A. A. A. for an automobile race meet at Poughkeepsie on September 16, which will be held in connection with the sixty-third annual fair of the Dutchess County Agricultural Society. The track is a one-mile circuit, and eighty feet wide.

Cardinal Satolli, who has been visiting the World's Fair, has used an automobile extensively in going to and from the Jerusalem exhibit. While he was the guest of R. C. Kerens he was driven through the residence portion of St. Louis in the latter's handsome motor car. He likes the new form of locomotion, and commends its time-saving qualities.

The five-mile championship cup, given two years ago by the Diamond Rubber Co., of Akron, will be contested for again in the races to be held in Cleveland, O., in August. Alexander Winton won the cup in 1902, and F. A. La Roche won it in 1903 at the Empire City track. By the conditions under which the cup was given, it must be won three times by a manufacturer before it becomes his permanent property.

Mr. and Mrs. G. H. Thomas and Mr. and Mrs. A. S. Hitchcock, of Providence, R. I., completed an ideal automobile trip of about seven hundred miles in their Autocar the first week in July. Their trip was to New York City by way of Worcester, Springfield, Hartford, and New Haven, and after a rest in New York on to Long Branch and Asbury Park. The distance between Providence and New York of 152 miles was traveled in one day. A remarkably successful trip was enjoyed, as there were no troubles whatever with either the engine or tires—the hood not being lifted from the engine the entire distance.

The educational committee of the Detroit Y. M. C. A., at its last meeting, appointed a number of leading local automobile constructors as members of an advisory committee for its motor school, feeling that properly to care for the needs of the school it is necessary to have a committee of practical automobile and gas engine manufacturers with whom the instructors may counsel on questions that may arise. Professional talent has been engaged for the teaching faculty. Henry B. Joy, of the Packard Company, who has been appointed a member of the advisory committee, asserts that the work of the Detroit school has been productive of much good in that city and recommends its methods in connection with the Y. M. C. A.'s in other cities.

Twenty-five automobiles are now owned and operated in Butte, Mont.

Nearly every automobile in South Bend, La Porte, Elkhart and neighboring Indiana towns took part in a very successful Fourth of July parade held in the evening. The procession was headed by the city officials of South Bend and nearly every car carried some emblem of patriotism, while some were elaborately decorated with flowers. Three prizes were awarded for the most handsomely decorated gasoline, steam and electric vehicle.

Dr. Stewart and G. H. Hill, of Pittsburg, have made the run from the Smoky City to St. Louis over the proposed A. A. A. tour route. They used a Pope-Toledo car, and covered the distance of 1,000 miles in eight days, carrying 250 pounds of baggage. The motorists report the roads as better than they expected. They will return by automobile this week, making business stops at Toledo and Detroit.

The California Promotion Committee of San Francisco is proposing to eastern capitalists the feasibility of establishing an automobile factory in San Francisco to supply the Pacific Coast market, and a number of them are inclined to think the project would prove profitable. A large automobile plant is almost certain to be established soon on the coast, where thousands of motor cars are already in use.

The New York garage of the White Sewing Machine Co., 42-44 West Sixty-second street, have been pursuing a novel procedure regarding orders for the 1905 White cars, since closing out all of the 1904 model. Before the announcement of the new model it was impossible to explain to prospective purchasers any details of the car. The regular deposit required is \$500, but until these in charge of the New York garage knew what they had to sell, they accepted deposits of \$250, giving the depositor the option of withdrawing the deposit, or putting up an additional \$250, when the details of the car were made known. More than thirty orders were placed on this condition.

James B. Dill, of East Orange, N. J., started on July 10 on an automobile tour of ambitious proportions. His former camping ground at the Rangeley Lakes, Maine, is the objective point, but instead of going there direct he will take a new and unmapped route through a portion of the Canadian province of Quebec, and if successful in finding a practicable route, will make a chart for the guidance of future tourists in that region. The party consists of Mr. Dill, his daughter, Miss Emma Dill, and John M. Schmidt, who accompanied him last summer on his White Mountain tour. An additional car was taken along loaded with baggage, tents, supplies and provisions, and a servant. The tourists were accompanied by Winthrop E. Scarritt, president of the Automobile Club of America, who, however, will not go all the way through. While traveling through the woods the rifles of the men will be expected to furnish fresh meat. As a complete camping outfit is carried, the party is almost entirely independent of settlements except for gasoline, which Mr. Dill has taken the precaution to ship ahead to points where he can call for it.

THE AUTOMOBILE

WEEKLY

NEW YORK—SATURDAY, JULY 23, 1904—CHICAGO

10 CENTS

RECORDS FALL AT EMPIRE CITY TRACK.

H EAVY showers interfered with the sport at Saturday's race meet at the Empire City track. Rain began falling lightly just as the second heat of the fifteen-mile free-for-all was started, as the third event on the program, and steadily increased until it was pouring down in torrents as the heat finished. The management announced an intermission of forty-five minutes, until 4 o'clock, to allow the track to dry off; but instead of drying off, it was converted into a sea of mud by heavy showers that fell intermittently for an hour, when the meet was declared post-

poned, to be continued on Monday if the weather was suitable. And the 5,000 spectators who had almost completely filled the grandstand and patiently awaited the pleasure of the weather, departed by automobile and trolley car.

The heat of the free-for-all, 1,432 to 2,204 pounds, was the only interesting and spectacular event of the afternoon. The starters were Paul Sartori, in A. G. Vanderbilt's 60-horsepower Mercedes; Carl Mensel in George Arents, Jr.'s 60-horsepower Mercedes, and Guy Vaughn, in the 40-horsepower Decauville racer, owned by

Tod Sloan. The event proved a runaway for Sartori, who pulled into the lead entering the back stretch and continued to widen the distance between himself and Mensel, who in his turn opened a steadily widening gap in front of Vaughn. At the start the course was heavy with dust, which the two big Mercedes cars tore up in dun-colored clouds as they skidded on the turns. Miles were spun off in less than a minute from the third mile to the finish, Sartori winning by almost a mile in 14:40, having gained one and a half laps on Vaughn, whose tire went flat and came near send-

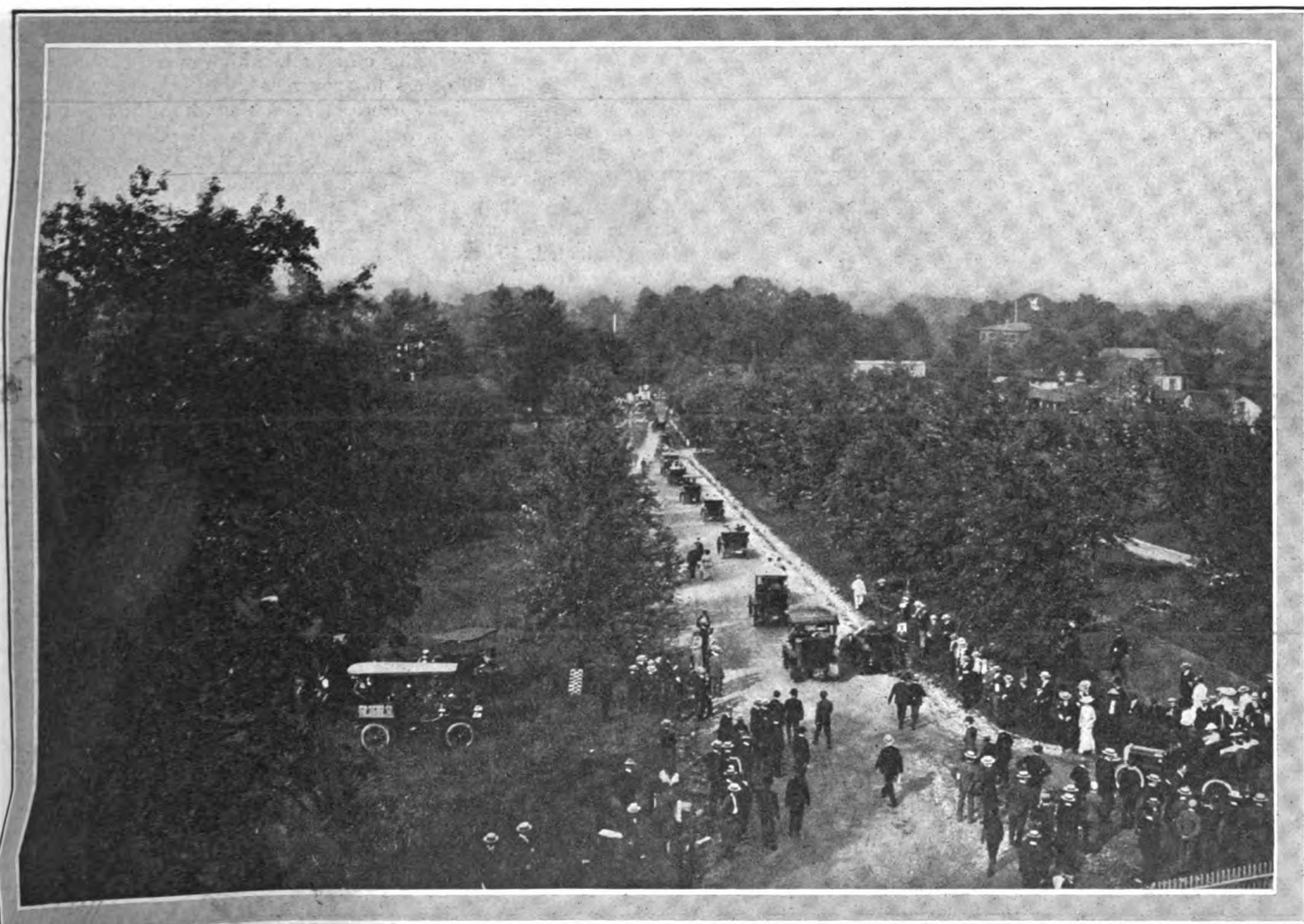

SPECTATORS' CARS DRIVING ALONG THE AVENUE FROM THE GRAND STAND TO THE GATE AT THE EMPIRE CITY TRACK, YONKERS, N. Y.



START OF SECOND HEAT OF FIFTEEN MILE FREE FOR ALL RACE AT THE EMPIRE CITY TRACK ON SATURDAY.

ing him through the outer fence on the turn. Mensel's time for the fifteen miles was 15:35 3-5, and Vaughn's, 16:57 3-5. The leader's times by miles were: One mile, 1:02 4-5; two, 2:01 2-5; three, 2:59 4-5; four, 3:57 3-4; five, 4:56 4-5; six, 5:54 4-5; seven, 6:52 4-5; eight, 7:50 1-5; nine, 8:50; ten, 9:48 3-5; eleven, 10:46 1-5; twelve, 11:45; thirteen, 12:42 3-5; fourteen, 13:41 3-5; fifteen, 14:40. The track record for fifteen miles is 14:21, made by Oldfield at Denver.

NEW LIGHT CLASS RECORDS.

The first event was a ten-mile run for cars of any motive power weighing from 881 to 1,432 pounds. The starters were Maurice Bernin, in W. Gould Brokaw's 30-horsepower Renault; Guy Vaughn, in the 40-horsepower Decauville; W. F. Winchester, in the Franklin 10-horsepower racer; Walter Christie, in his 30-horsepower racer; and M. J. Seymour, in Oscar Lewishon's 18-horsepower Mercedes. This race was a runaway for Bernin, who won by seven-eighths of a mile from Vaughn in 10:13 2-5 and lapped all the others. Winchester was third in 11:36 1-5. Vaughn's time was 11:01 1-5. Christie punctured a tire and Seymour met with a mishap so that both withdrew. Class records were established from one to ten miles as follows: One mile, 1:04 2-5; two, 2:04 1-5; three, 3:06 3-5; four, 4:07; five, 5:08 1-5; six, 6:08 4-5; seven, 7:09 2-5; eight, 8:09 2-5; nine, 9:11 3-5; ten, 10:13 2-5.

A special five-mile race for stock Franklin cars was run off as the second event. There were five starters: Alfred F. Comacho, Harry Esselstyn, Charles Singer, Thomas Lannon and D. M. Uptike. It is worthy of note that this is probably the only race run

at any large eastern meet this season in which all the drivers entered actually started. There was better competition in this event than in the others, as the cars kept closer together, Esselstyn winning by only about twenty yards from Comacho in 8:49 3-5. Comacho's time was 8:51 1-5. Singer was third in 9:19.

As an indication of the slippery condition of the course when the fast free-for-all heat finished, Arents' Mercedes, with Mensel driving, skidded through more than 90 degrees on the middle of the first turn, but was brought to a stop without damage. Everybody but the contestants had sought shelter before this time, and as soon as the showers ceased the spectators started for home.

A most commendable departure from the arrangements at all previous eastern meets, both on Saturday and the following Monday, was the keeping of the lawn between the grandstand and the track entirely free of spectators' cars and of spectators themselves. Instead the cars were parked under the stand and beneath the trees back of the stand. By this regulation the possibility of serious injury to onlookers and to valuable machines in case a competing car should leave the track and crash through the fence was eliminated. There was an unusually large congregation of upward of 325 cars at the meet, by far the greater number being touring cars with canopy tops or enclosed bodies; while many side-entrance machines were noted among them.

THE CONCLUSION MONDAY AFTERNOON.

Notwithstanding renewed showers Sunday night and a cloudy Monday morning, the program was concluded Monday after-

noon, when the clouds rolled away and the sun shone hotly. Uncertainty as to whether the events would be run off, and also the business engagements of most of Saturday's attendants, resulted in a slim crowd. Those who staid away did not miss a great deal, however, as there were many withdrawals by entrants in the several events, and the racing, which began at 3 p.m., was finished at 5 o'clock.

SARTORI WINS AND BREAKS RECORDS.

The best event of the whole meet was the final of the fifteen-mile free-for-all for cars weighing from 1,432 to 2,240 pounds, which was run as the first event. The starters were Sartori, in Vanderbilt's Mercedes; Mensel, in Arents' Mercedes; Vaughn, in Tod Sloan's Decauville; Bernin, in Brokaw's Renault, and J. W. Hilliard, in Nathaniel Huggings' 40-horsepower Decauville. The last two contestants were admitted to the final without running off a heat, as they were the only starters to appear when their heat was called. Sartori quickly went into first place and continued to gain, while the others strung out, with Bernin (Renault) second, Mensel (Mercedes) third and Vaughn (Decauville) fourth. Hilliard (Decauville) withdrew in the second mile. After the first mile, the laps were turned off considerably under the minute, with the Renault holding a slight lead over the Arents car until the tenth mile, when Mensel passed Bernin, taking second place, which he held to the finish. The Renault injured a tire and slowed perceptibly, being passed by Vaughn (Decauville) in the fourteenth mile and withdrawing. Sartori finished nearly a lap in the lead, winning in 14:42 2-5, and was going so well that he signalled the officials

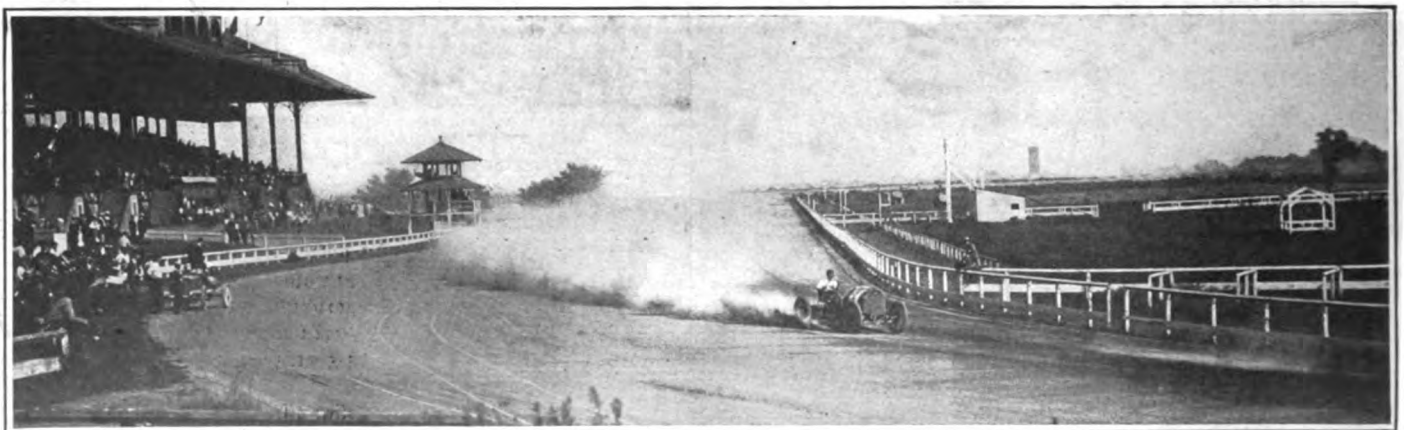

SARTORI IN ALFRED VANDERBILT'S 60-H.P. MERCEDES ROUNDING TURN OPPOSITE CLUB HOUSE WHEN GOING UNDER THE MINUTE.

that he would go on for track records from sixteen to twenty miles. Mensel finished second, nearly a lap to the bad, and Vaughn third, almost as far behind Mensel and lapped once by Sartori. New records were made by Sartori from sixteen miles to twenty, breaking Henri Fournier's figures. The records up to fifteen miles are held by Oldfield. The new times are: Sixteen miles, 15:41 2-5; seventeen, 16:39 4-5; eighteen, 17:38 4-5; nineteen, 18:37 1-5; twenty, 19:37 1-5. Fournier's record for twenty miles was 25:20 2-5. Sartori's times by miles for the fifteen miles were: One, 1:02; two, 1:59; three, 2:57; four, 3:55; five, 4:53; six, 5:52; seven, 6:51 4-5; eight, 7:51 3-5; nine, 8:50; ten, 9:48 4-5; eleven, 10:46 4-5; twelve, 11:46 3-5; thirteen, 12:45 3-5; fourteen, 13:44; fifteen, 14:42 2-5.

THE EMPIRE HANDICAP.

Great interest was shown in the Empire Handicap five-mile free-for-all. The starters in the first heat were H. E. Rogers in a 24-horsepower Peerless, Wayne Kratzer in a 10-horsepower Duryea, J. W. Hilliard in Huggins's 40-horsepower Decauville, D. Landau in Joseph Cowan's 15-horsepower Panhard, "Teddy" Goodman in a 16-horsepower Rambler, and W. F. Winchester in the 10-horsepower Franklin racer. All were started from the tape, the handicaps being by time instead of distance. The Duryea and Rambler were sent away first, followed by the Peerless and Franklin. The Duryea displayed unexpected speed, but the Franklin picked up in the second mile, passing the Duryea on the turn into the back stretch and the Peerless as they entered the home straight. Hilliard in the Decauville then gradually picked up and passed the Franklin entering the last turn in the fourth mile and won by half a mile in 6:02, with a handicap of 40 seconds. Winchester (50 seconds)

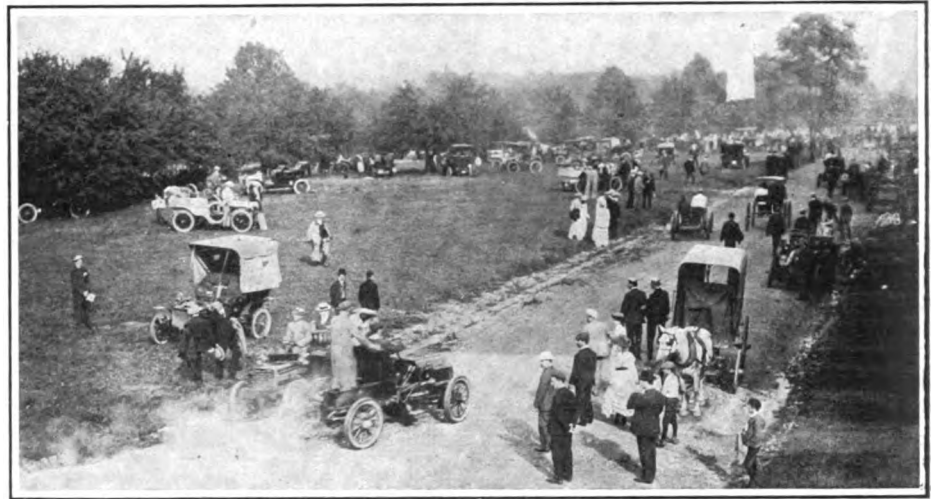

IN THE ORCHARD BACK OF THE GRAND STAND AT THE EMPIRE CITY TRACK

was second, and Rogers (70 seconds) was third.

The second heat of the same race was faster and more interesting, the starters being Sartori (40-horsepower Mercedes), 10 seconds handicap; Bernin (30-horsepower Renault), 15 seconds; A. E. Morrison (24-horsepower Peerless), 110 seconds; Mensel (60-horsepower Mercedes), 10 seconds; Vaughn (40-horsepower Decauville), 40 seconds. H. S. Harkness, who was entered to drive his 60-horsepower Mercedes, did not put in appearance Saturday and arrived by touring car Monday with the explanation that his Mercedes was out of order. In this heat Arents Mercedes and Brokaw's Renault ran much better than in any of the previous events, developing speed fully equal to that of Vanderbilt's Mercedes. Mensel, in Arents' car, kept on even terms with Sartori in Vanderbilt's Mercedes and passed Bernin in the Renault in the back stretch in the fourth mile.

Tremendous clouds of yellow dust were thrown up on the turns, the huge machines plunging into complete obscurity in them when going at a speed of more than sixty miles an hour. In the fifth mile Sartori slowed down somewhat and coasted the last turn, coming to a stop at the head of the home straight. Bernin, with the Renault, won in 5:30, with the benefit of his 15 seconds handicap, Morrison's 110-second handicap secured him second place, and Mensel was third. After the finish Sartori's car was pushed to the judges' stand and then towed off the track. Examination showed that a leak in the pump had allowed the cooling water to escape so that in the twenty-mile event and the five-mile heat following so soon afterward, the engine had overheated with serious results.

MORRISON WINS THE FINAL.

There were four starters in the final of the five-mile, as follows: A. E. Morrison (24-horsepower Peerless), 110 seconds; W. F. Winchester (10-horsepower Franklin), 60 seconds; Maurice Bernin (30-horsepower Renault), 15 seconds; and J. W. Hilliard (40-horsepower Decauville), 40 seconds. Morrison, with his big handicap, had made more than one lap and Winchester had nearly completed a mile, when Bernin was sent away. But the Renault got under top speed almost instantly and went out after the flying Winchester and Morrison, the limit man. Hilliard's Decauville had a leaking pump connection and hot water and steam poured from the bottom of the radiator. With a hot engine, it was only able to keep on even terms with Morrison's Peerless, although the latter carried a touring body with only the tonneau seats removed. In the back stretch in the fifth mile Bernin succeeded in overhauling and passing the Franklin, but he could not overcome the big allowance given Morrison, who won in 4:52 2-5, or 6:02 2-5 actual running time. Bernin ran second in 5:12 3-5 and Winchester third in 5:16 2-5.

There were only two starters in the mile record trials. Mensel, in George Arents, Jr.'s, 60-horsepower Mercedes, drove a mile

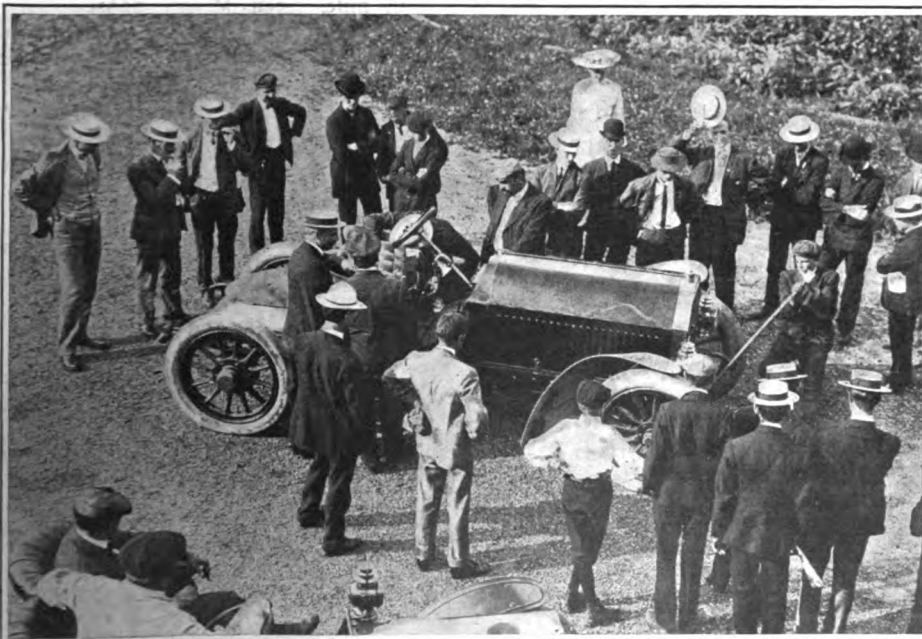

STARTING THE MOTOR OF THE 75-HORSEPOWER WALTER CAR WITH BAR.
First Car in America Started with Bar.

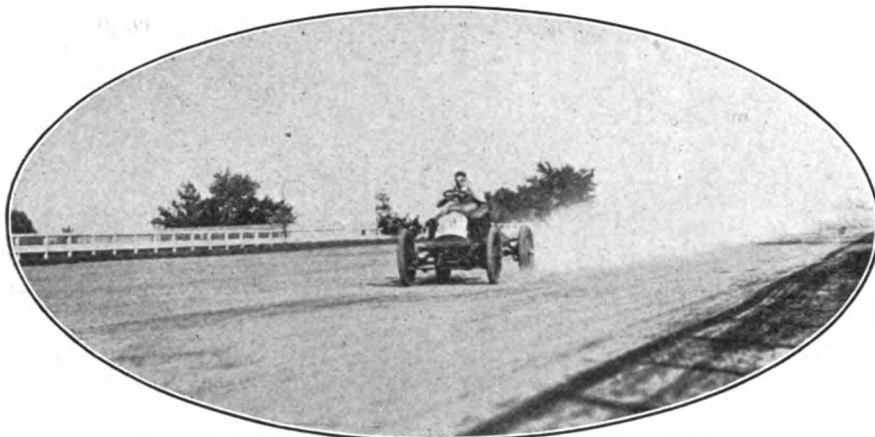

BERNIN IN W. GOULD BROKAW'S RENAULT COMING DOWN THE HOME STRETCH.

in 59 2-5 seconds, and Bernin, in W. Gould Brokaw's 30-horsepower Renault, made a circuit in 59 seconds flat.

The best mile of the meet was made by Sartori, who drove the second mile in the final of the fifteen-mile free-for-all in 57 seconds flat.

PARK AUTOS IN NEW YORK.

THE hackmen who ply their calling in Bronx Park, New York, and spend their spare time in devising means for making the park-visiting public fork over more of its good hard cash, will soon be brought to terms, according to William P. Schmidt, Park Commissioner for the Bronx, who states that an automobile company has been given a concession to inaugurate an automobile cab service in the Bronx and Pelham Bay parks. The general plan will be somewhat similar to that under which the Central Park automobile cab service is operated. The main stand will be at the elevated railroad station at Third and Pelham avenues, and from this point the fares will be 10 cents for the trip to and from the Botanical Gardens and the same to the Zoological Park and return, while it will cost but 25 cents to go to Pelham Park and back, a distance of about 4 miles. The present cab charge for this trip is \$1 for each passenger, or more, if the cabby can get it.

The company to whom the concession has been given has agreed to these low rates in return for a low charge for the concession. The name of the concern has not yet been divulged, but it is said to be a large and responsible one. As soon as the arrangements have been completed the cab-men will be forced to pick up their fares outside of the parks. They will, of course, be permitted to drive through, but can only take passengers from outside, and those who have taken up a stand in the park will have to locate elsewhere. It is anticipated that the service will be in operation about August 1.

Automobiles on Tracks.

A rather novel experiment in interurban traction is to be made before long in the neighborhood of Warsaw, Ind., if the plans

of J. V. Godman, a civil engineer of that town, materialize. Mr. Godman has invented what he calls a "monolithic railway," which is in effect a permanent way with rails of concrete about 12 inches wide, reinforced by expanded metal, instead of steel. The rolling stock is to consist of automobiles and trailers, with pneumatic tires; and, according to the inventor's idea, these are to be kept on the "rails" by raised flanges on the outer edges of the rails themselves, as shown in the illustration herewith. A drawing furnished by the inventor shows an automobile 'bus, with small horizontal rubber-tired guide wheels at front and rear, which are to bear against the track flanges and protect the regular tires from side friction. A special guiding arrangement for crossing highways is also shown.

According to Mr. Godman, a track ten miles long, connecting two towns with a summer resort between them, is before long to be built to test the practicability of the scheme on a working scale. It is proposed to use three 16-horsepower touring cars, each to cost, with canopy top and side curtains, \$1,500, and three twenty-passenger trailers at \$8,000 each. One trip an hour is contemplated, giving an average speed of fifteen miles per hour between stops.

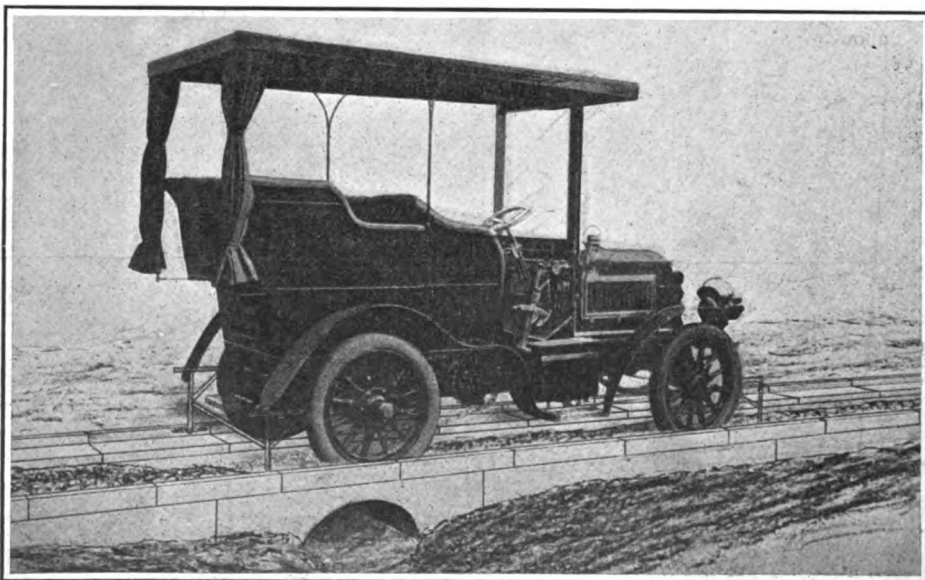

"MONOLITHIC RAILWAY" FOR AUTOMOBILES, DESIGNED BY J. V. GODMAN OF WARSAW, IND.

The maximum gradient is to be 3 per cent., and curves are to be of 10 per cent. at least.

The drawings, etc., are accompanied by a table of estimated costs, from which it is made to appear that the total cost of a ten-mile trip will be 77½ cents. This looks very well, but a study of the table shows that the repair bills and tire bills have been either overlooked or else included in the 15 per cent. per annum allowance for depreciation. In reality they would hardly add less than 50 per cent. to the above estimate of expense. The right of way is supposed to be donated, and the cost of track is reckoned at \$2,500 per mile, depreciation 3 per cent.

The illustration shows slight supports at front and rear for the guide wheels. Even with these, however, it would be necessary to steer the car, and as the estimate does not provide for additional help the driver would also have to collect fares. This would be possible, under the circumstances, only at stops.

The general scheme of the invention is interesting, as it suggests the automobile highway which has been frequently suggested for Long Island and elsewhere.

THE latest map to be issued by the Automobile Club of America, in its series of road maps of Eastern States, is one showing the central section of New Jersey. It includes all the territory between Jersey City and Philadelphia, the northern approaches to which are shown, but not the city itself; also all territory east of Whitehall and Schuylkill, Pa. Like the other maps of the series, it is cut into rectangles, each 4-3-4 by 9 inches, and mounted on muslin with 1-8 inch of space between rectangles, so that it folds readily into any shape without breaking. The through routes and distances between towns are marked in red.

WHITE MOUNTAINS TOURNEY.

**Tours Completed According to Program—
Good Roads Meeting Postponed.**

Special Correspondence.

BRETTON WOODS, N. H., July 13.—The regular schedule of hill-climbing events having been completed on Monday and Tuesday, it was the intention of the officials to hold a series of special climbs against time to-day (Wednesday) should the weather prove favorable. As morning broke with rain pouring down, all who had left early calls turned over for another nap after a look out of the window. Later, however, the sun broke through the mountain mists and burned away the clouds. Quick to take advantage of the change, the automobilists brought out their machines and when Governor Bachelder arrived on the noon train it was decided to form a parade of all the automobiles that had taken part in the climb. This was carried out, and twenty-one strong, they paraded about the Bretton Woods roads and then filed to Crawford's, where General W. A. Barron and C. H. Merrill, the managers, welcomed them cordially. All the automobiles were lined up at about 4 o'clock in front of the Mount Washington Hotel and were "biographed," together with several equestrians who happened to be near-by, showing that the Bretton Woods horses do not fear automobiles.

At a meeting held this afternoon at the Mount Washington, it was decided to transfer Saturday's endurance run to Thursday and to-morrow morning a 7 o'clock start will be made by twenty-five cars. The route will cover about 65 miles and lies through Littleton, Franconia, Bethlehem and Profile House. Friday's event will be run as scheduled, the 95 miles circuit of the mountains.

MOUNTAIN TOUR ON THURSDAY.

LITTLETON, N. H., July 14.—Twenty automobiles took part in the mountain tour to-day. The cars that started from Mount Washington were of all sizes, from the little runabout to a 40-horsepower gasoline touring car. The route followed took the tourists through Whitefield, Lancaster, Littleton, Franconia and Bethlehem. Governor Bachelder and ex-Governor Jordan, of New Hampshire, joined the run at Whitefield.

The only accident of this day's run was the breaking of a wheel on Harry Fosdick's automobile, caused by collision with a rock. A new wheel was secured and put on, however, and Fosdick overtook the others on the road. No one was hurt. The distance from Whitefield to Lancaster is about 10 miles, and was negotiated in 50 minutes. From Lancaster to Littleton, 21 miles, the run occupied slightly more than one hour. All arrived safely.

FINAL DAY OF TOURNEY.

MOUNT WASHINGTON, July 15.—The last day of the Mount Washington tour was spent in making a 95-mile run among the

northern hills of the Presidential range, through the Crawford Notch and the towns of Jefferson, Randolph, Jackson, Intervale and North Conway. Eighteen cars made the start this morning, and the run was made at an average speed of about 15 miles an hour.

A gear in the automobile of L. J. Phelps, of Boston, unfortunately broke, disabling the car, but Otto Nestman threw him a line and towed him ten miles to Jackson, where the Phelps party was left.

The following were awarded gold medals for meritorious performances in the touring events: H. W. Alden, gasoline Columbia, 12-hp.; James L. Breese, Mercedes, 40-hp.; Arthur Gardiner, Rambler, 16-hp.; Webb Jay, White, 10-hp.; George H. Lowe, White, 10-hp.; Frank Nutt, Haynes-Apperson, 12-hp.; John G. Prouty, Winton, 20-hp.; Percy Pierce, Pierce, 24-hp.; Harlan W. Whipple, Mercedes, 40-hp.; Harry Fos-

The Good Roads meeting, which was to have been held on Saturday, July 16, was called off. This was the only "event" in the entire series that was not carried out according to arrangements made.

TOLLS ON AUTOS ILLEGAL.

Special Correspondence.

MILWAUKEE, July 16.—Because automobiles were not in use when the toll road charters were granted, automobile owners and drivers cannot be required to pay toll over turnpikes in this county that are under private ownership. This fact was brought out at a meeting last week of the county board committee on highways and bridges.

The charter of the Fond du Lac toll road, which was granted in 1868, granted permission to tax horses at a specified rate per head, and later similar provisions were made in charters granted to cover the

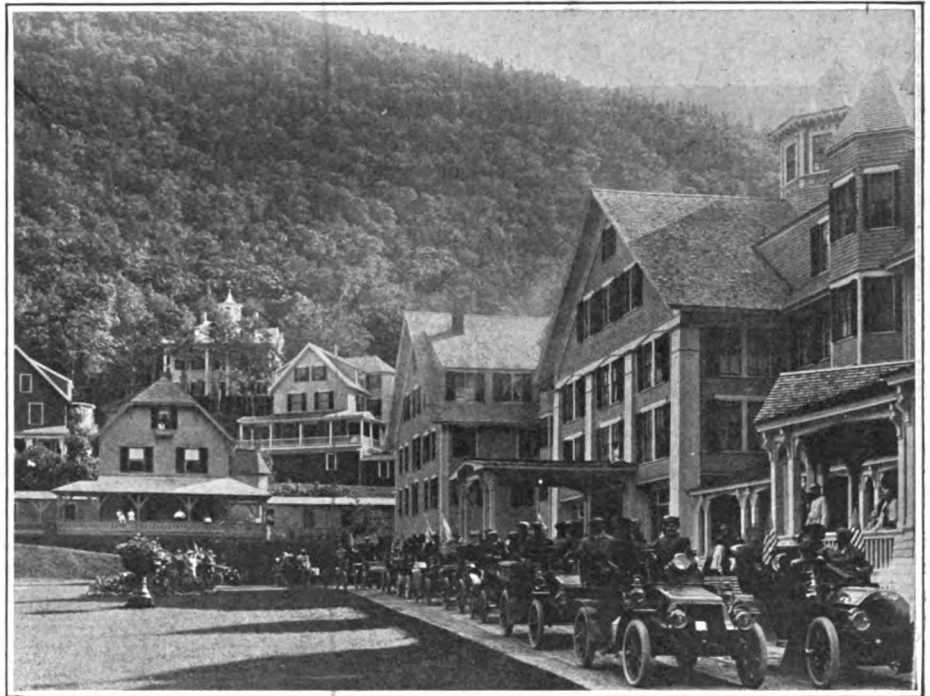

PARADE OF CARS AT THE PROFILE HOUSE NEAR FRANCONIA NOTCH, WHITE MOUNTAINS.

dick, Winton, 20-hp.; C. C. Hildebrand, Stevens-Duryea, 7-hp.; B. A. La Mont, Cadillac, 8-hp.; F. E. Stanley, Stanley, 6-hp.; L. R. Speare, Winton, 20-hp.; Mrs. L. R. Speare, Winton, 20-hp.; Alexander Winton, Winton, 24-hp.

A silver medal was awarded L. J. Phelps, Phelps, 20-hp., for one day's prospect record.

The official report of the Chronograph Club, of Boston, which had in charge the timing of the "Climb to the Clouds," shows that the following corrections should be made in the list of times as originally published:

Event No. 2—Price \$650 to \$1,000.		
Make.	Driver.	Time.
Olds.....	Benj. Smith,	7-hp...1:06:00 4-5
Event No. 4—Price \$1,800 to \$2,000.		
Phelps.....	L. J. Phelps,	20-hp...:56:15 2-5
Event No. 5—Price \$3,000 to \$6,000.		
Winton....	Alex. Winton.1:33:02 3-5

Whitefish Bay and several other toll roads radiating from this city. With the advent of bicycles and automobiles the holders of the charters have taken for granted their right to exact toll from the users of these vehicles, but it is said to be clear that in the event of a protest the motorist would come off victorious. The county supervisors claim that the toll, as applied to bicycles and automobiles, is illegal, but the automobile owners are paying it and making no protest because the tax is used to improve the roads. Automobiles are subjected in this county to a tax of ten cents for a single seated vehicle and fifteen cents for one with two or more seats.

TRUSTEES of the Campbell County Turnpike Company have raised the toll on automobiles from 50 cents to \$2 for the round trip between Alexandria and Newport, O.

Hints to Touring Car Purchasers—III.*

Proper Care and Adjustment of a Car Upon Its Delivery from the Builder's Factory, with Explanatory Photographs.

By JOSEPH TRACY.

WE are now ready to consider starting the motor and taking the car out for a trial spin. If one has not previously driven the same kind of car, it is advisable to push the machine out of doors rather than run it out under its own power.

PROPER WAY OF STARTING.

A little suggestion as to the proper way to hold the starting crank: Never push down, as shown in Fig. 11, when attempting to start the motor, because a "back-

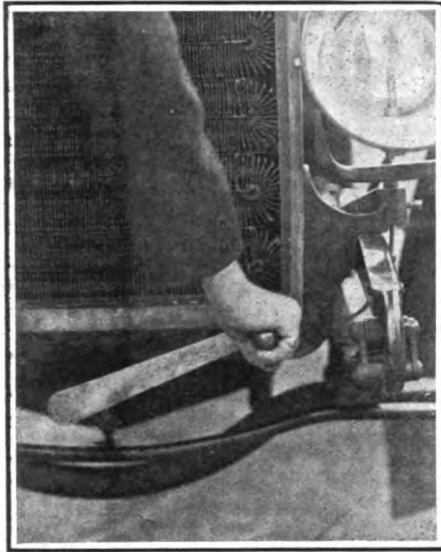

FIG. 11.—WRONG WAY TO CRANK.

kick" when pushing down will generally result in a broken or sprained arm. The correct way is shown in Fig. 12. Partly grasp the crank with the four fingers of the right or left hand, according to the direction the engine turns, so that the crank lays across them midway between the palm and finger tips, and then pull up. If the motor should "kick," the crank will be merely pulled or slid from the fingers, and will not hurt in the least. Stand in such a position that in case of a back-kick the free end of the starting crank will not strike the legs.

Before starting the motor, the throttle should be set so as to prevent the motor from running too fast and the hand brake put on rather tight. This in most cases disengages the clutch, and so allows the low gear to be engaged subsequently without rasping or making noise. Assuming that the clutch is properly fitted and adjusted, the proper position for the change speed lever is in the neutral notch. After starting the motor the driver can now take his seat at the wheel, grasping this with one hand—which hand depends upon the side the car is steered from—and the change

speed lever with the other. A good position is that shown in Fig. 13, but this is largely a matter of individual preference, and after a little practice the driver can select the method which comes "most natural" to him. Next place the feet securely on the pedals, as shown in Fig. 14, which represents a type of car in which the pedals are operated by a downward pressure. Now move the change speed lever into the first gear notch and then gently release the hand brake, thus causing the clutch spring pressure to come on the clutch pedal. By easing up on this pedal, the clutch will engage and the car will move forward. Don't be in too great a hurry to get into the second speed—not until you are well able to handle the car on the low speed.

PRACTICE STEERING THE CAR.

Find how nearly in a straight line you can drive, also how well you can get around a right-angled corner. Practice stopping with the front wheels touching a mark across the surface of the road, and see how near to this the wheels can be brought without overrunning. Now try running backward slowly. It is hardly necessary to say that the driver must be able to see over the back of the machine to practice this evolution. If possible select a good, wide, level road, free from traffic for these trials.

POINTS ON SPEED CHANGING.

The question of changing gears now calls for consideration. Recollect, always that when changing from a lower to a higher speed the engine should be "accelerated" before the change is made. It follows as a natural consequence that the reserve of engine power at any given car speed should be sufficient to cause the motor to race at the time a change of speed from a lower to a higher rate is attempted. When changing from a higher to a lower speed there is manifestly no necessity for engine acceleration.

When you are able to handle the car well on the low gear, you may safely change into the next. Before changing gear the motor should be accelerated a little, the clutch withdrawn, and the gear lever moved smartly to the second speed notch. Be careful, however, not to get past the notch. If there is a "latch" on the change speed lever, it will, of course, have to be first raised, before the lever can be moved. It will facilitate changing gear to raise the latch and then move the lever until the latch clears the notch, when it may be released. The latch will then be in contact with the quadrant and ready to drop into the second speed notch when the lever reaches that position. The latch by drop-

ping into the notch, tells when the gears are in mesh. This method of changing is much easier than when one lifts the latch and holds it clear of the quadrant until the gears are *thought* to be meshed and then releases the latch, which may not find its notch until the lever is moved back and forth several times.

GRIDIRON TYPE OF QUADRANT.

In cars having the "gridiron" or Mercedes type of quadrant, care must be taken that the gear change lever is not moved into the wrong slot. In going "up," if a gear is skipped, say from first to third, it will not do so much damage as if a gear is skipped in changing from a high speed to a low, say, from fourth to second. In the latter case a great strain is imposed on the clutch and transmission, as the momentum of the car is utilized in turning the motor over at an extremely high speed, and may result in breaking a gear or twisting a shaft.

The beginner should practice changing gear until this can be accomplished without looking at the quadrant, as this takes his attention from the road in front. This is not so likely to cause a mishap in a car fitted with change speed lever on the steering post, as looking at the lever in this form of control does not necessitate a



FIG. 12.—RIGHT WAY TO CRANK.

change of position of the head, but simply a momentary glance. On cars equipped with the usual side lever, changing gear "without looking" is more difficult on those having gridiron quadrants than on those in which the change speed lever has no lateral movement.

MOTOR WILL SLOW DOWN.

It is well to bear in mind that when changing from a low gear to a higher one, the motor will run slower after the gear has been changed. For this reason when you unclutch to change to a higher gear,

*Continued from page 37, issue of July 9, 1904.



FIG. 13.—POSITION OF HANDS.

the clutch shaft and gear wheels mounted on it must be slowed down before the gears can be meshed. As the natural tendency of revolving bodies is to come to rest, or to slow down, this explains why it is usually easier to change from a low to a high than the contrary. When a change is made from a high to a low, the clutch shaft will turn faster after the change is effected than before. Consequently, in order to mesh under these conditions the clutch shaft has to be accelerated. Usually the most convenient way to do this is to bring the slow moving gear into forcible contact with the fast moving one, resulting in much rasping of gears.

USES OF THE PEDALS.

In pressing down the clutch pedal before changing, be careful not to press the brake pedal at the same time. Some beginners find it difficult to press down one foot without pressing down the other also. When driving make it a practice to hold your feet on the pedals. This will feel uncomfortable at first, but after awhile you will feel uncomfortable unless your feet are on the pedals. That is the proper way to feel. If the driver keeps his feet on the floor, and is called on suddenly to stop the car, he cannot do so as quickly as if he already had his feet on the pedals.

Be careful when resting the feet on the pedals that the weight of the feet does not partially withdraw the clutch and so cause it to slip and burn the leather. Always allow the clutch to engage gradually and so prevent undue strains on the transmission.

We will now assume that the driver is familiar with his car and can steer it easily. The next thing in order is a short trip, say ten or fifteen miles. Before starting out, fill the various receptacles with water, gasoline and cylinder oil. See that the tires are all pumped tight, that the brakes act

properly, and that the full equipment of tools and spare parts is aboard.

TOOLS AND SPARE PARTS.

Tool equipment should include spark plug wrenches, large and small screw drivers, gas and cutting pliers, large and small file, hammer, medium size pin punch, large and small cold chisel, spanners to fit the most important nuts on the car, large and small adjustable wrenches, hack saw and small hand vise, oil syringe, tire levers and jack and tire pump.

The extra parts and supplies should include funnels for water and gasoline, spare inner tubes, which should be carried in canvas bags, cement and patches for repair on tires, a complete set of parts for tire valves, pieces of rawhide to repair cuts in tire shoes, or envelopes, French chalk and canvas patches. Also some nuts and bolts, soft iron and brass wire, assorted split pins, small wire cable, extra chain links, a piece of small rope and cans of oil and grease.

Motor parts should include spark plugs, inlet and exhaust valves, springs and cot-ters and collars for the valves, springs for the governor, gaskets for the various pipe connections, the spark plugs, and the valve chamber caps, pieces of rubber hose for water pipe connections, clips for the hose, extra tremblers and contact screws and brushes for the distributor. Some lengths of primary or battery wire and plug wire, and insulating tape of the best kind will be useful additions to equipment.

Many cars are fitted with a volt or ammeter and if not it would be well to have one permanently secured to the dashboard and connected by means of a switch or push button with the batteries.

If the car has a make and break system of ignition the various springs, rods, and tappets, which may break or wear should be taken along, also some of the insulated electrodes between which and the tappets the spark occurs.

While the foregoing may look like a formidable list it is actually not extensive or expensive. It may be necessary to use any one of the articles mentioned on the



FIG. 14.—POSITION OF FEET ON PEDALS.

initial ride, but it should not be forgotten that a breakdown on a short ride calls for the same repair equipment as a breakdown on a long tour—having reference in each case to roadside repairs and readjustments.

ATTENTION TO THE SPRINGS.

If the car is to run over rough roads it is a good plan to fit small rubber blocks on the middle of the springs to prevent the frame from striking the springs or axles. Another good plan is to fasten straps around the axles and frame, leaving sufficient slack to allow free vertical movement of the body. These straps are useful also in preventing the top spring leaves from being fractured. Such fractures are caused by the weight of the wheels and axle hanging from the top leaves only. This happens when the car strikes a rut or stone. The frame and body are driven upward by the recoil of the springs, while the wheels and axle are driven in the opposite direction. A bad jolt may raise the front wheels off the ground. In this case the momentum of the wheels and axle will be borne entirely by the top leaves of the front spring, as these are not fastened to the other leaves at any point except in the middle, where the spring is clipped to the axle. Clips which embrace the top and the second and third leaves are often used instead of straps.

(To be continued.)

BEXHILL AUTO CARNIVAL IN AUGUST.

Arrangements are being made at Bexhill-on-Sea, England, for a most interesting series of sporting and social events for August 1, 2 and 3, with Earl de la Wars and Mr. V. Stratton as principal promoters. According to the scheme at present made known, a parade of all the cars foregathered will take place in the morning, to be followed by the preliminary heats of the races in the afternoon. The second day will be entirely given up to the semi-finals and finals of the speed contests, while the third day has quite a Continental touch about it, more remindful of the Riviera at its gayest than staid and sober England with its battle of flowers, gymkhana and torchlight procession, with prizes for all the best decorated and best illuminated cars. If only the weather is fine, Bexhill should be the center for a large number of motorists. The races take place on the Parade, where the meeting was held two years ago, and are open only to touring cars.

An automobile road is being constructed from the McCloud River, Cal., to a point on the line of the Southern Pacific Railroad in the Sacramento River canyon. The road will proceed from McCloud River down Squaw Creek. The last part of the road is a horse trail, which will be widened and rendered suitable for vehicles. Several rich San Francisco men who have summer houses on the McCloud River will operate an automobile line over the highway, which they intend to put into fine condition.

Long Island R. R. Crossing Fatality.

Automobilists Killed at Rockville Centre—Reckless Driving, Brakes out of Order, and No Gate, Contributory Causes.

A COMBINATION of reckless driving, a machine not in proper running condition, and a grade crossing without gates, was apparently responsible for the death of three automobilists on the Long Island Railroad at Rockville Centre

slight grade and was just jolting across the east-bound track when the pilot of the engine caught it almost squarely in the middle. One of the occupants was tossed in the air and was picked up fifty feet away, clear of the tracks. The automobile

driver, was, it is said, somewhat inclined to take chances. This would seem to be borne out by the manner in which the crossing was approached, especially when the physical conditions existing at that point are taken into consideration.

For two or three miles west of the Rockville Centre crossing the Merrick Road, which is famous for its fine condition and a favorite highway for automobiling, runs parallel to the railroad track. Vehicles on the road can be distinctly seen from trains, and trains are plainly visible from the road, except at occasional intervals, where trees intervene. Then the road turns at an obtuse angle, the turn coming out on the straight road with the crossing in full view just 800 feet from the tracks, as shown in the sketch. In this 800 feet there are seven telegraph poles carrying incandescent electric lights on brackets projecting about 13 feet above the road. The road is 23 feet wide where it crosses the tracks.

A conspicuous sign to slow down stands by the road at a distance of about 400 feet from the tracks, and calls for a reduction of speed to 8 miles an hour. On the south side of the tracks and the east side of the road is one of the familiar diamond-shaped railroad crossing signs, plainly visible from the turn in the road; but this is the only signal with which the crossing is equipped, there being no bell or other sound warning and no gate. The actual crossing is somewhat high, and the road rises as it approaches the track.

Mr. Correll was very familiar with the road, and witnesses state that he and his companions had their heads down as the swiftly moving vehicle rushed toward the tracks. The opinion is expressed that there was a race between the automobile and the train for the crossing.

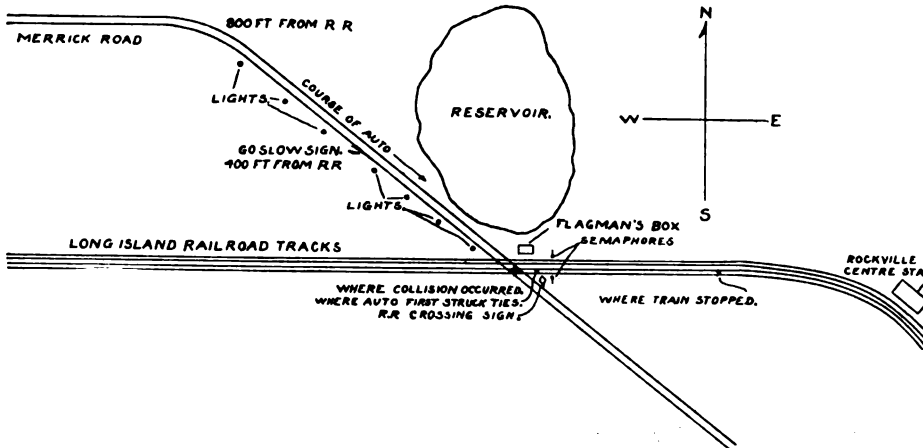

SKETCH MAP OF THE LOCALITY WHERE THE FATAL ACCIDENT OCCURRED.

on Wednesday evening, July 13. The three men were Frank Correll, a real estate dealer of Brooklyn, James Snyder, East Durham, N. Y., and Genet S. Jewell, Brooklyn. As there are no survivors of the accident to tell exactly what took place all that is known has been gathered from eye-witnesses and from a technical examination of the car and crossing.

In the accompanying sketch plan the details of the road conditions are plainly shown. The car, a Searchmont, with the three men in it, was going at a high rate of speed along the well-known Merrick road just west of Rockville Centre. It was about 9 o'clock at night and as the moon was not shining the road was dark except for the light cast by a number of incandescent lamps strung along at intervals on the approach to the crossing.

There is a sharp bend in the road about 800 feet from the tracks. Assuming that the car was traveling 20 miles an hour only about 30 seconds would elapse from the time the crossing was sighted until the car was on the tracks, provided it was not slowed down.

S. E. Van Nostrand, the railroad watchman at the crossing, says that shortly before the accident an east-bound passenger train was approaching and he gave the engineer a clear signal with his lantern. Hardly had he done this when he saw an automobile approaching the crossing at high speed. Standing in the middle of the roadway, he swung his lantern to warn the occupants of the machine which continued on its course with no apparent diminution of speed. He also shouted at the top of his voice in the hope of averting a collision, but the automobile rushed on, up the

was carried along on the pilot for 500 feet or more, scraping the ties at intervals, and when the train finally was brought to a standstill the remaining two men in the car were picked out of the wreck, crushed, mangled and torn almost beyond recognition. The man thrown out by the impact was found to be still living, but he expired about an hour later without having regained consciousness.

Mr. Correll, who was driving, was the owner of the automobile, which was a



LOOKING TOWARD CROSSING IN DIRECTION AUTOMOBILE WAS TRAVELING.

two-cylinder 16-horsepower tonneau. It is said that he was desirous of selling it and that Mr. Snyder was the prospective purchaser. The fatal trip was probably made to demonstrate the running of the machine, and Mr. Jewell went along as a passenger. The party started in the automobile from Mr. Correll's office in Brooklyn. Mr. Correll had owned three automobiles before the ill-fated Searchmont, and, though a good

A careful examination of the wrecked automobile indicates that the machine was apparently moving very slowly when struck by the locomotive. The point of impact is on the frame on the driver's, or right hand, side, about eight or ten inches back of the dash board. The wood sill was broken and the steel fitch-plate bent badly at this point. The cross member at the back end of the frame was out of place at the cor-

ners. Both side members of the frame remained approximately parallel, from the point of collision to the back ends. Both main and sub-frames rearward from the point of impact were pushed out of alignment with the forward part of the frames—see diagram. The front springs were knocked to pieces and their hangers bent

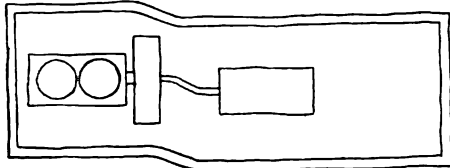

FRAME AND CLUTCH SHAFT BENT BY COLLISION.

and twisted. The rear springs sustained almost no damage, although the axle was wrenched off them completely. The front axle was bent, but the rear axle was not. The front wheels were not broken, the tires however, were burst. The rear wheels were

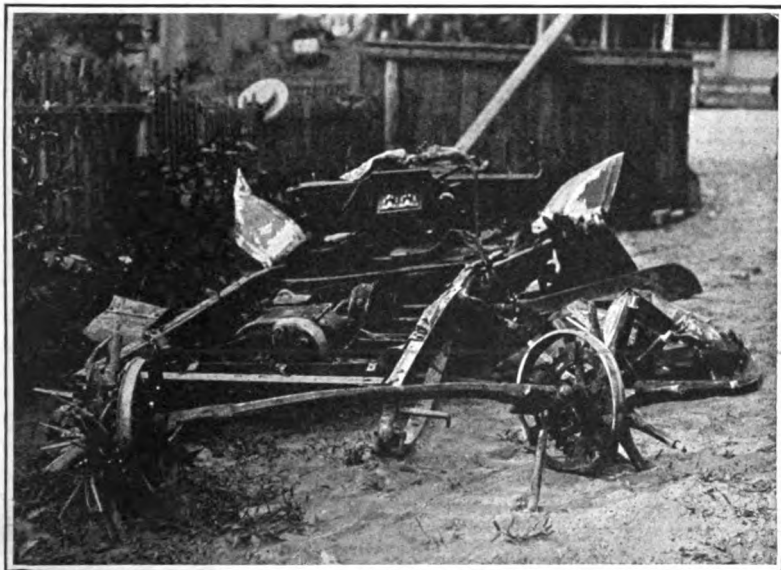

PHOTOGRAPH OF THE CAR AS IT LIES IN NEIGHBORING GARAGE.

badly smashed, only the broken stubs of the spokes remaining in the hubs. The motor seemed unharmed, with the exception of the flywheel, which was broken off at the hub, leaving the latter on the crank-shaft. The shock which broke off the flywheel, without doubt, also sprung the crank-shaft. The clutch cone was broken off its shaft and the latter bent very badly, close to the square sliding joint. The gear box was cracked at the right hand back "lug," but was apparently otherwise uninjured.

It is impossible to say in what condition the gears were or in what speed the car was at the time of the accident, as access to the interior of the gear box could not be had when this investigation was made. The differential shaft was not bent, but was very much out of line with the sprocket shafts. Tanks, both water and gasoline, were off, as was the radiator.

Both the drum and band on the foot

brake—which acts on the differential shaft—were covered with oil. This would indicate that this brake was not in good working order. One of the side brake drums on the back wheels was worn bright and smooth—the other seemed as if the band did not grip it when this brake was set. Judging from the appearance of the car after the accident it seems pretty certain that the right hand rear wheel brake was the only one on the car which was in proper working order. From this it will be seen that it would be impossible to slow down the car suddenly if traveling at high speed.

Taking into consideration the lay out of the crossing, and the condition of the wrecked car, it seems reasonable to suppose that the machine was traveling fast as it approached the tracks, and that when the driver saw the train he tried to stop. Finding he could not do so, owing to defective brakes, he next decided to go on, thinking that he could cross in time to avoid a collision. The clutch may have been thrown

Exchange and Record of Ideas.

During a recent trip to one of the automobile factories, the writer had a chance to see something of a carefully designed and well-handled card system of communication between the various departments of the whole establishment. It is in reality a simple arrangement, making a ready and convenient means of answering questions constantly arising in the various branches of any large business organization—particularly where it is not so important to have immediate replies as to ask the question or make the memorandum while the matter is fresh in mind.

In the system to which reference is made, one side of the card is blank, while the other bears a double column of titles (or their abbreviations) belonging to the persons most likely to use this kind of communication. One column is headed "From," and the other, "To." A line drawn obliquely across the space between—that is from the one asking the question to the one addressed—serves the purposes of both address and signature. It may happen that in seeking certain information a card passes through several hands, in which case the connecting lines between the names in the two columns will sometimes cross each other; but in all cases they will show the routes the cards have traveled. The system is one of "Memoranda in motion," and it will be found sufficiently elastic to take care of most detail matters.

The use of these correspondence cards presupposes an arrangement of pigeon-holes in which several classifications may be kept ready for quick and easy examination. Each officer or department head should be provided also with suitable means for handling and filing such cards as belong to his department. A miniature post-office and messenger system, by which inter-communication between all branches of the establishment is facilitated, will add to the completeness and usefulness of the plan.

Some very careful and efficient work, both in the exchange of memoranda and in temporary records making, can be done with a card system of correspondence, in any establishment so large that the managers do not meet their department heads several times a day, or where the latter cannot readily see each other as often as any matter of importance to two or more comes up. A telephone system "connecting all departments" is good in its way, but the party called up by 'phone may not be in, or if in, unable to respond at once, and at the best there is no time to deliberate over, and no record kept of the matter. A card system goes to a man's desk, to be picked up at a convenient moment; and it may either be attended to at once or laid aside for further consideration. When it does get back to the other party, it represents something to be relied upon, whether a simple memorandum or an important inquiry. Such a device may save many an expensive error.

Motive Power for Automobiles.*

By PROF. R. C. CARPENTER.

THE development in the automobile art has been more rapid in this country than its most sanguine disciples could have predicted five years ago. The development is the result of the application of the best mechanical and engineering training of the present age and serves to illustrate how much can be accomplished by an active people in an exceedingly short period of time when the sister mechanical arts are fully developed and able workmen and good tools are to be obtained. The development has been carried to great perfection, not only along the line of power development, but also as regards the construction and development of the vehicle. The motive power at present used is principally derived from steam or gas or from some stored force, as, for instance, electricity; of these three well known methods of propulsion, the steam engine and the gas engine are to be alone considered as prime movers or devices for generating mechanical power directly from the fuel.

THE ELECTRIC AUTOMOBILE.

Electricity as a power represents the force generated by the mechanical motion produced by some prime mover such as the steam engine, the gas engine, the water wheel or the wind mill; it is not at present produced to any practical extent directly from either the combustion of fuel or by chemical reactions. Electricity has been used for a long time for moving vehicles, in two ways; in the first way the electricity is stored in a storage battery which is moved with the vehicle; in the other, the electricity is supplied as required by connecting wires leading to the generator or other source of energy; the electrical current drawn either from the battery or generator is retransformed into mechanical energy by an electrical motor in both cases.

The storage battery which is employed in nearly all of the electrical carriages of the present time is very heavy, being composed largely of lead. The so-called storage process is principally a chemical action during which chemical products are formed in one of the two battery plates; during the discharge of the battery and at the time it is giving off current, the chemical products formed during the charging process are dissociated and reconvert the energy of chemical combination into that of electricity, which can be utilized in the electric motor for the purpose of locomotion.

In proportion to the energy which can be supplied, the storage battery is extremely heavy, consequently aside from any objections which might arise from the fact that the electric vehicle is not provided with primary means of locomotion,

the distance which the vehicle could go without charging, or, in other words, its radius of action, must be necessarily limited.

The storage battery is of necessity imperfect and a certain percentage of the charging current is lost in overcoming useless resistances or dissipated without useful results, so that the efficiency is necessarily less than 100 per cent. Practically, it is not likely to be over 75 per cent. When it is considered that the electricity which is used for charging a battery must be purchased at commercial prices and at prices which would probably give considerable profit to the owners of large electric plants, it would follow that the commercial efficiency of the electric vehicle must always be low and the corresponding expense of operating rather high; whether it is more expensive or not than other forms of energy available depends upon the conditions surrounding the production of power in other ways. As a rule, great economy in the generation of power is hardly to be expected for small engines used under the conditions of automobile locomotion. The electric carriage enjoys the distinction now of being the easiest to operate and control, the most nearly noiseless in operation and the most cleanly in use, and it is not likely to be deprived of these distinctions.

THE STEAM CARRIAGE.

The steam engine has advantages of its own as a motive power for propelling automobiles which render it extremely desirable under many conditions. The motion of the piston being produced by the direct application of the boiler pressure, gives a strong starting force and a powerful turning effort which is of great advantage when the vehicle is first put in motion or when the vehicle is employed to overcome grades or to exert great tractive effort at low speeds. The steam engine with its attached steam boiler and furnace constitute on the whole a complex organism and no little skill is required to properly operate both the boiler and the engine, to see that it has a proper supply of water and fuel and in addition give attention to the guiding and controlling of the vehicle. These difficulties have in large measure been overcome by some recent improvements in the steam boiler which are of such a nature as to practically render it automatic, and thus relieve the operator from many of the troubles which were incident to the use of the ordinary boiler and engine.

The steam engine can be considered as a machine for transforming the latent power stored in the fuel employed into work. Reckoned from such a standpoint it is very inefficient for the reason that only a small percentage of the heat which is retained

from the combustion of the fuel is converted into mechanical work. Thus, as an illustration, a pound of gasoline by its perfect combustion would give off heat sufficient to raise about 20,000 pounds of water one degree, or, in other words, would give off 20,000 thermal units; each thermal unit possesses the same amount of energy as would be developed in lifting a weight of 778 pounds one foot. From this it would appear that if a pound of gasoline were consumed in one hour of time and its heat were all converted into mechanical energy, it would develop by its combustion about 7 horsepower. Practically our best results require an amount of fuel from 10 to 15 times that theoretically possible.

The practical efficiency of a steam engine in converting heat into useful work is found between 3 per cent. for the ordinary and usual cases, and rising to about 10 per cent. in the best examples of modern practice in very large units and when multiple cylinder engines are used.

Despite the inefficiency of the steam engine as a means of converting the energy of fuel into work, it is never likely to be superseded for certain classes of work required of automobiles. It would not be at all surprising if it should again attain a great degree of popularity because of the advantages it possesses in the way of reliability, easy and ready starting, quick and accurate control, as well as in the absence of noise due to its operation.

ROTARY STEAM ENGINE.

There has been in connection with the development of the automobile a temptation to use a rotary steam engine, but such a type of motor has met with little or no success. The rotary engine would seem from the character of its motion to be particularly well adapted for automobile use, and such is doubtless the case if an engine of that type could be built which would be economical in its use of steam and durable in character.

The rotary engine, which we may define as one in which continuous rotary motion is produced by the pressure of steam, is apparently a simple mechanical construction admirably adapted for producing the rotary motion needed in automobiles. Inventions almost numberless have been made with the idea of perfecting this motor and of overcoming its defects, and while many of these inventions have seemed in the beginning promising and indicating economical results, yet a continued use has in every case demonstrated the failure of the attempt. The difficulties which must be overcome in the rotary engine are largely mechanical ones, and at the present time they are generally believed impossible of solution.

In the ordinary steam engine a piston is made to move backward and forward in the steam cylinder by pressure applied alternately on each side, and little or no difficulty has been experienced in providing means for preventing a leak of steam past

*From a paper read before the American Motor League in New York.

the piston without at the same time producing a pressure which would cause an inordinate amount of friction. With the rotary engine it has been different. In that construction the piston must swing on a pivot in a circular chamber and it has been found impossible to devise a piston or rotating body that would not permit steam to leak past it on the one hand, or did not take up a large portion of the power of the engine on the other hand. It has been found possible to design rotary engines that would use steam expansively and that appeared in the early trials to promise good results for the future, but a continued use of such engines has always proved disappointing and at the present time it seems a safe statement to make that *a rotary steam engine which will operate economically and successfully is practically an impossibility.* The man who wastes his energy in this unpromising field is certain to accomplish little or nothing.

The steam turbine is not classed as a rotary steam engine in this discussion, since it is not operated by the direct pressure of the steam, although in its use the steam produces a rotary motion. The efficiency of the steam turbine, which is practically equal to that of the piston steam engine, is dependent very largely upon its high peripheral velocity of rotation which must approximate to one-half of the steam itself. It is of course possible that the motion of a steam turbine could be utilized for generating electricity and that on the other hand might be used to operate an electric motor on an automobile in such a manner as to give us fairly efficient results. It is not easy to see how the extremely rapid motion so necessary for efficient results in the steam turbine could otherwise be usefully applied to a steam or electric carriage.

THE GAS ENGINE AUTOMOBILE.

The gas engine at the present time is the most extensively used motor for automobile service. This form of engine is one in which the energy of the fuel is directly converted into work by explosion or combustion in the cylinder of the engine, and its heat efficiency is much higher than that which can possibly be obtained in the steam engine.

I have found by actual test of the motor employed in two well known forms of automobiles that under good conditions the efficiency realized is as high as 21 per cent. and that it very seldom falls below 12 per cent. This would mean that the same amount of fuel required for a steam engine would perform, if the steam engine efficiency be considered as 3 per cent., from 5 to 7 times as much work when used in a gas engine.

The gas engine at present employed is almost universally that designed and patented by Otto in 1875 and generally known as the four stroke cycle engine or to use the short and common expression, as the "four-cycle engine." The fuel used in the

engine is a mechanical gas or vapor formed by the intimate union of particles of air with particles of a liquid hydrocarbon. The fuel used for the vehicle is almost universally in this country a petroleum oil known as gasoline which easily vaporizes in contact with air. In practice it is mixed with air or vaporized by an attachment to the engine termed a vaporizer or carbureter.

In Europe methol alcohol is being employed to a greater or less extent, either pure or mixed with gasoline. The fuel actually used is not essentially different from that used in the steam carriages, but it is true that the open flame under a steam boiler might be able to burn a hydrocarbon liquid of a character which could not be vaporized, and could not be used in a gas engine and which could be purchased at a much lower price.

It seems entirely unnecessary to discuss the theory of the gas engine or the character of its cycle of operation, as most of the owners of automobiles have during the last few years been thoroughly and carefully educated in these respects.

It is to be noted that the gas engine almost universally employed in automobiles is required to make four strokes for each impulse on the piston or for each explosion; the result is a tendency for an irregular motion which can only be overcome practically either by the use of a large number of cylinders or else by the use of an extremely rapid motion of the engine as compared with that of the driven axle. The inconvenience of the four strokes to one cycle of operation has caused many attempts to substitute a motor which should have not to exceed two strokes per cycle of motion. Some of the engines of this character have been made practically valveless and arranged so that the discharge of the burned gases was caused only by the entrance of the fresh charge. In such a case while the actual operations of the four cycle engine were made to follow each other in the same sequence, they were made to come in two strokes instead of four.

THE COMPOUND STEAM ENGINE.

The use of the compound steam engine has resulted in a considerable saving in fuel due to the fact that the principal waste in the steam engine is caused by the condensation of steam as it first enters the cylinder at the beginning of each stroke. This condensation is much reduced by working the steam in succession in two cylinders for the reason that by so doing the temperature range of each cylinder is lessened with the consequent saving of steam by reducing the amount of condensation. It has been argued that a compound gas engine might also result in increased economy over the simple gas engine for the same reason, but since there is no condensation in the cylinder of gas engines and little loss due to cooling on entering the cylinder, the analogy does not

hold, and while this attempt has been made several times, it has so far as I can learn never produced beneficial results unless some other object than economy were sought.

The gas engine as it existed even four years ago was a machine difficult to operate, unreliable in its operation and uncertain as to when it would stop or go. It was also of large size as compared with the steam engine in proportion to the power developed. Since that time improvements have been almost marvelous. The gas engine as at present used in the automobile is reliable in its operation, it can be regulated for wide ranges of speed, and nearly all of the bad attributes have been eliminated. Unlike the steam engine, it must be put in motion before an explosion can take place and before any power can be developed. Unlike the steam engine, it cannot develop much torque or rotative power at slow speeds. These difficulties have been overcome in its application to automobile purposes by the use of gears and clutches which permit the engine to move at a speed higher than that of the carriage or to operate when the carriage is at rest.

At the present time the gas engine motor is the most economical and most convenient means of propulsion known, and in view of the general developments in the art of power engineering it does not seem probable nor possible that it is likely to be superseded by any other motive power to any great extent. On the contrary it is possible that still further advances will be made in the art relating to its use and that it will continue to be more and more the dominant and principal motive power used for automobiles.

MAYOR ROSE ADVISES LICENSING.

Special Correspondence.

MILWAUKEE, July 16.—Although an ordinance recently introduced in the Common Council providing for the numbering and licensing of automobiles was practically shelved by being referred to a committee, the fight has been revived in the council by a communication from Mayor Rose urging the council to take action toward the adoption of such an ordinance, and a resolution is now in the hands of the judiciary committee recommending the passage of an ordinance.

Considerable feeling has been aroused by the resumption of the movement to pass this measure, and the Milwaukee Automobile Club, it is announced, will take legal action to oppose any such ordinance which may pass the council. It is claimed that such an ordinance, unless it applies equally to all vehicles, whether self-propelling, drawn by horses or otherwise supplied with power, would be discriminating and therefore illegal. A special committee has been appointed by the club, with full power to act, to look after the matter.

Driving Eastward on the National Road.—II.*

Highways and Accommodations Through Southern Indiana, Ohio and Pennsylvania—Practical Pointers for A. A. A. Tourists.

Special Correspondence.

PITTSBURG, July 17.—Five hundred and three miles, most of it over a hilly country, was our record last week, when we arrived at Terre Haute, Ind. Since then we have come this far over the southern route, as mapped for the endurance run, and will probably make Philadelphia by Tuesday, the run across Pennsylvania, according to reports, being very smooth going.

From Terre Haute to Indianapolis is given on the A. A. A. map as being seventy-seven miles. The roads are in excellent condition and such fast time can be made that there will be no need of stopping at Putnamsville for luncheon, as designated on the schedule. Should a stop be made there, the chances of getting anything to eat are slim, as the town consists of a water tank, four houses and three barns—no stores, hotels or eating houses. We had planned to eat dinner at Putnamsville but it was out of the question, though we made up for it by stopping at the Cloypool House, Indianapolis, where we were well taken care of. Four or five hours should be sufficient for even the smaller cars to cover this stretch.

The Indiana roads are the best of any we have traversed. We found them good on the northern route and we find them just as smooth and hard on the southern route. It does not appear to be due to any especial effort on the part of the inhabitants but more to the general nature of the soil and level topography of the state. From Indianapolis to Richmond is seventy miles; with excellent accommodations for luncheon at Knightstown.

Ohio still adheres to toll roads, and every few miles we were held up and asked to produce our coin. Twenty-five cents was the usual tax and some days our toll bill would be two or three dollars. If the roads were really good, no man would object to paying the tolls cheerfully, but when you are asked to pay every few miles for the privilege of exercising your skill as a road driver, there is some excuse for kicking—we kicked.

"I don't see why you ask automobilists to pay toll," said one of our party, "for they are generally considered a benefit to the road."

"Well, we didn't use to charge 'mobiles but they scare the horses and the other people git mad, so we charge you fellows twenty-five cents now," replied the woman in charge of one of the Ohio gates.

"I suppose that gives us a license to frighten all the horses we encounter, now we have paid for the privilege, doesn't it?"

"Well, now you have paid your quarter I guess you can do pretty much as you please about scaring the horses, but they

are not as much afraid now as they were last year, for there has been lots of you fellows pass through this gate this summer, all going to the Fair, I suppose."

From the time we crossed the Indiana-Ohio state line we encountered "chuck holes," as they are termed by the inhabitants. These are little ditches running entirely across the road, built for draining, probably, but they are likely to result in broken springs unless one drives watchfully. Almost every car that passes over this route snaps one or more springs before realizing what kind of road construction he is up against. Thanks to our early experience, all four of our springs were strapped down until they only had about three inches play and no damage was done, although we struck hole after hole with great force.

After leaving Richmond, Ind., we found a much better route by bearing to the south and running through Dayton to Columbus, then following the regular route through Zanesville to Wheeling. At Zanesville we began to encounter hills—hills apparently with neither top nor bottom, which continued on through the Cumberland mountains to Pittsburg. Our car, an excellent hill climber, took most of these at high speed, the spark retarded, of course, but we had to make use of the low speed frequently, as some mountain, whose top was in the clouds, loomed before us.

While descending one of these mountain roads we saw before us what we took for a large city in the valley below. With visions of a good night's lodging we hurried on only to find what we had taken for a city of at least 10,000 inhabitants was a

swarm of fire flies, whose radiance actually lighted up the valley until at a distance it would readily be taken for the numerous lights that mark a town. In telling at one of the Wheeling garages of our experience with the fire flies the proprietor said: "Yes, that valley is filled with fire flies. Some nights they shed so much light that I do not have to use my lamps at all, the road being visible for many feet ahead of my auto."

At Amsterdam, Ohio, one of the places designated as a noonday stop on the A. A. A. schedule, there is no hotel at which automobilists would care to stop, but the eighty miles between Zanesville and Columbus can easily be covered in half a day and, providing the start is made early enough in the morning, Columbus will be reached in ample time for luncheon. Cambridge, the noon stop between Zanesville and Wheeling, is a pretty little town at which excellent hotel accommodations can be obtained.

From Wheeling to Pittsburg is eighty-two miles, and the hardest climb on the trip. It is up or down steep mountains all the time, with many sharp curves that will keep the operator wide awake for the entire distance. Washington is the noonday stopping place, and while the hotel fare is good, tourists will do well to keep an eye on their belongings. We stopped there for the night and although we paid the liveryman \$1 for looking after the safety of our automobile and its contents, some one went through our hampers and stole such articles as they took a fancy to, including our loaded but unused revolver. We kicked—we are always doing that—but it did no good, the proprietor saying he was not responsible, and that he had only agreed to furnish a roof over our machine—as if rain could damage the *Pathfinder* at this stage of the game.

Just as we left Wheeling we were held-



SAFELY ACROSS THE LITTLE WABASH FORD.—See account in last week's issue.

* Continued from Page 65, issue of July 16, 1904.

up by a girl—and such a pretty girl. It was not necessary to send a solid shot across the bows of our craft, for the man at the wheel unconsciously slowed down when he first saw her. Before we had fairly stopped she came forward, and placing a hand on the steering wheel said: "I hope you gentlemen will pardon me, but I have just got a telegram from my sister saying that she is coming to Wheeling to see us and she is driving an iron grey horse and I think it is afraid of automobiles. Now, won't you please go back and wait until she comes and then you can go on again." We wanted to oblige, but with Pittsburg as an objective point, a delay of two or three hours would be a serious setback, and promising to use the utmost caution when we saw the iron grey, we once more headed eastward.

A stretch of eight miles of good macadam road brought us into Pittsburg in good spirits, although for several miles before we had reached the macadam we encoun-

that breaks the springs and not the going down.

Look well to your tires and pull out all tacks, nails and other things that have stuck in the outer shoes at every stopping plate (we are yet on our first set of tires and haven't had a puncture).

Keep oil in your lamps and plenty of carbide on hand at all times, for you never know how soon you will have to use them.

Watch your oilers as a cat watches a mouse, for the oil you purchase along the road varies and necessitates careful watching and adjustment.

Carry an extra chain and extra links and blocks.

Have your tool-box equipment complete.

Keep your tonneau door shut and locked at all times.

Carry 100 feet of rope and two good single blocks.

Carry chain or rope to be wound around your tires on slippery roads.

When inquiring the road to a town, ask

THOUSAND-MILE NON-STOP.

Charles Wridgway, New York, made a second attempt to run a 24-horsepower Peerless touring car 1,000 miles without stopping the motor and again was forced to capitulate this time, because his carbureter became clogged with a bit of waste.

The start from New York was made early Tuesday morning, July 12, and the New York-Boston route followed. On returning to New York on the first round trip it was necessary to replace the radiator, which was badly damaged, with a new one taken from a stock car. This was done successfully, the motor running all the time, and the car was again started for Boston only forty-five minutes behind schedule time. After running 650 miles the carbureter began to work badly and finally failed entirely, stopping the motor. The clogging was attributed to the fact that gasoline had to be poured into the tank without straining the straining funnel having been lost. After removing the obstruction Mr. Wridgway continued the run, finishing 1,040 miles in a total elapsed time of 66 hours 45 minutes. He was at the wheel nearly the whole of that time himself, and was pretty thoroughly exhausted at the finish.

AUTO BOAT BUILDERS ORGANIZED.

THE recently organized National Association of Engine and Boat Manufacturers held a meeting at the Hotel Manhattan, New York City, on July 15, when a number of matters were discussed, including the National show. A committee of two was appointed to consider this matter and report at the next meeting of the association. A resolution was adopted thanking E. W. Graef for his efforts in the formation of the Association. The following members of the executive committee were present: John J. Amory; H. A. Lozler, Jr.; J. N. Schoonmaker; H. R. Sutphen; J. S. Bunting; C. L. Altemus; E. A. Riotte; A. Massenet; A. Snyder; A. E. Eldridge; H. Newton Whittelsey; by proxy, J. S. Matthews; J. B. Smalley; C. L. Snyder; H. T. Brautigan.

The officers elected for the ensuing year are as follows: President, John J. Amory; Vice-President, H. A. Lozler, Jr.; Second Vice-President, J. N. Schoonmaker; Third Vice-President, Henry R. Sutphen; Treasurer, J. S. Bunting; Secretary, Hugh S. Gambel.

It was agreed that members of the association should use in their advertisements the words: "Member of the National Association of Engine and Boat Manufacturers," and that the same should be placed on all stationery.

The association now has 50 members, active and associate, who are taking a keen interest in its welfare.

It is a notable fact that usually persons who are prejudiced against motorcycles and automobiles are those who have learned what they know on the subject from watching the machines go by.



GOOD GOING ON A SECTION OF THE NATIONAL TURNPIKE IN SOUTHERN INDIANA.

tered a stone hill that bore a striking resemblance to the Giant's Causeway as pictured in old geographies. It was bounce, bounce, bounce, as our little 28-inch wheels came down the steps, for the highway resembled a flight of stairs more than it did a road.

As our next article will not appear in print until after the St. Louis tour has started from the eastern cities, a few suggestions might be appreciated by those taking in the first two days of the big run. The writer was as green a novice as ever sat behind a steering wheel when he left New York City on May 18, with a sign on either side of the car reading: "New York to St. Louis," but nine weeks in an automobile, traveling over country roads and city streets, will give even a novice a few ideas, and here are some points that we have learned:

Keep an auxiliary gasoline tank somewhere about your machine, containing at least two gallons of gasoline.

Strap your springs down until they only have about three or four inches play, and remember it is the jumping up of the body

an automobilist, a bicyclist or a liveryman—not a farmer or hotel keeper.

Beware of speed ordinances in country towns and the ever watchful constable who gets a fee for every arrest.

Do not give up if you strike mud, no matter how deep. It is the courage and persistency of the tourist that takes a machine through and not the rated horsepower and cost of the car.

Lastly, if you want a two weeks' outing, an outing that will cause you to forget that you have a business and will bring the tan and freckles back to your face and hands as did a summer in the hayfield when you were a boy, take in this proposed St. Louis tour; start with the "bunch" and keep with it across New York, Pennsylvania, Ohio, Indiana, and Illinois to the Mississippi River and cross it into the world's fair city. The "Pathfinder" has made the trip once and will start on Tuesday morning with the New Yorkers, going across the 42nd street ferry, through New Jersey, up the Hudson to Kingston and across the Catskill mountains, with St. Louis once more its objective point.

St. Louis Auto Club's Sylvan Retreat.

Special Correspondence.

ST. LOUIS, July 16.—The country club house recently occupied by the Automobile Club of St. Louis stands on Clayton Road opposite the St. Louis Country Club. The quaint red brick manor house is a type of the ante-bellum style of architecture. The estate was the property of the Crows, an aristocratic old family, and the old-time house with its twenty large rooms is extremely picturesque. It has a high brick cupola and broad wooden verandas. The house has been entirely refinished and refurnished to meet the requirements of the club during the summer. The dwelling stands back from Clayton Road about a quarter mile. The approach is through a magnificent grove of hardwood trees. Great orchards extend to the left of the lawn and in the rear are well stocked fish ponds. Beyond the barn, which is used as a garage, is a big vegetable garden where a hundred delicacies are being grown for the August visitors.

After the white heat and noise of the Universal Exposition it is like Arcadia to get out to the deep quiet of this retreat. The only sounds on a quiet day are the twitter of occasional birds, or the droning of bees. Perhaps in the distance is heard the faraway throb of a motor, then the car draws nearer and pulses up the driveway where the chauffeur announces that a number of members of the club will be out to dinner. Tables may be placed on the lawn, and famous dinners are served in the open air. Many of the members of the St. Louis Automobile Club are also members of the St. Louis Country Club, but they took this house in order to entertain visiting motorists during the weeks of August. So unique and delightful is the place that it will be purchased and retained permanently by the club.

About seventy members are enrolled on the list of the St. Louis Automobile Club. Their object at present is to make the stay of visiting motorists as pleasant and comfortable as possible. They are trying to abolish the speed limit of six miles an hour within the city limits. Every member of the club is willing to stand by anything reasonable, but they affirm that even funerals in St. Louis are permitted to go faster than that. They hold also that the county licenses are not legal. Now, if a St. Louisian goes outside his own county in an afternoon's run he is obliged to pay a county fee of \$2. Suppose he passes through three or four counties in the course of his half day's run, his bill is enormous. In the city proper he pays a license fee of \$10. The club has at least succeeded in extending the freedom of the city to visiting automobilists without a license fee. A visitor's license is asked, which costs \$5, but when the guest is ready to leave he is refunded \$4.50, the fifty cents retained just

covering the cost of registering his car and placarding it.

Miss Alice Roosevelt is much interested in motor driving, and while she was in St. Louis recently she was driven out to the new quarters of the St. Louis Automobile Club. She used an automobile several times during her stay, and expressed surprise at the number of cars in the World's Fair city.

New club officers were elected at a recent meeting at the new headquarters. F. W. Scofield was obliged to resign the presidency owing to continued business interests away from St. Louis, and Albert B. Lambert was chosen president, with Bertram B. Culver, secretary and treasurer. With these two enthusiastic leaders at the head, the club will continue its successful season of phenomenal growth. The board of direc-

The party will be held on the lawn under the oaks in front of the clubhouse. The date is not definitely decided upon, but it will probably be August 18.

President A. B. Lambert, of the club, is doing active campaign work against the speed limit. He has invited several of the mounted park police to take a ride in his car and judge for themselves the speed of an automobile and a horse. In one instance when a carriage passed he asked the guard at what pace the horses were going. "Eight miles an hour," said the policeman. By the speed meter attached to the motor car it was found that the team was going more than twelve miles an hour. It is conclusive that nearly every turnout in Forest Park breaks the law, which shows that the law is scarcely a just one, as very few accidents have happened there. Mr. Lambert offers to make tests in Forest Park to demonstrate the different speeds of both automobile and carriage. If the city officials and

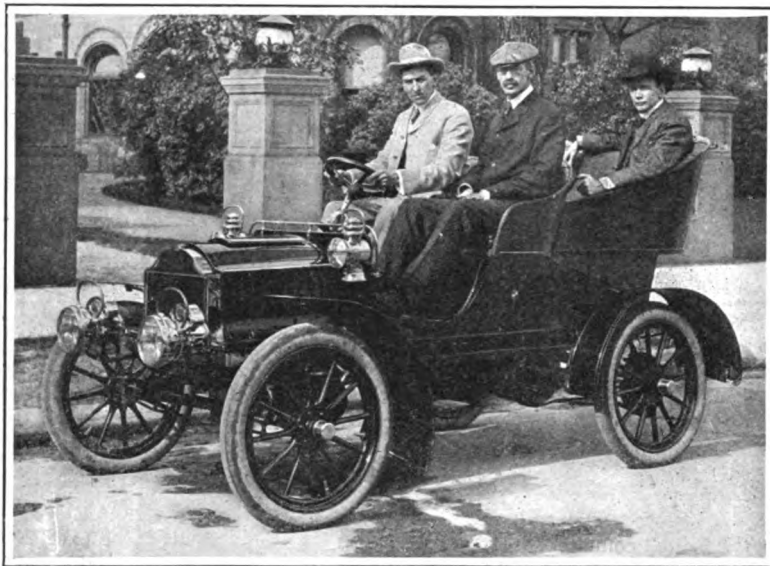

GEORGE ADE, AUTHOR AND LIBRETTIST, AT THE WHEEL OF HIS NEW OLDS.

tors includes some of the most enthusiastic young business men of St. Louis. Among them are Dr. E. N. Senseney, J. A. Prescott, E. R. Cuendet, A. N. Niedringhaus, G. H. Walker, E. H. Stedman and C. M. Dolph.

At a recent meeting the club admitted fifteen new members. The club is extremely exclusive, and the officers of the organization are working hard to make it one of the best socially in the city. Much is being done to make for better automobile legislation. The clubhouse is being furnished with a ladies' tea room and a growlery. The plan is to make the clubhouse as complete as possible for visiting guests, who are already beginning to arrive, and particularly for the motorists who are coming in August.

The St. Louis end of the A. A. A. tour is in the hands of the St. Louis Automobile Club, and its committees are making ample preparations to take care of their guests. A lawn party is being arranged, which will be the largest social event of the summer.

members of the police force will attend the trials will be made before the motorists come from the East.

George Ade in His New Car.

George Ade, author and librettist, is a firm believer in automobiling, and has supported his opinion by the purchase of an Oldsmobile light tonneau, which was delivered to him a short time ago. His first machine was an Oldsmobile runabout, and his recent purchase shows his faith in the product of the Olds Motor Works.

AUTOMOBILISTS of Battle Creek, Mich., have formed an association for the purpose of fighting the new ordinance requiring the tagging of automobiles and fixing the speed limit at six miles an hour. The association agrees to pay the legal expenses of any member arrested for violating the ordinance.

Auto Parade Prize Winners

Never have automobile parades been so popular and so successful as this season. These manifestations of automobile enthusiasm have been one of the most remarkable features of the outdoor season of the present year. Some degree of success has attended such affairs in past years in the smaller cities, but it was almost impossible to arouse interest in them in the larger cities. This spring, however, automobile parades with from 200 to 400 vehicles in line have been held in New York, Chicago, Boston, Cleveland and Cincinnati, while dozens of lesser cities from Lewiston, Maine, to Los Angeles, Cal., and from Minneapolis to Austin, Tex., have had proportionally large and successful turnouts.

The increased interest in them may be accounted for by a number of reasons, such as the larger number of automobiles in use, the desire to offer an ocular remonstrance against unjust and unreasonable legislation, and the improvement in reliability and appearance of motor cars themselves.

This year's parades, which reached a numerical climax July 4, have been notable as well for the beauty and uniqueness of some of the decorations of participating cars as for the number of vehicles taking part and the keen interest shown by the general public. Among the most original decorations were those in the Fourth of July parade at Springfield, Mass., in which seventy cars took part. Several of these were in the form of floats, as shown in the large engraving. Especially novel was the hay wagon float, seen in the middle, with a mowing machine drawn behind. This was a two-cylinder Knox touring car, fitted with a hayrack by the men from the body department of the Knox factory and loaded with hay and "Rubes." It was awarded third prize by the committee on decorations. First prize went to Forbes & Wallace, dry goods storekeepers, whose window dresser

trimmed one of the firm's large Knox delivery wagons elaborately and artistically in blue and white and mounted a big golden eagle at the front with a bunch of firecrackers in its beak.

Another novel and pleasing effect was presented by the float entered by the Knox Automobile Company, which is shown at the right in the large engraving. This carried a large boat, in which were seated a number of children. It was in charge of Mr. and Mrs. C. R. Culver, but was not entered in the competition for prizes. Much attention was attracted also by a car handsomely decorated and carrying three large butterflies suspended in front as if drawing the machine.

First prize for the best decorated car in the Fourth of July parade in Erie, Pa., was awarded to Irving M. Izer, who entered the car shown in one of the small engravings completely covered with flowers and occupied by pretty women.

The most elaborate creation in the way of an automobile float was seen in a parade



REPRODUCTION OF SCENE FROM FAUST.

Altree, owner of the car. The world is represented by the automobile and Marguerite, Faust, and the chauffeur, heaven by the two angels at the top standing over the tonneau, and hades by Mephistopheles and the imp stirring the pot of fire at the front near the ground.



FIRST PRIZE WINNER IN ERIE.

held in June in Tampa, Fla., where it won first prize, not for the beauty of its decoration but because of the excellent reproduction of a scene from the familiar opera "Faust." The scene was designed by Dr.

YOUTHFUL DIVERSION IN MISSOURI.

Special Correspondence.

KANSAS CITY, July 9.—The gentle pastime of throwing stones at motorists has reached Kansas City, and attacks of this kind have now arrived at the stage where the police begin to take notice. Boys are the principal offenders, although older rowdies are responsible for some of the complaints. E. S. Moser was struck on the point of the jaw some days ago with a jagged stone and suffered considerably from the wound.

Others have been attacked with mud, beer bottles and other missiles. E. P. Moriarty has offered the use of a machine to the police if they wish to make experiments for themselves.

AUTOMOBILES are now prohibited from running on the roads of the mountain top at Montreal, Canada.

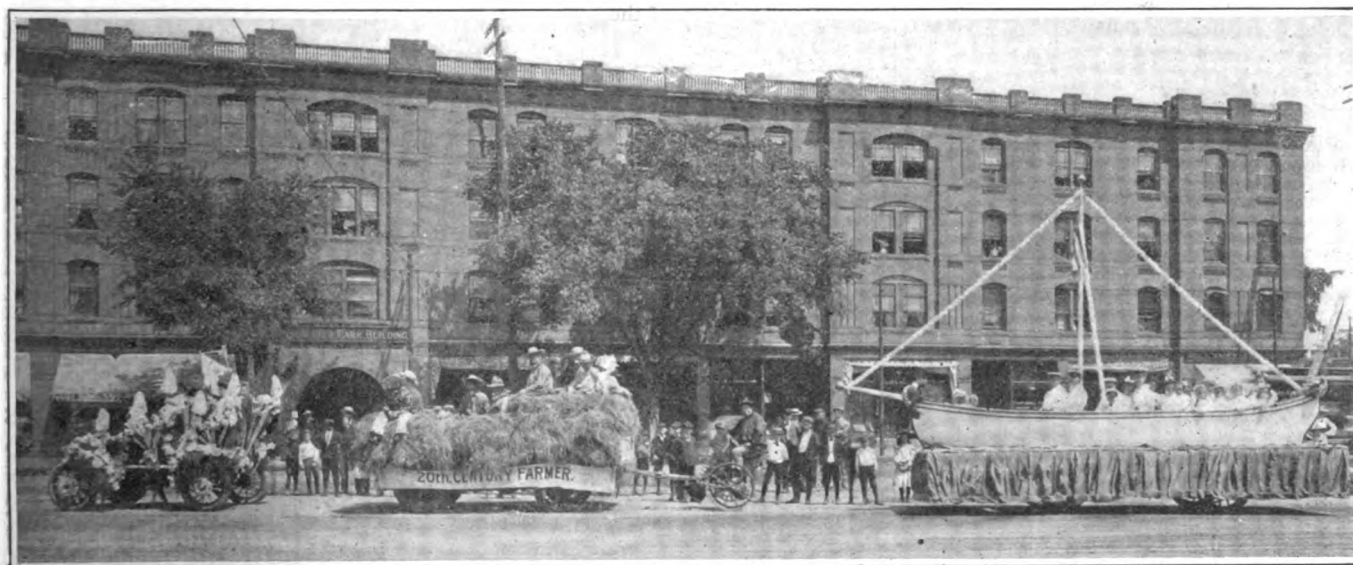

NOVEL CONCEPTIONS IN AUTOMOBILE DECORATION SEEN IN FOURTH OF JULY PARADE IN SPRINGFIELD, MASS.

Reliance Touring Car.

The first side entrance tonneau car to be offered by an American concern as its regular model is the Reliance touring car illustrated herewith. A first lot of fifty of these is being completed now by the Reliance Automobile Manufacturing Company, 67 to 103 Fort Street East, Detroit.

The long wheelbase that makes it possible to provide a side door on both sides to give comfortable access to the tonneau portion of the body directly from the sidewalk also provides ample room between the dash and the front seat and the front and rear seats, so that there will be no uncomfortable cramping of legs and so that

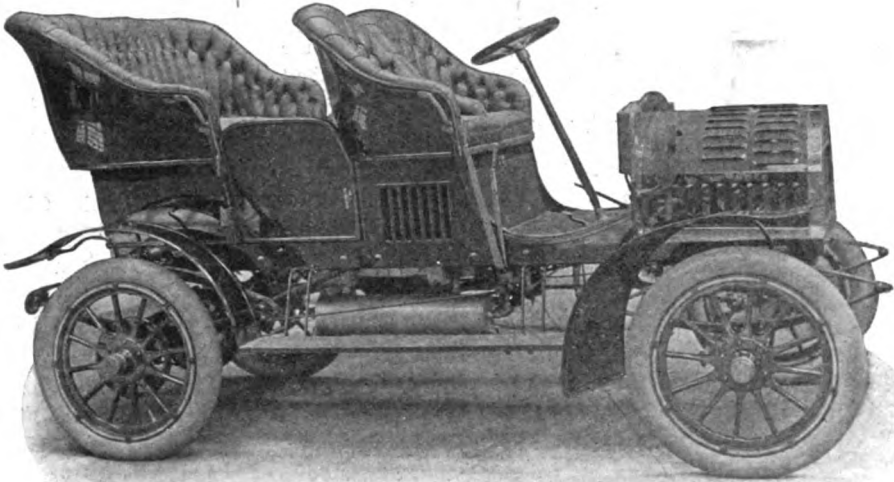

RELiance TOURING CAR. WITH DOUBLE OPPOSED MOTOR, SHOWING SIDE ENTRANCE.

a considerable amount of luggage can be disposed in the bottom of the tonneau. These comfort features of the car are further increased by the easy riding qualities afforded by the long wheelbase, by the fact that there is very little overhang to the rear seat and by the construction of the seats themselves, which have high backs and are luxuriously upholstered. The side entrance permits of making the rear seat with an unbroken back. This seat will comfortably hold three adults. With the operating levers in the position shown in the engraving, it will be seen that entrance to the driver's seat from the right hand side is not difficult. The tonneau portion of the body is detachable and a sloping cover may be substituted to convert the car into a machine for cross country traveling with two persons aboard.

The car is driven by a double opposed alternating four-cycle motor placed horizontally under the middle of the body, as shown in the engraving of the chassis. This engine is semi-air cooled, the heads of the cylinders, including valves, being water cooled, while flanges radiate the lesser heat from the lower or inner ends of the cylinders. The cylinders are of 4 3/4 inches bore and 5 1/2 inches stroke. All valves are mechanically operated, and by the use of an

ingenious fastener on the valve stems the use of nuts and cotter pins is avoided. Both valves on either cylinder can be removed quickly by the loosening of one nut. The valves are set in valve chambers on the lower sides of the cylinder heads. The lubricator is placed directly over the crank case.

Power is transmitted from the flywheel in the center of the chassis by means of a friction ring to sliding change speed gears mounted on the same subframe with the engine. This subframe has three-point suspension from the main frame, insuring alignment of the crankshaft and gearing. There are two forward speeds and reverse. The clutch and brake are controlled by one pedal, while an interlocking device

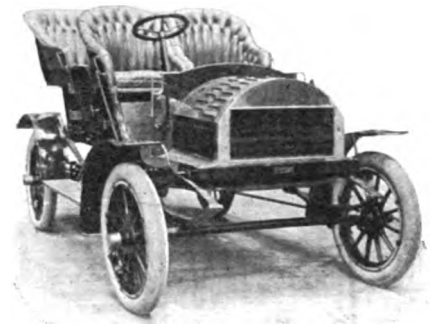

FRONT VIEW OF RELIANCE CAR.

Speed of the engine is controlled by a centrifugal governor which automatically retards the spark when the engine stops so that there can be no back kick when cranking to start.

A positive rotary pump having two deliveries circulates the water around the cylinder heads and through the large fin radiator mounted in the front of the hood. Full elliptic dragon head springs on the rear axle give great flexibility in the body suspension. Hyatt roller bearings, five inches long and having improved ball end thrust, are used on the live rear axle.

The motor and gears are readily accessible through the floor of the tonneau, the broad side doors contributing greatly to this convenience in this type of car.

Primary current for the jump spark ignition is taken from a double set of dry cells, either of which can be switched into use while the other recuperates. Each car is provided with two vibrating dash coils, either of which operates both cylinders so that there is always one coil in reserve.

Although the manufacturers got a late start for the present season, the Reliance company expects to complete at least 100 of these cars this year.

CERTAINLY there can be no reasonable objection to the regulation of the use of automobiles to the extent of requiring that every person entrusted with the operation of a horseless vehicle shall be a competent driver. That much is demanded in the interest of the public.—*Montpelier (O.) Enterprise.*

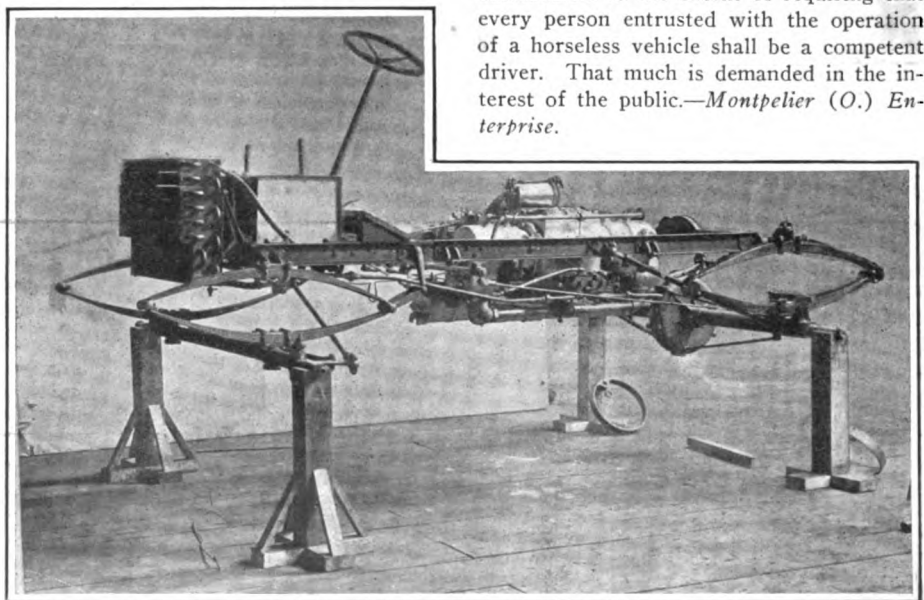

CHASSIS OF RELIANCE TOURING CAR MOUNTED ON STANDARDS FOR PAINTING.

Grade Crossing Protection.

Growing use of the automobile is already beginning to be a feature in the long fight waged by American cities against grade crossings at railroad intersections with wagon roads. As a result of its investigation into the fatal accident at Van Cortlandt Park, New York, June 12, when a New York Central train ran into an automobile owned and driven by George J. Noakes, the New York State Board of Railroad Commissioners recommended, in its report issued recently at Albany, that the crossing at Van Cortlandt Park be at once equipped with gates on both sides of the tracks and that a watchman be placed on duty to operate the gates at all hours. This is recom-

reported to the board of directors that the deaths of Mr. and Mrs. George E. Dixon, of La Grange, was undoubtedly due to the high rate of speed at which the electric car of the Aurora, Elgin & Chicago Railway Company was running when it struck the automobile. The club's counsel has written to both the electric railroad company and to the Chicago & Great Western Railroad Company, asking that suitable provision be made for the protection of the public at the crossing.

John Farson's "Pike Yachts."

Special Correspondence.

CHICAGO, July 16.—President John Farson of the Chicago Automobile Club, lately received his new 60-horsepower Apperson

himself, Mr. Farson has two sons, John, Jr., and William, both of whom are expert drivers of automobiles. The Farson cars, driven by the three male members of the family and one of the chauffeurs, may now be seen almost any pleasant day starting from the Oak Park home with the big Apperson in the lead. Mrs. Farson returned from Europe recently, arriving in time to take the first ride with her husband in the big car.

"THIS automobile ordinance is a dashed nuisance!" City Clerk Elbourn declared this morning, as he slammed his telephone receiver back upon the hook, after answering an inquiry from some one who wanted to know the name of the owner of machine

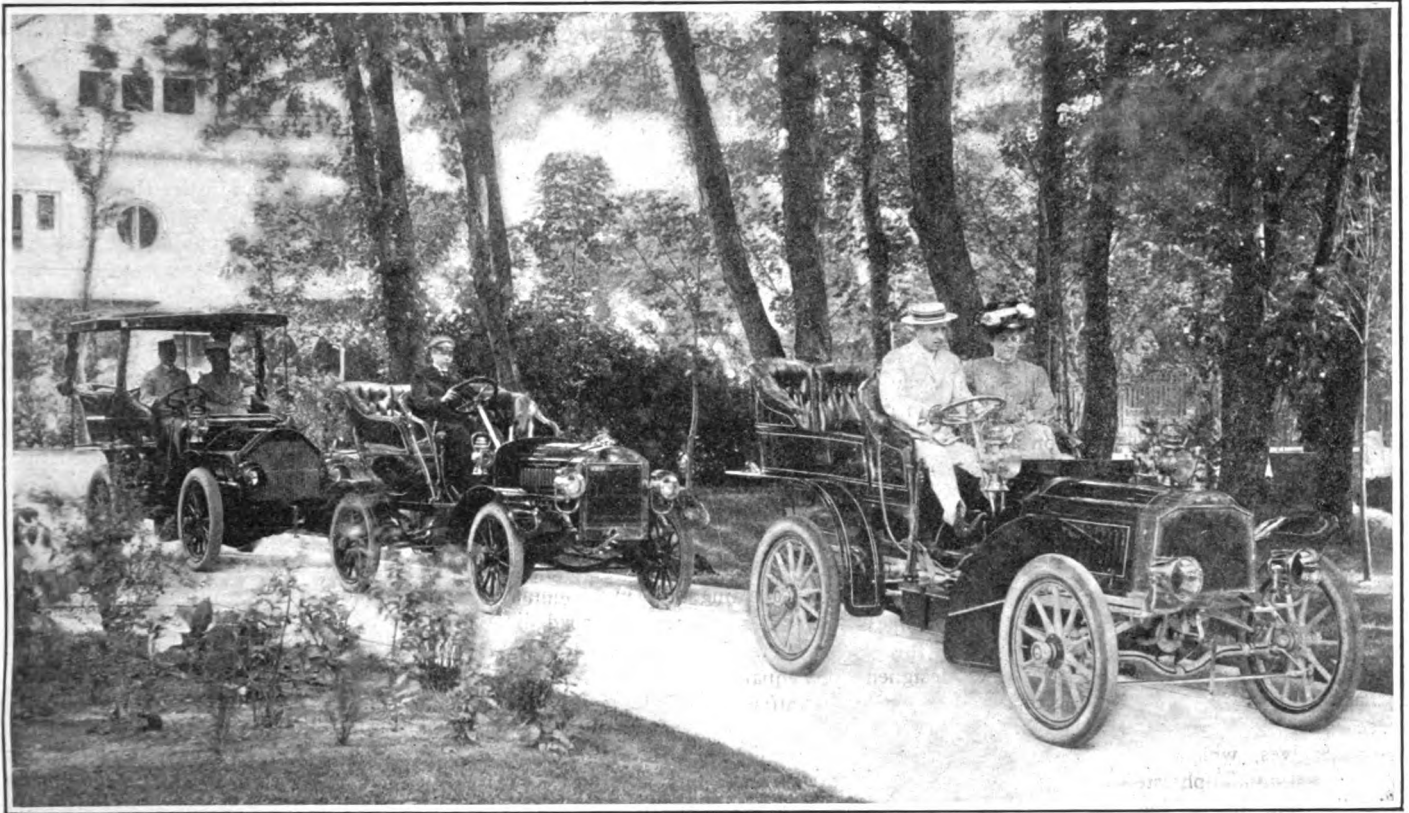

JOHN FARSON'S NEW APPERSON, NATIONAL AND PACKARD CARS AT PLEASANT HOME, HIS OAK PARK, CHICAGO, RESIDENCE.
Mr. Farson at wheel of canopy covered Apperson Car and his two Sons operating the others.

mended as a temporary precaution only, as it is the opinion that the grade crossing should be done away with as quickly as possible by an agreement between the city authorities and the railroad company. These recommendations are made notwithstanding the commissioners held that the accident was due to the carelessness of the operator of the car, who failed to note the approach of a train from the south, although he had an unobstructed view of the tracks for more than a quarter of a mile.

Another fatal automobile accident that has brought up the question of adequate protection at railroad crossings was that of the Dixon party, at Austin, Ill., three weeks ago. The attorney for the Chicago Automobile Club, who has made an investigation into the direct cause of the accident,

car, built after special designs by Mr. Farson. It has several features not found in the regular model. The Farson car is the highest powered American touring car made up to this time. It has developed a very high rate of speed in a tryout at the factory, and the manufacturers regard it as the crowning piece of work turned out from the Kohano plant.

Mr. Farson recently purchased a Thomas, a Packard and a National, which gives him a fleet of four "pike yachts," as he is pleased to call them. The owner takes especial pleasure in entertaining the ministers of Oak Park and the neighboring suburbs, and he has about decided to call the new sixty "The Ministers' Delight" and devote it principally to their use.

Besides being an enthusiastic motorist

number steen. "It keeps one clerk busy all day long replying to fool questions. Some nervous fellow sees a machine moving out of a walk, takes the number, and wants this office to investigate and find out how fast it was running; or some owner of an old-style machine wants to find out who owns one of the new beauties; or else some curious woman wants to know who it was that had Mrs. Blank out riding with him last night. There's no end to it. I'm going to ask the council to increase the permit fee, so that we can afford to put on a new clerk and an extra 'phone for auto work."—*Omaha News.*

A STEAM motor coach, carrying thirty-six passengers, has been placed in service on the Northwestern Railway, in India.

Correspondence

Electric Ignition Troubles.

Editor THE AUTOMOBILE:

Sir—I am having all sorts of trouble with ignition. Am driving a touring car with a four-cylinder vertical high-speed motor, with direct transmission, and the car is giving every satisfaction, with the exception of the ignition. The car is equipped with small dynamo, and a two-cell storage battery. The cells are supposed to be used one at a time—the extra one being held for reserve. When the car is in operation, and the motor at moderate speed, the ammeter shows that the dynamo is doing its work. The dynamo is connected to the positive cell of the battery, and is also directly connected to the wire leading to the spark coil. The negative side of the battery is connected to the frame of the car. When the motor is doing its work of course the ignition is perfect, but as soon as the battery runs down a little, and the motor runs at too slow a speed to make the dynamo do its work, the trouble begins. The cylinders miss fire and the battery runs down very rapidly, so that within a very few minutes after the motor begins to miss fire it is impossible to run the car. I have succeeded in cranking the motor and speeding it up so that the dynamo takes up the work, and the sparking is all right as long as the motor is run at full speed, but as soon as the clutch is let in to start the car, the speed of the motor being thus retarded, the dynamo fails to furnish sufficient current, and it is impossible to get the car under motion. The only remedy I have found is to take the batteries out, and have them charged in some charging plant, but even then they are a very uncertain quantity, and sometimes, after running the battery for only a few hours, it weakens, and the other one has to be connected. On one or two occasions I have been forced to procure dry cells to run the car in.

I am now trying the experiment of charging the extra cell entirely separate from the cell that is furnishing the spark coil, hoping that the dynamo may charge the weak battery while the live one is being run down. I have also changed the pulley on the dynamo, putting on a much smaller one, which has increased the capacity of the dynamo, so that the reading of the ammeter at a given speed is much higher than it was previously. The same disastrous result has occurred with the batteries, and I am very anxious to know, first, if the dynamo and the storage battery is the best way to furnish the current for ignition, and second, what modifications of practice with the present equipment will insure the result intended by the manufacturers. Of course, I appreciate that as the motor runs at high speed it requires a much greater quantity of electricity than a slow speed motor, or a motor with a lesser number of cylinders.

I have about come to the conclusion that the dry cell is the one expedient, and should be very much pleased to have some of your many readers straighten out this dynamo and storage ignition problem for me. H.
New York.

Road Around Montezuma Marsh.

Editor THE AUTOMOBILE:

Sir:—After having made several automobile runs between Syracuse and Rochester, with a view to locating the best route by which the tourists in the A. A. A. run to St. Louis may avoid the notorious Montezuma Marsh and its muddy road, I have located a very good route as follows:

From Syracuse to Camillus, through Elbridge, Weedsport, Spring Lake, South Butler, Clyde, Lyons, Newark, Palmyra and Fairport to Rochester.

The people along this route have done a great deal of work upon the roads, which are of a soil that makes a very nice, hard road. There are some hills, but not anything to interfere with automobiles. As a whole, it is a very good road. The trouble with automobilists has been that when they arrive at Port Byron, in going from the east to the west, they go across to the marsh. This marsh extends north of Cayuga Lake to about Conquest, but by going from Port Byron to Spring Lake, you go north of Conquest and do not come in contact with the marsh at all. The automobilists who state that the marsh begins at the north end of Cayuga Lake and extends practically all the way to Lake Ontario are wrong, for the country through Spring Lake is very high and a very beautiful country. This makes the trip to Rochester, according to my odometer, ninety-three miles, whereas the road direct through the marsh is something like eighty-one or eighty-two. H. W. SMITH.

Syracuse, N. Y.

Need of a Strong Organization.

Editor THE AUTOMOBILE:

Sir:—A constable in the town of Russell, about fifteen miles west of Springfield, Mass., got busy one Sunday recently and made a haul of about twenty automobilists, using an old stop-watch, "sighting" the victims as nearly as he could guess when they reached a certain point in the road and again when they had passed a point in the other direction, and also taking their numbers. Then the owners of such numbered vehicles were commanded to appear before the court in Westfield. The father of the constable is a Springfield lawyer, and appeared as counsel for the prosecution, which was suggestive to say the least; but any possible rake-off in the matter of "costs" resembled "counting the chickens before they were hatched," for at the trial, the judge, who evidently comprehended the wholesale "hold up," and believes in a sensible enforcement of the law, decided that

the owner of the car and number must be identified as the person driving it at the time, which the constable could not do except in two cases, and in those cases the judge dismissed the complaints on the ground of the doubtful method of timing, so that all were dismissed together.

Judge Kellogg is certainly deserving of high praise for showing that he is unaffected by the common clamor against automobiles and is uninfluenced by the chance to gather in large fees and fines from men who are supposed to be rich because they own automobiles and can afford to be robbed under the pretense of administering justice. It has since been reported that the constable had another list of twenty motorists to be haled into court as soon as the first batch had been disposed of, but the cases have been dropped.

Such attempts at this sort of legal highway robbery are not popular in Massachusetts, and this matter has reflected unfavorably upon the town where it occurred. Unreasonable racing and speeding, endangering the public safety, should be punished according to law, but justice should be tempered with reason and common sense in enforcing a law notorious for the invitation it offers to constables to trap profitable "game" under it.

There is a general feeling of regret, particularly among unattached motorists, on account of the failure of the committee to agree upon terms for merging the two rival associations of automobilists into one. Now that the clan are being preyed upon and persecuted by ignorant persons and crafty officials there is need of a single, strong and powerful association, to work for good roads, for reasonable laws, and all the advantages coming from organization. But two associations will weaken the efficiency of both, and to continue them after the members have voted to "get together," is sheer foolishness, and the parties blocking the way ought to bear the odium of it. Why not adopt a plan for both club and individual representation, according to the status of the motorist? Owing to the rapid increase of motoring, it is probable that a very large proportion of the persons using automobiles will not be members of any club, and their membership in the national association is most important.

The increasing numbers of automobiles in and around the cities and the almost absolute immunity from accident, indicate that the public is becoming used to the improved machines, and that with acquired skill, motorists are using them with care and safety to all concerned. Nervous persons express fright after some mad racer has gone through, in search of some kind of a "record."

The question has been discussed here of late, as to how many miles a set of double tube tires should run on a runabout, before playing out. Let those who have had experiences relate them. R. H. M.

Springfield, Mass.

Patents

Automobile Cap.

No. 763,602.—R. Fox, of New Rochelle, N. Y.

A convertible cap arranged to be equally serviceable in fair weather or foul. The flap 4 is arranged to turn down, as seen in the two lower figures, and its ends 6 7 button together at the back of the neck, the cap being reversed for this purpose when worn in stormy weather. Flap 4 is attached to the bottom edge of the cap at the sides, but not at the back, which is loose and drops down below the eyes. Between the back of the cap and flap 4 is the mask 9, which turns up and is covered by 4 when not in use, but may be dropped down as shown, covering the space between the bottom edge of the cap and the edge of 4 where the latter is not attached to the

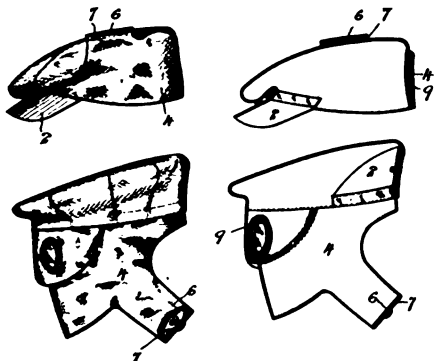

FOX CONVERTIBLE CAP AND MASK.

cap. Suitable eyeglasses are inserted in 9, and the visor 2 of the cap may be folded up inside it when the conversion is made.

Storage Battery Plate.

No. 764,282.—W. O. Duntley, of Chicago, Illinois.

A battery cell having a removable plug in its base, made tight by a soft rubber gasket, squeezed between the edges of two disks, which form the body of the plug. This invention was described in this publication on page 37, issue of July 16.

Pneumatic Tire Rim.

No. 764,400.—Thomas Midgley, of Columbus, Ohio.

The rim used in connection with the Dunlop detachable tire. Its feature is a pair of flattened tubular rings set into grooves, one at each side of the rim. These rings are split at one point, and the ends are drawn together by bolts, or the like, to render them immovable on the rim. The tire is held in place by simple air pressure.

Spring Tires.

No. 763,536.—J. Alloatti, of Paris, France.

A tire comprised wholly of narrow hook-shaped springs, formed and attached as shown. The hook-like ends are intended to close together under pressure, and the general intention is that the springs, being

small and close together, will yield severally and individually when encountering a rough place in the road, substantially as the pneumatic tire does. The idea seems to com-

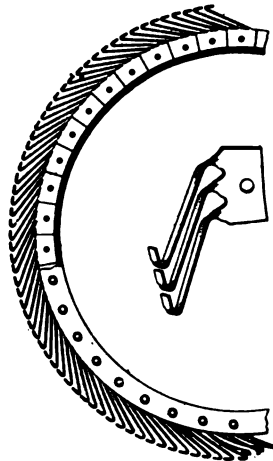

ALLOATTI SPRING TIRE.

bine in an unusually high degree the features of attractiveness on paper and impossibility in practice, which seem to characterize most spring tires thus far devised.

Expanding Hub Brake.

No. 764,357.—J. G. Heaslet, of Philadelphia, Penn.

The brake drum C is closed, as shown in the upper sketch, on the side toward the wheel spokes D D. On the other side it is closed by a fixed disk E, arranged to make it as near dust-proof as possible, and having internal projections E 3 supporting the radially movable brake-shoes H H. A lever I 5 acts through a short arm and toggle links I I to force these brake-shoes outward. As the tendency of E when the

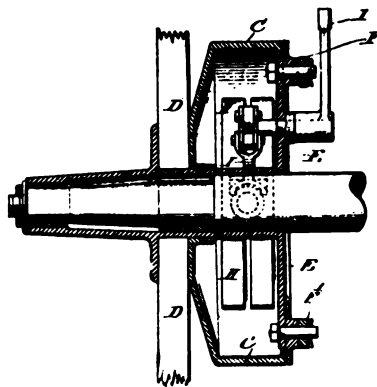

CROSS SECTION OF HEASLET BRAKE

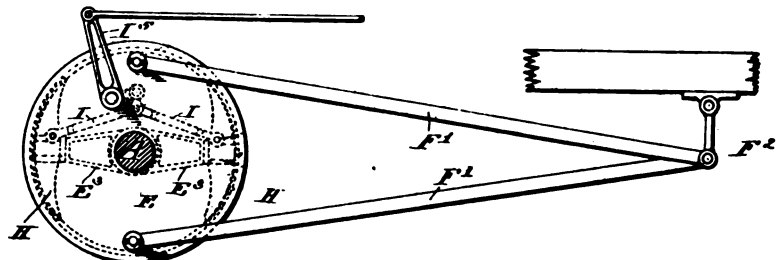

HEASLET INTERNAL EXPANDING HUB BRAKE AND STRUT RODS.

brake-shoes grip is to rotate with the wheel, the two strut rods F I are attached to it, and pivoted to a point F 2 on the frame.

As E is loose on the axle the rear springs suffer no bending or torsion when the brakes are applied.

Steam Generator.

No. 763,655.—T. W. Barber, of London, England.

A generator for vehicles, which most nearly falls in the classification of the water tube boiler. It comprises essentially two groups of slightly inclined tubes F 1 and F 2, upper and lower headers are used, and the lower ends of tubes F 1 go practically to the bottom of the lower header, while the lower ends of tubes F 2 are a little higher. The normal water level is on line yy, and the expectation is that steam will collect in the upper part of the bottom header F 8, when the generator is at work. The result will be that the water level in F 8 will have to rise to the line xx before water will enter

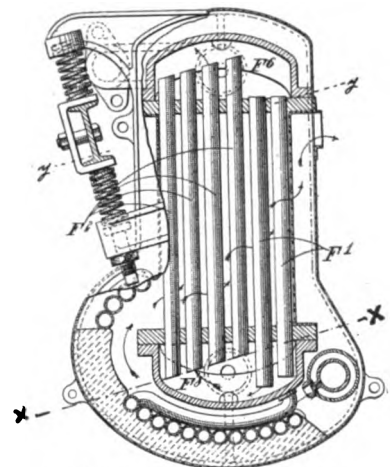

BARBER STEAM GENERATOR.

the bottom of tubes F 2. Consequently its tubes will be filled with a mixture of water and steam, and as the fire from the burner will be arranged to play principally on these tubes, rather than on tubes F 1, the movement of the contained water and steam in the former will be upward. The water carried into the upper header F 6 will fall to the bottom of the same and be returned by tubes F 1 to the bottom of F 8. It will be noted that the circulation is not due to gravity, but rather to the continued expansion and upward movement of the steam in tubes F 2. Practically the weight of water in tubes F 1 will balance or slightly overbalance the weight of the water and steam in tubes F 2. The generator is partly

spring-supported, as the drawings show, and the burner is arranged to use hydro-carbon fuel.



VOL. XI.

No. 4

Published every Saturday by

THE CLASS JOURNAL CO.,
Flatiron Building, Madison Square,
NEW YORK CITY.

Cable Address - - - Autoland, New York
Long Distance Telephone - 300 Gramercy, New York

SUBSCRIPTION RATES:

United States, Canada and Mexico, - One Year, \$2.00
Other Countries in Postal Union, - One Year, \$3.00

To Subscribers—Do not send money by ordinary mail.
Remit by Draft, Post-Office or Express Money Order,
or Register your letter.

FOREIGN SUBSCRIPTION AGENTS:

ENGLAND:—Hiffe & Sons, Limited, 3 St. Beide Street,
Ludgate Circus, London, E. C.

FRANCE:—Boyveau & Chevillet, 22 Rue de la Banque,
Paris.

GERMANY:—A. Seydel, Mohrenstrasse 9, Berlin.

To Advertisers—Copy or changes in orders for advertisements should reach us not later than 5 o'clock p. m. Monday for the issue of Saturday following.

Copyright, 1904, by The Class Journal Company.
Entered at New York, N. Y., as second-class matter.

The Automobile is a consolidation of The Automobile (monthly) and the Motor Review (weekly).

Copies Printed This Issue, - - 12,000
" " Since Jan. 1, - 361,300

Speed Maniacs a Menace.

A few years ago the popular hostility against automobiles was based mainly on the fact that they frightened horses and were excessively noisy. To-day the average automobile is not noisy—indeed, it is sometimes dangerously noiseless—and the horses of urban and suburban communities, at least, are so far wonted to it that with anything approaching reasonable consideration on the part of the chauffeur run-away accidents are rare.

But, while this early source of friction has nearly worn itself away, a new menace, more dangerous because not to the same degree self-correcting, has gradually arisen in the increasing speed of the faster machines and their rapidly growing vogue. Nothing is more common than the assertion that the man in a fast car is utterly careless of the rights of others in the road. If this were literally true the situation would be one justifying any remedy however desperate. Unhappily, it is in fact so nearly true as to warrant grave anxiety for the future of automobilism in the vicinity of New York at least, unless some effective remedy for its abuses be soon found. The plain fact is, that the joy of speed, the exhilarating sense of being able by a touch to command a flight swifter than the birds, becomes for certain natures an intoxication, which for the time being renders the subject insensible to ordinary considerations of courtesy and even to the plain dictates of prudence. The man who, forgetting that

his own life is involved in the stake, will recklessly race to beat a train at a crossing, who will coast at speed, even in a rain storm, down an unknown hill, who will start across a railroad track with the flag-man frantically trying to save him from dashing into an approaching train, or who will drive by night at thirty miles an hour with insufficient lamps or on an unfamiliar road,—such a man is plainly not in his sober senses, and other lives are not likely to be more sacred to him than his own.

The ease with which persons of weak self-control, and with no other qualification than depth of purse for the responsibilities which go with a fast machine, can acquire and use cars capable of speeds from thirty to fifty or sixty miles an hour, is a most serious fact. Specific means must be found to curb these speed maniacs, for one such man in a community can bring a whole tribe of law-abiding drivers into disrepute. The present outbreak of shooting and such utterances as those of Magistrate Cornell, indefensible though they are, merely signify that insensate motoring will produce an insensate public. The jail penalty, inflicted with rigorous justice, not on the hired chauffeur, but on his responsible employer, is the only remedy likely to be effective. Let us see it applied.

Tour to St. Louis.

By the time this issue of THE AUTOMOBILE reaches most of our readers the Boston and the New York via Albany contingents in the national club tour to St. Louis will have started on their long trip. The list of entries for this tour has fallen considerably short of the rather sanguine early expectations of its organizers. It will be over fifty, and late entries may bring it nearly double that number, of whom, however, only a few will be in the far Eastern contingent. Doubtless the affair will derive its best aspect numerically from the club escorts which it will undoubtedly receive on entering and leaving the larger cities *en route*.

But although the dream of a great he-gira of automobilists, hundreds or thousands strong, streaming along the highways and descending like a wolf on the fold to overwhelm the hotels and garages at every night stop, is in no danger of being realized, yet the run may go on record as a brilliant success of another sort, if it is carried out in sensible fashion. There are a number of cars entered by manufacturers, but these, it may be hoped, will not fix the tone and spirit of the run. The affair is promoted by and for amateurs, and the busy men from their affairs to set their faces toward the Mecca of St. Louis will best serve their own comfort and encourage future undertakings of the same sort by shunning any attempt to make it an "endurance run." The schedule is arranged on the touring plan, with easy stages, in no case over 120 miles a day; and with good

weather it can be followed with ease. With wet weather, no one who considers his comfort or his machine will pay much attention to the schedule from Buffalo to Cleveland or from Chicago to St. Louis, for the simple reason that the roads, especially in the latter section, will be practically impassable.

In one respect at least the tour is likely to have substantial value outside of the immediate field of the automobile industry. It will call attention in a striking way to the road conditions, good and bad, in the several parts of the country traversed, and the agitation, comparison of methods, and general information thus disseminated cannot fail to have a good effect in aiding the cause of highway improvement where it is most needed.

Another Reliability Cup.

Readers of the announcement in these pages last week of Charles J. Glidden's intention to offer an international challenge cup for competition in non-stop runs or touring, will be interested in the news that a similar trophy has just been offered in England by Sir Thomas Dewar, M. P., in the shape of a perpetual challenge cup bearing the donor's name. The offer of this cup, which is to be competed for by non-stop runs of at least 2,000 miles, was suggested to Sir Thomas by the recent attempt of D. M. Weigel to cover 2,000 miles without stopping the motor of his 15-horsepower Talbot car. This feat, which had been unsuccessfully attempted by others several times before, was carried out by Mr. Weigel in 124 hours of continuous running, and he is now the first to hold the Dewar cup.

The exact terms of future competitions are unsettled, but will probably include the following: Trials for the cup shall not take place oftener than twice in one year, three months' notice of challenge to be given and the course to be not less than 2,000 miles long and selected by Sir Thomas Dewar. The challenger shall state the distance he challenges the holder for. Observers will be appointed by the cup trustees, and at least four persons shall be carried through the whole tour. Not more than three changes of drivers are to be permitted.

A challenge has already been received from Henry Fournier, and several others are expected in the near future.

A decidedly interesting point brought out in connection with the accident at Rockville Centre, L. I., a few days ago, is the fact that the L. I. Railroad Co. some time ago declared the crossing at which the smash occurred to be dangerous, and, with the support of the State Railroad Commissioners, endeavored to build a bridge at that point. This praiseworthy attempt was blocked by the violent opposition of the townspeople themselves, who apparently preferred the risk of losing their unimport-

ant necks to helping bear the town's share of the expense. If the leader of Rockville Centre's opposition were to be the next victim, the rest of Long Island would be able to control its grief.



Several crudities and inconsistencies have developed in the new Iowa automobile law. One anxious owner wrote to the Secretary of State asking: "How am I to attach a number a foot long and half a foot high and a red light to the rear of my vehicle, which is a motor cycle?" After due consideration, the secretary passed up the puzzle by replying that his duties as fixed by the law were to collect the fees and register the machines, while the law required the owners to do the attaching of the numbers and lights.

While the automobile bill was pending in the legislature, S. D. Alexander, of Winterset, Iowa, who had noted the section requiring that a description of the car and its "character," together with the name of the maker and owner, must accompany the application and fee for registration, wrote to the Secretary of State as follows:

"Having very recently purchased an automobile, and having observed that the legislature is about to legislate for the control of the same, I hasten to say that if you will inform me when you open your herd books I will immediately send you the breeding and pedigree of my machine. Cannot at this time give you the name of the sire, but can assure you it is damned by everybody that drives a horse or a mule."



We commend to Magistrate Cornell's attention Section 6, Subdivision 1, of Chapter 538 of the Laws of 1904, New York State, better known as the Hill Automobile Law. This subdivision provides that a second or subsequent violation of the speed limits may be punished by imprisonment not exceeding thirty days, as well as or instead of by a fine. If Magistrate Cornell is in earnest, why does he not use the jail penalty on a few proved cases of furious driving within his own jurisdiction, and advise his brother magistrates to do the same? Talk of shooting is not only wicked but foolish, for it leads nowhere. The automobilist could shoot, if he wanted to, as well as the sheriff, and he would have the law on his side, as he would shoot in self-defense.

JAMES BLACK purchased a new automobile in Toledo Wednesday. It is the very latest and it is red. This makes five for Bowling Green and there are more coming. The next announcement will be of an auto club.—*Bowling Green (O.) Sentinel.*

IF SOME of those councilmen who rode in automobiles in the parade yesterday afternoon didn't go faster than six miles an hour after the parade had disbanded the speed experts were mistaken.—*Battle Creek (Mich.) Moon.*

Preparations on Eve of Big Tour.

Arrangements for the St. Louis tour have been about completed, and the entry numbers and route cards are being forwarded to entrants. Each day's program is printed on a separate card, and the cards are furnished in a leather case with a clear celluloid sheet in one side, so that the card for the current day, placed next to the celluloid, may be seen without removing it from the case and without exposing it to rain or dirt. Arrangements for piloting and laying the trail of confetti have been made. Tour officials in portions of Ohio, Illinois and Indiana have placed arrows on the roads leading to night stops.

President Whipple has made the suggestion, which will be carried out, that a number of the tourists act as couriers, carrying letters from the mayors of Boston, Springfield (Mass.), Albany, Syracuse, Utica, Rochester, Buffalo, Cleveland, Toledo, Chicago, Detroit, Springfield (Ill.), Philadelphia, Baltimore, New York, Pittsburg, Columbus, Richmond, Indianapolis, Louisville, Cincinnati, Kansas City and other cities, to Mayor Rolla Wells, of St. Louis. These will be presented on Aug. 11, St. Louis Day.

From letters received from garage proprietors along the route, the tour officials feel safe in making the statement that there will be ample accommodation for all cars at every point along the route.

THEATER PARTY IN SYRACUSE.

Special Correspondence.

SYRACUSE, July 18.—The Automobile Club of Syracuse, at its meeting to-night, instructed the entertainment committee to arrange for a theater party at the open air theater at Onondaga Valley, three miles from the city, to which the St. Louis tourists will be invited on the evening of July 29, when they stop here for a few hours. Special trolley cars will convey the party to the theater.

Handsome club buttons attached to ribbons in the club colors inscribed in letters of gold, "Welcome to the World's Fair Tourists," will be given to the visitors and the club members.

The tour headquarters in Syracuse, the Yates Hotel, will be decorated for the occasion.

The club also decided to advise the Tour Committee of the American Automobile Association not to make a side trip from Chittenango to Cazenovia to view the beautiful lake of that name on account of the poor condition of the roads in that section.

BUFFALO HOSPITALITY FOR TOURISTS.

Special Correspondence.

BUFFALO, July 18.—Elaborate preparations are being made by Buffalo automobilists for the entertainment and comfort of the tourists who will make the run from the East to St. Louis, arriving here, as scheduled, Saturday night, July 30, and remaining over Sunday. Never before has the automobile fraternity here worked so hard to make the visit one that will linger long in the memory of the tourists as well as the local people.

The Boston and New York contingents will meet here and go on west together

Monday morning, August 1, by way of Erie. A score or more of Buffalo motorists are planning to join the run.

The success of Buffalo's efforts to entertain the tourists lies with Jess B. Eccleston and a number of willing and energetic assistants. Mr. Eccleston is chairman of the entertainment committee of the Automobile Club of Buffalo, and is one of the most prominent and popular automobile men in New York State. "The members of the Automobile Club are already active," says Mr. Eccleston, "and a committee has completed arrangements for hotel accommodations. Arrangements have also been made to store and care for the tourists' machines. Mr. W. H. Smith, of Syracuse, recently informed me that I had been appointed as a sort of pilot to bring the tourists from Rochester to Buffalo. The Automobile Club will have open house while the tourists are here. I will go to Rochester with several other Buffalo men. We will take bags of confetti and after meeting the tourists will start out ahead, scattering the confetti along the route."

On the Sunday morning the tourists are here they will be escorted to Niagara Falls by Buffalonians and the day will be spent in sightseeing. It has not yet been decided what will be done in an official way by the city.

COLUMBUS PREPARING FOR TOURISTS.

Special Correspondence.

COLUMBUS, O., July 18.—Tourists who pass through this city in the big automobile run to St. Louis will be given a royal reception here August 4. The Columbus Automobile Club has appointed committees to meet and take care of the visitors and their cars over night. Each car will be cared for at the garage conducted by the local agent of that make of cars. Four cars have been assigned for escort and confetti duty. One of the cars will be sent to Delaware, about twenty-five miles north-east of the city, to meet the touring party which comes by way of Cleveland. Another car will go to Zanesville, sixty miles distant, to meet the party coming from the East over the National Turnpike from Baltimore. Open house will be kept by the local club at the Chittenden.

Everything necessary to the comfort and entertainment of the tourists will be looked after.

AN ESCORT THROUGH WORCESTER.

Special Correspondence.

WORCESTER, Mass., July 18.—Edwin C. Harrington and B. Austin Coates have been appointed members of a committee of the Worcester Automobile Club to look after the entertainment of the St. Louis tourists who are expected here on the morning of July 27. This committee will work in co-operation with the general committee, of which Charles J. Glidden is chairman. While no Worcester motorists are expected to participate in the St. Louis tour, local club members will escort the visitors through Worcester, and as far as Leicester or Spencer.

AT A recent meeting of the Board of Park Commissioners of Springfield, Ill., resolutions were adopted amending the rules governing automobiles. They provide that no automobile shall be permitted in Washington Park or on the boulevards from 6 p. m. to 5 a. m.; that no one under sixteen years of age shall be permitted to operate a machine in the park or on the boulevards, and that a speed limit of eight miles an hour shall be rigidly enforced.

ROUTE FOR COAST ENDURANCE RUN.

Grades and Road Conditions on 500-Mile Route from San Francisco to Los Angeles as Observed by L. P. Lowe for A. C. of California.

Special Correspondence.

SAN FRANCISCO, July 13.—L. P. Lowe, chairman of the racing committee of the Automobile Club of California, has returned from his trip of inspection of the route proposed for the endurance run of the A. C. of California and the A. C. of Southern California, and has prepared a report giving full and minute details of his trip of inspection. His trip was made within the proposed time and at about an average speed of fifteen miles an hour, the maximum suggested for the run. A slower rate than this will be adopted—probably a maximum of twelve miles an hour and a minimum of eight miles. Starts will be made earlier in the morning and controls reached earlier in the evening than was first suggested. The number of minutes consumed and the number of points with which each machine will be credited at the start will be more than 4,000. Dates will be fixed in a few days.

A stop of one hour will be made each day for luncheon and the taking on of fresh supplies of water and gasoline and looking after the car, and a stop of fifteen minutes will be made in the middle of the forenoon and another in the afternoon for brief rests.

As the run of five hundred miles to Los Angeles will nearly wear out a set of brakes, time will be allowed to attach a new set if necessary; and for this purpose two days will be spent in Los Angeles. As the run is to be made for the purpose of encouraging the careful and safe use of automobiles, stops made for the better adjustment of brakes will not be penalized; but a stop caused by a defective or broken brake will incur a penalty. The round trip from San Francisco to Los Angeles, or from Los Angeles to San Francisco, and back to the starting point, will occupy ten days.

Mr. Lowe collected accurate data with regard to the San Juan Hill between San Francisco and Monterey. This has generally been regarded as one of the most dangerous in the State of California, and has been variously estimated at one to three miles in length and from 20 to 35 per cent. grade. But Mr. Lowe says it is not difficult to surmount the hill with a car of fair power. The steep portion does not exceed four-fifths of a mile in length and the grade nowhere exceeds 18 per cent. according to numerous observations, the average grade from the northern foot of the hill to its summit being 11.23 per cent., with a minimum of 3 per cent. The decline on the south side is 1 1/4 miles long and is more gradual, the average grade being about 8 1/2 per cent. From the foot of the hill on its northern side to its foot on the southern side occupied twenty-five minutes' running time.

Automobilists are so unwilling to travel over the San Juan Hill that the manager of the Hotel Del Monte at Monterey hopes to get a new route established which will obviate the necessity of taking it. It is hoped to have the new route mapped in time for the annual meet and race of the Automobile Club of California at Del Monte. Owners of cars of sufficient power to negotiate the hill, however, will be repaid by the fine views obtained during the ascent and from the summit.

Mr. Lowe, who made the run to Los Angeles in a White touring car, accompanied

by his brother, S. C. Lowe, and a chauffeur, made many stops for the purpose of inspecting the route, taking photographs and making gradometer observations. The party returned to San Francisco by rail. The distance covered, according to the odometer, was 506 3/4 miles, and the time taken, including all stops except those at the end of each day's run, was 43 hours 16 minutes. An effort was made to conform as nearly as possible to the conditions of the proposed run. On elapsed time, the average rate of speed was 11.71 miles per hour. The running time was 31 hours 50 minutes, or 15.92 miles per hour.

The daily runs from San Francisco were: To Salinas, 110 5/8 miles; elapsed time, 9 hours 25 minutes; San Luis Obispo, 148 3/4 miles; elapsed time, 12 hours 3 minutes; Santa Barbara, 130 1/4 miles; elapsed time, 11 hours 13 minutes; Los Angeles, 117 1/8 miles; elapsed time, 10 hours 35 minutes.

The occupants of the car weighed 620 pounds, the baggage and extra parts 130 pounds, supplies of water and gasoline not being included. The car thus carried 90 pounds more than the 660 pounds required by the conditions of the run.

The roads were found good generally, those in the northern half of the route being better than those in the southern half, except near Los Angeles. The best road was between Oakland and San Jose. The roads were classified as "very good," "good," "fair," "semi-rough," "rough" and "very rough." From San Francisco to Fourteen-Mile House, very rough; to San Mateo, rough; to Palo Alto, fair; to Mountain View, semi-rough; to San Jose, fair; to Gilroy, fair; to San Juan, good; to Salinas, fair; to Soledad, fair; to King City, all kinds and sandy; to Bradley, good to very good, but dusty; to San Miguel, good; to Paso Robles, fair to rough, and dusty; to Templeton, fair; to San Luis Obispo, fair, sandy in places; to Nipomo, rough, sandy in places; to Santa Maria, good; to Garey, semi-rough; to Gaviota, fair to good; to Naples, good, but hilly; to Ventura, fair to good; to New Jerusalem, sandy; to Calabasas, fair; to Hollywood, rough; to Los Angeles, fair.

A piece of road, five miles long between Soledad and King's City is excellent. It seems to be made of limestone on a base of adobe, and, though by no means newly constructed, is not worn at all. The road between Gaviota and Naples, seventeen miles, is good, but so hilly as to be very hard traveling.

There are six steep ascents between San Francisco and Los Angeles, as follows: San Juan Hill, 11 to 18 per cent.; Jolon grade, 8 to 12 per cent., the roadbed new and soft; La Questa grade, 8 to 12 per cent.; the Santa Ynez to Gaviota, 8 to 16 per cent.; Casitas pass, 12 to 18 per cent.; and Canejo grade, 8 to 22 per cent. The 22 per cent. grade is not more than fifty feet long.

MOTORCYCLE MEET AWARDS.

The following is the official announcement of the awards in the motorcycle contests of the Federation of American Motorcyclists, which extended over a period of one week, from July 2 to July 7:

Complete Series—Comprising all tests and the run from New York to Albany and return, and from New York to Cambridge, Md. Highest possible score, 1,317 points—Diamond medal, George N. Holden, Springfield, Mass. (1 3/4 Indian), 1,310 points; silver medal, Frederick C. Hoyt, Springfield, Mass. (1 3/4 Indian), 1,309 points; bronze medal, Oscar Helstrom, Springfield, Mass. (1 3/4 Indian), 1,308 points.

The others in order of points are as follows: George M. Hendee, Springfield,

Mass. (1 3/4 Indian), 1,306 points; H. A. Gliessman, New York City (1 3/4 Rambler), 1,296 points; N. P. Bernard, Hartford, Conn. (2 1/4 Columbia), 1,295 points; E. M. Coates, New Britain, Conn. (2 1/4 Columbia), 1,292 points; A. J. Banta, New York City (1 3/4 Rambler), 1,277 points; F. A. Baker, Brooklyn, N. Y. (1 3/4 Indian), 1,276 points; Walter J. Zeigler, West Hartford, Conn. (2 1/4 Columbia), 1,266 points; James W. White, Newark, N. J. (1 3/4 Light), 1,255 points.

First Series—Comprising all tests and run from New York to Albany and return; possible points, 817. Combined gold and silver medal, George B. Pieper, Brooklyn (1 3/4-horsepower Indian), 772 points.

Second Series—Comprising all tests and run from New York to Cambridge, Md.; possible points, 817.—Combined gold and silver medal, J. M. O'Malley, Hartford, Conn. (2 1/4 Tribune), 972 points.

PITTSBURG EVENTS FOR JULY 23.

Special Correspondence.

PITTSBURG, July 18.—Secretary Linford W. Smith, of the Automobile Club of Pittsburg, has announced the schedule of events for the automobile races to be held on the Beechwood Boulevard speedway on Saturday, July 23. It is as follows: Class A—From 1 to 7 1/2-horsepower inclusive; Class B, 8 to 13-horsepower; Class C, 14 to 20-horsepower; Class D, 20-horsepower and over; Class E, free-for-all, for club members only; Class F, free-for-all, without restrictions.

Classes A, B, C, D and E are for club members only, the cars to be operated by owners or by Pittsburg chauffeurs, one person to operate not more than one car in any one class.

SYRACUSE CLUB BRAKE TEST.

Special Correspondence.

SYRACUSE, July 18.—Brake tests and speed trials over one and a half miles of macadamized road at Onondaga Valley will be held early next month by the Automobile Club of Syracuse for demonstration to the public of how quickly the largest cars may be brought to a standstill from their greatest speed.

A number of Syracuse cars will compete, and it is likely that Secretary S. M. Butler will be invited to bring the Automobile Club of America's Mors timing apparatus here for the tests. Cups will be given as prizes in the various classes.

MINNEAPOLIS RACE MEET AUG. 17-18.

Special Correspondence.

MINNEAPOLIS, July 18.—An automobile and horse race meeting will be held at the Minnesota State Fair Grounds, August 17 and 18. The cash and trophy prizes offered are valued at \$10,000. It will be the biggest thing of its kind ever given here. The Minneapolis Automobile Club and the Minneapolis Automobile Dealers' Association are promoting the auto events, and machines from many parts of the Northwest will take part.

H. G. BLAKELEY and W. G. Whitcomb, who left Kansas City July 3 for St. Louis to explore the route of the A. A. A. tour, returned home July 11. They reported that they arrived in St. Louis at 10 o'clock July 8, after being five days on the road. The rain which began shortly after their party left Kansas City pursued it across the State. The roads in some places were so muddy that Missouri mules had to be used to haul the cars through. The route was through Warrensburg, Sedalia, Boonville, Columbia, Warrenton and St. Charles. All members of the party say they will go on the tour in August.



PHILADELPHIANS ORGANIZE.

Tradesmen and Owners Form the Motor Power Association to Boom Motoring.

Special Correspondence.

PHILADELPHIA, July 18.—Believing that automobiling is not being properly boomed here under present conditions, a score or more of local manufacturers, dealers and automobile users met at the Aberdeen Hotel last Tuesday night and formed the Motor Power Association of Philadelphia, the object being to foster interest in automobile affairs through the medium of race meets, town parades and shows.

After a number of addresses by leading tradesmen and users, in which the dire need for such a body was plainly set forth, the organization was formally launched by the election of the following officers: President, George A. Banker; vice-president, W. W. Gawthrop; treasurer, W. F. Rudolph; secretary, Harry D. Le Cato. The election of a board of directors was deferred until the next meeting, which is scheduled for Tuesday night of the present week.

It was the unanimous opinion that a large membership was of primary importance in carrying out the plans of the association, and after some discussion the dues were placed at the nominal figure of \$1 a year.

A number of possibilities in the line of fixtures for the remainder of the season came up for consideration, including a race meet, an endurance run, a parade and a motor boat race, but nothing was decided upon apart from the promotion of a race meet for September. Secretary Le Cato was empowered to attend the races at the Empire City track on Saturday with a view to securing entries.

After complete organization the Motor Power Association of Philadelphia will apply for a charter and secure permanent headquarters in a central location, where members may get information, consult the association's lawyer, and have free use of the rooms, official stationery and stenographer's services.

Pending the establishment of permanent quarters, a temporary office has been established at 712 Girard Building, where Secretary Le Cato is receiving daily accessions to the association's membership.

GERMANTOWN CLUB'S NEW HOME.

Special Correspondence.

PHILADELPHIA, July 18.—The handsome new clubhouse of the Automobile Club of Germantown is well advanced toward completion. It is expected that the building will be under roof by August 1, and that on October 1 it will be completely equipped and furnished. Although considerably less than a year old, the club's membership limit of 100 was reached more than a month ago and the question of raising the limit will be discussed and probably favorably decided before the opening of the club's new home.

The plot of ground, at Greene and Carpenter streets, upon which the new 95 by 50-foot clubhouse is located, is in the shape of a triangle whose longest side measures 325 feet, the property to the eastward having been recently acquired to provide ground for tennis courts. The garage, which will be located in the basement, will be large enough for the storage of twenty machines. This has been deemed ample, be-

cause a large majority of the members store their cars at their homes.

Besides bowling alleys and the billiard room, the advisability of providing a squash racket court is being considered. These, with the private dining-rooms, six bedrooms and a completely furnished kitchen, will make the new quarters the best equipped automobile clubhouse in the country.

Pending its completion, the members have been using an old fire company house in the vicinity as a temporary garage and meeting place.

A series of bi-weekly club runs has been inaugurated, the first one of which was held July 5, when upwards of a dozen machines made the trip to and from Valley Forge without a mishap. The next run will be to Spring House.

NEWS NOTES OF THE CLUBS.

LORAIN, Ohio.—The Lorain Automobile Club has been formed with fourteen charter members. The officers for the first year are, Dr. Henry Frederick, president; Captain R. Thew, vice-president; I. Honecker, treasurer, and Frank Floding, secretary.

PEORIA, Ill.—The next run of the Peoria Automobile Club will be to Prospect Heights, where a basket picnic will be held. At a recent meeting eight new members were admitted, making the total membership sixty-seven, corresponding exactly with the number of registered machine owners in the city.

PITTSFIELD, Mass.—At a recent meeting of the Berkshire Automobile Club George E. Hall and Roy Curtiss were elected to membership. President Brandow announced that a new race track was assured for the club at Pleasure Park, subscriptions sufficient to complete the work having been received during the evening.

AURORA, Ill.—A recent run of the Aurora Automobile Club was made up the river to Pottawattomie Park, eleven automobiles and five motorcycles, carrying thirty-five club members, taking part. During the evening a picnic dinner was served in the woods. The trip going and returning was made without mishap. Another run will be held this week.

ANDERSON, Ind.—The Anderson Automobile Club has been formed, the following officers being elected for the ensuing year: George Wright, president; Clarence Shimer, vice-president; W. C. Dunn, secretary-treasurer; directors, Henry Kahn, Charles Lott, Daniel Edward Daniels, Harry Harter, Monroe Bing, Charles East and John Q. Shimer.

PITTSBURG.—The Automobile Club of Pittsburg in a body attended the matinee horse races at Brunot's Island last Saturday as the invited guests of the Matinee Club of Pittsburg and Allegheny. The automobile club members assembled in their cars in front of the Duquesne Club and started for the island at 1 o'clock. A pilot car, carrying a flag, led the way. There were twenty-four persons, riding in seven cars.

COLUMBUS, O.—The Columbus Automobile Association has adopted resolutions censuring the municipal officers of Columbus for the deplorable condition of many of the principal thoroughfares of the city, which, it is claimed, is due to the negligence of the authorities in allowing semi-public corporations to tear up the paving without relaying it properly. The associa-

tion is planning a trip to the Highland County caves, located in the southern part of the State. A map has been prepared showing two routes by which they can be reached. The caves are beautiful natural curiosities, and the roads to be traversed are in fair condition.

LYNN, Mass.—An automobile club has been formed here with the following officers: Thomas W. Gardner, president; Walter S. Haliburton, secretary, and Albert R. Creighton, treasurer. A committee composed of the president, secretary, A. M. Hoyt, Thomas Needham and E. F. Bacheller, was appointed to prepare and submit by-laws at a meeting to be held July 25, when the charter membership list will be closed.

TOLEDO.—The Automobile Club announces that it has secured as a permanent home the entire first floor of the Hotel Collingwood, affording furnished parlors, smoking rooms, dining rooms, and the like. Table d'hote dinners will be served daily from 6 to 8 p. m., and Sundays from 1 to 3 p. m. A la carte every week day from 10 a. m. to 10 p. m. The board of trustees have selected the regulation gray cap as the official head-gear of the club.

ROCKFORD, Ill.—At a recent meeting the Automobile Club of Rockford discussed at length the matter of scorching, and adopted a resolution providing for the expulsion of members who may be found guilty of speeding their machines in excess of the limit prescribed by law. The resolution provides that fines may also be assessed against offenders. The privileges of the club are such that most offenders after notice will be glad to quit excessive driving in order to remain in the club.

SAN DIEGO, Cal.—The Automobile Club, of San Diego, has been organized, with the following officers: Roy Howard, president; W. J. Wagner, vice-president; George N. Nolan, secretary-treasurer; directors, W. W. Whitson, J. W. Sefton, Captain Humphries, Roy Howard, W. J. Wagner and George N. Nolan, Jr. The club announces its purpose to promote the use of motor vehicles, defend and protect the rights of owners and secure improvements in the condition of public roads.

DAVENPORT, Ia.—The Automobile Club of Davenport has filed articles of incorporation, stating that the club will be athletic and educational in character, and that its objects are to encourage, promote and improve automobiling. Until the new year the directors will be A. L. Hageboeck, W. D. Peterson, F. L. Hillis, T. B. Carson, Sam T. White, B. L. Schmidt and A. H. Ruebsam. The following officers have been elected for the ensuing year: Sam T. White, president; T. B. Carson, vice-president; A. N. Ruebsam, secretary, and B. L. Schmidt, treasurer.

FITCHBURG, Mass.—The Wachusett Automobile Club held a run on Saturday, July 16, to Concord and Lexington, nine cars being in line. The start was made from the club's quarters at 9 o'clock, stopping at Hotel Sweetwater, Bedford Springs, for dinner. After a short time on the road a severe thunder and rain storm was encountered, forcing a number of the party to seek shelter in a nearby barn. After a short wait, the storm somewhat abating, another start was made. But a second shower overtook them, after running a short distance and several turned back to again take refuge in the barn. Just before reaching it the barn was struck by lightning and burned to the ground. The run was then continued and finished with but two more mishaps, one machine receiving four tire punctures, and another breaking down at Leominster, the occupants arriving home Sunday morning.

AMERICAN AND FOREIGN AUTOMOBILE AND AUTO BOAT FIXTURES.

Automobiles and Motorcycles.

- July 23—Straightaway Speed Trials and Races. Beechwood Boulevard, Pittsburgh. A. C. of Pittsburgh.
- July 25-26.—Circuit des Ardennes, Belgium. A. C. of Belgium.
- July 25-Aug. 10.—American Automobile Association Tour to St. Louis.
- July 30.—Race Meet, Newport, R. I., Newport Amusement Association.
- Aug. 1-3—Bexhill Meet and Races. England. A. C. G. B. & I.
- Aug. 6.—Second Annual Meeting of Missouri and Kansas Auto Association, at Leavenworth, Kan.
- Aug. 11.—Automobile Day and Parade at the World's Fair, St. Louis.
- Aug. 17-18.—Races at State Fair Grounds, Minneapolis.
- Aug. 19-20.—Race Meet at Glenville Track, Cleveland. Cleveland A. C.
- Aug. 21.—Semmering Hill Climb, Austria. A. C. of Austria.
- Aug. 21.—World's Fair Race Meet. St. Louis Fair Grounds Association.
- Aug. 22-Sept. 4.—French Industrial Vehicles Trials, Paris. A. C. of France.
- Aug. 27.—Motor Bicycle Non-Stop 100-Mile Run, British Motorcycle Club.
- Aug. 28.—Ventour Hill-Climbing Contest at Avignon, France.
- Aug. 29-Sept. 3.—Show and Track Races in Milwaukee. Milwaukee A. C.
- Sept. 2.—Chateau Thierry Hill Climb, France. A. C. of France.
- Sept. 16.—Race Meet, Poughkeepsie, N. Y., Dutchess Co. Agricultural Society.
- Oct. 5.—Dourdan Kilometer Trials. *Monde Sportif*.
- Oct. 8.—Vanderbilt Cup Race, Long Island, N. Y.
- Oct. 9.—Gallion Hill-Climbing Contests. France. *L'Auto*.
- Oct. 16-25.—Leipzig Cycle and Motor Show, Germany.
- Nov. 20.—French 100-Kilometer Trials, Algeria.

Auto Boats and Launches.

- July 23-25.—Motor Boat Races. Lucerne, Switzerland.
- July 26-27.—Reliability Trials for Motor Boats. England.
- July 30.—Harmsworth International Cup Race. The Solent, England.
- July 30.—Atlantic Yacht Club Races. Sea Gate, N. J.
- Aug. 5-11.—Paris-Decauville Motor Boat Race.
- Aug. 6.—Larchmont Yacht Club Races.
- Aug. 12.—Gaston-Menier Cup Race. France.
- Aug. 13.—Manhasset Bay Yacht Club Races. L. I. Sound.
- Aug. 13-14.—Calais-Dover-Calais Race. English Channel.
- Aug. 15.—Calais-Boulogne-Calais Race. English Channel.
- Aug. 18.—New York Yacht Club Races.
- Aug. 20.—Brooklyn Yacht Club Races.
- Aug. 27.—Larchmont Yacht Club Races. Long Island Sound.

BULLETS FOR MOTORISTS.

Long Island Deputy Sheriff Adopts Dangerous Method of Making Arrests.

Shooting at an automobile with a revolver in order to bring it to a halt is the latest method of enforcing speed regulations practised by Sherman F. Wicks, a Long Island Deputy Sheriff, and local automobilists are mightily stirred up over the incident. John Foley, Jr., of New York City, was the owner and driver of the automobile involved, and was running eastward on the principal street of Patchogue, L. I., on Sunday afternoon, July 17, together with three men friends, when a man came out into the road in front of the automobile and shouted to the driver to stop. Mr. Foley says that he was running well under 10 miles an hour at the time and that the man who ordered him to stop showed nothing to indicate his official capacity. Therefore the machine was not stopped, and Deputy Sheriff Wicks was forced to step out of the way. As soon as the automobile had passed him, however, he drew a revolver and fired two shots at it, the bullets entering the rear of the body at an angle, one lodging in a cushion an inch from the back of one of the passengers. Even then Mr. Foley did not stop, but proceeded to his destination, and later returned and informed the deputy that he would be proceeded against. He did not await the service of the warrant that Wicks procured later, but engaged counsel and surrendered himself.

THINKS SHOOTING JUSTIFIED.

Shooting, not automobiles but automobilists, is, according to Magistrate Robert G. Cornell, of New York, perfectly justifiable in order to prevent speed excesses.

Richard D. Willard was arraigned before Magistrate Cornell in Jefferson Market Police Court on the charge of driving an automobile through East Thirty-eighth street, New York, at the rate of 20 miles an hour, or a mile in three minutes, and the justice remarked:

"It seems to me that a man would be perfectly justified in shooting the chauffeurs of these squawking nuisances that go rushing through the streets."

And the Magistrate went on to say that down where he lived on Long Island the residents hated automobiles; and then informed Mr. Willard that his bond would not be accepted, but a real estate bond demanded, which would be inquired into closely. Mr. Willard was held for the Special Sessions in \$300 bail, which was furnished.

When interviewed later on the subject of this statement the magistrate is reported as having reiterated the extraordinary remark, adding that he did not consider the expression an intemperate one.

Automobilists throughout New York City are highly indignant, especially in view of the efforts being made to stamp out hoodlumism, which manifests itself in attacks on automobilists.

MINNETONKA LAUNCH RACES.

Rough Water Interferes With First Event in the Northwest.

Special Correspondence.

MINNEAPOLIS, July 18.—The first motor boat race in the Northwest was held Saturday afternoon on Lake Minnetonka during a heavy sea that made fast time impossible, and made the water too dangerous for very small craft to take part.

The race was a handicap, run over a fifteen-mile three-legged course. Twenty-seven boats started out of thirty-six entered.

The starting and finishing point was Tonka Bay, which is this year proving the most popular resort at the lake.

The race was won by J. E. Gage's *Minnesota*, with a handicap of 38 minutes, in 1:55:03. Second place was won by C. D. Heych's *Huiron*, time 1:49; third by Julius Newgard's *Gopher* in 2:04:58, and fourth by H. W. Watson's *Kia-Ora* in 1:48:05.

The best time of the race was made by Nichols Brothers' *Widgeon*, a 20-horsepower boat, which covered the fifteen-mile course in an hour and a half.

The second best time was 1:43, made by J. H. Howard's *Manitou*.

The feature of the race was a contest between *Manitou* and W. P. Davidson's *Billy D*, which started half a minute apart

and were together during the entire run of fifteen miles.

The race was held mainly for the purpose of ascertaining the amount of interest that existed at the lake in auto-boating, and as this has been determined satisfactorily, other races will be held during the summer.

ATLANTIC YACHT CLUB'S RACES.

The auto-boat races of the Atlantic Yacht Club on July 16 proved very uninteresting, as but four boats started. The course for the larger classes was from off the club station at Sea Gate, Coney Island, up through the Narrows and around the bell buoy off Robbins Reef—twenty nautical miles. The smaller launches had a course of ten miles laid out for them. The only starter in Class B was *Nokomis*, Captain Van Clief, and her time for the twenty miles was 2:15:20. In Class R the *Vingt-et-Un II*, started alone, and her time for the twenty miles was 1:12:24.

The only competition was in Class K, in which one of the Atlantic Yacht Club launches was matched against *Nada*, C. A. Godschalk, the latter steered by Miss Godschalk. Some rough water for a 20-foot launch was met on the way, but the *Nada* covered the ten miles in 1:11:27, the *Atlantic's* time being 1:21:40.

AUTO BOATS AT MARBLEHEAD.

In the third day's races of the Eastern Y. C.'s power boat regatta off Marblehead, last Wednesday, the *Mercedes* again suffered a breakdown which put her out of the competition, this time before the race began. Consequently the *Autowin* was again the star. In addition to winning two cups in her class she won the special cup offered by Rear-Commodore W. O. Gay for the boat under 40 feet over all making the smallest total elapsed time in three special races.

Among the autoboats, the winners and the distances were as follows: First class, three laps, 18 3/4 miles; *Fiat*, 1h. 13m. 19s.; Gay cup race, four laps, 25 miles; *Autowin*, 2h. 8m. 23s. The average speed of the former was 15.34 miles an hour, and of the latter 11.69 miles an hour.

GREASING one's automobile number so that dust will stick and conceal the figures isn't obeying Chapter 473 of the Acts of 1903, according to Judge Adams, who today fined F. Shirley Boyd \$10 for doing it. —*Boston Traveller*.

INDUSTRIAL

DISAGREE ON LIVERY RATES.

Special Correspondence.

SAN FRANCISCO, July 13.—The spirited protests of Managers C. R. Scott, of the Scott-Blakelee Auto Livery Company, and Frank E. Hartigan, of the Mobile Carriage Company, before the aldermanic committee on licenses against the proposed reduction of the rental rate for livery cars from \$5 to \$2.50 an hour, is discountenanced by Manager C. A. Hawkins, of the White Carriage Company.

"I'm opposed to this protest," he says. "Why have the high rate, which prohibits the average person from using the machines, when a fair rate gives us good enough income on the investment? The protesting managers, through their arguments before the city license committee, give the public a wrong impression, which I am going to try to remove, and show that the auto can successfully compete with the horse." Mr. Hawkins has sent to the Board of Aldermen a letter which reads in part as follows:

"The life of a good automobile, with ordinary repairs and adjustments, is approximately the same as that of a carriage and there is no reason that I know of why they should not be operated at the same expense to the public for the same service as is charged for carriages and hacks.

"It is, of course, true that an automobile is a much more comfortable and luxurious means of conveyance and will cover the same ground in a great deal less time than can be done by horses. It is also an absolute fact that the work can be done by an automobile at no greater expense than the horse. If you want the proof of this and will have your committee call at my office I shall be glad to show you the books."

NEW CLEVELAND GARAGE.

Cleveland's list of fine garages has been augmented by the new establishment of the Automobile Garage and Repair Company, located on Huron street between Euclid avenue and Erie street, in the best part of the downtown section of the city. The building is a handsome four-story brick structure, measuring 70 by 100 feet. The garage company has taken a long lease on the property and has rearranged some of the details to suit its requirements.

The first floor contains the general sales office, women's reception room, handsomely fitted up, with toilet room adjoining, private offices, stenographers' room and general storage room. The rear of this floor is partitioned off for light repair work, charging station and wash room. For the repair work there are two well-lighted pits and convenient benches. The wash rack is 20 by 30 feet, large enough for three machines at a time. It is fitted with overhead and side lights, so that all parts of the car can be seen at night. The charging plant is arranged to take care of 24 vehicles at a time, there being twelve switches arranged to charge in series two on a line. Arranged along a wall are a number of lockers which are rented to patrons. On an elevated platform are two gasoline storage tanks supplying 76 and 68 degree gasoline and provided with automatic measuring and regulating devices supplied by S. F. Bowser & Co.

The basement, reached by a large electric elevator connecting all floors, is divided into several departments. There is a dark, dry storage room for tires, a well-lighted room for battery testing, repairing and charging, a battery stock room, and an oil

room containing several oil tanks also provided with automatic measuring and regulating devices.

The second floor contains the general sales room and the stock room. In one corner of the sales room is an office for the bookkeepers.

The third floor is equipped for general repair work and contains an excellent complement of machine tools. The fourth floor is to be fitted up as a general manufacturing establishment, as the company is preparing to engage in the manufacture of a number of automobile parts and specialties.

The company made an excellent start in its old quarters on Erie street last fall. It has sold nearly 100 Autocars throughout Ohio, besides a number of Packards and Pope-Waverley electric cars in Cleveland and the vicinity. The company is agent for a line of specialties and has done well with them in this district. The management of the business is now in the hands of J. M. Belin, a clever little Frenchman, who has been in this country long enough to become thoroughly Americanized and well up on the requirements of the trade in this city.

RECENT INCORPORATIONS.

Plainfield Auto Garage, Plainfield, N. J.; capital, \$25,000. Incorporators: Andrew Wilson, Joseph B. Longhead and Elizabeth Longhead.

Hyne Motor Co., Plainfield, N. J.; capital, \$25,000. Incorporators: Harrison Coddington, William B. Harsel, Charles F. Fulmer and Charles F. Hyne.

Citizens Auto Transit Co., Cleveland, O.; capital, \$600,000. To operate automobiles, omnibuses and carriages. Incorporators: H. H. McKeehan, W. G. Merick, W. B. Stewart, G. W. Cottrell and Julian W. Tyler.

Motor Vehicle Transportation and Delivery Co., New York City; capital, \$10,000. Directors: C. R. Ruckert, Bensonhurst; Charles Schmitt, Jersey City Heights, and C. R. Smith, Brooklyn.

Merkel Motor Company, Milwaukee; capital, \$200,000. Incorporators: A. B. Ferdinand, Joseph F. Merkel and W. J. Merkel.

Broadway Automobile Exchange, New York City; capital, \$2,000. Incorporators: L. C. Jandorf, H. N. Jandorf and H. E. Harkins.

Boston Show Company, Boston, Mass.; capital, \$10,000; to promote automobiling, race meets and shows. Incorporators: Kenneth A. Skinner, Harry Fosdick, H. McAlmond and C. L. Campbell.

Automobile Depot, New York City; to sell, rent and store automobiles; capital, \$5,000. Directors, E. C. Griffith; P. M. Pelletreau, and W. H. Estes.

Fair Mfg. Co., Minneapolis; capital, \$50,000; to manufacture and deal in motors and appliances. Incorporators: Joseph Mullen, P. J. Harlin, and Henry Cowley.

Eureka Manufacturing Company, of Detroit; capital stock, \$50,000; to manufacture automobile machinery, china kilns and fire brick. Incorporators: Henry Egle, William Egle, Ralph E. Northway and Andrew V. Erving.

Battery Power Co., Milwaukee; capital stock, \$30,000; to manufacture storage batteries of a new type. The company will occupy a three-story brick building on Madison street, Milwaukee. Its portable batteries will be adapted for use in automobiles and the company claims that a battery of twenty-four cells weighing 390 pounds will have a voltage of 55 volts and possess 160 ampere hours' capacity. This would be sufficient to run a machine from 75 to 100 miles on a single charge.

TO WHOM IT MAY CONCERN.

The following inquiries have been received by THE AUTOMOBILE:

Fritz Schmidt, Stockholm, Sweden, asks for the addresses of builders of commercial automobiles having a capacity of from 2 to 3 tons, propelled by internal combustion motors.

G. H. Ireland, Box 577, Montreal, Canada, wishes to know the address of a manufacturer who can supply him with an automobile having a dynamo coupled to the vehicle motor, the dynamo to furnish 25 amperes at 52 volts to be used to operate a moving picture machine.

Mazza & Parravicini, Milan, Italy, wish to secure the agency for a good American automobile.

NEW GARAGES AND IMPROVEMENTS.

MT. VERNON, Ohio.—A garage and repair shop has been opened here by Ralph E. Vail.

GRAND RAPIDS, Mich.—Work has been commenced on the automobile salesroom and garage of J. K. Johnson on the south side of Louis street, between Market and Ottawa streets.

LA CROSSE, Wis.—The Pioneer Foundry Company has purchased the plant and business of the Bell Machine Company, at 110-112 Main street. Improvements to the extent of about \$5,000 will be made in the plant of the Pioneer Company, and automobile repairing and the manufacture of gasoline engines will be more extensively engaged in under the supervision of George Bell, formerly in charge of the Bell Machine Company.

ROCKFORD, Ill.—The Rockford Tack & Nail Company has equipped a portion of its factory as an automobile garage and repair station, and now has ample facilities for the speedy repair of both American and foreign makes of machines.

NORTH ADAMS, Mass.—An automobile garage and repair station has been opened on Ashland street by F. L. Rand. The station has a storage capacity for sixteen machines.

FITCHBURG, Mass.—George L. Lewis, on Ludenburg street, and H. C. Dean, on Water street, have established garages, and have ample facilities for general automobile repair work. In addition, they also carry a full line of supplies.

SOMERVILLE, Mass.—Hill & Holt, 79-81 Bow street, are agents for the Ford automobiles. They are conducting, in addition to their sales business, an up-to-date storage and repair station, and carry a line of general automobile supplies.

LOS ANGELES.—Elmer R. Ridsen, one of Los Angeles' pioneer bicycle dealers, has entered the automobile field and is now managing the station at 651 South Broadway, formerly conducted by Olive & West. The shop has been enlarged, and under the name of the Western Garage will do a general repair, storage and sales business.

SOUTH BEND, Ind.—A handsome and commodious building situated on the corner of La Fayette and Wayne streets is nearing completion and is to be occupied by W. H. Barger. The building is a brick and steel structure 150 by 60 feet, and will have a complete plate glass front. Mr. Barger will have a full equipment for charging electric vehicles and everything necessary for making repairs.

CLEVELAND.—The Chisholm & Phillips Automobilia is now occupying its handsome new establishment at 1197 Euclid avenue, opposite Olive street. The building is a three-story brick structure designed and built especially for the company's requirements. The company is featuring the Peerless, Knox and Royal lines and is meeting with excellent success.



Ridley, Bennett & Auten have secured the agency for the Oldsmobile at Oelwein, Ia.

The clubrooms of the Automobile Club of America will be closed during the month of August after 7 o'clock p. m.

The Park Commissioners of Boston, Mass., have purchased a Grout steam automobile to be used in official business.

A sight-seeing automobile has been started over a route in Boston which includes the principal points of interest.

The recently incorporated Detroit Motor Car Co. is seeking a manufacturing site in the town of Wyandotte, Mich.

H. Godschalk, of Philadelphia, will soon attempt a round trip to Atlantic City on his Baker electric without recharging his batteries.

John H. MacAlman has been elected treasurer of the Boston Automobile Dealers' Association, incorporated recently, with a capital of \$5,000.

It is reported that an air-cooled automobile is to be manufactured in Boston at an early date, and that the first machine is almost finished.

The Napier Company of America has opened a salesroom adjoining the Massachusetts Automobile Club on Boylston street, Boston.

Philadelphia will have but one representative on the St. Louis tour—W. B. Saunders, publisher of medical books, who will go in a 20-horsepower Winton.

The addition to the clubhouse of the Massachusetts Automobile Club, Boston, was completed last week. The addition will be used altogether for garage purposes.

Mrs. Chouteau Scott, of St. Louis, has a new Columbia car of 30-horsepower. She drives the car herself. It is the largest machine driven by any woman in the State of Missouri.

The automobile race meet which is to take place at Newport, R. I., in August is already attracting the attention of Boston owners of fast machines, and a large list of entries is looked for.

The Kansas City Board of Park Commissioners has approved an ordinance limiting the speed of automobiles on the boulevards and park driveways to eight miles an hour.

The Mississippi Valley Automobile Company has built an annex to its garage for the accommodations of visitors' autos during the month of August. The annex provides for 100 machines.

The Cleveland Motor Co., against which an involuntary petition in bankruptcy was filed some time ago, has submitted a schedule placing its assets at nothing and its liabilities at \$22,120.

A Michigan light touring car made a good showing at the automobile races held at Recreation Park, Kalamazoo, Mich., on July 4. This machine won the 2-mile race in which it was entered with ease, the time being 3 minutes 29 seconds.

The increasing business of the Reed-Underhill Company, which has the Boston agency for the Knox waterless gasoline automobiles, has made it necessary to secure larger and more central quarters, where both business and pleasure vehicles can be

handled. After August 10, therefore, the company will be found at 222-228 Columbus avenue. During the past six months thirty Knox delivery vehicles have been sold by the Reed-Underhill Company.

J. M. Smelzer, of Anderson, Ind., is endeavoring to interest local capital in establishing an automobile factory at Columbus, Ind., he having invented an engine especially for automobiles.

Negotiations are now under way between the Chamber of Commerce of New Castle, Pa., and a Buffalo manufacturing firm for the establishment at New Castle of a factory for the manufacture of automobiles.

The new quarters of the Knox automobiles on Columbus avenue, Boston, is now rapidly nearing completion. Besides ample accommodations for the display of cars, considerable space will be devoted to the convenience of patrons.

Lit Brothers' department store in Philadelphia has announced the installation of a full line of Reliance motorcycles and parts. Gimbel Brothers, of Philadelphia, recently began selling motor boats. Wanamaker has been selling automobiles for three years.

The Dayton Electrical Manufacturing Company, Dayton, O., is marketing the entire output of ignition plugs of the Climax Ignitor Co., Amesbury, Mass. The new plug has been called the Magnetic Ignition plug.

Governor La Follette, of Wisconsin, will make a campaign automobile tour of the State during the late summer and fall. The Governor will use the automobile, because by this means he will be able to address the thousands of voters whom it would be impossible to reach by railroad.

The Newton Graphic Publishing Company, of Newton, Mass., has just issued a very convenient list of the automobilists registered in the State of Massachusetts, giving as well the motive power and rated horsepower of the automobiles. The book is well bound in leather.

The Boston branch of the White Sewing Machine Company, having outgrown its quarters at Berkley and Tremont streets, has just broken ground for a new five-story brick building at Pleasant and Elliot streets. It is expected that the new place will be ready for occupancy about September 1.

Fame Fire Company No. 6, of Wilmington, Del., which recently appointed a committee with power to have an automobile chemical engine made to order, has abandoned the idea for the present. A member of the company says that the committee had written to two manufacturers in regard to such a machine, but neither would give a guarantee such as was asked for by the company.

The Columbia 12-horsepower car which won a first and third prize in the Mount Washington hill-climb was equipped with regular road gearing. The driver of this machine, H. W. Alden, of the Electric Vehicle Company, Hartford, states that after the first contest the descent of the mountain was made with the car well loaded with five persons and some baggage, bringing the total weight of car and load up to about 3,000 pounds. No trouble was experienced and the bottom was reached quite comfortably in 55 minutes.

Several of the most prominent automobile owners of San Francisco and the neighboring towns on the peninsula propose to build a toll-road to Redwood City, about thirty miles from Frisco. It is planned to make the road a model of construction and by the example foster the sentiment in favor of good roads.

Plans for the holding of an automobile exhibition in Milwaukee this summer have been abandoned, but it is probable that automobile and motorcycle races will be run in connection with the annual State fair to be held here in September under the management of the Wisconsin State Board of Agriculture.

The first consignment of automobiles for the bus line of the East End Auto Traffic Company, of Pittsburg, has been received, and S. J. McFerren, manager of the company, announces that the line will be in operation August 1. Plans have been drawn for the erection of a storage and repair plant at Craig street and Grant boulevard.

An order discharging Charles L. Carrick as receiver of the American Motor Boat Company, of Marion, N. J., has been filed in Trenton. This suit was brought by Albert T. Otto, of Montclair, in behalf of the creditors of said company. The business of the firm consisted largely in the manufacture of launches and tenders for larger vessels.

Notwithstanding railroad and coast navigation statistics show that the June exodus of San Franciscans for interior and coast resorts and to the St. Louis Fair aggregates upwards of 30,000, the automobile dealers are complacent, since they are easily selling all the machines they can secure from the factories, and they assert that present indications are for continued strong demand, even exceeding that of the first half of the year.

The National Capital Automobile Co., of Washington, D. C., has been reorganized into practically a new corporation under the name of the National Automobile Co., which will take over all the property of the old company. Articles of incorporation have been filed by F. M. White, E. P. Nussbaum and W. L. White. Capital stock is \$20,000, authorizing the company to do a general automobile and motor boat business. It will occupy the newly erected garage on Fourteenth street and will handle the Oldsmobile, Peerless, Pierce and Franklin cars, and Racine motor boats. The company is officered by E. C. Graham, president; H. B. Mirick, vice president and treasurer; E. P. Nussbaum, secretary. The general management is in the hands of J. C. Wood.

The Oldsmobile Company has made an improvement in the cooling system of its runabout that will, it is stated, completely avoid the difficulty that has sometimes been experienced through the heating of the cooling water of this machine when the motor is worked hard. Heretofore the circulation has been from the cylinder to the radiator, radiator to pump and from the pump back into the cylinder, the tank being connected through a single pipe to the pipe connecting the cylinder to the radiator, and was thus not included in the circulating system. Now, however, the tank forms part of the circulating system, being placed between the cylinder and the pump and, of course, piped to both. The first cars containing this improvement were received in New York City last week.

THE AUTOMOBILE

WEEKLY

NEW YORK—SATURDAY, JULY 30, 1904—CHICAGO

10 CENTS

PACIFIC COAST ENDURANCE RUN ROUTE.

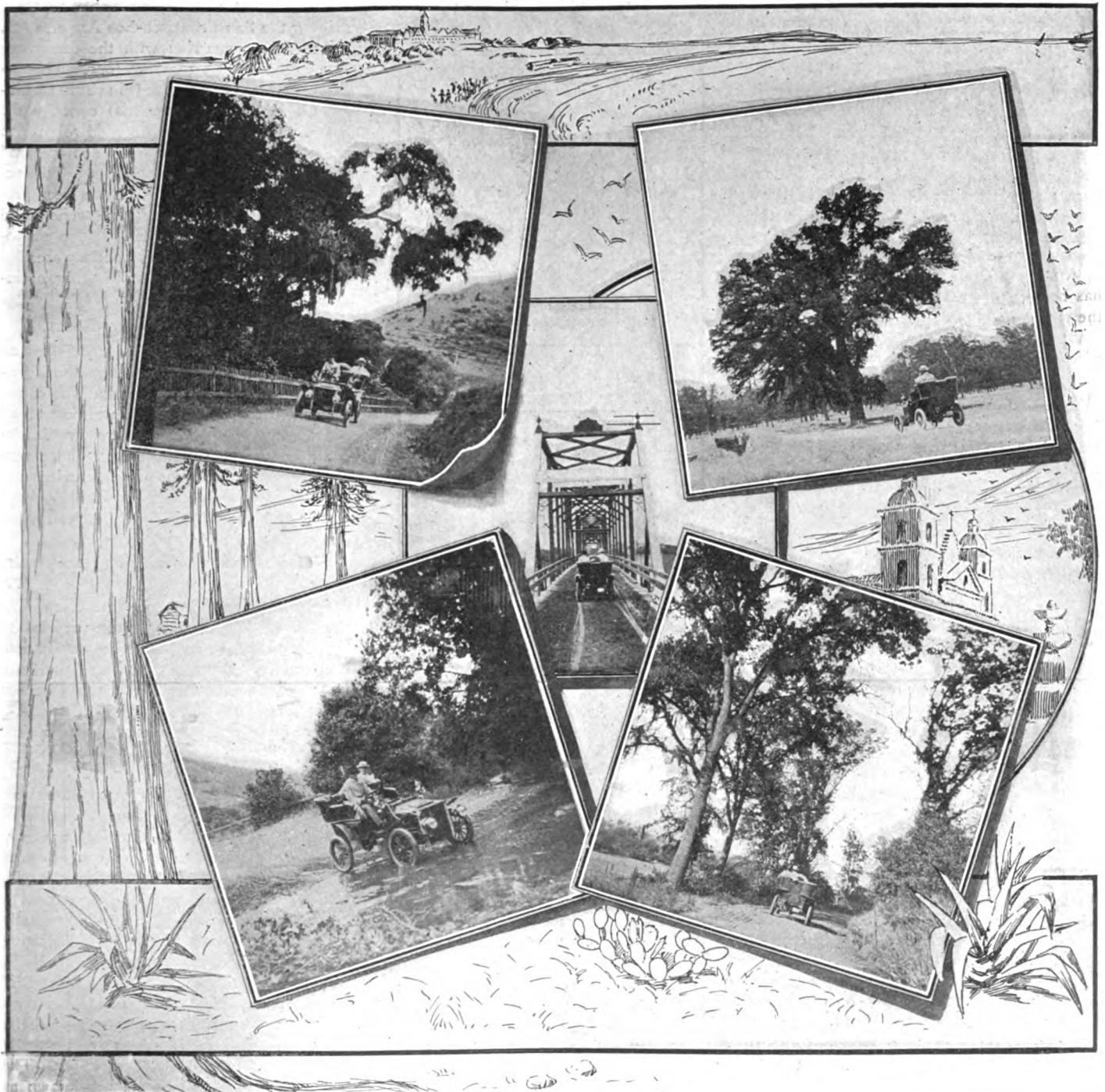

CHARACTERISTIC SCENES ALONG ROUTE OF SAN FRANCISCO-LOS ANGELES TOURING TEST TO BE HELD IN AUGUST.

PACIFIC COAST ENDURANCE RUN ROUTE.

Special Correspondence.

SAN FRANCISCO, July 20.—Growing interest in the coming endurance run to be held jointly by the Automobile Club of California and the Automobile Club of Southern California, insures the holding of the most important automobile event ever scheduled for the Pacific Coast. San Francisco is just beginning properly to take hold of the touring end of motoring, and with the increasing interest in long runs the demand for touring cars has jumped away beyond the ability to fill orders.

Heretofore, automobile owners in San Francisco, with a few exceptions, have done most of their driving in Golden Gate Park and along the beautiful ocean beach south of the famous Cliff House. This has been due largely to the fact that the roads within the city are excellent, while it has not been easy to get out of town, the roads out of this city being in about the worst possible condition. In Alameda County, across San Francisco Bay, as fine highways for automobiling exist as anywhere on the Pacific Coast, but to reach them necessitates a ferry trip, and the novice driver has been content to try out his car within the city limits.

Within the past year, however, through the influence and example of such pioneers in good roads hunting as C. C. Moore, L. P. Lowe, S. G. Buckbee, W. L. Pattiani and others, the owners of cars have been seeking out country runs and have been rewarded by the discovery that the vicinity of San Francisco offers some of the finest automobiling country in the world. The increase in the number of car owners has grown accordingly and the endurance test is a natural outcome.

PICTURESQUE AND DIVERSIFIED ROUTE.

The route chosen for the run—from San Francisco to Los Angeles and back for the San Francisco club members, and the reverse of this programme for the Southern California drivers—is one of the best courses to be found in California. The total mileage of the run will be a little more than 1,000 miles, and will occupy ten days, a two-days' "lay over" being provided for the San Francisco participants in Los Angeles and a two-days' stop in 'Frisco for the Los Angeles participants. Besides comprising all classes of country roads and including all the conditions met with by the touring driver, the route lies through some of the most beautiful of the justly-celebrated California scenery, the picturesqueness of which would be a revelation to an Eastern automobilist. It affords magnificent views of the Pacific Ocean from the *mesas* along its southern portion; it keeps within sight of the splendid Coast Range of mountains for a considerable part of its length, traversing passes high up among the hills; it winds through orchards and vineyards in the rich Santa Clara and other valleys;

it is bordered here and there by orange groves and towering palms, and it gives many a glimpse of the quaint old Spanish missions that joined early California to civilization long before the existence of gold was even suspected.

WILL BE A PLEASANT TOUR.

When it is understood that the run will be made as much with a view to the enjoyment of the tour as to testing the reliability of the cars, and that the details have been so arranged that women may join in the run with comfort, and if they de-

sire drive their own cars, something of the pleasure that is ahead of the participants may be imagined. One feature of touring in California that an easterner would quickly appreciate, is that during the long summer season there is absolutely no danger of interference by rain, and preparation for disagreeable experience on this score is eliminated.

The report on the course, prepared by L. P. Lowe, of the Automobile Club of California, who recently returned from an inspection of the route, is a comprehensive document that will be invaluable to those making the San Francisco-Los Angeles run, whether in connection with the endurance test or purely as a pleasure tour. This official report (summarized in *THE AUTOMOBILE* for July 23, page 100) contains the first adequate data ever compiled relative to the route, and will be in much demand among California automobilists. The accompanying map of the route has been prepared under Mr. Lowe's supervision and accurately shows the course. The photographs published with this article were also taken by Mr. Lowe during his tour of inspection.

GENERAL DESCRIPTION OF ROUTE.

Reporting officially on the conditions as he found them, Mr. Lowe says that, generally speaking, the roads, as a whole, can be classed as fairly good. In almost all of the localities mentioned there are blacksmith shops and general stores, and a reasonable supply of gasoline is carried and there are few very long "jumps." Note particularly, however, the one between New Jerusalem and Hollywood.

Water is readily had along the entire route.

Between San Francisco and King City the country is quite flat, save in the vicinity of San Juan. From King City to Gaviota the country is rolling and mountainous. From Gaviota to Carpinteria it is flat, and from Carpinteria to Ventura mountainous.

For forty miles south of Ventura the country is flat, and from thence to Los Angeles rolling and semi-mountainous.

Most of the route lies through a very beautiful, well-watered, and well-wooded country. The grades and passes are particularly beautiful, with the exception of the Conejo, which is parched and uninviting. The passes and grades contain a great many very short turns which totally obscure the road ahead, and careful driving is imperatively necessary.

There is a difference between a "grade" and a "pass." A "grade" is a continuous ascent or descent, while a "pass" is usually a succession of grades, which are generally not quite as steep as grades proper. The San Juan, Jolon and Cuesta are known as grades, while the Santa Ynez-Gaviota, and Casitas are known as passes. By some the

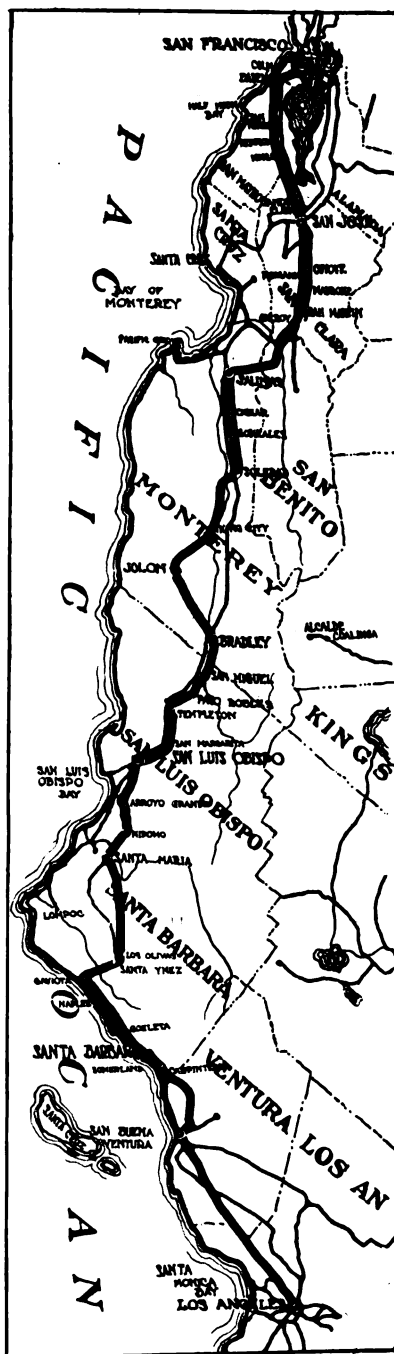

MAP OF 500-MILE ROUTE.

Condition of the Roads for Each Day's Run.

FIRST DAY—SAN FRANCISCO TO SALINAS, 110 5-8 MILES.

From	To	Road Condition.
San Francisco.....	San Mateo.....	Rough for about 14 miles, sand in spots
San Mateo.....	Menlo	Fair
Menlo.....	Mayfield	Semi-rough
Mountain View.....	Madrone.....	Fair
Madrone.....	Morgan Hill.....	Semi-rough
Morgan Hill.....	San Martin.....	Fair
San Martin.....	San Juan.....	Good
San Juan.....	Salinas	Fair

The San Juan grade is encountered between San Juan and Salinas. The grade on the north side is three-quarters of a mile long over the steepest parts and on the south side 1 1-4 miles. The grades range from 5 per cent. to 18 per cent.

SECOND DAY—SALINAS TO SAN LUIS OBISPO, 148 3-4 MILES.

From	To	Road Condition.
Salinas.....	Gonzales	Fair
Gonzales.....	King City.....	All kinds in short stretches
King City.....	Jolon.....	Good
Jolon.....	Bradley.....	Good but dusty
Bradley.....	Paso Robles.....	Good, except fording Salinas River.
(Salinas River)		
Paso Robles.....	San Luis Obispo.....	Fair, rough in spots, dusty, some sand

King City is 1 3-4 miles off the main road (opposite side Salinas River, crossed by bridge), but it is advisable to include this point, as it is the first town of any importance after leaving Salinas and there is no other point until Jolon is reached. A short distance beyond King City the road branches and is unmarked. Take road nearest river.

Between King City and Jolon the Jolon grade is encountered. It is about 1 1-4 miles to the summit (not measured), and grades run from 8 per cent. to 12 per cent.

About five miles below Bradley the bed of the Salinas River is crossed (dry at this season of the year), and the sand is quite deep for a distance of about 400 feet. Between Santa Margarita and San Luis Obispo the Cuesta grade, several miles long, is encountered, the grades varying from 8 per cent. to 12 per cent.

THIRD DAY—SAN LUIS OBISPO TO SANTA BARBARA, 130 1-4 MILES.

From	To	Road Condition.
San Luis Obispo.....	Arroyo Grande.....	Rough—sand
Arroyo Grande.....	Nipomo.....	Rough—fair
Nipomo.....	Santa Maria.....	Good
(Santa Maria River.)		
Santa Maria.....	Garey.....	Semi-rough
Garey.....	Gaviota.....	Fair—good—fair
Gaviota.....	Naples.....	Good
Naples.....	Santa Barbara.....	Fair—dusty

Approaching Santa Maria the bed of the Santa Maria River is crossed (dry at this season of the year), and there is considerable deep sand, but by keeping to the side little difficulty is encountered.

It is not necessary to go *via* Santa Ynez and about four miles can be saved, but it is advised to do so on account of blacksmith shop, there being no other until Goeleta (35 1-2 miles) is reached.

The run must be made *via* the Santa Ynez-Gaviota Pass, the other and shorter mountain road to Santa Barbara being closed to automobiles. The Santa Ynez-Gaviota Pass is several miles long, with grades varying from 8 per cent. to 12 per cent.

The road reaches the Pacific Ocean at Gaviota and runs on an overhanging bluff along the ocean to Naples, a distance of about seventeen miles. This bluff is crossed by numerous washes from the mountains and the road drops rather steeply in and out of these washes with short grades of from 8 per cent. to 20 per cent.

FOURTH DAY—SANTA BARBARA, 117 1-8 MILES.

From	To	Road Condition.
Santa Barbara.....	Ventura.....	Fair—good
Ventura.....	New Jerusalem.....	Semi-rough
New Jerusalem.....	Calabasas.....	Fair
Calabasas.....	Hollywood.....	Rough—fair
Hollywood.....	Los Angeles.....	Fair—good

At Carpinteria the road leaves the ocean and turns towards the mountains and travel is *via* the Casitas Pass for many miles. Two mountain ranges are crossed with grades running from 8 per cent. to 16 per cent., and numerous small streams are forded. Emerging from the Casitas pass, follow the right-hand road to Ventura.

From New Jerusalem to Hollywood, a distance of about 6 1-2 miles *via* the "old grade," no place of importance is passed and no supplies save water are to be had. From New Jerusalem to Calabasas the road is through the Conejo Pass. The grades are not very long, but are steep in places, the highest grade reading of the trip—22 per cent.—being here encountered. The general run of the grades is, however, from 8 per cent. to 16 per cent.

Mr. Lowe's run was made *via* the "old grade," but there is a new grade through the Conejo country said to be much easier and several miles shorter, which was missed owing to a misleading signboard.

Hollywood is a suburb of Los Angeles.

Conejo is called a grade and by others a pass.

Again, some farmers refer to the grades and passes as "roads," and they are sometimes given the names of the towns which they approach. In seeking advice it was generally found best to merely ask the direction to the next town on the route.

As a rule, horses do not act badly and but little trouble is encountered from that source. When driven by women, however, it is generally necessary to lend assistance, as women seem to lack faith in all three—the horse, the automobile and themselves.

There are good hotels in the principal towns, and usually a small country hotel in the towns named.

The people met along the route are obliging and courteous, and seem to take much interest in automobiles.

A good substantial linen duster was found very useful—in fact, almost necessary—and an ordinary sunbonnet was also tried and found excellent as a protection against sunburn, while the shield on the back acted as an excellent protector against dust, which finds a ready resting place in one's hair.

Details of road conditions and route directions, as compiled by Mr. Lowe, are given in the accompanying table.

PROGRAM OF CLEVELAND MEET.

Entry blanks were issued last week for the third annual race meet of the Cleveland Automobile Club, to be held at Glenville track Friday and Saturday, August 19 and 20. Prizes, which will be sterling cups valued at from \$75 to \$200, will be awarded only to winners of first places. Entries close Aug. 17 with George Collister, 317 Superior street, Cleveland. A rule that might be followed with advantage at other meets is one requiring contestants to congregate in the "cooling-out" shed, where stalls will be assigned to them and where they must remain until called by the clerk of the course, who will make no call elsewhere. Following is the program of events:

August 19—One-hundred-yard obstacle race, two-mile race for stock runabouts, five-mile race for manufacturers' challenge cup (Diamond Rubber Co.), open to manufacturers and their representatives and to become the property of any manufacturer who wins it three times; two miles for electrics, five-mile open handicap with standing start and a handicap limit of three-quarters of a mile; two-mile open for motorcycles, five-mile open for stock touring cars stripped (classes 1 and 2), record trials.

August 20—One-mile open in heats for classes 1 and 2, five miles for electrics, five miles for touring cars with full road equipment and three passengers in addition to driver, ten-mile open handicap, five-mile motorcycle handicap, five-mile open for regular stock standard touring cars stripped (classes 1 and 2), ten-mile open, and record trials.

The Glenville track at Cleveland is one of the best and fastest mile ovals in the country.

START OF THE A. A. A. TOUR TO SAINT LOUIS.

SIXTEEN automobiles, carrying two score intrepid tourists, started from New York on the first stage of the St. Louis tour on Monday morning, July 25, looking as if they were prepared for anything that could possibly happen. The scene of the start was at Fifty-eighth Street and Fifth Avenue, in front of the rooms of the Automobile Club of America, and a crowd of spectators gathered to see the machines sent off, though, judging from the curious remarks made by some, the real meaning of the affair was not well understood outside the ranks of the automobilists and those directly or indirectly interested in automobile matters. There seemed to be an impression about that a parade was being

way one linen-dusted and goggled tourist expressed himself, "And it will be a big bust that we're not prepared to take care of on the road." He was about right, as well as could be judged from the appearance of his outfit, and the same might be said of every one of the starters. Spare tires, tool boxes, side hampers filled with everything experience and forethought could suggest, machinery protected by rubber aprons, covers for the cars themselves were the rule. But only one man was sufficiently oblivious to public opinion—or was it an inadvertency?—to leave in plain sight a sturdy looking block and tackle, which looked as if it had at some time done something more than repose on the floor of the

until 9.30 A. M., when Augustus Post, chairman of the touring committee of the American Automobile Association, which has had charge of the preliminary work for the tour, swung out into Fifth avenue, his red colored White gliding noiselessly away at the head of the column. Three other Whites followed close at his heels—or his rear tires?—keeping close together after the fashion of Whites, and the other cars fell in just as they pleased, true to the spirit of the tour, which is intended to be "go-as-you-please" in every respect, with the object of extracting from it just as much healthful pleasure as can be squeezed out. There was one car whose occupants will have more thought for business than pleas-

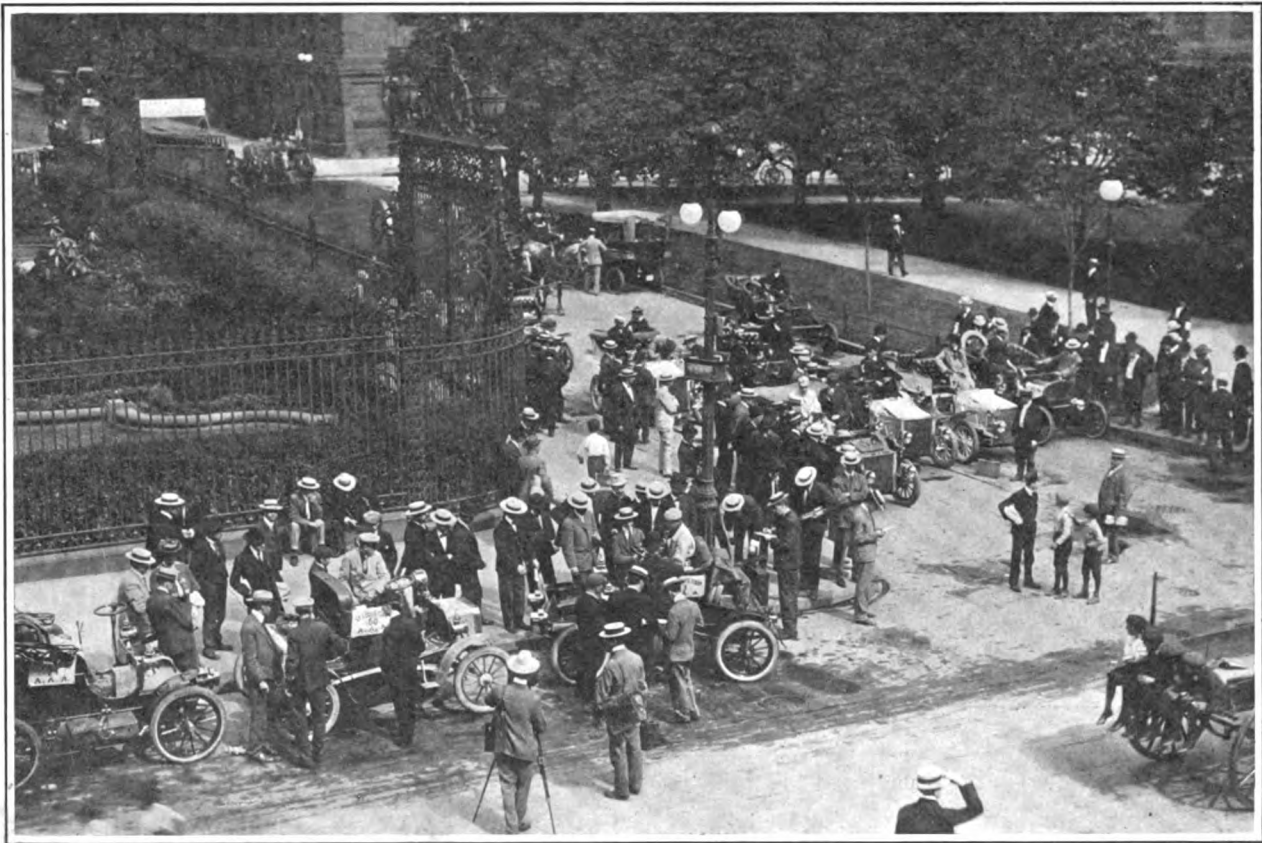

SCENE AT THE START FROM THE PLAZA, NEW YORK, AS VIEWED FROM THE AUTOMOBILE CLUB OF AMERICA.

organized, and next in popularity was the guess that an endurance run was commencing.

Certainly the scene was a bright one. It was evident that most of the cars had been cleaned and polished with special care, and they presented a most attractive appearance lined up ready for the word that was to start them on their 1,350-mile journey. A noticeable thing was the diversity of types of machines entered for the tour. The big tonneau car did not by any means have the whole stage. The smaller cars were considerably in evidence, and the light tonneau will probably get a pretty thorough trying out before St. Louis is reached. "St. Louis or bust" was the determined

car. And if that is the only block and tackle in the party, doubtless it will see real service before it gets through.

The weather was as nearly perfect as the average automobilist could wish. Light clouds floated between the sun and the automobilists, breaking through occasionally just to relieve the monotony and give the camera men half a chance. The temperature was neither too high nor too low, and the light, but continuous, rain of the previous day had effectually laid the dust of the roads. In fact, the rain was rather too generous, the roads being somewhat muddy.

The start had been scheduled for 9 A. M., and automobiles began to gather shortly after 8 o'clock, coming in one at a time

ure, and who must ever be on the alert for trouble. This is the Darracq driven by F. A. La Roche, who started with the intention of making the run through to St. Louis without stopping the motor.

To the interested and informed spectator there were some cars that attracted especial interest for various reasons. Some of the machines are old and tried tourists, and others are about to undergo their trial under ordinary road conditions, which means mud and water and dust and other things with which the touring automobilist is only too familiar. Most conspicuous among these was the huge Peerless special touring car with 70-horsepower motor under a hood of enormous length—the biggest car

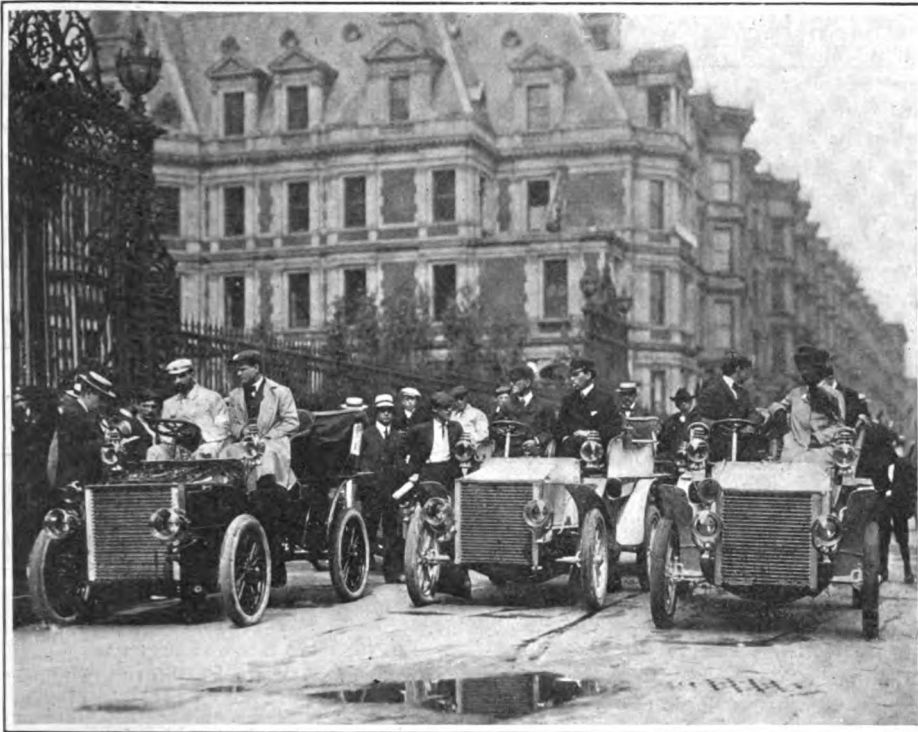

WHITE STEAMERS READY TO START FROM THE PLAZA AT CENTRAL PARK, NEW YORK.
Augustus Post at Wheel of Car on Right of Line.

starting from New York. Six occupants looked as if they had room to walk around without scraping elbows. The new Oldsmobile tonneau looked bright and clean, spick and span, innocent of knowledge of what lay before it. Its progress will be watched with interest, as this is its first public performance of the kind. A 16-horsepower Yale touring car is equipped with solid rubber tires, giving the passengers assurance that, whatever else may happen, they will not be troubled by punctures. There is no lack of features whose testing out will be of deep interest to the mechanically inclined.

As the cars of the tourists moved off they were accompanied by an escort of some twenty "stay-at-homes." A very noticeable point, and one particularly striking to any one who had seen a considerable number of automobiles running together a couple of years ago, was the exceedingly smooth and quiet running of the motors. The entire chorus might easily have been drowned out by the clatter of one of the large machines of two or three years ago. This quiet running caused some comment, one skeptic, however, voicing the opinion that it would only last till brass buttons were out of sight, when the drivers would "open 'em up!"

A list of the cars that started from New York will be found on page 113.

Though they said but little, the officials were somewhat disappointed at the small number of starters, and considerable comment was indulged in by others concerning the number of able-bodied cars that stayed at home. The send-off was not quite what was expected; but all made the best of it and turned their attention to thankful contemplation of the weather. That was doing

the best it could anyway. The total number of entries received up to the day before the start was sixty-one, and it seems just a little ironical that the same figures, transposed, stand for the number of actual starters. Half an hour before the start a telegram was received by Mr. Post from Charles J. Glidden, Boston, the globe-trotting tourist, in the following words:

"New England Division happy; will embrace you all at Albany."

One of the unexpected starters was Joseph Wilkins, of Omaha, an enthusiastic automobilist who just arrived in New York,

after a four weeks' trip in his car from Nebraska. He immediately joined the party to make the return journey. Mr. Wilkins said that many of the Western roads were in bad shape and he expected the tourists would encounter trouble before completing the journey.

On Tuesday a few belated cars started which were unable to get off Monday with the "bunch." Mrs. Susan D. Malpas was one of the starters and it was her intention to overtake the main party on the road, with her 24 horsepower Panhard. Dr. W. J. Morton, who started Tuesday in an Autocar, will take things easy, not attempting to catch the others, but journeying entirely at the dictates of his own inclinations. Eugene Hale also started on Tuesday in a Knox. James L. Breese will join the tourists at Buffalo.

Last week the American Automobile Association sent out the following letter by President Whipple to intending participants in the run:

The American Automobile Association wishes to call the particular attention of the participants in the St. Louis run to the matter of their conduct in driving their machines during the run. The interests of thousands of people who ordinarily would not notice us will on this occasion be directed to our performance. We want you to join loyally with us in being particularly careful during this run in the way in which you meet and pass teams, in avoiding racing and in the way in which you observe the speed laws of the different cities and towns through which we pass. We wish to warn you that any car that is convicted of flagrant violations of the rights of others on the road, or of speed laws, will be disqualified and will not receive a certificate.

We believe that careful attention to one and all of these regulations will do the cause of automobilism more good than anything else we can do, and we know that you will want to aid us in accomplishing this result.

You must remember that the eyes of the entire public are on us in this tour.



BUCKMOBILE EQUIPPED FOR TOURING WAITING FOR THE START FROM NEW YORK.

With the Boston Contingent.

SPRINGFIELD, Mass., July 25.—There was little of parade or ceremony about the start of the Boston contingent of the St. Louis tour this morning. Five cars destined, according to the hopes of their owners, to arrive sixteen days hence in St. Louis, lined up at 9 a.m. before the Massachusetts Automobile Club's home on Boylston street, submitted with their occupants to be photographed, and started off through a gray fog, over streets as slippery as wet asphalt and macadam can be. Perhaps two dozen spectators went to or paused at that point long enough to see them off. Of these were several newspaper men, one or two of whom have been actively engaged in helping the work of the tour along, and who now bade a hearty farewell to the local representatives in the great event.

The little band was headed by President Whipple, of the A. A. A., and Mrs. Whipple, who registered from Andover and were accompanied by a chauffeur. Another notable member was Charles J. Glidden, international tourist and prospective donor of the Glidden cup. Mr. Glidden was accompanied by his wife and mechanic, and drove a long and rakish-looking green 24-horsepower Napier, fitted with a Cape cart hood. Mr. Whipple drove a Mercedes of 20-horsepower. President Elliott, of the Massachusetts A. C., accompanied by a chauffeur and driving his familiar White steamer, made the third active member; the fourth was H. Frederick Lesh, of Boston, accompanied by his wife, Mrs. W. F. Camp, of Morganton, N. C., Ralph McLellan, of Boston, and a chauffeur. Mr. Lesh drove a Pope-Toledo, and his party of five was the largest in the Boston section. Last to start was the Pierce *Great Arrow* car which participated in the Mount Washington Climb to the Clouds and the White Mountains tour. It was driven by Percy P. Pierce, and carried as passengers George Ulrich, whose mission it is to help other Pierce cars on the run out of possible trouble, and the writer.

Besides the tourists bound for St. Louis, there were several others who planned to go short distances. Chief of these was George Otis Draper, who, in his 1904 Packard, is bound as far as Albany. R. R. Ross, connected with the Packard agency, accompanied the tourists to Worcester.

Number 51 (Pierce Arrow) started about twenty minutes after the others, and did not overtake them before reaching Worcester. No effort at speed was made, the forty-five miles being traversed in a little more than two and one-half hours. There is certainly something very confusing about the roads from South Framingham to Northboro. Two years ago, in the New York-Boston reliability run, the whole procession missed the road on account of insufficient directions. Mr. Pierce declared that he had taken a wrong turn in a trip not long

ago; and today we somehow got off the road while to all appearances following the road directions. What was more curious, the directions continued seemingly to fit the wrong road, and after a time we fell in with the right road again, all without having retraced any of our course. But for missing the tire marks of our predecessors, we should hardly have known that we had gone astray.

Save for that small incident, the morning's run was uneventful. Nearly all the roads were in splendid shape except in certain towns, such as Natick, where the macadam had two inches of mud on top. Even the dirt roads through Southboro and vicinity were too gravelly to be very wet.

At Worcester the Worcester Automobile Club entertained the tourists and itself with an excellent dinner at the State Mutual restaurant, after which President Asa Goddard, of the Worcester club, paid his respects to the time-honored custom of after-dinner "vocal exercises," and prevailed upon Messrs. Whipple, Lee, and Glidden, and ex-President Julian A. Chase, of the A. A. A., to do the same to the extent of about two minutes each. As none of the cars in that section of the tour could be called exactly slow, there was appreciably more leisure for the amenities of life than in the endurance runs. However, the distinguished guests managed to break away from their hospitable entertainers shortly after 2 o'clock, most of them starting at 2:20.

We had fifty miles ahead of us, the first half over very fine roads, much of the second half over very indifferent dirt roads. As we wanted to get to Springfield in good season, we made what speed there was opportunity for without overdriving. The roads beyond Worcester are with few exceptions magnificent. They are not wide, but they are smooth and little traveled, and today were just damp enough to be firm. Mr. Pierce did not drive "all out," as our English cousins say, except to rush a hill. On Leicester Hill, for the only time in the day—except in starting—the first speed was used. The hill has a grade of, I believe, about 12 per cent., and was very muddy, but the engine did not hesitate at it in the slightest. Indeed, the indifference of a 24-horsepower motor to mud, dirt, and sand that would compel the operator of a smaller car to nurse his machine carefully is one of the most impressive things about such a machine. A road that would seem desperately rough to a small car is thought little of with 34-inch wheels and the power to push them.

Beyond Leicester the roads for some miles were of splendid macadam, dry and nearly deserted, with long straight stretches where we could and did put the car to the limit of its speed. I was surprised, however, to find that unavoidable periods of slow going,

on the hills and through the villages, kept our average down to little more than twenty miles an hour.

Have you ever heard of Podunk? To the whereabouts of this celebrated community I shall never again confess ignorance. It is about three miles off the route of the tour, between Brookfield and East Brookfield.

The sun now began to appear in glimpses through the clouds. We were skimming along the southern edge of a beautiful valley, with alternating hayfields and pastures to the right and wooded hills to the left. In one of the few cultivated spots on the hills we passed a group of farmers gathering their annual crops of stones.

The feature of West Warren, which I shall remember longest was a tiny triangle—about thirty feet long—of grass in the fork of a road, with a stone curb around it, and at least half a dozen signs admonishing the crossroads public to "Keep off the Park."

Just beyond West Warren we bade farewell to the macadam, and began to take the medicine of which the Boston run two years ago had given us a vivid memory. Doubtless we shall get much worse roads, but these were bad enough to discourage speed. Abrupt wooded hills rose on either hand, and the road, now a slim embowered dirt track, writhed and undulated by the stream, and was sprinkled freely with "chuck holes" full of water and of uncertain depth.

Mr. Whipple overtook us as we were approaching Palmer, through which we had two or three miles of level macadam. His car appeared to be scarcely the equal of ours on the hills, but perceptibly better on the level. Pierce was manifestly reluctant to concede it the faster machine's privilege of passing, but in Palmer Mr. Whipple took another turn, and had slipped passed us before Pierce knew what had happened. We overtook him again among the hills, and I admired the *sang froid* with which, trying to shake us off, he drove his car full tilt through chuck holes, bouncing his young mechanic half out of the tonneau. I also admired the Mercedes springs, but a little later it seemed that the weakest part was elsewhere, for a front tire went "bang," and we left them preparing to replace it.

Approaching Springfield we had magnificent roads again. Lest the grueling encounters to come should lead me foolishly to proclaim some respectable western road the best I ever saw, let me here record my firm conviction that no roads, with simple crushed stone as material, could possibly be better than many of the Massachusetts roads which have made to-day's run so delightful. They were perfect, "that's all."

HERBERT L. TOWLE.

ARRIVAL IN POUGHKEEPSIE.

Special Correspondence.

POUGHKEEPSIE, N. Y., July 25.—Sixteen cars, all that started from New York, arrived here this afternoon and evening and fifteen drivers registered on the official slip,

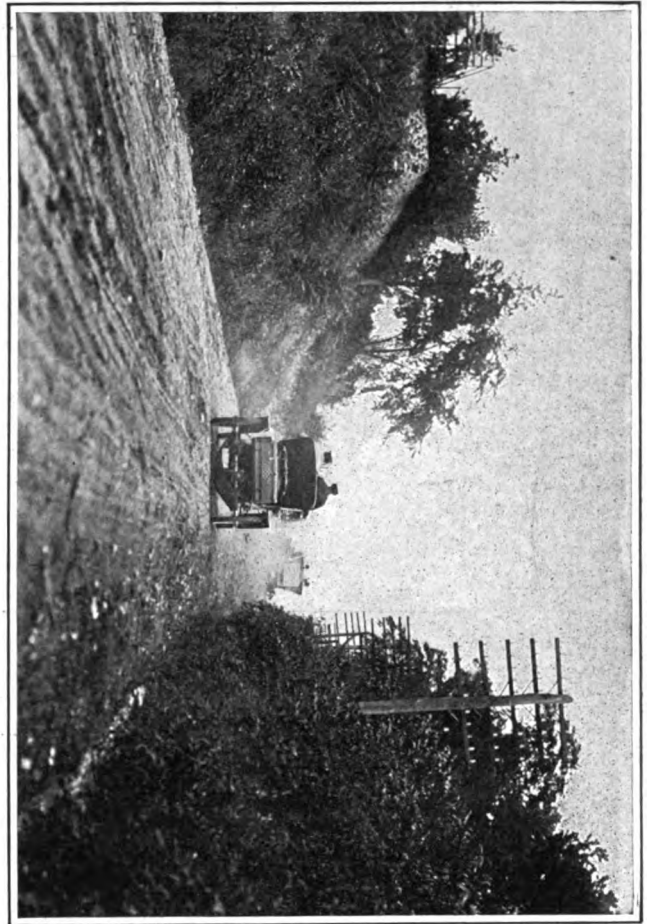

Ascending the Hill into Peekskill, the Noon Stop on the First Day.

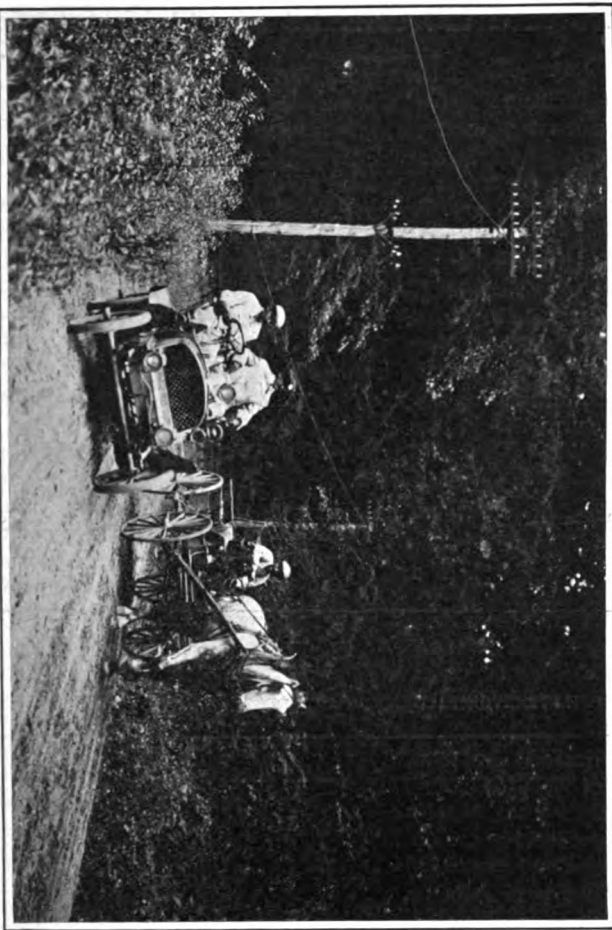

Swinging into the Ditch on a Turn to Pass a Plodding Horse. MEMBERS OF THE NEW YORK CONTINGENT AT THE START AND ON THE ROAD TO Poughkeepsie, New York.

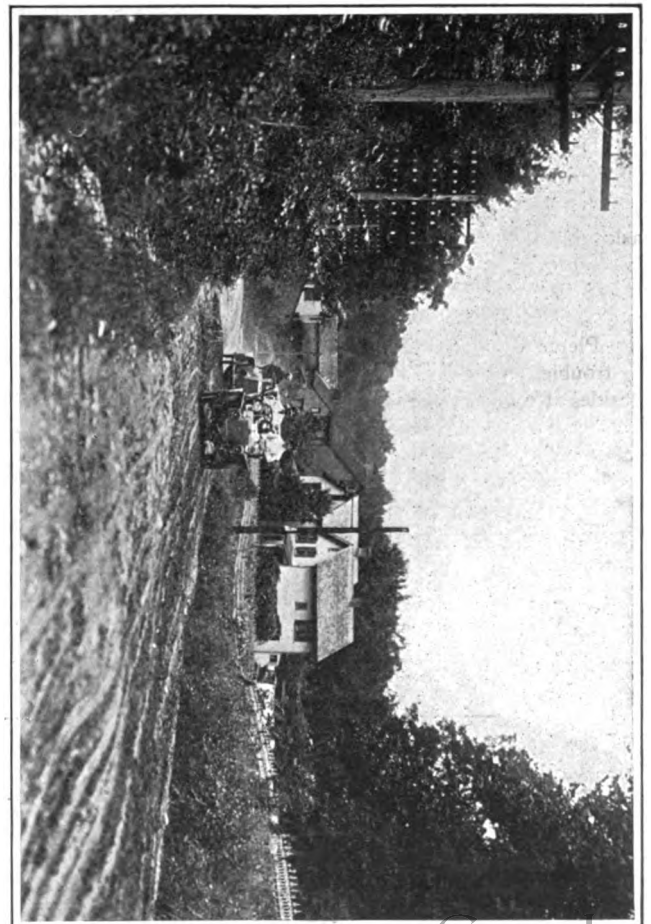

Approaching Peekskill, F. A. LaRoche Leading in His Non-Stop Through Run.



Mr. and Mrs. Williams Starting in the Run After Finishing Tour from Omaha. IN THE AMERICAN AUTOMOBILE ASSOCIATION TOUR TO ST. LOUIS.

New Yorkers and Bostonians Meet at Albany.

Special Correspondence.

which opened for registration at 7.30 p. m. and remained open until 10.30. One, F. A. LaRoche, driving his Darracq, passed through Poughkeepsie at about 3 p. m., several hours before the official control opened. He did not stop long, but pushed on to Albany in his non-stop run attempt.

The roads for the first stage of the journey were somewhat muddy, but later in the day the warm sun dried them partially and made the going better. No mishaps were reported with the exception of a sharp skirmish between LaRoche's machine and a trolley car at Yonkers, in which the latter was left fenderless and the former suffered injury to its headlight, but continued on its way quite without stopping. The Elmore *Pathfinder*, which is now making its second trip over the St. Louis tour route, had three punctures on the way.

As this is in no sense a race, place counting for nothing, no mention will be made of the order in which the cars arrived, only the record on the score-card of the officials in charge of the controls being taken. Here is the official list of those who started from New York with the object of driving the entire distance to St. Louis: Augustus Post, New York; C. H. Gillette, New York; R. D. Lillibridge, New York; C. W. Berchwood, Kokomo; A. D. McLaughlan, Cleveland; B. C. Swinehart, New York; C. H. Page, New York; Albert L. Pope, New York; H. C. Esselstyn, New York; Megargel Brothers, Rochester; A. G. Seaton, Utica; W. B. Hurlburt, Detroit; Robt. B. Scott, Cleveland; F. Ed. Sponer, New York; Webb Jay, Cleveland.

ENTHUSIASM IN BALTIMORE.

Special Correspondence.

BALTIMORE, July 26.—Present indications are that ten or fifteen automobiles will be in line when the Baltimore Division starts for St. Louis Friday morning at 9 o'clock. Some of these tourists may not go beyond Wheeling, but a representative number undoubtedly will keep on to Columbus, where they expect to meet the Central Division on August 5, and thence to the Exposition City.

Now that the time is so close at hand, enthusiasm, which heretofore has been rather insignificant, is growing rapidly, and the subject of the tour, the benefits to be derived from it and the practical lessons it will teach are being discussed. A member of the Automobile Club said yesterday:

"If our city had escaped the great fire which devastated its busiest section and rendered close attention to business so necessary, I firmly believe that Baltimore would have sent away fully a hundred machines. And this in spite of the many difficulties in the way of bad roads, worse laws and lack of repairing facilities at the stops this side of Pittsburg. Until yesterday I wasn't certain that I could go. I feel that I will enjoy the trip immensely."

In the absence of R. P. Scott, the arrangements are in the hands of George S. Dickey, a member of the Baltimore committee.

ALBANY, July 26.—Without serious mishap the New York and Boston sections of the American Automobile Association tour to St. Louis reached the Albany control this afternoon, and by evening all but two of the touring cars had reported and five minutes later the big 70-horsepower Peerless (No. 14) driven by R. P. Scott and with C. S. Scott, R. P. Wauson, of Baltimore, Emerson Brooks, of New York, and George Behrens, engineer, aboard, came tooting along Broadway and turned into State street. This car is to be delivered to President H. W. Whipple, of the A. A. A., at St. Louis.

No attempt at fast driving or racing was made and no times of arrival were taken. A. L. Pope, driving a Pope-Toledo, with A. W. Pope and Engineer George Soules aboard, reached the Ten Eyck about 12.30 p. m., closely followed by F. Ed. Sponer and D. B. Huss in the Oldsmobile tonneau, which arrived at 12.40 p. m., having left Poughkeepsie at 8.05 a. m.

Before the first car arrived, Assistant Secretary A. B. Tucker, of New York, and M. L. Downs, came by train from Poughkeepsie to see that all arrangements were made for the accommodation and entertainment of the tourists. They were soon in consultation with President W. E. Milbank and Secretary O. A. Quayle, of the Automobile Club of Albany, and the local club's escort committee, consisting of F. S. Howell, Frank Fisk, Jr., and John Newall was sent out to Schodack Centre, where the Boston and New York post-roads converge, to pilot the tourists through Brookview. Confetti was scattered to mark the route. The first of the tourists arrived at Albany before the escort committee reached the junction point.

President Milbank and Secretary Quayle, with other members of the local club, remained in or near the Ten Eyck all the afternoon to aid the representatives of the association in receiving and directing the tourists. Members of the local committee and the tour officials wore broad blue satin ribbons, with the initials of the association and "St. Louis Tour" stamped thereon, while each tourist received a similar badge in white. Cap badges of the A. A. A. were worn and each tourist was given either a card of admission to the Albany Club across the street from the hotel or to the Country Club. There was no formal entertainment of the visitors. Some spent the afternoon and evening quietly about the hotel; some went to the Albany Club, and a few who were not afraid of the threatening rain in the evening were taken out to the Country Club.

The tourists' cars were stored at the Lucey-Taylor Auto. Co.'s and R. Robinson's garages. Fire Chief Higgins visited the stations in the early evening and directed that doors and windows be kept open to

allow the gasoline vapor from the many machines to escape.

Those who were seated around the hotel here at about 8 o'clock were startled by hearing the fire bells, and when an excited man rushed up and said that the garage was afire there was a stampede up the street toward the blaze now plainly visible from the hotel steps. It proved to be a livery stable two blocks above the garage and once more the tourists breathed easily. However, most of them went to the garage and took a last look at their machines before retiring for the night. The garage was so jammed with automobiles that had a fire occurred not one-tenth of them could have been rescued. Such a calamity would end the tour on the spot.

As usual, at the start from Poughkeepsie there was more or less racing, which was kept up between the big machines. There was also a great desire to make Albany before the Boston contingent, which led even some of the little cars to get early starts and hustle through. So great was this desire to make Albany that only two cars stopped for dinner at Hudson, the place designated on the official route card as the noon stop, and the good things prepared for the tourists by the landlord of the Hotel Worth still remain on his hands.

The roads were in excellent condition, although several sharp turns might have caused some trouble had they been negotiated at a very fast pace. The Albany Automobile Club officials went down the line to meet the tourists and each car and its occupants were showered with *confetti* as they came up.

The farmers along the road all took a holiday on Tuesday and incidently invited in their neighbors who lived off the main road. Houses and grounds were decorated with flags and bunting in many cases and apples, flowers and cheers greeted the automobilists all along the line.

Of course, on a run of this kind, while plenty of time is allowed to make each control, nobody cares to stop for any length of time along the road. There was an exception to this rule on Tuesday, for two very pretty girls seated in an orchard along the roadside and surrounded by novels and apples caused more stops (for adjustments of engines and oiling, of course) than were really necessary; and the best of it was that the tourists in each car thought that they were the only ones until notes were compared at the hotel in Albany, when it was found that the two girls had the names and addresses of about half the party and had promised to write, while a number of pictures were taken with the girls not always in the background.

There were only minor troubles on the road, such as the breaking of an exhaust valve on the Pope-Hartford which carried Secretary C. H. Gillette, of the A. A. A.,

and wife, near Hudson. H. C. Esselstyn came along, however, and gave assistance. Webb Jay ran over a dog, the machinery taking part of the hair and hide off the animal, which bolted yelping down the road. It is told of Jay that, desiring to fill the water tank of his steamer, he drove into a farmyard and was about to help himself when a woman appeared and objected. Webb politely but earnestly told her that he must have the water at once or the machine would blow up and he advised her to get out of harm's way immediately. The woman retired precipitately while Jay filled the tank and prevented the catastrophe.

About two miles south of Hudson Ray D. Lillibridge, of New York, was stopped by a farmer, who rushed out and explained that a man working with him had bored an auger into his finger and was losing blood rapidly and there was no doctor nearer than Hudson. Lillibridge at once dropped one of his passengers to take the next car behind, and taking the injured man into his own car rushed him to the hospital in Hudson in record time.

B. C. Swinehart, in a 16-horsepower Yale, had the only disabling accident. A piece of steel left in the bottom of the carriage at the factory bounced around until it lodged in the gears and stripped them. This occurred about twelve miles south of Hudson. The gears will be replaced and the car shipped on ahead to join the party farther on.

President Elliot C. Lee, of the Massachusetts State Automobile Association, who had intended to come on to Albany, decided to quit on the other side of the Shaker Mountain at the border of New York State. He sent his engineer on, but took his car, a White steamer, back with him.

Dr. W. E. Milbank, of Albany, who was entered with his 8-horsepower Knox, decided on account of his recent illness not to join the run at this point.

While the tourists were idling about the Ten Eyck in the afternoon an animated discussion arose over the new movement to get rid of the numerous French automobile terms. The general sentiment appeared to be in favor of the adoption of plain English terms, and Charles J. Glidden said that during the recent Climb to the Clouds a proclamation had been issued from the summit of Mt. Washington which called for the complete abolition of the French word "chauffeur" and the use of "engineer" for "mechanician," "motor car" for "automobile," "motorist" for "automobilist" and "motor-house" for "garage." This pleased the majority, and later the word "engineer" was heard everywhere and "motor-house" was the direction given to the arrivals.

While waiting for the arrivals Messrs. Tucker and Quayle secured a message from Mayor Gaus which Secretary Post, of the National Tour Committee, will deliver to Hon. Rolla Wells, Mayor of St. Louis. Mr. Quayle made the trip to New York Monday to get a message from Governor Odell

and was promised one by Secretary Graham.

F. A. La Roche came through Albany about 9 p. m. Monday night and started on to Utica at 9.25 p. m. He registered at the Ten Eyck and was reported at Utica this morning at 9.15 o'clock, his motor not yet having stopped. Norris Mason and H. H. Everett are the official observers and L. A. Blank is to assist in operating. Mr. Everett joined the party here Monday night.

A representative of the Black Diamond Automobile Co., of Utica, came to Albany

and posted an invitation to all the tourists to avail themselves while in Utica of the facilities of the Buckmobile factory.

H. W. Smith, of Syracuse, also came on to greet the tourists. He is a member of the A. A. A. tour committee, and has charge of the arrangements for the reception of the tourists at Syracuse, where the Thursday night stop will be made.

Most of the motorists left orders for a start Wednesday morning at 8 o'clock.

The run will be to Utica, where an all night stop is to be made.

Starters from New York and New England.

No.	Car.	Horsepower.	Occupants.
1	Mercedes	20-27	Harlan W. Whipple, president of the American Automobile Association; Mrs. Whipple and C. J. Donohue, engineer.
3	Pope-Hartford	10	C. H. Gillette and Mrs. Gillette.
4	White	15	Carl Paige, driver; M. R. Green, mechanic; M. H. Newton.
10	White	10	Augustus Post, driver; J. R. Thompson, mechanic.
14	Peerless, special touring car	70	R. P. Wausson, driver; George Behrens, mechanic; R. B. Scott and C. S. Scott, Baltimore, and Emerson Brooks and George B. Adams, New York, passengers.
15	Napier	24	C. J. Glidden, of Boston; Mrs. Glidden and Charles Thomas, of London, engineer.
21	Pope-Toledo	21-24	H. Frederick Lesh, of Boston; H. F. Lesh, Mrs. Camp, Ralph McClellan and J. R. Darling, engineer.
24	Haynes-Apperson	12	C. W. Birchwood, driver; George H. Kauffman, passenger.
30	White		George H. Lowe, of Boston; W. G. Schamp and H. G. Reynolds.
31	White	10	Ray D. Lillibridge, driver; W. E. Sonnasteine, mechanic; Miss Laura Lillibridge, passenger.
32	White	10	Webb Jay, driver; C.E. Denzer, mechanic.
34	Elmore "Pathfinder"	15	Percy Megargel and R. G. Megargel.
38	Cadillac	8 1-2	W. C. Hurlburt, of New York; J. Wetmore and John Speck, engineer.
39	Columbia	24	F. N. Manross, of Forrestville, Conn.; R. H. Manross, W. W. Horton and H. A. Warner, engineer.
42	Darracq	15	F. A. La Roche, driver; A. Le Blon, alternating driver; Norris Mason, observer; H. H. Everets, alternating observer; Lee Strauss, passenger.
46	Packard	22	George Otis Draper, of Hopedale, Mass.; with two passengers.
47	Franklin	10	H. C. Esselstyn, driver; John Gerrie and G. J. Bradley, passengers.
50	Panhard	24	James M. Waters, driver, and E. B. Gitchel, engineer.
51	Pierce Arrow	24	Percy P. Pierce, H. L. Towle and George Ulrich, engineer.
53	Oldsmobile	10	D. B. Huss, driver, and F. E. Spooner.
55	Pope-Hartford	10	Harold L Pope, with two passengers.
56	Panhard	24	Mrs. Susan D. Malpass, with five passengers.
58	Yale	16	B. C. Swinehart, driver; Lazarneck, passenger.
59	Pope-Toledo	24	George Soules, driver; A. L. Pope and A. W. Pope, passengers.
60	Buckmobile	12	A. J. Seaton and J. W. Seaton.
61	Royal	20	A. D. McLachlin, driver; A. C. Walker, mechanic; George H. Bowler, passenger.
77	Phelps	15	F. W. Richards, of Boston; Mrs. Richards and Walter Killam, engineer.

DINES IN SYRACUSE.

LaRoche Arrives at 2.45 Tuesday Afternoon, Over Miserable Roads.

Special Correspondence.

SYRACUSE, July 26.—The first warm food that passed the lips of F. A. LaRoche from the time he left New York Monday morning on his record seeking non-stop run to St. Louis, he ate from a tray as he paused here this afternoon in front of the Yates Hotel in the sight of several hundreds of spectators.

A large party of local automobilists were on hand to greet him. Gasoline had been provided by N. A. Mason and Lee Straus, of New York, who are in charge of the arrangements for the trip.

To the representative of THE AUTOMOBILE, Mr. LaRoche said:

"From Albany to Utica in the Mohawk Valley, the roads were positively the worst I have ever encountered and I have traveled a great deal in this country by automobile. Last night it rained and rained and at times I thought that we would be unable to get farther, as the wheels of the car were up to the hubs in mud. I can keep my engines going for a month if necessary, but it is not very pleasant to be caught some place without being able to extricate the machine."

All the time he talked, LaRoche kept eating from the well filled tray, stating that the unfavorable circumstances could not keep him from making the most of a square meal.

LaRoche arrived here at 2.45 o'clock and left at 2.55 for Rochester, where he expected to be relieved. From there he said he would go by train to Erie, Pa., and there resume the wheel when his machine came through.

Special Telegram.

FREDONIA, N. Y., July 27.—LaRoche, at the wheel, passed through Fredonia at 7:10 P.M.

FOUR ENTRIES IN CLEVELAND.

Special Correspondence.

CLEVELAND, July 26.—The number of entries for the Cleveland contingent on the St. Louis tour is proving somewhat of a disappointment. Although it is understood that several others will probably decide to take part, thus far only the names of J. R. Blakeslee, Dr. W. H. Gifford, Fred Gates and George S. Waite have been sent in. Mr. Waite, who is in charge of the division from Cleveland to South Bend, has completed all his arrangements.

The Cleveland Automobile Club will hold open house while the participants are here, and the A. A. A. headquarters will be in the club rooms in the Hollenden Hotel. Members of the club have been delegated to meet the participants several miles out of the city and escort them to the club. There will be no official garage, as originally planned, as it was found impossible to secure the use of Central Armory. In conse-

quence the participants' cars will be taken care of at the downtown garages.

No entertainments have been arranged. Mr. Waite deciding that the tourists would prefer being left to follow their own inclinations during their short stay in the city.

Two pilot cars scattering *confetti* will leave Erie Tuesday morning, reaching Cleveland in the evening, and Wednesday morning Mr. Waite, in charge of two cars, will go to Toledo and then on to South Bend, carrying on the *confetti* trail.

AN ESCORT FROM ROCHESTER.

Special Correspondence.

ROCHESTER, July 25.—Automobilists and others here are looking forward with no little interest to next Friday night, at which time the touring automobilists *en route* to the World's Fair will arrive and spend the night here. The following gentlemen have been appointed by the Rochester Automobile Club to act as a reception and entertainment

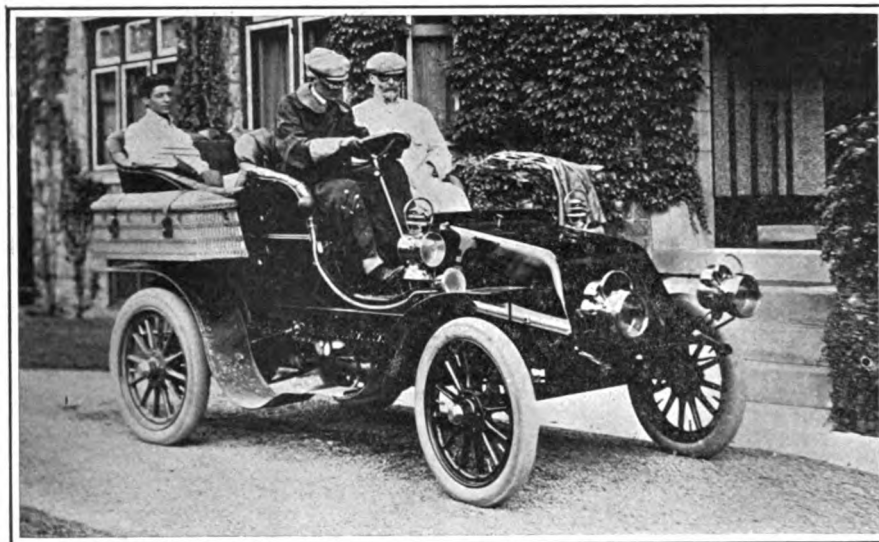

W. B. SAUNDERS, THE LONE ENTRANT FROM PHILADELPHIA IN THE ST. LOUIS RUN.

committee: Lee Richmond, chairman; Joseph J. Mandery, Robert Thomson and Tom Northway.

Arrangements have been perfected for the storage of the machines at the garage of the Rochester Automobile Company, and two cars will pilot the tourists as far as Batavia Saturday morning. Several cars will undoubtedly join the tourists here and run up as far as Buffalo. One member of the local club, George T. Thompson, of Canandaigua, has entered the run, and with his party will accompany the tourists through to their destination.

ROUTE THROUGH TOLEDO.

Special Correspondence.

TOLEDO, July 25.—The Toledo Automobile Club has engaged rooms at the Boody House for headquarters during the visit of the tourists and has rented the Armory in which to store the machines. The committee in charge will consist of W. D. McNaull, Dr. Charles P. Wagar, Frank Hake, and Peter Gendron.

W. W. Morrison will leave Toledo August 4 in advance of the automobile tourists, with a 400 pound box of *confetti*, which he will strew along the road from Toledo to Chicago. The visitors will leave by way of Madison, Collingwood and Central Avenues and hit the stone road for the West.

Instead of entering Toledo on the afternoon of the 3rd, over a dirt road from Woodville, as directed in the guide book, the tourists, after arriving at Woodville should keep on straight to Stony Ridge, a distance of ten miles. From Stony Ridge to Toledo, eleven miles, a good stone road and pavement makes touring very pleasant.

ONE STARTER FROM PHILADELPHIA.

Special Correspondence.

PHILADELPHIA, July 26.—Walter B. Saunders, Philadelphia's only participant in the St. Louis run, will leave his home at Overbrook, one of the Quaker City's prettiest suburbs, at 8 o'clock to-morrow morn-

ing. He will take the old National Turnpike route, reaching that highway by way of Reading and Gettysburg, crossing the mountains to either Hagerstown or Cumberland as circumstances and reports as to condition of the roads warrant.

Mr. Saunders has decided to travel light, and will leave his tonneau at home, his only companion on the trip being his chauffeur. Long-distance touring is a new experience for Mr. Saunders, and if the game meets with his approval on the outward trip he may conclude to run his 20-horsepower Winton home from St. Louis over another route.

NO STARTER FROM WASHINGTON.

Special Correspondence.

WASHINGTON, D. C., July 26.—Much to the regret of those who are interested in automobile matters here, not a single person from Washington is making the automobile tour to St. Louis under the auspices of the A. A. A. It was understood several weeks ago that six, and possibly ten, automobile drivers would take part in the

tour and thus represent the eight hundred automobilists of the capital city, but for various reasons all decided not to start, and the national capital is without a representative in the tour.

INTEREST KEEN IN CHICAGO.

Special Correspondence.

CHICAGO, July 25.—Local automobilists, particularly the members of the Chicago Automobile Club, are becoming stirred with enthusiasm over the tour to St. Louis, and entries from Chicago are beginning to come in rapidly. Nearly all of the directors of the club have signified their intention of joining the caravan here, while a considerable number of the members will be seen turning the prows of their automobiles toward St. Louis on the morning of August 8.

The Chicago contingent will in reality start from South Bend, Ind., as a large delegation will go from here to that place on Friday, August 4, to meet the tourists from the east. Chairman Frank X. Mudd, of the runs and tours committee of the Chicago Automobile Club, has called a run to South Bend and many members have promised to go out and meet the visitors.

The tourists will be entertained while in Chicago at the club headquarters at 243 Michigan avenue. Saturday night, August 6, there will be an entertainment of some kind, and on Sunday a run will be made to the club's country station at Evanston, where a special musical program will be rendered during the afternoon and evening.

BANQUET IN SYRACUSE.

Special Telegram.

SYRACUSE, July 27.—The entire party of World's Fair tourists and the members of the Automobile Club of Syracuse, to the number of 150 in all, will be the guests of the H. H. Franklin Manufacturing Company at a banquet at the Yates Hotel tomorrow night at 6 o'clock.

BANQUET PLANNED IN COLUMBUS.

Special Correspondence.

COLUMBUS, July 25.—The Columbus Automobile Club has practically completed all arrangements for the entertainment and reception of the automobilists in the St. Louis tour, who are scheduled to reach this city August 4. William Monypenny, Jr., who was chosen to represent the club for the occasion, will also act in the capacity of chairman of the various committees and direct their movements. The entertainment committee, which will spare no pains to make the brief stop of the tourists in this city exceedingly pleasant, is composed of Dr. T. K. Wissinger, C. E. Firestone, Dr. George M. Waters, Stanley Rhoades, Dr. Rogers, Dr. C. A. Howell, E. W. Seeds and W. C. Anderson.

Chairman Monypenny, accompanied by members of the entertainment committee, will meet the tourists some miles east of the city and escort them to the Chittenden Hotel, where "open house" will be kept by the local club. Upon their arrival at the hotel, which will be official headquarters, the

Driving Eastward on the National Road. Hurried Run from Pittsburg to New York to Be "In at the Start" of the St. Louis Tour.

Special Correspondence.

POUGHKEEPSIE, N. Y., July 25.— Leaving Pittsburg at 12.05 Monday morning, we started across the State of Pennsylvania with visions of making Philadelphia by the following night and establishing a record. The almost weekly newspaper accounts of motorists driving from one city to another in a day and claiming records caused our bump of ambition to enlarge until we could clearly see Philadelphia, about 400 miles away, almost coming forward to meet the *Pathfinder* and its crew to help them get through in twenty-four hours.

We questioned every one we met in Pittsburg about the roads and, of course, every one said that Pennsylvania roads were always good. We endeavored to locate some one—motorist, cyclist or horseman—who had been over the roads between the two cities, but without success, so we started—blind, you might term it.

Well, the roads were pretty rough, every inhabitant was in bed, and we naturally got lost—not once or twice, but fully a dozen times, as we did not have a compass and the moon not being visible. At first we didn't realize that we were lost, but when we had passed the same large red barn with a windmill on top three times, running up a mileage of about five miles every time, we realized that we had been speeding around a circle. There is no telling just what we would have done if we hadn't at this stage of the game punctured a tire that took us until sun-up to repair, when the rural inhabitants commenced to make their appearance. Then we "hit it up" once more, still with faint visions of Philadelphia ahead. Trouble, however, never comes singly; our chain, worn thin by continual usage, snapped and another hour was spent in repairs. So, instead of making Philadelphia that night, we stopped at Johnstown, the scene of the famous flood, and were glad to get a much needed night's rest.

tourists will be relieved of their cars, which will be taken to the various garages, each car being assigned to the garage maintained by the agents for that make.

A committee comprising Dr. C. M. Taylor, president of the club; F. E. Avery, W. C. Anderson and Oscar Lear, has been appointed to sprinkle *confetti* from this city as far west as Dayton, a distance of about eighty miles. Four cars will be used for this purpose.

The regular meeting night of the local club falls on August 4, the date of the arrival of the visitors, but it is not likely the members will transact any business, it being their purpose to devote all their time to the welfare and comfort of the tourists. One

The next morning, with our bump of record breaking ambition greatly decreased, we started out with Bellefont as a goal and made it with safety, arriving in Philadelphia in three days instead of twenty-four hours, as originally intended. However, we had learned another lesson, and that is, before trying for a record it is a good idea to go over the course at least once and ascertain what is before you.

Originally it had been our intention to start out on the big run from New York with the Tuesday contingency, going over the Catskill Mountains as we did before, but upon inquiry at the eastern club houses we found that nobody was going that way, so far as could be learned, and we had to change our plans quickly and run our car all day Sunday through the rain to get from Philadelphia to New York in time to start with the "bunch" Monday morning, going up the east bank of the Hudson instead of the west side. Our car should have been overhauled, as we had anticipated doing on Monday, but with the change in plans that was out of the question, and we started with everything wet from Sunday's rain, and the *Pathfinder* looking the "toughest" car in line while awaiting on Fifth avenue for the crowd to start.

The only incidents occurring on our trip from Pittsburg to Philadelphia worth mentioning was the hill we struck just before entering Altoona. This is known all over that section of the State as Buckhorn Hill and is six miles long—we thought it twenty. It is very rough and we had two punctures while climbing.

PERCY F. MEGARGEL.

(Concluded.)

Mr. Percy F. Megargel, having completed the round trip from New York to St. Louis outward over the Binghamton-Buffalo-Chicago route and return over the Indianapolis-Columbus-Pittsburg road, started last Monday morning with the New York contingent over the Hudson River-Mohawk Valley route. He will report the run especially for THE AUTOMOBILE.—Ed.

pleasant feature will be a dinner given in their honor.

William Monypenny is the only member of the Columbus club who has thus far entered for the tour.

WHEN IT COMES HARD.

It is easy enough to be pleasant
When your automobile's in trim,
But the man worth while
Is the man who can smile
When he has to go home on a rim.

—Chicago Record-Herald.

PLANS are being made for an automobile race meet to be held at Urbana, O., in connection with the Champaign County Fair on August 9 to 12.

Suggestions to the Inexperienced.—VI.*

A Simple Discussion of the Principles of the Gasoline Car for the Benefit of Novices.

By A. D. RIVER.

LUBRICATION OF THE ENGINE.

THE theory of lubrication is that, in spite of all that can be done to polish and smooth a bearing surface, minute roughnesses still remain, whose dragging tendency, when two such surfaces are rubbed together under pressure, is aggravated by the natural tendency of two metal surfaces in close contact to adhere. Both of these tendencies are averted by introducing a film of slightly viscous liquid like oil between the surfaces, which then float, so to say, on that film. Capillary attraction and the natural tenacity of such a film prevent it from being squeezed out when the pressure is not too great; and when oil is supplied at the edges of the rubbing surfaces capillary attraction will draw it in. This is especially the case in a shaft bearing, where the oil can be introduced where there is little or no pressure, and carried around to the points under pressure by the movement of the rubbing surfaces.

If a bearing be not supplied with a proper lubricant, in quantity sufficient to make up for the constant squeezing out of oil which goes on around the edges of the bearing, it quickly becomes hot from the increasing friction, and, when all the oil is gone, if the power is still sufficient to overcome the friction, the surfaces "seize," and one or both become scored and cut, an eventuality which usually stops the machine in short order.

LUBRICATION AN ESSENTIAL.

From this it will be seen that the lubricant is as essential a part of a machine as the bearings themselves, and should be looked after as carefully. This is a point which many beginners fail to appreciate. If they do not actually let the bearings go dry they are likely to think that one sort of oil is as good as another, whereas in reality each has its own proper use, cylinder oil being unfit for bearings, machine oil unsuitable, sometimes, for crankcases, and both machine and crankcase oils usually useless for cylinder lubrication.

It was remarked in a previous article that a thorough understanding of ignition devices will save the novice from very many involuntary stops. The same is true of lubrication, with the difference that neglect of the latter spells not only delay but costly repairs as well. Fortunately there is nothing about lubricants and lubricators at all difficult to understand, and there is no excuse for the veriest tyro neglecting the simple attentions required.

DIFFERENT MOTORS' REQUIREMENTS.

It is hardly necessary here to go into a

* Continued from Page 685, issue of June 25, 1904.

minute discussion of the several classes of oils and greases, for the reason different motors frequently require different grades of oils of the same general class, and every builder is careful to specify what oils will be found most suitable in his own machine. The general classes of oils, however, should be carefully distinguished. In a sense, the most important of them, because the most expensive and also because the effects of lapse in quality are soonest felt, is cylinder oil.

GAS ENGINE CYLINDER OIL.

Gas engine cylinder oil is primarily distinguished by its high "fire test," by which is meant the temperature at which it will give off inflammable vapors. This is never below 600 degrees Fahr., and for the latest oils it is upward of 800 degrees; the highest fire test oil being used in air-cooled cylinders, which get very hot. Some kinds of cylinder oil are quite heavy and thick, but it does not follow that the heaviest oil is always the best. If the cylinder walls have a moderate temperature, due to thorough water cooling, a light oil may be preferable, as having less tendency to clog the piston rings. But a light mineral oil loses its viscosity very rapidly at high temperatures, and with restricted water cooling, or high compression, as well as in air-cooled cylinders, its use calls for special care. In such cases, and also in any case when the piston rings are worn and disposed to leak, a heavier oil must be resorted to. A good cylinder oil (not *steam engine* cylinder or valve oil) will burn slowly away with little residuum if not fed too fast, whereas ordinary machine or crankcase oils, grease, etc., will not only burn up before they have performed any lubricating function worth mentioning, but will leave a black, tarry residuum which will soon clog the piston rings and short circuit the spark plugs.

CRANKCASE OIL OF COMMERCE.

Crankcase oil, properly so called, is seldom or never used in automobile motors. It is a cheap, heavy oil, designed to float on water in the crankcases of stationary engines, and lubricate the shaft and crankpin bearings by its splashing.

Machine oil, which is used for the crankcase and general lubrication of automobiles, other than the cylinders, is a fairly light mineral oil, and is sold under a good many names, and in different grades. Heavy or light oil should be used according to the pressure per square inch in the bearing, the mode of feeding, the speed of the shaft, etc. It is better to use a light oil in liberal quantities, collecting it as it escapes, settling it, and using it again, than to use a heavy

oil fed as sparingly as possible. The former absorbs less power, and it washes out the bearing, if properly applied, carrying away with it whatever particles of metal have been worn away from the rubbing surfaces. In cold weather, a lighter oil must be used than in summer.

Greases are seldom employed about the engine, though they are much used about the gear shaft, axle, and wheel bearings of the car, as well as in ball bearings generally and the small detached bearings of the steering gear, operating connections, propeller shaft and other minor bearings. A frequent and very good combination is a mixture of grease and graphite, which may be bought compounded for use.

METHOD OF FEEDING OIL.

The method of feeding the oil is as important as the character of the oil itself, because there are not many devices which will feed oil intermittently—drop by drop—and yet with absolute regularity under all conditions. The sight feed oil cup, feeding oil four or five drops per minute by gravity from a regulating needle valve, has fallen steadily into disfavor owing to the impossibility of maintaining a constant rate of feed under the changes of temperature, vibration, etc., to which the automobile is subject. It is still used in some cars, but more positive devices have taken its place in most. The same may be said of the wick feed, in which a loose strand of wicking soaks oil up over the edge of a tank and dips it into the mouth of a tube leading to the bearing. This device is serviceable for cars of small power, but is not reliable enough for the high power touring cars.

OIL POCKETS AND RINGS.

Probably the best way to lubricate the main shaft bearings is to use oil pockets and oil rings such as are used in many steam engines and all electric motors and dynamos. These oil pockets should be supplied with oil either at periodic intervals or by a drop-by-drop feed, and the escaping oil carried from the ends of the bearings into the crankcase. This affords a practical realization of the ideal of a constant flow of light oil, used over and over again.

When ring oilers are not used, a common method is to put sufficient oil in the crankcase to be dashed about by the ends of the cranks as they dip into it, and to catch this oil splash in suitable pockets over the bearings, from which it flows by drilled holes to the latter. When this method is used, the large ends of the connecting rods are drilled to catch some of the oil and carry it to the crankpins.

When properly managed, this is a very effective way of oiling all the bearings of the crankcase and is probably the best for the crankpins. It necessitates maintaining a fairly constant level of the oil in the crankcase, as too little oil will not give splash enough to reach the main bearings, and too much will throw an excess of oil into the cylinders. To prevent too much

oil from reaching the latter even under ordinary conditions it is necessary either to put an extra ring near the lower end of the piston to scrape the oil back, or to close the mouth of the cylinder with a baffleplate having in it a slot for the connecting rod to work through. The "splash system" of lubrication is obviously applicable only to vertical motors.

WICK WIPER OILING DEVICE.

It is common to oil the crankpin of a horizontal engine by a wick "wiper" mounted on the large end of the connecting rod and catching at each revolution a fraction of a drop of oil from a sight feed device at the top of the crankcase. The wrist or piston pin of such an engine is generally lubricated by forming a trough on the upper side of the connecting rod, by which oil is taken from a convenient feeding device at the mouth of the cylinder. The wrist pin of a vertical motor is commonly lubricated by oil reaching it from the cylinder walls through a hole drilled lengthwise through the pin and connecting with other holes leading to the bearing surface of the pin.

CYLINDER OILING MECHANISM.

For feeding oil to the cylinder, the "force feed" or positive pressure oiler has come to be recognized as the most reliable device. This oiler is a miniature pump, or, if there are several cylinders, a series of miniature pumps, worked at a very slow rate of speed by belt or gear connection with the engine. The pumps are positive in their action and will overcome any ordinary obstruction in the oil pipes leading from them to the cylinders. They work fast or slow, according to the speed of the engine, and therefore deliver oil in substantial proportion to the demand for it. They are unaffected by vibration and by ordinary heat or cold, as well as indifferent to changes in the thickness of the oil. Consequently they require no readjustment.

The merits of these force feed lubricators have led to their adoption on many touring cars not only for the cylinder lubrication, but for the crank and gear cases and clutch mechanism as well. The oil tank has two compartments, one for cylinder oil and the other for machine oil, and each feeds its own pumps. The cost of the outfit is not high, owing to the diminutive size of the pumps; and it is a very real insurance against disablement, besides saving the operator from a great deal of worry.

TRANSMISSION SYSTEMS.

The reason for using speed changing gears, by means of which from two to four different ratios of gearing may be established by the shift of a lever, between an explosion motor and the drive wheels of the vehicle, may best be understood by a comparison of the explosion motor with the steam engine.

The steam engine works most economically with a short "cut-off," i.e., with steam admitted to the cylinder at boiler pressure for the first quarter or half, let us say, of the stroke and allowed to expand without fresh additions during the remainder of the stroke. The shorter this cut-off can be made, and the more the steam can be expanded before release within certain practical limitations, the more economically the engine will work. The explosion motor, on the other hand, is most efficient when working against a full load, and its efficiency falls off rather rapidly as it is throttled down to a fractional load; the main reason being found in the low compression of a throttled charge.

Consequently, the normal or preferable condition of working for the steam engine is that of short cut-off and medium or light load, and a heavy load is taken care of by temporarily lengthening the cut-off at the expense of economy, while a load lighter than normal is provided for either by throttling or by still further shortening the cut-off, according to the type of engine. The explosion motor, on the contrary, is intended for the sake of economy to take a full charge, rather than a reduced charge, as often as possible, from which it follows that an increase in resistance must be taken care of by a lower gear, by which the engine is allowed to run at full speed although the vehicle moves more slowly. The engine thus gets a better "purchase" to move the car, exactly as a cyclist demands a low gear if he is in a hilly country.

In theory the explosion motor ought at all times to be geared as high as its work will allow, thus permitting it to work with full charges at all times. Of course, this

is not always possible; particularly if it is desired to run the car slowly on a level road. The resistance then being very small, a very high gear would be required to load the motor, and it would be turning so slowly that a large percentage of the heat, instead of being utilized by prompt expansion, would be lost to the water jacket, besides which the valves would overheat. Again, the necessity of shifting gears frequently becomes more or less irksome, so that in practice four changes constitute the limit.

Many machines, especially those of moderate price, have but two forward changes of gear, on the higher of which most of the running is done. This makes the operation extremely simple, but it has the drawback that, because the single high gear has to serve the purpose of two, the motor must be large enough to carry the car up moderate grades on the high gear, and consequently must run throttled a large part of the time on the level. Again, as the motor can never be geared high enough to pull its full load on the level, it follows that for the highest speed of the car the motor must be running considerably faster than would be necessary if it could be geared to exert its full torque. Consequently, its wearing parts will need refitting so much the sooner. It is generally admitted that the main objection, such as it is, to three or four gear changes is simply the greater first cost.

(To be Continued)

THE French are now to the front with a motoring skirt for women which is nothing more than a bag fastened around the waist and having two holes for the feet to pass through, these being fitted with elastics to keep them tight about the ankles.



DAYTONA BEACH CLUBHOUSE OF FLORIDA EAST COAST AUTOMOBILE ASSOCIATION.

The Daytona Beach clubhouse of the Florida East Coast Automobile Association, shown in the engraving above, was formally opened July 4 with appropriate ceremonies. It was erected on the sand dunes overlooking the wide beach where the winter speed trials and races are held, and cost the association \$20,000. The figures 39 over the entrance commemorate W. K. Vanderbilt, Jr.'s world's record, of which the club is very proud, Mr. Vanderbilt being a member of the organization. President C. G. Burgoyne, of the F. E. C. A. A., was the leading spirit in promoting the tournaments, organizing the association and arranging for the construction of the new clubhouse, whose dining halls overlooking the beach and ocean will accommodate more than 200 guests. Next winter's tournament is to be held in November, when, if the hotels are not opened, contestants and other visitors will be accommodated in the new clubhouse and in Daytona.

Detroit Electric Commercial Vehicles.

Huge Vans, Omnibusses and Open Summer Cars Under Construction Using New System.

Special Correspondence.

DETROIT, July 23.—The largest electric truck in the world, according to the manufacturers was recently put into service here and attracted much attention, especially as it is the first of local manufacture and marks the advent of Detroit into the field of heavy commercial vehicle manufacture, whereas heretofore the city has been recognized as the pioneer and largest producer of small gasoline pleasure carriages.

The new truck is in the service of the Michigan Stove Company and is the first of a lot of six to be completed by the Commercial Motor Vehicle Company. The other five trucks on this contract order will be delivered as fast as completed and will be put into the service of the Michigan Stove Company in this city, Chicago and Buffalo. Two will be used in each city where plants of the stove company are located. Each truck costs \$6,000 and is expected to do the work of seven or eight horses.

The truck weighs eight tons, with top, and its carrying capacity is seven tons of dead load. The overall length is twenty-four feet, while the body is twenty-one feet long by seven feet wide. The particularly novel feature of construction is the four-wheel drive mechanism. As will be seen from one of the accompanying engravings, each wheel is mounted with its separate motor as a unit on the axle and is movable in a yoke on the axle end. The rear wheels and motors are movable in the axle as well as the front ones, permitting the huge vehicle to be turned in a circle of thirty feet diameter. Steering is effected by means of a small electric motor connected by gear and worm to the arm of the bell-crank seen at the top of the axle in the photograph, which moves the motors

and their wheels simultaneously in opposite directions with relation to the axle and in corresponding degrees. The armature shafts of the motors are always in accurate line with their work. Each motor is geared to its wheel hub through a simple system of spur gears enclosed in dust and waterproof steel castings. By this construction all the mechanism is concealed

is said to give a traction never achieved by rubber for heavy vehicles and to have proved successful.

The battery is underslung to give low center of gravity, leave the body free from obstruction and facilitate removing and replacing the battery boxes. The battery is composed of eighty cells furnishing 160 volts and 350 ampere hours. The truck requires empty, on a level road, thirty-five to forty amperes, and loaded to full capacity, from sixty-five to seventy amperes.

CLOSED AND OPEN PASSENGER CARS.

In addition to the freight and merchandise wagons, the Commercial Motor Vehicle Company has completed two immense

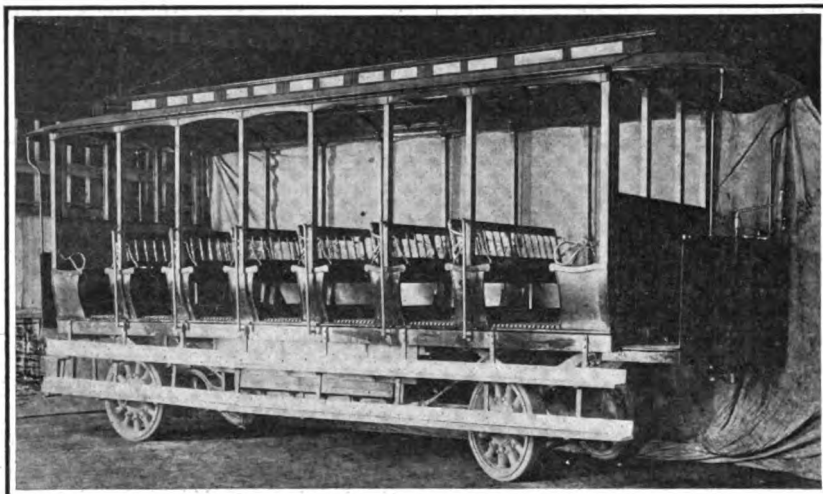

OPEN SUMMER CAR BUILT TO RUN ON TRACKLESS STREET.

from sight, as will be noted in the picture of the complete truck. The ratio of the gearing allows a speed of eight miles an hour. Each motor is controlled by a separate switch so that it can be cut out at will without stopping the others; and any one of the motors will drive the vehicle. Automatic air brakes are fitted to all of the wheels so that the strain of stopping is equalized.

An odd departure is the use of southern gum wood for tires instead of rubber. It

closed omnibusses and some open summer cars, each having capacity for forty-four persons. These are the first vehicles of a lot of fifteen ordered by the recently organized Citizens' Transit Company, which will use them for public service between the downtown district and Belle Isle Park, and other outlying parts of the city. The Citizens' Transit Company will confine its own operations to Detroit, but it is proposed to sell licenses through a subsidiary company known as the



DOUBLE-DECK ELECTRIC OMNIBUSSES CONSTRUCTED BY THE COMMERCIAL VEHICLE COMPANY IN DETROIT



HUGE SEVEN-TON ELECTRIC VAN IN SERVICE OF DETROIT STOVE CONCERN.

Imperial Electric Motor Transportation System of Michigan to other companies or individuals and furnish the equipment for similar omnibus lines elsewhere. The Citizens' Transit Company, the Michigan Stove Company and the Commercial Motor Vehicle Company all have close relations, as James B. Book is president of the Citizens' and the Commercial companies and George H. Barbour of the stove company is one of the directors of the Commercial company.

The passenger vehicles have the same chassis as the big truck, but the bodies are interchangeable from the closed pattern to the open summer car style. The cars will run anywhere on the streets, as they do not require rails. The wheels are fitted with solid rubber tires. The bodies are twenty-five feet long by six feet wide. The wheelbase is eighteen feet. The four motors are of 4-horsepower each and the gearing provides for a speed of twelve miles an hour.

Napier Six-Cylinder Racer.

The accompanying illustration shows the engine of the very interesting six-cylinder

car taken by S. F. Edge to Germany to use as a reserve in case of accident to the four-cylinder 80-horsepower car which he finally drove.

The general arrangement of the engine

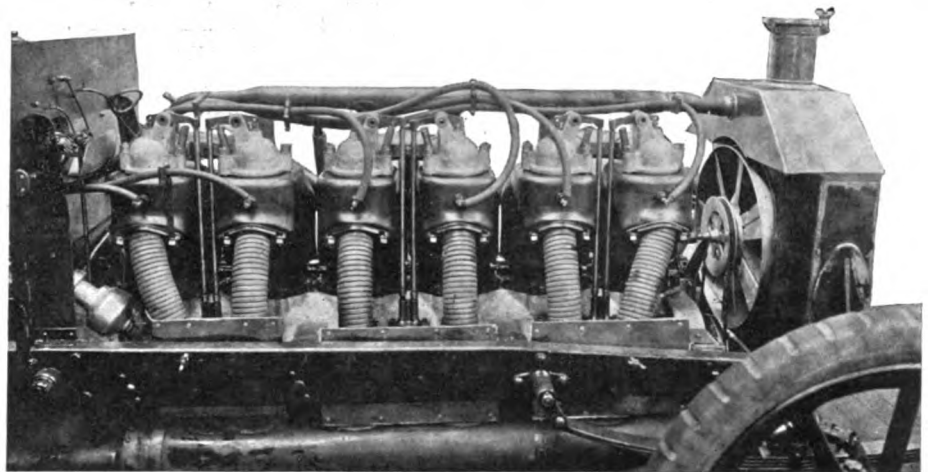

SIX-CYLINDER 80-HORSEPOWER MOTOR MOUNTED IN NAPIER RACING CAR.

is quite similar to that of the standard 30-horsepower six-cylinder touring car produced by the same firm this year. Its leading feature is the 80-horsepower engine, which

The ignition is by the Napier high tension synchronized system, using but one coil and one trembler for all the cylinders. The clutch has metal-to-metal friction surfaces, with three springs independently adjustable, and its thrust is self-contained. The gear box is very small, and has but two forward speeds. Although the constructors credit this feature to the flexibility of their six-cylinder engine, it may be supposed that intermediate speeds are really unnecessary, because the torque of the engine is nearly as much as the rear wheels would carry without slipping.

The radiator is built up out of fluted tubes, giving the maximum of air surface with the minimum of contained water. The frame is of pressed steel, and the total weight is about 2,150 pounds.

MOTOR cars for railroad inspection purposes are rapidly coming into use and are said by the railroad officials to be of great value.

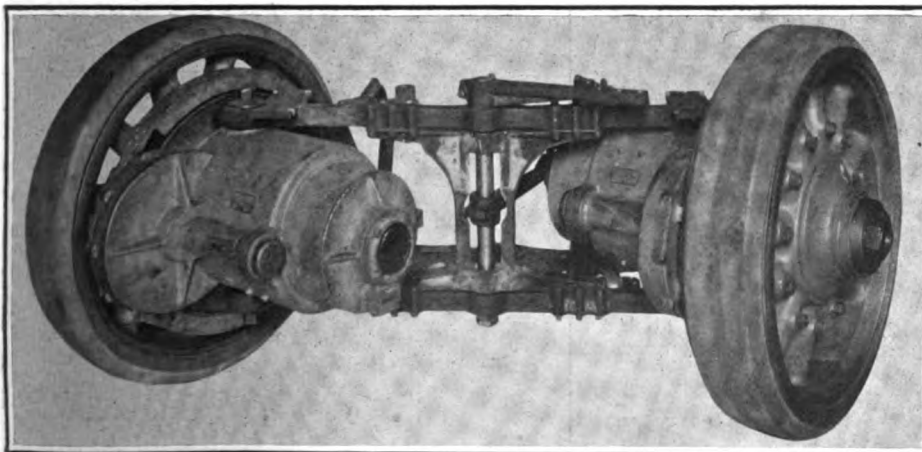

AXLE AND WHEELS OF COMMERCIAL COMPANY'S TRUCK SHOWING MOVABLE MOTORS

Columbia Electric Tonneau.

An electric touring automobile constructed on the conventional lines of a large gasoline machine, which it exactly resembles in appearance, has been turned out by the Electric Vehicle Company, Hartford, Conn., for E. E. Gold, President of the Gold Car Heating and Lighting Company, New York city. The casual observer would surely suppose that the car was a regulation gasoline machine, as a glance at the accompanying photograph will show.

The touring equipment of the car is complete, consisting of full canopy top with side curtains and glass front, baggage rail on top and side hampers. The car is lighted by electricity, there being two large headlights, two lights on the hood, one tail light, and a light in the tonneau. The tonneau will accommodate five persons and the front seats two.

The wheel-base is 106 inches and the tread 56 inches. These and other general dimensions correspond exactly with those of the 35-horsepower Columbia gasoline car. The single motor is a Westinghouse of 40 amperes, 140 volts, and drives through herring-bone gears, countershaft and side chains. The battery consists of 116 Edison cells, part being carried in the hood and the remainder in the box slung under the floor of the car. We are informed by the builders that a mileage of 60 miles can be attained, the maximum speed of the car on level roads with full load being 16 miles an hour. There are four speeds forward and two backward. A General Electric controller is used, with resistance on the first notch. A safety switch having a removable plug is provided. The tires, both front and rear, are 34 inches by 5 inches, double tube. Two sets of double acting brakes are fitted, the foot-brake acting on the countershaft and the emergency brake, operated by

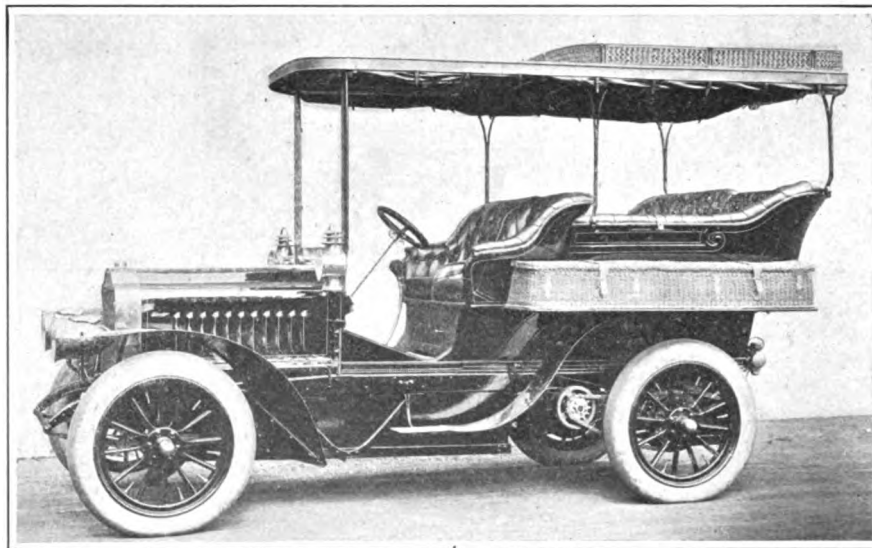

COLUMBIA ELECTRIC TONNEAU CAPABLE OF SPEED OF 16 MILES AN HOUR.

a lever, acting on the hubs of the rear wheels.

The car is said to have been thoroughly tested out, with excellent results.

The Gale Runabout.

A new runabout of western origin, containing most of the well-known features of the American type of light car, is shown in the accompanying illustration. It is made by the Western Tool Works, of Galesburg, Ill., and is named the Gale car. It has a horizontal engine of one cylinder, 5 inches bore by 6 inches stroke, of a nominal speed of 800 revolutions per minute. Both valves are mechanically operated. The pump is bolted to the crankcase so that it cannot get out of line. A Kingston carbureter is used, and a Splitdorf coil.

A planetary transmission gear is used, but the high speed clutch, instead of being of the usual flat disc type, is conical. All gears are stated to be of hardened steel.

The two forward speeds are operated by one lever at the side of the car, and the reverse by pressure on a foot lever.

The tanks and two sets of batteries are located beneath the bonnet, and below is a radiator of twelve 24-inch flanged tubes. The frame is channel iron, and the body is so attached that by loosening two front bolts it may be tilted up on two hinges at the back, giving ample room to get at the machinery. By taking out the pins in the hinges it may be removed.

The emergency brake acts on the drum of the differential, which is of the spur gear type. The rear axle has a solid shaft extending clear through and fast to one wheel. The differential drives the other wheel by a sleeve on this shaft. Midgley wheels are used, with ball axle and hub bearings of liberal dimensions. The springs are all full elliptic and long enough for easy riding. The tires are double tube, 28 inch by 3 inch; and the wheel base is 80 inches.

A fair-sized carrying space is afforded under the tonneau board, but no tonneau is supplied. The makers state that several cars of this model have run over 5,000 miles this year without replacements except on tires. The car is said to weigh about 1,000 lbs., and is sold at a very low price.

Pungs-Finch Light Car.

The light touring car of the above name, lately brought out by the Sintz Gas Engine Co., has a four-cylinder vertical motor, a sliding gear change speed device with three forward speeds, and propeller shaft drive to the rear axle. It is rated at 10-horsepower, and is built to sell at a price unusually low for a four-cylinder car.

The frame is of pressed sheet steel, and the engine and gear box are hung on a false frame. The engine has cylinders of 3 1-4 inches bore by 4 inches stroke, with heads cast integral. The valves are all mechanically operated. The shaft has five main bearings. A float-feed carbureter is used,

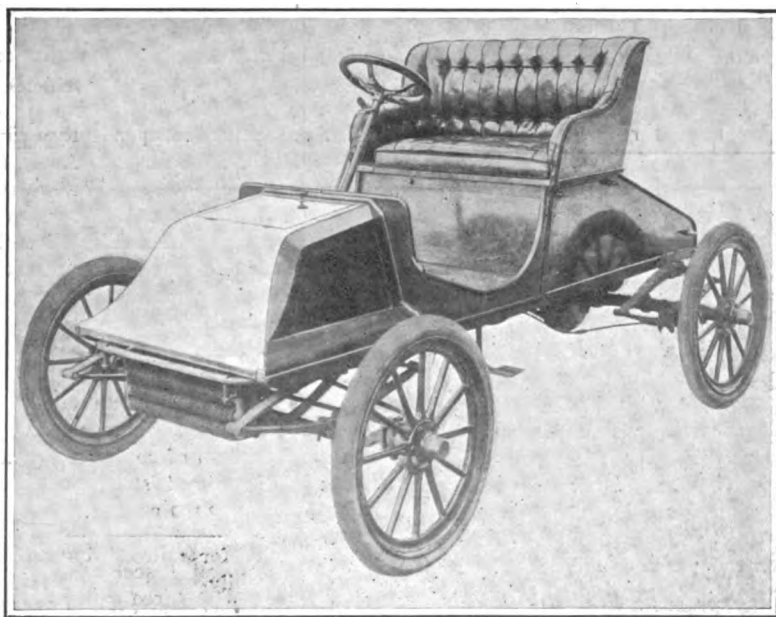

GALE LIGHT CAR FITTED WITH SINGLE CYLINDER HORIZONTAL MOTOR.



ORIENT LIGHT TONNEAU WITH SIDE ENTRANCE.

and jump spark ignition, there being a separate coil for each cylinder.

A conical clutch of liberal size transmits the power to the gear box. The gears are of 1 1-4 inches face, and the transmission is direct on the high speed. The case, like the engine crankcase, is aluminum.

The rear axle, of the usual bevel gear type, is equipped with roller bearings. The makers claim a special device for keeping it in alignment. The front axle is a steel tube. The wheels are 30 inches in diameter, of second growth hickory with wooden hubs, into which the spokes are fitted before the metal covers are put on. Springs are 32 and 42 inches long, respectively, in front and rear, both being semi-elliptic. The wheel base is 80 inches and the tread standard.

A gear pump is used for cooling, with a radiator at the front of the bonnet. Lubrication of the motor is by splash, a little oil being let into the crankcase from a tank every ten or twelve miles.

The body has a divided front seat and removable tonneau. It is so arranged that a delivery body, or a coupé or surrey body can quickly be put in the place of the tonneau.

Buick Light Touring Car.

The increasing popularity of the light touring automobiles is one of the most noticeable features of this season in automobile circles, and many new vehicles are being designed to meet the demand. One of the

latest is the Buick Model B, manufactured by the Buick Motor Company, Flint, Mich. This car is driven by a double opposed cylinder motor of 15 horsepower located in the body of the car. The hood covers the water and gasoline tanks, which are of liberal



BUICK LIGHT TOURING CAR STRIPPED FOR CROSS COUNTRY RUN.

size. The planetary transmission gives two forward speeds, thirty-five miles an hour, it is stated, being the maximum speed. The tires are 3 inches in diameter and the springs at front and rear are 36 and 40 inches long respectively, giving the car excellent riding qualities. Lubrication is accomplished by an automatic sight-feeding device placed on the dash and feeding

through seven leads to the various bearings. The tonneau, which has side entrance, will seat three persons and the front seats are of the individual or "bucket" style, upholstered in leather. The body of the car is finished in blue with gold striping, and the running gear yellow. Brass trimmings around the seats and on the dash-board add to the appearance of the vehicle.

The accompanying engraving shows the car, stripped, that made a test run from Flint to Detroit, 102 miles, over the poor roads of Michigan, in 3 hours, 37 minutes.

Orient Light Tonneau.

The latest production of the Waltham Manufacturing Company, Waltham, Mass., makers of the Orient Buckboard, is a step toward the production of the poor man's family automobile. The new car is of attractive design, as the illustration shows, and it will be noticed that the tonneau is provided with one of the latest features—side entrance. The manufacturers state that the machine is capable of taking four adult passengers up any ordinary grades; that it

will make a speed of eighteen or twenty miles an hour on the road; and that it rides as comfortably as many larger vehicles.

ESCAPED BEING SHIPWRECKED.

A party of automobilists had a narrow escape from being shipwrecked at sea in an automobile a short time ago; queer though this may sound, it is a fact. It was at Atlantic City. The driver had run his machine along the beach and into the shallow water for fun, and the party, consisting of ladies, was enjoying the novelty of the sensation when the wheels suddenly sank into a hole in the sands. The first thing they knew the water was a foot deep on the floor, and the tide was rising at a rate that threatened to make the party swim for it—if they knew how. Before this happened, however, a team of horses was brought to the rescue, and the machine with its badly scared crew was hauled safely ashore. No more ocean voyages in automobiles for theirs!

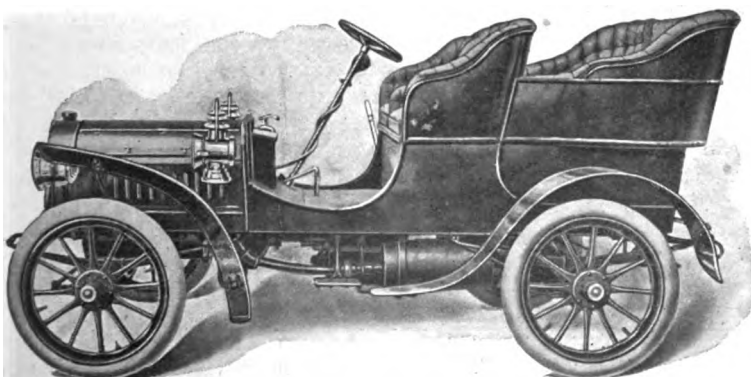

PUNGS-FINCH FOUR CYLINDER MOTOR-IN-FRONT LIGHT TONNEAU.

Pennsylvania Toll Road Extortion.

Automobile Club of Philadelphia Obtains Legal Opinion and Belligerent Members Want to Fight.

Special Correspondence.

PHILADELPHIA, July 25.—Few large cities of the country are so enmeshed in the coils of the toll-road octopus as is the good old Quaker burg. Radiating from it in every direction are turnpike roads still in the hands of the antiquated companies that formed them, and many of them are in a condition which would seem to warrant the granting of a premium to those who use them rather than the mulcting of the traveler in an amount out of all proportion to the wear and tear inflicted on the road surface or the benefit conferred upon the user.

Especially is this true in the case of automobile travelers, who, being popularly supposed to be in the millionaire class, are charged "all the traffic will bear." Within the past fortnight the woes of the automobilists have been greatly aggravated by the sudden and apparently preconcerted increase in the rates on the majority of the toll roads within twenty-five miles of the city. Even as far away as Lancaster the automobilist is feeling the effect of this discrimination—that is the word, for the increase affects him alone, the driver of the horse-drawn vehicle still enjoying the comparatively low rates which have obtained for years.

In Lancaster the automobilists are fighting for a complete abrogation of tolls, on the ground that the companies' charters contain nothing that will warrant a charge for "horseless" vehicles. They further contend that any company which leases or sells any portion of its road to a trolley company exceeds its legal rights and forfeits its charter. It would seem that a fight for a rate equivalent to that charged horse-drawn vehicles would be more equitable and have a better chance of success in the courts. One of the Lancaster automobilists has even gone so far as to chop down a gate on the Lancaster & Susquehanna Turnpike, which was intended to bar his progress until he had paid the excessive toll demanded. There is a law in force which provides a penalty of six months' imprisonment for any one destroying the property of a turnpike company, no fine being provided for as an alternative. The automobilist in question was arrested and held in \$300 bail to answer a charge of malicious mischief.

In another section of the country, thirty miles from Lancaster and half that distance from this city, the Spring House & Lumneyborn Turnpike is "piling it on thick," ex-Burgess Charles W. Wainwright, a motorcyclist, having been compelled to pay 96 cents for traveling the 17 1-2 miles of road included in that company's property—

an average of nearly 5 1-2 cents a mile! And this, despite the fact that its charter provides for a charge of but 10 cents for every five miles "for a chariot, coach, phaeton or dearborn with one horse and four wheels, and in proportion for any less distance." Two-horse vehicles are charged 12 cents for five miles, "and for every other carriage of pleasure, under whatever name it may be known, the like sums, according to the number of wheels and horses drawing the same." The toll exacted of the motorcyclist in this case therefore represents an increase of 125 per cent.! Mr. Wainwright has taken the case to court, and has asked, first, for a decision as to whether any toll can be collected for motor vehicles; second, for a ruling determining the classification of motor vehicles for purposes of charging toll; third, for an injunction restraining the turnpike company from charging illegal tolls; fourth, for an order compelling the company to refund excess charges. The plaintiff contends, finally, that the turnpike company cannot equitably class his motorcycle higher than a one-horse carriage, and that his toll therefore should have been at the rate of 10 cents for five miles, according to its charter.

This case, while a local one, will establish the standing of the motor bicycle on all toll roads throughout the State.

In the case of the Lancaster Avenue Improvement Company, which recently made a 50 per cent. increase applying only to motor vehicles, the Automobile Club of Philadelphia has been considering the advisability of carrying the matter to court, Lancaster Pike being more popular with its members and local automobilists generally than any other toll road leading out of the city. As a preliminary, the matter was referred to the club's attorney, Ellis Ames Ballard, who is a member of the club, and although he apparently deems it inadvisable for the club to engage in litigation just now, not a few of the members believe that even though the rate of toll increase is small as compared with that charged by some other companies, the principle involved is the same, and that unless a strong legal protest is filed at once the companies are liable to raise the tariff still higher. The matter of fighting the overcharge is to be decided at a meeting of the club's board of governors in the near future.

Mr. Ballard's opinion is in part as follows:

1. A turnpike company has an inherent right to charge tolls against all vehicles using its road, whether automobiles be specifically mentioned in its charter or in the general Acts of Assembly. The Lan-

caster Avenue Improvement Company has the power to make such charge for the additional reason that the acts under which it is incorporated allow it to charge toll, in proportion, upon "every other carriage of pleasure, under whatever name it may go."

2. Automobiles have the right to use all public highways of the Commonwealth, including turnpikes, and cannot be excluded therefrom, directly or indirectly, by charging excessive or prohibitory rates of toll.

3. The various Acts of Assembly on the subject of regulating turnpike companies indicate that the amount of toll to be charged is arrived at by taking into consideration (a) the number of wheels on a vehicle; (b) the number of horses drawing it; (c) the width of tires; and (d) the weight of the vehicle, and this weight is partially indicated by the number of horses required to draw the vehicle. Automobiles, not being mentioned specifically in the acts regulating the rates of toll, would have to pay such rate of toll as a vehicle of like general character pays. The Lancaster Avenue Improvement Company has authority under its charter to charge a higher rate upon the heavier vehicles.

The question, therefore, resolves itself into one purely of fact and is not one of law. It would depend upon the evidence of men versed in road-making and experts on the subject how the court would view the charge. It could be shown, for instance, in favor of the automobile that it has no horses to wear out the road and that its softer tires would not injure the road as much as metal tires. Against this view it could be shown that the automobile is a heavy vehicle, and, by reason of its speed, very wearing upon the roadway. I have been surprised to hear an opinion expressed by those who ought to know that an automobile is harder on a turnpike by reason of its speed than a vehicle drawn by horses.

To conclude, the rate of toll charged an automobile must be reasonable when compared with the rates charged other vehicles after taking into account the matters hereinbefore referred to. Whether the present rate will be held to be reasonable will depend very largely upon the character of testimony given by parties who may be considered experts upon the wear and tear of a roadway. I fear that the increased rate is so small that we would not win out in a fight. In this, as in other matters, I think it the part of wisdom from the automobilist's standpoint to avoid litigation as much as possible, in the belief that time will cure many of the annoyances to which they are now subjected; but I stand ready to make a test if the club thinks it advisable.

The opinion expressed by Attorney Ballard that the turnpike company has the right under the charter to charge toll for automobiles although they are not specifically mentioned, indicates that the up-State automobilists will be disappointed in their effort to have the court decide that automobiles may use the turnpike free of charge.

If Mr. Ballard's interpretation of the law is correct, the Automobile Club of Philadelphia should have a good case against the company, as it is evident that it is charging excessive rates of toll for autos and thereby indirectly excluding them from the highways. The rate on one-horse carriages still remains at five cents and on two-horse vehicles eight

cents, as against seven cents for motor runabouts and twelve cents for touring cars. The crux of the situation, in the opinion of many of the members of the Automobile Club of Philadelphia is the evident discrimination against automobiles, and not the rather insignificant increase in the rate.

Those members with the legal chip on their shoulders say the unreasonableness of the charge for automobiles must be apparent, and think that the present opportunity of doing away forever with a palpable and gross discrimination against autos is too good to be missed. They assert that in the light of present-day knowledge of roads and road-making it will be impossible to convince an average judge and jury that, generally speaking, an automobile, even at high speed, injures a road to the extent that the hoofs of a horse and the metal tires of a wagon do.

Mr. Ballard's confiding reliance upon the softening influences of time seems to be misplaced. It is only necessary to recall the experiences of the bicyclists in the early days of that sport. Every right and privilege the wheelmen secured was given grudgingly and only after the matter had been thoroughly threshed out in the courts. In this connection a prominent local automobilist to whom a copy of Mr. Ballard's opinion was shown, said:

"If we are to sit down and wait till the turnpike companies grant us our rights we will wait till doomsday. It seems to me that the Automobile Club has a good case, and that as the governing body of the sport in this vicinity it should stand by its guns. Of course, the fight will cost money; but the result in my opinion will be well worth the outlay. The only unjust feature of the case is that the 160 members of the Automobile Club of Philadelphia should bear the cost of the test, whereas the number of possible beneficiaries in the event of a successful outcome will mount well into the thousands in this vicinity alone. If the club should follow the example of the wheelmen, and use the unjust discrimination of the turnpike companies as a rallying cry, it could possibly double its membership in a comparatively short time, and thus provide itself with the sinews of war. If I know the average American, there is nothing he will combine against quicker than extortion—and that's what the turnpike companies' recently increased rates amount to."

THIRTY automobiles are in use in Elgin, Ill. Under a recent ordinance owners are required to register and number their machines, paying a license fee therefor of \$2.50.

THE "runaway automobiles" of which the daily papers so frequently speak are almost invariably caused by some fault of the operator, who either gets flurried and does nothing or does the wrong thing, with disastrous results.

Correspondence

Automobile vs. Horse and Buggy.

Editor THE AUTOMOBILE,

Sir:—On many occasions I have noticed in your paper comparisons between the automobile and horse, and while difficult to make I feel that it is possible. For when I purchased my machine I had that very point in mind and consequently have kept an accurate account of my running expenses. I will append a table which will explain matters better than words. Owing to the fact that I live in a city having smooth streets my tire and repair bills have not been as large as one would expect. Then another point and an important one is that I keep my machine in a shed at the rear of my house and care for and run it myself. I spend 15 minutes each morning looking it over and testing the mechanism, and as a result have never been left by the roadside and only once have I had to be towed in through not having enough cylinder oil. But I had taken another person's word as to the amount and as a consequence my engine run dry.

It has been my experience that you can never take another person's word for anything about an automobile unless you want to get in trouble; very few repair men are excepted under this heading either. I have now run the machine thirty-one months, and in that time covered 14,932 miles at a total expense of \$524.46, or at the rate of .035 cents per mile for my riding. The table appended will show the various expenses.

Oldsmobile runabout			
First cost,		\$650.00	
Miles traveled in 31 months,	14,932		
Batteries,	" " "	\$15.00	
Repairs,	" " "	312.06	
Gasoline,	" " "	88.25	
Tires,	" " "	109.15	
Depreciation in value in 31 months	2-3		
first cost, or about	\$450.		
Comparison with horse and buggy:			
Automobile.Horse.			
First cost.....	\$650	\$325	
Cost of keeping for 31 months.....	524.46	775	
Depreciation in value 2-3....	450	215	
Number of miles traveled....	14,932	9,000	

Thus we see that if after 31 months the auto and horse and buggy were offered for sale with their 2-3 depreciation they would have cost \$975 and \$990 respectively. In neither case did I count the expense of a driver, but that would be about the same in either case. Therefore, after 2½ years' constant use (have only missed using the machine thirty-two days) I am led to think that the automobile is from the essential points of cost, mileage and time, to be preferred to the horse. Of course, you have to treat an automobile in an en-

tirely different manner from a horse, and any one expecting to run an automobile according to horse rules will be badly left.

I have never been an automobile enthusiast and don't care especially to ride in them just to be riding, but for any person who has to go in a hurry and any distance at any time, an automobile will beat a horse to a standstill. After careful inquiry among my doctor friends I find that I save \$3 to \$5 per month on night calls by using my machine in place of going on the cars or hiring a cab.

C. E. FERGUSON, M.D.
Washington, D. C.

Suggestion for Manufacturers.

Editor THE AUTOMOBILE:

Sir:—When a double-tube tire on a run-about explodes on the road and an extra casing is not carried, repair is possible only by covering the shoe with some heavy canvas and wiring it on. Why does not some manufacturer supply the market with a braided rope of some suitable fibre, made of proper size to fit 2½ and 3-inch tires, and cut to the right length, so that, in case of an exploded casing, or a puncture that could not be readily repaired, this piece of rope could be slipped in, in place of the inner tube, and the automobile run for the rest of the trip without injury? Or, instead of a woven rope, perhaps a rubber hose could be made and stuffed full of curled hair or other material, and which could be coiled and easily carried for use in such emergencies.

M. S. RECOR.

Springfield, Mass.

Ode to an Automobile.

Editor THE AUTOMOBILE:

Sir: You are at liberty to print the following verses to my automobile, penned to the meter of "The Old Oaken Bucket."

How dear to my heart is our little 'mobile
That stands in the shed, so shining and grand.
It has served us so faithful for more than a twelve-month,
And will travel all over the face of the land.
The wide spreading seat and the guide lever by it—
The switch and the lock where the starting crank turned;
The throttle and brake and the speed lever nigh it;
To use these in order I very soon learned.
The soft-cushioned 'mobile I hail as a treasure.
For often at night when returned from the field,
I found it a source of exquisite pleasure—
A neat fascination to which I would yield.
How eager I'd seize it with eyes that were glowing,
Switch on electricity, gas and crank then,
And quick down the road we soon would be going,
And cooled off, come back the happiest of men.
How oft from the old horse's shed we will take it
And clean it and dust it and grease it with care,
And the ride is surely a realization
Of the long cherished dreams of castles in air.
And when I'm removed from this loved situation,
The tears of emotion most surely will well;
When fancy roves back to our Olds Automobile,
And all the fond memories that with it doth dwell.

Oasis, Iowa.

L. C. GREENE.

HINTS ON OPERATING A RUNABOUT.

LOSS of compression in a gasoline motor is synonymous with loss of power, and an evident falling off of the usual hauling capacity of a motor may sometimes be traced to this cause. If the leakage occurs at any point within sight, the defective place can usually be located by the sound of the escaping vapor or by the appearance of the surfaces adjacent to the leak. If the machine has been running for some time it may with reason be suspected that the valves require grinding, as valves occasionally will, however good they may be. If it is decided that this should be done, do not go at the job as if it was necessary to grind off a large amount of metal, but bear in mind that only a very minute reduction will bring the valve down to a bearing all around, if the work is properly done. Clean the valve and its seat. Mix a small quantity of the finest flour emery with ordinary lubricating oil to the consistency of a thin paste. Put the end of your finger in this mixture and transfer what sticks to it onto the bearing portions of the valve and seat, distributing it fairly evenly over the surfaces. Put the valve in place and turn it a few times to complete the distribution of the emery and oil, and then the actual grinding may be commenced. Exact only a gentle pressure on the valve, moving it through say quarter or half a turn, and raise it off the seat every half dozen turns. In again bringing it down on the seat turn it so that the same surfaces will not again be in contact. You will find that every time the valve is raised and replaced, after a little grinding, the emery seems to regain its sharpness.

Watch and see that the emery is evenly distributed at all times during the grinding, as otherwise it may cut grooves, slight but most undesirable, in the bearing surfaces. After grinding for a short time—it is impossible to say how long, as this depends altogether on the condition of the valve—wipe the valve and seat clean and again rub them together, as in grinding, but with only a small portion of a turn. Then examine the surfaces and see if there are evidences of close contact at all points. Wherever the surfaces have been pressed together and rubbed one upon another they will have a peculiar burnished appearance very readily recognized. It may be mentioned that if the valve is turned completely around, or nearly so, while testing the result of the grinding, any low spots on one surface might be brought in contact with high spots on the other, and thus give the appearance of a perfect bearing. One who is not an expert may be quite easily deceived in this manner. If it is found that there are still low spots, the grinding must be continued until they disappear. In other words, the entire surface must be brought down to the level of the lowest spot, and in doing a good job of grinding only this

amount of metal will be removed. A little practice will soon make the grinding process quite an easy one.

A few things should be noted by the inexperienced. Do not attempt to put more pressure on one part of the valve than another, with the idea of reducing that part more rapidly than the rest of the surface, but keep the pressure as nearly uniform all around as possible. Do not seat the valve with a thump, as it may imbed the emery in the surfaces. Do not make the mixture of emery and oil too thin, or it will run off the surfaces. On the other hand, if it is too thick, it will not spread evenly and will not cut well. A very important point is to clean off the valve and seat very thoroughly after grinding, washing well with gasoline, and be quite certain that none of the emery gets into the cylinder. Emery is awful stuff when it gets loose where it is not wanted, so see that none of it gets into the cylinder either during grinding or afterwards. If the surfaces are not thoroughly cleaned before testing the film of oil and fine emery may make the job look better than it really is, so look out for this. And, though it hardly seems necessary to mention it, be sure there is no emery sticking to the valve stem. It is not necessary to say what it would do.

* * *

We will now suppose that the valves are perfectly tight and that there are no leaks in evidence, but still the motor, while operating faultlessly in other respects, seems weak. Try the compression carefully. Put a little kerosene in the cylinder and give the crank several rapid turns to loosen things up as they are when hot. Then close the relief crank so as to hold the charge in the cylinder and with the crank bring the piston up against the compression and, applying some force, see how long it takes for the charge to escape and allow the piston to pass the centre. This test is a comparative one, however, and it is necessary to have an idea how long the compression will hold when the motor is in good condition and developing its full power. In this, as in most other matters, "touchin' on an appertainin' to" automobiles, experience is the best possible guide, and an occasional trial of compression will give a basis for making comparisons. If it is found that the charge leaks away with undue rapidity, it can but be concluded that the leak is inside the very heart of the whole machine—the cylinder. If this is the case it is a job for the repair man. The cylinder may be cut and grooved—thought it is to be hoped not. The most likely trouble is leakage past the rings. New rings will usually settle this, if you are lucky enough to know of a man who can make a good job of putting new rings into an old cylinder. In any case you cannot do the work yourself unless you are something of an

expert, in which case you will not need these hints.

* * *

Kerosene is an oil that is not always appreciated at its true value by automobilists. One of its most valuable features is that it can be obtained anywhere, and many an automobilist has been saved from the disgrace of a tow home by putting kerosene in his gasoline tank. Many motors will run fairly well on kerosene if it is fed to a hot motor. Starting cold on kerosene is, however, quite another matter. It might be interesting to try your motor on kerosene to see how it would work if stress of circumstances compelled its use. Run your motor on gasoline until it gets as hot as it will—the hotter the better, as long as it does not overheat—and then, having a little gasoline remaining, put enough kerosene into the tank to make it about a half-and-half mixture. If this works well increase the proportion of kerosene until the tank contains practically pure kerosene. It is probable that things will get sooted up, and that there will be a good deal of smoke floating around before you finish the experiment; but air and fuel adjustments may help this, and in any case you will have the satisfaction of knowing just what to expect. Kerosene will require more air than gasoline. Kerosene is also an excellent thing to inject into the cylinder when leaving your motor after a run, keeping the lubricating oil from clogging and making it easier to start the motor next time. Put it into the motor while hot and give the starting handle a few whirls—with the current cut off. This is a wrinkle much in use by French chauffeurs. In fact, some motors are fitted with a special kerosene tank, piped to the cylinders, so that the motor can be "purged" after a run by turning a valve.

* * *

Here is a good way to make a spark plug joint if you do not happen to have a packing washer at hand. Take a piece of copper wire, of about the thickness of stove-pipe wire, and make a ring with the ends slightly overlapping. Bevel off these ends by a tap of the hammer so that they will lie about on a level with the rest of the ring. Then heat the wire red-hot and plunge it into cold water. This will make it very soft, and should be done last of all, as manipulating the wire tends to harden it. Screw the plug down hard on this soft copper ring and, if the job is carefully done, a first-class joint should be the result. The same method may be employed for making any joint where there is sufficient pressure to somewhat flatten the copper wire.

MELBOURNE, Australia, recently held an automobile race meet, one of the features of which was a 220 yards backward race for automobiles.

Patents

Double Brake.

No. 764,325.—A. Winton, of Cleveland, Ohio.

A brake drum attached to the rear wheel hub and acted on by internal and external brake bands, substantially of the character shown in the illustration. One end of each band is anchored to a bracket rigid with the rear axle, and the other is tightened by the levers shown in dotted lines.

Planetary Speed Changing Gear.

No. 763,477.—F. G. Gies, of Detroit, Mich.

On the driving shaft 1 is a loose sleeve, on which pinions 4 5 are integrally formed, and to which sprocket pinion 6 is rigidly

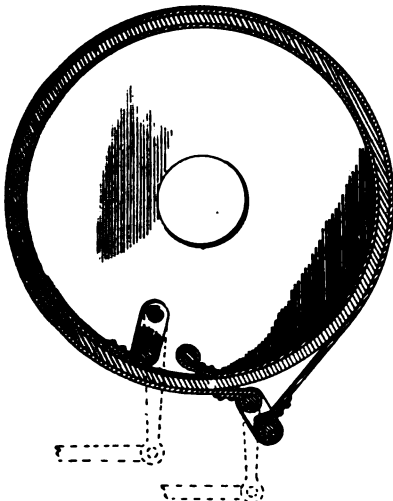

WINTON DOUBLE BAND BRAKE

secured. Drum 9 and a clutch-drum 23, rigidly secured together, are arranged to turn loosely on the shaft and sleeve. They carry a suitable number—as three—of pins,

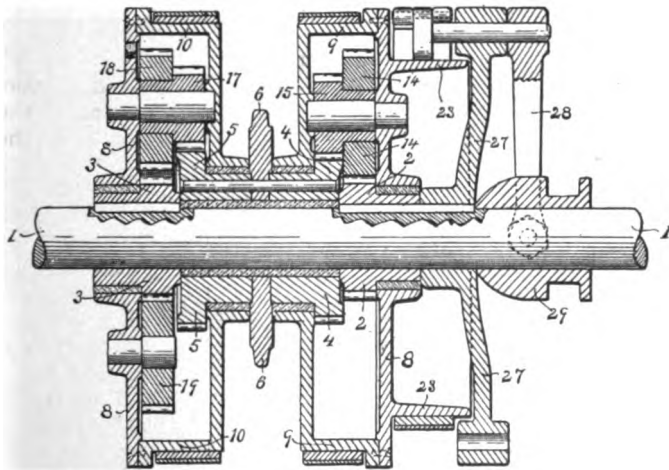

GIES PLANETARY SPEED-CHANGING GEAR.

on which are mounted pinions 14 15 rigidly secured together. The latter meshes with pinion 4, and the former with pinion 2 keyed rigidly to the shaft. The clutch spider 27 is also keyed to the shaft, and the clutch

is tightened by the action of a thimble 29 spreading two arms 28, which tighten an exterior friction band on drum 23. When this band is tightened there can be no relative movement between any of the parts, and the direct or high speed is produced.

For the slow forward speed a band on the surface of 9 is tightened, thus rendering stationary the points on which pinions 14 15 turn. Then the motion is from 2 through 14 and 15 to pinion 4 and sprocket pinion 6, the ratio of diameters being such as to produce a slower speed in 6. For the reverse a drum 10 is provided, which turns loosely like the other, and is rendered stationary by tightening the band around it. The drive is through pinion 3, intermediate pinions 19, and pinions 18 and 17 to pinion 5. The movement is thus exactly as for the slow forward speed, except that it is reversed by pinions 19.

Automatic Frame.

No. 763,494.—Louis Lacoïn, of Paris, France.

A frame in which the rear and forward portions are constructed separately. To the former the body and rear axle are attached, and the motor and transmission gearing are mounted on the latter. The

two halves can then be joined together, and can readily be separated for the substitution of a different body. Plan views of the rear and forward portions are given, and a side elevation in section of the forward portion, from which it will be seen that the two

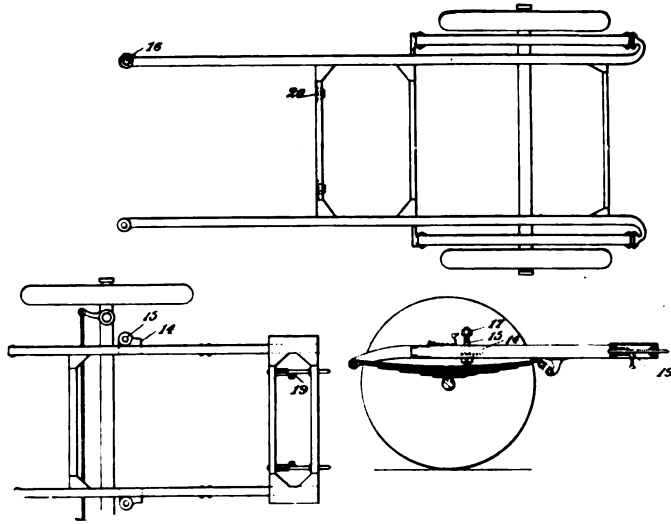

LACOÏN SEPARABLE FRAME, PLAN VIEWS AND ELEVATION.

are attached at two points on each side. A bracket 14, and bolt and nut 15 17, connect with eyes 16 at the front ends of the rear portion. The other connections are made by bolts or pins 19, which in the form shown are arranged much like door-bolts,

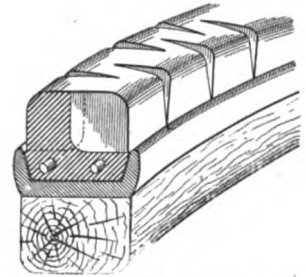

KURTZ NOTCHED SOLID TIRE.

and can be slid in and out of the sockets 20, which they engage. One advantage claimed for the invention is the convenience of assembling the motor and transmission gear on the frame separately from the assembling of the body and other rear portions.

Solid Tire.

No. 763,909.—A. S. Kurtz, of Springfield, Ohio.

A solid tire giving special flexibility by cutting in it the notches shown.

JOHN BREUNER, of San Francisco, accompanied by a party of four in a touring car, recently drove from Santa Cruz to Oakland, a distance of 135 miles, in five hours and thirty minutes, which is record time for the trip. The former record, six hours, was held by W. K. Vanderbilt, Jr.

A MOVEMENT is under way among motorists and cyclists of Muskegon, Mich., to hold an automobile and cycle race meet during the Fair in September.



VOL. XI.

No. 5

Published every Saturday by

THE CLASS JOURNAL CO.,

Flatiron Building, Madison Square,
NEW YORK CITY.Cable Address - - - Autoland, New York
Long Distance Telephone - 300 Gramercy, New York

SUBSCRIPTION RATES:

United States, Canada and Mexico, - One Year, \$2.00
Other Countries in Postal Union, - One Year, \$3.00To Subscribers—Do not send money by ordinary mail.
Remit by Draft, Post-Office or Express Money Order,
or Register your letter.

FOREIGN SUBSCRIPTION AGENTS:

ENGLAND:—Hiffe & Sons, Limited, 3 St. Eekle Street,
Ludgate Circus, London, E. C.FRANCE:—Boyveau & Chevillet, 22 Rue de la Banque,
Paris.

GERMANY:—A. Seydel, Mohrenstrasse 9, Berlin.

To Advertisers—Copy or changes in orders for advertisements should reach us not later than 5 o'clock p. m. Monday for the issue of Saturday following.

Copyright, 1904, by The Class Journal Company.
Entered at New York, N. Y., as second-class matter.

The Automobile is a consolidation of The Automobile (monthly) and the Motor Review (weekly).

Copies Printed This Issue, - - 12,000
" " Since Jan. 1, - 373,300**Awads
for
Attendance.**

Attention is recalled to the "service test of motor wagons" conducted by the Automobile Club of America last April by the publication of the report of the Contest Committee of the club. This document in the shape a pamphlet of more than 100 pages has just been distributed to the interested parties and the members of the club. As will be recalled, the test was held in New York city, and extended over a week, during which the commercial vehicles were placed in the service of the American and Westcott Express Companies in the ordinary routine of delivery work, the performance of the vehicles being noted by official observers appointed by the club. There were seventeen starters and of these fifteen completed the required program. The remaining two, one a heavy steam truck and the other a gasoline delivery wagon, only completed one day's test and were then withdrawn. Of the fifteen that finished eight were fitted with gasoline engines, six were electric vehicles and one was equipped with a "combination" motive power plant.

Considering the fact that several of the vehicles were of an experimental character, and had had little or no preliminary testing out under ordinary service conditions, the showing made was indeed remarkable. This view was evidently held by the Committee which appears to have let its enthusiasm run away with its judgment and distributed medals as rewards for participation in the contest rather than for excel-

lence of performance. Its action recalls the diplomacy of a private school management which, unwilling to go to the length of giving each scholar a prize for merit, soothes the feelings of the dunces' parents by awards for attendance.

Of the fifteen that finished fourteen received medals, and only one, the Lansden, achieved the more distinguished honor of getting no prize at all.

According to the rules of the contest awards were to be "based on economy of operation in time and fuel, ratio of paying load, ton mileage, and general reliability and availability for service." It would be interesting to know how the Committee apportioned the marks in awarding the medals. Following the rules of the old shipboard game of "put the eye in the pig," it apparently shut its collective eyes and made a mark. This had only to be repeated often enough to pick a winner.

The most absurd case, perhaps, is that of the 4,000-pound Union Motor Truck, the sole entry in Class 4. According to the published schedule of the observers this vehicle had fifteen stops for repairs and adjustments that occupied seven hours and eleven minutes in all. On the fifth day of the trial the notation "Connecting rod broken" appears in the record and further along a broken crank case is referred to. Yet this vehicle is awarded a gold medal, which can be exhibited long after the details of the performance are forgotten. We have no criticisms to make of the machine. On the contrary, it is an excellent one and we have favorably noticed its past performances in these pages. It was the fortune of war, or trial, however, that it met with mishap, and we doubt very much if the builders themselves expected to do else than stand manfully on the record.

Another instance of looseness of award appears in Class 3, in which the Knox wagon, with a perfect record as regards repairs and a performance of great merit in delivery service, was awarded a silver medal, while a Consolidated delivery wagon in the same class received a gold medal. The published record of the latter does not show an equal superiority of performance. It is possible that the Committee was influenced in its decisions by other facts connected with the performances of the wagons that do not show in the published record. As this record, however, contains all the data made public it must be accepted on its face value as showing the respective merits of the cars. The awards considered by themselves are inconclusive.

Typographically, the report has been excellently prepared, and its information as to actual performances is well supplemented by descriptions of the various wagons and excellent half tone illustrations.

It is a very complete document of its kind, containing not only the summaries of performances but the rules and regulations and reproductions of the official observers' blanks.

**Benefits of
Legal
Knowledge.**

Every automobile agent, whether his sphere of operations be extensive or limited, should have a more or less thorough understanding of the laws of business, especially sales and contracts. In fact, it ought to pay any one who expects to enter upon and follow this occupation to spend some time in the deliberate study of mercantile law. This point is not being overlooked by many astute business men with respect to their sons and junior partners generally. Such experience and equipment would be of advantage primarily to escape litigation, and secondly to know when you have the law on your side, especially when dealing with dishonest persons of whom, unfortunately, the supply is greater than the demand.

An automobile agent without this training and equipment, but whose business relations are more or less complicated, will frequently find it a positive economy to choose at the outset of his business enterprise an able attorney, with whom to consult before concluding any important contract or entering upon any other undertaking. The younger members of the legal profession are not to be overlooked in making this choice, for although they have had, of course, less experience than the older ones, they are usually more thorough in their researches and more careful to advise their clients on the safe side.

Business men who are known to have a personal knowledge of legal matters, or else known to have good counsel, are less apt to be troubled by "bluffers," and are freer from litigation generally than those who rely entirely upon their own judgment. And then, too, some acquaintance with legal principles invariably makes for that sort of conservatism which saves trouble without curbing enterprise.



Overconfidence of Automobillists. An increasing number of automobile accidents, especially at grade crossings, is reported by the daily press of various sections throughout the country. At this time of the year when out of door life is enjoyed by thousands of persons, especially city folk, who at other seasons would not spend such a large percentage of time in health and enjoyment seeking, it is only reasonable to expect an increase of automobile mishaps in common with those of a more familiar character, such as drownings, runaway accidents and the like. A careful reading of reports published in local papers and those received from our own correspondents shows that in nearly every case the mishap has been largely the fault of the automobilist. Leaving out of account reckless drivers who are sure sooner or later to meet with mishap if not to the passengers at least to the machine, most accidents are caused by overconfidence of otherwise careful persons.

In the majority of instances the accidents have happened to touring cars rather than

to runabouts and light machines. As we have said, overconfidence is really at the bottom of most accidents, especially collisions. The driver of the big touring car who has either graduated from the runabout or has gained his entire experience with the big car, gets so accustomed to safe travel that he forgets the possibility of mishap. There is no special providence watching over touring cars any more than over horse-drawn vehicles, or pedestrians for that matter.

The usual history is that the driver of a large car, taking his experience under ordinary conditions of travel as a measure of the probabilities and possibilities, is quite unprepared for extraordinary and unusual situations when they arise. He is accustomed, for example, to dash over grade crossings when no train is in sight or when a train is visible and distant, and some day he attempts the same feat with, perhaps, fatal results. His judgment of speeds and distances is at fault and he has forgotten that the self-control he exercises under ordinary and usual circumstances is no guarantee of "presence of mind" in emergencies. This not uncommon type of man has no appreciation of the natural laws that govern the operation of his machine, and to questions of momentum and impact at high velocities he has never given any serious thought. So he goes cheerfully on his way, always ready to act as his own executioner or that of any innocent person who as a passenger trusts his "skill," and he gives argument to the autophobes to class the automobile as a *dangerous* machine.

A little less hurry to tour and to take chances and a good deal more intent to know himself and his machine is better than any amount of insurance, accident or life.



The decision of Judge Kellogg, of the District Court in Westfield, Mass., that the owner of an automobile cannot be convicted on the charge of excessive driving merely by the identification of his machine by its registered number, but that the identity of the driver must be determined at the time of the alleged infraction of the law, raises the question whether any one can operate a registered car other than the person to whom the license was issued. The magistrate's decision is manifestly just, as the mere fact that one person owns a car is not sufficient evidence that he was driving it at excessive speed. If any one else were breaking the law in it, the owner could not reasonably be held responsible for the act. And if an unlicensed person has not the right to drive a registered machine owned by another, he and not the owner would be breaking the law if he ran such a car, even within the legal limits, as has been held recently by a judge in another city.



Was an accident to a gasoline automobile ever reported in a daily paper without the accompaniment of "hissing steam" and the "explosion" of a gasoline tank?

Flying Kilometer Cut to 21 3-5 at Ostend.

In an attack on the world's flying kilometer record, the holder, Rigolly, lowered the figures to 21 3-5 seconds at the Ostend meet July 20. The existing record was

To get the record down to the present figures he traveled at the terrific rate of speed of 103.27 miles an hour. It was expected that Rigolly would lower his own figures on



RIGOLLY IN THE GOBRON-BRILLIE RECORD BREAKER AT THE OSTEND MEET.

23 3-5, made by Rigolly at Nice on March 31 last. In both successful attempts he drove the now famous Gobron-Brillie car.

the Ostend-Snaeskerke road, as the course is very fast and there is lots of room at the ends for gathering speed and stopping.

GORDON BENNETT PLANS.

British Auto Club Decides to Enter in the 1905 Contest.

Special Correspondence.

LONDON, July 6.—The Automobile Club of Great Britain and Ireland has decided not to withdraw from the Gordon Bennett contest of 1905, which will be arranged by the Automobile Club of France, presumably in the French Ardennes, and will send in its challenge for the Cup. This decision was arrived at in a meeting of the club committee on July 4, with Colonel Holden in the chair. In his introductory remarks, Col. Holden referred to the various suggestions that have been made by technical members of the club, for restricting the cup race to cars of moderate power and touring speed, and stated that the Hamburg conference decided to consider these and any other measures proposed by other clubs at the annual meeting of the International Commission on December 10. Should any alterations be accepted, however, they would only affect the race of 1906. Mr. Edge then raised the question of England's participation in next year's event, which he considered due to the reputation of the British industry. After some discussion it was decided, thanks to a very effective speech by the chairman of the Race Committee, Mr. Bird, to challenge France for next year's race, and this resolution was announced with the following appendix: "Any racing car designed to comply with the existing racing rules of the Automobile Club of France which may be driven on the public highways above the legal limit of the United Kingdom (unless authorized) shall be liable, with its owner and driver, to be disqualified by the A. C. G. B. I. from taking part in the Gordon Bennett or any other race."

This is a preventive against undue speed in carrying out tests on English roads and will send them in all likelihood over to France for preliminary trials.

Mr. Edge has announced his decision of

entering three cars, the Wolseley Co. will also be certain starters, whilst Messieurs Mark Mayhew and his Napier that did so well on the Riviera and Lionel de Rothschild on a Siddeley represent the purely amateur element. Other entrants are expected, but with eight at once at hand, as the Wolseley will surely nominate their three cars, the A. C. G. B. I. can set to work to commence preparations.

BIG MEET FOR BUFFALO.

Automobile Racing Association Gets Sanction for August 12 and 13.

Special Correspondence.

BUFFALO, July 25.—A big two-day automobile meeting is to be held at the Kenilworth race track August 12 and 13. This was decided at a recent meeting of the Automobile Racing Association; a recently incorporated organization of Buffalo men, which has secured sanction to conduct this meeting and signed a contract for the use of the track. Preparations are well under way to make this, the first meet ever held locally, a most successful one. Kenilworth is one of the prettiest race tracks in the country and also one of the fastest. Every effort will be made to bring all the famous racing cars here for this occasion.

The Automobile Racing Association has elected the following officers: President, A. H. Knoll, vice-president Buffalo Automobile Club; first vice-president, W. C. Jaynes; second vice-president, J. A. Cramer; secretary, C. W. Roe; treasurer, J. B. Eccleston; director, F. J. Wagner, secretary of the Buffalo Automobile Club.

Mr. Jaynes says he will have the *Winton Bulletin* here; Mr. Cramer has promised the *Ford 999*; Mr. Roe will see to it that the Peerless racers are entered; Mr. Eccleston has given assurance that the *Grey Wolf* will be present, and it is promised that Eddie Bald will compete in the races—the first time the Buffalo ex-bicycle champion has been seen in an automobile race. D. H. Lewis will have direct charge of the meet.

TWO DRASTIC NEW CHICAGO ORDINANCES.

Remarkable Provisions of Licensing and Numbering Measures Passed This Month, Whose Legality Will Be Tested by Chicago Automobile Club.

Special Correspondence.

CHICAGO, July 25.—An important meeting of owners of automobiles will be held at the Chicago Automobile Club Wednesday night for the purpose of securing an expression of opinion from the club members on the ordinance recently passed by the city council. This ordinance will become effective in a short time unless the club takes steps to secure modifications. The board of directors of the club propose enjoining the authorities from enforcing the ordinance, bringing a friendly suit to test its legality.

The ordinance requires that every person shall pass an examination before a board consisting of the city electrician, the commissioner of health and the city engineer before being permitted to operate an automobile on the public thoroughfares of the city. The rules of the examination provide that the applicant shall have the free and full use of both arms and hands and shall not be less than eighteen years of age, that he shall have good eyesight, or if he wears glasses they shall be securely fastened to the head by spectacle frames; that he must have good hearing, be free from epilepsy or heart disease and must not be addicted to the excessive use of alcoholic liquors or injurious drugs; that he must not be of reckless disposition nor subject to fainting spells; that he must be able to guide his machine through crowded streets, be able to stop and turn suddenly and must show ability for quick and decisive handling of the machine in emergencies; applicant must state type of machine to be operated and give a full description of it and its equipment and show familiarity with its mechanism; must state his experience in operating such machines and record accidents he has had, if any; must be familiar with this and other ordinances of the city governing the use of public streets.

Having passed the examination, the applicant shall have issued to him a numbered permit card, good until April 30 next after date of issue, entitling him to run such a machine in the streets. For this privilege, or, as the ordinance naively puts it, to "defray the expense of the regulation provided for," each applicant so examined shall pay \$3. Renewals of certificates may be secured at a cost of \$1 without re-examination, unless the certificate has been revoked.

SPEED LIMITED TO TEN MILES.

The ordinance also limits speed anywhere in the city to ten miles an hour, and when turning corners to four miles. It requires the fitting of a bell or gong of not more than four inches diameter which shall be sounded at street crossings and whenever or wherever else deemed advisable by the operator. It must have at least two brakes or sets of brakes, one of which shall be independent of the driving gear, and either of which shall be sufficiently strong to bring the car to full stop within ten feet when moving at a speed of ten miles an hour. One or more lighted lamps must be carried conspicuously whenever the vehicle is in motion on the street after dusk and before dawn. No part of the machinery shall be left running while the vehicle is left standing in the street unattended.

Having passed examination for one type

or class of machine, no person shall operate any other class of automobile except that specified in his certificate. Penalty for violation of any of the provisions of the ordinance is a fine of not less than \$5 nor more than \$25 for each offense.

Section 11 of the ordinance provides that any certified operator who shall "be fined for a breach of this ordinance or any ordinance that is now or may hereafter be in force requiring the numbering of such machines, or regulating the operation thereof, may have his certificate revoked by the mayor of the city of Chicago upon recommendation of the said board of automobile registration."

Section 13 repeals the old ordinance passed July 6, 1899, and the amendments to it, and also all other ordinances in conflict with the provisions of the proposed new law, but specifically provides that such repeal shall not affect prosecutions or suits pending under the previous ordinances.

NUMBERS FIVE INCHES HIGH.

In addition to the foregoing ordinance, the city council passed on July 11 an ordinance amending the numbering ordinances of June 8, 1903, and October 26, 1903, so as to require the affixing to automobiles of identification numbers and letters not less than five inches high, painted in white lines five-eighths of an inch wide at every point and the numbers and letters placed three-quarters of an inch apart, on plaques of dark color. The numbered signs are to be furnished by the examining board, but the lettered signs are to be furnished by the owner of the car, and the letters may be painted directly on the car, provided the body of the car is painted black at that particular place. The plaques must be attached so that they will not sway in any direction independently of the motion of the car, and the numbers and letters must be displayed on the rear of the machine in plain sight as near the middle as possible and low enough so as not to be hidden by the hood or other obstruction on the car. The numbers must be in Arabic numerals and the letters in plain capital type.

MUST RENEW ANNUALLY.

Again "to provide for the expense of such assignment of numbers and such registration, each person so applying for a number shall pay to the City of Chicago, at the time of so applying, the sum of \$1." As the registration is good only until April 30 next following, a new number must be obtained each year at a similar charge.

Section 9 requires all automobiles when in use on the street from sunset to daybreak to carry one or more lighted lamps that shall throw a red light directly to the rear of the machine and a white light on the letters and numbers. A fine of \$5 to \$25 is provided for violation of this numbering or registration ordinance.

VEHICLE TAX FOR COLUMBUS.

Special Correspondence.

COLUMBUS, Ohio, July 25.—City Solicitor Butler is preparing a vehicle tax ordinance that will place a burden of from \$3 to \$6 per year upon owners of automobiles. In addition the bill will require that each vehicle shall carry a number to show that the tax has been paid. But the city already has an auto registration ordinance requiring that a number be carried and the owners are taxed \$1 for the license. Mr. Butler is at a loss to reconcile the two ordinances. Again the registration fee may be construed as a tax that owners will object to paying. Mr. Butler will probably recommend that the registration tax law be annulled and the vehicle tax increased enough to cover it.

GENERAL HOLD-UP OF BOSTON MOTORISTS.

Of 234 Drivers of Cars Stopped and Examined Simultaneously Throughout the City by the Police, 126 Had Failed to Comply Fully with the Law.

Special Correspondence.

BOSTON, July 23.—Some startling information concerning the failure of the automobilists of Boston to comply with the automobile registration law was put before the Highway Commissioners to-day in the form of the report of the police commissioners on the inspection of automobiles that was conducted by them on Wednesday of this week.

It had been rumored in the newspapers for weeks that the police were planning a general round-up of automobiles on a certain day, and the date had been unofficially set once or twice. Even with this warning, however, many of the automobilists were caught napping, and the report shows that only a little more than half of the motorists "held up" had complied with the law in every particular. The examination of automobiles on Wednesday was conducted simultaneously in all sections of the city. At 3 p. m. the police of all the precincts began to stop every automobile that came along. This was continued up to 5.30 o'clock, and in two hours and a half 234 machines were examined. The points which the police were required to ascertain were whether the certificate of registration, properly filled out with owner's name and residence, and with the number of the machine, was on the car; whether the automobile bore numbers at front and back and on the lamps as prescribed by the law; whether the operator had his certificate, license or badge; whether the machine had the lamps required, and whether the numbers on the machine corresponded with the numbers on the certificates.

Of the 234 automobiles that were stopped and examined only 126 complied with the law in every particular, not including a New York and a Pennsylvania car which were held up and found to be complying with the requirements of the laws of their respective States. Sixty-two operators failed to produce their certificates and in twenty-nine instances no license was carried on the car. Thirteen chauffeurs were without their licenses. Thirty-five cars had no numbers on their lamps and five had no lamps at all. In one case the numbers on the lamps did not agree with the numbers on the certificate, and in another case the lamp numbers were not the same as the numbers on the front and rear of the machine. In another instance there were no numbers at all on the auto, and two cars carried number plates different from the kind authorized by the Highway Commissioners. In several cases numbers were missing from the front or the rear of the cars. Twenty-one chauffeurs were without their official badges.

The police took the numbers of all the automobiles that were examined and gave a list of these to the Highway Commissioners. What action the latter will take in the cases of those who did not comply with the law has not yet been announced. It has been said that the Boston police and the Highway Commissioners are to cooperate in stopping violations of the law, and that the Highway Commissioners will take steps toward the revocation of the licenses of automobilists who violate the speed laws or who do not conform to the registration law.

AMERICAN AND FOREIGN AUTOMOBILE AND AUTO BOAT FIXTURES.

Automobiles and Motorcycles.

July 25—Aug. 10.—American Automobile Association Tour to St. Louis.
 July 30.—Race Meet, Newport, R. I., Newport Amusement Association.
 Aug. 1-3.—Bexhill Meet and Races. England. A. C. G. B. & I.
 Aug. 6.—Second Annual Meeting of Missouri and Kansas Auto Association, at Leavenworth, Kan.
 Aug. 11.—Automobile Day and Parade at the World's Fair, St. Louis
 Aug. 12-13.—Race Meet at Kenilworth Track, Buffalo. Automobile Racing Association.
 Aug. 15.—Ventour Hill-Climb. Avignon, France.
 Aug. 17-18.—Races at State Fair Grounds, Minneapolis.
 Aug. 19-20.—Race Meet at Glenville Track Cleveland. Cleveland A. C.

Aug. 21.—Semmering Hill Climb, Austria. A. C. of Austria.
 Aug. 21.—World's Fair Race Meet St. Louis Fair Grounds Association,
 Aug. 22-Sept. 4.—French Industrial Vehicles Trials, Paris. A. C. of France.
 Aug. 29-Sept. 3.—British Small Car Reliability Trials. A. C. G. B. & I.
 Sept. 2.—Chateau Thierry Hill Climb, France. A. C. of France.
 Sept. 16.—Race Meet, Poughkeepsie, N. Y., Dutchess Co. Agricultural Society.
 Oct. 5.—Dourdan Kilometer Trials. *Monde Sportif*.
 Oct. 8.—Vanderbilt Cup Race, Long Island, N. Y.
 Oct. 9.—Gallion Hill-Climbing Contests. France. *L'Auto*.
 Oct. 16-25.—Leipzig Cycle and Motor Show, Germany.
 Nov. 20.—French 100-Kilometer Trials, Algeria.

Auto Boats and Launches.

July 30.—Harmsworth International Cup Race. The Solent, England.
 July 30.—Atlantic Yacht Club Races. Sea Gate, N. J.
 Aug. 1-4.—Motor Boat Races. Ostend, Belgium.
 Aug. 5-11.—Paris-Deauville Motor Boat Race.
 Aug. 6.—Larchmont Yacht Club Races.
 Aug. 7.—Exhibition of Competing Boats at Calais.
 Aug. 8.—Calais-Dover Races. Recoupe Cup.
 Aug. 10.—Calais-Boulogne Races.

Aug. 12.—Gaston-Menier Cup Race. France
 Aug. 13.—Manhasset Bay Yacht Club Races. L. I. Sound.
 Aug. 13-14.—Calais-Dover-Calais Race. English Channel.
 Aug. 18.—New York Yacht Club Races.
 Aug. 14-22.—Paris-to-the-Sea Races.
 Aug. 15.—Calais-Boulogne-Calais Races.
 Aug. 20.—Brooklyn Yacht Club Races.
 Aug. 27.—Larchmont Yacht Club Races. Long Island Sound.

READY TO FIGHT.

Milwaukee Club, Under Minister's Leadership, Will Test Ordinance if Passed.

Special Correspondence.

MILWAUKEE, July 25.—This afternoon the common council referred the ordinance providing for the numbering and licensing of automobiles to the clerk for engrossment and a third reading. Contrary to the plans no opposition was offered by the Automobile Club when the measure was brought before the council, the committee to whom was entrusted the duty to oppose hostile legislation preferring to await the action of the council before showing its hand. The club will make its fight on the ground that an ordinance of this nature converts vested rights into privileges, and it is among the possibilities that the Supreme Court of the State will be called upon to decide whether it is class legislation to require the numbering of one class of vehicles and not another. The contest promises to be a bitter one.

Rev. Szukalski, president of the club, when asked for a statement, said:

"Most certainly we will oppose the action of the council, and the matter will be taken to the court for a decision. The club refuses to wear a tag. We are opposed to being made victims of class legislation, which this would be, as we consider that we have fully as many rights as other American citizens. I would not object to numbers being placed on automobiles if such a requirement was made for all other vehicles in the city, for in that event all would be treated alike, but unless that is done the measure will be opposed.

"Precautions of this nature are no more imperative as applied to automobiles than to horses. People are no more liable to be injured by an auto than by a runaway. A short time ago a number of persons were injured by a runaway in this city, and so far as I can learn the police have not as yet discovered to whom the outfit belonged. I believe this justifies our position that automobile owners should not be discriminated against in such a manner.

"With reference to the speed ordinance in force in this city, which places limitations of four miles at street crossings and eight miles between the crossings, I will say that I believe the average speed should be about eight and fifteen miles an hour."

Rev. Szukalski is an enthusiastic automobilist and makes it a point to be present

at all meetings of the club at which important matters are likely to be called up for discussion. Many physicians have demonstrated that the auto has widened their field of work, and Rev. Szukalski has shown that this is true of the ministry as well.

NEW ORDINANCES FOR CLEVELAND.

Special Correspondence.

CLEVELAND, July 25.—City Clerk Peter Witt has in preparation an ordinance that provides for the replacing of numbers on automobiles with letters three inches high. The numbers, he says, were all right so long as they contained only three figures, but after they pass the thousand mark, policemen have much difficulty in making them out. Mr. Witt has a scheme by which all machines may be labeled with two letters. These being large, there will be no difficulty in distinguishing them at a distance.

A member of the city council is also preparing an ordinance that will prevent children from operating autos on the streets in the business district. He says that children do not have the mature judgment of their superiors and are naturally given to risking too much, even when they are able to keep their machines under perfect control. For this reason they are constantly exposing others to danger as well as themselves. The ordinance will apply only to the streets that are constantly crowded with vehicles and pedestrians.

MANHASSET BAY LAUNCH RACES.

The Manhasset Bay Yacht Club held a race for auto-boats on July 23, the courses being laid on Manhasset Bay and Long Island Sound, 12 1-2 miles for the larger boats and 6 1-4 miles for the smaller ones. There were but six starters. The official summary is as follows:

Class A.—Course, 12 1-2 miles.	
Boat and Owner	Elapsed Time
Miss Swift, Robert Jacob.....	57:21
Class B.—Course, 12 1-2 miles.	
Ardis, R. M. Haddock.....	1:11:26
Dolphin, E. M. Graef.....	1:24:47
Class C.—Course, 6 1-4 miles.	
Express, G. T. Wilson.....	42:59
Suis Moi, G. M. Plympton.....	46:49
Midge	56:10
The winners were Miss Swift, Ardis and Express.	

MOTORCYCLES EXEMPT.

Buffalo Corporation Counsel Says State Law Does Not Apply to Them.

Special Correspondence.

BUFFALO, July 25.—The corporation counsel of this city has decided that under Chapter 538, of the laws of 1904, a motorcycle is not classed as an automobile and is exempt from the provisions of the state law regarding license and speed. Consequently, as motorcycles or motor bicycles are not governed by the motor vehicle law, they must observe the speed regulations fixed by the ordinance for bicycles. This is eight miles an hour anywhere in Buffalo, except on Main street, south of Chippewa street, where the speed is restricted to five miles, and on the bicycle paths, where it is ten miles an hour.

William S. Bull, superintendent of police, has sent out notices embracing the corporation counsel's decision to all police captains with instructions to pass the order among the policemen. The police are instructed to govern themselves according to the decision and arrest operators of motorcycles violating the ordinance in reference to speed on the city streets.

DEMONSTRATION FOR CITY FATHERS.

Special Correspondence.

KANSAS CITY, Mo., July 25.—Henry Merrill, Hugh C. Thompson and E. E. Richter took four of the city aldermen out for a ride last Saturday, just to show them that the proposed ordinance to limit speed to 8 and 10 miles an hour in the city was restricting motorists too much.

All the cars were equipped with speedometers, so that the aldermen could observe the speed at every moment. The motorists gradually hit up the speed to a 15-mile rate and the aldermen thought this very moderate. When an electric car went by an alderman expressed the desire to ride at the same speed as the car was going. The driver speeded up and when he kept even with the car the speedometer registered 30 miles.

The committee of aldermen then decided that if a street car could run at 30 miles an hour through the streets an automobile could run at 8, 10 and 15 miles, and they agreed to recommend this speed to the city council.

LONG COMMERCIAL AUTO TRIP ENDS.

F. E. Muscovics Arrives in St. Louis from New York in Seventy-five Days and Commends Motor Car for Commercial Traveling.

Special Correspondence.

ST LOUIS, July 23.—F. E. Muscovics, who reached St. Louis this week from New York, holds the record for making the longest automobile commercial trip in this country. He started from New York May 3 in the interests of the Continental Caoutchouc Company, and has made stops at all the important cities along the route. In an interview, Mr. Muscovics said that as compared with results, the trip had been the cheapest one he had ever taken. "I met people that I could not have met otherwise; interested people that I could not have interested otherwise, and people were interested in me who would not have been interested without the car."

The trip was the outcome of a discussion at the Chicago automobile show last February. It was argued that agents should travel by motor car in selling their machines. One manufacturer said: "Well, you sell tires, why don't you demonstrate to us that it is profitable by making your trips by automobile fitted with your tires?" "I'll do it," said the tire man, and this trip of 6,100 miles was the result. The car used was a four-cylinder 15-horsepower Clement, and the operator says that during the journey not a screw, valve, spring, or anything else was replaced. The agent reached Buffalo May 11, and on May 13 the chauffeur had an accident in that city, running the car into a tree. The frame was bent, the radiator smashed and the lugs on the engine and gearcase torn up. The car was sent back to the factory, its parts were straightened out and the machine returned to Buffalo where the journey was continued. The same set of tires that were on the car when it left New York last May are still in use on the car.

Going into Cleveland at a high rate of speed the chauffeur had his second accident. A deep rut lifted the car off the ground, and the machine went over an embankment, throwing the occupants out. One wheel hit a railroad tie and its tire was knocked off the rim. These, with two punctures, constituted the tire mishaps of the entire trip.

From Cleveland to Chicago the roads were found good without exception. From Chicago to St. Louis Mr. Muscovics encountered the same trials and vicissitudes that every motorist meets. Entering Springfield, Ill., there is a dangerous hill with no warning whatever. The motorist who starts down unprepared will have trouble, as the hill is of solid rock and the road leads down like winding stairs. At the foot of the hill is a dangerous turn at a bridge. No motor car has ever gone up this hill, it is said, the local motorists making a detour of three miles in order to avoid it.

Between Springfield and East St. Louis the chauffeur had to stop his car 182 times while horses passed. Two runaways were caused in Missouri by this auto. However, the farmers appreciated every act of courtesy shown them, and the westerners were greatly interested in the car. Inhabitants of the western states have large anticipations regarding the endurance run, and if it doesn't come up to what its promoters have claimed, the natives are going to be immensely disappointed.

Coming into St. Louis motorists should

turn at Edwardsville, twenty-five miles east, and go to Collinsville through Peters Station, thus avoiding many of the troubles of the Missouri bottom roads.

Mr. Muscovics's trip was in every way a success, he claims, and demonstrated the theory that commercially the automobile fills a much needed want, and people will believe when they see for themselves what the car and tires actually accomplish.

CHICAGO-NEW YORK RECORD TRIAL.

Special Telegram.

CHICAGO, July 27.—Jerome A. Ellis, a director of the Chicago Automobile Club, started promptly at 3 a. m. this morning in an attempt to break the Chicago-New York record, which now stands at 76 hours. He hopes to reduce the record to 55 hours, arriving in New York in his 40-horsepower Apperson car at 10 a. m. Friday. Arthur C. Schmitt left by train at the same hour for Toledo, where he will take Ellis's place at the wheel and drive to the next control, Ellis taking the train and getting what sleep he can.

MINNEAPOLIS-ROCHESTER TOUR.

Special Correspondence.

MINNEAPOLIS, July 23.—A. M. Lindsay, Jr., accompanied by W. S. McGregor, left this city yesterday for an automobile trip to Rochester, a distance of about 1,200 miles. They go to Chicago and thence by way of Cleveland and Buffalo, and expect to arrive at their destination about August 1. This is one of the longest tours yet attempted by northwestern motorists.

The present condition of the western roads will undoubtedly subject the machine to a severe test of endurance, as there have been frequent rains and the roads through southern Wisconsin are in bad condition. The car that is being used is a 16-horsepower air-cooled Marion, made in Indianapolis, and weighing 1,400 pounds.

STRAIGHTAWAY RACES AT PITTSBURG

Special Correspondence.

PITTSBURG, July 25.—One of the most successful events ever held by the Automobile Club of Pittsburg was the race meet Saturday afternoon on the Beechwood Boulevard speedway. The machines contesting ranged from 5 to 60-horsepower, and, while no records were "smashed," the sport was above the average and the attendance larger than at previous events here. All of the events were for the mile, with results as follows:

First event—For steam cars not exceeding 7 horsepower. Won by J. A. Pietsch in 1.48 2-5; W. H. Artzberger, second, 2.06.

Second event—For gasoline machines from 8 to 13-horsepower. Won by C. Heinze in 1.32; C. Fleming second in 1.49.

Third event—For machines of 14 to 20-horsepower, run in heats. Final won by W. L. Mellon in 1.35 1-2.

Fourth event—For machines of 20-horsepower and over; run in heats. Final won by G. E. Turner in 1.11 2-5.

Fifth event—Free for all; run in heats. Final won by R. E. Clemson, in 1.08.

The next races to be held under the auspices of the club will be given at Brunot's Island, September 20.

On Saturday, August 30, a club run will be held to Greensburg, where luncheon will be served, and the run continued to Saltsburg and return.

AN ORDINANCE limiting the speed of automobiles to eight miles an hour within the fire limits and fifteen miles in other parts of the city, has been passed by the city council of Atlanta, Ga. It also provides for the registration of all such vehicles with the city clerk, for which a fee of \$1 must be paid.

TO TOUR BY RAILROAD.

Flanged Wheels to Be Used by C. J. Glidden in Far West.

Special Correspondence.

BOSTON, July 25.—Mr. and Mrs. Charles J. Glidden and their chauffeur or "engineer," as Mr. Glidden prefers to call him, who left this morning for St. Louis with other participants in the tour to the exposition city, expect to make a brief stay there, while their car is placed upon exhibition in the Transportation building for about two weeks, at the request of the chief of that section. The car, a Napier, arrived in Boston only last Saturday from England. With it was a set of wheels having steel rims with flanges to fit standard railroad track, as it is Mr. Glidden's intention to do several thousands of miles of traveling on the tracks in his tour around the world.

From St. Louis he will tour through Missouri, Kansas and other southwestern states into Texas, whence he will make a short trip into old Mexico, returning to St. Louis before starting westward on his trip to the Pacific Coast.

The start for the Pacific will be made from Minneapolis and the trip will be made over the lines of the transcontinental railroads. Extensive preparations have been completed for this trip, among these being agreements with the several railroad companies whose tracks will be used to send the Glidden motor car along under the direction of the regular train despatchers. The car is to be run in all respects like a private railroad train. A railroad engineer will be carried and the car will be run on schedule, starting behind regular trains and following these, sidetracking when they do and making the regular stops. Mr. Glidden anticipates no trouble in keeping up with the trains.

Upon arriving at Vancouver in the fall the automobile will be stored for a few months, as the weather in the late fall and early winter in Hawaii, the next place to be visited, is not suitable for touring. Mr. and Mrs. Glidden will return to Boston for the winter holidays and expect to resume their tour in January, shipping their car to the Hawaiian Islands, touring these, and then, about February 1, shipping to Australia. The route laid out in Australia includes a drive of about 5,000 miles across the island continent. The start will be made from Brisbane in Queensland, and the finish will be in Adelaide, South Australia, New South Wales being crossed on the way. In Australia Mr. Glidden expects to find excellent roads and a fine country for touring. After covering Australia, the next place on the list is Tasmania, then New Zealand, which is to be completed the last of April, 1905.

The summer and fall of 1905 will be spent in Japan and China. In China the roads are so narrow that a vehicle of the gauge of Mr. Glidden's automobile could make no progress. The car will therefore again be fitted out with its railroad wheels, and the Chinese trip will be made over the railroad. From China the route is through Sumatra, Java and Borneo into Ceylon.

In April, 1906, the tour is to be continued in India, Egypt, the Holyland, Greece and Europe, ending in London about October 1.

STREET SUPERINTENDENT WERDIN, of San Francisco, owing to a recent action of the city council, has been provided with an automobile, which he uses in looking after the condition of the streets. And 'tis said, while the Superintendent does not work on Sundays, the automobile makes no such discrimination.

A RECORD- OF MISHAPS.

Grade Crossing and Other Accidents Mark the Touring Season.

A grade crossing on Long Island was the scene of another automobile accident on Thursday, July 21, when Martin J. Rauscher, proprietor of the Albemarle Hotel at Coney Island, accompanied by Menton Merritt, his chauffeur and Albert Buckhart and Horatio Abbott, employees of Mr. Rauscher, were run down in an automobile on King's Highway, where it is crossed by the tracks of the Prospect Park and Coney Island Railroad on Gravesend avenue. The automobile was completely wrecked and the four men injured, one of them, Abbott, probably fatally. There was no bell, flagman, gate or any sort of signal or warning, except the usual railroad crossing sign.

The automobile was a 35-horsepower Panhard, recently purchased by Mr. Rauscher. The party was on the way to Bath Beach, and on approaching the crossing speed was reduced to a low rate, as a high board fence along the road obscured the view of the tracks on Gravesend avenue. These tracks are used by trolley cars, elevated trains and freight trains of the Long Island Railroad. The trolley cars and elevated trains are obliged by rule to stop before crossing, but the freight trains, of which there are two daily, do not stop. It was a freight train that struck the automobile. When almost on the track Mr. Rauscher saw the engine approaching, tender first, and instantly applied his emergency brake, stopping the machine on the track directly in front of the train. It seemed probable to those who saw the accident that had the automobile been sent ahead at full speed the accident would have been avoided. As it was, however, the back of the tender caught the automobile almost in the middle. All but Abbott were thrown out, clear of the tracks. Abbott was pinned in the wreck of the tonneau and dragged along until the engine stopped, when he was extricated in a semi-conscious condition with a fractured skull. The others managed to pick themselves up, their injuries being comparatively slight.

It is said that the engineer of the freight train was not aware of the collision until a boy shouted to him that he had run down an automobile, when he applied the brakes and brought the train to a stand-still. Some persons who witnessed the accident said that the locomotive bell was ringing, while Mr. Rauscher states that this was not the case.

Mayor McClellan's automobile figured in a less serious accident on the Staten Island Ferry on the same date. The chauffeur had just driven the car into a position on the boat when a large truck, endeavoring to pass, smashed into it and ripped off a rear wheel from the automobile. Lewis Nixon's machine, which was immediately behind that of the Mayor, had a narrow escape from sharing the damage.

The recent grade crossing accidents have served to stir up a vast amount of comment and activity among the city officials. Mayor McClellan has sent a special message to the board of aldermen, urging it to take up the grade crossing question vigorously, and suggesting that a systematic crusade be inaugurated with the object of abolishing all grade crossings of a dangerous character within the limits of Greater New York. Immediately upon receipt of this it was decided by the Board to send a petition to the State Railroad Commission without delay, asking for the necessary improvements at crossings.

An automobile, in which David C. Whitney, Mrs. Whitney and child and Charles Stinchfield, all of Detroit were driving, suddenly swerved from its course while on the

road between Detroit and Alma and went over an embankment, injuring Mr. Whitney's legs and badly damaging the car. The other members of the party were unhurt. The car was in charge of a professional chauffeur. The canopy top with which the vehicle was fitted saved the occupants from more serious injuries, as it prevented the car from entirely turning over by catching in the trees by the roadside. The power plant of the automobile was uninjured.

William Smith, of Newmarket, N. J., brother of Mrs. Charles L. Fair, who, with her husband, was killed in an automobile accident in France, had a very narrow escape from a fatal accident July 25. While running his automobile through the streets of Newmarket he came so close to colliding with a trolley car that the machine grazed the fender, which caused Mr. Smith to lose his presence of mind and allow the automobile to butt into a tree. Miss Emma Mehr, of New York, and Miss Anna Marsh, of Jersey City, who were passengers, were thrown out and badly injured. Mr. Smith got off without a scratch. The automobile was badly damaged and the tree lost a large portion of its trunk where the heavy machine crashed into it.

Charles Hurst and his wife, of 771 Putnam avenue, Brooklyn, N. Y., were badly injured by being run into by a Wabash express train on Saturday, July 23, while touring in their automobile near Altamont, Ill. It is reported that Mrs. Hurst was so badly hurt that she could not recover, but Mr. Hurst is improving. The machine was completely wrecked. Charles Hurst is engaged in the electrotyping business in Fulton street, New York. Both he and Mrs. Hurst had a strong liking for automobile touring. Mr. Hurst is slightly deaf, and it is thought that this might have caused him to run into danger through not hearing the approaching train.

GETS ROAD FOR A RIDE.

Special Correspondence.

KANSAS CITY, Mo., July 25.—W. B. Clarke, who owns considerable land south of this city through which he wants the county to build a macadam road, took the county judges on a 40-mile ride Saturday. Incidentally, of course, he went over the proposed route of the road he asks for.

The county judges liked the view from the tonneau of Mr. Clarke's Peerless so well that they told him they thought favorably of his project. Mr. Clarke took the time to show the officials some stretches which needed repairing and received assurances that betterments would be made.

NOVEL AUTO-BOAT-IN BUFFALO.

Special Correspondence.

BUFFALO, July 25.—A novel auto-boat has been built and demonstrated successfully here by Capt. Samuel Golden, a veteran mariner of this city, who now contemplates building a larger and faster launch on the same plan.

The Captain's little craft is named *Vinco*, and it is conceded to be the fastest in this harbor. It is 35 feet long and 7 feet beam. The hull proper is very flat and draws only three inches of water, the object being to have it glide over the surface of the water when going at high speed. Below this hangs a narrow cockpit in which is located a 20-horsepower gasoline engine, the top of which is just on a level with the bottom of the hull proper. This pit, with the engine, serves the purpose of a fin keel, giving the craft such stability that with six men standing on one gunwale the combined weight of about 900 pounds hardly caused the boat to list perceptibly. The peculiar construction also causes the boat

to answer the helm very quickly. Her owner darted in and around the big freighters in the river with remarkable accuracy and claims that he can turn a complete circle in a fifty foot channel with *Vinco* while going at full speed.

AUTOCAR EXTENSION IN ARDMORE.

Special Correspondence.

PHILADELPHIA, July 25.—The site having been graded and otherwise prepared, the Autocar Company, of Ardmore, will next week break ground for the new machine shop addition adjoining its present plant. The new building is to be of brick, 204 by 44 feet. There will be three stories and basement, the latter, which is to be used as a stock room, to be the full length and width of the building. The third floor is to be used for storage purposes, while the first and second floors will be devoted exclusively to machinery, of which no less than eighty new pieces will be installed. The additional space thus available for machinery will be upwards of 17,000 square feet, or three times the area of the present machine shop.

With this increase in facilities the company will next year have little difficulty in at least doubling its 1904 output. The new shop, it is expected, will be finished and in running order by mid-October.

RECENT INCORPORATIONS.

Curado Willowware Co., Philadelphia, Pa., capital, \$10,000; to manufacture automobile baskets. Officers, Gottlob Hammer, president; A. L. Curado, vice-president; George Hammer, secretary, and Charles Walters, treasurer.

Cook Kerosene Carbureter Co., capital, \$200,000; to manufacture carbureters and vaporizers for use in automobile and marine motors. Incorporators, James J. Cook, Mungo J. Currie, John Alexander Currie, Albert J. Cook and Henry M. Traphagen, of Jersey City, and Samuel G. Currie and Eugene L. Flandreau, of New York.

Morgan & Harding Automobile Co., St. Louis, Mo., capital \$10,000. Incorporators, E. L. Morgan, W. R. Morgan and A. G. Harding.

Maxwell-Briscoe Motor Company, North Tarrytown, N. Y.; capital, \$750,000; to conduct a general freight and passenger transfer business in cities and villages, using motor vehicles and boats. Directors: Richard Irvin and Nicholas Betjeman, of New York City; Walter B. Horn, of Hollis; Henry E. Tobey, of Brooklyn, and Isaac C. Kirkham, of New Brighton.

GARAGES AND IMPROVEMENTS.

SOUTH BEND, Ind.—A. M. Jennings, agent for the Winton, has established a large garage at 131 Vistula avenue, in this city. The garage is directly on the route from west to east on the only street that can be used by automobilists making the trip from New York to St. Louis.

ASBURY PARK, N. J.—J. E. Crater, of the Central Automobile Company of Newark, has opened an automobile livery establishment at 1038 Bangs avenue, Asbury Park, N. J., and in connection with this business will conduct a general repair and storage station.

COLUMBUS, O.—F. E. Avery has a handsome and roomy garage on Franklin avenue, in the heart of one of the best residence portions of Columbus, and is securing an excellent business from the best citizens. His building is equipped with all the latest appliances for taking care of machines. He handles the Pope-Toledo, Franklin and several other machines.



CANADIAN AFFILIATION.

Reply of President Potter, of the A. M. L., to Winnipeg Proposal.

Special Correspondence.

WINNIPEG, Can., July 21.—Members of the Winnipeg Automobile Club discussed at a recent meeting the following reply from President Potter, of the American Motor League, to a proposal of the affiliation of the American and Canadian automobile clubs, with a view to obtaining reciprocal customs, privileges and touring advantages:

"Your letter of last month came at a time when our attention was given to the proposed merging of the American Motor League and the American Automobile Association. The other organization is much smaller than ours, but it was thought best that there should be but one body, and we have labored patiently to that end, but the merger scheme hangs fire, and we shall now go on with the regular work of our league until the conditions for amalgamation are more propitious.

"Your suggestion that a joint union between the two countries should be formed, to facilitate automobile touring and to insure uniformity in our signs, reciprocal customs privileges, etc., be brought about, is a most timely and admirable one, and you may rely upon our cordial co-operation to give it effect. We have members in over 600 cities and towns, and in forty-four states, and a very fair number in the Canadian provinces, and we are in a position to wield a strong influence toward the end you propose. There should really be but one organization on the American continent, and if this organization can be made to include both the automobilists of Canada and the United States much good will result.

"Would it not be best for the Winnipeg club to become affiliated to the A. M. L. and send a delegate to our next national assembly, which will probably be held in Chicago next January?"

(Signed) "I. B. POTTER,
"Pres. American Motor League."

MOTOR POWER ASSOCIATION ACTS.

Special Correspondence.

PHILADELPHIA, July 25.—The second meeting of the Motor Power Association of Philadelphia, which was organized ten days ago, was held last Wednesday evening, nearly every member being in attendance. President George Banker occupied the chair. After the admission of a number of new members the following board of directors was elected: James Gibney, A. G. Powell, H. Walter Schlichter, Joseph Stettler and Lewis Hawkins. Alexander Allen, of Germantown, was elected vice-president.

It was decided to seek permanent quarters on North Broad street, in the "automobile zone," and Secretary Le Cato is now looking over the ground for a suitable location. These headquarters will be open day and night, and it is proposed to run a café in connection with them, where members and their friends may secure a bite of lunch after a trip.

The initial move in the preparations for next September's race meet under the auspices of the association was made last week when an agent of the association visited the Empire City track, New York, and secured the entries of a majority of

the contestants there. It is probable that the races will be run off at Point Breeze track, as there is no other suitable course within easy distance of the city's center.

NEWS NOTES OF THE CLUBS.

TRENTON.—The Trenton A. C. adopted a constitution and by-laws last week and decided to hold its annual meetings hereafter on the first Monday in March.

ROCKFORD, Ill.—The Automobile Club of Rockford is negotiating for the purchase of the old Presbyterian Church building. If secured, a second story will be added, in which will be located the club rooms, while the first floor will be used as a garage and repair shop.

JACKSON, Mich.—The recently organized Automobile Club of Jackson made its first run to Van Schoick's landing, Round Lake, recently, eight machines, carrying nineteen members participating. Dinner was served at the Lake, and the return trip made without mishap. Another run will be held early in August.

KANSAS CITY, Mo.—At the annual meeting of the Automobile Club of Kansas City, held July 21, the following officers were elected for the ensuing year: William Huttig, president; G. L. Henderson, first vice-president; H. N. Strait, second vice-president; H. G. Blakely, treasurer, and F. R. Sanborn, secretary.

JOILET, Ill.—An automobile club has been organized here with twenty charter members. A recent run was made to Electric Park, Plainfield, where a complimentary luncheon was served by the Joilet Automobile and Garage Co. The twenty members, accompanied by their wives or sweethearts, took part in the run.

COLUMBUS, O.—The Columbus Automobile Club is now in a flourishing state, and has an active membership of 125. Governor Myron T. Herrick is an honorary member. The present officers are, C. M. Taylor, president; William Neil, vice-president; E. W. Seeds, treasurer, and Dr. C. A. Howell, secretary.

HAVANA, Cuba.—A committee of the Automobile Club of Havana, Cuba, recently waited upon President Palma, requesting his support of a movement to hold automobile races in the Cuban capital during the early fall. The President expressed his approval of the project, and promised to discuss the matter in the council of the secretaries.

CHICAGO.—A second theater party has been arranged for the members of the Chicago Club to be given at the Illinois Theater, Saturday evening, July 30. The play will be the comic opera, "The Forbidden Land," which has proved one of the successes of the season at this house. The entertainment committee has reserved 250 seats and four of the boxes for club members.

PHILADELPHIA, July 11.—Members of the Tours and Runs Committee of the Automobile Club of Philadelphia are considering the advisability of promoting another race meet to be held early next fall. The Point Breeze meet last spring was held under the joint auspices of the club and the local trade, and was followed by a boom which some of the moving spirits in the latter attribute in large measure to the race. Apart from their shortcomings as speed

contests, the races proved a good advertisement, and it is believed that with good attractions and fair weather a meet next fall would establish automobile racing here on a successful basis.

LOS ANGELES.—The annual election of the Automobile Club of Southern California resulted as follows: Dr. Milbank Johnson, president; Frank A. Garbutt, first vice-president; Herbert Cutler Brown, second vice-president; A. P. Fleming, secretary; F. W. Flint, Jr., treasurer.

CHICAGO.—An immense album containing the pictures of all the members of the Chicago Automobile Club in their cars, with their families or friends, is being made by the official photographer of the club for the reading room of the club house. In addition to the names of the persons, the make and horsepower of the car will be given, together with other data of interest.

FORT WAYNE, Ind.—Arrangements have been completed for an automobile race meet to be held at the Driving Park, on July 29th and 30th, under the auspices of the Fort Wayne Automobile Club. There will be four events each day for local and northern Indiana drivers, and in addition match races and exhibition runs by LaVin, the French driver, and Austin Crooks, of New York.

NEW YORK.—The New York Motorcycle Club will hold an open run from New York City to Philadelphia and return early in August, the exact date to be named later. A time limit of fourteen hours will be fixed, and medals will be awarded to all who complete the trip within that time. The club is also considering the matter of holding a race meet on Labor Day.

TOLEDO.—Last week the annual convention of Press Clubs from all over the United States was held at Put-in-Bay, and after the meeting the members went to Toledo, where they were given a ride around the city, through the parks, to the wine cellars of the Lenk Wine Company, and the Country Club, in automobiles by the members of the Toledo A. C. Dinners were served at the wine cellars and Country Club.

SAN FRANCISCO.—The arrival of Mr. and Mrs. Charles J. Glidden on their tour of the world will be appropriately observed by the Automobile Club of California. It is probable that Mr. Glidden will be tendered a reception and his stay made as pleasant as possible. The approximate date of his arrival on the Coast has not yet been announced. This will be the first trans-continental trip to be made in an automobile starting from the East.

LANCASTER, Pa.—The Lancaster Automobile Club has been organized, with the following officers: Jacob D. Rider, president; Dr. S. T. Davis, vice-president; Dr. E. B. Ilyus, secretary, and Dr. P. P. Brenehan, treasurer. Local owners of machines are incensed at the excessive tolls charged by some of the turnpike companies, and the object of the club is to secure legislation that will give automobilists the same privileges enjoyed by other users of the public roads.

ALBANY, N. Y.—At a recent meeting of the Automobile Club of Albany, resolutions were adopted protesting against the excessive speeding of cars within the city limits. A committee was appointed to render to the authorities such assistance as is possible toward the apprehension and prosecution of violators of the law. The question of a race meet was discussed and a committee appointed to make the neces-

Directory of Automobile Clubs and Trade Associations

WITH SECRETARIES' NAMES AND ADDRESSES.

REVISED TO DATE.

In the interest of completeness and accuracy, officers of new clubs not included in this Directory, but which have a formal organization, are invited to send club name, list of officers, and address of secretary. Reports of club elections, club news of general interest, and corrections are especially requested.

- AMERICAN AUTOMOBILE ASSOCIATION—C. H. Gillette, 31 W. 42d St., New York City.
- AMERICAN MOTOR LEAGUE—Robt. L. Stillson, 150 Nassau Street, New York City.
- AMERICAN POWER-BOAT ASSOCIATION—J. H. McIntosh, 32 Broadway, New York City.
- A. C. OF AMERICA—S. M. Butler, 753 Fifth Avenue, New York City.
- ASSOCIATION OF LICENSED AUTOMOBILE MANUFACTURERS—Geo. H. Day, Manager, 7 E. 42d Street, New York City.
- NATIONAL ASSOCIATION OF AUTOMOBILE MANUFACTURERS—A. B. Tucker, 7 E. 42d Street, New York City.
- NAT'L ASSN. RETAIL AUTO. DEALERS—Sidney Ellston, Indianapolis.
- SOCIETY OF AUTO. ENGINEERS—E. T. Birdsall, 138 W. 38th St., New York City.
- ALAMEDA COUNTY A. C.—F. F. Weston, 1302 Webster Street, Oakland, Cal.
- ALBANY A. C.—Chas. M. Page, 60 Liberty Street, Albany, N. Y.
- A. C. OF ALLENTOWN—A. S. Weishampel, 623 Commonwealth Bldg., Allentown, Pa.
- A. C. OF ARIZONA—K. L. Hart, Tucson, Arizona.
- A. C. OF AUBURN—Dr. G. W. Whitney, 148 Genesee Street, Auburn, N. Y.
- A. C. OF AUGUSTA—Wm. Martin, Augusta, Ga.
- A. C. OF AURORA—S. W. Thorne, Aurora, Ill.
- BERKSHIRE A. C.—L. A. Merchant, 86 North Street, Pittsfield, Mass.
- BETHLEHEM A. C.—William E. Martin, Bethlehem, Pa.
- A. C. OF BINGHAMTON—Dean Albert Smith, Binghamton, N. Y.
- BLOOMINGTON A. C.—Henry Thobro, Griesheim Bldg., Bloomington, Ill.
- BLOOMSBURG A. C.—C. W. Funston, Bloomsburg, Pa.
- BOSTON AUTO. DEALERS' ASSOCIATION—C. I. Campbell, Boston, Mass.
- A. C. OF BRIDGEPORT—D. R. Beebe, Meigs Bldg., Bridgeport, Conn.
- BROCKTON A. C.—W. H. Marble, 52 High Street, Brockton, Mass.
- BRONX A. C.—J. Stuart Blackton, 310 Mott Avenue, New York City.
- A. C. OF BUFFALO—F. J. Wagner, 774 Ellicott Square, Buffalo, N. Y.
- BUFFALO AUTO. TRADE ASSN.—D. H. Lewis, 70 Woodlawn Avenue, Buffalo, N. Y.
- A. C. OF CALIFORNIA—F. W. McNear, 415 Montgomery St., San Francisco.
- CEDAR RAPIDS A. C.—G. L. Rothrock, Cedar Rapids, Ia.
- CHICAGO A. C.—Sidney S. Gorham, 243 Michigan Ave., Chicago, Ill.
- CHICAGO AUTO. DEALERS' ASSN.—Fred Pardee, Chicago, Ill.
- CHICAGO MOTOR CLUB—W. D. Foreman, 478 Wabash Ave.
- CHICAGO MOTORCYCLE CLUB—Ira H. Whipple, 260 W. Jackson Boul.
- A. C. OF CINCINNATI—Dr. L. S. Colter, St. Clair and Gano Streets, Cincinnati, O.
- CLEVELAND A. C.—Geo. Collier, 317 Superior St., Cleveland, O.
- COLORADO A. C.—Dr. W. H. Bergtold, 624 14th St., Denver, Colo.
- COLORADO SPRINGS A. C.—S. G. Pierce.
- COLUMBIA UNIVERSITY A. C.—R. C. Gaige, Columbia University, New York City.
- COLUMBUS A. C.—C. A. Howell, Columbus, O.
- COUNCIL BLUFFS A. C.—Tom S. Farnsworth, Council Bluffs, Ia.
- CRESCENT A. C.—A. W. Sallander, Fort Madison, Ia.
- CUTLER A. C.—Walter D. Pinks, 20 E. 50th Street, New York City.
- DALLAS A. C.—G. C. Scruggs, Dallas, Texas.
- A. C. OF DAVENPORT—A. B. Reubens, Davenport, Ia.
- A. C. OF DAYTON—C. B. Wolf, Dayton, O.
- A. C. OF DETROIT—DeWitt Loomis, 902 Union Trust Bldg., Detroit, Mich.
- A. C. OF EL RENO—W. D. DeVarney, El Reno, Oklahoma.
- FEDERATION OF AMERICAN MOTORCYCLISTS—E. L. Ferguson, Middletown, Conn.
- FLORIDA AUTO. ASSN.—Dr. F. P. Hoover, Stockton-Budd Bldg., Jacksonville, Fla.
- FLORIDA EAST COAST AUTO ASSN.—John B. Parkinson, Daytona, Fla.
- FT. WAYNE, A. C.—A. L. Randall, Ft. Wayne, Ind.
- GAS BELT A. C.—H. C. R. Wall, Muncie, Ind.
- GENEVA A. C.—Charles Fairfax, Geneva, N. Y.
- GERMANTOWN, A. C.—Robert P. Hooper, 509 Arch St., Philadelphia, Pa.
- GRAND RAPIDS A. C.—L. W. Welch, Grand Rapids, Mich.
- GRANITE STATE A. C.—Albert L. Clough, 1008 Elm St., Manchester, N. H.
- HAMILTON A. C.—James Moodie, Hamilton, Ont.
- HARTFORD A. C.—Wm. T. Plimpton, Hartford, Conn.
- HERKIMER A. C.—W. I. Taber, Herkimer, N. Y.
- HOUSTON A. C.—Mrs. L. M. Adams, Binz Bldg., Houston, Texas.
- A. C. OF HUDSON COUNTY—Frank Eveland, 52 Madison Ave., Jersey City, N. J.
- A. C. OF ILLINOIS—M. Scott, 405 Monadnock Bldg., Chicago, Ill.
- ANDERSON A. C.—W. C. Dunn, Anderson, Ind.
- A. C. OF INDIANA—Gordon E. Varney, Indianapolis, Ind.
- IOWA A. C.—S. B. McNutt, Des Moines, Ia.
- A. C. OF KANSAS CITY—F. R. Sanborn, 316 American Bank Bldg., Kansas City, Mo.
- KANKAKEE A. C.—Chas. H. Cobb, 208 Court St., Kankakee, Ill.
- LONG ISLAND A. C.—H. P. Hanford, 32 Hanson Place, Brooklyn, N. Y.
- LOS ANGELES A. C.—C. F. Gates, 120 N. Main St., Los Angeles, Cal.
- LOUISVILLE A. C.—Dr. Wm. Pfingst, Louisville, Ky.
- LOWELL A. C.—C. S. Mussey, 4 Fletcher St., Lowell, Mass.
- LYNN A. C.—Walter S. Baliburton, Lynn, Mass.
- MACON AUTO. ASSN.—E. W. Burke, Macon, Ga.
- MADISON AUTO. LEAGUE—H. H. Ratcliff, Wisconsin Bldg., Madison, Wis.
- A. C. OF LORAIN—Frank Floding, Lorain, O.
- A. C. OF MAINE—Howard Winslow, 323 Commercial St., Portland, Me.
- A. C. OF MARLBOROUGH—J. F. J. Otterson, Marlborough, Mass.
- A. C. OF MARYLAND—C. Warner Stork, Altamont Hotel, Baltimore, Md.
- MASSACHUSETTS A. C.—Frederic Tudor, Jr., 761 Boylston St., Boston, Mass.
- MASSACHUSETTS STATE AUTO. ASSN.—L. H. Greenwood, Fitchburg, Mass.
- McHENRY CO. A. C.—A. L. Towne, Harvard, Ill.
- A. C. OF MEXICO—Fernando de Teresa, Mexico City.
- MILWAUKEE A. C.—James T. Drought.
- MOTOR AND ACCESSORY MANUFACTURERS ASSN.—D. J. Post, Hartford, Conn.
- MOTOR POWER ASSOCIATION—Harry D. Le Cato, Philadelphia, Pa.
- AUTO DEALERS' ASSN. OF MINNEAPOLIS—W. T. Walker.
- A. C. OF MINNEAPOLIS—Robert A. Hastings, 1031 Guaranty Bldg., Minneapolis, Minn.
- MONMOUTH A. C.—Geo. W. Pittenger, Asbury Park, N. J.
- NATIONAL CAPITAL A. C.—E. M. Sunderland, 819 14th St., N. W., Washington, D. C.
- NEW HAMPSHIRE A. C.—Chas. G. Sheldon, Exeter, N. H.
- A. C. OF NEW HAVEN—F. E. Bowers, New Haven, Conn.
- A. C. OF NEW JERSEY—C. H. Gillette, Newark, N. J.
- NEW JERSEY AUTO AND MOTOR CLUB—Jas. C. Coleman, Newark, N. J.
- PHYSICIANS' A. C. OF NEW JERSEY—Dr. Clement Morris, 75 Washington Ave., Newark.
- A. C. OF NEW ORLEANS—Sam. Stone, Jr., 818 Common St., New Orleans, La.
- NEWTON A. C.—Ralph C. Emery, Newton, Mass.
- NEW YORK AUTO TRADE CLUB (Hotel Navarre, N. Y.)—E. B. Gallaher
- NATIONAL ASSOCIATION OF ENGINE AND BOAT MANUFACTURERS—Hugh S. Gabel, New York City.
- N. Y. AUTO TRADE ASSN.—Wm. P. Kennedy, 7 East 42d St., N. Y.
- N. Y. MOTORCYCLE CLUB—John E. Oest, 1904 Broadway, New York City
- N. Y. STATE AUTO ASSN.—Frederick H. Elliott, Syracuse, N. Y.
- A. C. OF NORFOLK—J. Roy Collins, P. O. Box 116, Norfolk, Va.
- NORTH JERSEY A. C.—Ed. T. Bell, Jr., Paterson, N. J.
- NORTH SHORE A. C.—Quincy A. Shaw, Jr., Prides Crossing, Mass.
- A. C. OF OGDEN—A. V. Withee, Ogden, Utah.
- OHIO VALLEY A. C.—R. H. Mahlke, Wheeling, W. Va.
- OTTUMWA A. C.—Dr. A. C. Lec, Ottumwa, Ia.
- PALM BEACH POWER BOAT ASSN.—H. M. Flagler, Palm Beach, Fla.
- PASADENA A. C.—Robt. H. Gaylord, Pasadena, Cal.
- A. C. OF PHILADELPHIA—Frank C. Lewin, 250 N. Broad St., Philadelphia, Pa.
- PHILADELPHIA MOTORCYCLE CLUB—Charles Krauss, 1406 Oxford St
- PITTSBURG A. C.—W. Linford Smith, 524 Penn Ave., Pittsburg, Pa.
- A. C. OF PRINCETON UNIVERSITY—S. H. Bird, Princeton, N. J.
- A. C. OF RACINE—F. J. MILLER, Racine, Wis.
- RHODE ISLAND A. C.—H. H. Rice, Crown Hotel, Providence, R. I.
- RICHMOND A. C.—A. J. Spekenhner, 220 S. 12th St., Richmond, Ind.
- ROCHESTER A. C.—F. E. Mason, 93 Exchange, Rochester, N. Y.
- ROCKFORD A. C.—H. W. Dickerman, Rockford, Ill.
- A. C. OF SACRAMENTO—T. C. Drake, Sacramento, Cal.
- ST. AUGUSTINE AUTO BOAT ASSN.—W. W. Dewhurst, St. Augustine, Fla.
- A. C. OF ST. LOUIS—E. H. Steedman, St. Louis, Mo.
- ST. LOUIS MOTORCYCLE CLUB—John Hurck, 307 North 14th St.
- A. C. OF ST. PAUL—A. W. Farrar, St. Paul, Minn.
- MOTOR CLUB OF ST. PAUL—J. M. Hammes.
- A. C. OF SAN ANTONIO—Eugene Tips, San Antonio, Texas.
- A. C. OF SAN JOSE—B. D. Merchant, State Security Bank, San Jose, Cal.
- SCRANTON A. C.—A. P. Bedford, Scranton, Pa.
- A. C. OF SHEBOYGAN—A. C. Prescott, Sheboygan, Mich.
- A. C. OF SOUTHERN CALIFORNIA—F. W. Flint, Jr., Los Angeles, Cal.
- SAN DIEGO A. C.—George N. Nolan, Jr., San Diego, Cal.
- SOUTH BEND A. C.—Thos. W. Slick, Oliver Hotel, South Bend, Ind.
- SOUTH SHORE A. C.—Philip F. Hall, Kingman, Mass.
- A. C. OF SPRINGFIELD—B. J. Griffin, 332 Main St., Springfield, Mass.
- A. C. OF SYRACUSE—Frederick H. Elliott, Syracuse, N. Y.
- TERRE HAUTE A. C.—John Cox, Terre Haute, Ind.
- TOLEDO A. C.—Dr. Chas. P. Wagar, 450 Spitzer Bldg., Toledo, Ohio.
- TORONTO A. C.—T. A. Russell, Toronto, Can.
- TOPEKA A. C.—R. D. Montgomery, Topeka, Kan.
- A. C. OF TRENTON—Edw. S. Wood, 138 E. State St., Trenton, N. J.
- TRENTON MOTOR TOURING AND RACING CLUB—Warren C. Eccles, 144 Jackson St., Trenton, N. J.
- TROY A. C.—Dr. Archibald Buchanan, Troy, N. Y.
- A. C. OF UNIVERSITY OF PENNA.—G. B. Fletcher, 216 N. 34th St., Philadelphia, Pa.
- A. C. OF UTICA—Harry H. Mundy, Utica, N. Y.
- A. C. OF VERMONT—W. D. Woolston, Springfield, Vt.
- VIRGINIA BEACH A. C.—Lee Straus, New York City.
- VIRGINIA EAST COAST AUTO. ASSN.—J. Roy Collins, P. O. Box 116 Norfolk, Va.
- WACHUSETT A. C.—L. H. Greenwood, Fitchburg, Mass.
- A. C. OF WARREN—Edw. M. Moran, Warren, Mass.
- WASHINGTON AUTO. DEALERS' ASSN.—B. C. Washington, Jr., 817 14th St., N. W. Washington, D. C.
- WICHITA A. C.—Scott E. Winne, Wichita, Kan.
- WORCESTER A. C.—F. E. Frost, Worcester, Mass.
- YONKERS A. C.—F. P. Fuller, 26 S. Broadway, Yonkers, N. Y.

sary arrangements. Island Park track has been secured, and it is proposed to hold the meet early in September.

SPRINGFIELD, Ill.—Automobile owners of Springfield met recently and formed a club, with Col. R. D. Loose, temporary chairman and Ralph Baker, temporary secretary. A committee was appointed to draft by-laws, which will be submitted at another

meeting to be held at an early date, when a club name and officers will be selected. One of the matters to be first taken up by the club will be the new regulations which exclude automobiles from the park driveways after 6 p. m.

INDIANAPOLIS.—The following are recent additions to the membership roll of the Automobile Club of Indiana: Robert H.

Hassler, Robert S. Givens, Dr. George Hunt, H. L. Beveridge, J. K. Lilly, J. B. Wimmer, H. N. Hempstead, George V. Camp, H. C. Vajen, H. W. Buttolph, Dr. B. Pettijohn, D. L. F. Page, Dr. A. M. Col George A. McClelland, Gustave Kever Herbert H. Rice, Louis Levey, J. S. Holiday, James A. Allison, Howard Marmore Russell Fortune and Romeo Johnson.



The Caille Bros. Company, Detroit, Mich., by whom the familiar slot machine was originated, is experimenting with a four-cylinder touring car for next season.

New Jersey license No. 6,505 was issued last week in Trenton by Automobile Clerk Walter Pycroft, of the Secretary of State's office. The total number of licenses issued for the week was 150.

Articles of incorporation are being prepared for the Ford Motor Co., of Walkerville, Mich., with a capital of \$125,000, the principal stockholder being the Ford Motor Co., of Detroit.

We are informed by the Briscoe Manufacturing Company, Detroit, Mich., that the report to the effect that this concern, or some of its members, are about to engage in the manufacture of automobiles, is incorrect.

The Salt Lake Automobile Co., Salt Lake City, Utah, has removed to its new sales-rooms in the Clayton Building, on South State street, where it has larger quarters and better facilities for the handling of its constantly increasing business.

A hand-book compiled by the G. & J. Tire Company, Indianapolis, Ind., for the benefit of the St. Louis tourists, contains a complete list of all the night and noon stops together with a directory of garages, repair stations and machine shops at each place.

The proprietor of the Hilltop House, on the crest of Pompey Hill, twelve miles from Syracuse, has offered two silver cups to be competed for during the season by members of the Syracuse club. The cars which climb the hill in the quickest time will be awarded the cups.

The long journey to the World's Fair may be pleasantly varied and its monotony broken by those whose route will permit, by taking the Detroit & Buffalo Line steamers across Lake Erie. The vessels are models of comfort and equipped with every requirement of the traveling public.

The 20-horsepower car ordered from the Clement-Bayard factory for Mrs. Mary Dickerson, of Kansas City, arrived there and is being tested. The car cost \$7,000 and is by far the most elegant in that section of the country. The body is of the removable limousine type, finely appointed.

J. P. Toman, of Trenton, has issued a challenge offering to match his Rambler car against any car in Trenton in a run to Newburg, N. Y., on a wager of any amount from \$100 to \$1,000. Mr. Toman joined the legislative committee that Mr. Shattuck conducted on an inspection tour of New Jersey and New York roads this month, accompanying them as far as Newburg.

Several attempts have been made lately to establish a record for the trip between Los Angeles and Santa Barbara, the distance being 117 1-8 miles, as shown by odometer. Norman Church, of Los Angeles, accomplished the distance in 6 hours and 20 minutes, elapsed time. Then John F. McLain, manager of the Pioneer Automobile Company at Los Angeles, and L. T. Shettler, one of the salesmen, made the run in 5 hours 35 minutes. H. T. Lally, of San Francisco, who is touring about southern California in a Winton car, accomplished the trip in 5 hours 21 minutes, carrying four persons.

A fully equipped automobile and general machine shop has been established by the North Jersey Automobile and Engineering Company at Hackensack, N. J., with ample facilities not only for handling repairs and supplies, but also for storage and garage service. The establishment is in charge of A. Ross Jarman.

Frank E. Hartigan, manager of the Mobile Carriage Company of San Francisco, is in the East where he will place a \$150,000 order for Pierce-Arrows. The cars will be for the California trade. The Mobile Carriage Company's shop is now building a fourteen-passenger bus for the St. Francis Hotel, which is the third built by this company for the new hostelry.

Percy F. Megargle and William S. Harrison, the "crew" of the Elmore *Pathfinder* which went over the route of the St. Louis Tour previous to the start of the big excursion, have gotten up a complete guide-book of the road, giving maps, road directions in detail, lists of hotels and garages, hotel charges and information valuable to those taking part in the tour or touring over any part of the route at any time.

At a recent meeting of the trustees of the International Motor and Power Company, at the offices of the company, 618 F street, N. W., Washington, D. C., the following officers were elected: President, H. H. Darnielle; first vice-president, Hon. S. W. Smith, M. C.; second vice-president, J. S. Zeigler; treasurer, B. H. Brockway; superintendent, W. L. Walter; counsel, Alexander H. Bell; assistant counsel, Francis Nye; secretary, S. H. Bell; assistant secretary, U. M. Carpenter.

Seven automobiles were destroyed by fire in the automobile sheds connected with Dreamland, Coney Island, on July 21, and the sheds were completely destroyed. The fire is said to have originated in an explosion of gasoline vapor. The rapid spread of the flames made it impossible to rescue the machines, and the Coney Island fire brigade was unable to do anything except prevent the fire from communicating to the adjoining buildings. Almost immediately after the fire an enterprising automobile dealer inserted an advertisement in a daily paper offering to purchase the remains of the machines that were burned.

The recently reorganized New York Automobile Trade Association, with quarters at 7 East 42d street, is planning to establish a bureau for the registration and employment of chauffeurs. Records of the qualifications of drivers will be kept, enabling the association to recommend only competent men. Uniform storage rates are proposed, also the limitation of demonstrations to prospective purchasers to one hour's ride; a charge of \$25 to be made for the second hour, and \$10 for each succeeding hour, a rebate being made where sales are effected. The object of this is to put a stop to the free rides now often obtained by alleged intending purchasers.

Vice-Chancellor James J. Bergen, of Trenton, N. J., has issued an injunction against the Salamandrine Boiler Company, of Newark, restraining the company from testing its boilers with gasoline, or from running automobiles propelled with or by means of gasoline into the building it occupies at 420 and 422 Ogden street. The company is also restrained from storing

automobiles in the building pending settlement of a suit brought by the J. C. Smith & Wallace Co., owners of the building, who allege that several insurance companies advised them that their policies would be cancelled unless the use of gasoline was prohibited at once in the building.

The Lackawanna Motor Company, of Buffalo, has instituted voluntary dissolution proceedings, and William C. Carroll has been appointed temporary receiver, and John T. Ryan referee, before whom creditors and other persons interested in the company are required to show cause why the affairs of the concern should be wound up. Attorney Charles Diebold, Jr., stated that the company has outstanding obligations amounting to upwards of \$10,000, and has nominal assets of about \$15,000. He gave his opinion that the creditors would be paid in full. The Lackawanna Motor Company was organized February 24, 1903, with a capital stock of \$5,000. Last December the capital stock was increased to \$25,000.

The new Dunlop detachable tire is very clearly explained by means of a working model sent out by the Hartford Rubber Works Company, Hartford, Conn. The rim used with this tire is made with a flat surface and a ring at each edge, one ring being detachable. When it is desired to remove the tire the loose ring is removed and the deflated tire slipped off. The tire is replaced by reversing this operation, the outer and inner tube being slipped over the rim together, after which the loose ring is replaced and tightened up by the screw device provided for the purpose. In the model the wheel and tire are made of cardboard and the ring of tin, and the working of the arrangement is shown at a glance.

John U. May, of Cleveland, is working on the plans by which the Citizens' Transit Co. expects to operate motor busses in that city. The authorized capital is \$600,000, and H. H. McKeehan, W. C. Merrick, W. B. Stewart, C. W. Cottrell and J. W. Tyler are the incorporators. Mr. May says that when a sufficient number of cars are received a regular service will be established on Euclid avenue to Lake View. The fare to be charged is five cents. When this line is equipped, Mr. May says the company will take up lines to other important points in the city. Storage battery cars of large capacity will be used. It is understood to be Mr. May's plan to build the vehicles in a factory the company will establish there, and the plan eventually will be extended to other cities.

A speed launch fitted with a four-cylinder horizontal Brennan motor has been turned out by Merritt Batchelder, boat-builder, Jamestown, N. Y., and on her trial trip developed a speed of nearly 17 miles an hour. The contract under which the boat was built called for a speed of 15 miles per hour, the builder to receive \$50 for each quarter of a mile over this speed. On the other hand, the builder was to forfeit \$50 for each quarter of a mile under 14 miles an hour, if the boat failed to come up to expectations. The trials were made on Lake Chautauqua under almost perfect conditions, and as a result the builder pockets a bonus of \$400. The boat, which is 30 feet long and 5 feet beam, and named the *Eunice*, was built for Frank O. Anderson, Jamestown, N. Y.

THE AUTOMOBILE

WEEKLY

NEW YORK—SATURDAY, AUGUST 6, 1904—CHICAGO

10 CENTS

RACING ON THE BEACH AT NEWPORT.

Special Correspondence.

NEWPORT, R. I., July 30.—Taking its cue from the Florida resort the premier summer colony of the Atlantic coast held a race meeting to-day on the sands at Sachuest Beach. At least it attempted to hold a meet, and in so doing displayed a degree of skill and intelligence that possibly might pilot a croquet or ping pong tournament to a successful conclusion. Newport likes to be original where no brain

ideal for fast racing and for this reason, and the poor race management, it was quite an inconsequential affair. The only really spirited event was the race between E. R. Thomas and H. S. Harkness, each driving a 60-horsepower Mercedes. Thomas won, covering the 1 1-8 mile stretch in 1:02 3-4, though at the finish Harkness was going at a better gait.

The race meet was held under the auspices

marked off on Sachuset or "Second" Beach, one of the three beaches of Newport, and which ordinarily is used only to a limited extent by bathers. It is a stretch of about 1 1-2 miles of fairly clean hard sand at low tide and lies outside the boundaries of Newport proper.

Apparently for the sake of being "original" the responsible committee laid off a 1 1-8-mile course so that no ready comparisons

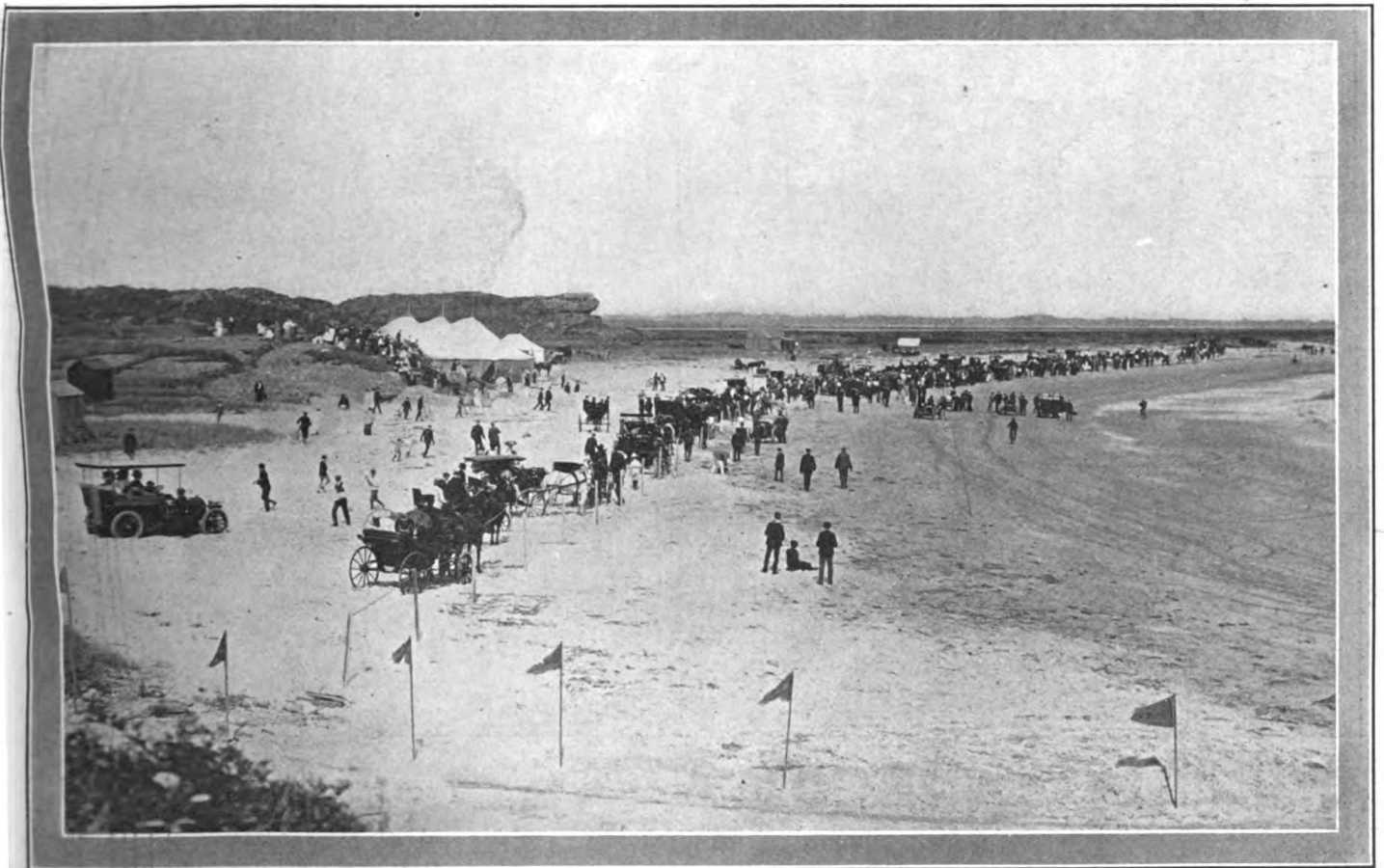

VIEW OF THE COURSE ON SACHUEST BEACH NEWPORT, RHODE ISLAND, WHERE AUTOMOBILE RACES WERE HELD JULY 30.

fag is involved and the splendid stupidity of to-day's performance was not marred by a single intrusion of any ordinary common sense idea, except that of the race itself, and that was borrowed from Ormond.

This seaside course is not by any means

of the Newport Amusement Association, of which Reginald C. Vanderbilt is first vice-president. He was indeed the moving spirit in the affair, though responsibility for actual mismanagement rested on the officials of whom he was not one. The course was

between the speeds attained here and elsewhere could be made. Although the beach in this particular bay on the shore line is slightly curved, it gives practically a straight-away course. At the end nearest the approach from the road the finish line was

stretched and here the various officials grouped themselves, with the exception of the starter J. K. Sullivan, a local "expert," who was at the further end of the beach. From the road leading along the coast line a rather steep pitch leads down to the sands and along the top of the cliffs a number of spectators in heavy vehicles and afoot looked at the show.

When the first race was called there was a long fringe of vehicles, motor driven and horse drawn, including several smart four-in-hands, extending for about half a mile

The program on its cover stated that the meet was held "under the rules and with the sanction of the A. A. Association." A glance at the inside pages showed that while the "sanction" may have been secured, the classification of entries was far enough "under" the rules, so that it could not be reached with a deep-sea sounding line. According to the card, the classification was by horsepower, with vehicles of 600 and 1,400 pounds in the same event, and some that were slated were above the maximum limit of weight.

when he saw it drop. They then started their watches and later did the best they knew to time the machines at the finish.

Three false starts, including a runaway, were needed to get the second race completed. This had the result, however, of showing the superior speed of Harry Hamlin's 24-horsepower Panhard, which was stripped down in record fashion. Each time he led to the tape, the others also running. In the final attempt Hamlin finished in 1:35 1-4, with John Jacob Astor in a 20-horsepower Mercedes second, M. C. Bishop's 16-

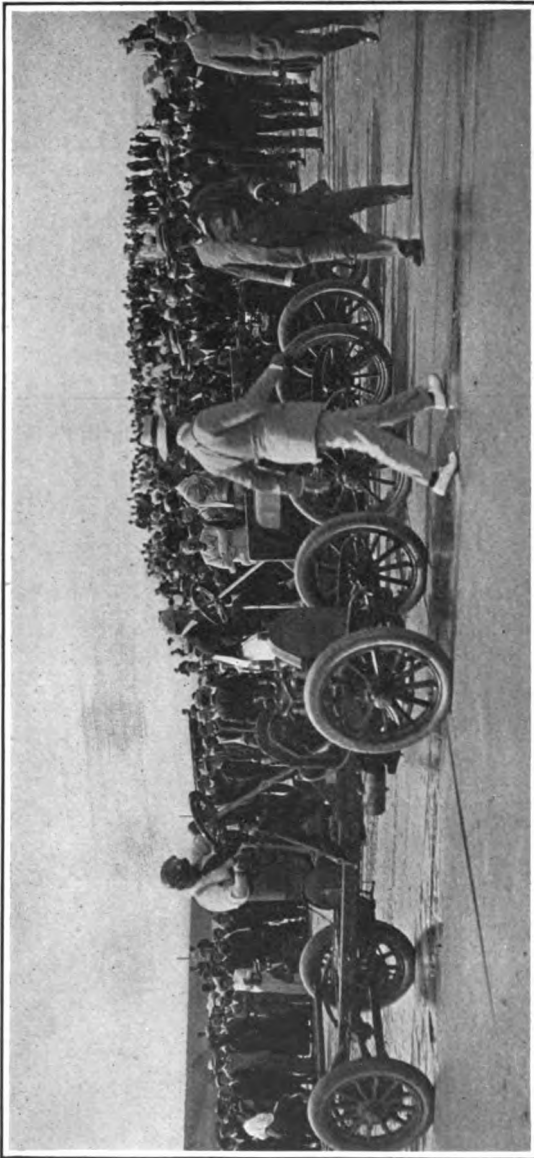

AN UNUSUAL RACE FEATURE — CONTESTANTS AT THE FINISH LINE READY TO RUN BACK TO THE STARTING LINE.
The Second Event at Newport Was Run Off Several Times Before the Judges Declared It a Race.

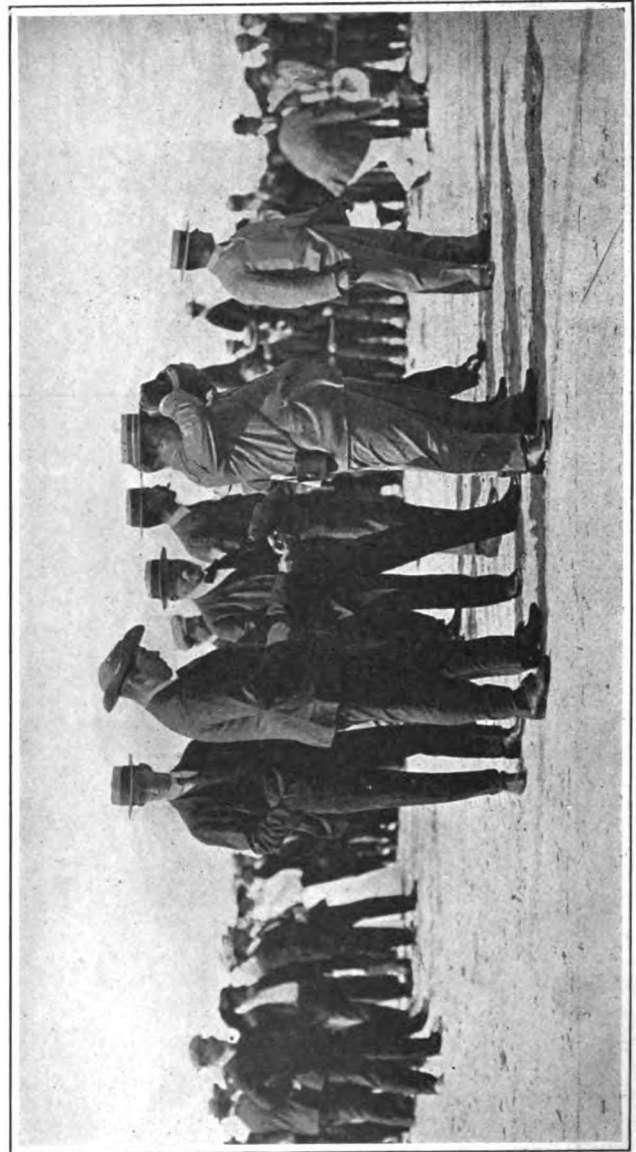

GROUP OF OFFICIALS AT THE FINISH LINE AT THE AUTO RACES ON SACHUEST BEACH, NEWPORT, R. I.
Official with Binoculars Waiting to Notify Timers When the Starter's Flag Has Fallen.

from the finish line. A fine summer sun shone down on the pretty costumes of the women and gave a bright contrast to the gray tweeds that the men of the colony affect. There was enough breeze blowing to carry the sand that the cars stirred up on the dry spots in stinging spindrift into the faces of the drivers.

It was altogether a pleasant scene and as a purely local meet would no doubt have given the pleasure-loving colony good fun for an afternoon with a subject for small talk other than Harry Lehr's Antics.

In the purely "local" events this was not more serious than the purpose of the promoters, but in the "open to all" it was a plain violation of the rules that friendship could not cover.

Motorcycles went to the line soon after 3 o'clock, and the first race ended in a runaway for Oscar Hedstrom on a 1 3-4-horsepower 105 pound Indian in 1:27.

The Newport idea was cleverly displayed in the timing. At the finish line one of the officials with a prism binocular watched the starter's flag and called to the timekeepers

horsepower Fiat third, and Reginald C. Vanderbilt's 22-horsepower Mercedes last. The latter car was driven by a French chauffeur, but did not make a winning in any event.

In the race for electrics the cars driven by the owners gave an amusing exhibition of a sprint at such a speed as the Newport traffic regulations allow.

A. E. Morrison, of Boston, put the Peerless ahead of the foreign machines in the class for gasoline cars not exceeding 24-horsepower. His time in the race with the



SPECTATORS' CARS DRIVING OFF THE BEACH AFTER FINISH OF THE RACES.

ing 10-horsepower, not exceeding 24-horsepower. Prize, Silver Cup, value, \$100. Won by H. Hamlin, Panhard, 24-horsepower; J. J. Astor, Mercedes, 20-horsepower, second; Miss M. C. Bishop, Fiat, 16-horsepower, third; R. C. Vanderbilt, Mercedes, 18-22-horsepower, fourth. Time, 1:35 1-4.

Class 3.—(Local) Gasoline Cars not exceeding 10-horsepower, to be raced in road condition. Prize, Silver Cup, value, \$100. First Heat. Won by P. F. Conroy, Stevens-Duryea, 7-horsepower; J. J. Astor, Cadillac, 8-horsepower, second; T. Shaw Safe, De Dion Bouton, 6-horsepower, third. Time, 1:35 1-2.

Second Heat. Won by P. Jones, Renault, 10-horsepower; W. P. Thompson, Renault,

Astor and Vanderbilt Mercedes cars was 1:29, and in the final he distanced Hamlin's Panhard, finishing in 1:27. Otto Nestman also upheld the domestic product when he won in the gasoline class, under 10 horsepower, in the Stevens-Duryea, in 1:35 1-2.

During the races the officials persisted in standing out on the course away from the rope, and in the path of the finishing cars. The crowd followed their example, and barely gave passage to some of the fast machines as they came across the line. As a consequence the attention of the officials was distracted from their proper duties to futile efforts to clear the course. Newport police had been brought down for appearance sake, but they had no jurisdiction over

the 3,000 persons who witnessed the races on Sachuest Beach.

The following were the officials of the meet: Judges, Daniel B. Fearing, William R. Hunter and William E. Carter; Timers, F. B. Garrettson, Hamilton Fish Webster and Joseph S. Milne; Referee, J. M. Clarke; Umpires, Clarence W. Dolan and E. L. Winthrop, Jr.; Starter, J. K. Sullivan.

Following are the summaries:

Class 1.—(Open) Motorcycles. Prize, Silver Bowl, value, \$75. Won by Oscar Hedstrom, Indian 1 3-4-horsepower; J. McNevin, Rambler, 1 3-4-horsepower, second; B. Thaw, Jr., Indian 1 3-4-horsepower, third. Time, 1:27.

Class 4.—(Local) Gasoline Cars exceed-



AN INTERESTED SPECTATOR.

10-horsepower, second; P. D. Martin, Renault, 10-horsepower, third. Time, 2:00.

Final Heat. Won by Conroy; Jones, second. Time, 1:56 3-5.

Class 2.—(Local) Electric Automobiles. Prize, Silver Cup, value, \$100. Won by H. Bull, Jr., Waverly, 3-horsepower; H. Oelrichs, Jr., Waverly, 3-horsepower, second; E. Dyer, Jr., Waverly, 3-horsepower, third; J. M. Clarke, Pope, 3-horsepower, fourth. Time, 3:32 1-2.

Class 5.—(Open) Gasoline Cars not exceeding 24-horsepower. Prize, Silver Cup, value, \$100.—First heat—Won by A. E. Morrison, Peerless, 24-horsepower; J. J. Astor, Mercedes, 20-horsepower, second; M. C. Bishop, Fiat, 16-horsepower, third. Time, 1:28.



JOHN J. ASTOR AT THE WHEEL OF HIS MERCEDES CAR, STRIPPED FOR RACING.

Second heat—Won by H. Hamlin, Panther, 24-horsepower; A. E. Morrison, Peerless, 24-horsepower, second; M. C. Bishop, Fiat, 16-horsepower, third. Time, 1:37.

Final heat—Won by Morrison; Hamlin, second. Time, 1:27.

Class 5.—(Open) Gasoline Cars exceeding 24-horsepower. Prize, Silver Cup, value, \$150. Won by E. R. Thomas, Mercedes, 60-horsepower; H. S. Harkness, Mercedes, 60-horsepower, second. Time, 1:02 3-4.

Steam Auto Boat.

While steam has been almost entirely ignored of late in the search for extreme speed in light launches, it would seem that at least one expert still considers it a worthy rival of gasoline. N. G. Herreshoff has for some time past been busy with a speed launch intended to compete with the fastest of the gasoline craft, and bearing the suggestive name of *Swift Sure*; indicating the designer's faith in a perfect freedom from the doubts and uncertainties of the explosion motor. The new boat made her debut on Saturday, in a small but very select company, the only other starters being the *Standard* and the *Vingt-et-Un II*.

The occasion was the second launch race of the Atlantic Yacht Club on the Lower Bay in New York Harbor, and good prizes were offered, but they failed to tempt the many fast auto boats now in commission in New York waters.

The *Swift Sure* is a handsome launch of the general type made known through the

Yacht Club station at Sea Gate up the Narrows and around the buoy off Robin's Reef and return, two rounds making twenty nautical miles.

The start was made at 2:30 p. m., with nearly half the ebb tide run out and a moderate southerly breeze up the Narrows against it, making a chop. The *Standard* stated with a lead of 27 seconds over the

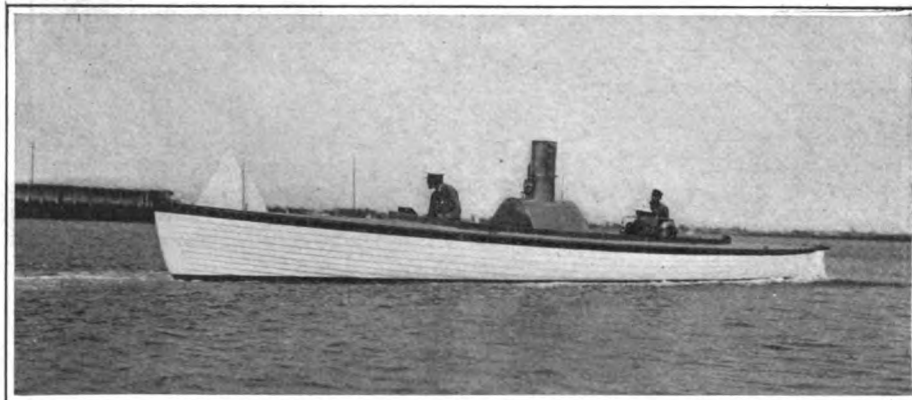

STEAM AUTO BOAT "SWIFT SURE," DESIGNED BY N. G. HERRESHOFF, AT LOW SPEED.

Swift Sure, and at the end of the first round she had only held her own, but at the finish she was ahead by 2 minutes 46 seconds. The time of the *Standard* for the first round was 28 minutes 52 seconds, making her speed 20.75 knots, as compared with 20.37 for the *Swift Sure*. On the second round the *Standard* made 21.50 knots, against 19.90 for the steamer. The *Standard's* speed for

and weather are not at hand, but will arrive by mail in another week. The race was run in heats, five boats, representing England, France and America, competing.

The American boat *Challenger*, the English boat *Napier II.*, and the French boat *Bayard* started in the first heat, *Challenger* getting away well. The *Bayard* fouled her propeller and *Napier II.* lost nearly a minute in crossing the line and then stopped short after going about 100 feet. In twenty seconds the English boat began running again and went after *Challenger*, which when about a quarter mile from the first outer mark, of which there were three, began missing explosions in her forward cylinders. By the time the third mark was passed the whole forward engine was dead in *Challenger*, which so slowed her that *Napier II.* passed her half a minute later and won the heat with a long lead in 25:10, including the minute lost in starting.

The *Napier Minor* (English) and *Trèfle-à-Quatre* (French) covered the course in the second and third heats alone to qualify.

In the fourth heat the two English boats, *Napier II.* and *Napier Minor*, raced for supremacy, *Napier II.* winning by 19 seconds in 24:04.

Although *Napier II.* qualified for the final, it was necessary to substitute *Napier Minor* for her as she was leaking badly at the bow, where she had been damaged in a previous race. This brought only the English boat and the French challenger, *Trèfle-à-Quatre*, together in the deciding event. The French launch was one second slower than her English opponent in starting, and after crossing the line showed inferior speed, being soon distanced and finishing 1 minute 25 seconds later than *Napier Minor*, which won in 23:01, or at the rate of twenty-three statute miles an hour.



REGINALD C. VANDERBILT AT THE WHEEL OF HIS MERCEDES TOURING CAR.

Scout and *Mirage*, with none of the freak features of the latest gasoline boats. She is 51 feet on the water line, 6 feet in breadth, and carries a triple expansion engine of 100-horsepower at 700 revolutions, her boiler being tested for a working pressure of 270 pounds.

The course was from off the Atlantic

the full course was 21.12 and that of the *Swift Sure* was 20.13.

Running alone, the *Vingt-et-Un II.* made the first round in 29 minutes 4 seconds and the full course in 57 seconds 54 seconds, a speed of 20.72 knots, a very good performance as compared with the *Standard*, which is a larger boat.

TOURISTS HALF WAY TO ST. LOUIS.

An Enthusiastic Body of Automobilists Arrives in Cleveland After a Seven Day Journey on Good, Bad and Indifferent Roads.

Special Correspondence.

CLEVELAND, Aug. 2.—After seven days of touring and one day of rest, the drivers, friends and newspapermen occupying seats in the twenty-four cars now *en route*, arrived in this city to-day. Without exception every one connected with the run is delighted with the success that has greeted the efforts of the American Automobile Association touring committee and the general good time enjoyed on the road.

One or two have fallen by the way, it is true, and one or two, owing to a pressure of business, could not indulge in the entire 1,500-mile run, but almost all who started are still with the "bunch" and enjoying themselves. There are several ladies in the party, more than there have been in any other long tour or endurance held in America.

There are laughable incidents, lots of them. In the first place, every one declares most emphatically that this is a pleasure tour—not a race or endurance run—and they are sincere in these declarations. Yet these same individuals when a car comes rushing up behind them shove their throttle wide open, advance the spark, and bend low over their steering wheel, advance their spark until their engine whether it be one, two or four-cylinder, is working to its fullest capacity. They take "thank-you-ma'ams" and "chuck holes" as though they were merely shadows on the road, and if they are eventually distanced by a car possessing more power and speed than their own, declare most emphatically that their gasoline gave out.

No, there is no racing on this trip, yet why do owners of machines capable of traveling forty miles an hour get up at 3:30 a.m. and without a bite to eat drive their cars at their limit toward the night control only 100 miles away, an easy five-hour trip? And why is any one so angry when he hears that the driver of a Smith or a Jones machine was called at 2:30 a.m. and has been in at the night control three-quarters of an hour before he arrives with his Brown racer? The secret of the whole matter is simply that the newspapers chronicle each day who was the first to arrive in town and what machine he drove.

The start from New York city was scheduled for 9 a.m., but was made about 9:45 o'clock. The early starters from Poughkeepsie were called at 6 a.m., from Albany at 5 a.m., from Utica at 4 a.m., and one man from Rochester was aroused at 3:30 a.m. in order to be the first to arrive in Buffalo. So anxious are the tourists to arrive at the night stops that noon stops are cut out altogether, not more than a dozen persons in all taking meals at the designated midday stop.

Of course, there are some who do no racing, who run their cars on schedule, take in the noon-day stop, and arrive about 4 or 5 o'clock at the end of the day's run. Some do this because they think it the proper way to travel on a tour of this kind. Some do it because they possess slow cars and know

the squadron. Jay wishes to discourage the racing spirit that has cropped out on all sides and quietly pilots his machine along in the dust of others with the remark: "I'll show those fellows some time what this little White can do when I want to run it."

Messrs. Post, Gillette and Whipple, officers of the A. A. A., have all refrained from joining in the racing, although the White steamer, driven by Post and the Pope-Hartford and Mercedes of the other two are built for speed.

Thus far there have been no very serious accidents, although several of the machines have suffered from minor troubles. Harold Pope, son of the worthy colonel, drove his Pope-Hartford over a steep bank on the third day out while taking a curve on his high speed, smashing lamps and generally bending things up; the big Mercedes of President Whipple broke its time shaft between Rochester and Buffalo and had to be towed in by the Haynes-Apperson and later by the big special Peerless owned by R. B. Scott, of Baltimore. The Cadillac, driven by W. C. Hurlburt, of Detroit, had some trouble with its steering gear and went over an embankment,

bending things up badly, but not putting it out of commission. The big Peerless had "troubles of its own," and almost every car in the run, foreign cars excepted, have at some stage of the game possessed badly sprung front axles, which are quietly straightened out at night in most cases. Trouble with ignition, spark plugs, coils, tires, and springs has bothered almost every one of the tourists, while two of the newspaper men accompanying the run, F. Ed. Spooner, of New York, and Percy F. Megargel, of Rochester, have had their typewriters damaged by the rough roads over which all had traveled before reaching the good State roads in Monroe County, New York, which were followed by other equally good highways in Pennsylvania and Ohio.

A feature of the run that has never been brought prominently to public attention before is the killing of domestic fowl along the roads traveled. In the story of the tour



MAKING WAY FOR A TEAM IN THE MOHAWK VALLEY IN NEW YORK.

that to try conclusions with the fast cars would be only to demonstrate how slow their machines really are; while others do it in order that when they make repairs no others in the party will pass them and see their cars broken down.

There are more White steamers in the run than cars of any other make, the White always having demonstrated that it was an excellent touring car. Augustus Post, chairman of the committee having the run in charge, drives a White. Webb Jay, one of the most conspicuous figures in automobile circles, always having a hand in the touring, hill-climbing or racing game, is driving the same White that has carried him to victory on hill and track in the past. Jay is also in command of the "White Squadron," as the five steam cars, which keep together, are commonly called, and it is needless to say that it brings the tears to his eyes to see gasoline cars, that he knows he can beat in a race, go sailing past his lit-

of the *Pathfinder* over this route some weeks ago, the writer incidentally mentioned the fact that we occasionally struck a dog, maiming or killing him, but said nothing about barnyard fowls. On this run, from the first day out of New York, chickens have been "getting the worst of it." When encountered in the roadway hens, ducks, geese and turkeys invariably run along the road directly in front of the automobile. If the car is traveling at twenty-five miles an hour or more there is no fowl that can outrun it and unless they dodge off the road very soon they are overtaken and run down. Some go under the wheels and are killed. Others go through the entire machinery and come out dead and plucked of their feathers.

On Monday, August 1, the writer started from the Iroquois after the "bunch" had departed and driving leisurely along the lake road, had an opportunity of seeing what a terrible execution had been wrought by the machines ahead. Dead chickens, dogs, turkeys, ducks, geese and one fine peacock, lay bleeding beside the road, some of them not quite dead. At every farmhouse between Buffalo and Erie there was probably mourning and cries for revenge, but whose fault is it? There is no law protecting live stock or fowl left to run at large in the highway, and with a hundred miles to go in a few hours, few drivers cared to slacken down for fowls in the road. For dogs the writer has no sympathy—big vicious brutes that run out and snap at the front tires while the wheels are revolving at a three-minute clip. They "go down and out" very quickly on the day the big tour passes if they attempt these tactics.

Charles J. Glidden had a little adventure on Monday of this week. He preferred to start at a reasonable hour and take his time, and it was while bringing up the rear of the procession that he was "held up"—not by masked robbers armed to the teeth and wearing black masks, but by an even more dangerous adversary, an enraged Erie County farmer, whose prize Plymouth Rock lay struggling in the roadway with both legs broken, the result of being run over by one of the twenty odd machines that had preceded Mr. Glidden.

"I want one dollar from you to pay for that chicken which some one in your party killed. I don't care who killed it, you belong to the gang and you have got to pay for it." As this remark was emphasized by a double barrel shotgun, which looked to the occupants of the big Napier as though it was loaded to the muzzle, Mr. Glidden cheerfully (?) complied with the demand and passed over the dollar. The rustic grasped it in his palm and after lowering the threatening weapon said: "Well, I will let you go at that this time, but if you or any of your friends ever kill another of my chickens there will be some other blood shed, and don't you forget it."

In the hotel dining room that night 100 cents were collected among the tourists and handed to Mr. Glidden, preceded by a very

formal address by Mr. Post. Investigation at the garage in the evening resulted in finding feathers on a number of cars.

There are large crowds of spectators awaiting the arrival of the tourists at every hotel, and all along the line of march the enthusiasm is intense. Flags are displayed on buildings and small children wave flags as the machines pass by their homes. The big sisters of these small children stand near and attach bouquets to such cars as stop. Many of the cars must make frequent stops, as they come into the night control well laden with flowers, apples, peaches and other tokens of a pleasant day in the country.

Automobile enthusiasm in and around Syracuse seems to be intense, but the roads are among the worst it has been my experience to travel over during the entire season's touring of some 4,000 odd miles.

There was not much "doing" in the way of entertainment at Rochester, although the members of the reception committee were awaiting the arrival of the tourists at the Powers hotel, where a hearty hand shake awaited all. It was probably better that no elaborate plans for the evening had been made, as all were worn out with their hard day's run, it having rained the night before, putting the highway in "fierce" condition. A number of the tourists formed a small party of sightseers and ran over to "Rattlesnake Pete's" for the evening, where they were entertained with snake stories and were given an exhibition of Pete's fearless handling of the dreaded rattler that caused these men, who fear nothing while traveling behind the steering wheels at a forty-mile clip, to draw back until yards separated them from the den of live and squirming snakes. Webb Jay hasn't got the sound of that rattling out of his ears yet, he says.

The run from Rochester to Buffalo, seventy miles, was over as fine a stretch of good roads as one might wish and everyone "hit it up" to a speed limited only by the capacities of the car. Some of the tourists who had been over this bit of roadway before did not start until afternoon.

At every night's control there is one official garage at which most of the machines are stored, and there is presented an opportunity of seeing an automobile exhibit without charge. Every one in the city who is interested in automobiles manages to get around to the garage during the evening. The cars that attract most attention are: First, Charles J. Glidden's English Napier, with its enormous wheels fitted with very large tires of a peculiar construction to prevent slipping and also having an arrangement to pull out nails or tacks that are picked up by the outer casing. Charles Thomas, Mr. Glidden's engineer, is not averse to showing the merits of this machine and the crowd that continually hovers around it shows plainly what an object of interest it is. After Mr. Glidden's car comes the big special Peerless of R. B. and C. S. Scott, of Baltimore. This machine, with

an estimated horsepower of eighty, is without doubt the largest touring car ever constructed in America. It is of the four-cylinder type and looks like a combination of the Peerless and Mercedes. Of the smaller machines, the little Elmore, covered with the mud and incidentally the glory of having traveled in ten States thus far this year, receives most attention. The original signs reading "New York to St. Louis" are still in place on the hampers and above them are tacked two new signs reading "Second Trip." This machine, while the smallest in the lot, having twenty-eight-inch wheels and three-inch tires, is certainly entitled to rank in the veteran class. Still another machine that has made a name for itself is the White, driven by Webb Jay, the same one he drove in the New York-Pittsburg Endurance Run last fall and from New York to St. Louis last June.

Chairman Post, of the Tour Committee, is still the hard working enthusiastic tourist that he is credited with being and personally looks after the wants and comforts of the entire party. Mr. Whipple, another familiar figure to automobilists, and his big Mercedes, have a certain friendly appearance that makes acquaintances all along the way. The tonneau door of his automobile is closed tight and an iron frame bolted on the rear supports a pair of extra tires, a huge coil of rope and a spade. The spade causes the same chilly feeling to pass over the new tourist as was caused at the outset by seeing tackle and blocks dangling from the front deck of the *Pathfinder*. "Will we have to dig ourselves out of the mud with a spade and use blocks and tackle when we strike that Illinois road?" is the question that is asked as these recall unpleasant memories of the pictures showing what Illinois and Missouri mud is like.

Following a trail of *confetti* is an easy task if the torn paper is properly laid. Sometimes it is and again it is not. On most occasions those in the pilot cars strew so much paper along the roadway for the first ten or twenty miles that by the time seventy-five or one hundred miles has been covered there is no *confetti* left and the tourists have to decide for themselves which roads to take. This is comparatively easy when a dozen or more machines have already gone over the route, but some one has to be the first one over the road, and for him to pick his way when the trail is scant is a very difficult matter. Sometimes, even though the *confetti* is well laid, it becomes confusing before the day has passed. In the run between Erie and Cleveland the trail was beautifully marked by the pilot car, but it did not remain so, for one of the big Panhards rushing over the course just at day break caused such a whirlwind that the *confetti* was thrown in every direction by the wind. To make matters worse, in Painesville a liberal quantity of tour paper had been strewn along Main street to mark a certain turn to the right. This was laid before daybreak and when the street

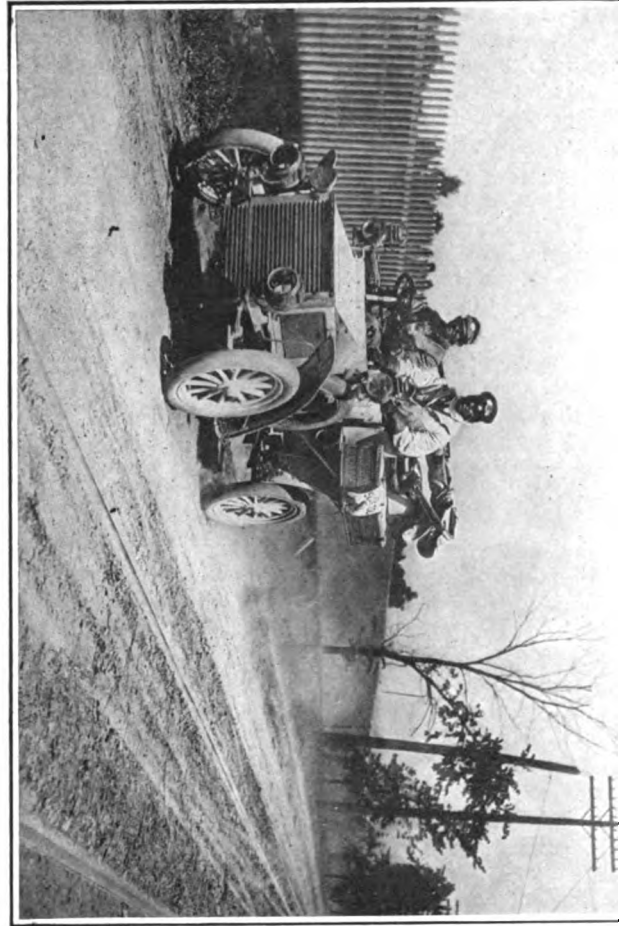

Geo. H. Lowe of Boston in White Steamer at the City Line in Buffalo.

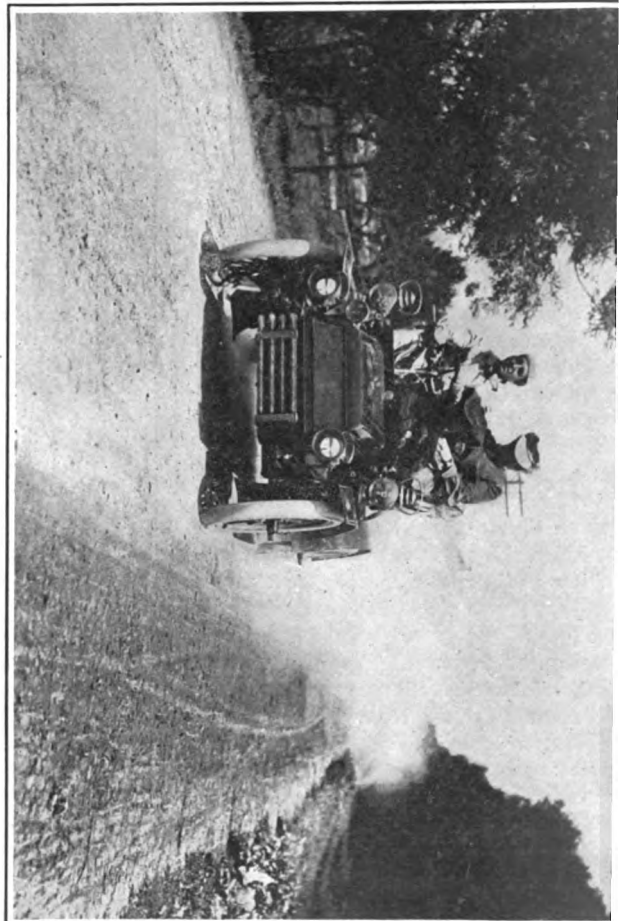

Mr. and Mrs. Gillette Bringing Mrs. Whipple Into Buffalo after Breakdo wn.

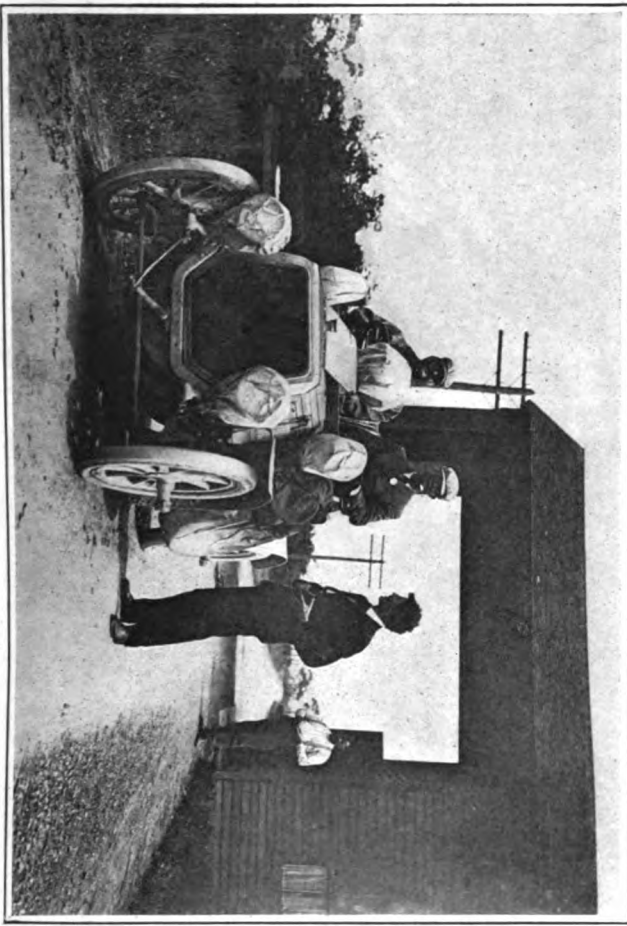

J. M. Waters of New York in 2-Horsepower Panhard paying Toll.
SNAP SHOTS. MADE IN TOWN AND COUNTRY IN NEW YORK STATE. OF SOME OF THE TOURISTS IN THE AMERICAN AUTOMOBILE ASSOCIATION'S RUN TO ST. LOUIS.

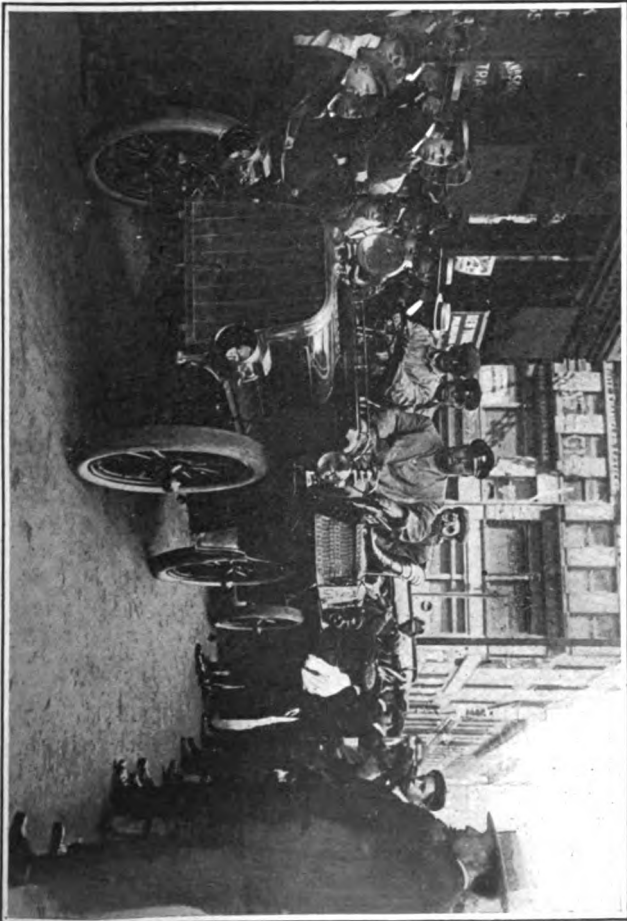

Frederick Leah of Boston in Pope Toledo After Arrival in Buffalo.
SNAP SHOTS. MADE IN TOWN AND COUNTRY IN NEW YORK STATE. OF SOME OF THE TOURISTS IN THE AMERICAN AUTOMOBILE ASSOCIATION'S RUN TO ST. LOUIS.

sweeper passed an hour or two later swept the scattered particles all the way down the street for five blocks beyond the turn.

Looked upon from the viewpoint of the chief promoters of the run so far it has been very successful. Augustus Post, in an interview Sunday, said: "The objects in the mind of the promoters were three-fold: to demonstrate the practicability of taking long tours in automobiles; to prove the pleasures of such trips, and to increase interest in good roads. I have had a better time during the last week, I think, than in almost any similar period of time I can remember. We have traveled in a leisurely manner through the state of New York and while we have encountered some rather bad roads, we are showing ourselves and every one else who is interested that the motor car is a practical vehicle for those who wish to travel, even on American roads. We are showing this to the sportsmen rather than to the trade, and I feel confident that interest in motoring on the road will be increased by this tour of ours."

There are six women with the run, all of whom seem to take as great an interest in the day's trip as do the men. Despite the fact that there have been a number of hard showers while on the road and also that dust has been more than plentiful in certain sections, these women always manage to look as though they had just stepped out of a Pullman, instead of a dusty, hard driven automobile. The women are: Mrs. Glidden, Mrs. H. W. Whipple, Mrs. C. H. Gillette, Mrs. Lesh, Miss Camp and Mrs. F. W. Richards

While the tourists and their escorts were at dinner in the International Hotel at Niagara Falls one old lady in the crowd of sightseers gathered around the line of automobiles at the curb was heard to say: "Why, there seem to be more of those St. Louis cars than any other make. They must be all made by the A. A. A. Company, I guess, from the way those signs read."

Almost every machine carries one or more cameras and snap shots are taken upon every provocation. When provocations do not turn up often enough, there is posing for an effective picture; and it was reported that one machine was almost put out of the run by being sent over an embankment to secure a good position for a dramatic picture. Owing to the large crowds that assemble at every stopping place it is almost impossible to take a good picture of the machines as they enter or leave the controls.

Registering on the official control list is not allowed until 7.30 p.m., nor later than 10.30 p.m. All cars coming in after 10.30 o'clock will have issued to them second class certificates. Cars making every control before 10.30 will receive first-class certificates regardless of the length of time consumed in getting from one town to another. To receive a first-class certificate a car does not positively have to come in under its own power, but it must be in. If broken down it can be towed in by another machine or even a horse.

Just how many additions will be made to the number of cars that left Buffalo before the cavalcade reaches St. Louis is problematic, but it is a pretty fair estimate to say that 100 cars, carrying 300 passengers, will arrive in St. Louis August 10, providing that rain does not render traveling through Illinois impossible.

The banquet served in the banquet hall of the Hollenden hotel by the White Sewing Machine Company was enjoyed by all the tourists, as were the speeches afterward. About 150 guests sat around the tables, but President Whipple, of the A. A. A., was conspicuous by his absence during the meal. He and Mrs. Whipple drove up to the hotel at 8.55 p.m., after spending about twelve hours on the road between Erie and Cleveland. First, it was engine trouble and then tire trouble, until for a time it looked as though the big 40-horsepower Mercedes would miss a control to-night. Finally the difficulties were overcome, and the big machine rolled up to the hotel just as the banquet crowd settled back in their chair for cigars and "jump spark."

Among the exceptionally good runs today was that of the Panhard of James Waters, who made the 118 miles in 3 hours 48 minutes, and the Elmore, which covered the distance in an even four hours. The tourists were joined at Cleveland by Mr. and Mrs. W. C. Temple, of Pittsburg, in a Pierce Great Arrow; Mr. and Mrs. E. H. Wallace, of Freeport, Pa., in a seven-horsepower Rambler; Mr. and Mrs. George S. Waite, of Cleveland, in a White steamer; Dr. Gifford and three passengers in a White; Mr. and Mrs. Fred Gates, and two passengers in a White; Mr. and Mrs. "Jack" Blakeslee and two passengers in a Winton; H. B. Dyer and three passengers in a Winton; T. C. Collins and three passengers in a Peerless and R. H. Johnson and driver in a Peerless. PERCY F. MEGARGEL.

THREE PENNSYLVANIA STARTERS.

Special Correspondence.

PHILADELPHIA, Aug. 1.—Promptly on the stroke of 6 o'clock last Wednesday morning Walter B. Saunders left his pretty Overbrook home en route for St. Louis. Having been advised that a light outfit was desirable, owing to the stiff grades to be encountered, he decided to leave his tonneau at home, and, accompanied only by his chauffeur, he predicted a safe trip for his 20-horsepower Winton.

While Mr. Saunders is the only local starter in the run, there were two other starters from points near the city. They were E. T. Allison, of Wallingford, who decided to take the trip only twenty-four hours before the official hour for starting, and A. T. Keeley, of Ryersford. Mr. Allison was accompanied by C. L. Allison and John B. Hamel, while Mr. Keeley's party included his two brothers. The Allison car is a four-cylinder 24-horsepower machine, and Mr. Keeley's a 7-horsepower Rambler.

All three machines are scheduled to take

the National Pike route. At this writing Mr. Saunders is in the lead, the Allison's having trouble on the road and being compelled to return to Cumberland, where the car was put to rights in a machine shop, resulting in the loss of an entire day.

Assistant Secretary Gundlfinger, of the Automobile Club of Philadelphia, tried to induce the Allison and Keeley parties to come to Philadelphia and start with Saunders from the A. C. of P. headquarters, promising them an escort of a dozen or more cars as far as Morristown; but after the escort was secured the participants decided to each start "on his own hook."

TEN CARS LEAVE BALTIMORE.

Start Over Southern Route with New Orleans and Norfolk Entries.

Special Correspondence.

BALTIMORE, July 29.—Promptly at 9 o'clock this morning the Baltimore division of the A. A. A. tour lined up in front of its headquarters at The Altamont and on the given signal the ten automobiles fell into single file and amid the tooting of horns and the cheers of the spectators struck the trail which leads to the Exposition City. They were escorted as far as Ellicott City, twenty miles out, by members of the Automobile Club of Maryland, headed by Secretary C. Warner Stork. Two women accompanied the starters in the tour.

Owing to the light rains of yesterday the roads outside the city were found to be free from dust and in very fair condition, but it is impossible to say how they will be up State, where the rainfall was considerably heavier.

All of the tourists do not expect to reach St. Louis. One or two will probably drop out at Cumberland or Wheeling, but they declared in chorus as they left the escort that they would keep on so long as they found passable roads and fair weather.

Those who left this morning were: Hart Newman and Sam Stone, of New Orleans; Secretary Stork, of the Automobile Club of Maryland; Messrs. Gill and Dickey, of the Baltimore committee; W. H. Rife, parents, and Mrs. Rife, D. A. Clark, M. W. Higgins, J. J. Mason, R. G. Atkinson, Robert French, Howard French, F. H. Hack, Jr.; Waldo Hack, O. Gooden, C. W. Hooper, and Palmer Abbott, Roy Collins and Frank Ziegler, of Norfolk, Va.

The tourists will follow the route laid out for the Baltimore division—through Hagerstown, Cumberland, Wheeling, Zanesville to Columbia, where they will meet the Central division August 5.

NO MILWAUKEE ENTRIES.

Special Correspondence.

MILWAUKEE, Aug. 1.—Although twenty and perhaps fifty automobiles from Milwaukee and the Northwest were expected to join the tour to St. Louis at Chicago, no entries from this section have been made, and it is doubtful if any automobilists will participate, as the entry date has passed.

ROYAL TIME IN SYRACUSE.

Tourists Entertained at Banquet and Opera by Local Club and Manufacturer.

Special Correspondence.

SYRACUSE, Aug. 1.—Their ardor undampened by the miserable roads over which they passed in the run from Albany through the Mohawk Valley, the World's Fair tourists arrived in Syracuse last Thursday. They were ready, however, to stop for a night's rest and merry making.

As the visitors came up to the Yates hotel with a dash, their cars coated with mud, they were met by officials and members of the Automobile Club of Syracuse, under whose auspices all arrangements for the pause here were made. Every member of the club was on hand during the afternoon and evening, and President Willet L. Brown and Secretary-Treasurer Frederick E. Elliott as well as Carl L. Amos, H. W. Smith, T. A. Young and H. W. Chapin, of the entertainment committee, were especially active.

Pinned upon the coat of every local man was the insignia of the Automobile club upon the fluttering ribbons of which was imprinted in letters of gold "Welcome to the St. Louis Tourists, July 28-29, 1904." And with these the tourists were also decorated as they arrived.

In accordance with custom, on such occasions, the first car to arrive in Syracuse, the home of the H. H. Franklin Manufacturing Company, was that company's only car in the tour, which reached the A. A. local headquarters at 9.45 a.m. It was followed at 10.20 by a Pope-Toledo touring car, carrying Albert L. Pope and Arthur W. Pope. Albert J. Seaton and son, in a Buckmobile, carrying the message of greeting from the Mayor of Utica to Mayor Wells, of St. Louis, were third, and five minutes later came a Pope-Hartford containing Harold S. Pope and Walter Ziegler.

Four White touring cars arrived in a bunch at 11.10 a.m., having traveled together all the way from Albany, as is the White custom. Augustus Post, who was at the wheel of the first, stated that it was a good thing they had done so as they had to help each other out of mud holes and ruts in the roads more than once. "Worst roads I ever saw down there in the Mohawk Valley," said he, and his words were echoed by every one of the visitors. When it came to discussing the roads between Albany and Utica, they could not find words strong enough to express themselves. Along the Hudson and from Utica here, they allowed it to be understood, the highways were fair.

Among the late arrivals were Mr. and Mrs. Harlan W. Whipple and Committeeman Hurlbut W. Smith, of this city, who is in charge of the arrangements for the tour across the State from Albany to Buffalo. Mr. Smith was the guest of Mr. Whipple in his car from Albany here.

At 6 o'clock all of the tourists had arrived and a few minutes afterwards the visitors and local club members, to the number of 150, found their way to the big dining room of the hotel where a banquet had been provided through the Franklin company. All of the men filed into the big room, while in a small dining room so near that they could hear the ringing speeches that were made, the women tourists and a dozen or more prominent Syracuse society women enjoyed the dinner. Even the menu cards were made to show the spirit of the automobile, as a glance at one will show:

MENU

Gasoline Cocktail
Four Cylinder Clams on half shell
Olives Celery Radishes Salted Almonds
Air Cooled Green Turtle
Kenebeck Salmon a la Gerry
Cucumber Tonneau Baskets New Potato
Rissole
Sauterne Shaft Drive
Larded Filet of Beef a la Franklin
Green Peas
Roller Bearing Burgundy
Croquets of Sweet Breads, Automatic
Sauce
Float Feed Sorbet
Broiled Chicken Differential Style
Mum's Jump Spark
Tomato Stuffed Cylinder Oil Mayonnaise
Automobile Ice Cream
Assorted Fancy Cakes
Spark Plug Cigarettes
Roquefort Cheese, Rich Mixture
Short Circuit Bent's Crackers Wafers
Open Exhaust Cigars
Fruit Cafe Noir
Music by Spooner's Band
Butter and Cheese from Whipple's Farm

Seated at the head table were: Willet L. Brown, president of the Automobile Club of Syracuse, H. H. Franklin, Mayor Alan C. Fobes, Augustus Post, George S. Larrabee, Commissioner of Public Safety Ralph S. Bowen, Harlan W. Whipple, C. H. Gillette, Hurlbut W. Smith, Charles J. Glid-

den, John Wilkinson, Frederick H. Elliott, Carl L. Amos, Albert A. Pope, Jr., Arthur Pope, Harold Pope, A. B. Tucker, C. A. Benjamin, M. L. Downs, F. Edward Spooner, J. H. Gerrie, Emerson Brooks and J. M. Waters.

When the attack upon the viands had become less strenuous and glasses had been refilled, President Brown proposed a few speeches and first called upon Mayor Fobes. In his happiest vein, the Salt City's young chief executive told the visitors that the city was theirs. Although not an automobilist himself, the Mayor explained, there was a good chance for him to become one, if "Ben" (C. Arthur Benjamin) would only visit the City Hall on a customer-hunting expedition.

Giles H. Stillwell, a Syracuse attorney, painted a brilliant future for the automobile, and in even more brilliant colors did Augustus Post speak of the motor car and its mission in war as well as in peace. Albert L. Pope said that he hoped the Toledo Club, of which he was a member, would be able to duplicate the treatment which the tourists had received in Syracuse. They could not better it, he said, as he proceeded to call for a toast to the Automobile Club of Syracuse and the Franklin Company, which was responded to with a will.

At the close of the dinner, the entire party boarded the special trolley cars in waiting and was transported to Onondaga Valley, three miles distant, where it listened to "Fra Diavolo." It was a happy and appreciative audience. The opera put the company in good humor at once, as the singers did their best to please. At times the audience assisted the vocalists on the stage. It was long after midnight ere the party had returned from the Valley and the tourists had found their way to bed to rest up for the continuance of the trip.

A Peerless touring car, with Harry C. Pierce at the wheel and W. L. Brown and H. W. Smith aboard, left here in the early hours Friday morning to show the way by a trail of confetti to Rochester. The first of the tourists left the city about 6 a.m., the

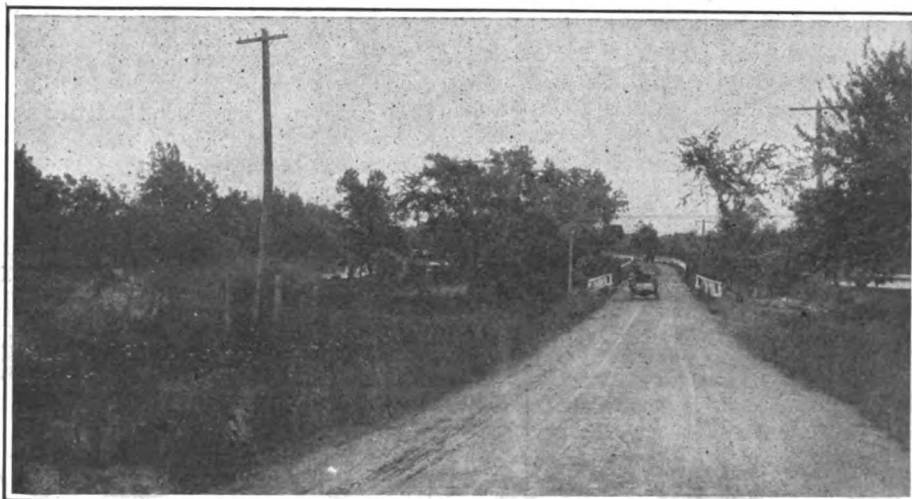

A STRETCH OF GOOD ROAD WEST OF ROCHESTER, NEW YORK.

others following at intervals until the last car disappeared from the Salt City about 8 o'clock.

The tourists' stay in Syracuse was far too short in the opinion of the club members, but will be long remembered as an event in local history.

VISIT THE FALLS.

Tourists Make Fast Run from Rochester to Buffalo and Spend Sunday Sightseeing.

Special Correspondence.

BUFFALO, Aug. 1.—Buffalo was the host of the tourists for practically two days. Some of the tourists arrived early Saturday morning and others continued coming in throughout the day. The arrival at Buffalo concluded the sixth day of the run, twenty-three cars having left Rochester on Saturday morning. Including the cars which went from here to Batavia to pilot the tourists, the party consisted of about thirty automobiles, each carrying several passengers.

Percy P. Pierce was the first of the tourists to reach Buffalo, arriving at 7:25 a.m. in the Arrow car. He had made the 73-mile run from Rochester to Buffalo in 2 hours 25 minutes. Others came in at varying intervals, making the Hotel Iroquois their destination.

The day was notable for the small number of mishaps, the road being in its best condition. The only accident of account befell Harlan W. Whipple's Mercedes car, the axle of which broke at Crittenden, a small town a short distance from Buffalo. C. V. Birchwood, of New York, with his Haynes-Apperson car, volunteered to tow the crippled machine into Buffalo, but after covering about six miles they were overtaken by the Messrs. Scott in Mr. Whipple's special Peerless, which relieved the Haynes-Apperson of its load. C. H. Gillette broke a rear spring on his Pope-Hartford at Corfu and had to stop at a blacksmith shop for temporary repairs.

Jesse B. Eccleston, chairman of the entertainment committee of the Automobile Club of Buffalo, with a party, and Dai H. Lewis, with another party, went from Buffalo to Batavia to meet the tourists and pilot them through Chittenden and into the Bison city, scattering *confetti* to mark the route. When the run from Rochester to Buffalo was concluded some of the motorists, who at Utica were so dissatisfied with the condition of the highways that they sent a protest to Governor Odell, had revised their opinions of New York State roads and all freely admitted that Saturday's traveling was the best part of the trip so far.

Saturday night the Automobile Club of Buffalo gave a reception to the tourists, at which a number of informal addresses were made and incidents of the trip recounted. Most of the tourists, escorted by members of the Buffalo Automobile Club, made a trip to Niagara Falls on Sunday, and returned in the evening.

Augustus Post, chairman of the touring committee of the American Automobile Association, when in Buffalo said:

"I think I had a better time during the last week than in any similar period before. We traveled leisurely, and while we came across some bad spots, we are showing ourselves and others interested that the automobile is a practical vehicle for travel, even on the roads of this country. We are showing that to the sportsmen rather than to the trade, and I feel confident that this trip will do much to increase interest in motoring. The trip will show that the roads and machines of America have been improved within the last three years."

President Whipple, of the A. A. A., speaking about the attitude of the rural communities toward the automobile, said that much of the antipathy that formerly existed had been removed.

Charles J. Glidden, of Boston, had a conference with President William H. Hotchkiss, of the Buffalo Automobile Club, Mr. Whipple, Mr. Post and others in reference to the reliability test cup, which he is to offer in competition next year. It is announced that the trophy will cost \$2,000 and that its height will be three feet. The competition is to be in the hands of the touring committee of the American Automobile Association. It is suggested by Mr. Glidden that the distance be not less than 1,000 miles, to be covered in ten days, each car to be driven by its owner, accompanied by a woman, if he has a family, and by an engineer and one observer. A condition to be imposed is the carrying of 200 pounds of baggage. Those are the tentative propositions; they have not been definitely decided upon and will not be until the party gets to St. Louis.

There were many incidents more or less amusing on the trip from Rochester to Buffalo. The Pierce Arrow came near running into a herd of cows that refused to budge, but Mr. Pierce got his machine past the animals without injury to them or to the car. A chicken got caught in the machinery of one of the cars and came out at the other end dressed as if for the poultry store. Several of the cars killed a number of chickens on the road.

Robert P. Scott, of Baltimore, was served with a summons by Deputy Sheriff William Kaiser at the Iroquois Hotel on Saturday night on a complaint issued by a Rochester man whose horse was frightened by Mr. Scott's automobile. The animal ran away and had to be killed.

Before Buffalo was awake this morning some of the automobilists had started again on their journey to the World's Fair. The first starter was M. J. Waters, of New York, in his 24-horsepower Panhard. He left the hotel at 3:25 a.m. Five minutes later he was followed by C. V. Birchwood, in his White.

Mayor Knight, of Buffalo, sent on with the tourists a letter to Mayor Wells, of St. Louis, in which he wished the big Fair the best of success and expressed the hope that

the motorists would arrive safely in St. Louis.

At Buffalo the party was joined by James L. Breese, of New York, in a 40-horsepower car, and Harold Hoag, of Lockport, N. Y., in a 6-horsepower machine, which was the smallest of the cars that left this city.

ST. LOUIS RECEPTION.

Tourists to Be Escorted into City and Through World's Fair Grounds.

Special Correspondence.

ST. LOUIS, Aug. 1.—The president of the St. Louis Automobile Club, A. B. Lambert, has completed arrangements for the reception of visiting motorists August 10.

Near the end of the tour route all machines will be cleaned and decorated, for it is proposed to enter St. Louis in holiday attire. The tourists will be met in East St. Louis by a committee of the club, who will greet them and escort them across Eads's bridge to their hotels. The president is kept informed by telegraph of the movements of the motorists. On the morning of August 11 the visitors, accompanied by 160 local motorists, will form a parade at Twelfth street, headed by Mayor Wells and Chief of Police Kiely, and will proceed by way of Chestnut street, Lawton avenue and Lindell boulevard to the Fair Grounds.

After a ten-mile tour of the Fair Grounds they will proceed to the Plaza of St. Louis, where President Francis, of the Louisiana Purchase Exposition, will formally receive them. The tourists will then present to Mayor Wells of St. Louis letters from the mayors of all the cities through which they have passed. Luncheon will be served in the Tyrolean Alps.

The following afternoon, August 12, the tourists will be entertained at a smoker in the Lumbermen's House of the Hoo Hoo. The St. Louis Automobile Club will give a lawn party at the club house in Clayton road as the principal function in honor of the guests.

Automobile speed contests will be held at the St. Louis Fair on Sunday, August 21, on the mile track in the grounds. The track has been specially prepared for the occasion by banking, and a survey has also been made to obviate any doubts that might exist regarding the accuracy of the distance. The meet has been sanctioned by the racing board of the American Automobile Association. Handsome prizes will be offered for the contestants in the eight events that have been scheduled, and a number of entries have already been received. The accommodations for spectators are enormous, the management stating that 100,000 persons could be taken care of without difficulty.

The New York agency of the French automobile firm of Panhard & Levassor has entered two machines for the Vanderbilt Cup race on October 8. The details of the automobiles entered have not yet been forwarded to the committee.

On the Trail of Confetti.

St. Louis Tourist's Notes in Old York State—Corkscrew Turns and Thank-you-ma'ams Keep the Drivers Guessing.

Special Correspondence.

ALBANY, July 26.—The tourists were joined in Springfield by F. M. Manross, of Forest ville, with a Columbia, who got away from Springfield about 7.10 a. m. Messrs. Glidden and Lesh also left before car 51 started, at 7.45 a. m. Just out of Springfield we overtook Mr. Glidden, whose Napier we wanted to test, as we believed it to be no faster than our car on the level and rather slower on the hills. What followed was not exactly a race, because we made no attempt to pass him, and both cars slowed down at the proper times; but it was still a merry chase, in which both cars were driven "all out" in the hills, at least, and possibly elsewhere at times. So far as such a trial could prove anything, it confirmed our impression.

The country, rolling in surface and with alternative cornfields, woods and pasture for the first dozen miles, became more hilly and wooded as we approached Fairfield. Our course was constantly upward, for we were entering the Berkshire Hills. Presently we were in a beautiful valley, with a narrow river on our right and abrupt wooded hills on both sides. For nearly twenty miles we followed that valley, up, up, always upward, and saw it close in on us to the proportions of a defilé, and the river diminish to a babbling brook, tumbling over stones and often wholly hidden by trees. Through Fairfield, Russell, and Huntington the roads were narrow macadam, varied by dirt roads admirably kept, crowned, ditched, and rolled smooth and firm. "Don't Drive in the Middle of the Road" was a common notice along the way.

We met few timid horses, but several nervous drivers, for all of whom we slowed down, stopped (car and motor), or got out and led the horse, as the case seemed to require. Where we could properly do so, we made the best speed we could. We were still following Mr. Glidden, but with no attempt to race.

The early morning fog had now partly lifted, but instead of the sky clearing, it presently began to sprinkle, and Mr. Glidden's party stopped to unfurl storm robes, while we pushed on with rubber capes and boots already in place.

Beyond Chester, a microscopic hamlet wedged in between high hills, the roads, now all of dirt, grew rougher and the steady uphill grind more arduous. We passed Mr. Manross's car, and immediately after overtook but did not pass Mr. Lesh. We lost sight of him presently, the road being so winding that a view for any distance was impossible. Soon after, on a short and apparently not difficult rise, our wheels sank inches deep in soft rotten saw-

dust, and we were ignominiously stalled. I had heard of the sawdust plan of repairing roads, and of its terrors for the automobilist, but I saw it face to face now for the first time. We backed down hill a little, and, finding the water a-boil in the tank, refilled the latter from a rivulet just at hand. Then, with Ulrich pushing, we attacked the hill again, and climbed triumphantly.

That was the beginning of the Chester Hill of local renown. It is an ascent perhaps three-fourths of a mile long, rising in wave after wave, with maximum slopes of fully 20 per cent. grade. It is certainly worse than Nelson Hill, that now dethroned ogre of the motorist on the New York-Albany route; but our car took it without a falter, with baggage and passengers all aboard. At the top we found Mr. Lesh refilling his water tank. His car, he said, had gone up also with all hands aboard.

The descent of Chester Hill—which ought to be called Becket Hill, as Becket Centre Postoffice is on its crest—is as long, steep and rough as the ascent. Like all such hills, it was punctuated with frequent and very sharp thank-you-ma'ams, which gave the tonneau passengers enough to do to preserve order among the luggage.

Lee and Lenox, as seen from a flying automobile, justify their fame as summer residence places. The latter in particular seems almost wholly made up of beautiful estates, most of them commanding fine views of the surrounding hills. The roads are like billiard tables, and it was not hard to believe that automobile owners in those towns sometimes found their temptations too great.

We reached Pittsfield in company with Mr. Lesh at 11 o'clock, an hour before Mr. Glidden, the next arrival. He had got up the hill all right, he said, but had taken a wrong turn and gone astray in Lenoxdale. Just behind him came Mr. Manross, who admitted shedding three passengers. Up to 12.45 p. m., when we left Pittsfield, I noticed no others, though Mr. Whipple's mechanic tells me that he reached Pittsfield about noon, having started at 9 o'clock.

Going out of Pittsfield in company with Mr. Lesh, we took the wrong road almost at the start, and both cars had to be pushed up a short muddy slope on the side of a wooded hill. Mr. Lesh stopped to rest when the pushing was over, while we went on. We learned our error a quarter of an hour later from a passing horseman, when about half-way down the longest, most tortuous, most precipitous, and roughest hill I ever saw. A beautiful valley, down which one could look out to hill after hill, miles away,

was seen, rounded on three sides by a hill—Taconic Mountain—many hundred feet high. Our road began near the top of the mountain, at one end of the horseshoe, and curved around to the bottom of the valley at the other end. The State road which we should have taken is a fine highway. The road we did take was a narrow track, with the thin dirt covering over the rock foundation nearly washed away. We went down with motor stopped and hub brakes jammed on hard—went down at a snail's pace, for the turns were like corkscrews, the trees hid all but the nearest fifty feet of road, and the thank-you-ma'ams were the most diabolical possible to imagine. Luckily the morning's shower had not made what dirt was left very slippery, else I might not now be penning these lines. I should say that hill was fully three miles long from top to bottom. Before we reached the foot the grease in our right rear axle bearing was smoking from the communicated heat of the brake, and we had to stop and cool it with water.

We struck the right road again at Lebanon Springs. Naturally, our mistake in route had cost us some time, and now Mr. Pierce tried to make up some of it. I believe we got off the road somewhere else, for we missed certain expected landmarks; but we got safely to Nassau, where we began to meet the peculiar and irritating geological feature of that part of New York State, of occasional rock strata, displaced from the horizontal, jutting up at intervals and forming natural thank-you-ma'ams at all sorts of unexpected places. Pierce was driving on the principle of taking every bump at the best speed practicable for that particular bump, and it was inevitable that he should miscalculate sooner or later. He did so—a little—on one of these rock thank-you-ma'ams, with the result that the present writer—in the tonneau—got a jolt that he will remember, and one of the steering knuckles got a slight bend. We finished the drive to Albany at a more sober pace, and the bend has by this time been corrected. Curiously, we were the first of the Boston contingent to arrive, Mr. Glidden following about fifteen minutes later. Mr. Lesh had the good luck to learn his error in route, from the same horseman who enlightened us, before it was too late to retrace, and finding on reaching the State road that others had gone ahead, he took things philosophically and arrived in Albany about 4.30 p. m. Mr. Whipple had preceded him by half an hour.

Albany to Syracuse.

SYRACUSE, July 28.—When we left Albany, about 8.30 o'clock, Wednesday morning, nearly all the others had started. The shower of the day before had laid the dust, and for the first eight miles we whirled at top speed over superb macadam. Then we turned to the left into the Troy Turnpike, a broad, but far from smooth, highway made by piling dirt on a bed of crushed stone.

This dirt was in the condition of half-dried mud, rutted and full of chuck holes, which we dodged when we could and jolted through whenever we had to. Interurban trolley lines have been built within the past two years through a large part of the Mohawk Valley, paralleling the railroads and, like the latter, visible for long stretches from the wagon road. Between Troy and Schenectady the electric line runs by the side of the turnpike, and is equipped with block signals as in approved railroad practice.

We bumped at good speed into Schenectady over rough macadam, and left it following the river by a road which last spring was entirely under water near the turn. Muddy earth roads followed, through a rolling country with cultivated fields and orchards. We were on the northern side of the Mohawk Valley, which is two or three miles wide, level and green between the hills to north and south. Disagreeable though the roads were, they were not so bad as to distract attention from the beauty of the landscape, smiling under a cloud-flecked blue sky.

Mr. Whipple, who then as usual had started late, passed us by another road, as we went through Schenectady, and we followed him into Amsterdam, stopping once or twice for nervous horses, for which, as for timid drivers, Mr. Pierce has uniformly shown all consideration.

The road from Schenectady to Amsterdam is narrow and mainly dirt, in good condition as dirt roads go, but disagreeably rough for any speed over fifteen miles an hour. I was, therefore, considerably sur-

unsuccessfully to hail us. The car was certainly fast for its size, and the night before Mr. Hurlburt, the driver, had promised to "do us up brown." He didn't do it, of course, but we had to put on more speed than was comfortable to keep out of his way, and I was rather aghast at the way the little car was put through mudholes and over the bumps in the road. I did not envy

This same circumstance, which seemed to have little relation to the character of the roads, struck me on the two following days as well, and it was not difficult to guess the reason. Nearly all the population of the counties containing the Mohawk Valley is found in or near the valley itself, which is served by two lines of steam railway and interurban electric lines, all in immediate

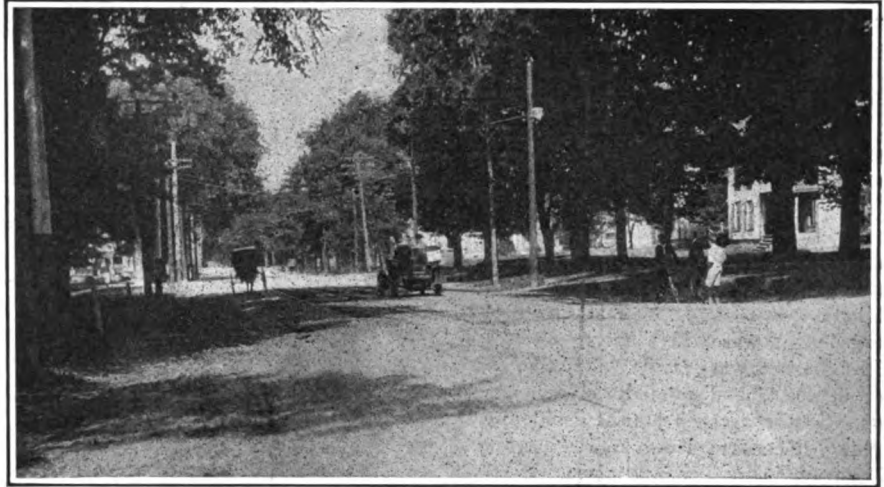

PASSING THROUGH THE LITTLE VILLAGE OF SOUTH BUTLER, WAYNE COUNTY, N. Y.

its passengers, though they did not seem to mind their punishment.

We were warned to go slowly through Amsterdam, but we went fast enough to pass Mr. Whipple's car; and when outside it became necessary once more to settle the respective merits of the cars. We were favored with good new macadam, and that the furious scurry which followed did not

proximity. Consequently there is almost no teaming or carriage travel between the towns, and even the through highways are very little used. Under the State aid law the towns pay but 15 per cent. of the cost of improving the roads, and the counties 35 per cent.; but, as most of the taxable property of these counties is in the towns through which the through roads pass, the hope of persuading these towns to apply for State aid, and spend money rebuilding roads which they hardly use is very small indeed. Either we must admit that the roads between Fonda and Syracuse are not enough used to repay improvement, or means must be found to rebuild them at the State's expense.

Tribes Hill, well remembered since the endurance run three years ago, is now sprucely dressed in a crushed stone road surface, with macadam thank-you-ma'ams, all new and very neat. We had to descend it carefully, for the thank-you-ma'ams were very abrupt. Approaching Fonda we struck a bit of rough road, on which Mr. Whipple was able to get by us, as we did not care to do "stunts" with that steering knuckle.

We reached Fonda at 11 a. m. and decided to stop for lunch, though the tourists who had gone through before us had pushed on to Little Falls. Five other machines arrived not long after us, and the occupants followed our example.

Out of Fonda we found the roads first good, then fair. For some distance the road ran level and close to the railroad tracks, its material a black pebbly dirt, which when we traversed it was firm and smooth. We made good speed, and on one occasion took what might be called a flying leap off the end of a small bridge, beyond which the

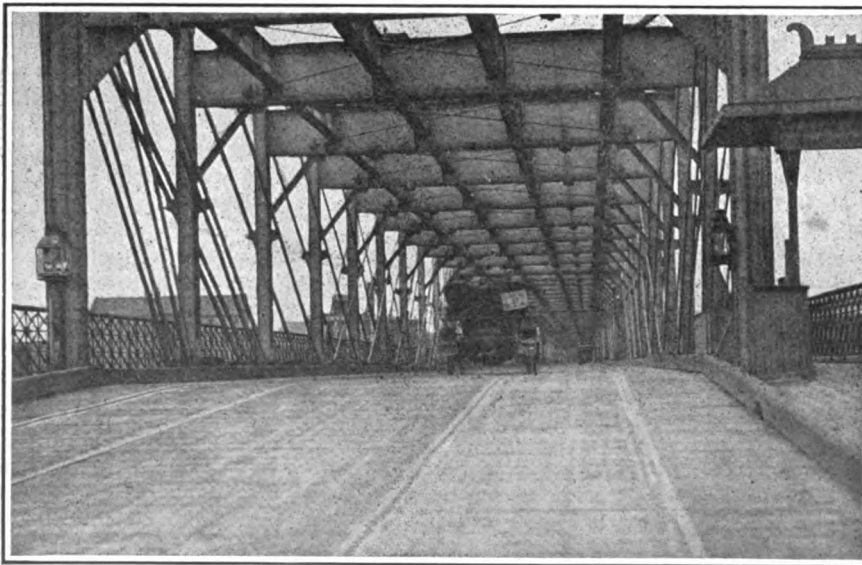

CROSSING THE TOLL BRIDGE OVER THE HUDSON RIVER AT ALBANY, NEW YORK.

prised to see the Cadillac car, carrying three passengers, coming after us at a rate which bespoke either a beautiful confidence in the running gear or a grim resolve to defy Fate. Beside the driver was "Johnny" Wetmore, well known to all New York newspaper men, his coat off and shirt sleeves rolled up, his feet on the dash, and in his hand a megaphone, through which he tried

result in trouble for some one was due in large measure to the almost wholly deserted state of the roads. It is possible even when racing to slow down for other vehicles, signalling the following car to do the same; but it is a remarkable and significant fact that, outside of the towns and villages, the vehicles which we passed on that day could almost have been counted on the fingers.

road fell away sharply. In another village—Spraker's, I think—we rushed a short hill at twenty miles or more, only to jump high into the air from a thank-you-ma'am near the crest. A crowd of happy villagers saw us perform this feat with great delight. That and similar incidents kept the tonneau passenger both busy and tired.

Such leisure as the roads gave us for looking around disclosed a charming panorama of tilled fields and pasture, gentle hills, and frequently a distant prospect for miles up the valley. Before long, however, these idyllic scenes were forgotten. In St. Johnsville we encountered the first specimens of that diabolical product of the up-state road maker; the "gridiron" road. This curious kind of highway, the like of which I have seen nowhere else, is a road built mainly of stone, but built and used in such a way as to become scored lengthwise with numerous parallel ruts, out of which it is impossible to keep the wheels. I have seen roads, both now and three years ago, of the width of a boulevard, completely ruined by ruts five or six inches deep and a foot and a half apart, over their entire width.

Such a formation is practically impossible in real macadam; and yet most of these roads resemble wornout macadam closely enough to deceive the casual eye. A close examination, however, of the roads between Fonda and Utica, nearly all of which were more or less of this character, showed that the material was simply a mixture of dirt and smooth round pebbles, piled on the road and left to be packed by travel. The dirt, instead of acting as a binder, when wet plays the part of a lubricant between the pebbles. When a rut starts, therefore, it holds the water, which wets the dirt below; and the pebbles, which average the size of a hen's egg, have no grip on each other, and, therefore, slip and are pressed down under the wheels of vehicles, which also force out the mud from the ruts, making the latter deeper. The dirt washes out in successive rains, and the result of several years of remaking the roads with this material is a surface of dirt or mud on a loose foundation of round stones, ready to creep and sink and ravel on any provocation. The most abominable roads of the tour thus far—the most difficult, most treacherous, and most exasperating generally—were those extending for several miles each side of Little Falls and Herkimer. We were there skirting river and canal, and the scenery was bewitching, but if we took our eyes for ten seconds at a time from the road ahead we were severely punished for doing so. Where trees overhung the road the mud was inches deep, and a sideslip was added to our other troubles. Pierce is a most skillful driver, and I was never for an instant uneasy; but it is no fun watching the road for jolts for hours at a stretch.

In and beyond Little Falls we overtook Messrs. Glidden and Lest, who sensibly were not hurrying; and beyond Herkimer we were chased full tilt over an inconceivably bad road by the Cadillac. As I watched

the little car with its three "shuck up" passengers go bouncing about behind us, I wondered that it had a spring, axle or steering knuckle left. Pierce, who was not taking chances, allowed it to pull abreast of us, after which its occupants drew long breaths of relief and moderated their pace.

Our running time from Albany to Utica (100 miles) was about 5 1-2 hours, which must be called very good, considering the roads. Mr. Glidden, in the hotel that night, emphatically pronounced the latter the worst in all his 16,000 miles of travel. France, he said, has 416,000 miles of roads, every mile of them better than any that we have seen since we left Boston. The unanimous sentiment of the tourists found expression in a round-robin letter to Governor Odell, in which the general opinion of the New York State roads was forcibly expressed, and hope voiced that a way could be found to better them.

A smart shower Wednesday night brought trouble to Mr. Scott, whose big 70-horsepower Peerless was caught in it between Little Falls and Herkimer. Because the wheels were not roped, it got into the ditch and had to be hauled out by horses. It reached Utica in the small hours of the morning and started with the rest between 7 and 8 a. m.

A leaking radiator racked by the hard going of the day before, delayed our start on Thursday until after lunch. The roads were of mixed varieties, but on the whole better than those of the afternoon before; and there were some very good stretches of macadam.

A good many drivers and some horses were afraid of us, the automobile being apparently less familiar here; but no trouble resulted. Our route, being the direct road through Oneida and Canastota, no longer followed the Mohawk river. The country was rolling, with few trees in the earlier part of the day, and some stiff hills in the latter part. The only "gridiron" road encountered was in Chittenango, but that one was certainly disgraceful. Indeed, I have noticed that the village streets hereabouts are apt to be in worse condition than the country roads.

From Utica onward we have found the trail of *confetti* left by the pilot cars very useful, especially where there is a choice of roads. Going out of Chittenango, however, we managed to take the wrong fork, and went over a very stiff hill into a region where few automobiles appeared to have been seen. We got a fine view from the hill, and the roads were not excessively bad. With the aid of a few inquiries we found our way to Fayetteville, where we picked up the main road again. Save for a short shower or two, ending in a hard downpour just as we reached the asphalt of Syracuse, the ride of fifty miles was quite uneventful.

Syracuse to Rochester.

ROCHESTER, July 29.—The air was cool and bracing when we left Syracuse this morning

in the face of a fresh northwest wind. It was beyond Syracuse that we had struck the worst specimens of gridiron road in the endurance run of September, 1901, and the general character of the roads was not greatly changed, although local deterioration and improvements were noted. The rain of the night before had left soft mud in some spots and drying mud in others, but in the bracing air the drawbacks of the roads were little thought of. Nevertheless, we did considerable skidding, and but for the omnipresent ruts should have done much more.

Camillus Hill, a steep descent followed by an equally steep ascent was slippery with mud on the macadam surface, but all save the first portion of the climb was taken on the second speed. In Elbridge the roads were badly gridironed and very muddy.

Beyond Syracuse the mixed pebbles and dirt of the previous day or two give place to a *quasi* macadam, which seems to be made up sometimes of large pebbles broken in a crusher and sometimes of crushed limestone. In either case the stone is far inferior to the crushed granite and other hard, sharp stones used further east: but the worst of it is that the macadam is finished off, when newly made, with a layer of dirt an inch or two in depth. The muddy rutted state into which all of the roads near Syracuse soon lapse seems to be largely due to this pernicious practice, of which we had a good example in a road, badly gridironed and in process of remaking, just out of Syracuse.

At Weedsport we left the main road, turning around three sides of a square and crossing the canal twice in quick succession. This gave us our start on a welcome detour north of the Montezuma Swamp. The detour led through Port Byron, Spring Lake, and South Butler, joining the main route before Savannah was reached. The road directions were somewhat vague, but the *confetti* trail was definite enough, and we had no trouble. Mr. Manross, who had preceded us, earned the thanks of some of the tourists by stopping his car at an abrupt and unlikely-looking left turn in the course, and guiding them to it.

The roads of this detour were at first very bad, being frightfully gridironed out of Weedsport, with sharp downward slopes on both sides; then they were better, and they ended by being positively respectable, narrow but macadamized and smooth of surface; better, in all likelihood, than nine-tenths of the main line roads. The country was decidedly attractive, for the road followed a small stream for some distance, and the soil, a black, fertile loam, was liberally cultivated. Further on we encountered some hills.

The farming population showed interest in the tourists, but for the most part made no demonstration. In South Butler, however, we were pelted with a rain of bouquets, which, propelled by the capable arms of many village lassies, struck us at the psychological moment before we struck sundry very high crosswalks, over which we

bounced at an uncommon rate before we could separate business and pleasure long enough to slow down the car.

We entered Clyde by the canal road, of detestable memory. It had lost none of its odious distinction, and we were glad to leave Lyons behind and ride over the better roads approaching Palmyra. Here we stopped for lunch, in company with Mr. Lesh's party, which had kept close to us much of the way.

Several tourists who had lunched at Lyons passed before we started again, and we caught sight of some of them soon after. One, Esselstyn, driving the Franklin, ran short of gasoline just before reaching Fairport, and we stopped to share our scanty supply with him, after which both cars replenished at Fairport.

From Fairport to Rochester the roads were perfect, and we made fast time. The general opinion is that the most arduous part of the tour, so far as roads are concerned, is over, and I fancy few of us regret the fact.

Rochester to Buffalo.

BUFFALO, July 30.—I relinquished my seat in the *Great Arrow* at Rochester, and rode to Buffalo by train. Percy Pierce started from Rochester about 5 o'clock, and reported at Buffalo that he had made the sixty-odd miles between the city lines in just two hours. As the roads are throughout in splendid shape, I had no difficulty in believing it, even with all proper slow-downs and stops for traffic counted in.

A round-up of the tourists at Buffalo shows twenty-three arrivals, and no withdrawals enforced by accidents—a record in memorable contrast to that of the endurance run three years before. There have been, of course, minor accidents, chargeable in nearly all cases to the shocking state of the roads. The Cadillac which chased us so madly two days before has demonstrated what, for that sort of usage, at least, was the weakest part, by breaking a steering knuckle between Utica and Syracuse. No injuries to the occupants had resulted, for the reckless Wetmore had gone home from Utica; and a new knuckle was put in and the car hurried on. Several cars reported broken springs, which, of course, were early replaced. Mr. Scott's big car is undergoing minor repairs at the Pierce factory. Mr. Whipple's car broke a shaft yesterday, but the damaged member will be replaced in time to start to-morrow.

At a smoker tendered to the tourists yesterday night by the Buffalo Automobile Club, I asked Judge W. H. Hotchkiss, who was largely instrumental in drafting the present New York State automobile law, what he thought of the prospects for new legislation of the sort next winter. He replied that he thought there would be no occasion for a change.

"The present law will stay on the statute books till there is no law," he said, "or until the reckless driver of an automobile is

treated exactly like the reckless driver of a horse. The time will come in the country, as it already has in the cities, when horses will pay no attention to these machines; and when that time comes all drivers can be treated alike. Meanwhile we have won the confidence of the country districts by being decent and giving them an effectual law—one that can be enforced. There is no sentiment in this part of the State demanding a stricter law."

To my remark, that all parts of the State were no so fortunate, and that a good deal of trouble was caused about New York city by the sporting owners of fast machines, Judge Hotchkiss replied with emphasis that the thing for decent motorists to do was to combine in enforcing the law against their reckless neighbors. "The jail penalty is going to be the only thing that will stop this scorching," he said, "and there is no reason why it cannot be enforced. I have sometimes thought that we could get at a good part of the trouble by forbidding any one to drive a machine who is not a citizen of the United States. That would shut out these French chauffeurs; but it would be class legislation, I suppose. We in Buffalo have no such problem to face. There are, of course, plenty of machines that will go forty miles an hour, but they are in the hands of gentlemen, mostly, who don't want to drive fast. We haven't a French chauffeur in the city, and I hope New York will never let them come here."

To-day a number of the tourists, escorted by members of the Buffalo Automobile Club, enjoyed a run to Niagara Falls.

The good condition of nearly all of the cars, and the freedom from the restrictions of an endurance run, have without question done much to convince the public that a tour of this sort can really be a pleasurable experience instead of a task, and in that way at least the "cause" has greatly benefited.

Buffalo to Erie.

ERIE, July 31.—For twenty-five miles west of Buffalo the tourist enjoys fine macadam roads, which for some miles lie close to the edge of Lake Erie. The rest of the trip into Fredonia is over dirt roads with no stone foundation. When dry they are in very good condition: to-day they were only fair. The country about Fredonia is a great grape-growing region, miles of farm land devoted to little else being passed. The proximity of the lake averts early frosts, and the soil, a gravelly loam, seems especially adapted to this crop. When it is considered that the beneficent influence of the lake breezes extends not more than five or six miles inland, it is hard to realize how extensive the grape-raising industry of this region is. Other fruits are raised also, and Fredonia, the nominal noon stop, is known as a town of beautiful trees. Only a few cars stopped there, most of the tourists making early starts and pushing directly through to Erie. To this rule Mr. Scott was an exception, as he pulled into Fredonia about 8

p.m., and an hour and a half later, at the Reed House in Erie, Mr. Whipple was joyously announcing his intention of repaying Mr. Scott's favor in towing him into Buffalo on Saturday by going out to meet him and towing him (Scott) into Erie. What the issue will be is not at this writing known.

HERBERT L. TOWLE.

PLACE HOPE IN MAYOR.

St. Louisans Believe His Purchase of a Car Will Remedy Local Evils.

Special Correspondence.

ST. LOUIS, Aug. 1.—Mayor Wells has bought a high-powered Peerless and local motorists think that this augurs much for the sport in St. Louis. It is hoped that the Mayor will take a hand to prevent unjust discriminations and unfair legislation. The streets of St. Louis are in a deplorable condition with the exception of Lindell, Delmar and West Pine boulevards. These streets are new and the contractors and the gas company have not had a chance to leave their usual marks. Many of the streets have recently been paved, but the gas companies are permitted to tear them up and not replace them properly. When a building is in course of erection gas and water connections have to be made from the street and a dozen thoroughfares show hundreds of places where the pavement has been torn up, leaving depressions which are getting worse. When Mayor Wells tries a few of these streets it is thought he will see the justice of the complaints by taxpayers, particularly by the members of the St. Louis Automobile Club.

This club is also trying to interest the Mayor in the matter of speed restriction. At present it is six miles an hour in the parks, and all the police have positive orders to arrest all automobilists going over that limit. Other vehicles are allowed to go eight miles an hour, yet wholesale arrests do not occur except in the case of the automobile. Members of the club are working for the limit set by Paris, New York, London and other large cities—ten miles an hour in crowded streets and twenty miles an hour in the country. The members, meantime, are adhering strictly to the present law and have gained the confidence and respect of the Mayor and the public. As a result, prejudice against motor cars is gradually beginning to die out here.

Mr. and Mrs. Chouteau Scott, of St. Louis, will accompany the visiting tourists from Chicago to St. Louis. Both are expert motorists and on the way to Chicago they took turn about in driving their 25-horsepower car. They hold the record for fast auto-driving between these two cities, having made the distance in twenty and one-half hours. Before her marriage Mrs. Scott was Miss Irene Keller, one of the most accomplished horsewomen of St. Louis. She has studied automobiles and is remarkably familiar with their mechanism.

Hints to Touring Car Purchasers—IV.*

Practical Instructions for Driving by Day and Night on Rough, Soft and Slippery Roads.

By JOSEPH TRACY.

NOW everything is presumably ready for the start, and, as this is the owner's initial trip, it is advisable to take along a friend, who may be of assistance in case of breakage or mishap. It is well to bear in mind that, as a general rule, the slower the motor can be run the better. This means that the high gears should be used when possible, and the motor throttled to give the required car speed. The motor, however, should not be run so slowly as to cause knocking in the transmission system, due to the lost motion being taken up suddenly at each explosion. This lost motion or "backlash" either in the gears or connections is caused by the car tending to run faster than the motor. Slow motor speeds save the bearings, prevent overheating, and decrease the consumption of gasoline, oil, and water.

When fairly started attention should be given to the lubrication, to see that the oil feeds properly. Care should be exercised in adjusting the different oil drips, so that each feeds the number of drops per minute as recommended by the car builder. In a new car it is better to use too much cylinder oil than not enough.

RULES OF THE ROAD.

In driving on the road it is a good plan to keep well to the right, and to blow the horn when about to overtake vehicles or animals. Always pass on the left when overtaking, except where the road is very wide, such as the entrance to a park, and always allow as much room as possible, especially when passing horses. When meeting horses also give plenty of room, and do not sound the horn. If the horse is restive it is best to go by at a fairly rapid pace, making as little noise as possible. It is generally better to do this than to stop the car and allow the horse to be led by. Should the horse appear to be getting beyond control of the driver as you approach, open the switch and bring the motor and car to a standstill. A considerate motorist will even jump off his car, especially if the vehicle met is driven by a woman, and will lead the frightened horse past his car.

In some States rules of the road are embodied in the automobile laws and the driver should be careful to familiarize himself with these, and to be guided accordingly.

When overtaking another car, it is not wise to pass if the car in front is not well toward the right, because the road may be obscured by dust, and possibly an automobile or other vehicle coming in the opposite direction just at the instant may cause a collision. Be especially careful to

avoid driving close behind electric street cars. They are sometimes stopped without warning. As they can be brought to a standstill abruptly and as they weigh considerably more than an automobile, the latter is likely to come off second best in an end-on collision.

When driving behind trolleys do not allow the wheels to run in the tracks if the latter are wet, as it is then difficult to get the wheels out of them. Collisions have occurred to automobiles which had been following trolley cars at a considerable distance on wet tracks. Under such conditions should the trolley car stop rather short, and the automobilist apply his brakes to avoid a collision, the brakes would lock the driving wheels and the machine slide into the end of the trolley car.

In an emergency of this sort if the driver tries to turn out of the tracks he will usually find this impossible, and there is nothing left to do but to strike the trolley car. The co-efficient of friction between rubber and a wet smooth rail is comparatively small.

GENERAL ROAD INSTRUCTIONS.

When running on the road, and approaching a turn it is a good plan to slow down, sound the horn and hug the right hand side. Should one swing wide and not slow down, and should a car happen to be coming in the opposite direction a crash would inevitably ensue.

When a car is being driven along an undulating road, in sections where speed laws do not apply, and it is desired to make fast time, advantage should be taken of grades to utilize the momentum acquired on a downgrade to help the car on the next upgrade. On meeting a grade that cannot be "rushed" it is a safe plan to put in the low gear at the foot of the hill and open wide the throttle. If, on the contrary, the car is driven part way up, say on second, and if the motor is unable to pull it on that gear, it will be necessary to change back to the low. Sometimes, however, the low may be missed at the first attempt, and when finally engaged the car may not only have come to a standstill but be rolling backwards, demanding a terrific pull from the motor to get it moving up the hill again. Again, if the low gear is missed, it may be impossible to engage it after the car has started backward, as in this case the teeth of the gears which are to be meshed may be moving in opposite directions. Should this happen, and should the brakes not act well, the car will run away backwards.

The best thing to do in this case is, first, keep cool and then open the ignition switch (stopping the motor), and put the reverse

gear in and allow the clutch to engage. It is obvious that if the brakes and clutch are interconnected, the latter will not engage unless the brakes are off. It requires considerable presence of mind to take the brakes off when running backwards down hill. The car will now have to pull the motor around, which will prevent the former from running wild. If the car continue to run backwards so fast that it is impossible to keep it straight, the next thing to do is to run it into the roadside. In case there is a bank or fence at the side not much damage will be done. If, however, the sides of the road are steep, the only thing to do when the car cannot be guided is to jump.

It may happen that in climbing a stiff grade the gasoline from the tank will not flow to the nozzle in the carbureter. This is more likely to happen when the tank is nearly empty. In this case, obviously, the thing to do is to come up backwards. In machines fitted with a pressure fuel feed system this is not likely to be a source of trouble.

COASTING DOWN A HILL.

When running down a steep long hill, particularly if the route is unfamiliar, it is a good plan to put the low gear in before starting down, and then stop the motor—usually by opening the ignition switch. The hand brake can now be put on sufficiently to disengage the clutch. In a few cars the hand brakes are not connected up with the clutch, and therefore in such cars the clutch would have to be held open by pressure on the foot pedal. In case the brakes fail to hold, the motor may be used as an emergency brake, by allowing the clutch to engage. This will prevent the car from attaining an excessive rate of speed, inasmuch as the movement of the car will rotate the motor against compression. Although the motor will usually be unable to stop the car under those conditions, it will prevent it attaining a dangerous speed.

In some cars in which the ordinary cone clutch is replaced by a clutch of special design, as in the Mercedes, for example, the clutch will not hold securely when the speed of the clutch shaft exceeds that of the motor shaft. Entire dependence must be placed on the brakes in such cars for a safe descent.

When coasting with the clutch out, and when the bottom of the hill is reached, the switch can be closed, the ignition having been previously retarded, and the motor started. If it refuses to start with the spark the clutch may be dropped in for an instant, just long enough to rotate the motor once or twice.

When going up grade it is bad practice to change from a low to a high gear, unless the grade is a very easy one.

DRIVING OVER ROUGH ROADS.

When traveling over rough roads, the driver should sit in such a position that the

* Continued from page 85, issue of July 23.

feet will not be shaken off the pedals. Otherwise, when the clutch is disengaged, as it should always be for a rough spot, and the car allowed to "coast," the feet may be jarred off the pedals, allowing the clutch to slam in, and causing great strain on gears and transmission.

When about to pass over tracks, or holes in the road, the car should have sufficient momentum to carry it over such rough places so as to allow the clutch to be disengaged. This prevents racking the mechanism.

The low gear should invariably be used when starting the car, as this saves both clutch face and transmission. Cars having powerful motors may be started on the third gear, but this does not do the car any good and may do it a great deal of harm.

The practice of throwing in the reverse, and then dropping the clutch in while the car is moving ahead, is one which should never be attempted, as it imposes a heavy strain on the mechanism. The car should always be brought to a standstill by means of the brakes, and not by the motor through the medium of the reverse gears.

Another practice which should be avoided as much as possible, and which is responsible for many broken gears, chains, and twisted shafts, is racing the motor before the car is started, and then dropping the clutch in. Only when the car gets into a hole or into soft mud, or deep sand, should this be resorted to.

DRIVING OVER SOFT GROUND.

When a muddy road is encountered the best way to get through is to put in the low gear before running into the mud. If the car seems unable to get through, the accelerator should be pressed down and the ignition control handle moved to the proper position to cause the motor to exert its full power. If the bad spot does not extend for any great distance, it may be "rushed" through in second speed. This should not be attempted, however, if the road is bad for a greater distance than, say, one hundred feet, because if the car is run through the mud some distance on second speed and the motor is unequal to the task and slows down a change back into the low gear will be necessary. Unless this change can be effected very quickly, the car will probably come to a standstill, calling for a much greater effort from the motor to restart the car. In fact the load may be too great and result in stalling the motor. Then before the motor can be started again, the car may settle and the chances are that it will not be possible to get it out under its own power.

When running through a soft place, it is much easier to go through in a straight line than in a winding course, and for this reason no attempt should be made to turn the front wheels to the right or left, even if by doing so one may avoid a pool of water, or a spot which seems very soft. Should the car get stuck in a soft spot, it

should be jacked up, one wheel at a time, and boards put underneath the wheels. If boards cannot be found, use the floor boards of the machine, one of which should be put underneath the jack to prevent it sinking. The lifting will probably have to be done in stages; that is, when the car has been raised, as much as the jack travels, the car will have to be blocked up and the jack removed. The jack can then be screwed back to the beginning of its travel, blocked up and lifting recommenced and continued till the wheels are slightly above the surface of the ground, when the boards can be pushed under them. Bear in mind that the jack has to be placed under the axles or springs, and not under the frame. If planks can be procured they will, of course, be more serviceable than short boards.

The foregoing remarks apply to sandy roads as well as to muddy or soft roads.

HINTS ABOUT SKIDDING.

As serious accidents often occur when a car "skids" it will pay to be careful when running on wet pavements, particularly asphalt. "Skidding" is more likely to occur when the surface of the road is about half-wet, as it is then in the condition known as "greasy." It will be generally found that a car skids less when the side or emergency brakes are used than when the foot brakes are used. The latter usually act through the differential gear, and the former directly on the rear wheels. A car on which the brakes on the rear wheels are adjusted precisely alike so that they both grip equally, will skid much less, other things being equal, than one on which the brakes are adjusted unequally.

Suppose a car is going down hill on a wet asphalt street, and it is necessary to stop quickly to avoid a wagon or for some other purpose of safety. If the brakes are applied smartly, the rear end of the car will skid around. Putting on the brakes tight enough to prevent skidding, and allowing the car to come to a standstill, is about the only course to pursue. When it is plain that the car cannot be stopped in time to prevent a collision it is better to go into the obstruction head-on rather than broadside. This would happen if the brakes were applied suddenly and forcibly, as the car would skid instantly.

When a car skids remember that putting on the brakes "hard" will make matters worse. About the only thing which can be done is to take out the clutch, keep the brakes gently on and guide the front of the machine in the same direction as the back end tends to go.

When driving a car fast on a slippery street, the best part of the street to drive on is close to the curb. Then if one wants to stop suddenly the front wheels should be turned slightly away from the curb and the brakes applied. The back wheels will then slide against the curb and cannot, of course, skid any further.

NIGHT RUNNING AND LAMPS.

A few words on night running and lamp management are now in order. Do not attempt to make fast runs at night unless thoroughly familiar with the road, and unless the car is equipped with powerful acetylene lamps. The light from these lamps has the effect of magnifying inequalities in the road surface. It makes holes look deeper, and ridges appear higher. This effect is not very objectionable at first, as it tends to make a driver careful. When he gets accustomed to this effect, however, he is likely to become careless, and assume that all inequalities are apparent rather than real.

When about to pass a light in the middle of the road proceed cautiously, as the obstruction may be either on the right or left side. If the front end of the car is swung a little from one side to the other the light from the gas lamps will follow the car movement and show which side is clear. When the car has a swinging "searchlight" this can be used for the same purpose.

Always carry a good red lamp on the back of the machine, on the left side facing in the direction of forward motion. This red light may prevent another driver from running a car into yours from behind. When stopping at night for repairs, or other causes, move the car as much as possible to the right side of the road, and see that the rear lamp shows clear and bright.

TURN OFF THE GASOLINE.

In making repairs at night, if underneath the car or in the vicinity of the gasoline tank, first turn off the gasoline at the tank. Use the gas lamps to work with. Lay them in such a position that the light from the gas lamps will shine on the place you are working on. For this purpose the lamps may be at some distance from the car, and held in position by small stones or pieces of wood.

Gas lamps are sometimes not hung properly on the brackets. The brackets may be inclined forward from the vertical, causing the light to strike the road close to the car, and showing very little light ahead, or they may be inclined backward, causing the light to shine upwards, and leaving the road close to the car in comparative darkness. The remedy in both cases is obvious.

HOW TO TEST LAMPS.

An easy way to test lamps for proper light direction is to take out the car on a dusty road at night and with the lamps alight. Now, another car should be driven by fairly fast to stir up the dust. If an observer is stationed about a hundred feet in front and to one side of the road, he can see very plainly through the dust in just what direction the light is projected.

Lamps should be secured on their brackets by split pins or nuts, and the lugs on each lamp body should be a snug fit on the bracket, or the lamp will rattle.

It is best when leaving the car for the

night to turn off the gas rather than to let it burn out. When left to burn out, the pressure is gradually reduced, as the carbide ceases to give off acetylene gas, with the result that the flame smokes and deposits carbon in the burner passages.

CLEANING THE GAS LAMPS.

Sometimes in cleaning or repairing a lamp the burner is moved out of its proper position so that the light does not focus, and is streaky. When this occurs the lamp should be sent to the manufacturers for readjustment.

When the burner tips get stopped up they usually can be cleaned with a fine steel wire. If the back tip is stopped the front one will throw its flame on the reflector and spoil it by melting, burning away, or cracking the reflecting surface. It is better to run slowly with one lamp than to risk spoiling a reflector.

If acetylene lamps are expected to give satisfactory service, the gas generators should be thoroughly cleaned every time they are filled. A good way to do this is to use a hose and water under pressure, compressing the end of the hose so as to make the water stream out forcibly. See that all the residue is thoroughly removed from the generator before refilling.

NO SOLDERED JOINTS.

When having repairs made to lamps see that joints are riveted and not soldered, as a soldered joint will not stand the heat and vibration. It is always well to have some extra burner tips, as these sometimes get stopped without any warning and cannot be cleared. When replacing a tip, use a small gas pliers and handle it carefully. Tips are very easily cracked when made of lava.

When screwing down a burner make sure the pliers grip the metal base and not the lava tip. Use a little white lead on the joint, and see that when it is screwed in it stands in such a relation to the lamp body as to bring the flame in correct position, viz., parallel to the front glass.

When leaving the car at night, or for any length of time, make it a practice to shut off the gasoline. If this is not done, and if there is a fuel leak, or a flooded carbureter, a fire may be caused by some one carelessly tossing a burning match under the car.

IN CONCLUSION.

Attention to the instructions given in this and the preceding articles will, it is hoped, help the novice to a better understanding of the requirements for the successful operation of a car. There are many points not touched on which will manifest themselves as experience is gained in the use of the car, but reasoning from this experience will usually enable the owner-driver to work out a solution.

In conclusion, it is impossible to write general hints on automobile operation that will be applicable to each individual case.

In details of construction there are wide differences between cars of the same general type, both home and foreign. In all, however, the principles embodied in the construction are alike. Therefore, in cases where a conflict between the form of construction and the suggestions here given is apparent, the reader will be able to reconcile matters by taking the intent of the instructions rather than the letter for his guide.

An Official Auto Trip.

An automobile trip to the Newark watershed at Newfoundland, N. J., situated between Copperas and Kanouse Mountains, was made one Sunday last month by a party of officials from Newark, for the purpose of inspection and for a pleasant trip. The party included Mayor Henry M. Doremus, Police Commissioner Fredrick Castle, Engineer Morris R. Sherrerd, of the



NEWARK INSPECTION TRIP—THE START.

Water Department, in one car; Collector of Customs George L. Smith, Excise Commissioner Dickson and Thomas L. Cressey, in another; William T. Hunt, Winton C. Garrison, Chief of the Labor Statistics, and County Supervisor David R. Johnson, in the third, and Dr. James T. Wrightson, Isaac R. Denman, and James P. Logan in the fourth machine.

It was an ideal day, so far as weather and road conditions were concerned. The start was made from the North End Club, in Newark, and all enjoyed the fresh air, the fine roads and the beautiful scenery as the cars spun along through Montclair and over the Pompton Turnpike. But while running through Little Falls a sharp report caused some excitement and investigation showed that a tire on the car occupied by Messrs. Smith, Dickson and Cressey had blown out. Those officials who were unaccustomed to automobile riding spun along through Montclair, over the Pompton Turnpike, through Little Falls and Butler. No more serious mishaps occurred than the blowing out of two tires, which delayed half of the party until after 3 o'clock for their dinner, which



AN AFTERNOON STOP FOR DINNER.

was eaten at Stockholm. Before reaching Stockholm, however, the car containing Messrs. Wrightson, Logan and Denman was stopped by a constable, who wanted to know why they did not have a license number on the vehicle. After a brief parley, during which Dr. Wrightson gave the constable his card and assured him that the machine was properly registered under the law, but it had such a strong exhaust that it must have blown the tag off, the guardian of the statutes graciously permitted them to proceed.

After appetites had been appeased, the officials examined the Clinton Reservoir and then the trip home was begun. Although the road was rough and steep in places, the only approach to an accident on the homeward journey was the puncturing of two tires on one machine at the same time. Repairs were quickly made, however.

The last of the cars got back at 10 o'clock, and all the occupants expressed their enjoyment of the day's run.



MAKING ADJUSTMENTS ON A GRADE.

Service Test for Motor Wagons.

Details of Performances of Vehicles that Participated in the A. C. A. Contest in New York Last April.

In the accompanying table are summarized the performances of the vehicles that competed in the Automobile Club of America's "Service Test for Motor Wagons" last April, and the awards made by the contest committee, as published in the report of the contest issued by the club last week. This table includes all the information contained in the report except the details of construction of the several vehicles, the causes of the penalized stops made and repairs effected, and the general behavior, which are too extended to be tabulated. The table, however, presents the essentials in convenient form for easy comparison of the individual performances.

The contest committee under whose direction the report was prepared was composed of Messrs. John A. Hill, Emerson Brooks, Roland R. Conklin and S. M. Butler, secretary of the club. In the report to the board of governors of the club, the contest committee expresses appreciation of the cooperation of General Superintendent George W. Slingerland of the American and Westcott Express Companies, in whose service the wagons were placed and operated daily over the regular routes, collecting, transferring and delivering merchandise, prod-

uce, baggage and other express matter during the week of April 4 to 9, inclusive, 1904. Acknowledgment is also made of the courtesy of the H. Clausen & Son Brewing Company, in whose service the Herschmann and Fischer trucks were placed, transporting loads of beer to Yonkers and Flushing alternately.

"It must be borne in mind," says the committee's report, "that in a practical test like the present, in the daily service of a large express company, the loads available for the wagons were constantly varying ones, and the conditions failed to afford the factors necessary for the finer calculations of the cost per ton or hundredweight a mile, which would have been obtainable in a purely theoretical test where a constant load is carried over an accurately measured distance. The practical conclusions to be drawn from the test, however, in the opinion of your committee, more than compensated for this deficiency."

The report contains, in addition to the records of the performances of the wagons, engravings from photographs of the different wagons with descriptions of them, and is illustrated by more than a score of pic-

tures taken during the test and loaned by the several automobile journals.

It is rather to be regretted that there are not incorporated in the report some data of the performance of horse-drawn wagons in the same service over the same routes, for comparison with the motor vehicle service, from which valuable conclusions might be drawn.

SELDEN PATENT MACHINES.

The National Association of Automobile Manufacturers is getting out a "Hand Book of Gasoline Automobiles," which, it is anticipated, will be of much usefulness to all whose business or pleasure brings them in contact with automobiles. The book will contain illustrations and specifications of 88 gasoline automobiles, and an important point is that the information will be given in the form of questions and answers, the same questions being applied to every car in the same order, so that comparisons may be readily made. The information consists of bare technical facts, without comment, making it easy to get at whatever is wanted without delay. The work, which will be ready for distribution about September 1, describes cars built under the Selden patent.

Owing to want of space in the book now under way, which precluded descriptions of a number of machines, another book will be put in hand at an early date to be ready for the Madison Square Garden automobile show, if possible.

OFFICIAL RECORD OF PERFORMANCES OF VEHICLES THAT PARTICIPATED IN THE 1904 TRIALS IN NEW YORK CITY.

Class 1.—To carry 1,000 pounds or under.

No.	Maker.	Motive power.	Hp.	Selling price.	Tare lbs.	Load lbs.	Distance traveled miles.	Running time.	Av. Run'g speed, m. per h.	Elapsed time.	Dist. Div. m.	Repairs.	Current.	Fuel, gals.	Passing Trips	Awards.
4	Knox Auto. Company.	Gasoline	8	\$1,500	2,065	700	188 3-8	27 36	6	55 29	271	23	2 24	3d prize, bronze medal.
7	Olds Motor Works.	Gasoline	4½	800	1,225	500	228 1-4	20 59	10.8	57 51	282	13	2 29	1st prize, gold medal.
8	Olds Motor Works.	Gasoline	4½	850	1,225	500	212 1-4	24 15	8.8	54 33	265	12 1-4	2 26	2d prize, silver medal.

Class 2A.—To carry 1,100 pounds.

1*	Commercial Motor Co.	Steam	1,200
5	Knox Auto. Company.	Gasoline	8	\$1,600	2,280	1,100	187 3-4	21 45	8.6	55 34	271	22 1-2	2 24	2d prize, silver medal.	
11	Pope Motor Car Co.	Electric.	3	1,400	2,465	1,100	168 3-4	22 28	7.5	56 55	268	40.8 kw.	2 21	3d prize, bronze medal.	
12	Pope Motor Car Co.	Electric.	3	1,400	2,455	1,100	184 7-8	25 20	7.2	54 28	260	47.9 kw.	2 19	1st prize, gold medal.	

Class 2B.—To carry 2,000 pounds.

2	Charles Rockliff.	Gasoline	15	\$2,500	4,092	2,000	204	28 35	7	60 35	114	4 43	43 1-4	4 14	3d prize, bronze med.
10†	Carlson Motor V. Co.	Gasoline	20	2,500	2,830	2,000	11 1-4	1 24	7.8	1 40	6	5	No rec.	3 1
13	Lansden Motor Car Co.	Electric.	2,000	2,760	2,000	180 1-2	26 45	6.7	59 43	102	2 13	192.6 kw.	3 13
14	Electric Veh. Co.	Electric.	5,400	2,000	2,500	192 1-8	23 22	8.2	54 54	176	18	136.6 kw.	3 15	2d prize, silver medal.
16	Cantono El. Tractor Co.	Electric.	4	3,300	2,000	1,700	145 1-8	23 42	6.1	53 41	187	89.3 kw.	3 19	1st prize, gold medal.

Class 3.—To carry 2,000 to 3,000 pounds.

6	Knox Auto. Company.	Gasoline	16	\$2,300	2,815	2,100	235 1-2	25 23	9.2	48 49	146	28 1-4	3 18	2d prize, silver medal.
9	Consolidated Motor Co.	Gasoline	7	2,000	3,450	2,500	239 1-2	25 39	9.3	52 17	150	10	35	3 16	1st prize, gold medal.

Class 4.—To carry 3,000 to 4,000 pounds.

3	Union Motor Truck Co.	Gasoline	20	\$3,500	6,850	4,000	172 7-8	29 30	5.8	60 37	109	7 11	58	4 13	1st prize, gold medal.
---	-----------------------	----------	----	---------	-------	-------	---------	-------	-----	-------	-----	------	-------	----	------	------------------------

Class 5.—To carry 4,000 to 5,000 pounds.

15‡	Electric Veh. Co.	Electric.	\$3,300	6,700	5,000	150 1-4	24 27	6.1	53 57	127	30	147.6 kw.	4 13	1st prize, gold medal.
-----	-------------------	-----------	-------	---------	-------	-------	---------	-------	-----	-------	-----	----	-----------	-------	------	------------------------

Class 8.—To carry 8,000 to 10,000 pounds.

17	Fischer Motor Veh. Co.	Gasoline.
18§	Columbia Eng. Works.	Electric.	20	\$5,000	14,050	10,000	187 1-2	33 44	5.5	56 25	76	1 44	124 3-4	4 6	1st prize, gold medal.	
		Steam	25	4,500	14,100	10,000	34	4 02	6.6	9 58	1	700 lbs coal	3	

* Did not start.
 † Withdrew after first day. Engine was new and ran hot.
 ‡ Towed 11½ miles on first day owing to exhaustion of battery.
 § Withdrew at end of first day. Steamed very badly and glands of engine leaked.

Records Broken in Ostend Week.

seconds off of the record made last year by Willy Poege in a 60-horsepower Mercedes. Baras, in a Darracq, was only four seconds

AUTOMOBILE week at Ostend, Belgium, began Thursday, July 14, with a five-kilometer contest for touring cars classified by list prices of chassis. There were many competitors, among whom the most notable was Baron de Caters in his 90-horsepower Gordon-Bennett Mercedes. The events were run on the Nieuport-Snaeskerke road, which lies along the coast of the North Sea, connecting Ostend, the Belgian watering resort, with the French frontier with one of the first modern good roads built in Belgium. The road passes through a low-lying country of sandhills intersected with canals. The section of the new road selected for the contests was wide and level, with only two bends, one near the start and the other about five kilometers distant. In the speed trials for racing cars on the subsequent days the second turn necessitated slowing down to avoid accidents.

Strong breezes that on the first day re-



SERPOLLET STEAMER WITH VIS-A-VIS BODY ENTERED IN TOURING CLASS.

by Rigolly, in his big Gobron-Brillié, who covered the course in 4:39, or at an average speed of eighty miles an hour, cutting 34 3-8

slower in the same class. After the results were posted Baras entered a protest, claiming that Rigolly's Gobron-Brillié was overweight for the 1,000-kilogram class. As all the cars were machines that had competed in the French eliminating trials for the Gordon-Bennett, they had not been reweighed. Owing to Baras's claim that the Gobron-Brillié was now overweight, the cars were weighed on Saturday, July 16. In the light car class (480 to 700 kilograms) Hanriot, on a Clement-Bayard, covered the ten kilometers in 4:52 4-5, only 13 4-5 seconds slower than the best time of the day.

The following Monday, July 18, there was a clean sweep of the record slate for the mile with standing start, and cars were timed over a section of the course 609 meters (2,060 feet) long. Rigolly and Baras, in the Gobron-Brillié and Darracq, respectively, were both timed over the 609 meters at 13 3-5 seconds. Baras was timed for a standing-start kilometer in 35 seconds, as against Rigolly's 36 3-5 seconds. Baras



HANRIOT IN CLEMENT-BAYARD AT FULL SPEED IN THE RACING CLASS.

tarded the tourists, blowing directly in their faces and causing some inconvenience on account of dust, on Friday and Monday materially aided the contestants in putting up a fresh slate of straightaway records.

De Caters naturally made the best time on Thursday in the tourist section with his 90-horsepower Mercedes, his time for the five kilometers (3 1-10 miles) being 2:52 3-5. New records were made in the classes as follows: For chassis costing less than 10,000 francs (\$2,000), Elskamp, 20-horsepower Gobron-Brillié, 4:32 2-5; costing less than 15,000 francs (\$3,000), Kinet, 24-horsepower Rochet-Schneider, 3:47 2-5; less than 20,000 francs (\$4,000), Delville Gardner-Serpollet, 4:17.

Nearly all of the records of 1903 were broken on the second day, July 15, when the racing cars were sent over a ten-kilometer (6.2 miles) course, with a strong wind blowing at the back of the competitors. The Crown Prince of Belgium and the Minister of the Interior were pleased witnesses of the day's sport. The best time was made

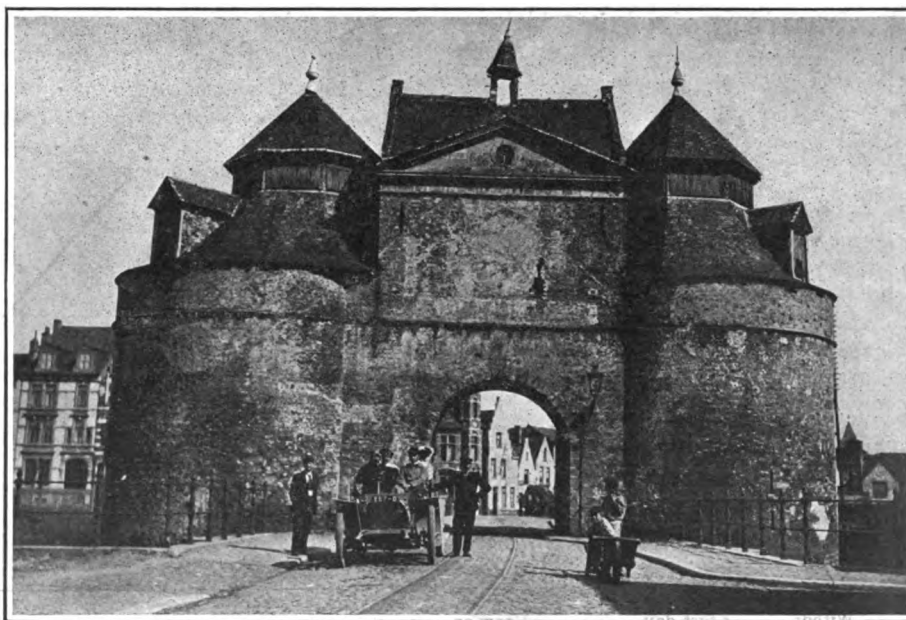

PICTURESQUE OLD TOWN GATE AT BRUSSELS ON THE ROAD TO OSTEND.

made the best time for the mile—:48 3-5—creating a new record, while Rigolly's time in the same class was :50 1-5. Other world's records for the standing mile were: Light cars, Hanriot (Clement-Bayard) :56; Voiturettes, Edmond (Darracq), 1:01 4-5; motorcycles, Rigal (Buchet), 1:16 1-5; motor bicycles, Olieslagers (Minerva), :59 2-5.

Reports of the events on the subsequent days, on one of which Rigolly made the new flying kilometer record of 21 3-5 seconds, have not yet come to hand.

The flying kilometer trials were held Wednesday, July 20. The most eagerly awaited efforts were those of Baras and Rigolly, who had been pretty evenly matched at the highest speeds in the previous contests. Besides these two, there was only LeBlon in a Hotchkiss in the heavy car class. Marvelous speed was attained by all, Rigolly covering the 62-100 of a mile in 21 3-5 seconds, which figures out at a speed of more than 103 miles an hour. Baras, in the

Circuit des Ardennes Won by Heath on a Panhard.

The race for heavy cars over the Belgian Circuit des Ardennes, second only to the Gordon Bennett in importance as an automobile race, was finished Monday, July 25, two Panhard cars taking first and second places, the winner, Heath, averaging 57 1-2 miles an hour over the course of 600 kilometers (375 miles). Teste drove the Panhard that took second place. The time of the winner was 6 hours 30 minutes, the second car finishing only one minute later. Glement (Bayard) was third, Rigolly (Gobron-Brillié) fourth, and Le Blon (Hotchkiss) fifth. The Georges Richard-Brasier was not represented, nor was the Mercedes.

Severe conditions governed the contest. There were no compulsory stops or controls; only those riding in the cars were allowed to fill tanks or do any other work

power. This is the third time a Panhard has captured the Circuit des Ardennes. The course is a seventy-five-mile circuit through Herbamont, Ourthenville, Ramoat, Champlon, St. Hubert, Serpont, Recogne, Verlainem, Neufchateaum, Leglisem, Habay-la-Neuve and Martelange back to Bastogne.

1,600 MILES WITHOUT STOP.

La Roche Reaches St. Louis Monday in 158 Hours 28 Minutes.

Special Correspondence.

ST. LOUIS, Aug. 1.—F. A. LaRoche and his party arrived here thirteen minutes after midnight Sunday—to be exact, at 12:13 a.m. this morning. They had covered a distance of 1,600 miles in 158 hours 28 minutes without stopping the motor. The distance as given in the A. A. A. tour book is 1,318 miles, but the motorists said that the route they traversed was almost 300 miles longer. They say that the motor did not cease to throb from the time they left New York a week ago lacking nine hours, and it was not permitted to stop running even in St. Louis, as it is intended to make a non-stop round trip of 3,000 miles. The party, which includes, besides Mr. LaRoche, Alexis LeBlanc, Herbert H. Everett, Norris H. Mason and Lee Straus, plan to leave for New York to-morrow (Tuesday).

They followed the route of the A. A. A. run to St. Louis, going through Albany, Utica, Syracuse, Rochester, Buffalo, Erie, Cleveland, Toledo, South Bend, Chicago, Pontiac and Springfield. On the way they had some bad weather and many miles of excessively bad roads. In one place in Ohio it took them five hours to go two miles. The run was not made with an attempt to speed, but was rather an endurance test of the car and engine, which stood it well.

Mr. LaRoche, who is president of the American Darracq Company, of New York, which has one of the principal displays in the foreign section of the automobile exhibition in the Transportation Building, visited the booth to-day and was enthusiastic over the appearance of the display.

Yesterday afternoon a funny incident was witnessed on West Main street; that is, it was funny to the chauffeur and spectators, but not the granger in front of the machine. The granger stood in front of the Jackson & Battle Creek interurban waiting room just as the auto dashed up. He turned and saw the machine coming for him, and commenced to dodge, jumping back and forth in front of the motor. The chauffeur applied the brake, but the auto didn't stop, and the granger sprinted up the street, evidently thinking his sole safety lay in flight, the auto in full pursuit. Completely out of breath he jumped for the curbing and the auto sailed up the street. The granger shook his fist and called out to the disappearing driver, "Say, you — old foöl, do you want the whole road?" Then the crowd laughed.—*Jackson (Mich.) Press.*

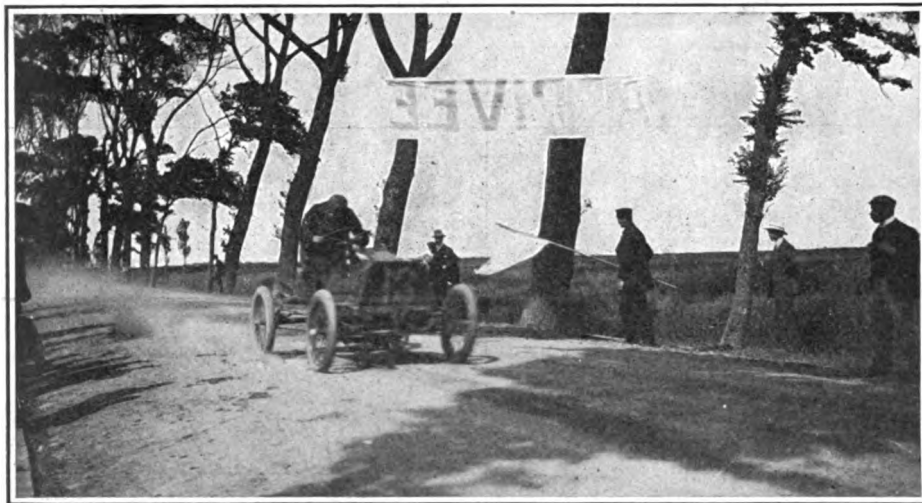

EDMOND GOING A MILE IN 1:01 4-5 AT OSTEND, JULY 18, IN A DARRACQ VOITURETTE.

Darracq, was only 2-5 of a second slower, and LeBlon's time was :25 1-5. In the light car class Hanriot (Bayard) did :26 4-5, and in the voiturette class the time of Edmond (Darracq) was caught at :30 2-5. Among the best times of the day was that of Seguy on a Griffon motor bicycle, :36 2-5. In the touring car section, De Caters and De Jochems, both in Mercedes cars in the class for chassis selling at more than \$6,000, covered the kilometer respectively in :30 and 35 seconds, while Dreye in a Serpollet steamer ran in :34 1-5.

The Police Department of St. Louis has purchased two high-speed gasoline automobiles to be used in overhauling violators of the automobile speed ordinance.

Steamboat inspectors turn from examining hulls to conduct of automobiles on ferryboats, ordering power shut off before embarking. Inspectors have not yet ordered the vehicles equipped with peek-a-boo fire hose and those fine, powdered cork combination life belts and anchors.—*New York Telegram.*

on their machines; cars could not be moved except by their own power; the use of mufflers was compulsory, discharging in such a way that the gases would not strike the ground; and contestants were enjoined to be particularly careful to leave half the road for an overtaking car, so there would be no difficulty in such cases. The roads, while good, are very tortuous and hilly, and the skill of the drivers was severely tested in making some of the turns.

The great race was run the second day of the meeting, racing having commenced Sunday with motorcycle and voiturette contests over a distance of 240 kilometres (150 miles). The weather on both days was perfect, and all the events were carried through without serious mishap. The weighing in took place on the Saturday previous to the races, and owing to the fact that many cars were over the limit of weight and had to be lightened and again weighed, it was a long time before this preliminary process was completed.

Heath, the winner, is said to be an American. The car he drove was of 100-horse-

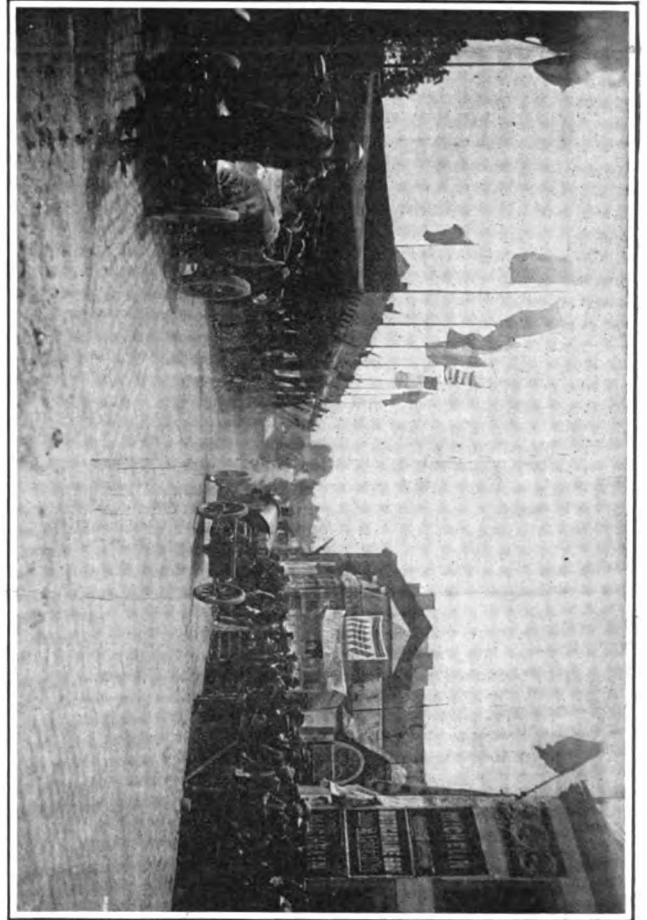

Rigolly Passing Grand Stand at Bastogne—Jenatry to Left with Broken Car.

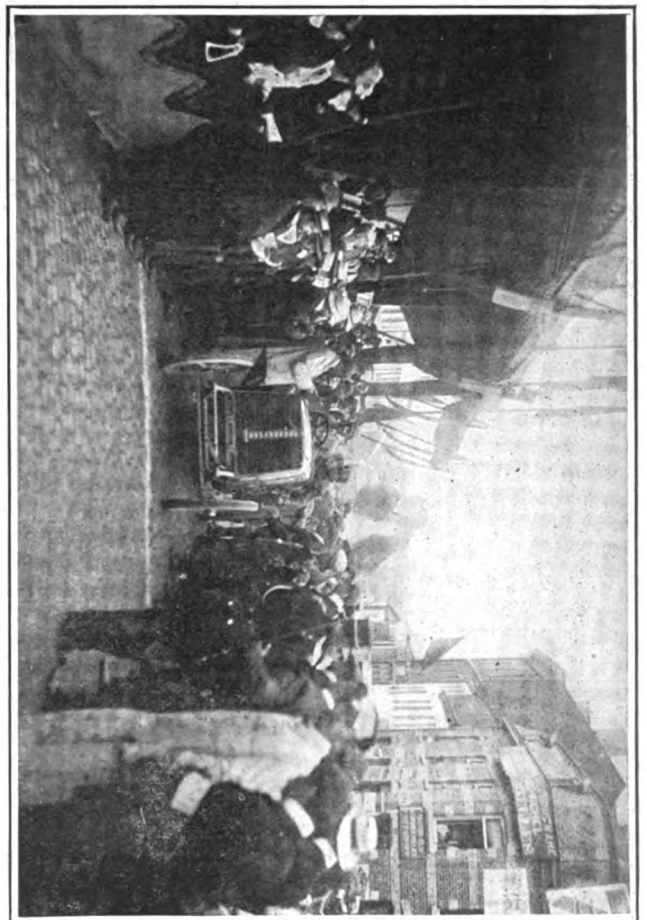

Starting the First Cars from Bastogne—Heath, the Winner, in a Panhard.

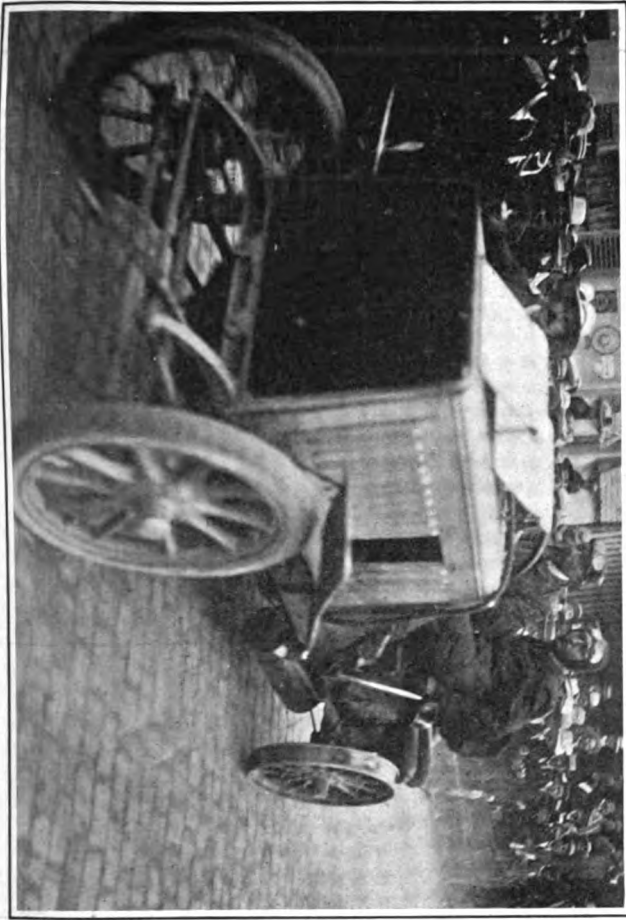

Teste, Winner of Second Place, Who Finished Minus Left Rear Tire. START AND FINISH OF THE CIRCUIT DES ARDENNES, AT BASTOGNE, BELGIUM, AND HEATH AND TESTE, WINNERS OF FIRST AND SECOND PLACES.

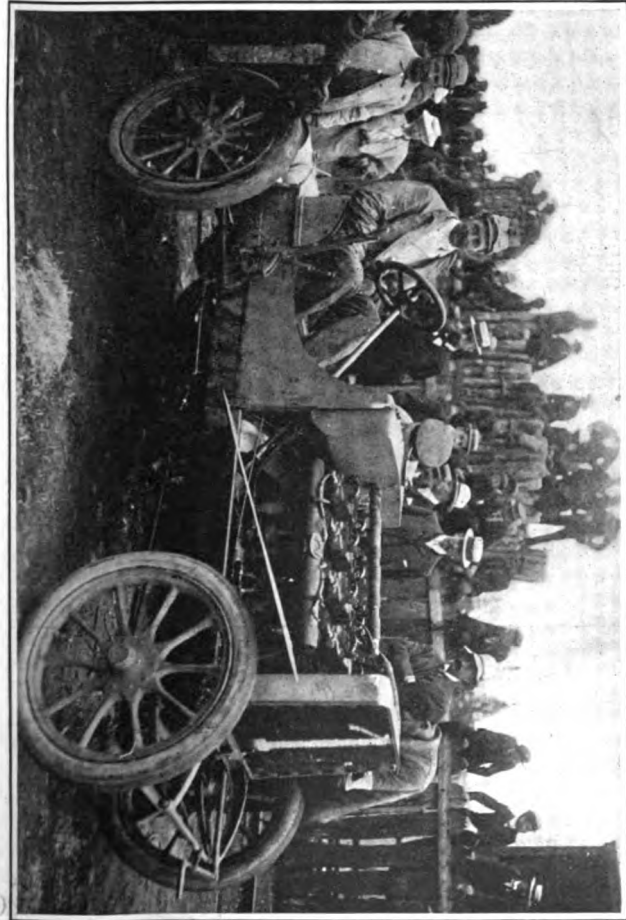

THE Winner, Heath, Who Averaged 37 1-2 Miles an Hour for the 375 miles.

Federal Definition of "Fire."

Scientists of U. S. Steamboat Inspection Service Apply its Meaning to Internal Combustion Engines and Compel Drivers to Stop Motors on Ferries.

AUTOMOBILISTS have been given another problem to solve—a problem that has failed to solve itself and that no one else cares to tackle. It is the question of the transportation of automobiles on ferry boats; certainly not a new puzzle. This time, however, it seems to have come up in dead earnest, and must be definitely settled one way or the other. Just now the whole matter is in a state of confusion. Some take it seriously, some disregard it entirely and the rest don't know what to think of it and are simply waiting.

Meanwhile in New York some of the ferry companies have refused to carry automobiles, an exercise of private judgment permitted by the Federal law. As a consequence of these restrictions and prohibitions many automobilists making runs out of the Borough of Manhattan into Long Island have taken to the bridges instead of making the East River crossing by ferry.

There is a Federal law which prohibits the carrying of explosives of any sort on passenger steam vessels. When automobiles began to come into vogue the fuel in their tanks came under the ban, and in order that motor vehicles might not be altogether excluded from the ferries, automobilists in 1901 secured the passage of an amendment, as follows:

TEXT OF FEDERAL LAW.

"An act for the amendment of section 4472 of the Revised Statutes of the United States, an act governing steam passenger vessels, provision prohibiting the carrying of explosives.

"Nothing in the foregoing or following sections of this act shall prohibit the transportation by steam vessels of gasoline or any of the products of petroleum when carried by motor vehicles (commonly known as automobiles) using the same as a source of motive power; provided, however, that all fires, if any, in such vehicles or automobiles, be extinguished before entering said vessel, and that the same be not relighted until after such vehicle shall have left the same.

"Provided, further, that any owner, master, agent or other person having charge of passenger steam vessels, shall have the right to refuse to transport automobile vehicles, the tanks of which contain gasoline, naphtha or other dangerous burning fluids."

SITUATION IN NEW YORK CITY.

Such is the text of the law. Since its passage, so far as New York City is concerned, automobiles have used the ferries as freely as any other class of vehicles, and it seems probable that this beatific state of affairs would have existed to-day had it not been for the burning of the excursion

steamer *General Slocum* and the resulting discovery of loose methods of inspection. An immediate and extraordinarily vigorous barricading of the barn door was commenced after the horse had made his escape. The inspectors suddenly discovered, to their utter amazement, that automobiles were running on and off the ferries under their own power every day in the week and twice on Sundays, and, scarce believing their own eyesight, reported at headquarters what they had seen. Ten ferries were reported, and in the twinkling of an eye each of the ten shut its gates to automobiles, other than electric, unless fires were extinguished or engines stopped before boarding the vessel. Meantime the other ferries were doing a brisk business in automobiles, both steam and gasoline.

INSPECTOR GENERAL UHLER'S VIEWS.

Supervising Inspector General Uhler, of Washington, D. C., of the United States Steamboat Inspection Service, was in this city early in the week and was asked for a statement of the case from his point of view.

"Here is our position in a nutshell," he said. "In the first place there was a law passed prohibiting the carrying of explosives of any sort on passenger steamers, and that law is a mighty strict one. A man couldn't even carry over a can of gasoline in his hand. But when automobiles came along it at once appeared that something would have to be done in order that they might not suffer inconvenience or hardship on account of a law which, though covering them to some extent, was framed before the automobile had taken its place on the road, and was therefore not considered. So this amendment," turning to the act already quoted, "was passed. The law was stretched a point or two for the benefit of those who used automobiles. They were allowed to take their machines on the ferries, and automobiles were transported the same as other vehicles; but the exception was not absolute, it was simply conditional. The conditions imposed were that all fires were to be put out before entering the vessel, and not again lighted until after leaving it. A gasoline motor won't run without a spark, and it won't run without explosions. Now, if sparks and explosions are not fire, I don't know what fire is. Here you have what is practically a carriage carrying a big tank of gasoline, and sparks and explosions going on right next to it.

"Then there are other points. The vibration of one of those machines when standing on a ferry boat with the motor in operation is tremendous, and it is possible that a gasoline tank might be broken, or shaken loose or a leak sprung. A gasoline tank

may leak anyway, and there is always the danger of the leakage becoming ignited and the flame communicating with the gasoline in the tank and blowing the whole thing to atoms."

NOT FAMILIAR WITH CONSTRUCTION.

Explanation was made to the supervising inspector concerning some details of construction and operation of the gasoline automobile, with which he has manifested no practical acquaintance, and, moreover, no desire for any. The impossibility of communication of fire between the cylinder and the gasoline tank was dwelt upon, as was also the fact that the explosions, taking place within the cylinder, are inside of double walls of cast iron; that the dreaded spark inhabits the same place; and that the more a man becomes acquainted with gasoline the more he learns of the difficulty of making it explode, even when he wants it to.

"I am not a practical automobile man," said the supervising inspector, "and maybe that's the reason I can't account for all the automobile explosions you read of in the newspapers. Launch builders come to me every day and tell me their boats are absolutely safe—simply can't make them blow up if you want to. And the automobile people say the same thing. But just the same the papers print report after report of launch and automobile explosions.

THE LAW IS THE LAW.

"But, as a matter of fact, all this has nothing whatever to do with the point in question. The law is there, and we are given no discretion in the matter—simply told to see that it is enforced. The law says that automobiles may carry gasoline on board of steamboats, but no fire. That's all there is to it. If the law was just the opposite it would still be my business to enforce it, and I have no power to do anything else."

Local Supervising Inspector R. S. Rodie believes in the enforcement of existing laws and their removal if they are really objectionable.

"The rigid enforcement of this particular law is the best possible way to get it wiped out," he said. "When automobilists find that they are going to be held strictly to the letter of the law they will bestir themselves to have it replaced with something better, if they can. Naturally they would not take the trouble to do this as long as the existing law was not enforced, and I don't blame them. This particular law certainly ought to be well known, for a copy of it is pasted up in every ferry house. New York is the only place I know of where it is not strictly observed."

NOT ENFORCED BY ALL.

Asked why the law seemed operative at some ferries and not at others, Mr. Rodie said that it applied to all, without exception, and not only to ferries, but to all other steamboats carrying passengers. "It is like this," he said. "When the ten ferries learned through the press that they had

been reported for the infraction of the law, they immediately shut down on allowing automobiles to use their own power on the boats. They did this of their own accord, no notice to that effect having been sent them from this office."

When informed that the Thirty-fourth street-Long Island City ferry, for instance,

subject to a fine for transporting automobiles, and at the same time secure a common sense interpretation of the law, we will be in a position to compel the companies to transport our machines, should they persist in their refusal."

Messrs. Seligman and Niles intended starting almost immediately for Washing-

COAST RUN IN SEPTEMBER.

Frisco-Los Angeles Endurance Contest Postponed to Await New Cars.

Special Correspondence.

SAN FRANCISCO, July 26.—It has been decided by the executive committee of the Automobile Club of California to postpone the joint endurance run of the two California clubs until September, as several San Francisco dealers wish for time in which to receive and try out new cars. L. P. Lowe, chairman of the executive committee, is now in Los Angeles, where he will confer with the members of the Automobile Club of Southern California and will decide on a date in September.

So much opposition is encountered by automobilists in the Western States and the sentiment of the people runs so strongly against speeding on the high roads, that an endurance run seems a very suitable competition, especially under conditions that make it impossible to run at high speed without incurring disqualification. The ordinary motorist wants a car that can be satisfactorily used for touring.

LAUNCH RACES IN THE ST. LAWRENCE

Special Correspondence.

CHIPPEWA BAY, N. Y., July 30.—Five of the fastest gasoline launches in the St. Lawrence region started in the first race held here under the rules of the American Power Boat Association over a twelve-mile triangular course this afternoon. The race was won in 47:02 by the *Chip*, owner by J. Wainwright, of Philadelphia, and operated by Ernest Sewell, of Bayonne, N. J. Second prize was awarded to *Roma*, owned by Louis Hunt, of Brooklyn, which covered the course in 52:09. The other boats finished in the following order: *Bubble*, Commodore Englis, of New York, 52:53; *Radium*, G. E.

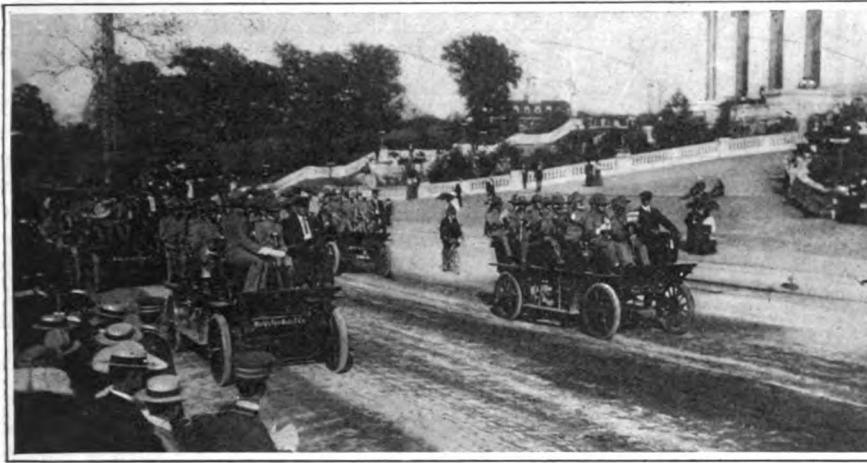

CONVEYING TROOPS IN ELECTRIC AUTOMOBILES AT THE WORLD'S FAIR PARADE.

carried both gasoline and steam automobiles on Sunday under their own power, Mr. Rodie said he had no official knowledge of any violations of the law with the exception of the ten already referred to.

The Automobile Club of America believes that the word "fire" as used in the act was never intended to apply to the ignition sparks or the explosions within the cylinders of gasoline automobiles, it being evident from the wording that steam machines were the ones against which precautions were being taken. No trouble has ever occurred on ferry boats in New York through fire from automobiles, either steam or gasoline, and the interpretation now placed on the law is so far-fetched and improbable as to be considered ridiculous by all automobilists. The matter was taken up at the meeting of the Board of Governors of the Automobile Club of America on Wednesday, August 3, and it was determined to entrust a special committee with the task of securing from the U. S. Department of Commerce and Labor a more liberal interpretation of the meaning of the statute. The work was placed in the hands of W. W. Niles, counsel for the club, and Jefferson Seligman, who were instructed to communicate with Secretary Metcalf of the Department to see what could be done in the matter.

The president of the A. C. A., Winthrop E. Scarritt, referring to the action of the ferry companies, said:

"They are taking refuge behind the \$500 fine clause, ignoring the clause in the amendment which permits them to use their discretion in accepting automobiles for transportation. If we can secure from the Department of Commerce and Labor an assurance that the ferry companies will not be

ton, in order that the matter might be taken up with as little delay as possible.

Transportation Day at the Fair.

In the land parade on the World's Fair Grounds at St. Louis last Saturday, which was Transportation Day at the Exposition, all the big racing cars from the booths were out in gay attire. Igorrotes from the far away Philippines rode in twentieth cen-



IGORROTES AND OTHER EXHIBITS IN THE PARADE ON TRANSPORTATION DAY.

tury automobiles, and primitive Indians were given seats in tonneaus. It was a far cry from the beating of tom toms to the toot of an auto horn. Fifty automobiles from the American and foreign exhibitions added their share to a magnificent parade.

An automobile passed through here Sunday and caused great excitement among the natives.—*McLeansboro (Ill.) Times*.

Campbell, Alexandria Bay, 45:31. The *Kitten*, owned by ex-Mayor George Hall, of Ogdensburg, was fouled at the starting buoy. The *Bubble* was the only French type auto-boat entered, and is equipped with a French motor. Wainwright's *Chip* is the fastest launch of her class hereabouts. She was built last spring, and is 27 feet long, 3 1-2 feet beam and has a 10-horsepower Leighton engine. The Brooklyn boat ran a sensational race through a heavy sea.

Correspondence

Cure for Ignition Troubles.

Editor, THE AUTOMOBILE.

Sir:—Replying to the query of "H" about electric ignition troubles in the July 23 issue, I send the following suggestions:

The troubles mentioned are undoubtedly due in a great measure to the improper ratio of speed between the engine pulley and the dynamo pulley. The speed of the dynamo is evidently too low, since after attaining high speed at the engine the ignition is perfect as stated. Apparently when the engine is running at slow speed the dynamo speed is not sufficient to generate current at a voltage in excess of that of the storage battery which allows the battery to discharge into the dynamo.

The proper remedy, if this be the case, would be to determine with a speed indicator the speed of the dynamo at the time the engine is running at high speed, then calculate the size of pulley required on the engine or dynamo to maintain the same speed when the engine is running at slow speed. Of course, there should be a governor attached to the dynamo pulley which will release when the proper dynamo speed has been attained. Then again, your correspondent's trouble may be due to the capacity of the dynamo being too low to charge an exhausted cell and operate the spark coil at the same time. The remedy in this case would be a dynamo with a

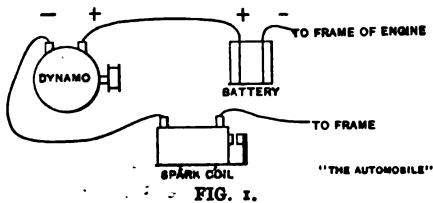

greater ampere output, but it is quite likely there is some other trouble as the dynamo must have worked properly at some time, when tested by the builder.

It appears from the explanation of the system of wiring shown in Fig. 1 (as much of it as I can understand) that the whole arrangement is very much in need of overhauling.

It is plain from this sketch that the dynamo is working against the storage cell and necessitates a high dynamo speed to overcome the action of battery, and that it is also delivering current to the battery in the wrong direction. When engine is slowed down the battery would, if there were any life in it, discharge through the dynamo, or else reduce the action of the dynamo to such a degree as to make it useless.

This sketch, if it is a correct copy of the system used, shows that the dynamo is used in starting and that the two sources of ignition are in use at the same time.

I doubt whether your correspondent can get satisfactory results from a one-cell stor-

age battery as mentioned, as most spark coils are made for two or more cells of batteries.

He would do well, if sure that he is only using one cell of battery at a time, to make such connections as will put both cells in use at the same time and then arrange the wiring as follows. See Fig. 2.

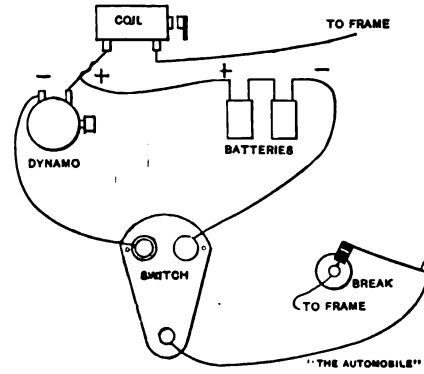

Have the two points on the switch close enough together so that in charging the switch lever will not rest on both points. This arrangement allows of the use of the storage battery independently or the dynamo independently, and also allows of charging at any time while the machine is running and at the same time furnishing current for the spark coil.

This is the system in common use and gives satisfaction. The storage battery and dynamo combination is a nuisance in most cases with the average motorist, since the storage battery requires more careful attention than is usually bestowed upon it.

The dynamo requires very little attention beside oiling and the occasional renewal of brushes, the wear and attention to commutator and slipping of belt.

The combination of dynamo and dry cells, the former for continuous running and the latter for starting, gives much better results in ordinary hands.

My opinion is that better results are obtained by the average motorist by the use of batteries for ignition, using two or more sets of batteries with the required number per set and by the use of a two-point or double throw switch.

With this arrangement one set at a time can be used until exhausted, or the two sets used alternately every other day or alternately on a long trip.

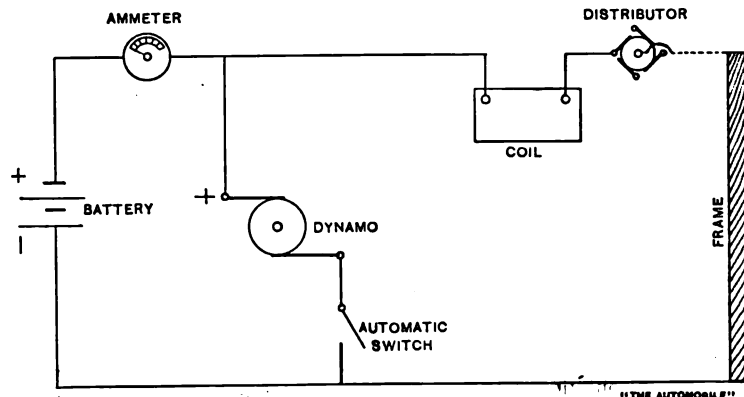

The alternate use of the dry cell equipment gives more time for recuperation, and keeps the batteries in better condition.

However, the method of using them is a matter of choice. By the use of two or more sets of dry batteries it very seldom occurs that both sets get weakened at the same time (due to carelessness of the operator in not renewing a set when he knows it is exhausted) to such a degree that the operator cannot get enough cells out of both sets to be able to get to a repair shop or even home.

The care of a dry battery is nothing beyond examining connections and tightening of screws, and an occasional test to determine the condition of each individual cell.

In testing a dry cell it is common practise to use an ampere meter, the cells indicating the largest current output being considered in the best condition.

While this may be so in some cases I have found cells with a lower current output give longer service.

In testing dry batteries I have found that the use of a voltmeter gives better satisfaction inasmuch as the current output of different makes varies very widely, while the voltage is very nearly the same with all makes.

The voltage of a dry cell when in good condition varies from 1.4 to 1.5 and is about exhausted when reduced to from 1.2 to 1.3.

I hope this may be of some use to the gentleman in trouble.

C. T. V.
Bloomfield, N. J.

Editor, THE AUTOMOBILE.

Sir:—Your correspondent signing "H," who wrote about ignition troubles in the issue of July 23, has raised some interesting points, and the enclosed comment may be of some help to him.

The batteries are evidently in bad condition. "H" does not state whether there is an automatic switch fitted to the ignition system or not. If such a switch is fitted, it may not be working properly. Should this switch stick, and remain closed, the battery would quickly become exhausted. The reason is, that an alternate path would be open to the current from the batteries, part of which current would flow through the dynamo when the armature of the latter was either standing still, or revolving too

slowly to generate an electromotive force, or voltage, equal to, or greater than the battery voltage. See Figure A. If the automatic switch functions properly, the batteries are at fault, and should be sent for overhauling either to the battery manufacturer, or to some one who does battery repairs.

The accompanying diagram shows the proper way to make the various connections. When connected as shown, the batteries will send current through the ammeter (this should be a double scale instrument, one scale shows battery current, the other scale dynamo current) coil and distributor, or interrupter, to the frame and so back to the negative battery pole. When the dynamo armature is revolved at a certain predetermined speed, the automatic switch closes. At this speed the dynamo will generate a voltage slightly in excess of the battery voltage. Consequently the current from the dynamo is divided into two parts, one part going through the coil and interrupter to the frame, the other part going through the battery, but in the reverse direction, to that which the battery current would travel, if the dynamo were not connected.

Under these conditions the dynamo is charging the battery, as well as supplying current to the coil. Should the dynamo speed drop low enough, the automatic switch will open, and the battery current flow through the coil. If the battery is out of order, the motor will then, obviously, fail to ignite. If an automatic switch is not fitted a hand switch may be used. This must be closed after the motor is started.

The battery may be short-circuited so badly that it will allow all the current generated by the dynamo (at comparatively low speeds) to pass through it. Obviously, under these conditions, no current will pass through the coil and the motor will stop. When the motor is not allowed to slow down too much, the dynamo will generate current in excess of that which goes through the partially short-circuited battery. This excess will, of course, flow through the coil and so keep the motor running.

Changing the pulley on the dynamo shaft and putting on a smaller one will enable "H" to run his motor slower and still use the dynamo current for the coil. An objection to the small pulley is, that on account of the increased dynamo speed the current will be excessive at normal motor speeds and will tend to overcharge the batteries and possibly injure the coils. Your correspondent will not have to modify the present equipment, in order to insure the result intended by the manufacturers.

If the batteries are of sufficient capacity, and in good condition, and if the automatic switch or its substitute is closed and opened at the right time, there is no reason why the present arrangement should not operate satisfactorily, assuming, of course, that the wiring is in good condition.

Although the dynamo and storage battery

system is an excellent one, when properly fitted and handled, I am not prepared to say that it is the best method of furnishing current for ignition. For a motor such as the one described, using dry batteries would seem to us a step backward. T.

New York.

Change of Sprocket.

Editor THE AUTOMOBILE:

Sir:—I would be thankful for some information about lowering the gear of my machine.

I have an automobile runabout, which has a 5-inch by 6-inch single cylinder. It will not climb better than an 8 per cent. grade on the high speed. If I put on an 8-tooth sprocket in place of the 9-tooth sprocket that the machine has on now, what changes would it make in the running for hill-climbing and level?

E. S. M.

Connellsville, Pa.

If an 8-tooth sprocket is put on instead of the present sprocket, which has 9 teeth, it will cause the machine to run slower on both the low and high gears. With the smaller sprocket steeper grades can be ascended, on both gears, than with the present arrangement. With the 8-tooth sprocket when running on level roads, or down hill, the engine will have to make more revolutions per minute in order to maintain a given speed of car, than with the 9-tooth. Therefore, unless you are careful in handling the car your motor will be racing most of the time, when your car is running on the level or down hill. Racing a heavy motor, like the one you refer to, will result in heating it up, and in wearing out the bearings.

Mors Timing Apparatus.

The extreme speeds attained by modern racing automobiles have in a comparatively short time rendered the split second stop watch nearly obsolete as a method of registering their velocity. At such tremendous speeds as these machines attain, when the automobile is timed over a kilometer or a mile at speeds of 60 miles an hour or more, an error of a fraction of a second in the watch, or in the hands of the timer, produces a much more considerable percentage of error than when the instrument is used to time nothing faster than a running horse. The stop watch leaves no record by which an error in reading it can be detected, and its rate is guaranteed only apart from the stops imposed upon it.

The new Mors apparatus, which received the prize offered by the Automobile Club of France for the most successful apparatus of its sort, makes use of a strip of paper which is unrolled continuously by clockwork. It might be supposed that this paper would unroll at a constant speed and would therefore be itself a measure of the lapsed time. Practically, however, this is not the case, and the lapse of time is indicated by dots pricked in it every

fifth of a second by a needle actuated by an electro-magnet. The special chronometer used governs by its escapement an electrical contact finger, by which the circuit in which the electro-magnet is included is made and broken every fifth of a second. This renders the regulating of the paper's movement of no practical consequence, since the time is still accurately registered.

When a vehicle passes the tape another electro-magnet is made to actuate a second needle, causing it to perforate the paper independently of the first. This gives both an exact measure and an exact record of the lapsed time, the exactness being greater as the rapidity of movement of the paper and consequently the interval between the dots is greater.

Autos for Fire Chiefs.

It is now practically certain that within a few weeks New Yorkers will be able to enjoy the sight of Chief Croker dashing to a fire in a modern gasoline automobile, while Brooklynites will line the curbs to watch Deputy Chief Lally being rushed to conflagrations in a similar conveyance. Chief Croker has long held the opinion that the automobile is the best vehicle for this class of work, and even made up his mind as to what particular make of machine he thought was best adapted to his wants. He therefore wrote to the mayor asking to be allowed to purchase in the open market two automobiles, one for his own use and one for the use of Deputy Chief Lally, of Brooklyn, both to be of a make named by the Chief, and to cost \$4,000 each. The Board of Estimate and Apportionment turned this down, however, insisting that the proper method of procedure was to call for bids. Accordingly bids on automobiles to embody the following features were advertised for.

Four-cylinder vertical gasoline motor of not less than 24-horsepower, to develop not less than 1-horsepower for every ninety pounds of weight of vehicle. Body to be of the tonneau type, seating four persons, upholstered in the best tufted leather and ironed for canopy top. Wheels to be of wood, artillery type, not less than 34 inches in diameter, with 4-inch detachable double tube tires. Automobiles to be delivered in 30 days from time of acceptance of bid. Separate bids to be made for New York and Brooklyn. The following offers were received:

For New York—Locomobile Company of America (Locomobile), \$4,000; Auto Import Company (Rochet-Schneider), \$10,000; Winton Motor Carriage Co. (Winton), \$3,000; Duerr-Ward Co. (Royal), \$2,900; Electric Vehicle Co. (Columbia), \$4,000.

For Brooklyn—Locomobile Company of America, \$4,000; Auto Import Co., \$10,000; Winton Motor Carriage Co., \$3,000; Duerr-Ward Co., \$2,900.

New Wayne Models.

Two new models have been brought out by the Wayne Automobile Company of Detroit, Mich.; a 16-horsepower light tonneau machine and a 9 1-2-horsepower runabout, both cars being built on the same general specifications.

The tonneau machine has a frame of pressed steel, the corners being re-enforced with forged steel plates, two to each corner, hot riveted. The drop forged spring hangers, similar in general style to those used on French touring cars, are secured to the frame in the same manner. The semi-elliptic springs are 40 inches long, and are hand-forged. All springs are interchangeable. The wheel base is 80 inches and the tread 56 inches. The motor is of the double opposed cylinder type, the cylinders having

by a single roller chain. Artillery wood wheels, 30 inches in diameter, are used shod with 3 1-2 inch detachable double tube tires. The brake operated by two foot-levers acts on the outside of the differential drum, there being a band on each half of the drum, the braking pressure being equalized by a compensating device. Lubrication is effected by compression grease cups and by a multiple sight feed oiler with six leads. Water circulation is maintained by a positive gear pump, the radiator, of the flanged tube type, being placed at the front of the hood just under the water tank. The tubes are of copper and the flanges square. The gasoline tank, with a capacity of 12 gallons, is under the rear portion of the hood, and in a space between the radiator and gasoline tank is the battery, consisting of two sets of dry cells, six in a set. Jump spark ig-

by a Boston firm. The chassis is the regular Knox chassis of the double-cylinder type, embodying the Knox system of air cooling, side spring suspension, and is fitted with a platform body 8 feet long and 4 feet wide, exclusive of the driver's seat. At the rear spiral springs are used to assist the side springs in carrying the load. The vehicle weighs 2,700 pounds, and has a capacity of 2,500 pounds dead weight, besides two men, and carries fuel for about 100 miles. It is geared to a maximum speed of 15 miles an hour. The wheel base is 8 feet and the wheels are of wood, 32 inches in diameter, shod with 3 1-2-inch solid rubber tires.

A smaller truck is also built on the single-cylinder chassis, having a platform 4 feet wide and 6 feet long and a carrying capacity of 1,500 pounds. Speed, 12 miles an hour maximum. Both these wagons are fitted with special Timken roller bearings, made very heavy and substantial.

About twenty Knox commercial vehicles of this type are in constant use in and about Boston, most of them being used for suburban delivery service.

The Cameron Car.

The Cameron Car, built by the United Motor Corporation, Pawtucket, R. I., is a light runabout propelled by a single cylinder air-cooled motor placed vertically under a metal hood in front, the front of the hood having a wire netting screen through which the air currents pass to the motor. In addition to this an eight-inch belt-driven fan is employed to assist in carrying away heat from the cylinder. Both valves are placed in the head of the motor, immediately above the piston. The intake valve is automatic and has a diameter of 1 3-4 inches, while the exhaust valve is a quarter of an inch greater diameter, and both are fitted in removable seats. Semi-steel is the material used for the piston, which is very light in weight and has a stroke of 4 inches. The bore of the cylinder is 4 1-8 inches. Weight is also saved by hollowing the wrist pin, which is 3-4 inch in diameter and of steel. Phosphor bronze is used for the main bearings, and also for the entire connecting rod. The crank shaft is 1 3-8 inches in diameter and the bearings 3 inches long. The crank pin is 1 3-8 inches in diameter with a length of 2 inches. The motor is lubricated by splash.

A cone clutch, held in engagement by a spring and released by a pedal, transmits the power to the change speed gear. This is a sliding gear, giving two forward speeds and a reverse, the ratio being 15 to 1 on the low and 5 to 1 on the high gear. The gears are cut from solid steel, are hardened and run in an oil-tight case. The gear shaft bearings are of phosphor bronze. Transmission from the gear box to the bevel gear differential on the rear axle is by shaft and universal joint. Internal expanding ring brakes are fitted to the rear hubs and are operated by a foot lever working on a rat-

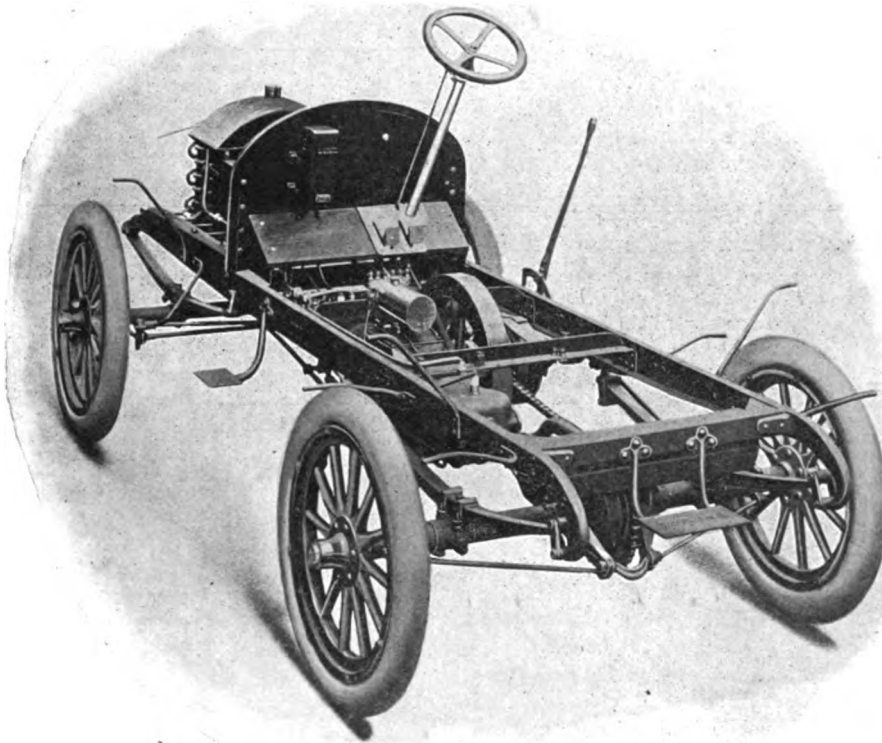

REAR VIEW OF CHASSIS OF 16-HORSEPOWER WAYNE TOURING CAR.

a bore of 5 inches and the piston a stroke of 5 inches. Each cylinder head and water jacket is cast integral, avoiding the use of gaskets for packing. The crank case is split horizontally at the centre line of the shaft, the lower part carrying the two-to-one shaft and valve cams, while the upper half is provided with a generous hand-hole on top, covered by a plate. The push-rods are underneath the cylinders, and the intake valves appear to be mechanically operated. The motor is rated at 16-horsepower at 900 revolutions per minute.

Anti-friction bearings are used in all the road wheels, rollers in the rear and balls in the front. The differential on the rear axle is of the spur type, the gears being of steel. Two speeds and reverse are given by the planetary change speed gear, and drive is

tion is used, the coil being placed on the dash. The traveling radius of the machine is given as 200 miles.

The body, which is finished in carmine, with black trimmings, has individual front seats. All seats are upholstered in buffed leather.

The same description applies to the runabout, except that the motor used in the latter has a single cylinder of 5 1-2 inches bore and 5 1-2 inches stroke, rated at 9 1-2 horsepower.

Knox Stake Truck.

The Knox platform stake truck illustrated herewith was built for the severe work imposed by daily brewery service, and is standing up well under the test. It is used

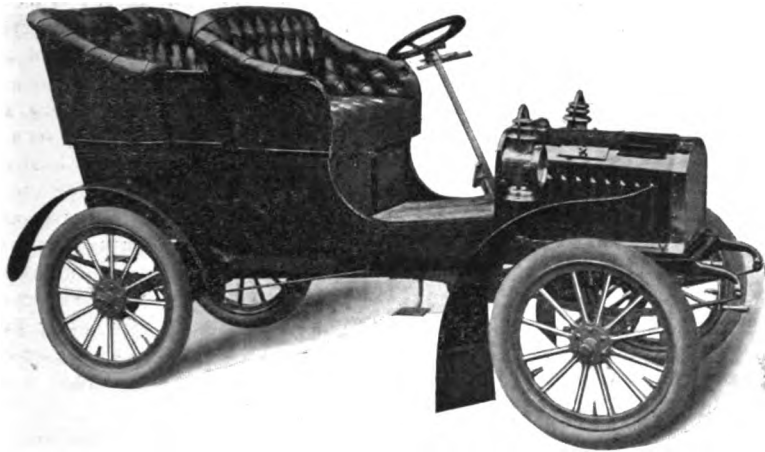

CAMERON TONNEAU CAR FITTED WITH AIR COOLED MOTOR.

chet which will hold the brake at any point desired. The gasoline tank holds fuel for from 150 to 200 miles, according to road and other conditions. A single lever controls the gasoline and air in the float feed carbureter. The throttle, spark and speed changing levers are grouped on the steering column, directly under the wheel. The wheel tilts, permitting easy ingress and egress.

Other points of this machine are 28-inch wood wheels with 2 1-3 inch detachable tires; steering gear adjustable for back lash; automatic throwing out of the clutch when brakes are applied; foot pump for forcing fresh oil into crank case; large laminated wood mud-guards; wheel base, 76 inches; tread, 46 or 54 inches; weight, 700 pounds, or, with detachable tonneau and canopy top, 800 pounds.

Auto Boat Comanche.

The most extreme development of the auto boat idea thus far produced in this country was launched on July 25 at the Mor-

ris Heights, N. Y., works. The motor, which is said to be of 350 horsepower, has nine cylinders, each 10 inches in diameter

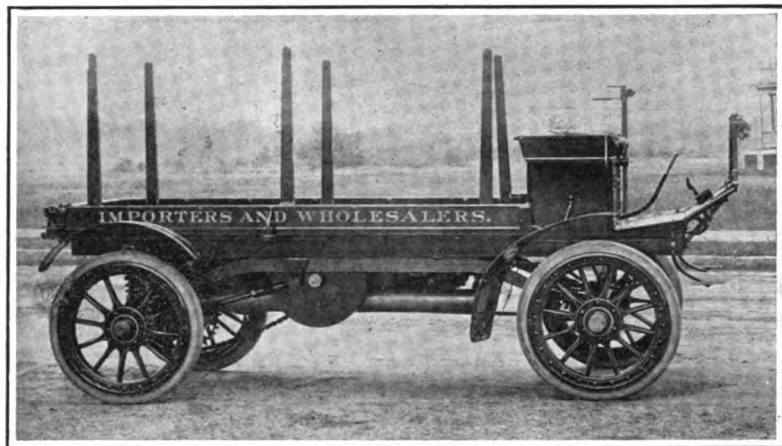

KNOX STAKE TRUCK BODY ON REGULAR DOUBLE-CYLINDER CHASSIS.

by 8 inches stroke. The new boat named *Comanche*, was built for Samuel H. Vandergrift, a wealthy Pittsburg manufacturer,

underwater body is very shoal, with a wide flat section throughout, the run being perfectly flat and of the full breadth of the boat.

The hull is built of three thicknesses, the outer skin of teak below water and Spanish cedar above, all riveted with copper. There are three cockpits, with high coamings of mahogany, the motor being placed in the middle one. The construction of the hull is of the lightest, but with thorough bracing and careful balancing of the motor it is expected to be amply strong.

The motor, specially designed for the hull has cylinders of 10 inches bore by only 8 inches stroke, the weight being thus kept as low as possible. The cylinders are cast in pairs, three sets being bolted together in the forward group while the second group, slightly separated, but has three. The engine base is made of a couple of bars of angle steel, and each cylinder is supported on four light steel standards, about 3-4 inch in diameter, with a diagonal brace to each of half-inch steel rod. While the big cylinders with their oval water-jackets look very heavy and massive, the base and supports are spider-like in their lightness. The motor is supported in the boat by light trusses of angle steel, running fore and aft.



The photograph herewith reproduced shows the new four-cylinder air-cooled Premier tonneau car built by the Premier Motor Manufacturing Company, of Indianapolis. The occupants are: Front seat, H. O. Smith, president, and at the wheel, George Weidley, superintendent of the shops; rear seat, front view, Carl Fisher; side view, Lucian M. Wainwright.



VOL. XI.

No. 6

Published every Saturday by

THE CLASS JOURNAL CO.,

Flatiron Building, Madison Square,
NEW YORK CITY.Cable Address - - - Autoland, New York
Long Distance Telephone - 300 Gramercy, New York

SUBSCRIPTION RATES:

United States, Canada and Mexico, - One Year, \$2.00
Other Countries in Postal Union, - One Year, \$3.00To Subscribers—Do not send money by ordinary mail.
Remit by Draft, Post-Office or Express Money Order,
or Register your letter.

FOREIGN SUBSCRIPTION AGENTS:

ENGLAND:—Iliffe & Sons, Limited, 3 St. Eklide Street,
Ludgate Circus, London, E. C.FRANCE:—Boyveau & Chevillet, 22 Rue de la Banque,
Paris.

GERMANY:—A. Seydel, Mohrenstrasse 9, Berlin.

To Advertisers—Copy or changes in orders for advertisements should reach us not later than 5 o'clock p. m. Monday for the issue of Saturday following.

Copyright, 1904, by The Class Journal Company.
Entered at New York, N. Y., as second-class matter.The Automobile is a consolidation of The Automobile
(monthly) and the Motor Review (weekly).Copies Printed This Issue, - - 12,500
“ “ Since Jan. 1, - 385,800

Advance-ment in Reliability. Progress is measured comparatively, and when we do not know how far we shall go, we look back to estimate the distance we have come rather than forward to the final destination. Thus, in automobile building, we look back at the annual endurance runs, automobile shows, hill climbing contests and speed trials that mark our progress like milestones on the highway. An excellent opportunity for estimating the advancement made in motor vehicle construction is afforded by the present tour to St. Louis, as the route of the tourists from New York to Buffalo is over the same course as was followed in the endurance run conducted in September, 1901, the lapse of three years serving to emphasize the improvement as a twelve-month could not possibly do. This is one of the pleasing features of the present run.

Among those participating in the present run are a considerable number of persons who took part in the Automobile Club of America's first endurance run three years ago, and by the testimony of some of these it is evident that the road and weather conditions were about the same last week when the tourists were wallowing up along the east bank of the Hudson and through the Mohawk Valley as they were during the previous memorable event. Comparison of results is therefore most fair.

In 1901 seventy-eight competing cars started, of which four were foreign made

and twenty-six were steam vehicles. Despite the hard traveling, the test for endurance or reliability degenerated as usual into a race, but the average speed was only about twelve miles an hour. The daily stages were less than ninety miles, the schedule allowing six days in which to traverse the 500 miles from New York to Buffalo. The run was never completed, being called off in Rochester out of respect to President McKinley, the news of whose death in Buffalo the contestants received in Rochester.

Of the seventy-eight starters, forty-one arrived in Rochester the fifth day after reporting at all the controls. Twelve reached Syracuse with complete records, but did not arrive in Rochester; seven dropped out at or beyond Herkimer and thirteen at or beyond Albany. Compare this with one failure to reach Albany out of sixteen starters from New York this year, and the arrival in Cleveland of all the twenty-three starters from New York and Albany with the exception of this one, which was disabled by the dropping of a wrench into its gear box and not by any inability to negotiate the roads. Only sixteen of the vehicles in the 1901 endurance run carried more than two persons, whereas the majority of the cars this year are carrying from three to five, but the horsepower and weight of the machines now is considerably greater than three years ago.

The improvement in hill-climbing ability that has been made in the three years is silently attested by the almost total absence of trouble on the hills in the present tour, whereas a comic opera scene was enacted in 1901 on Nelson Hill, just north of Peekskill, nearly half of the contesting cars getting stalled at some point on the 2,372-foot climb up the average grade of 9.1-2 per cent., with a maximum grade of 16.15 per cent. for 100 feet. The report of the Nelson Hill climb of three years ago is ludicrous in the extreme, but now no one in the run appears to mind the hills. Unfortunately, for purposes of comparison, the tourists did not go over Nelson Hill this year.

Scorching on the Tour.

Reports from the front by those participating in the A. A. A. tour to Saint Louis confirm the fears of many well-wishers of the cause that the tour would degenerate into a run pure and simple. There is little of the real pleasure tour spirit shown in the actions of those participants who get up in the early hours of the morning to make a trip of say a hundred miles to the next night stop. In the space of about three hours these pleasure-seeking, law-abiding automobilists cover the distance that was scheduled to occupy the entire day, and for no better reason than they want to see their names in the local papers among the first arrivals.

Unfortunately for the well-being of auto-

mobiling this was a lesson that was learned on last year's endurance run to Pittsburg. Then as now the great mass of the townsfolk, newspaper men included, in each of the stopping places on the journey, erroneously supposed that some sort of a speed contest was being held. Consequently the early arrivals got the credit and publicity that naturally rewards the victors. It did not matter in what condition a machine arrived, it was *when* it arrived that attracted the local interest.

It is certainly a "cheap" way for a manufacturer to exploit his product, having by his previous entry practically subscribed to the reasonable rules and regulations that are supposed to control the tour. Beside this conduct, the action of the ordinary auto mucker seems honorable. He avowedly goes out to break the law and takes the chances not only of arrest and fine for speed law infractions, but of far more serious punishment at the hands of a jury in civil or criminal proceedings that might follow any damage to property or injury to other users of the highway. In the present case, however, the scorchers are taking advantage of those living along the route who had been led to believe that the tour would be conducted in an orderly, considerate spirit—a gentleman's affair.

One of our correspondents who followed in the trial of the tourists in New York reports a considerable number of domestic animals dead and dying along the road, in a bloody record of the passage of the cars. Yet there is no word of any action being taken by the A. A. A. officials on the run to discipline or disqualify those who bring a delightful form of sport and pleasure into disrepute. The remedy plainly lies in the hands of those officials who, should the circumstances warrant, could call off the tour as a measure of protest and a public assurance of their sincerity in denouncing reckless scorching and selfish defiance of the rights of other road users.

If no questions of property or individual rights were involved, the rough riding tactics are shortsighted, from the fact that the rural population is well equipped to attempt reprisals not only directly against individual tourists but indirectly against the great body of automobilists by influencing repressive legislation.

Independent Foreign Show.

If present intentions develop into matured actions New York will have two separate automobile shows next winter. A secession movement has been going on for some time among importers of foreign cars in New York, who are dissatisfied with the consideration or want of it shown by the National Association of Automobile Manufacturers. At the last Madison Square Show the foreign built cars were practically buried in the restaurant, where the entire floor space was too small for the proper display of the cars.

Will Prefer Charges Against Magistrate.

actually exhibited, and when from this was taken the space for aisles for the public and accommodation for the attending salesmen the remainder was absurdly inadequate.

Naturally there are two sides to the dispute, and in this case it is not easy to figure out how an acceptable compromise can be reached. On their part the representatives of foreign cars want stands allotted to them on the main floor, taking their chances with the larger home builders for floor space there. Domestic interests fail to see why foreign cars should be given a large share of the best space in the whole exhibition to the exclusion of American cars. They reason that while it is an automobile show, it is primarily an American automobile show and the home product should have first choice. In a country of majority rule the result is not difficult to foresee.

It was plain at the last New York show that the entire available space was inadequate to accommodate all intending exhibitors, and the conditions are not likely to change for the better. The trouble is that the amount of floor space is a constant while the space required is a variable and increasing quantity.

It will be recalled that what was practically an overflow show was held under private auspices last year in the Macy Building on Herald Square, New York. It is not unlikely that this hall will contain the entire foreign exhibit next winter.

A question yet unanswered is whether or not the public will follow the foreign cars in numbers that will satisfy the seceders. Those in the trade who regularly come to the annual display will undoubtedly attend and so will the large number of interested persons who want to compare the foreign and domestic makes. In fact, both the expert and the interested will attend both displays. At the National Show, however, many persons who have a slight present interest in automobiles attend for an evening's entertainment. In such persons a taste is often awakened by the show and when their automobile education is sufficiently advanced, at some later period, they are likely to become purchasers. It is this latter class that is in the doubtful column with respect to an independent show of foreign cars.

While automobilism recently in Rowayton, a country settlement between Stamford and South Norwalk, Conn., Rear Admiral Schley was in collision with Charles Read. According to eye witnesses of the collision, Read, who is something of a character in the community, was crossing the street in such a way that even an admiral could not be expected to steer clear of him, and it is yet an open question whether the machine ran into the man or the man ran into the machine.

The motor car business is assuming considerable proportions in India, notwithstanding the expense of gasoline, which is, comparatively speaking, very great.

A meeting of the Board of Governors of the Automobile Club of America was held at the clubhouse on Wednesday, Aug. 3. The members of the Board present were Winthrop E. Scarritt, President; Jefferson Seligman, A. R. Shattuck, W. W. Niles, H. R. Winthrop, Geo. F. Chamberlain, Arthur Iselin and Secretary Butler. The following resolutions were passed:

Resolved, That charges be preferred against City Magistrate R. C. Cornell, to the Appellate Division of the Supreme Court of this Department, as being an unfit person to preside on the Bench, as he has by his utterances from the Bench incited citizens of this State to rioting and to the taking of human life; that such utterances have borne fruit is evidenced by the fact that an innocent man driving an automobile, who

was declared by the Court to be not guilty of violating the law, was shot at by a deputy sheriff.

Resolved, That a special Committee consisting of Mr. Jefferson Seligman and Mr. W. W. Niles, Counsel of the Club, communicate at once with Secretary Metcalf of the Department of Commerce and Labor and endeavor to secure from him a fair and liberal interpretation of the present statute so as to permit of the carrying of gasoline motor cars on ferries.

The matter of the shooting at an automobile by Deputy Sheriff Wicks, of Patchogue, L. I., which followed close upon Magistrate Cornell's remarks, approving of the shooting of automobilists, will be taken up vigorously by the Club and carried through to finality.

DECIDES TO FIGHT.

Chicago A. C. Votes to Oppose New Licensing and Numbering Ordinance.

Special Correspondence.

CHICAGO, July 30.—A meeting of the members of the Chicago Automobile Club was held Wednesday evening to consider some course of action regarding the newly enacted city ordinances regulating the use of automobiles. The following resolution was adopted:

"Whereas, It is the sense of the membership of the Chicago Automobile Club that the Chicago city ordinance requiring that numbers be assigned and affixed to automobiles operated in Chicago is an undue interference with the rights of drivers or owners of such vehicles, therefore, be it

"Resolved, That the board of directors be instructed to resist the enforcement of said ordinance through the institution of such legal measures as may be advised by the counsel of the club."

Another resolution referring to licensing was also passed, as follows:

"Resolved, That such legal measures as may be advised by the counsel of the club be instituted by the board of directors with the object of restraining the enforcement of the recently enacted ordinance providing for the licensing of drivers of automobiles."

Judge Haney decided last Friday that the speed gauge used on the automobile of Joseph F. Gunther was better evidence than time recorded by an Evanston policeman with a stop watch, and Gunther was discharged on habeas corpus proceedings. The judge held that Gunther was not liable for a fine imposed under the 12-mile ordinance in Evanston, the prisoner and his associates, Frank P. Smith and Andrew McAnsch, declaring that the speedometer showed only eleven miles an hour when they were arrested.

COAST CONSTABLE EMULATES WICKS.

Special Correspondence.

SAN FRANCISCO, July 26.—Last Saturday Thomas C. Berry, a well-known insurance man of this city, with his brother, W. F. Berry, was driving along the San Anselmo road at about 9 o'clock in his motor car when two constables ordered him to stop. When Berry did not slacken speed Consta-

ble Hughes drew his revolver and began shooting at the automobile. The driver then stopped his car and he and his brother were arrested and taken back to San Rafael, the county seat. On being brought before Judge Magee they were released on bonds of \$100 apiece. They were charged with operating an automobile on a public road of Marin County after sunset, in violation of a county ordinance. T. C. Berry says that he believes the ordinance to be unconstitutional and will resist it. The constable says that he fired at the tires of the car, in the hope of puncturing them.

DEL MONTE DATES FIXED.

August 18 to 22 Selected for A. C. of California Run and Races.

Special Correspondence.

SAN FRANCISCO, July 26.—The executive committee of the Automobile Club of California has decided to hold its annual trip to and race meet at Del Monte in August. The motor cars from San Francisco will start Thursday morning, August 18, and will run through to Del Monte, arriving in the evening. If any of the automobilists desire to do so, a stop may be made at San José or elsewhere for the night and Del Monte reached by making an early start next morning. The races will be held Friday and Saturday, the intention being to complete the program each day before the air becomes chilly. Sunday will be devoted to rest and an easy trip round the Seventeen-Mile Drive, one of the finest marine roadways in the United States. On Monday the motorists will return home.

The program of races will be drawn up on the return of L. P. Lowe from Los Angeles. It is expected that several Los Angeles and Pasadena motorists will come up to Del Monte to take part in or witness the races. An opportunity will thus be afforded for further consultation about the endurance run.

LA ROCHE PASSES INDIANAPOLIS.

A telegram received in New York Thursday morning announces the arrival of F. A. La Roche in Indianapolis on his return trip over the southern route in his non-stop run. At that place he had exceeded the record made some time ago by Edge in England.

IN FIGHTING MOOD.

Settlement of Toll Road Suit Encourages Members of Philadelphia Club.

Special Correspondence.

PHILADELPHIA, Aug. 1.—Despite the conservative advice to the Automobile Club of Philadelphia by its legal adviser, E. A. Ballard, on the question as to whether or not a fight should be made against the Lancaster Avenue Improvement Company in the matter of that corporation's discrimination against automobiles in the way of toll charges, many of the individual members still continue to urge prompt legal action. As the list of members who have been compelled to pay the increased charges grows, the feeling that the matter should be fought to a finish increases.

This attitude of the pugnacious ones was considerably strengthened last Saturday, when it became known that the Springhouse and Sumneytown Turnpike Company, against which Charles Wainwright, a motorcyclist, had brought suit for the return of overcharges, compromised the case by announcing a return to the former rate and refunding the overcharge. This action was brought about after the turnpike company's counsel had practically assured the board of directors that they hadn't a leg to stand on. Orders were immediately issued to all the toll-takers along the pike to rate an automobile runabout the same as a one-horse vehicle and larger machines on the basis of vehicles drawn by two horses.

While this decision is gratifying to those who advocate fighting the Lancaster Avenue Improvement Company, it throws upon them the whole burden of securing a legal decision in the matter. Local automobilists had hoped that the Wainwright case would be fought to a finish in the regular way, but the settlement by agreement of counsel gives the Philadelphia automobilists no precedent on which to base their claims.

However, as the conditions existing on the Lancaster Pike are practically identical with those which obtained in the Wainwright case, several club members are urging an immediate move, confident of either a favorable settlement out of court or an absolute victory.

The case of Samuel Bell, Jr., vs. Radnor Township, which will bring up the question as to whether the State or borough limit obtains in sections which are not built up is listed on the Superior Court docket for an early trial. Judge Johnson, in the Common Pleas Court of Delaware County, decided adversely to Mr. Bell's claims, and the latter, backed by the Automobile Club of Philadelphia, immediately appealed the case to the higher court. Mr. Bell, who was arrested while driving his car over a lonely road in Radnor Township at a sixteen-miles-an-hour rate, contends that as he was well within the twenty-miles-an-hour State limit he was fracturing no law, despite the fact that the township's maximum rate is ten miles an hour—in other words, that where the State and local laws conflict, the State law is paramount. If such an opinion can be written into the State's statute-books it will mean much to automobilists generally in the way of protecting them from the petty persecution of sheriffs, constables and magistrates.

RHODE ISLAND CLUB RUN.

Special Correspondence.

PROVIDENCE, R. I., Aug. 2.—The Rhode Island Automobile Club will hold its second long run of the season Saturday and Sunday, August 6 and 7, when the members will visit Onset Bay, Mass. The start will be "go-as-you-please" from the clubrooms

at the Crown Hotel at 2 p.m. The total distance is fifty-three miles. Supper will be served at the Glen Cove Hotel, Onset, at 7 o'clock. The start for the return trip will be made Sunday afternoon at 2 o'clock, affording the members ample time to visit the beach, take a dip in the sea, or enjoy short runs to the summer home of Ex-President Cleveland, Joseph Jefferson and other distinguished personages. The roads are said to be in perfect condition and it is expected that a large number of the members will participate.

BOSTON MOTORISTS ACQUITTED.

Special Correspondence.

BOSTON, Aug. 1.—To John J. Kelleher, manager of an automobile garage in Salem, belongs the distinction of being the first motorist to be acquitted in the local municipal courts under a charge of exceeding the park speed limit. He and ten other automobile drivers were arraigned in Judge Burke's court last Friday, charged with excessive driving. Several of the ten pleaded guilty and all but three were fined \$10 each.

The exceptions were Mr. Kelleher, George B. Reed, a dealer at 41 Stanhope street, Boston, and Frank E. Straw, of Salem. They pleaded not guilty and presented evidence to refute the testimony of Patrolman Stevens, who had made their arrests, timing their movement by means of chalk marks on the street and a watch. Stevens testified that Kelleher was going at the rate of fifteen miles an hour, but Kelleher stated that this was impossible, as he was demonstrating a car for a customer and was showing him how slowly it could be made to move in Tremont street, which was so congested with other vehicles that it was impossible to display speed. Judge Burke dismissed the case, saying that he would have to rely strictly upon the law of evidence, and as Mr. Beech, the customer referred to, had supported the testimony of Kelleher, the burden was upon the commonwealth to prove the case beyond a reasonable doubt, which it had failed to do.

Similar action was taken in the case of Frank E. Straw, whose denial that he was exceeding the legal limit was supported by Dr. Percy Brigham, of Roxbury. The judge said that he believed the speed test as made by the policeman was unfair, as he was of the opinion that Patrolman Stevens could not see from a point more than 500 feet distant when an automobile passed a chalk mark on the street.

ENTRY BLANKS FOR POUGHKEEPSIE.

Entry blanks are out for the automobile races to be held at Poughkeepsie by the Dutchess County Agricultural Society, on the last day of its sixty-third annual fair, Friday, September 16. The plan of naming each event, as in running horse races, has been adopted and the names are descriptive as well as "catchy."

The entry blank calls attention to the fact that the one-mile track at Poughkeepsie is one of the best race courses for automobiles outside of New York City, being eighty feet wide, clayed and hard, but smooth and well banked. Entries for the races close September 12, with Arthur N. Jervis, Room 94, Tribune Building, New York City, who has been appointed superintendent of automobile racing by the Agricultural Society and who will have full charge.

A rough and ready way to make a comparative test of the lubricating qualities of two oils is to place a drop in the palm of the hand and rub it hard with a finger of the other hand. Good oil will take a lot of rubbing before a dry spot can be made, while poor stuff will soon break down and cease to lubricate.

LONG BRANCH CARNIVAL.

New Jersey Resort to Have Automobile Week This Month.

The dwellers in Long Branch want an automobile carnival of a week's duration, and "Senator" W. J. Morgan, of New York, has undertaken to give them their desire during the week of August 15-20. The Long Branch Town Council has sanctioned the use of Ocean Drive for half-mile and quarter-mile straightaway races on Monday, August 15, and longer races will be held on the following Wednesday and Thursday at the Elkwood trotting track, Long Branch. The week will wind up on Saturday, August 20, with a floral parade. This feature will be reviewed by the Governor of New Jersey, Mayor McClellan of New York and other public men.

But this is not all. There will also be an automobile show in the West End Casino, Long Branch. This building, which adjoins the West End Hotel, is 100 feet long and 80 feet wide, and is said to be well adapted to this purpose. No admission fee will be charged, but invitations will be sent out, and admission will be by ticket only. Exhibitors will be charged for the space they occupy, and Mr. Morgan anticipates that the place will be well filled. Arrangements for the show were made after consulting with the Show Committee of the National Association of Automobile Manufacturers.

BUFFALO'S TWO-DAY PROGRAM.

Entry blanks have been issued for the two-day race meet to be held at Kenilworth track, Buffalo, August 12 and 13, by the recently organized Automobile Racing Association. Entries for the meet close August 8 with D. H. Lewis, manager, 110 Broadway, Buffalo. Following is a list of the events scheduled for the two days:

Friday, August 12.—Ten miles, for machines of any motive power, 881 to 1,432 pounds. Five miles, for machines of any motive power, 551 to 881 pounds. Five miles, for touring cars, full road equipment; three passengers in addition to operator. Five miles, for Ford automobiles; full road equipment; regular stock models; one passenger. Five miles, for Cadillac automobiles; full road equipment; regular stock models; one passenger. Five miles, for Oldsmobiles; full road equipment; regular stock models; one passenger.

Saturday, August 13.—Five miles, for Franklin automobiles; full road equipment; regular stock models; one passenger. Five miles, for Pierce cars; full road equipment; regular stock models; one passenger. Five miles, for Ramblers; full road equipment; regular stock models; one passenger. Fifteen miles, *free-for-all*; machines of any motive power, from 1,432 to 2,204 pounds. Five miles (Great Buffalo Handicap), for cars owned in Erie and Niagara counties, with full road equipment; regular stock models; one passenger in addition to operator. Handicap limit, three-quarters of a mile. There will also be special match races and record trials.

One of the principal races will be a five-mile free-for-all, without restrictions as to weight, horsepower, motive power or condition, for the Diamond Challenge Cup. In addition to the foregoing events there will be stock car races at five miles for Haynes-Apperson, Stevens-Duryea, Thomas and Queen automobiles and Orient buckboards, all to have full road equipment and to carry one passenger in addition to the operator. There will also be a five-mile motorcycle race. Prizes in all events are silver trophies, valued at \$100, \$50, \$35 and \$25.

INDUSTRIAL

HAS A WOMAN MANAGER.

Ohio Motor Car Company's New Garage Planned by Mrs. Post.

Special Correspondence.

CLEVELAND, July 30.—The Ohio Motor Car Co. recently increased its capital stock to \$100,000, and filed an amendment to its charter, authorizing the handling of stationary, marine and portable gas engines. This company occupies one of the largest and best equipped garages in the central west. It embraces the ground floor and basement of a large building on Huron street, near the corner of Erie, close to the retail shopping and office building district.

The front portion of the ground floor is used as a salesroom, measuring 44 by 60 feet. Samples of the Stearns gasoline, Columbia gasoline and electric and the Cadillac gasoline cars, for all of which the company is local agent, are arranged in an orderly way according to price. Ad-

the various departments of the establishment.

Distinct from the repair shop is the battery room and electrical department. Stewart Rhodes, who is in charge of this department, was formerly with the National Motor Vehicle Company, and is an expert. Batteries are renewed and rebuilt, and motors and controller parts are repaired.

The entire management of the affairs of the Ohio Motor Car Company is in the hands of Mrs. M. A. Post. When the company was formed about two years ago she was interested in it in a financial way, but the original management was not entirely satisfactory, and Mrs. Post, who had experience in other lines of business, decided to take the management into her own hands. She has thoroughly mastered not only the management of the business, but has learned the technical details of the various types of machines on the market, and is in position to discuss the merits of their mechanical features in an intelligent manner.

CHURCH'S LOS ANGELES GARAGE.

Norman W. Church's garage at 116-118 East Third street, Los Angeles, Cal., is a new two-story building, completed and occupied last January, and has a frontage

in the firm name of Church & Crippen, but Mr. Church bought out his partner's interest two years ago and has built up a business that last year aggregated a quarter of a million dollars. He now has the agencies for the Peerless, Stevens-Duryea, Knox and Cadillac, and employs seventeen men, including demonstrators and first-class mechanics, several of whom were taken from the eastern factories where the respective machines are built.

GARAGES AND IMPROVEMENTS.

ANDERSON, Ind.—Clark & Beach have opened an automobile garage at Fourteenth and Meridian streets.

ZANESVILLE, O.—An automobile repair shop is now being conducted by Fritz Brothers on Sixth street.

TRENTON.—Walter Richards has just occupied a new two-story brick structure 40 by 95 feet, located in East State street, and will conduct a fully equipped and commodious garage conveniently located in the heart of the city.

COLUMBUS, O.—The Oscar Lear Automobile Co. now has a fine garage at the corner of Fourth and Gay streets, where the Packard, Winton, Peerless, Cadillac and Wav-

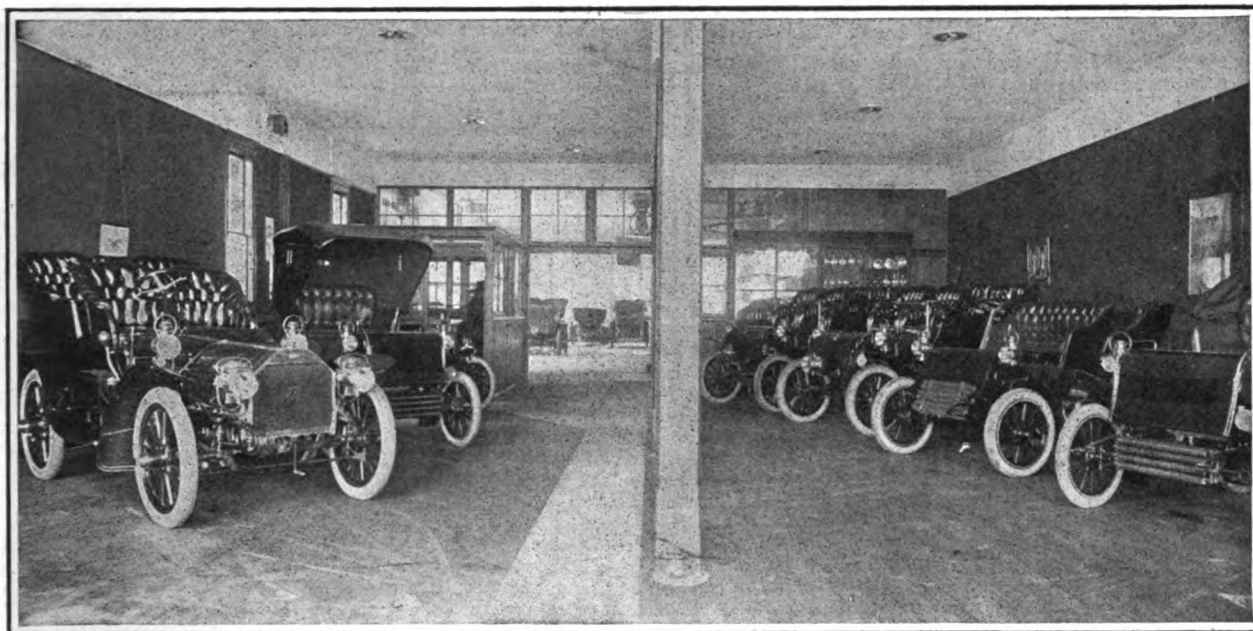

UP-TO-DATE GARAGE BUILT AND OCCUPIED IN LOS ANGELES, CALIFORNIA, BY NORMAN W. CHURCH.

joining the salesroom is a large general office with private offices opening off at the side; also a handsomely furnished waiting room for women, planned especially for women patrons who drive downtown to the theatre or to go shopping.

Between the salesroom and the large garage and storage room in the rear is an electric elevator large enough for the biggest touring car and capable of handling 6,000 pounds.

In the basement are two large rooms for storage, each having washing stands. Another room is devoted to general repair work and assembling, while in a fourth is the machine shop. This is equipped with lathes, planers drill presses and other tools necessary for performing almost any kind of repair work. In this room there is also a 35-horsepower gas engine direct connected to a 22-kilowatt generator which supplies current for all lighting and power and furnishes current for charging the batteries of electric vehicles. There is a smaller gas engine connected to a pump that maintains pressure in a large air tank, from which pipes for inflating tires lead to

of 65 feet. The salesroom is 65 by 40 feet. This room is always quiet and clean, as there is no passing of used cars through it to the garage and repair shop. This is accomplished by having provided on the outside of the building a 14-foot asphalted driveway leading back to an elevator to the second story, where the storage space for "boarders" and the repair shop are located. The boarders' department is 40 by 90 feet, in the front, and the repair shop at the rear is 40 by 150 feet. The elevator is electrically operated.

Compressed air for tire inflating and for cleaning purposes is on tap at many places throughout the building. The gasoline is stored in Bowser underground tanks, from which it can be pumped to the storage room and repair shop. The salesroom is made attractive by wainscoting and pictures of automobile subjects. The accompanying engraving shows the first floor show room.

Mr. Church, proprietor of the establishment, is the pioneer dealer in gasoline vehicles in his territory, having had the agency for the Oldsmobile for the last three years. At that time the business was

erley are handled. On the first floor there is an abundance of storage space and on the second floor the general repair shop is located. The manufacturing department occupies the third floor. The building is well lighted and was built especially for the business. Mr. Lear has a fine charging board and will install a generating plant to furnish current for this as well as for power.

N. A. A. M. MEETING IN N. Y.

A meeting of the National Association of Automobile Manufacturers was held on Tuesday, August 2, in New York, but owing to the absence of the President, Windsor T. White, but little business was transacted. The action of the Show Committee in the arrangement of show dates was ratified. The schedule of dates was given in THE AUTOMOBILE for July 2. It was decided to appoint a committee to confer with a similar committee from the Motor and Accessory Manufacturers' Association on matters of mutual interest. Other matters, including the consideration of show rules, were held over until the September meeting.



Six hundred automobiles have been registered with the Secretary of State at Des Moines, Ia.

Clarence Osgood, of Washington, D. C., has returned home with his family from St. Louis in his Olds tonneau. The family made the trip to and from the World's Fair in their automobile.

An automobile repair station has been opened at 110-112 West Georgia street, Indianapolis, Ind., by the Stutz Automobile and Repair Company. While repair work will be the specialty, the Schebler carbureter will be handled as well.

A movement has been started by enthusiasts of Newport, R. I., to hold an automobile parade in that city in the near future. The committee on improvements, recently appointed by the business men of the city, will take the matter in charge.

The Auto Traffic Company, of Pittsburg, has put in operation its automobile passenger service on the Butler plank road. Three busses are now being used, running every thirty minutes from the end of the car line out the plank road beyond Greensburg.

A petition signed by residents in the Yosemite Valley, Cal., has been presented to the Board of Commissioners of Yosemite Valley, requesting that automobiles be excluded from the roads of the Valley, so long as they constitute a menace to life and safety.

In the recent automobile races held in Halifax, N. S., R. Paterson, with a 1904-model Stevens-Duryea, was awarded a medal for the championship of the Maritime Provinces. The races were run on a half-mile track, and the time for five miles was 10:06.

David R. Francis, president of the Louisiana Purchase Exposition, is an ardent automobile enthusiast, and is watching the St. Louis tour with interest. He is also a good roads advocate and favors the endurance run because of what it will do for the betterment of our highways.

The first arrest under the new automobile ordinance of Jacksonville, Fla., was that of Leonard C. Moore, secretary of the Florida Automobile Club, charged with running his machine at a greater speed than twelve miles an hour, the maximum allowed within the city limits.

The auto-boat *Vingt-et-Un*, built through-out by Smith & Mably, New York, has won in each of the five races in which she has been entered, and the builders state that she will be entered in every race to which she is eligible during the boating season. Her best speed was 22.45 miles an hour.

J. H. Bonday, who has completed a trip from Baltimore to St. Louis in his 1904 Winton car in fourteen days, averaging a daily run of 100 miles, reports no accidents and only two punctures. He has shipped the car to Denver for Samuel Cupples and D. A. Milligan to use in a mountain trip.

The most complete exhibit of storage batteries ever made is made at the St. Louis Exposition by the Electric Storage Battery Co., of Philadelphia, in Section 20. Electricity Building, where are shown Chloride Accumulators for electric automobiles, for car lighting, for central station lighting and

power, for railway service, for isolated lighting and power, for telephone and telegraph and for laboratory service.

Every preparation is being made by the St. Louis garages to take care of the machines of the tourists upon their arrival next week. A new wing 125 by 54 feet has been added to the Halsey garage, and the A. L. Dyke Supply Company has put a ball-bearing turntable in the machine shop in the rear of its salesroom. All the garages report steady sales to Western buyers.

The first automobile tour from San Francisco to the Nevada mining town of Tonopah was recently made by Harry A. Lemmon, of San Francisco, covering the distance in four days. The route taken was by way of Tallac, Lake Tahoe, Carson City and Soda Springs, scaling the 6,900 feet ascent to the mountain summit. The trip was a rough one, but made without a mishap.

The Smith & Mabley auto-boat *Challenger* which was sent to England to compete for the Harmsworth cup, has an official record of 26 1-2 miles an hour, while the smaller Smith & Mabley launch, *Vingt-et-Un II.*, which has one-half the power of the *Challenger*, travelled at the rate of 23.83 miles an hour for twenty nautical miles at the Atlantic Yacht Club races on Saturday, July 30.

A peculiar accident happened to an automobile in Wilmington, Del., a few days ago. George H. Ward, proprietor of a local plumbing establishment, was driving his machine cautiously along King street, one of the principal business thoroughfares, and just as he was about to cross the street car track behind a car, the car started backward and ran Mr. Ward down, badly damaging the machine and injuring the occupant.

A new automobile journal has made its appearance, hailing from Kansas City, Mo., bearing the name of *Motors and Motoring*. It is to appear monthly, the first number being the July issue, and containing some breezy reading matter, served up with true Western energy and "go." The legislative craze, touring, automobile troubles, garages, motorcycles and technical matters are dealt with, as well as current news and a lot of interesting items covering every phase of automobiling.

Following the application of the Lackawanna Motor Company, of Buffalo, for voluntary dissolution last week, and the appointment of William C. Carroll as receiver, a petition was filed by creditors in the United States District Court last Friday, asking that the company be declared an involuntary bankrupt. U. S. Judge Hazel has appointed Mr. Carroll receiver for the company on the bankruptcy petition and a meeting of creditors is to be held soon.

A handsome metallic sign about 12 by 18 inches in size has been put out by The Diamond Rubber Company, advertising Diamond "Motor Tires." It does not say whether the tires are for boat motors or for automobile motors, but in either case they are certainly an innovation. The sign is really a very attractive one in color and design. In a white diamond in the center there is a large reproduction of a section of an automobile wheel rim and detachable tire. It would make an attractive wall decoration for a garage or office.

A special building is being erected by the B. F. Goodrich Company, of Akron, O., to be used exclusively for the housing of the automobiles owned by the officers and some of the employees of the company. A man will be placed in charge of the building who will clean, oil and generally care for them. It is thought that more cars are owned by the officers and employees of this company than by those of any other single concern in the country.

With \$35,000 in gold, C. P. Cole, president of the Lancaster, O., bank, made a dash in an automobile from Columbus to Lancaster a few days ago, arriving in time to prevent the bank from closing its doors in the face of a run. Hearing by telephone of the trouble, Mr. Cole secured the money from a Columbus bank, but missed his train. He hired an automobile from a Columbus dealer and with I. F. Kieseewetter made the run of forty miles in one hour 28 minutes.

Tours to New England are becoming popular with Philadelphia motorists. Rodman Griscom, of Haverford, a pretty Quaker City suburb, is touring to Watch Hill and Narragansett Pier, R. I. Samuel Heebner, of Chestnut Hill, will spend a fortnight on a trip through New England, stopping en route in New York City and Boston. William Dick, of Dick Bros. & Co., will take in New York City, Narragansett Pier and Boston in a ten-day jaunt, while H. Bartol Brazier, secretary of the Automobile Club of Philadelphia, has just returned from a two-weeks' trip to Kennebunkport, Me.

Arrangements are being perfected for a four-days' summer carnival to be held at Spring Lake, N. J., August 17 to 20 inclusive. The program as now planned will include an automobile parade and races, golf and tennis tournament, coaching party, aquatic sports and fireworks, closing with an automobile dinner and grand ball at the New Monmouth and Essex and Sussex hotels. Those in charge of the arrangements include some of the most prominent citizens. Efforts have been made to interest automobilists all along the coast from Point Pleasant to Long Branch in order that a large entry list may be secured. A small entry fee has been fixed and suitable prizes offered in the several events. Machine owners desiring to enter this meet can obtain full particulars by addressing Loren R. Johnston, Essex and Sussex Hotel, Spring Lake.

A certain New York city policeman is strongly of the opinion that chauffeurs have no sense of gratitude. The man with the club found an automobile on Park avenue at 166th street, about 5 o'clock one evening, and, seeing no one in attendance except a flock of children who were doing the usual stunts with the horn, decided that the machine had been left to its fate and mounted guard over it. It was a beautiful study in still life. After a while, however, the preserver of the peace wearied of his job and sent for a patrol wagon to haul the automobile to the police station, which was done, and the cop's mind was easy once more. Along toward 10 o'clock an excited chauffeur blew into the station demanding an explanation of the removal of his car, which he had just left "temporarily" while he got some repair materials to fix a slight break. And even when told all about it he failed to see that the police had done him a favor.

THE AUTOMOBILE

WEEKLY

NEW YORK—SATURDAY, AUGUST 13, 1904—CHICAGO

10 CENTS

FINISH OF 3,400-MILE NON-STOP RUN.

ONE of the most remarkable demonstrations of the possibilities of the automobile terminated Tuesday morning, when F. A. La Roche stopped the engine of his Darracq car after it had run continuously for fifteen days, traveling from New York to St. Louis and back. The performance broke all non-stop records

across the Tottenville ferry to Perth Amboy. On top of the hill from the ferry the travel-stained car was seen with Mr. La Roche and H. H. Everett, one of his observers. They had arrived from Philadelphia some hours earlier and were awaiting the arrival of the party and of the especially chartered ferry boat. The

organization. On another special ferry boat they went from Stapleton to New York, where they drove up Broadway and Fifth Avenue to the A. C. A. clubhouse, where, at 11.44 a. m., the motor was stopped.

The distance traveled by the machine was about 3,400 miles and the total time taken for the round trip was fifteen days two



LA ROCHE AND PARTY IN THE EXPOSITION GROUNDS AT ST. LOUIS, THE TURNING POINT IN THE LONG NON-STOP RUN.

by more than 1,000 miles, and incidentally showed that there are no roads impossible to an automobile in the hands of a skillful operator.

Early on Tuesday morning a party of Mr. La Roche's friends and newspaper men left New York in two machines to meet him. They went over to Staten Island and

latter was necessary owing to the recent enforcement of the law requiring all machines to stop their engines while on public ferries.

After crossing the Kills the party went to the Columbia Fishing Club on South Bay, where they were entertained at breakfast by R. R. Debacker, president of the

hours. The car showed the effects of its experiences over the rough trails in Ohio called roads, the body being covered with mud, but on the ferry over to New York the motor ran smoothly and quietly. Before starting on the trip switches had been arranged for different sets of batteries so that they could be quickly changed. The

relief cocks on top of the cylinders were also removed and spark plugs inserted in their places so that when, as occurred many times during the run, one or another of the cylinders was found to be missing, the wire would be removed from the regular plug and attached to the plug in the relief cock hole.

The route followed to St. Louis was the A. A. A tour route and the return by way of the old National Highway through Columbus, Pittsburg and Philadelphia. With the exception of several almost impassable stretches over the Alleghany Mountains La Roche declared the latter route to be far superior to the northern one. On his arrival home, like all long distance travelers, La Roche had difficulty in remembering various places passed through. Near Java, Ohio, he had the worst experience of his trip, the road for miles being nothing but piles of slippery lumps of clay and rock, the machine at times being almost on its side, sliding and bumping over places where it would be impossible for a horse driven vehicle to go. At another place where Norris Mason, his observer, had to arouse a farmer out of bed to obtain road directions, and came near being shot as a burglar, the party after traveling for five hours, found themselves back at the same farm but on the other side of the buildings.

One of the most surprising experiences of the trip was the manner in which the Michelin tires with which the car was fitted held up. Extra tires had been sent to meet the party in St. Louis, beside the extra set carried on the machine, but on the whole trip it was necessary to replace only one tire, the shoe of which was cut by a broken bottle, causing the inner tube to blow through. The front tires were not touched, it is asserted, from start to finish, it not even being necessary to blow them up.

During the trip La Roche alternated on the car with Lieutenant Le Blanc, of the Brooklyn navy yard, the observers being Norris Mason and H. H. Everett. Mr. Mason's report is an interesting summary of the trip. Following is a summary:

RECORD OF ARRIVALS AND DEPARTURES IN PRINCIPAL CITIES.

City.	Arrived.		Departed.	
New York City.....			July 25	9:44 a.m.
Peekskill.....	July 25	12:24 p.m.	July 25	12:30 p.m.
Poughkeepsie.....	July 25	3:07 p.m.	July 25	3:22 p.m.
Hudson.....	July 25	6:02 p.m.	July 25
Albany.....	July 25	9:00 p.m.	July 26	3:10 p.m.
Syracuse.....	July 27	3:05 p.m.	July 27
Buffalo.....	July 28	10:55 a.m.	July 28	10:38 p.m.
Cleveland.....	July 28	10:15 p.m.	July 30	12:05 p.m.
Toledo.....	July 29	10:50 p.m.	July 31	5:45 a.m.
South Bend.....	July 31	4:50 a.m.	July 31	3:30 p.m.
Chicago.....	July 31	10:50 a.m.	Aug. 3
Bloomington.....	Aug. 1	12:13 a.m.	Aug. 4	12:30 a.m.
Springfield.....	Aug. 3	7:30 p.m.	Aug. 4	7:00 a.m.
St. Louis.....	Aug. 3	12:00 p.m.	Aug. 4	4:00 p.m.
Terre Haute.....	Aug. 4	6:30 a.m.	Aug. 5	11:00 a.m.
Indianapolis.....	Aug. 4	2:00 p.m.	Aug. 8	11:35 a.m.
Richmond.....	Aug. 5	11:00 a.m.	Aug. 8	11:44 a.m.
Columbus.....	Aug. 5	11:00 a.m.
Pittsburg.....	Aug. 8	11:35 a.m.
Philadelphia.....	Aug. 8	11:44 a.m.
New York City.....	Aug. 9

WHITMAN STARTS EAST.

Transcontinentalist Begins Second Ocean-to-Ocean Trip at 'Frisco.

Special Correspondence.

SAN FRANCISCO, Aug. 1.—L. L. Whitman, of Pasadena, Cal., who made the transcontinental trip last summer in 73 days in

worth, Nev., and for about two or three miles near Winnemucca, in the same State. Including equipment and supplies, the car weighs 1,400 pounds, to which is added a combined weight of 332 pounds for the two men. This is the first attempt to make the run in an air-cooled machine, and Mr. Whitman stated this afternoon that his greatest interest is to discover how this type of car

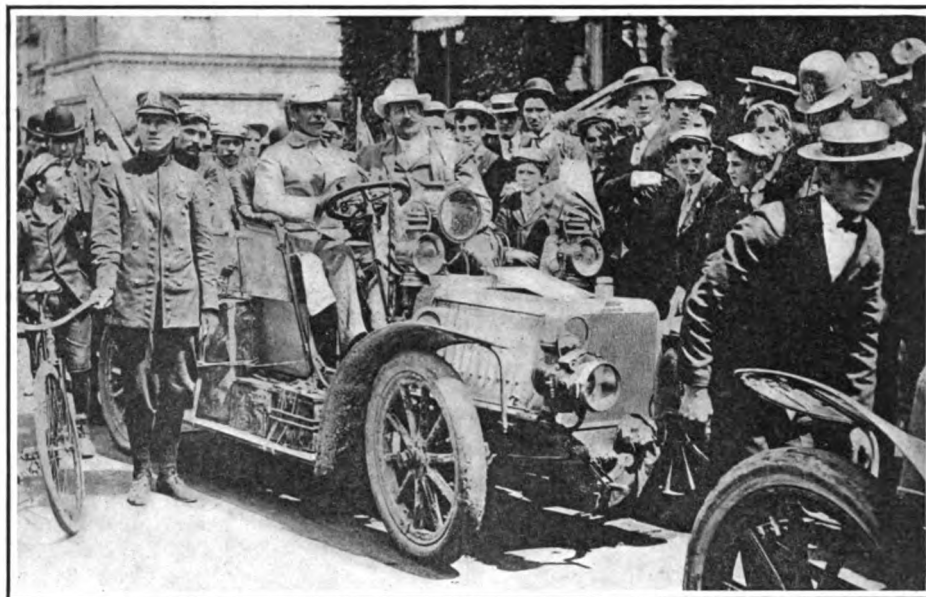

END OF MOTOR NON-STOP RUN AT A. C. A. CLUBHOUSE, NEW YORK, AUGUST 9.

an Oldsmobile, started at 4 o'clock this afternoon in a Franklin in an attempt to break the San Francisco-New York record of 61 days, now held by Tom Fetch and the Packard. Mr. Whitman is the first driver to make a second attempt at the ocean-to-ocean tour, and has the advantage of his former experience. He is accompanied by C. S. Carris, of Syracuse, as mechanic. They carry with them one extra tire, three inner tubes, six batteries, ropes to wind round the tires and an axe. Last year Whitman took with him strips of canvas to lay down over stretches of sand, but he says that these were needed in only two places,—for a distance of about five miles near Wads-

will stand the tedious drive over the hot sands through Nevada and Utah.

Thus far only three machines have made the run from San Francisco to New York. The record of 61 days is held by the Packard. The two other cars which have completed the tour are Dr. Jackson's 20-horsepower Winton and Whitman's Oldsmobile. In his run last year Mr. Whitman ran from California to Maine, his cyclometer reading 4,500 miles. He started July 6, and of the 73 days was delayed for nine days in one stretch at Omaha by floods in Nebraska.

The route to be followed this time will vary but slightly from that of last year. Speaking of the route to be taken, and of his trip generally, Mr. Whitman said yesterday:

"The route follows rather closely the Southern Pacific railroad line from San Francisco to Ogden, then the line of the Union Pacific to Laramie and Denver, and along the Platte River to Omaha. Crossing the Missouri River we will make for Des Moines and Cedar Rapids, and cross the Mississippi River at Clinton or Davenport, thence to Chicago and eastward through South Bend, Toledo, Cleveland, Erie, Buffalo, Albany and down the east bank of the Hudson to New York City."

A Party of automobilists recently toured from Oregon to Los Angeles in an automobile, carrying with them a complete camping outfit and making night stops where time and place suited them.

FINAL STAGES OF THE ST. LOUIS RUN.

Tourists Enter Chicago in Triumphant Procession Escorted by Chicago Automobile Club Members and Continue Journey to Their Destination.

Special Correspondence.

CHICAGO, Aug. 7.—Leaving Cleveland Wednesday morning, some starting as early as 4 a. m., the run to Toledo was found to be a comparatively easy one, although the distance was a good 100 miles, some say twenty miles over. Luncheon on Wednesday was scheduled for Norwalk, and "Colonel" Sprague had worked up the hotel keeper to such a pitch that it proved to be one of the finest meals the party has yet partaken of. More tourists stopped for lunch that day than have sat down together for a noon-day meal since the run started from New York.

There have been the same minor troubles experienced during the past week that characterized the run of a week ago, yet the tourists, now that Chicago has been safely reached, feel confident that they will soon feel the bumps of the St. Louis car tracks beneath their tires, and are cheering up wonderfully. The going, too, since there have been no further signs of rain, has on the whole been fairly smooth, and no more letters condemning roads have been sent in to the governors of the States passed through since leaving New York.

Of racing, the writer can say little, as his car is geared

for touring and twenty-five miles an hour seemed pretty good touring speed until we started on this tour. There are cars that pass us traveling two feet to our one, but there are a few cars that have found we can run around, even if geared low. We have not caught the racing fever, but we would give our next month's income if our front sprocket had four—yes, even three—more teeth in it.

I thought we had some dust on the first trip to St. Louis and return, but have found out that we did not know what dust was at that time; we do now. Formerly it was only the dust our own car raised. now it is the dust from forty other machines intermingled with ours. Two machines in the tour are equipped with the Brown dust guards. One other machine has an improvised dust guard.

We have used up six pair of auto goggles since we originally set out on this St. Louis touring business, but at no time have

we felt the need of goggles as we do at present. It isn't the flies and bugs that bother us now, but the dust. When we overtake a slower machine we take its dust for from one to five miles before we have an opportunity to go by. If a faster machine overtakes us we are obliged to take its dust until it gets out of sight.

It is amusing to note the signs appearing on the different cars participating in this run. When the machines left New York on July 25 there were signs on only two of the cars—ours with signs on either side reading: "New York to St. Louis," and the Darracq, driven by La Roche, bearing a huge sign on the tonneau door telling about the non-stop run it was engaged in. At Albany, when the Boston contingency

thinking up signs to be added just before entering the World's Fair city.

Early morning starts are much in order even yet, for when cars of the same power are driven by operators of equal experience it is the car that starts first that is first to reach its destination and get the most attention in the newspaper story of the day's arrivals. Among the early starters each morning is J. M. Waters and his chauffeur Gretchel, resulting in the Panhard being pretty favorably known all along the line. The peculiar hollow exhaust of the Panhard can be heard on the still morning air for over a mile.

The tourists were much surprised to find at South Bend a hotel—the Oliver—as good as they had been accustomed to in their own

home, whether it was Boston, Philadelphia, New York, Buffalo or Cleveland. Mr. Oliver, the millionaire owner of the hotel, and incidentally of a large slice of the city of South Bend, including the famous plow and wagon works that bear his name, was down in front of the hotel to see the automobilists start off for Chicago on Saturday morning. It is doubtful if any one among the tourists gave the little old phaeton, or its sole occupant, a little old man in very



J. M. WATERS STOPS DWIGHT HUSS TO BORROW FEED FOR HIS PANHARD MOTOR.

came in with several cars fresh from their hill climbing triumphs in the White Mountains, the Pierce Arrow bore an announcement: "Mt. Washington to St. Louis." Then the Haynes-Apperson came out with the sign: "Gold Medal Winner White Mountain Endurance Run;" and the White steamer driven by Webb Jay put out a sign on the tonneau: "This car won first place in the New York-Pittsburg Endurance Run." The Elmore then added another line of lettering, making the sign read: "Second Trip, New York to St. Louis." The Franklin air-cooled then appeared with a sign reading: "We take no Water." Mr. Glidden had a sign made, reading "Arctic Circle," which he tacked on the rear of the big Napier, and when the little Covert joined the procession at Lockport, Mr. Hoag had a "Baby" tacked on the rear of the seat. Other cars carry signs reading: "New York to St. Louis," or "Boston to St. Louis," while still other participants are

ordinary clothes, wearing a faded straw hat and blue calico shirt, a passing glance. His ancient looking horse and wagon remained at the curb until the last of the tourists had left.

Frank X. Mudd and about two dozen good fellows from Chicago Automobile Club ran down to South Bend to act as an escort to Chicago. The bulletin Friday night said that the official start would be made at 7:30 a. m., that dinner would be partaken of by the crowd at Valparaiso and that those arriving in Chicago early should wait in Jackson Park until 4 o'clock in the afternoon, when all would invade the city in a body, escorted by the members of the Chicago Automobile Club.

Everything seemed to go wrong from the start. Instead of waiting until 7:30 o'clock many left before 5:30 a. m., among them a number of the members of the Chicago club. With this big gathering of machines on the road racing couldn't be stopped,

and soon they were off in full tilt. R. A. Kent and R. W. Sturtevant, in a 1903 Cadillac, were among the Chicago contingent that started early, and in taking a curve at the foot of a steep, sandy hill, their machine went crashing over a fifteen-foot embankment, turning completely over twice in its descent to the bottom. Kent, who was at the wheel, was pinned in and went over twice with the machine, breaking his left wrist and otherwise injuring himself. Sturtevant, who was in the tonneau, escaped with a few bruises. Three hours later a crew from La Porte was seen hauling out the wrecked car. Kent, while awaiting a train for Chicago, said: "I don't mind getting hurt, but I do so hate to take the train back home."

When arriving at Valparaiso we naturally expected to find the party awaiting luncheon as planned, but there was no one there with the exception of the Haynes-Apperson crew, with Birchwood frantically telephoning back to South Bend for the watch he had left under his pillow. Mr. and Mrs. Gillette, in the Pope-Hartford, came up a few minutes later. It was only 11:15 a. m. and the landlord said he would not have dinner until 12 o'clock, so we decided to move on. The trail of confetti was very indistinct and the most important turns were unmarked, which occasioned considerable delay and more or less wrong going.

Just west of Valparaiso we came upon another wrecked automobile lying bottom upward at the side of the road. It was a big Winton which had left early in the morning with the object of establishing a record between South Bend and Chicago. The car was manned by R. S. John and E. F. Meyer, of the Chicago Automobile Club, who had left the Oliver at 4:30 a. m. Neither man was injured beyond a few scratches.

The city of Valparaiso was crowded,

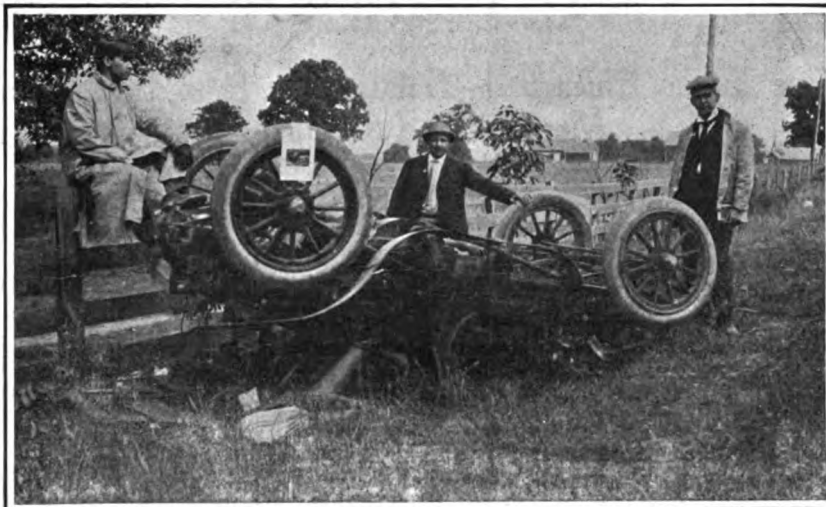

WINTON CAR OVERTURNED NEAR VALPARAISO OWING TO RECKLESS DRIVING.

fully 500 farmers' rigs being tied around the town square, the farmers having come for miles to see the automobiles come in, as Valparaiso was advertised as the noon stopping place.

R. H. Johnson and E. S. Morton, driving a Peerless limousine, joined the run at Cleveland. The enclosed car is called by the natives all along the line "the house on an automobile." The car has 24 horsepower and although built for slow driving shows considerable speed.

Members of the Chicago Automobile Club to the number of 400 were awaiting the arrival of the tourists at Jackson Park, and at 3 o'clock the cars were lined up according to their serial numbers and the parade to the Auditorium started. Large crowds lined up on the walks on either side and cheered the tourists as they passed along. The line of march led down Michigan boulevard, passed the Chicago Automobile Clubhouse, which was profusely dec-

orated with flags and bunting, through several of the downtown streets and eventually back to the Auditorium Annex, where it broke up, the tired and dusty travellers going to their rooms at once.

Chicago to Pontiac.

PONTIAC, Ill., Aug. 9.—The run from Chicago to Joliet on Monday morning assumed less the proportions of a road race than at any of the previous stages. The Joliet Automobile Club, about seventy-five enthusiasts in one-quarter that number of machines, ran out five miles to Lockport and met the World's Fair tourists as they came in. The tourists were halted and the entire division came in together, and participated in the dinner prepared by the genial host of the Hotel Monroe. More tourists were seated at this meal than at any other noonday stop on the long run.

The roads from Chicago to Joliet were excellent, and the forty miles could be covered easily in two hours. Great enthusiasm was manifested all along this line, and every youngster old enough to wave one was provided with an American flag, with which he saluted the tourists as they passed. The trail of confetti, while not very distinct in the City of Chicago, was readily followed on the country roads. Horses showed considerable fear at the approaching machines, and more than one tourist was obliged to get out and assist in leading some obstinate animal past his car. The Joliet Automobile and Garage Company opened its garage to the visitors, and there were ample facilities for filling on oil, water and gasoline during lunch hour.

Tire troubles cropped out abundantly in Chicago, and the cars that did not pick up at least one nail while running over the city pavements, especially in the down-town districts, were extremely fortunate. We pulled a three-inch wire nail out of one of our rear tires after running a couple of miles with the tire flat. There were ample facilities at the garage of the Chicago Auto-



CADILLAC THAT ROLLED DOWN FIFTEEN FOOT EMBANKMENT NEAR LA PORTE.

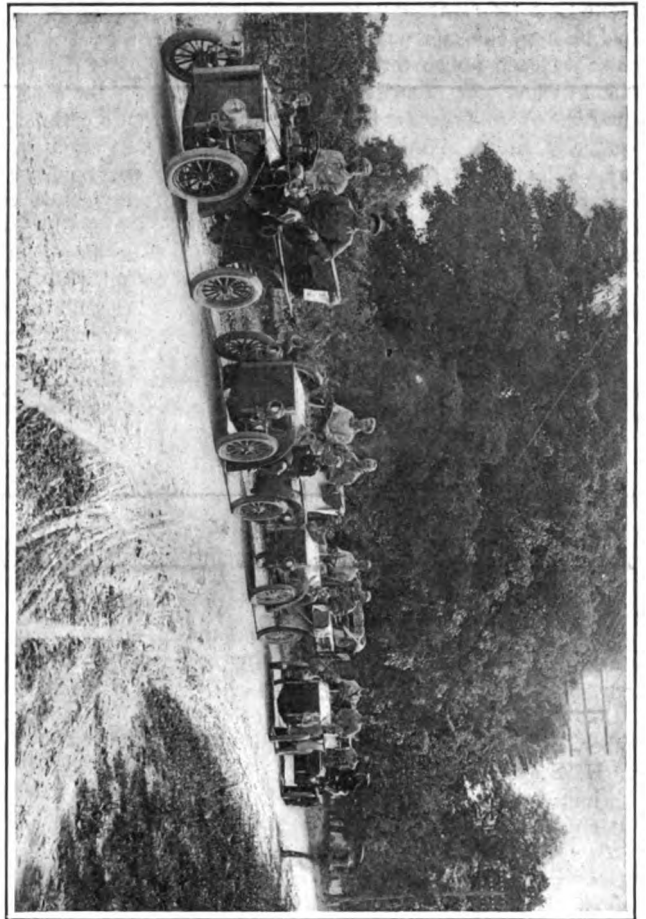

Characteristic Line-Up of the "White Squadron."

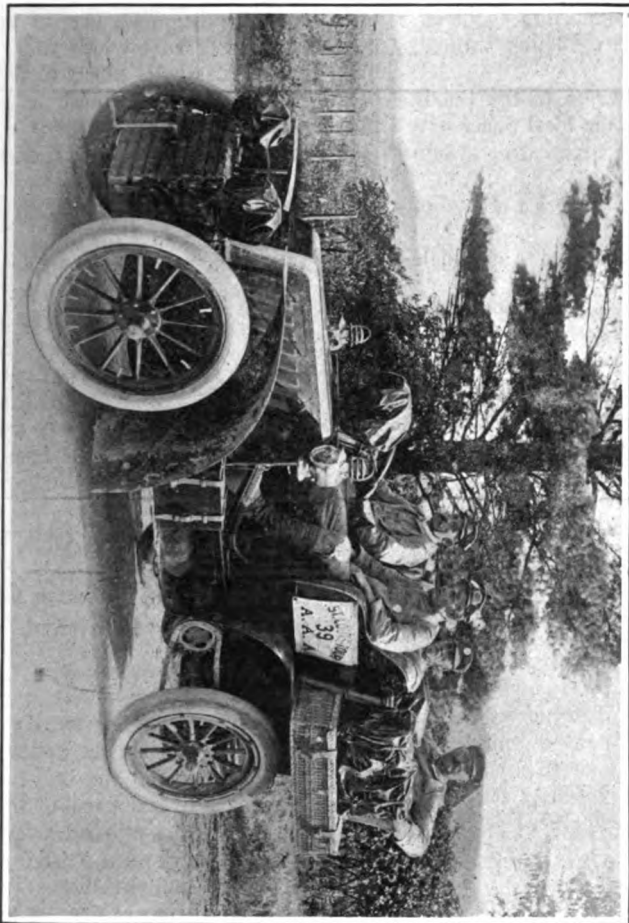

Prominent Amateur Tourists, F. N. Mansons and Party in the Columbia. SOME OF THE NOTABLE PARTICIPATING CARS THAT ATTRACTED UNIVERSAL ATTENTION IN THE TOUR TO THE WORLD'S FAIR.

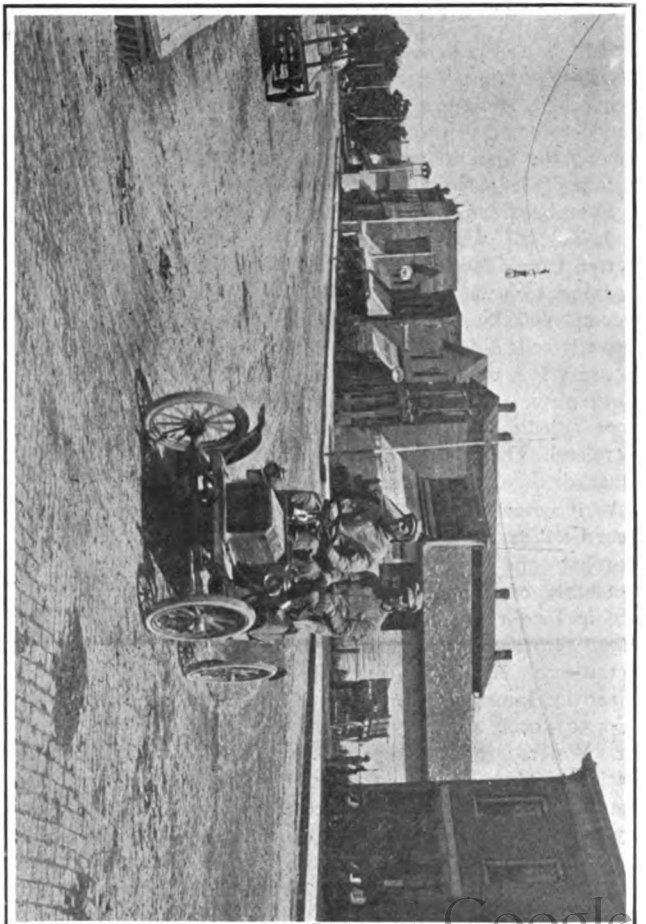

Hoag's Covert "Baby" Taking a Turn in Archbold, Ohio.

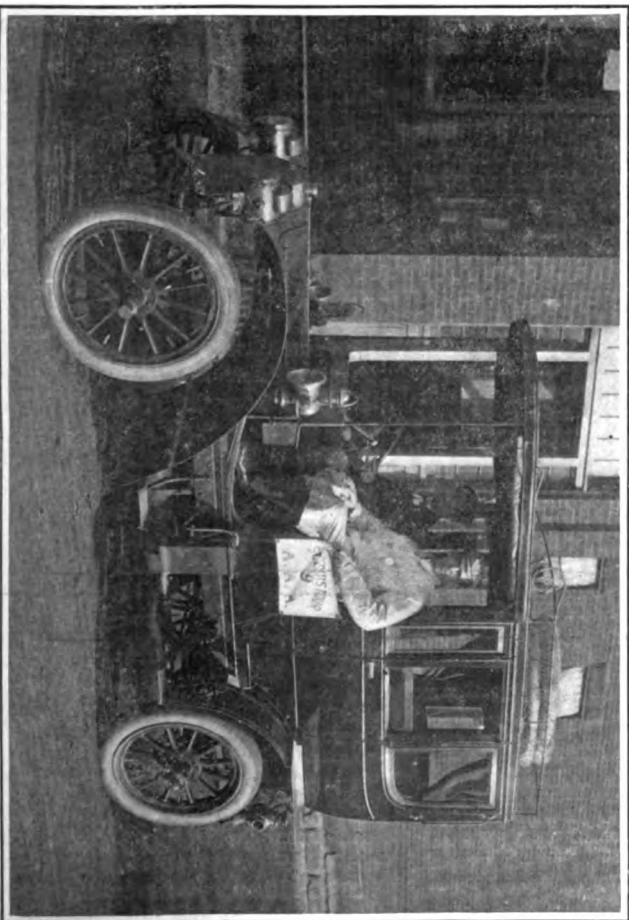

The "House on an Automobile" - Peerless Limousine. Entered at Cleveland. The TOUR TO THE WORLD'S FAIR. ENDED AT ST. LOUIS AUGUST 10.

mobile Club for repairing tires, and we were fixed up in good shape within a half hour.

The Chicago police force was unusually lenient when the tourists, after riding hundreds of miles over indifferent roads, eventually rolled in over Michigan boulevard. Who could resist such an opportunity of throwing throttles open and "letting things rip" just for a minute or two? Greycoat after greycoat turned his back as this or that tourist's car sped past traveling twice as fast as the city ordinance allowed. The same leniency was observed as the tourists left Chicago, wending their way out Jackson and Washington boulevards toward Austin avenue.

The following men have registered for the run from Chicago to St. Louis: John Farson, F. C. Donald, F. X. Mudd, W. G. Lloyd, I. V. Edgerton, J. A. Ellis, W. W. Shaw, Chas. R. Judd, Henry J. Ullman, S. J. Turnblad, F. H. Pietsch, S. S. Gorham, W. J. Wilkins, G. J. Scherer, E. H. Pratt, F. A. Bostwick, A. G. Bennett and George A. Crane. L. A. Wood and B. A. Ledy, of St. Paul; George J. Scherer and S. J. Turnblad, of Minneapolis; O. F. Weber, of Milwaukee; E. B. Jackson and W. H. Stepanck, of Cedar Rapids, Iowa, also joined the party in Chicago, arriving in that city on Sunday afternoon.

PERCY F. MEGARGEL.

SUB-POENAED IN TOLEDO.

Surprise Sprung by Local Manufacturers and Club is Hugely Enjoyed.

Special Correspondence.

TOLEDO, Aug. 4.—The tourists began arriving here shortly after dinner and continued to come in up to 9 p. m. last night. Among the first arrivals were A. L. Pope in Pope-Toledo No. 59, Harold L. Pope, in a Pope-Hartford and H. T. Lesh, in a Pope-Toledo. Mr. Lesh, of Boston, who started from Cleveland at 4 a. m. yesterday morning to scatter confetti at the turns, accompanied by Ralph McClelland, came through splendidly and reached the Boody House a few minutes after 11 o'clock. C. C. Ferguson and R. H. Magoon, driving a Pope-Toledo, also made a fast trip from Cleveland. They are not officially in the run, but made the day's journey for pleasure.

As it neared 1 o'clock the committee to record the arrivals, consisting of President Marshall and Dr. Wagar, secretary and treasurer, of the Automobile Club, and Archie Hughes of the Pope-Toledo company, were anxiously awaiting the arrivals of the cars. At 12.55 p. m. a big Panhard, driven by James M. Waters of New York (No. 50), came snorting up to the entrance. Mr. Waters was accompanied by E. P. Gitchell. They left Cleveland at 6 o'clock yesterday morning and completed the journey of 123 miles in six hours 35 minutes. It was a splendid run and the entire journey was made without an accident. From this time to 9 o'clock last evening, the autos came

stringing in, a number reporting slight accidents, but the majority coming through without any mishaps.

As the machines drew up to the Boody House entrance, one of the local police officers, Val Kujawa, was ready with a subpoena reading:

"The United States of America, State of Ohio, City of Toledo, ss.

"The President of the Toledo Automobile Club to—

"Greeting: For divers and sundry reasons appearing sufficient to us, we command and strictly enjoin you, that, laying aside all matters whatsoever such as bum spark plugs, flat tires, bad roads or short circuits, notwithstanding any excuse whatever, you be and personally appear at Hanner's Farm, in said City of Toledo, on Wednesday, August third, in the year of our Lord, A. D. 1904, at 8 o'clock p. m., then and there to witness whatever we shall elect to do unto you, the same being respite from police, road and roadside trials and tribulations in the way of a dinner given under the auspices of Ye Toledo Automobile Club by Ye Pope Motor Car Company. And this banquet you may nowise omit under penalty of having your rear tires slit, your gasoline watered, your batteries short-circuited, and what more we shall elect to do to you will be a plenty.

"Witness:

(Seal.)

"E. J. Marshall,

"President Toledo Automobile Club,
C. P. Wagar, Secretary."

Officer Kujawa would ask the driver if he had run over a dog or chicken and naturally would receive a negative answer. He would, however, impress upon the receiver the seriousness of their supposed misdeed and while the recipient was reading the subpoena the crowd, which early had gotten onto the idea, would stand ready to laugh. As soon as the driver saw what it meant he would smile and then everyone would yell. It was a clever idea and made one of the hits of the run.

About 7 o'clock the tourists were taken to "The Farm," where a fine dinner was served by the Pope Motor Car Company, under the auspices of the Toledo Automobile Club.

At the conclusion of the dinner speeches of a short and pertinent nature were delivered, after which the guests adjourned to the theater, where a vaudeville bill was enjoyed.

The club presented maps of the roads within a radius of sixty miles of Toledo to each of the drivers and owners.

All of the machines got away this morning on their way westward about 10 o'clock.

PROGRESS OF KANSAS CITY TOURISTS.

Special Correspondence.

KANSAS CITY, Aug. 8.—E. P. Moriarty and Mr. and Mrs. C. C. Cockerill, of Pittsburg, Kan., started from here on the St. Louis tour Saturday morning in two Stevens-Duryea cars. A number of local mo-

torists accompanied them part of the way on the first day's run, which ended about midnight at Marshall, ninety-three miles, the tourists having been much delayed by the heavy travel on the country roads near Pink Hill, where a political picnic was in progress.

They reached Glasgow, Mo., early Sunday evening. A spring on the car driven by Mr. Cockerill broke just as he was entering the town, but it was quickly repaired and the party got away all shipshape this morning. The worst roads they have yet traversed were those in Jackson County, not far from this city. The Missouri River was crossed at Glasgow. The next stop will be at Mexico, probably about noon. They expect to arrive in St. Louis Wednesday.

THE SCOTT ACCIDENT.

Fatal Collision of Big Baltimore Car with Train Narrowly Averted.

Special Correspondence.

PERRYSBURG, O., Aug. 5.—R. B. Scott's party in the huge 70-horsepower special touring car No. 14, had an accident here yesterday that wrecked the car and came dangerously near to being one of the worst and most fatal of the railroad grade crossing accidents that have occurred so frequently of late to automobilists.

The party consisting of Charles S. Scott, of Cadez, O.; R. B. Wausson and "Gus" Behrens, of Baltimore, and Charles Benner, of Cleveland, had met with an accident at Cleveland which caused some delay and was endeavoring to make good time to Toledo, where it would take up R. B. Scott, and proceed on the way westward. By a miscalculation they came through Perrysburg and were making rapid progress. The road leading into Perrysburg makes a turn about 200 feet from the railroad crossing, and as the big machine came bowling down the street the C., H. & D. R. R. fast express train was steaming onto the same crossing. The train does not stop here and was therefore making fast time. It was impossible for the driver of the auto to see or hear the approaching train and until within a very short distance of the track he had no warning of his danger. It was then too late, and although Behrens, who was at the wheel, immediately applied the brakes the momentum forced the machine against the train, which it struck just behind the tender. It was then bumped by the trucks of the coaches successively as they passed until the machine was knocked clear of the track.

Just before striking the train Scott jumped and landed about forty feet away unhurt. The others did not have time to jump. Benner was thrown out and struck against the steps of the baggage car and was hurled back against the auto. He immediately jumped up and declared himself unhurt, although he was afterward found to be badly, though not seriously, bruised.

The other two men remained in the automobile and were only severely shaken up.

The front end of the machine, which bore the brunt of the collision, was very badly damaged. The baggage car was badly splintered and the oil-box covers on several of the trucks were torn off.

R. B. Scott immediately came from Toledo and upon viewing the wreck of his elaborate and costly machine, ordered it dismantled and sent to his shops at Cadiz, O., where it will be rebuilt.

The car was a special machine, built at the shops of Sinclair, Scott & Co., in Baltimore, Md., after the Peerless model, with an engine copied after the Mercedes. The machine, when ready for this tour, cost \$12,000.

R. B. Scott, who is chairman of the Baltimore division of the Tour Committee, went on to St. Louis from South Bend, Ind., where he had invitations to join other members of the touring party. Regarding the collision he said: "Both of the driving

TROUBLE ON SOUTHERN ROAD

Cars in Baltimore Division Suffer from Bad Roads and Hills.

Special Correspondence.

ZANESVILLE, O., Aug. 6.—The National Highway division of the A. A. A. St. Louis tour reached this city on schedule time Wednesday. Only four cars were in the party, the fifth entrant, No. 81, a Pope-Toledo driven by W. D. Allison with two passengers, being reported delayed with tire troubles and a damaged frame near Cumberland, Md.

A number of local automobilists drove east on the turnpike to meet the party. The first car to arrive, at 5:30, was No. 66, White steamer, driven by A. M. Husted, owner, with Mrs. J. M. Husted and W. B. Husted as passengers. This entrant joined the division at Uniontown and left Wheeling at 9:30 a. m. Wednesday. Engine troubles were experienced *en route* and at Cam-

driven by Sam Stone, Jr., owner, with Palmer Abbott passenger, both of New Orleans. These two entrants left Wheeling at 8.45, but were stopped by a seized bearing twenty miles west. The trouble was in the pinion drive shaft. Six hours were lost in taking down the differential and making the necessary repairs. A pleasing (?) incident of the stop was a two-mile jaunt 'cross country to a blacksmith shop for a heavy vise.

Storage was provided for the four machines at Fritz Bros.' garage, where gasoline and supplies were taken aboard Thursday morning.

The first car to get away was No. 48 at 9:30 a. m., with No. 66 following in half an hour. Nos. 25 and 26 were piloted out of town at 11:30 a. m.

The road between Zanesville and Columbus is in bad condition, owing to heavy rains and subsequent neglect, large patches of loose stone and sandstone boulders being exposed, and but few good stretches exist in the entire stage from here to the state capital.

Chas. A. Davis and A. E. Vinton, of the G & J Tire Co., are in the party, making the various stages by train and looking after the comfort of the tourists at night stops.

SOUTHERN SECTION BANQUETED.

Special Correspondence.

COLUMBUS, Ohio, Aug. 6.—The eastern motorists en route to St. Louis over the National Pike arrived in this city Thursday, as scheduled, and were taken in charge by the Columbus Automobile Association and given a good time. In the evening a banquet was served at the Chitenden. The first car to arrive was driven by Hartley Newman, of Norfolk, Va., and with him were Frank Zeigler and Roy Collins.

"We had a good run, but a tough time," said Newman. "Our worst troubles were in crossing the Cumberland Mountains. It was like running up the side of a house. After crossing the ridge we found power unnecessary, but it was difficult to retard momentum. The descent was so steep that we had to get farmers to cut logs and tie them to our machines."

The party remained here over night, resuming their journey Friday morning. It was reinforced by four Columbus machines. One was the 24-horsepower Stearns of William Monypenny, and carried besides himself and his machinist, Mrs. Monypenny, Miss Ethel Monypenny and Miss Eleanor Bryne. The other machines were the big Buckeye 4-cylinder, air cooled, 20-horsepower touring car designed by L. A. Frayer, of this city, and ridden by him; Imperial runabout, built in Columbus, and carrying A. D. Rogers and T. Tom Piccard, and another Imperial carrying Charles O. Howard.

Springfield, the first stop after Columbus, a distance of 48 miles, was reached in 1 hour 38 minutes, Frayer's car leading the party.



MINNEAPOLIS CONTINGENT.—MESSRS. TURNBLAD AND SHERER, THEIR WIVES AND LILLIAN TURNBLAD.

men are experts and I know the accident was unavoidable. I am certainly sorry it happened but consider the escape of the men extremely fortunate. The car was not being run recklessly, but the approach of the train being hidden, and the crossing not having been prominently marked, nor a warning bell having been heard, I hold the driver blameless."

FOUR STARTERS FROM TWIN CITIES.

Special Correspondence.

MINNEAPOLIS, Aug. 6.—Minneapolis and St. Paul are not so well represented in the A. A. A. run to St. Louis as had been expected. Only four machines have left the Twin Cities. The Minneapolis participants are Mr. and Mrs. Swan J. Turnblad and daughter Lillian, and Mr. and Mrs. George J. Scherer. The St. Paul starters are L. A. Weeds and B. A. Leddy.

The party left from here Wednesday morning for Chicago, where they will start with the eastern tourists Monday morning.

bridge, the noon stop, the crankshaft was discovered to be fractured between the high and low pressure engines. A new engine will be installed at Columbus. In spite of the broken shaft the car pulled through in less than six hours net running time.

The second car in was No. 48, Winton, driven by W. B. Saunders, of Philadelphia, with mechanic. Tire troubles in fitting a new casing, nipping an inner tube and having the work to do over held it up until after noon, so a late start was made from Wheeling. By lunching at a country store on sardines and the thirst-producing cracker enough time was saved to get the car through by 6 o'clock, a very creditable performance when the grades and road surface are considered.

Two machines, Nos. 25 and 26, both White steamers, came in at 9:30 p. m. No. 25 was driven by Hart D. Newman, owner, of New Orleans, with Frank M. Zeigler of the same city and J. Roy Collins, of Norfolk, Va., as passengers. No. 26 was

On the Trail of Confetti.

Fifty-Odd Touring Parties Enjoy Good Traveling Over Macadam and Gravel Roads of Northern Ohio and Indiana.

Special Correspondence.

TOLEDO, Aug. 4.—The run into Cleveland was marked by a lively contest between the White "string" and the Royal Tourist entered by A. D. MacLachlan. It was understood that the cars made in any city passed through were to have the privilege of entering their home town first, but neither of the two Cleveland makes was willing to give first place to the other. The result was that the Whites started about 10.30 p. m., and made a leisurely run, meeting Rollin White at Willoughby and getting to the Hollenden, with no effort at haste, about 4.30 or 5 o'clock. They came near losing the honor of first entry by their lack of haste, for Mr. MacLachlan, who started at midnight and did his best to overtake them, actually did so just as they reached the Hollenden, so that honors were even after all.

The party leaving Erie numbered twenty-six cars not one car having withdrawn because of permanent disablement. At Cleveland the party was swelled by a number of new entries, as given in the accompanying list, which includes all the new entries received up to that time. Apparently fully 100 cars will leave Chicago next Monday morning.

The roads between Erie and Cleveland were pronounced by all the tourists fine, with the exception of those entering Cleveland, which were reported the worst, in fact, of the run. They were dry, but they were full of chuck holes a foot or two feet deep. Almost equally bad roads were traversed when leaving Cleveland.

The country between Cleveland and Toledo is nearly level, with occasional woods still uncleared. Grain and corn are the commonest crops, but orchards and truck gardens are also common. The roads in general are dirt, with no stone foundation, and therefore dependent in condition almost altogether on the weather and amount of usage. Of the particular roads traveled by the tourists, those through Elyria and Birmingham to Norwalk were dirt; and from Norwalk through Clyde, and Fremont to Stony Ridge. Nine miles from Toledo, a state macadam road eight or ten years old, is followed. This road is in such poor condition that for long distances the tourists preferred the dirt track at the side.

From Stony Ridge to Toledo is a new macadam road, equal to the best we have yet traveled on. It has been built very recently under a new state aid law quite similar in some respects to New York's. Under this law the abutting property owners on an improved road are assessed more or less according to their distance from the road, up to a total of fifteen per cent. of the whole cost of improvement; the county

pays thirty-five per cent. and the state the remaining fifty per cent. of the cost. The expectation appears to be that the abutting property owners will be able in many cases to make good their contributions by getting contracts for all or certain portions of the work.

In Toledo the tourists were the victims of a genial practical joke devised by the Toledo Automobile Club, under whose auspices the Pope Motor Car Co. gave them a dinner and theatre party at "The Farm," a resort about two miles out of the city. As each car drew up before the Boody House, its occupants were severally served with invitations drawn, folded and sealed in the form of subpoenas. These formidable-looking documents were handed out by policemen, and there were few of the visitors who received them without guilty trepidation, which changed to laughter when they had recovered sufficiently to peruse them. At least one man, on being informed by the officer that he "had a warrant for him," immediately made ready to accompany the "cop" to the police station, without even looking inside the "warrant;" and Mr. Glidden at first refused to receive his, claiming an alias.

The dinner itself, arrangements for which had been superintended by Mr. Lehman of

the Pope Company, was both excellent and substantial. It was served in the bowling alley, which just sufficed to seat the party, and after the good things on the menu had been dispatched a good-humored and slightly noisy crowd filled a block of reserved seats in an open-air theatre adjoining, and lent efficient moral and vocal support to a bill of vaudeville.

But one accident of consequence was reported on the Toledo run. E. H. Wallace, driving Rambler car No. 40, was descending a hill at good speed near North Amherst, when he struck a patch of loose sand near the foot, and the car slewed around and overturned. Mrs. Wallace, who was with him, was thrown some distance, but was not injured. The car was righted with the aid of the men in the White string, which arrived most opportunely; and it appeared to have suffered no injury. Both Mr. and Mrs. Wallace finished the journey in the car, after a couple of hours' rest in Norwalk.

A good deal of indignation was excited among the tourists by flagrant overcharging at two of the garages, the Toledo Motor Car Co. and the Kirk-Hall Co., both of which raised their rates on everything except oil and gasoline. As they gave no notice of their intention until the bills were made out, there was nothing to do except to pay under protest. It was the first time that the tourists had been "held up;" and Albert L. Pope expressed himself as greatly disturbed that it should have occurred in his company's home city, and said that he would do his best to have the matter rectified.

An interesting feature of the country

Entries Received Between Albany and Cleveland.

No.	Car.	Horsepower.	Participants.
9	Peerless Limousine		R. H. Johnson, Cleveland, O.
13	Packard		E. T. Fetch, Erie, Pa.
63	Winton		S. S. Gorham, Chicago.
64	Covert		Harold Hoag, Lockport, N. Y.
65	Winton	24	H. P. Dyer, Cleveland.
66	White Steamer		A. M. Hustead, Uniontown, Pa.
67	Peerless		W. G. Lloyd, Chicago.
68	Stearns	24	I. V. Edgerton, Chicago.
69	Apperson		J. A. Ellis, Chicago.
70	Knox		Swan J. Turnblad, Minneapolis.
71	Austin	16	C. B. Judd, Grand Rapids.
72	Autocar		F. H. Pitsch, Chicago.
73	Pope-Toledo		W. W. Shaw, Chicago.
74	Knox		G. J. Scherer, Minneapolis.
75	Marion	16	Marion Motor Car Co., Indianapolis, Ind.
76	Withdrawn.		
77	Phelps	15	F. W. Richards, of Boston; Mrs. Richards and Walter Killam, engineer.
78	Winton		L. A. Wood, St. Paul.
79	Rambler	16	B. A. Ledy, St. Paul.
81	Pope-Toledo		T. E. Allison, Wallingford, Pa.
86	Oldsmobile		W. J. Wilkins, Chicago.
87	Winton		George T. Thompson, Onondaga, N. Y.
88	Franklin	10	R. P. Lipe, Toledo, O.
101	Pope-Toledo		W. R. Smith, Chicago.
102	Pope-Toledo		O. F. Weber, Milwaukee, Wis.
103	Pope-Toledo		Dr. H. C. Wendel, Cincinnati, O.
104	Winton		J. R. Blakeslee, Jr., Cleveland, O.
105	Peerless Limousine		Collings, Cleveland, O.

about Fremont, Ohio, is the considerable number of oil wells there seen. These wells are not now "gushers," if they ever were. They are connected by pipes of about two-inch size, sometimes eight or ten wells being pumped by a single engine. Several of the tourists who were not in a hurry stopped in this region and inspected the wells before going on.

Upon arriving at the hotel after the "show," each driver of a car was given a large blue-print map of the roads from Toledo to South Bend, Ind., compiled by W. M. Morrison, of Bryan, O., who drove the pilot car between those cities. The map was admirably laid out, with every landmark of importance clearly indicated.

Toledo to South Bend.

SOUTH BEND, Ind., Aug. 5.—As Waterloo is only a small town, and as the roads were in good condition, about half of the tourists determined to go straight through to South Bend and lie over a day. This proved to be an excellent arrangement, and, in spite of the length of the run—about 170 miles—the cars began to reach South Bend before 2 o'clock. The fastest run was made by James L. Breese, who reported the running time of his 40-horsepower Mercedes as six hours ten minutes. For the last seventy-six miles he gave his time as two hours ten minutes, the roads improving towards South Bend. Webb Jay made a fast run in seven hours twenty minutes, being the first to arrive, and Berchwood, in the Haynes-Apperson, reported an average speed of twenty miles an hour from Toledo to Waterloo, including ten miles of bad macadam out of Toledo.

The others to double up on the schedule were Messrs. Johnston, Post, Glidden,

are certainly very different in many ways from those of the East.

Beyond Toledo the tourist gets a taste of the true Western prairie. A few low hills are met with, but for miles and miles only gentle undulations and occasional groves of trees enable one to say that the country is not absolutely level. From the Air Line Junction in Toledo to Butler, Ind., seventy miles, the Air Line branch of the Lake Shore runs as straight as a string between fields of wheat and corn in almost unbroken succession. The roads are laid out on section lines, east to west and north to south, giving the driver an uninterrupted view, sometimes for a mile or two, before a slight bend or undulation of the surface breaks it, so that the speed possible is limited only by the power of the motor. From Toledo to South Bend the course is slightly south of west, and in many places the road lies almost parallel with the railroad. At one such place Mr. Glidden managed to keep up with the Lake Shore Limited for nearly half a mile before a rough place in the road obliged him to slow down.

The larger number of the through highways of northern Indiana, as well as many of the Ohio roads west of Toledo, are gravel roads, the material for which is found in the numerous gravel beds scattered through the State. The gravel in its natural state is mixed with a considerable quantity of sand, and this is spread on the earth road. No stone foundation is made, and the virgin soil beneath the gravel may be clay, black loam, or occasionally sand. Though the loam predominates, there is a great deal of clay, and this in time works up through the gravel, producing a muddy surface, necessitating fresh applications of gravel.

As neither the gravel nor the sand makes mud, the gravel road will stand a deal

the last rain hereabouts, but the gravel sends up enough dust already to give the roads a close semblance of dirt roads. Indeed, of the two the dirt road is distinctly the firmer when both are perfectly dry.

An agreeable feature of both dirt and gravel roads is the absence of "chuck holes."



WHY THE PEERLESS TURNED OUT.

These interesting affairs seem to belong peculiarly to "improved" roads which have fallen out of repair. The natural dirt road is almost wholly free from them, and the gravel road nearly so.

The occupants of none of the cars arriving in South Bend reported trouble of consequence, but James L. Breese appears to have had a close squeak to being smashed up by an express train. He was going at high speed through Goshen, and failed to make a right turn which would have brought him parallel with the railroad without crossing it. When close to the tracks he heard the train, and jammed on his brakes. His car slid in the loose dust, and he had to slacken the brakes, but he fortunately was able to stop with a foot or two to spare, just as the train roared by. Earlier in the day he had taken another right turn at a speed which tore off a front tire and caused the two other men with him to either jump or to be thrown from the car.

The Peerless limousine cars seem to have made a decided hit with the local population along the route of the tour. The idea of a closed automobile seems to be entirely new in most quarters, and this practical demonstration of its capabilities appears to have done much to stimulate popular interest among those seeing it.

South Bend to Chicago.

CHICAGO, Aug. 7.—Between South Bend and Chicago the writer had his first road trial of the St. Louis single cylinder run-about. This little Old Reliable had two forward speed changes by sliding gears, weighed about 1,300 pounds and was rated at 9 horsepower. It was piloted by "Charley" Root, and, while by no means a fast machine—its maximum speed on the level being about twenty-five miles an hour—it managed to demonstrate very well that speed is not everything, for it passed on the road several cars which were a lot faster

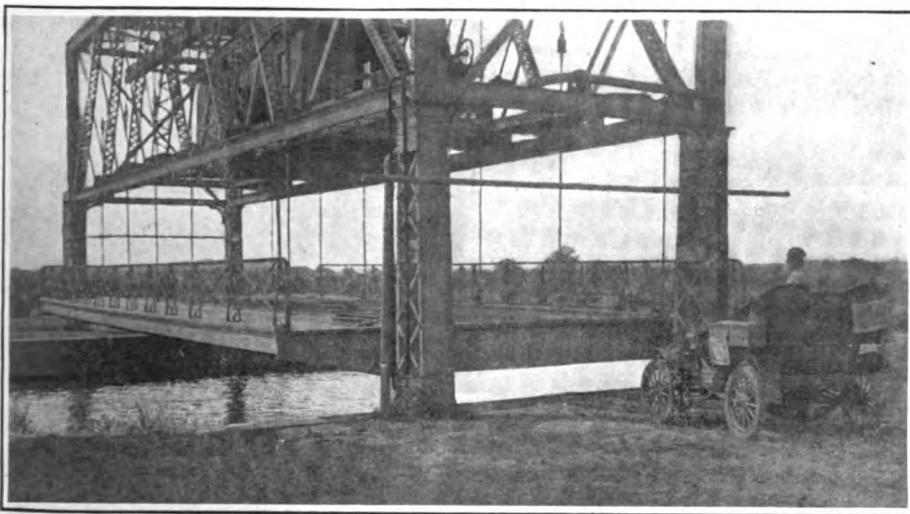

LIFT BRIDGE OVER ERIE CANAL NEAR ROCHESTER ON TOUR ROUTE.

Waite, Lowe, Esselstyn, Waters, Huss, A. L. Pope, MacLachlan, Fatch, Page, and Collings. Fatch is driving a Packard from Erie, and Collings, another recent entry, drives a Peerless limousine. Nearly all heartily praised the Indiana roads, which

of wetting and be the better for it; but in prolonged dry weather it gradually disintegrates; the sand no longer binds the stones, but works up in a fine dust, which is raised in clouds by every vehicle and pedestrian. It is only about ten days since

when they were going, but which had to stop for tire and other troubles.

For several miles out of South Bend we had gravel roads, but not of the admirable sort described in the preceding letter. These were very rough, with numerous hollows lying across the road, rather than ruts, and were sandy where they were not bumpy. In spots fresh gravel had been piled on, but not spread.

For a number of miles each side of La Porte the roads were pure, unadulterated sand. The soil of all that territory is sand, with a little clay in spots, and a thin surface of loam a few inches deep. The roads generally have deep ditches on each side, the sand being thrown up into a narrow causeway in the center. The country is rolling, with a constant succession of small hills, and the roads are winding instead of straight.

The net result of these characteristics, where the roads are not graveled or macadamized, is a crooked, rough, and very treacherous sand track, which it is equally difficult and dangerous to negotiate at speed.

The horses met in this part of the country were more disposed to be skittish than those farther east, but most of their drivers seemed determined to make short work of their timidity, for they were prepared to hold their beasts in hand till the last machine had gone by. I saw several short but sharp struggles between horse and driver, but no runaways. I learned, however, that one young woman, driving in person, had let her horse bolt and smash the buggy. She was taken to a doctor by the man whose car had caused the trouble; but she appeared to be suffering more from shock than from bodily harm.

Beyond Valparaiso—the nominal but mostly neglected noon stop—a very good limestone macadam road is found, on which fast time can be made, limited only by the extreme sharpness of most of the turns in the roads, which here and again follow the rectangular layout. It takes the Easterner some time to get used to this feature, and I was not greatly surprised, though certainly shocked, on approaching one of these sharp corners, to see a Winton touring car upside down just beyond the outer side of the turn. This accident was plainly due to downright recklessness, for no driver attending to business could have failed to see that the turn was there. It was learned later that the pilot car behind us ran out of *confetti* in the latter part of the run, and resorted to beans and corn as the most convenient substitute, with the natural result that chickens were killed in scores by the following cars.

The official route card proved nearly worthless on this day's run; and as the pilot car with the *confetti* did not start till after we did, we had little except Mr. Root's recollection of the road—from a night trip two days before—to guide us. We departed altogether from the official route into Chi-

ago, going in via South Chicago, by a very crooked but a short route through a villainous neighborhood.

We reached Jackson Park in time for a sandwich lunch at the German Building, our time having been 5 1-2 hours from stop to stop. At 3.30 p. m., the stragglers having arrived and a swarm of spick and span local automobilists having descended on the dusty tourists, the city was entered via Washington Park and Michigan Boulevard in parade order. In two respects the parade was a success: it was witnessed by a great throng of people, especially in Jackson Park; and the number of participating cars was certainly impressive.

Chicago to Pontiac.

PONTIAC, Aug. 8.—The Chicago Automobile Club showed its good will to the tourists in many ways, but in none more acceptably than in the preparation of a good road book with map, showing the route from South Bend through Chicago to St. Louis. This little book was compiled by F. E. Wheeler, of Janesville, Wis., and copies were distributed gratis to all the tourists. It does not wholly dispense with the need of *confetti*, but it is far ahead of the official route cards.

That the pleasures of an automobile ride on dirt roads depend a great deal on when it last rained has again been proved, for to-day's ride, which, we have been told, would be the most strenuous of the tour, has been one of the most delightful. All of it after the first twenty miles has been on dirt roads pure and simple; but these have nearly all been of black loam, which has been worn smooth by travel and yet is only moderately dusty. From Chicago we have had fine macadam out to the Joliet Road, then fine gravel, as different as possible from that of Saturday; and after this came the dirt, at first loose and sandy, with pebble roads in places, which we sometimes drove on and sometimes skirted. These pebble roads resembled those of the Mohawk Valley, but the dirt, being sandy, did not lubricate the pebbles, and a very good surface resulted. Where the black loam began the pebble roads ceased.

Added to the roads and the weather, the writer had an especial cause for pleasure in being a passenger with "Tom" Fetch, of "Old Pacific" fame, on the four-cylinder Packard car No. 13, which will go to St. Louis. Fetch is not out for a speed record—a fact he proved early in the morning by stopping his car to light cigars. The tonneau rides as nearly like a rocking chair as a tonneau car can; and the smooth, even spinning off of the miles on the straight level roads beyond Joliet, at a steady pace of about twenty miles an hour, was nothing if not delicious. It seemed actually restful, and probably was.

Until we got beyond Joliet and away from the Illinois River the country was rolling. The farmers with their families were out in force to see us go by, and

some of the rural lassies were very comely. All greeted us with good will and some with proffers of apples.

For a few miles beyond Joliet, where we lunched in company with Mr. Whipple and an escorting Packard driven by F. J. Pardee, of Chicago, we followed the river and the drainage canal, and the scenery reminded me much of some bits of the Mohawk Valley near Herkimer. Beyond Morris we left the river and turned south, and the level country began. For miles the road ran with gentle undulations between fields of oats and corn and pasture land, the dirt track winding between straight fences true to the compass, and Fetch had nothing to do but to toy gently with the steering wheel and occasionally shift the spark or throttle.

At one farm about midday between Morris and Dwight, where a considerable party had gathered to see the machines go by, we stopped and all hands—there were four of us—gave up our seats to some uncommonly pretty girls. Then Fetch gave them a ride up the road, and we took our leave amid a round of cheers from their brothers and parents. We learned later that at least one other tourist stopped and photographed and gave a ride to the same party, and that he and his driver and the occupants of some half-dozen other cars also, which came along about that time, were rewarded with cake *ad lib.*, for their gallantry. It will be long before we cease to grieve over the cake we didn't get.

We had passed a number of cars on the road, some in motion and others temporarily stopped by tire and other minor troubles of the sort which every seasoned tourist accepts as a matter of course. One and all, to Fetch's invariable hail, "Have you everything you want?" replied in the affirmative; but now our own time was to come. Seven miles out of Pontiac the right rear tire burst. It was the first tire trouble experienced with any car which the writer had ridden in on the tour. Apparently the rim had been a bit rough, and had chafed the casing. A tire burst seemed not to have been among the things Fetch expected, for he carried no spare casing; and we crept slowly into Pontiac on the rim.

Here we have found the whole town—it is not a big one—*en fete* to greet us. The one hotel is more than full, and a number of private boarding houses have received the overflow. Everywhere are evidences of hospitality and friendly interest; and, best of all, there is no disposition to "hold up" the visitors.

Among the incidents reported by other tourists, one related by R. H. Johnston, of the Peerless limousine No. 9, is interesting. Mr. Johnston's car had the ill luck to puncture a tire a few miles from Joliet, and the casing was too large for the rim, necessitating a couple of hours' disagreeable work in getting it into place. The car had stopped opposite a farmhouse,

the owner of which came out while they were at work, and, wonder of wonders, offered them real tire tools, including some they did not carry, and personally assisted them to subdue the refractory casing. He offered them the use of his house telephone if they needed help from town—which they did not—and when the job was done he insisted on their taking dinner with his family. He was an up-to-date farmer, that was all; he owned a Cadillac and had a complete home workshop, besides a telephone and other modern conveniences that made his guests open their eyes.

Shortly after midnight, while the above lines were being penned, the most exciting event of the whole tour occurred. Most of the cars had been stored for the night in the yard adjoining Bunn's livery stable, but four were indoors—F. A. Benson's Oldsmobile, Fetch's Packard, Esselstyn's Franklin and Seaton's Buckmobile. The first two were in a repair shop attached to the stable and under the office of a local paper, and the other two were next door, the Franklin having been transferred after 11 o'clock. The Oldsmobile was undergoing repairs, and the local mechanic assigned to the job finding that the incandescent drop light cord was too short to reach under the car, detached one of the oil lamps of the car and set it beneath. Then, by mistake, he opened the drainage tap from the gasoline tanks. The inevitable followed.

The blaze spread so quickly that there was no time to shut off the gasoline or even roll the car out of the building, a small two-story frame structure. Fetch and some friends fortunately were downstairs in the hotel, which is directly across the street from the stable, and on hearing the alarm they dashed out, burst in the main door, which was locked, and dragged the Packard out to safety. Before the fire company—a very efficient one—could respond to the alarm, the gasoline tank of the burning car had exploded with a report that shook the hotel, and in an instant the whole building seemed ablaze.

Visions of a devastated business block and a mourning Pontiac arose before the mind's eye; but when the firemen got to work the flames were subdued almost as quickly as they had spread. Fifteen minutes, at most, from the time of the explosion, the building was a blackened, smouldering shell; and the surrounding structures were safe. The tour will be minus one car, and Pontiac will have lost one print shop and acquired very likely a complicated dispute with some insurance company. **HERBERT L. TOWLE.**

No automobile tool-box should be without a supply of copper wire of two or three different sizes.

Automobiles are becoming such a common sight in the village that the horses refuse to be scared and the small boys fail to follow half a mile.—*Barrington* (Ill.) *Review*.

Plans for St. Louis Reception.

Staff Correspondent.

ST. LOUIS, Aug. 9.—The World's Fair city is going to do herself proud in the splendid reception which is planned for the tourists when they arrive at the end of the record-breaking journey. Under the direction of A. B. Lambert, President of the St. Louis Automobile Club, who has developed splendid qualities of leadership, the program, extending over three days, has been completed.

The main body of tourists that come by way of Chicago is expected to reach the city limits to-morrow, Wednesday, evening. Today a reception committee of St. Louisans, including Dr. E.M. Senseney, Harry Turner, O. L. Halsey, W. W. Leathers and Jesse French left for Springfield, Ill., where they will give the tourists friendly warning of what they may expect when they reach the journey's end. To-morrow afternoon another committee will start out in machines to meet the cavalcade at Edwardsville. This will be headed by President A. B. Lambert of the St. Louis A. C., and will include Messrs. Walker, Culver, Gardner, Schlusser and Fest. Besides the official representatives of the club there will be many local motorists with their cars in the party. From the famous Eads bridge, over which the procession of tourists and locals will pass to reach the city proper, the route will be through the business district to the magnificent Hotel Jefferson, which will be headquarters for the tourists during the stay in St. Louis.

Wednesday night and the greater part of Thursday will be a period of rest, and Thursday night there will be a smoker in the Washington Hotel in honor of the visitors. This will be really an experience meeting in which the troubles and pleasures of the trip will be narrated, and those lucky enough to be with the crowd will get some sure-enough pointers about touring.

On Friday the chief feature of the program will be the grand parade of automobiles at the Fair. Friday is Automobile Day, and not only will the tourists and their local friends be in line, but many machines from the surrounding country are expected, and as it is Automobile Day at the Fair it is probable that many of the exhibits will be in the running. In front of the Jefferson Hotel on Twelfth street the machines will be lined up for the start on Friday afternoon. Led by the travel-stained cars of the tourists, the procession will give the natives a five-mile demonstration run to the grounds. Inside the fence the course will be laid along the principal drives, where neither mud nor thank-you-ma'am's are found, until the Administration Building is reached, where President Francis, of the Exposition, will head the parade. With him in a Pierce Arrow will be Director of Exhibits Skiff and Willard A. Smith, Chief of the Department of Transportation Exhibits.

At the Government Building they will turn out of the line and all the other cars will pass in review. The Missouri division will lead the run past, with Mayor Rolla Wells of St. Louis in front.

Already some of the odd tourists have come to town. The advance guard of those who took the Southern route reached here about 7:30 o'clock last night, and put up at the Jefferson Hotel. In this "bunch" were A. D. Rogers, Jr., Sterling Rogers, T. W. Pinkard and C. O. Howard, all of Columbus, Ohio. They left last Friday and came through in their two cars in about twenty-five hours' actual running time. On the way from Columbus to Terre Haute the roads were excellent, but in Illinois the roads were invariably bad and the going heavy. An odd incident on the way was the passage through a grove, where a barbecue and picnic of country folk was under way. Several hundred horses, it seemed to the tourists, were hitched to fence rails and branches, and every one showed a wild desire for freedom when the autos came along. Some of the natives had apparently never seen a car before, as they were more scared than the beasts. However, no mishap occurred.

First to arrive over the Northern route were Mr. and Mrs. Walden Shaw of Chicago, who got in here at 6 o'clock Monday evening, making the run down from the Windy City in about eighteen hours.

THE LONG TOUR ENDS.

Tourists Reach Destination After Weary Day of Mud Plugging.

Special Correspondence.

ST. LOUIS, Aug. 10.—The New York-St. Louis automobile tourists arrived here today after a hard struggle with almost impassable mud from Springfield, Ill., the last stopping place before St. Louis. The cars were strung out in a long procession, and on the hills it was the rule for all hands to get out and push, owing to the greasy surface. The forty-two miles between Mount Olive and East St. Louis proved to be almost the undoing of many of the automobiles. A number of St. Louis automobilists met the tourists at Edwardsville, Ill., and escorted them to East St. Louis, where they were greeted by a cheering crowd as they rolled toward the Fair grounds on the last stretch of their long journey. Reports of mishaps to Ray D. Lillibridge's White and Harlan W. Whipple's Mercedes have been received, but none of the occupants was injured. Mr. Whipple made the last few miles of the journey by train. It is expected that practically all of the cars will come in later, some having been delayed by minor troubles directly attributable to the bad roads.

Suggestions to the Inexperienced.—VII.*

A Simple Discussion of the Principles of the Gasoline Car for the Benefit of Novices.

By A. D. RIVER.

SLIDING GEAR SPEED-CHANGING SYSTEM.

THE system of speed-changing gears employed on nearly all of the European cars, and on most of the higher powered American machines as well, is that known as the "sliding gear" train. On one of two parallel shafts is fixed a set of gears three or four in number, of different sizes. On the other shaft is a corresponding set, united together and free to slide along the shaft, but not to rotate on it, being held either by keys or by that portion of the shaft being squared. These gears are of such sizes and so spaced as to mesh, each with one of the gears on the other shaft, and to mesh one at a time only. Consequently, by shifting the movable set along so that one or another pair of gears is in mesh, the velocity of the driven shaft relatively to that of the driving may be changed.

To avoid smashing the gear teeth, which would inevitably result if one attempted a shift of gears while running with one shaft connected to the road wheels and the other to the motor, the shaft connected to the motor is momentarily released, by means of a friction clutch between it and the motor, and allowed to turn loosely till the change of gears is accomplished, after which the friction clutch is re-engaged. Even then, however, there is an unavoidable

shock, which it requires the very best of material in the gears to withstand. As *C* and *H* are of the same size, *G* turns in the high gear at the same speed as *A*. In the low gear the relative sizes are such that *G* turns at about 3-10 the speed of *A*. To shift the gears, a sliding rod *L* is provided from which an arm *M* extends,

carrying at its end a fork attaching to a split thrust ring *N* working loosely in a groove in the carriage.

The arrangement of gears just described requires that the power shall always be transmitted through one pair of gears. As most of the driving, except in a very hilly country, is done on the high gear, some makers consider it better to make the drive direct on that gear, even at the expense of driving through two pairs of gears instead of one on the lower speeds.

An arrangement of this sort is seen in Fig. 2. Here the loose jaw coupling, of which *A* forms a portion, constitutes the connection to the flywheel clutch. Part *A*

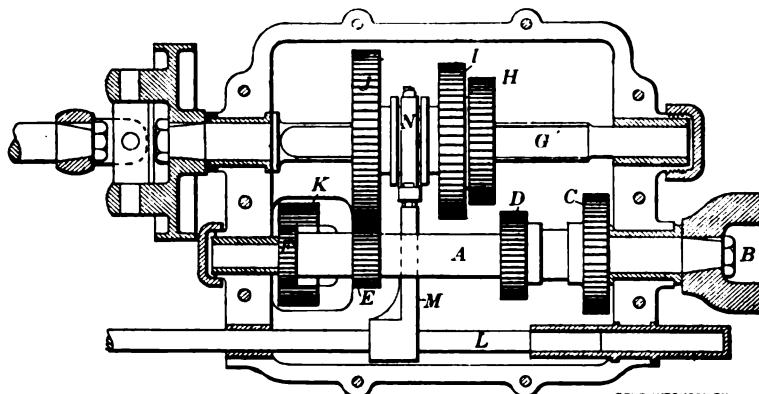

FIG. 2.—ARRANGEMENT OF GEARS FOR DRIVING DIRECT ON HIGH SPEED.

in this case is the highest. The gears are so spaced that any pair is fully released from mesh before the next is engaged. To obtain the reverse motion, gear *J* is shifted past *E* into mesh with an intermediate pinion *K* wide enough to mesh also with *F*.

is formed integral with a short thick shaft, or rather sleeve, which turns in the bronze bushing *B* and has fixed on it the pinion *C*, back from which project the claw clutch teeth *D*. Like all of the other shaft bearings seen, *B* is slotted on top and an oil ring in the slot rests on the shaft and is carried around by the latter, dipping into an oil well below, and carrying the oil as it turns to the shaft above.

The left-hand (or, in the car, the front) end of the squared shaft *E* turns freely in the sleeve to which *C* is attached, and on it slides a carriage to which are attached the two gears *F* and *G*. On the "jack-shaft" *H* are secured four gears, the first of which *I* is in permanent mesh with *C*, so that *H* constantly turns when the clutch is in. For the first or lowest speed the carriage is moved by the shifter rod and fork *I* so that gear *G* meshes with pinion *K*. For the intermediate speed *F* is engaged with *L*. For the high speed or "direct drive," the carriage is moved to the left till the claw teeth *D* enter corresponding recesses in the end of the carriage, thus locking the shaft *E* to the driving sleeve. In this position only the gears *C* and *I* are in mesh. For the reverse, the carriage is shifted through the first speed till *G* engages an intermediate pinion *M* on the stud below pinion *N* on the shaft. As *N* is smaller than *K*, *G* does not touch it. Drum *O* is the service brake drum, similar to the corresponding drum on the rear end of shaft *G*, Fig. 1, and *P* is a sleeve surrounding a universal joint from which the power is transmitted.

The most characteristic thing about the

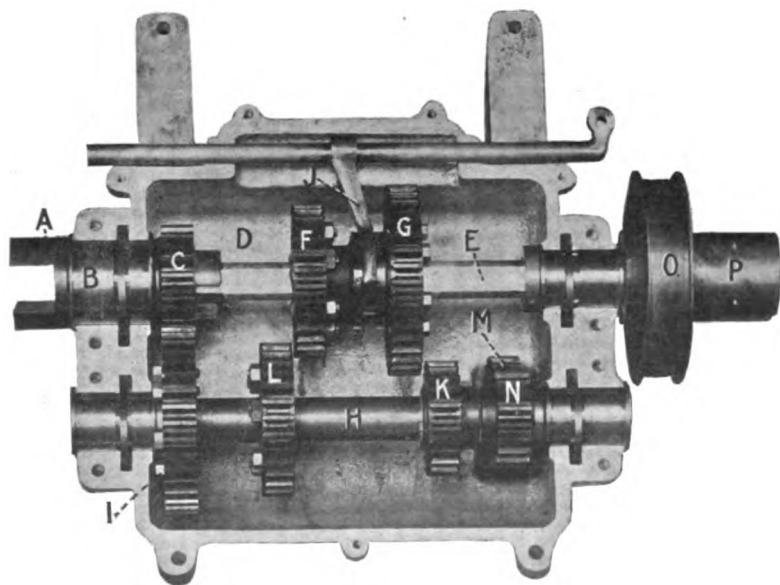

FIG. 1.—TYPICAL ARRANGEMENT OF SLIDING CHANGE SPEED GEARS.

shock, which it requires the very best of material in the gears to withstand.

A typical arrangement of sliding gears is shown in sketch form in Fig. 1. The shaft *A* is driven from the motor through a friction clutch coupled to the end *B*, and

*Continued from Page 117, issue of July 30, 1904.

sliding gear system is the necessity of adequate provision for the battering to which the teeth are subjected by every shift of gears. Not only are the gears subjected to rough usage, but they are generally made as small as is compatible with safety, both to save weight in general and because this very feature of small size and light weight reduces the shocks on shifting, which shocks of course are due wholly to the inertia of the gears, the idle shaft, and the portion of the flywheel clutch connected thereto. Consequently the gears must be tough, not brittle, and at the same time have a very hard surface on the teeth to withstand the wear of travel and the shocks of changing speed. These qualities have been combined by the use of either a very mild steel or Lowmoor iron, rendered almost glass-hard to the depth of about 1-32 inch by case-hardening after they are cut.

As a gear tooth will sometimes break, and as the gears as a whole wear out (and are expected to wear out) rather rapidly, they are nearly always made separate from the shaft or carriage, so that they may be cheaply replaced. This is clearly shown in Fig. 2.

Another point of considerable importance with this system is that of lubrication. The gears run in a bath of thick oil, but even with the best attention to this point the wear they suffer results in the production of fine metal dust, most of which settles to the bottom of the case, if the latter is deep enough to permit settling under the gears. The dust does not always settle, however, and if the shaft bearings are oiled from the interior splash a certain amount of this dust will get into the bearings and "cut" them. Probably the best plan is to separate the lubrication of the shaft bearings wholly from that of the interior of the case, and this is done in the illustration last shown, in which each bearing has a separate pocket in case and a ring or chain oiler. Another device by which the same result is obtained is to feed oil directly to the shaft bearings from a pressure oiler, and let it escape slowly from the ends of the bearing into the interior of the case.

When the shaft bearings are oiled from the interior splash, a very fine wire gauze screen is frequently used over each pocket, to strain the oil before it goes down to the bearings. If this is not done, a fairly deep case, not too thick oil, and periodic renewal of the bath before it gets too thick with dust, are the best protectives of the bearings.

(To be Continued)

Light Without Matches.

When automobilng, if matches cannot be had, and a light is wanted, it may be obtained in this way: If the car is fitted with jump spark ignition, disconnect one of the high tension wires from its plug; place the free end of this wire in such a position that it lays about a quarter of an

inch away from the cylinder casting. A small piece of cotton waste or a piece of paper should now be saturated with gasoline and placed over the free end of the ignition wire. Turn on the ignition switch and crank the motor. When the spark jumps from the free end of the disconnected wire to the cylinder casting, it will set the paper or waste on fire.

Be careful not to allow the blazing waste or paper to fall into the "apron," underneath the motor, if one is used. This "apron" is usually covered with grease and oil, and if it catches fire it may imperil the car.

On machines having make and break ignition one wire should be disconnected from the insulated electrode in the cylinder. A piece of waste or paper saturated with gasoline, as previously described, is then laid on the cylinder head. The motor is next started and allowed to run slowly—on three cylinders. If the wire which has been disconnected from the sparker, as described, is now touched on and then removed from the cylinder casting or *masse* close to the waste, the spark resulting from the short-circuit will ignite the waste or paper.

Worn Valve Gear.

An unexpected cause of motors missing and not giving off full power is due sometimes to faulty action of the exhaust valves. This is caused by wear in the valve actuating mechanism. The rollers, or shoes, which ride on the cams of the half-time shaft or the cams themselves may wear, owing to defective lubrication, or to the material of which they are made being too soft. If the amount of wear is, say, one-eighth of an inch, it is clear that the valve will open just this much too late, and close this much too early.

Back pressure will be caused by late opening, particularly at high speeds, and the burned gases will be retained in the cylinder by early closing, and will be compressed toward the end of the exhaust stroke. When the inlet valve opens, therefore, these burned gases, which are then under pressure, will rush out into the inlet pipe, and displace a portion of the incoming charge. Now the piston goes out on the suction stroke, and as the inlet pipe is full of exhaust gas, the fresh gas will not reach the cylinder until the piston has moved out a considerable percentage of its stroke. Consequently the volume of the aspirated charge will be less, and the percentage of burned gas to fresh, or explosive, gas will be greater. This will cause weak explosions and loss of power.

A little consideration will show that if the exhaust valves act as described, it will be almost impossible to throttle the motor, so as to make it run slowly. When the motor is throttled very much only a small quantity of explosive gas is taken in during each suction stroke. There is, as just shown, a relatively large volume of burned gas in the cylinder and passages. This burned

gas may dilute the fresh gas to such an extent as to render the resulting mixture non-explosive.

When there is a greater distance between the "push-rod" and valve stem than 1-16 inch the valve actuating gear should be taken apart and refitted. More clearance must be allowed between the rod and valve stem when the latter is long than when it is short. The reason is, that a long valve stem lengthens more on being heated than a short stem. For this reason before testing the clearance between the stems and rods, one should make sure that the motor is thoroughly heated by running it for ten or fifteen minutes. This run ought to get the valve stems up to working temperature.

When fitting a new exhaust valve—especially if it has a long stem, and everything cold—be careful not to make this clearance too little. If too little clearance is allowed when the parts are cold, the expansion due to the working heat may be sufficient to lengthen the valve stem so much that it will rest on the end of the push rod, and so prevent the valve from seating fully. This will, of course, result in great loss of power also.

Often a motor will have good compression when cold, or slightly heated, and have next to none at all after it has run for some time. When a motor acts in this way, the trouble is usually due to leakage past the valves on account of the small amount of clearance between the valve stems and the push-rods. When the stems and valves are cold, the latter seat properly, but when the stems are heated, and of course expanded, the valves are prevented from seating by the stems resting on the push-rods.

Valve seats which are pitted badly are usually faced off. So much metal may be taken off in doing this that the stem of the valve—when the latter rests on the re-made seat—will touch the push-rod. After valves have been ground in a great deal, or after they have been faced off, the stems may also strike the push-rods. The action of mechanically operated inlet valves will be affected by wear in the mechanism, the same as exhaust valves.

Inasmuch as the springs on the inlet valves are usually weaker than on the exhaust valves, the wear on the parts which move them will not be so great. Another reason why the wear is less that there is no pressure on the inlet valves at the instant when they are lifted, while the exhaust valves may have forty or more pounds pressure to the square inch on them at this moment.

Inlet valves do not get nearly as hot, and consequently do not expand as much as exhaust valves. For this reason less clearance should be allowed between the stems and push-rods than would be allowed between the stems and push-rods of exhaust valves.

The remarks about facing off the seats or valves and grinding in of exhaust valves apply to inlet valves also.

Ardennes Circuit a Hard-Fought Race.

Special Correspondence.

PARIS, Aug. 1.—The grand automobile sport which Belgium has been giving us for the past two weeks is now over. The great speed records have been broken and we have seen the greatest road race ever held. All are satisfied that nothing better could be done, and that nothing ever showed the perfection of the automobile better than the events of the fortnight.

The record breaking at Ostend requires no comment, since such races do not present any peculiarities, so short is the time between their beginning and end. Such performances leave only an astonished and incredulous feeling in the mind of the witness that men can stand such strains, if there is time to feel a strain at such tremendous speeds, and one is left to wonder which should be admired most, the man who attains to this speed or of the delicate mechanism which with so much power tears through the air, obedient to her driver's least notion.

Not less admirable than these wonderful bursts of speed were the performances in the long road races which followed.

Taking them chronologically, on Sunday the motorcycle and the light voiturette races were held. How a man was able to stand 240 kilometers of rather poor roads on a bicycle weighing less than 105 pounds at an average speed of more than a kilometer (62-100 of a mile) a minute is almost incomprehensible, but such was the performance of Kuhling, on a Minerva (Belgian), who covered the 149 miles in 3:46:06 4-5, winning first place, and of Griet on an Alcyon (French), who finished second in 3:48:49 3-5.

Only two started in the light car class. Edmond, on a Darracq, did not finish on account of too many stops, due mostly to tires, which disheartened him. A. Clement, on a Clement-Bayard, had just as many stops, but stuck better to his task, probably because he was more interested in his firm, and finishing alone won in his class in 4:26:52 3-5.

The Monday races were far more interesting, being for the heavy and medium weight cars. The classes were divided in two, for cars between 450 and 700 kilograms, and for cars from 700 to 1,000 kilos. The latter class was the more interesting and attracted all the attention.

The start took place in the early morning, the cars leaving at intervals of two minutes. As a rule the cars and drivers seemed better tuned up and in better shape than at the start of the Gordon Bennett race, probably on account of the experience which the makers and some of the drivers had gained in that event and also because of the greater practice which all had gotten during the fine weather which has favored us of late. At any rate, the start was more regular and without any hitches.

Throughout the race we were in doubt

as to the probable winner, although it appeared to all that the old Panhards had the best chance. They had the lead practically all the time, but their competitors were so close behind and proved so nearly equal that no one was sure of the victory even after the first car had arrived; so close were the others that long calculations of the allowances had to be made amidst the shouting of the anxious, interested parties.

The results were at last published, as follows:

Driver.	Nationality.	Car.	Time.
Heath	American	Panhard	6:30:49
Teate	French	Panhard	6:31:44
A. Clement	French	Clement-Bayard	6:34:43
Rigolly	French	Gobron Brillie	6:42:04
Le Blon	French	Hotchkiss	6:54:05
Duray	French	Darracq	6:55:34 3-5
H. Farman	French	Panhard	6:57:29 3-5
Gabriel	French	De Dietrich	6:58:05
Mark Mayhew	English	Napier	7:27:42
Leger	French	Mors	7:45:15
Fletcher	English	Mercedes	7:53:00
Bianchi	English	Wolseley	7:54:10
Lancia	Italian	Fiat	7:55:25
Salleron	French	Mors	7:55:34

Heath, the winner, was born in America, but has lived many years in Paris, where he is universally known and liked as a "fine fellow" in the automobile centers.

A most promising driver, however, is the young A. Clement, son of the great French maker. We have already mentioned his plucky race in the French elementary trials for the Gordon Bennett. He has now been proved one of our best drivers by his success in these last races. He especially distinguishes himself by his pluck and absence of fear, and above all by his determination; he sticks to his race with the grip of a bulldog, and nothing short of a completely smashed car would stop him from going on until the race is called off or he passes the finishing post, whatever the difficulty of the repair may be. With a car 40 horsepower below that of the winner, he lost only four minutes in 600 kilometers compared with the latter. His secret is the adjustment and almost building up of his car himself, seeing that nothing is left to uncertainty.

The best run was made by Le Blon, the former driver of the Serpollet steam cars, now interested in the Hotchkiss gasoline car. This new make classed itself among the best, making 104 kilometers 252 meters (64.78 miles) in the hour, including all stops and everything.

A most interesting performance from a technical point of view was that of Rigolly. The holder of the world's record, in the same car which he had at Ostend, made a beautiful showing and had not his tires given him any amount of trouble he certainly would have been in the first, if not the very first. This was wished by many and was almost as good as done. It goes

to prove that the same car that gave such terrific speed on short distances can also hold its own on the road and make a magnificent showing of reliability.

The big racing cars will now take a well deserved rest, and let their experts design their 1905 cars, profiting by the experiences they will have obtained. And now the auto-boat comes at the head of the program of sporting events.

Sunrising Hill Climb.

The annual hill climbing contest of the Midland Automobile Club, England, was held again this year on Sunrising Hill, Kineton, near Stratford-on-Avon, July 23. The hill is an exceedingly trying one, as, in addition to its steepness it has three short turns, all of which occur on heavy grades. The start is made on a grade of 1 in 15, which rapidly increases to 1 in 8. Just before reaching the first curve the grade becomes easier, about 1 in 22, but on the turn the gradient runs up to 1 in 9, and here the rules of the contest called for a dead stop. Immediately on re-starting, the contestants were forced to negotiate another curve on a grade of 1 in 8¾ to 1 in 7. Another bend had to be rounded on a grade of 1 in 6½, and here another stop was required. After a short sharp pull the grade comes down to about 1 in 8 at the end of the climb. The total distance being 3,000 feet.

There were thirty-eight entries and twenty-nine starters, and out of this number but two failed to make the ascent. The best time was made by S. F. Edge in a 20-horsepower Napier, one of last year's racing machines with a touring body fitted. His time was 4:48 4-5. Four 28-horsepower English Daimlers took the next four places, their times ranging from 4:49 3-5 to 4:58 2-5. A 60-horsepower and a 40-horsepower Mercedes failed to make much of a showing, owing largely to the greasy condition of the road caused by a heavy shower after the first few cars had made the climb. Three American cars—a 12-horsepower Duryea, a 6½-horsepower Cadillac and an Oldsmobile runabout—were on the entry list. The Duryea made the ascent in 5:36 2-5, but had a good deal of trouble in re-starting on the hill from slipping clutches. The Oldsmobile broke an inlet valve before starting, and did not compete. The Cadillac made a steady climb with four passengers on board in 10:23 4-5.

Such delicate affairs are the cellular radiators on some of the French automobiles that the makers insist that only distilled water should be in them.

The heat radiated from the flanges of an air-cooled gasoline motor cylinder, or absorbed by the water in the jacket of a water-cooled cylinder, represents just so much wasted power. A theoretically perfect motor would utilize all the heat in useful work, leaving none to be radiated or otherwise lost.

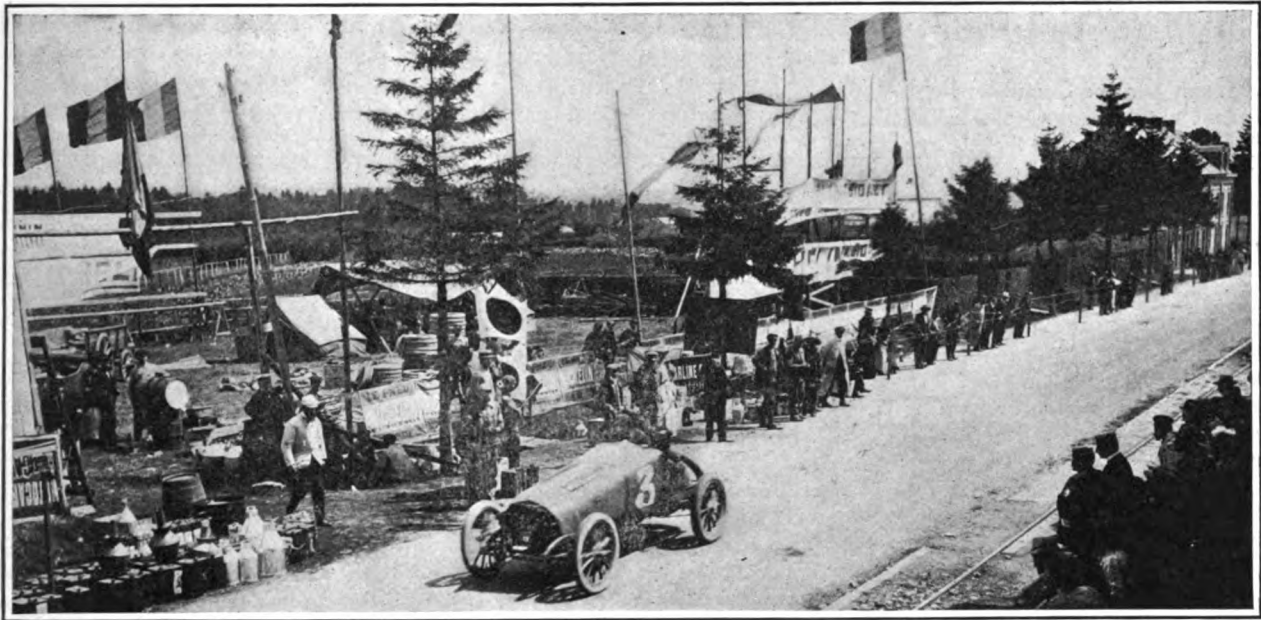

A. CLEMENT, WHO FINISHED SECOND IN ARDENNES CIRCUIT, PASSING TIRE AND SUPPLY DEPOT.

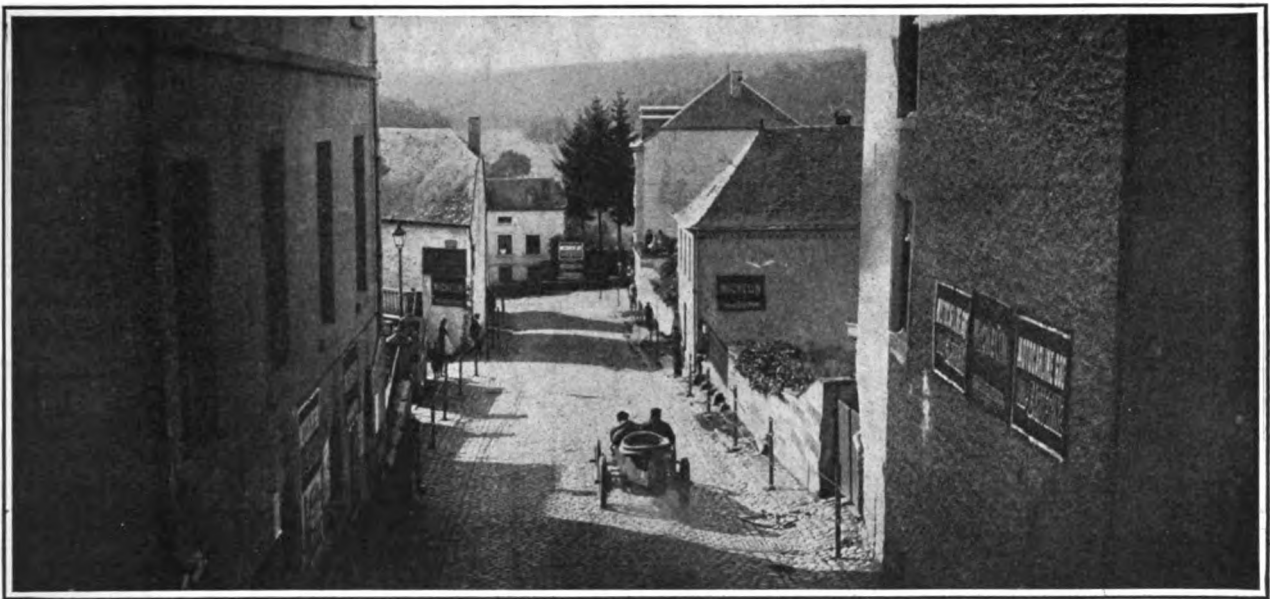

DESCENT AND ABRUPT LEFT HAND TURN IN NEUCHATEAU, OVER BELGIAN BLOCK PAVEMENT.

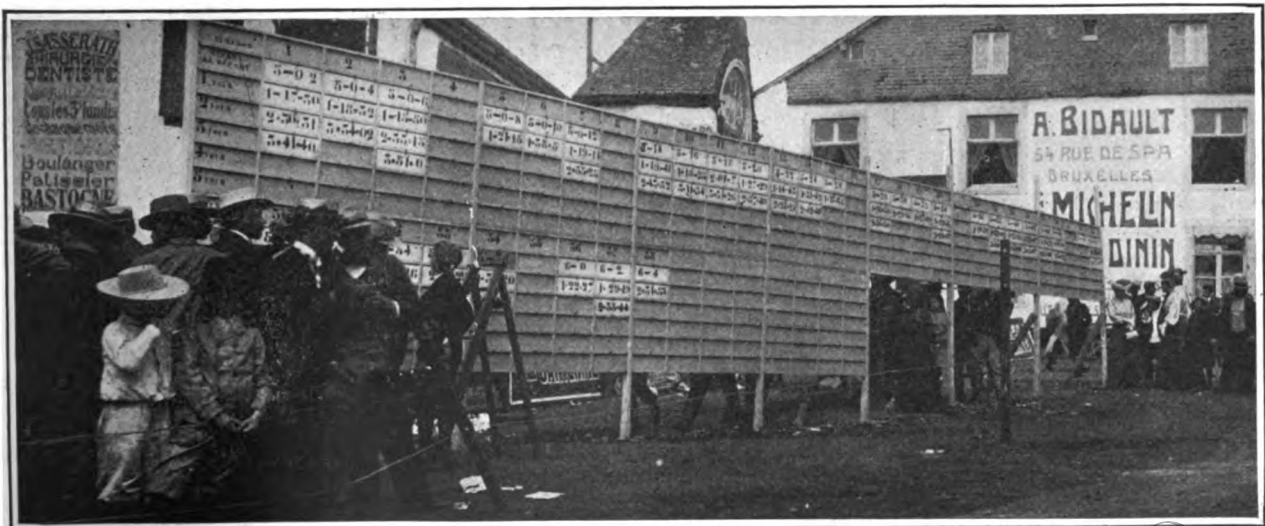

SCORE BOARD FOR ARDENNES CIRCUIT FACING GRAND STAND AT START AND FINISH LINE IN BASTOGNE.

1000-MILE NON-STOP RUN ON THE TRACK.

Packard Voiture Legere Completes Public Test on Grosse Pointe Oval in 29:53:37 3-5 without Stopping the Motor—Trial Thoroughly Organized.

Special Correspondence.

DETROIT, Aug. 8.—A non-stop run of 1,000 miles was completed at the Grosse Pointe track at 12:09:37 3-5 o'clock this morning—just a few minutes after midnight—by a Packard Model L, not the slightest hitch having occurred to mar the performance. The Voiture Legere, a four-cylinder stock car, was in as perfect condition at the finish as when it went on the track, and the 1,000 miles were covered in 29 hours 53 minutes 37 3-5 seconds. The objects sought in this trial were to test the motor under the steady grind of a 1,000-mile non-stop run, to secure data on

part of the driving, Mr. Waldron and Edward Roberts, who drove part of the time, state that the motor did not miss an explosion during the whole test.

The run began at 6:16 p. m. Saturday, and was conducted under a system of shifts of driving crews, there being three drivers and five mechanics. After the track had become packed down hard it was like flint and proved very destructive to the tires. One set of special Diamond tires carried the car over the first 611 miles, but several changes had to be made in the next 150 miles or so, and the necessity for jacking up the axle, removing the wheel and slipping on another at frequent intervals, although done very quickly, caused the loss of many minutes. Altogether twenty-nine stops were made for changing and examining tires, lighting lamps and replenishing the gasoline and oil supplies. Schmidt drove the car 100 miles before discovering that through an oversight he had entered the track with

mile, but Roberts was instructed to take no chances in the darkness, and accordingly reduced the rate of his trick to about five seconds under two minutes.

An even gait was maintained all night, and the Sunday following passed uneventfully. Many visitors, afoot, on bicycles and in automobiles, rode out to watch the run. Following is a summary of stops and oil consumption:

Stops on account of tires, 12; on account of lamps, 4; for gasoline, 16; for lubricating oil, 3. Total quantity of gasoline used, 70 gallons; lubricating oil, 3 gallons.

The timing was accurately done with a split-second watch, the timers and score keepers being employes of the Packard company. The complete list of the officials is contained in the accompanying table.

If you get a slight bend in the axle, get it straightened without delay, for a wheel that runs out of truth will absorb a lot of power, cause rapid wear of its bearings and.

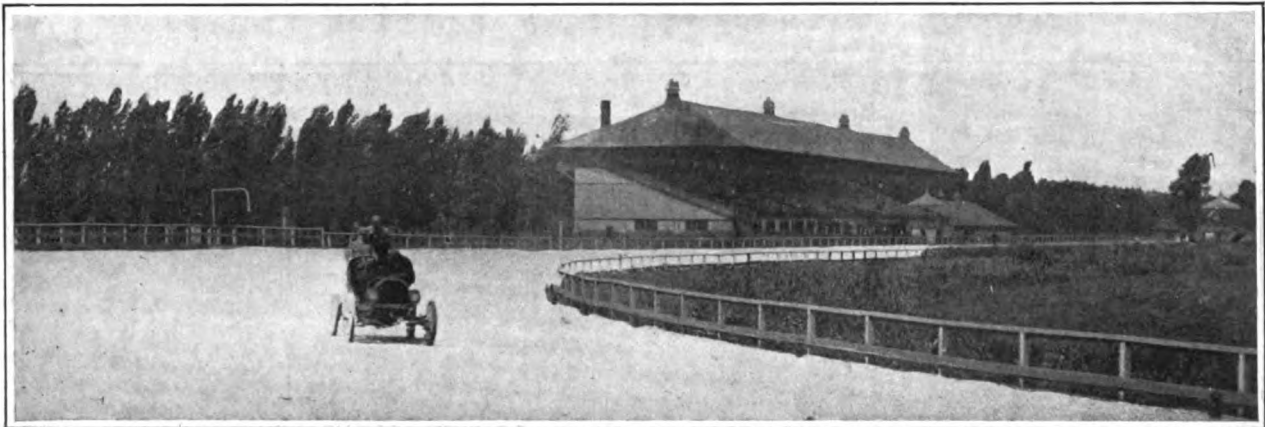

ROUNDING FIRST TURN ON GROSSE POINTE TRACK IN PACKARD 1,000-MILE MOTOR NON-STOP RUN.

the consumption of gasoline, oil, water and electricity, and to study the durability of the various parts in order to make improvements in the 1905 cars.

As a matter of fact, the machine was driven considerably more than 1,000 miles, as a distance of not less than twenty-four feet from the inside fence was maintained in order to avoid the possibility of a repetition of the accident that spoiled the former attempt, and Sales Manager S. D. Waldron, who had charge of the run, told Charles Schmidt, the driver who began and finished the run, to do an extra five miles for good measure.

This is the first time an automobile has been driven 1,000 miles without stopping the motor, on a track where the trial was thoroughly organized and the public and the press had free access to the trial at all times. In carrying out the project the Packard company had the coöperation of other automobile manufacturers, dealers and rubber tire men as officials and judges, notably Henry Ford, W. C. Rands and Harry Unwin. The machine was, of course, stopped at intervals to replenish the supply of gasoline or put on new tires, but the motor was not stopped for an instant. Designer Schmidt, who did the greater

but six gallons of fuel in the tank. The track was in excellent condition.

About 150 miles had been covered at 10.30 o'clock Saturday night, the sixty-fifth mile having been the slowest, owing to Schmidt reducing speed to light the lamps. The time was 4 minutes 33 1-5 seconds. The fastest mile of the entire run was done just before dark, and was clocked at 1.25 3-5. At midnight 200 miles had been covered, the car being then in charge of "Ed-die" Roberts, foreman of the Packard motor room. Schmidt figured on being at the wheel about 90 per cent. of the time. He had kept the pace up to about 1.49 for the

what is probably the worst feature, plays havoc with the tire. If you run over a large obstruction, or accidentally run one wheel up on the curb, take a look at your axle and make sure that it is straight. If not, have it attended to.

Chauffeur.—Excuse me. You say you are not seriously hurt. Then isn't \$50 damages a trifle high?

Mr. Ironback.—Say, you can't git out of it that way. I advertised in the local paper last week that 'Hereafter my rates for bein' knocked down by auto machines was to be raised to \$50.—Chicago News.

TIMERS, SCORERS AND JUDGES OFFICIATING IN DIFFERENT STAGES

Stages.	Timer.	Scorer.	Judge.
100-100	F. R. Humpage	J. H. Normington	W. C. Rands.
50-100	"	"	W. M. Perrett.
100-150	J. J. Ramsey	M. C. Taylor	M. Grinderson.
150-250	"	"	E. H. Broadwell.
250-350	Russell Huff	J. C. Harrington	"
350-400	"	"	W. A. Brush.
400-500	F. R. Humpage	J. H. Normington	"
500-550	"	"	W. J. Bowman and C. M. Hall.
550-700	F. W. Dennis	M. C. Taylor	Bowen and Hall.
700-750	Russell Huff	A. C. Harrington	Harry Unwin and W. C. Rands.
750-800	"	"	Unwin and Chas. B. King.
800-850	Huff and Humpage	Harrington and Normington	King and Perrett.
850-900	F. R. Humpage	J. H. Normington	W. M. Perrett.
900-950	"	"	J. C. Weston.
950-1,000	F. R. Humpage and J. J. Ramsey.	"	Weston, Unwin, Henry Ford, Chas. P. Root, Geo. W. Gunn.

The Ostend Gymkhana.

Ostend week was brought to a close on July 21 with an automobile gymkhana, in which M. Jochems, in a Mercedes, won first place and M. De Breyne, in a Darracq, second prize. The gymkhana events consisted of feats of dexterity and skillful operation on the part of the drivers, who had to drive their machines backward through a tortuous maze marked by posts, pick up rings, ring bells "on the fly," climb a mound, cross a trench on narrow rails, pass, at considerable speed, between balloons set close together, which would explode if touched, and, finally, steer a course through a crowd of wooden men, very naturally arranged so that the harassed chauffeur could avoid mowing them down only by the most extraordinary efforts. There was also a floral decoration contest, which was won by M. Jochems.

The gymkhana has become so popular in Europe that it is the usual closing event of every automobile met; one reason for its popularity being that the competitors are frequently women, who often prove themselves a match for the lords of creation in this form of sport. The gymkhana is gaining ground in the United States, and doubtless will be more appreciated when it is better known.

Motor Cars in Scotland.

In 1902 there were only about 250 motor cars in all Scotland, whereas there are now 200 in Edinburgh alone, and about 2,000 in Scotland. Only four Scotch cars are on the market, these being the Argyle, St. Vincent, Albion and Arrol-Johnston, but the Scotch carriage builders are wisely turning their attention to the building of automobile bodies in order to compensate for the loss of carriage business. The cars owned in Scotland are mainly of the larger types, doubtless owing to the fact that they are the property of wealthy persons, to whom the price of a large car is no objection. "The demand for small cars is increasing,

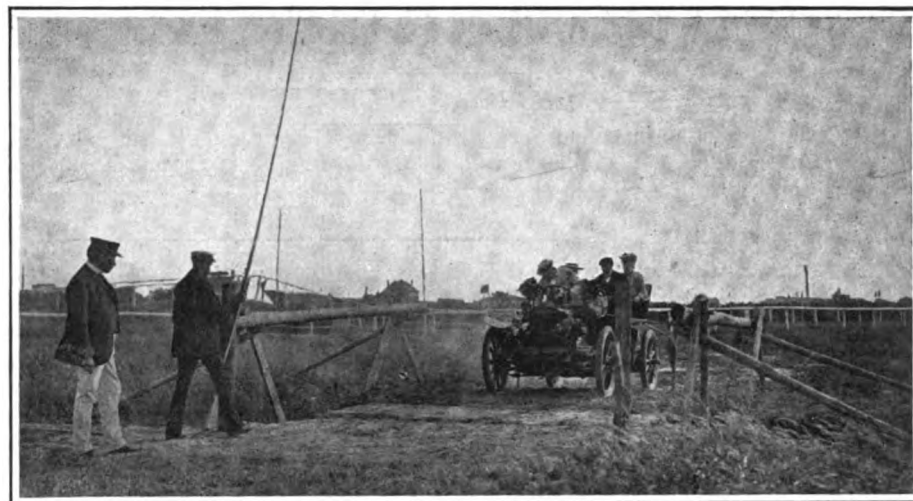

MAKING QUICK STOP AT SIMULATED RAILROAD CROSSING AT OSTEND GYMKHANA.

however, at a rapid rate," writes United States Consul Fleming to Washington. Self propelled motor coaches for railroad work on branches will likely be adopted in Southern Scotland if the experiments now being conducted with motor coaches in England and Wales should prove as successful as is anticipated. The first experiments were made by the Taff Vale Company, which ran a steam coach between Cardiff and Penarth, Wales, at a cost of 11 cents per mile, as against a cost of 30 cents per mile for an ordinary train consisting of a locomotive and four cars, and six additional motor cars have been ordered as a result. Gasoline motors for this work are being experimented with by the Great Northern Railway.

English Channel Boat Races.

The international motor boat race across the English Channel from Calais to Dover, which was run on August 8, was won by a French boat, *Mercedes IV.*, the time being 1 hour 5 minutes. An English boat took second place and a Belgian boat third place. There were twenty-two competitors out of thirty-two entries, and the race was followed by excursion boats carrying spec-

tators and by French torpedo boats, in one of which was M. Pelletan, the French Minister of Marine. In the competing classes divisions had been made for racers of various lengths, cruisers and finished boats. The speed craft included such boats as *Rapee III.*, M. Charley's *Mercedes III.*, the Richard-Brazier, boat, *Trèfle-à-Quartre*, Fournier's *Hotchkiss*, *Gardner-Serpollet*, *Napier II.*, *N'a pas Pied* (formerly *Napier I.*) and other well known high speed boats.

SALT LAKE ILLUMINATED PARADE.

Special Correspondence.

SALT LAKE CITY, Aug. 4.—An illuminated floral automobile parade was held here last Saturday evening and scored a decided hit. Thousands of persons lined the streets through which the beautifully decorated cars passed, and crowds thronged Utahna Park, where the parade ended and the prize, a handsome silver cup, was awarded to Orson H. Hewlett, whose Fredonia touring car was fairly smothered out of sight in many varieties of flowers. A special point in the scheme of decoration of this machine was the American flag on the front, done in roses and carnations. In addition to flowers, the winning machine, as well as the others in line, was hung with Chinese lanterns, greatly heightening the effect.

There were twenty-five machines in line and the procession was headed by a brass band. Mr. Hewlett's win was not by any means a walkover, as there were many cars decorated with artistic taste.

The excruciating noises produced by vigorous filing across the edge of a piece of sheet metal may be avoided by filing along the edge, or across at a slight angle, instead of directly across. Also, if the work can be held in the vise, keep the edges to be filed as close to the jaws as possible. By careful management the noise can be reduced to almost nothing. Even if you don't object to the nerve-racking screeching, you can do better work by following the foregoing directions. A screeching file does not cut fast or smooth as a quiet one.

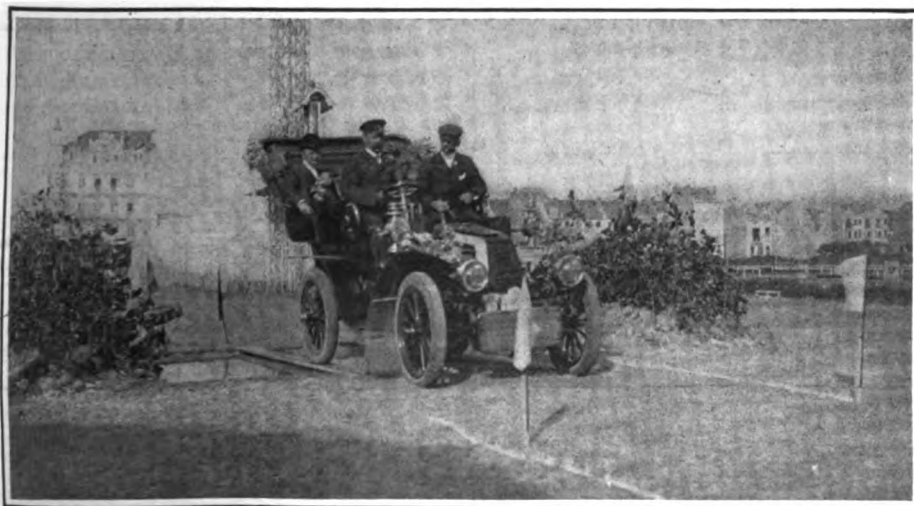

CROSSING NARROW RAILS OVER DITCH REQUIRING SKILFUL STEERING OF LARGE TOURING CAR.

British Motor Boat Reliability Trials.

Special Correspondence.

LONDON, July 28.—Marine motor week, one of the principal events in the automobile season of 1904, was ushered in July 26 and 27 by a two-days reliability tour in the Southampton waters, for which twenty-six boats had entered. Only sixteen appeared, however, at the hour of starting on the first day, but they rendered such an extremely good account of themselves as to console all concerned for the decreased number of participants.

The course marked out was a distance of 9½ nautical miles, commencing at Southampton Graving dock, and the task set was to complete as many rounds as possible within the ten-hour limit for the daily tour. Each boat was accompanied by an official observer, who kept careful account of all incidents and of the fuel used during the test. The War Office and Admiralty were both represented.

On the opening day the weather was fine, and of the sixteen boats fourteen were able to complete their task, the 28-horsepower Daimler, entered by Gorham & Manville, being thrown out of competition by a broken clutch, and the 5-horsepower *Cornubia* having a damaged pump. The Cannstatt Daimler boat was running excellently when it was forced to retire. It had been started off first, with *Napier Minor* second.

There were several minor incidents that prevented actual non-stops being made by some of the contestants, but on the whole the repairs were not of any magnitude. The longest stop was a quarter of an hour, made by the Brooke 14-horsepower, owing to defective water circulation. Much interest was evinced in Miss Larkins, who carefully steered the 18-horsepower Wolseley boat for the greater part of the ten hours.

The *Napier Minor* was the out-and-out fastest boat, as will be seen by the following list of the laps made in the first day's running:

The engine of the carvel built Launch Motor Co.'s boat was built by the Lozier Motor Co.; that of Cloud & Nichols by the Buffalo Gasoline Motor Co., and the

Woodnutt engine by the U. S. Long Distance Automobile Co.

Fifteen boats started July 27, the second day, as *Cornubia's* damages were repaired, and every one of the fifteen finished their arduous task in unpleasantly damp weather. This is a most laudable result, comparing very favorably with trials on land. *Napier Minor* again came out at the head of the list on the showing both of this day and the whole trials and completed a non-stop, although the speed had to be greatly slackened about half-way through, owing to a broken wire in the coil, which rather upset Mr. Edge's calculation of outdoing his achievements on the previous day. Although he could complete only thirteen laps as

and the Woodnutt, Mitcham and Maudslay launches. The official classification is not yet available, but the number of laps covered by the participants during these first trials for motor boats under the auspices of the Automobile Club of Great Britain and Ireland are as follows:

Napier Minor, 73-hp., 28 laps; *Scolopendra II*, 20-hp., 19 laps; *Durendal*, 22-hp., 17 laps; *Brooke*, 14-hp., 15 laps; *Woodnutt*, 10-hp., 14 laps; *Clement*, 13-hp., 14 laps; *Maudslay*, 20-hp., 14 laps; Cloud & Nichol's 10-hp., 14 laps; *Wolseley*, 18-hp., 13 laps; *Gobron*, 12-hp., 13 laps; *Cornubia*, 5-hp., 12 laps; *Vosper*, 12-hp., 12 laps; *Mitcham*, 6-hp., 12 laps; *Launch*, 5-hp., 11 laps; *Seal*, 2 1-2-hp., 9 laps.

Napier Minor covered 142.95 nautical miles on the first day in 9 hours 50 minutes, and 123.89 nautical miles in 9 hours 31 minutes on the second day, a total of 266.84 nautical miles in 19 hours 21 min-

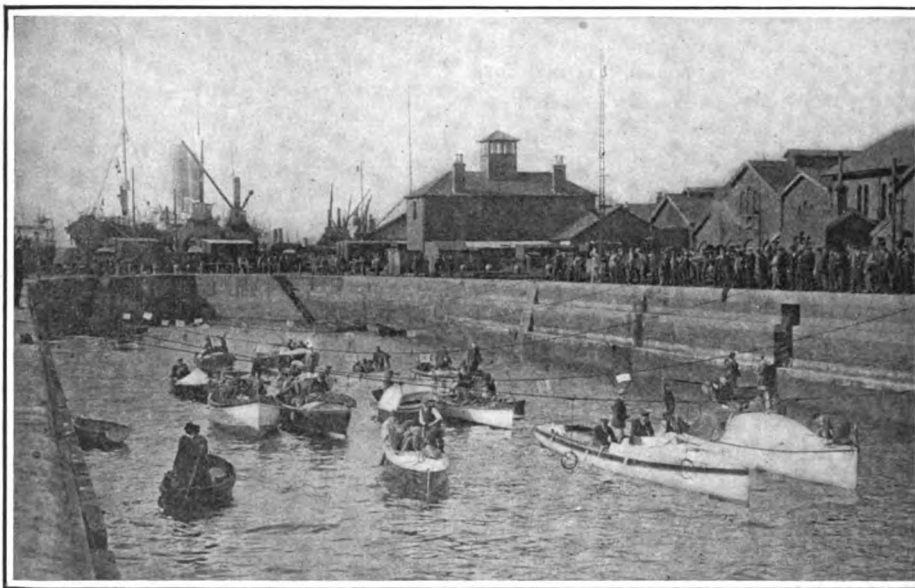

AUTO-BOATS AWAITING THE START IN DOCK AT SOUTHAMPTON.

against fifteen the day before, he was nine rounds in the lead of the second swiftest boat, *Scolopendra II*. His fastest time for the circuit of 9½ nautical miles—38 3-4 minutes—was made in the second round.

The *Cornubia*, too, ran excellently without a stop for the ten hours.

Non-stops for the whole twenty hours' trial were made by *Napier Minor*, *Seal*,

utes. The breaking of an ignition wire on the second day cut out one cylinder, which prevented the second day's record from equaling that of the first, but *Napier Minor* had a long lead notwithstanding the difficulty.

The five American motors in the trials all gave good accounts of themselves, such troubles as occurred being of the minor

DETAILS OF COMPETING AUTO-BOATS IN BRITISH RELIABILITY TRIALS, AND RESULTS OF FIRST DAY'S RUN.

Order.	Entrant.	Name of Boat.	Builder of Hull.	Builder of Engine.	Overall Length		Horse-power.	Laps Covered.	Nautical Miles.	Time.
					ft.	in.				
1	S. F. Edge	Napier Minor	Saunders' Launch Co	D. Napier & Son	35		73	15	142.95	9:50:00
2	Frank Beadle	Durendal	Saunders' Pat. Syn	M. M. C.	29	7 1-2	22.6	9	85 1-2	9:14:00
3	J. I. Thornycroft, Ltd.	Scolopendra	Maynard	J. I. Thornycroft, Ltd.	30	0	20	8	76	9:14:00
4	J. Gorham	Daimler	Canstatt Daimler	Daimler Co., Coventry.	40	0	28	8	retired,	6:01:00
5	Woodnutt & Co.	Woodnut	Woodnutt & Co.	U. S. Long Distance Automobile Co.	30	0	10	7	66 1-2	9:03:00
6	Gobron Motor Co.	Gobron	Hansen	Gobron-Brillie.	30	0	12	7	66 1-2	8:51:00
7	Maudslay Motor Co.	Maudslay	Sargeant & Co.	Maudslay Co	25	6	20	7	66 1-2	9:11:00
8	Cloud & Nichols		F. G. Maynard.	Buffalo Gasoline Motor Co	24	11	9.6	7	66 1-2	9:23:00
9	J. W. Brooke & Co.	Brooke	H. Reynolds.	J. W. Brooke & Co.	25	0	14	7	66 1-2	8:48:00
10	Launch Motor Co.		F. G. Maynard.	Lozier Motor Co.	24	11	5	6	57	9:11:00
11	Vosper & Co.		Vosper & Co.	Vosper & Co	22	1 1-2	12	6	57	9:01:00
12	Mitcham Motor Co.	Mitcham	Camper & Nicholson.	Fay & Bowen	22	6	6	6	57	9:09:00
13	Wolseley Tool & Motor Co.	Wolseley		Wolseley Tool & Motor Co.	22	3	18	5	47 1-2	8:53:00
14	Seal Motor Co.	Seal	F. G. Maynard.	Seal Motor Co	18	0	2 1-2	5	47 1-2	9:03:00
15	G. Phipps Spooner	Cornubia	Hart, Harden & Co.	Tangyes, Ltd.	25	0	5	5	retired,	6:51:00



THORNYCROFT 20-HORSEPOWER, 30-FT. LAUNCH "SCOLOPENDRA II," SECOND FASTEST BOAT.

sort and due more to carelessness in operating than to any defect in the mechanism. One skipper, for instance, forgot to replenish his fuel tank and so stopped his motor. In another case dirt in the gasoline clogged the carbureter, causing a short delay.

Tire Bursting Demonstrations.

Special Correspondence.

LONDON, July 30.—In order to prove that, given a car properly constructed and just as properly attended and a cool and experienced driver, the bursting of a tire is not necessarily followed by an accident, S. T. Edge instituted a series of demonstrations on the Crystal Palace Fireworks ground in London this week.

Aided by Cecil Edge, of non-stop fame, and Mr. MacDonald, who carried off a prize at the Kiel regatta, Napier cars of different horsepowers were driven at full speed over a specially prepared course covered with such formidable articles as broken glass bottles, iron plates with projecting steel points, boards bristling with carpenters' chisels, long nails and other instruments of destruction.

Cecil Edge commenced the experiments, driving his 15-horsepower car backward and forward over the stretch. Whenever the tires fell a victim to one of the obstacles, a

Bennett racer then gave some most convincing demonstrations. A speed of more than fifty miles an hour was attained, and although punctures occurred at this high speed, no swerve was noticeable. With a front tire cut by the chisels and a back tire burst by an iron spike and held to the rim on one side only, Edge made the crowning experiment of the day. Running the car at top speed, he endeavored to detach the tire entirely without abating the pace by throwing the vehicle quickly from side to side. This succeeded to everybody's satisfaction, the Napier racer after the tire was dashed off continuing in a straight line on a deflated front tire, two perfect ones and the bare rim, and promptly replying to the brakes at the close of this final test, which has proved that it needs somewhat more in the majority of cases than a burst tire to overthrow a reliable car, or even to throw it violently out of its course.

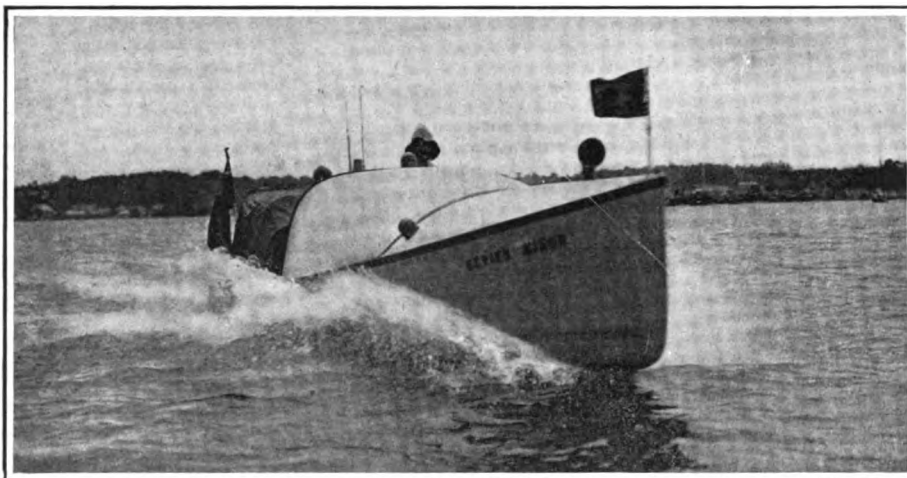

"NAPIER MINOR," WINNER OF RELIABILITY CONTEST AND ALSO OF HARMSWORTH CUP RACE.

slight jolting was the only result, the car keeping in its course in spite of the deflations.

S. F. Edge, on his 80-horsepower Gordon

Fifty-three hundred automobiles have been registered in the State of Massachusetts since the new law became effective last September.

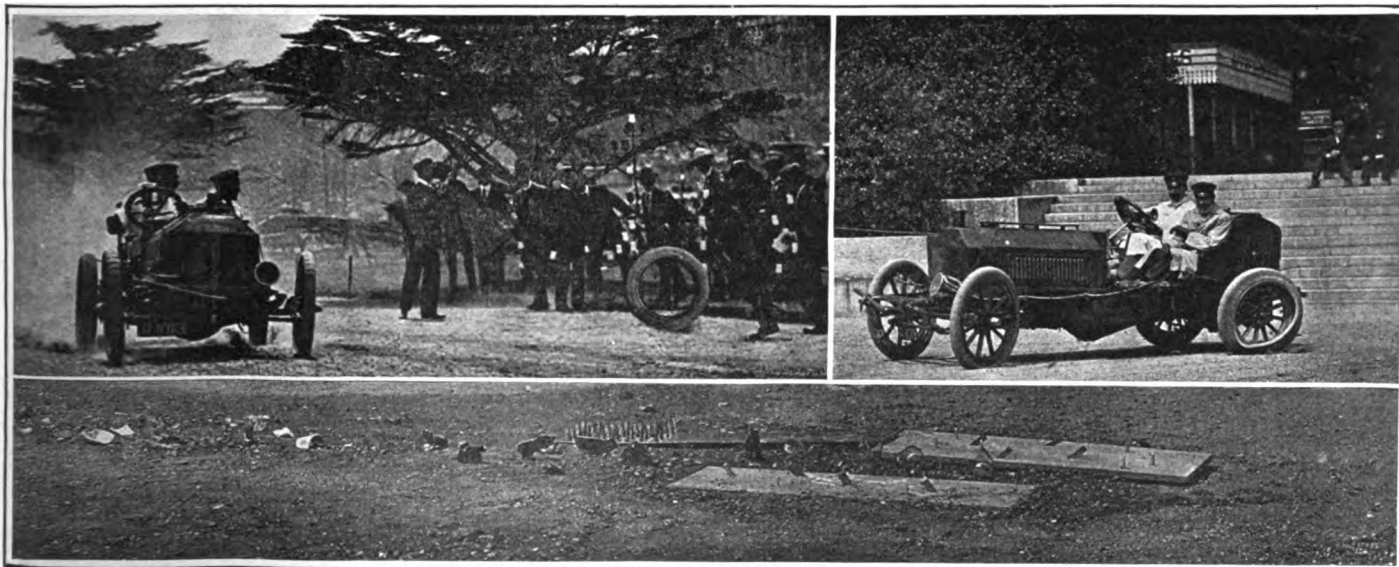

Casting Shoe from Rear Wheel at High Speed. Front Tire Flat and Rear Semi-Detached. Puncturing Implements Laid on Course and Driven Over at Fifty Miles an Hour.

PHOTOGRAPHS OF TIRE BURSTING AND DETACHING DEMONSTRATIONS BY S. F. AND CECIL EDGE IN LONDON.

Correspondence

Another Transcontinental Trip.

Editor THE AUTOMOBILE:

Sir:—We leave San Francisco to-day in a Franklin car to make the run to New York City—or to attempt to make it. As an operator of one of the only three cars to ever cross the continent, I speak with a little caution on the subject, as I have passed that period of confidence assumed by the beginner in the game. Nevertheless, we shall start to-day at 3 p. m., and regarding our progress shall advise you later.

The machine is a regular stock car, but we have put in a larger tank for gasoline and fitted Diamond 3 1-4 by 28-inch double-tube tires. The engine is a four-cylinder air-cooled motor, this being the first air-cooled car to tackle the heat and sand of that hard part of the desert route from Reno to Ogden (600 miles) and from Ogden to Cheyenne (400 miles). My companion is C. S. Carris, of Syracuse, N. Y., twenty-seven years of age and weighing 156 pounds.

I have added an axe to my outfit, having learned some things about the roads and sage brush. We will take a shovel, too, for the good roads movement has not hit the ground in some places. I enclose a snap shot of the outfit taken in front of the Cliff House in 'Frisco.

L. L. WHITMAN.

San Francisco, August 1.

Automatic Valve for Runabout.

Editor THE AUTOMOBILE:

Sir:—Will you please tell me the advantages relatively of the cam lifted and the automatic valve? I have a light car, an Olds, which was in perfect time according to instructions, but it ran sluggishly. I removed the inlet valve lever and replaced the heavy spring with a light one, trying till it did the best, and the car runs faster and stronger. Why is the automatic valve not the better?

M. P. GREEN.

Pasadena, Cal.

The advantages of the cam lifted, or mechanically operated inlet-valve, are, briefly, positive action and non-liability to get out of adjustment. Its chief disadvantages are, complication due to the number of extra parts necessary to actuate it, and its inflexibility, which does not allow it to accommodate its closing time to various speeds.

Advantages of the automatic valve are simplicity, cheapness of manufacture, "flexibility"—which permits it to remain open until the cylinder is completely filled with gas—and on account of its pulsating or fluttering action it assists carburation, especially at low engine speeds. The disadvantages of the automatic valve are many. Among these are, sticking to its seat, liability to get out of adjustment, noise, tendency to break its stem and cotters owing to its chattering

action and difficulty of correctly adjusting the tension of the spring.

In answer to your direct question, "Why is the automatic valve not the better," we may add that the automatic valve is more delicate than the mechanical, and gets out of adjustment much more easily, and is therefore less suited to motors on runabouts than the mechanical valve.

With a correctly designed and correctly timed mechanically actuated valve your motor should at any constant speed develop more power than with the automatic valve.

Effect of Street Rubbish on Tires.

Editor THE AUTOMOBILE:

Sir:—It seems to be the custom of too large a portion of our population to deposit its rubbish in the street or highway. In

size of a brad up to a twenty-penny scatters them off one by one. The truckman never gives a thought to his death-dealing and destructive carelessness until his horse steps on a rusty nail protruding from a box cover dropped from a load hauled by another of his own calling. When his horse dies of lockjaw he protests with vigor against the carelessness of the other fellow. Not so with the motorist who picks up the loose piece of board by the nail that protrudes an inch or more, quickly finding the wind in his tire and letting it out, while perhaps the board flies through the air, smashing a lantern or breaking a mud guard. The motorist makes no protest but gets out his repair kit and proceeds to patch the punctured inner tube or to replace it, mentally congratulating himself meanwhile,



WHITMAN AND CARRIS, AT CLIFF HOUSE, SAN FRANCISCO.

addition to the broken bottles, barrel hoops, spring beds, antiquated hoop skirts, and bustles that find a place on the highway, there is a class of specialists in this line of distribution who travel the public roads and streets contributing their mite to the tire-destructive material as they go along.

Among the latter is the milkman, who carelessly throws his broken bottles against the curb and innocently slumbers homeward from his morning's work oblivious of the pain and sufferings of the bare-footed child or the destruction of the tires of the carriage, bicycle or motor car that happens to come in contact with the sharp edges of his broken glass.

The truckman with his load of empty packing boxes and crates with loose covers bristling with sharp pointed nails from the

probably, that he has not been held up for exceeding the local speed limit of eight miles per hour by the same authorities that granted a license to the truckman to distribute nail-studded boards on the public highway.

The delivery wagon of the bottling establishment adds to the contribution of broken glass; the lamplighter—who ever saw him remove broken glass from the vicinity of the lamp on which it has broken? Then there is the linemen of the telegraph, telephone and trolley companies, who nip off the surplus wire in pieces from an inch to a yard long. The junk man never counts the loss of a pitchfork or a few old horse-shoes with nails in them worthy of replacing in his wabbling old wagon when they drop off, but the driver of a rubber tired vehicle

traveling in his wake has reason to bemoan the other fellow's loss.

I never approach a newly planked bridge without a feeling that I may find one or more of the nails so considerably left by the carpenter who planked it.

In driving an automobile upwards of 30,000 miles, I have had about as varied a tire experience as falls to the lot of any one operator, yet I never had but one puncture from broken glass that put the tire out of business at the time; but I would prefer to get a puncture from a nail and have it over then and there than to have the covering of my tire scored all over by broken glass, as in nearly every case when you get a cut from glass it goes through the canvas, letting water and filth in to be absorbed by the fabric and rotting it until it becomes so weak that the shoe will blow out.

What is more exasperating on a beautiful day when spinning along over a smooth piece of road exhilarated by the fresh air than suddenly to hear a bang as of a pistol shot and feel that grinding bumping of your car as it gradually slows down on a deflated tire? You find upon examination that there is a hole in your shoe that you can put your fist through and a tear in the inner tube running in three different directions. If you will notice carefully you will find that the direct cause of the explosion is that the covering of the casing was cut by some glass or other substance, thus letting water and mud in to rot the canvas.

There are laws and ordinances enough prohibiting the throwing of rubbish in the streets and highways, if properly enforced, to reduce tire troubles to a minimum, and if a small percentage of the attention devoted by public officials to controlling the speed of motor cars could be diverted to the prevention of this nuisance their efforts in this direction would merit the approval not only of motorists, but of bicyclists and owners of valuable horses and rubber tired vehicles of all kinds.

ASA GODDARD.

Worcester, Mass.

Corrections.

Editor THE AUTOMOBILE:

Sir:—My article in the August 6 issue, under the heading "Cure for Ignition Troubles," has two errors which I would like to have mentioned in your next issue. One was, I presume, a typographical error, and was as follows:

"Have the two points on the switch close enough together so that in charging the switch lever will not rest on both points." The "not" is extraneous and is a bad mistake, as the object in placing the two points close together is to allow the switch lever to rest on both at the same time when charging, and on either point separately when using battery or dynamo.

The other error is in the last paragraph, which reads "is about exhausted when re-

duced from 1.2 to 1.3." The figures should read 1 to 1.1.

C. T. V.

Bloomfield, N. J.

Hints on Dry Batteries.

When installing dry batteries, be sure that the paper cases or envelopes are on each cell. If these envelopes are left off and if the cells touch each other they will short circuit. See that the paper caps on the bottoms of the cells are also in place. If the cells are carried in a wooden box or receptacle, no damage will result if the bottom caps are left off, but short circuiting will result if the batteries are placed in a metal case without the caps. Handle the cells carefully, because if one is dropped the carbon plate which projects through the top of the cell, which is very brittle, may be fractured. This will render the cell useless.

When tightening up the binding screws on dry cells, use a small pliers, and be careful not to strip the threads or break the carbon plate. See that the binding screws are securely fastened in the carbon plates, and that both make good electrical connection.

When wiring up a set of dry cells, allow sufficient slack in the connecting wires to prevent them from breaking should the cells happen to shake around. Sometimes when the connecting wires are tight the insulation will be sawed through by the edge of the zinc cylinder, which forms the containing vessel of the cell, and a short circuit results.

If batteries become exhausted quickly and for no apparently good reason, examine the bottom of the box in which they rest.

This box is usually made of wood, and is often secured to the machine by means of a metal strap which passes under the bottom. This strap is usually fastened to the box with screws, and the latter may be too long and may project through the bottom of the box on the inside. It is plain that if the cells are resting on these projecting screw-points the vibration of the car will soon force the screws through the paper covers. The screws will then short-circuit the zinc shells, through the metal strap on the bottom of the box.

Storage batteries may be short circuited in this way as well as dry batteries, but with more serious results. In this case the screw or nail points—as the case may be—will punch a hole through the jar or cell which contains the liquid or electrolyte, allowing the latter to leak out, and in this way render the cell useless.

Batteries which have been damaged in this way may be repaired (temporarily) by plugging the holes with chewing gum, which has been masticated for a little while. Use a good-sized lump of gum. This should be applied on the outside of the containing cell or jar, and held tightly in place by means of a tape. After the hole is stopped fresh solution can be put into the cell, and the battery charged up, if it needs it. It is hardly necessary to add that the offending nail or screw should be removed before the battery is again placed in the battery box.

One good point about gasoline is that it is not only incapable of making things with which it comes in contact dirty, but will effectually remove grease and other spots from almost anything.

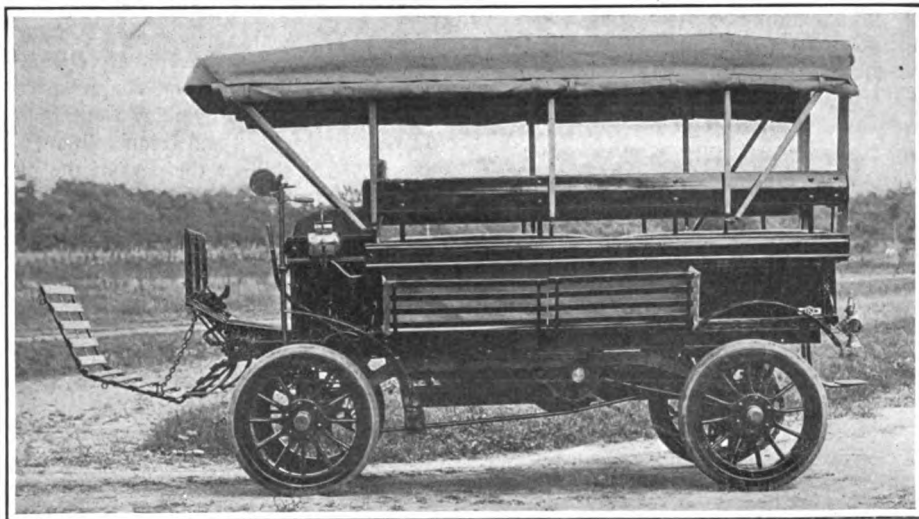

The colonial 'bus shown herewith has just been completed by the Knox Automobile Company and shipped to C. H. Martin, who is conducting an automobile stage service in Porto Rico. The 'bus has a regular double opposed Knox air-cooled motor. The special body seats fifteen passengers and has room in addition for baggage and mail. The car has a wheelbase of 96 inches and tread of 56 inches. The wheels are fitted with 4-inch solid rubber tires. There are two folding side racks that let down for carrying luggage and one that lets down in front for carrying mail pouches. The weight complete is 3,580 pounds. This vehicle can be converted into a patrol wagon by leaving off the racks. Orders for four similar 'busses for transferring passengers and baggage in Pittsburg have been placed by the Pittsburg Transfer Company.



VOL. XI.

No. 7

Published every Saturday by
THE CLASS JOURNAL CO.,
 Flatiron Building, Madison Square,
 NEW YORK CITY.

Cable Address - - - Autoland, New York
 Long Distance Telephone - 300 Gramercy, New York

SUBSCRIPTION RATES:

United States, Canada and Mexico, - One Year, \$2.00
 Other Countries in Postal Union, - One Year, \$3.00

To Subscribers—Do not send money by ordinary mail.
 Remit by Draft, Post-Office or Express Money Order,
 or Register your letter.

FOREIGN SUBSCRIPTION AGENTS:

ENGLAND:—Iliffe & Sons, Limited, 3 St. Bride Street,
 Ludgate Circus, London, E. C.

FRANCE:—Boyveau & Chevillet, 22 Rue de la Banque,
 Paris.

GERMANY:—A. Seydel, Mohrenstrasse 9, Berlin.

To Advertisers—Copy or changes in orders for adver-
 tisements should reach us not later than 5 o'clock p. m.
 Monday for the issue of Saturday following.

Copyright, 1904, by The Class Journal Company.
 Entered at New York, N. Y., as second-class matter.

The Automobile is a consolidation of The Automobile
 (monthly) and the Motor Review (weekly).

Copies Printed This Issue, - - 12,000
 " " Since Jan. 1, - 397,800

Illmax in Reliability Tests.

Almost simultaneously with the successful conclusion of the largest and longest organized automobile tour ever held, not only in this country but anywhere in the world, comes a climax this week in another form of the practical demonstration of the degree of perfection to which the new means of transportation, scarcely yet a decade old in this hemisphere, has been brought—the non-stop run. The completion of the arduous road run from New York to St. Louis and back in fifteen days by a large touring car carrying three or four persons, and the running of 1,000 miles on the Grosse Pointe track in thirty hours, both without stoppage of the motor, should deal the death blow to that frayed old pun about the automobile that "ought to mope but won't."

Any one who has a personal knowledge of our wagon roads between New York City and St. Louis, either by way of Chicago or Pittsburg, will have a proper respect for any car that can make the trip in two weeks under the weather conditions that have prevailed this month; then add to this the incessant watchfulness and nursing required to keep the motor from stopping even once in the 3,000 and odd miles, while climbing steep and rough ascents, sliding into ditches in the darkness on strange roads, and meeting all sorts of unexpected obstacles. The difficulty of keeping batteries, plugs and carbureter continuously

in working condition is recognized, even with the best of motors.

The track test of 1,000 miles, while lacking most of the elements of ordinary road traveling, possesses the merit that it can be constantly watched and checked by a corps of disinterested persons, and by any number of spectators who care to verify for themselves the claims made.

These three supreme tests of the reliability of transmission, engine and running gear of both the American and foreign motor car are gratifying contrasts to the early experience of many purchasers who have good naturedly made fun of their mishaps and disappointments, but courageously stuck to their faith in the final and early development of the entirely dependable road car. Their faith is having its reward now. With the season's remarkable successes in bringing to America the world's records in speed trials on straightaway and track, in mountain climbing up Mount Washington, and in continuous road driving throughout a fortnight or more over all sorts of American highways, it now becomes necessary to look for some new form of competition to set as a test. Speed, power and reliability have been pretty thoroughly demonstrated, but there are left as factors insufficiently tested, simplicity and ease of operation, responsiveness of motor, steering and brakes, and general comfort and convenience.

Foreign countries have gone farther along these lines than we have in this country, their gymkhana contests, anti-skidding and anti-dust raising trials, starting, stopping, and standing start speed competitions, and tire bursting demonstrations being promoted with these objects in view. Events of this nature would lend a welcome variation to our race meet programs, especially in the smaller cities where it is difficult to secure entries of high powered and very fast cars. Spectators grow weary of a long program of slow races and walkovers, especially if the events are all of the same character and length. The so-called gymkhana events introduce entirely novel and frequently amusing contests of skill on the part of the operator and adaptability of the car that hold the interest of the spectator, and have a certain value of their own.

**Proposed Road to Long Island.**

There is a generally admitted need for a direct route, broad enough and straight enough to admit of high speed without annoyance to the public, by which automobilists may get from Manhattan to the suburban region of Long Island. One of the most feasible suggestions to be made on this subject comes from Henry Clay Weeks, the well-known sanitary engineer, who has done such effective work in ridding various Long Island communities of mosquitoes. It is to start from the eastern terminus of the Blackwells Island Bridge (now building), and convert Jackson avenue and the con-

necting street through Flushing, Bayside and Little Neck into a parkway 200 feet wide, which will extend almost straight from the bridge to the city line near Success Lake. From there it could readily be extended to meet the Jericho turnpike near Westbury; or one can reach any point on the island by splendid roads without such extension. In this connection it is proposed that the marshy and now almost valueless lands about College Point and at the heads of Flushing and Little Neck bays be drained by tide gates and converted into recreation parks for the rapidly growing population of the metropolis. If not so converted, these lands will be built up with various factories, which will depreciate greatly the value of the surrounding land for residential purposes.

The value to automobilists of such a highway as the above will be particularly manifest in connection with the proposed speedway from Floral Park to Hicksville, announced in a recent issue. From the end of the boulevard at the city line to Floral Park is less than five miles by a nearly straight macadam road, the boulevard itself being about fifteen miles long. It is proposed in the boulevard, as in the speedway, to have separate strips for different classes of traffic, and to give the automobilists one strip to themselves. Although the boulevard would not, like the speedway, be on private property, there is every reason to believe that the speed regulations on it would not be stringent.

**Basis for Pennsylvania Toll Charges.**

Pennsylvania toll road companies appear to have a high appreciation of automobile horsepower ratings—much higher than new purchasers of motor cars, who have tried to climb some of the Pennsylvania mountain roads. A Lancaster County turnpike company whose charter provides for a charge of 10 cents for every five miles for "a chariot, coach, phaeton or dearborn with one horse and four wheels" and 12 cents for five miles for two-horse vehicles, "and for every other carriage of pleasure, under whatever name it may be known, the like sums according to the number of wheels and horses drawing the same," has apparently assumed that one horsepower is equivalent to one horse. On this basis it would charge \$2.40 for every five miles for a 40-horsepower touring car. Should it take full advantage of the rights conferred by its charter, we might expect it to multiply the toll rate by five, "according to the number of wheels," as follows: Front wheels 2, drive wheels 2, steering wheel 1, flywheel 1, change speed gear wheels 7, drive sprockets 4, cam-shaft gear wheels 2, pump gear wheel 1—total 20. A chariot or dearborn has four wheels and an automobile twenty, ergo, multiply \$2.40 for forty horses by 5—result, \$12 for traveling over five miles of wornout turnpike.

Magistrate Cornell now denies that he said it. As near as he came to saying it was to remark in an aside to a bicycle policeman in connection with a particularly bad case of reckless driving, that "in case any of these people had been run over and injured I should not have blamed them very much if they had shot at the automobilist." To a reporter the following day the magistrate told of several cases of reckless driving that he had personally witnessed and said that one of them was "a case where probably the only thing that would have stopped the automobilist was a shot gun." But still he denies that he "ever advised anybody to shoot at anybody else." He admits that he declined to make any explanation of the remarks attributed to him to the Automobile Club of America upon request by the secretary, and evidently he did not think it worth while to make a denial until the club showed an earnest of its intentions in the matter by adoption of the resolution to prefer charges against him. The judge says, in the same interview, that it is most disagreeable to see his name constantly in the public press; and, from the nature of the subject in connection with which his name has appeared daily for a fortnight, his sentiment is no cause for surprise.



Whitelaw Reid has told Rye, N. Y., that its local police should exercise their stop-watches on the drivers of fast horses as well as of automobiles. He approved their zeal against the latter, "on grounds of both safety and revenue;" but he forgot that the automobilists who make enforced contributions to Rye's treasury come from outside—most of them couldn't be hired to live in Rye,—whereas the horsemen are mainly a local product. The suggestion is excellent, but there is no danger of its being carried out.



In our report of the recent "Climb to the Clouds" on Mount Washington a typographical error is responsible for the statement that the average grade of the road on which the trails were run is 17 per cent. This is incorrect. The average grade is actually 12 per cent.

JERSEY ROAD MAPS FREE.

Because of the reputation New Jersey is fast gaining for its superior macadam roads, and the great number of requests from automobilists asking for information as to routes by which they can pass through the State over good roads, the Commissioner of Public Roads of New Jersey has prepared and now has ready for distribution a map of the entire State showing the improved roads in red and the unimproved roads in black.

These maps can be procured gratis upon application to Henry I. Budd, State House, Trenton, N. J., or at the New Jersey Exhibit at the St. Louis Exposition, which is in charge of Henry I. Budd and R. A. Meeke, the State Supervisor of Roads.

500 CARS WANTED FOR G. A. R. VETERANS.

Many Owners Offer Machines to Take
Old Soldiers for Run Over Historic
Ground on August 18 During Boston
National Encampment.

Special Correspondence.

BOSTON, Aug. 8.—Plans are rapidly maturing for the automobile run which is to be one of the great features of the entertainment of the Grand Army veterans during their national encampment in this city next week. The plan of giving the veterans a ride in automobiles round about Boston was suggested some time ago, and, after consideration, the entertainment committee of the encampment decided to send out circulars to automobile owners in Boston and within a radius of twenty miles of the city, asking them to cooperate with the committee. The responses were quick and numerous. Private owners in almost every town and city in the vicinity of Boston offered to lend their machines for a day and almost without exception the owners offered either to act as drivers themselves or to provide chauffeurs.

The expectation of the committee, when the plan was first broached, was that it might be possible to obtain two score or more machines, and that with these perhaps a hundred old soldiers could be taken out into the country for a day's enjoyment. The first mails after the circulars were sent out, however, brought in nearly 100 favorable replies, and from day to day the number has been increased, so that at the present time the committee has had placed at its disposal nearly 300 cars, from runabouts to touring cars. But with the growth of the number of machines at its call, the plans of the committee have expanded, and it is now hoped to secure as many as 500 cars for the tour.

As soon as the veterans heard of the plan they began to send in requests for places in the cars, and the number of requests now at hand far outnumbers the accommodations that can possibly be secured. So far most of the cars secured are privately owned, but the committee hopes to be able to induce the manufacturers and agents to make up the required number. This the makers and agents are willing to do so far as lies in their power, but at this season of the year they have not a large supply of extra machines on hand.

Plans for the tour have been practically completed, and no matter how many machines are secured it will not be necessary to change them. The day has been set for Thursday, August 18, and it is expected that noon-time of that day will see the largest number of automobiles gathered, at Symphony hall, at the corner of Huntington and Massachusetts avenues, in Boston, that has ever been collected in one place in New England. The run is to start at 1 o'clock in the afternoon and will be in two divisions, each under competent leaders and pacemakers. The first section will proceed down Massachusetts avenue, across the Harvard bridge and through Cambridge to Harvard square, where the veterans will have an opportunity to see the grounds and buildings of Harvard college, the Washington elm and other historic spots. Continuing up Massachusetts avenue the cars will pass through Arlington along the route of Paul Revere to Arlington Heights. All along this route there are houses and places associated with colonial and revolutionary history which the veterans will be able to identify by means of guide-books and maps that are now being prepared.

At Lexington Green a short stop is to be made to enable the tourists to inspect the Minute Man Monument and relics of the battle of April 19, 1775. Then the procession will proceed to Concord, where another stop is to be made to give the passengers opportunity to visit places of interest. The return journey will be through Lincoln, Waltham and Newton, along the picturesque Charles River, past some of the large industrial establishments and parts of the Metropolitan park system. The return journey is to be over some of the finest roads in the eastern part of the State, including the Newton boulevard from Auburndale to Boston.

The second section is to cover the same route as the first, but in the reverse direction. It is planned to have both parties meet at Concord, where the two sections will be reviewed and the stop will be long enough for the veterans to get a good idea of the famous place.

Each automobile is to have as decorations a silk flag three feet long and two feet high on a staff with yellow streamers. On the flag will be the names, "Lexington, Concord and Cambridge," and these flags will serve as souvenirs of the journey. The entertainment committee of the encampment which has charge of the automobile tour consists of Charles H. Baker, of Lynn, chairman; Joseph B. Maccabe, of East Boston; Leonard D. Ahl, of Boston; George E. Henry, of Boston; Elliot C. Lee, of Brookline; William M. Olin, of Boston; Joseph E. Shaw, of Boston; Jesse S. Bartlett, of Boston, and Eugene B. Fraser, of Lynn. The arrangements for the automobile trip are under the special direction of a sub-committee headed by Elliot C. Lee, president of the Massachusetts Automobile Club.

GORDON BENNETT ENTRIES.

A. C. A. Racing Committee Promulgates Stringent Conditions Governing American Entrants.

The conditions governing the entry of American cars for the Gordon Bennett race of 1905 were announced by the racing committee of the Automobile Club of America on Tuesday. They require that all entries from the United States must be made through the A. C. A., by which they will be received up to December 15, 1904.

Each entrant must deposit a sum of \$600 as a guarantee of good faith, and must file with the secretary of the club by April 15, 1905, an affidavit signed by two responsible persons stating, on their own knowledge, that the car has been entirely completed for a period of over four weeks; that they have driven the car over 1,000 miles on the road; that they have driven the car over 250 miles without stopping the engine, and that they have driven the car more than forty miles in less than sixty minutes on track or road.

The racing committee will decide which of the entrants may compete in the cup race, arriving at such decision by trial, contest or otherwise as it elects. All cars must be placed for this purpose at the disposal of the committee on April 15 and thereafter until the decisions are made. Any entrant who fails to appear with his car at the times and places designated by the committee, or who refuses to undergo the tests, shall be ineligible to compete in the 1905 race and may forfeit his entrance fee. The fee will be returned to any who comply with all requirements but are not selected by the committee. Names of the intended drivers must be submitted to and approved by the committee. Any entrant nominated for the race who fails to start shall forfeit the \$600 entrance fee.

BIG DETROIT MEET.

Program of Two Days of Racing, August 26 and 27, and Parade.

Special Correspondence.

DETROIT, Mich., Aug. 8.—Detroit is planning for the biggest automobile racing event in its history in the two days' meet of the Detroit Automobile Racing Association, to be held at Grosse Pointe track, Friday and Saturday, August 26 and 27. The full official program has just been announced by Secretary E. H. Broadwell. There will be six events each afternoon. A feature of the second day will be the Detroit Owners' Handicap, standing start.

In all the events first prizes only will be given. Prizes will be special in value from \$75 to \$200. Entries close August 25, with E. H. Broadwell, secretary, 254 Jefferson Avenue, Detroit.

One of the biggest features of the meet, which is expected to prove as popular as the races, is the parade of automobiles to be held Friday morning, August 26. There will be automobiles decorated with flowers and automobile floats. Every owner in Detroit has been invited to join in making this parade a good one, and special prizes will be given for the best and second best appearing cars. The start will be at Grand Circus Park at 9:30 a. m.

The program for the two days' racing follows:

August 26: Five-mile open, any motive power and weighing under 1,432 pounds; ten-mile open, stock touring cars stripped, any motive power or weight; five-mile Manufacturers' Challenge Cup, open to manufacturers and their representatives; five-mile open handicap, standing start; five-mile motorcycle race; fifteen-mile open, any motive power or weight; record trials and exhibitions.

August 27: Five-mile open, any motive power, under 1,432 pounds; Detroit Owners' Handicap, five miles, standing start; ten-mile open; five-mile motorcycle handicap; five-mile handicap, standing start; ten-mile open, any motive power or weight.

POUGHKEEPSIE MEET PROGRAM.

Following is the list of events to be run September 16 at Poughkeepsie, N. Y.

The "Hudson"—Five miles for touring cars, classes 2 and 3 (881 to 2,204 pounds), stock machines.

"Poughkeepsie Cup"—Ten miles, free-for-all, for all classes under American Automobile Association Rules, any motive power, motorcycles barred.

"Catskill Chase"—Pursuit race, Australian style (distance unlimited). A challenge event.

"Grand Dutchess Handicap"—Five miles, open to all, handicaps to be allowed in time.

Dutchess County Fair Championships—Five-mile events, open to all machines driven by owners who have residence in Dutchess County, or in New York State within fifty miles of Poughkeepsie. Cars must be stock machines, in roadster condition; must be driven by owner and carry one person besides the driver. (a) Championship for cars of Class 3 (551 to 881 pounds); (b) Championship for cars of Class 2 (881 to 1,432 pounds); (c) Championship for cars of Class 1 (1,432 to 2,204 pounds). Cars in events (a) and (b), if they have detachable tonneaus, may remove them and race as runabouts, but under no circumstances may any car be "stripped." Cars having non-detachable tonneaus must carry the full body.

Grand Championship—Five miles, open to winners in (a), (b) and (c), and also to the second car in the fastest of these events.

In case the entries for the championships render preliminary heats necessary, they will be at one mile distances and may be held in the forenoon of the race day.

Record trials.

It is of interest to note, in connection with this meet, that the following freight rates on automobiles to Poughkeepsie prevail: Carload, from New York City, via Hudson River Railroad, \$18; from Boston, via B. & A. and H. R. R. R., \$30; from Syracuse, \$35; from Buffalo, \$30. Single machines, from New York, via H. R. R. R., crated, \$12.60; uncrated, \$14.40; via Central Hudson Steamboat Co., \$5 to \$10 per machine; from Boston, crated, \$21, uncrated, \$24; from Syracuse, crated, \$24.50, uncrated, \$28; from Buffalo, crated, \$27.30, uncrated, \$31.20.

There are fine roads from both New York (76 miles) and Boston (226 miles) for those who care to drive their cars.

COAST MOTORCYCLE TEST.

Seven Out of Fourteen Make Perfect Scores in 100-Mile Run.

Special Correspondence.

SAN FRANCISCO, Aug. 2.—The second annual reliability run under the management of the Pacific Coast Motor cyclists was held Sunday, July 31, over the course around the bay of San Francisco. The start was from the corner of Larkin and McAllister streets, San Francisco, at 7:30 a. m. The run was then through San Jose, to the Creek Route ferry slip in Oakland. The total distance was ninety-seven miles. At San Mateo, Centerville, San Jose and Oakland the contestants reported to the officials in charge of the control.

Riders finishing before or after the schedule time were penalized. No stops for repairs were allowed and several riders lost time from punctured tires.

W. J. Bowman had a perfect score until near the end of the contest, but he reached Oakland two minutes before the schedule time. C. C. Hopkins had a tire punctured, but, by careful management of his machine, succeeded in making a perfect score. There were fourteen starters, of whom seven made perfect scores.

A. Navlet and H. Fuchs rode down from Sacramento to San Francisco on Saturday night and started Sunday morning without having had an opportunity to put their machines in order. An allowance of three minutes was made for variation of watches.

The official record is as follows:

C. C. Hopkins, L. C. Black, F. M. Butler, E. L. Malsbary, J. W. Leavitt and E. C. Dreschman, 100 points each; W. J. Bowman, 98; H. Fuchs, 94; A. Navlet, 93; J. M. Litchfield, D. T. Fish, J. C. Larsen, F. E. Carroll and B. I. Bill, no score.

AUTO WEEK AT LONG BRANCH.

Long Branch will be in the possession of automobilists for the week of August 15 to 20 inclusive, if all signs do not utterly fail. The occasion will be the first annual automobile carnival of the North Jersey Coast Automobile Association, which has obtained a sanction from the racing board of the American Automobile Association to hold a race meet. There will be races of all kinds, on the beach and on the mile trotting track, the distances ranging from quarter of a mile and half a mile, for which there are no official records, to 100 miles, the longer races being run on the track and the short ones on the beach. The McMurtry electric timing apparatus will be used to insure the accuracy of the clocking. Among the novelties will be an automobile gymkhana, which will be held at the Horse Show grounds.

DEL MONTE DATES FIXED.

Interesting Events Scheduled for Three-Days' Coast Tournament.

Special Correspondence.

SAN FRANCISCO, Aug. 4.—Dates for the racing tournament to be held at Del Monte have been advanced from August 18 to 21 to August 25 to 28 by the executive committee of the A. C. of California following the return a few days ago of Chairman L. P. Lowe from Los Angeles, where he had been in conference with the officials of the A. C. of Southern California relative to both the Del Monte meet and the San Francisco-Los Angeles 1,000-mile round trip endurance run. The reasons for the postponement are that a number of new cars which it is desired to enter have not arrived from the East, and many of the members of the A. C. of California are also members of San Francisco's famous Bohemian club, and August 18 to 21 is the time selected for the latter club's annual camp life and jinks in Russian River Valley, and the members of both clubs are anxious not to miss either event. The endurance run has been deferred to the first week in September following the Del Monte meet.

Motorists going by road from 'Frisco to the Del Monte meet will start on the morning of Thursday, August 25. Friday and Saturday there will be races on the Del Monte track, and Sunday, August 28, a trip will be made round the Seventeen-Mile Drive. Several motorists from Los Angeles will attend the meet, some of them making the run to Del Monte in their cars.

The principal feature of the meet will be the initial contest for the Lowe inter-club challenge trophy, offered by L. P. Lowe as a perpetual challenge cup for clubs only. This cup is subject to challenge for any event on the ordinary meet program. While the initial event will be a five-mile race, open to any car selected by the clubs participating, it may in the future be contested for in a hill-climbing contest or an endurance run, as may be stipulated under the terms of the deed of gift, which are now being prepared. The trophy will be the most valuable cup ever offered on the Pacific Coast, standing fully three and a half feet high, and will be of elaborate design. In all probability the Automobile Club of Southern California will select Frank Garbutt's new racing car, *Snowball*, to represent it. It is expected that the Pasadena club will send a car and there are a number of candidates among the San Francisco machines, including Dr. J. D. Hill's 60-horsepower Mors in which Fournier made the Paris-Berlin record three years ago.

Another interesting event will be the deciding heat in a match between Garbutt's *Snowball* and Captain Ryus's racer, the *White Ghost*, which is also owned in Los Angeles. Two five-mile heats have already been run at Los Angeles, one being captured by each car. There is a great deal of rivalry between the two drivers and the race promises to be a hot one.

August 26.—Three miles for gasoline stock runabouts and light touring cars 10 1-2 horsepower and under; five miles for gasoline stock light touring cars, \$1,500 and under, touring condition; five miles for gasoline stock cars, 10 to 16 horsepower; five-mile Garbutt-Ryus match race; five-mile open, for stock cars, \$1,200 to \$2,550; five mile open, stock cars, 10 to 24 horsepower; pursuit race, gasoline stock cars \$1,000 and under; pursuit race, open, stock cars, \$1,001 to \$2,550; five-mile free-for-all.

August 27.—Three miles for gasoline stock runabouts and light touring cars, \$1,000 and under; ten-mile open, stock touring cars \$1,551 to \$4,000, touring condition;

five-mile open, stock cars 10 to 16 horsepower; five miles for Lowe Inter-Club Challenge Cup; five-mile open, stock cars \$2,000 to \$4,000; five-mile open time handicap for the Del Monte Cup; pursuit race, stock cars \$2,501 to \$4,000; five-mile free-for-all; pursuit race, free for all.

August 28.—Hill-climbing contest. Stock runabouts and light touring cars, \$1,000 and under; stock touring cars \$1,001 to \$2,550; stock cars \$2,000 to \$4,000; free for all.

MINNEAPOLIS TWO-DAYS PROGRAM

Special Correspondence.

MINNEAPOLIS, Aug. 8.—Arrangements have been completed for the automobile race meet to be held at Hamline Track August 17 and 18, under the auspices of the Minneapolis Automobile Club. Customary conditions will govern the several events, with the exception that the cars must be driven in road form in all races except the professional events.

Several large eastern racing cars have been entered, and two or more contests by these will be held each afternoon, for which special prizes will be awarded. In the touring car race the machines will be required to carry passengers as stipulated in addition to the ordinary touring car equipment.

Entry blanks, with full particulars, can be obtained from R. F. Jones, 1600 Hennepin avenue.

The program as announced is as follows:

August 17.—Five-mile Minneapolis Derby, 40-horsepower or under; 8-horsepower or under; two-mile, 12-horsepower or under; two-mile, 16-horsepower or under; five-mile, 90-horsepower or under.

August 18.—Challenge Race, St. Paul vs. Minneapolis, 40-horsepower or under; three-mile, 20-horsepower or under; ten-mile touring car race, 30-horsepower or under, each machine to carry three or more passengers weighing not less than 130 pounds each; two-mile, 90-horsepower or under; three-mile, 24-horsepower or under; sweepstakes; one-mile free-for-all; trials for track record.

LAUNCH RACES AT 1,000 ISLANDS.

Special Correspondence.

THOUSAND ISLAND PARK, N. Y., Aug. 8.—The next auto-boat races of the Chippewa Bay N. C. will be held August 13. Many speedy launches are entered. Three silver cups are offered the winners in the following divisions:

Class 1, boats of 5 horsepower and less; class 2, boats of 40 horsepower and less; class 3, boats of over 40 horsepower rating. The rules are those of the American Power Boat Association.

The *Comanche*, owned by S. G. Vandergrift, of Pittsburg, will arrive here next week. She was built by the Seabury Company at Morris Heights, and is equipped with a 300-horsepower engine of nine cylinders. She measures 66 1-2 feet, with a 6-foot beam. The builders guarantee a speed of thirty miles an hour.

"ADIOS" WINS LAUNCH RACE.

Special Correspondence.

ALEXANDRIA BAY, N. Y., Aug. 10.—The racing auto-boat *Adios*, built by H. J. Leighton, Syracuse, won first place in to-day's free-for-all race for gasoline boats, there being no handicap or time allowance. The distance was 14 1-2 miles, which *Adios* covered in 39 minutes 44 seconds, beating four other boats, *Pappoose*, *Roma*, *Radium* and *Carmencia*. Second place was won by *Pappoose*, a minute and a half after *Adios*.

OMAHA TROLLEY ACCIDENT.

Street Car Runs Down Automobile Party in Miller Park.

Special Correspondence.

OMAHA, Aug. 3.—An accident near Miller Park yesterday, in which C. E. Perkins, chairman of the board of directors of the Chicago, Burlington and Quincy railroad, and J. D. Robinson, of New York, and their wives, were injured was apparently due to the carelessness of the motorman of a trolley car that ran down the automobile they were riding in.

Mrs. Perkins was so seriously hurt that she was unconscious for four hours, and it was at first feared she would die. Later, however, she showed such marked improvement that it is now believed the accident will have no serious effects.

Miller Park is some distance from Omaha. The trolley line parallels the road for some distance. The crossing is near one corner of Miller Park, where the road runs obliquely.

The motorman, in his version of the accident, naively states that he saw the automobile coming some distance away, but did not take any precautions at the crossing, as he did not suppose that the automobile would attempt to cross in front of him. He did not slacken the speed of his car, he adds, although admitting that the crossing is a very dangerous one.

On account of the prominence of Mr. Perkins, the matter will be thoroughly investigated, as the street railway company is as anxious as anyone to fix the blame for the accident.

STUDYING JERSEY'S STONE ROADS.

Special Correspondence.

TRENTON, Aug. 8.—A. Marston, dean of the division of engineering of the Iowa College of Agriculture and Mechanic Arts, has been inspecting the improved highways of Mercer County as a member of the Iowa State Highway Commission during the past week to investigate thoroughly the Jersey methods of macadam road construction and familiarize himself with the working of the state road law. As the guest of Henry I. Budd, State Road Commissioner, and Frank Eppel, County Engineer, Mr. Marston went over Mercer and Burlington county roads in Mr. Eppel's Winton car.

At the recent session of the Iowa Legislature, the State college was designated as the state highway commission. It will carry on the road work under the direction of Dean Curtiss, of the College of Engineering, and Mr. Marston, who is professor.

ASSESSING AUTOS IN ALBANY.

Special Correspondence.

ALBANY, Aug. 8.—Citizens of Albany have been discovered by the city's tax assessors to own somewhere in the neighborhood of 100 motor vehicles, and as the machines cost more than a horse and carriage, as a rule, the assessors have decided to boost the personal property assessment of such citizens by including the value of their automobiles.

This will be the first year that autos have been generally assessed here as personal property. Last year only two or three motor vehicles figured in the personal property assessments. Last week the assessors made a tour of the garages and secured a list of the cars stored. They are now said to be studying up the price lists of the different manufacturers. There is not more than one \$10,000 motor car in the city, but several are over the \$2,000 price limit, while

there are a number of buckboards and runabouts costing from \$350 to \$600, \$800 and \$900. More expensive cars have been purchased this year than ever before, and the assessors' attention has been attracted to the talk and published statements of their cost. Those who have been swelling the cost of their machines for the purpose of boating of it are now regretting the fact.

AMERICAN AUTOS AT MANITOBA.

Special Correspondence.

WINNIPEG, Manitoba, Aug. 5.—With a view to increasing the interest in automobiles in western Canada, the Canada Cycle and Motor Company has arranged a good display at the Dominion of Canada exhibition which opened last Tuesday, July 26. The exhibit includes the Thomas, Ford, Autocar, Stevens-Duryea, and the Ivanhoe, the last mentioned being manufactured in the company's works at Toronto. Considerable interest has been taken in the display by a large number of Western men, and it is anticipated that good business will result.

McCulloch & Boswell are showing four examples of the Pearson Boat Construction Co.'s gasoline launches, especially designed for river work. They range from a 1-2-horsepower 16-foot to a 12-horsepower 24-foot launch built on torpedo boat lines. The Pearson Company's works are at Duluth, Minn.

MOTORIST KILLED IN MONTREAL.

Special Correspondence.

MONTREAL, Aug. 8.—The first fatal accident in this city occurred Saturday afternoon, when A. J. de B. Corriveau, president and general manager of the General Automobile Company of Canada, was run into by an electric car within a stone's throw of his office. He died from his injuries in the hospital seven hours after the accident with a fracture at the base of the skull.

Mr. Corriveau was driving his automobile alone when he collided with a street car. The impact was so great that he was hurled headlong against the sidewalk. The deceased, who was in his fifty-second year, recently took a fancy to the automobile, and developed a good business. Some time ago he was elected unanimously to the vice-presidency of the Automobile Club of Canada, recently organized in this city.

RECENT INCORPORATIONS.

D. B. Dunham & Son, Rahway, N. J.; to manufacture and deal in automobiles, coaches, cars, bicycles and boats; capital stock, \$100,000; incorporators, Emma F. Dunham, Frederic W. Dunham and T. B. Lindsay.

Peoria Automobile Co., Peoria, Ill.; capital \$5,000; to manufacture motor vehicles; incorporators, S. K. Hatfield, Charles L. Gage and E. M. Giles.

Importers' Automobile Salon of Mount Vernon, N. Y.; capital stock, \$4,000; directors, E. T. Birdsall, S. B. Bowman and E. B. Gallagher, of New York City.

Automobile Transfer Co., Cleveland, O.; capital \$10,000; to conduct an automobile livery in connection with large hotels. Incorporators, George A. Welch, F. A. Quail, G. B. Siddall, O. G. Bechtel and George McGregor, Jr.

The Interstate meet at Leavenworth, Kas., has been postponed until some time in September. W. W. Guthrie, president of the association, writes that the postponement was occasioned by the A. A. A. tour to St. Louis.



CROSS COUNTRY RUN.

Philadelphia Club's Second Annual Go-As-You-Please Cup Contest.

Special Correspondence.

PHILADELPHIA, Aug. 8.—The Runs and Tours Committee of the A. C. of Philadelphia will announce this week the rules governing the second annual run to be held October 1 for the Cross-Country Challenge Cup presented to the club by Secretary-Treasurer H. Bartol Brazier, which was won for the first time last year and is now held by A. H. Chadbourne.

One of the points which will be especially emphasized is that the run is in no sense a race (although the first man to finish secures the cup); and another that, apart from the necessity that each contestant shall report to the judges at the official stopping place in each of the four tours on the rectangular course, there will be no special route to be adhered to between these points.

In the accompanying diagram is shown the general lay-out of the route and the air-

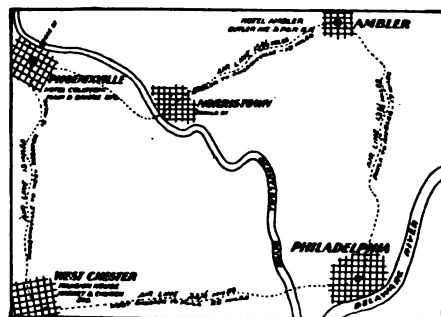

LOCATION OF CROSS COUNTRY ROUTE.

line distances between towns. In cutting across country from Ambler to Phoenixville, and from the latter place to West Chester the actual number of miles to be traveled is out of all proportion to the air-line distance, and the possibilities in the way of selection of routes are so numerous as to make a right choice of no little importance. The result of the announcement will doubtless be many quiet preliminary excursions over the various routes in an effort to secure the best, and this without giving one's opponents a line on the best going.

Between Philadelphia and Ambler and between West Chester and Philadelphia the choice of routes is limited, although by making a detour to Paoli on the last leg of the course a bad section of the West Chester pike is avoided, at the expense of several additional miles' travel.

Each contestant will be supplied with a time card, which must be signed by the judges at the various points named, who will mark thereon the time of each car's arrival and departure. A large sign will be placed in a conspicuous position in front of each stopping place.

'FRISCO CLUB TO STOP SCORCHERS.

Special Correspondence.

SAN FRANCISCO, Aug. 1.—The matter of speeding on country roads is being taken up by members of the Automobile Club of California, and it is more than likely that some definite action will result, looking to an active discouragement of the evil. Some of the local automobilists are just now ex-

periencing the speed-craze stage, and those who are not themselves bitten by the disease are frequent sufferers from it. Owing to the fact that the general use of the roads by automobiles is a comparatively recent condition in this portion of the country, there are many operators who fail to appreciate the rights of others to the public highways, as well as the dangerous character of racing speed. The result is such as has been experienced in other sections. The natural antagonism of the farmer has been increased and a number of serious accidents have aroused the authorities.

So many complaints have been heard in the past few weeks, and the adverse temper of the town authorities in many places has become so apparent that the more conservative drivers who form the majority of automobile users have become alive to the need of protection from their own class. There is therefore a disposition to create a new committee in the club which shall take up the matter of excessive speeding, investigate cases brought to its attention and report evidence to the authorities. It is felt that by co-operation with other users of the roads against the reckless drivers, the governing body among local automobilists may be able to overcome the resentment which is at present being directed against the whole class. Unless something of the sort is done there is danger that many of the most desirable roads will be closed to automobiles.

NEWS NOTES OF THE CLUBS.

PROVIDENCE, R. I.—The recent tour of the Rhode Island A. C. along the Massachusetts coast was so successful that it has been decided to hold a longer run into that state, Onset to be the destination.

VAN WERT, O.—An automobile club has been formed here with the following officers: D. L. McDonald, president; Dr. S. S. Tuttle, vice-president; M. Woodruff, treasurer, and Robert Webster, secretary.

MOBILE, Ala.—The Mobile A. C. has been formed with a charter list of twenty-six members. The following officers were elected: Gen. J. W. Whiting, president; Robt. C. Morris, vice-president; E. G. Hubbard, secretary, and Wm. A. Blair, treasurer.

WACHUSETT, Mass.—The A. C. of Fitchburg held its postponed run to Hull, Mass., last Saturday. The participants stayed over night in Hull and Sunday morning all made the run into Boston for lunch, returning home in the afternoon.

PADUCAH, Ky.—The A. C. Paducah was organized August 3, with the following officers: Col. Ben Weille, president; Henry Arenz, vice-president; Dr. Boyd, secretary and treasurer. The first club run was held last Sunday, to Mayfield, Ky., a distance of thirty miles, and return, the round trip being made without a mishap.

NEWARK, N. J.—At a recent meeting of the Physicians' A. C. of New Jersey, Dr. Frank D. Meeker, of Newark, was elected vice-president to succeed Dr. W. H. H. Bull, of Glen Ridge. The club will hold no meetings during August, but will hold a general meeting September 15. The club now has thirty members.

TOLEDO, O.—At a recent meeting of the directors of the Toledo A. C. it was decided not to fight the wheel tax, but to

submit to the law and pay the annual \$4 assessment. After the meeting those in attendance went to the auditor's office and secured licenses, Dr. Chas. P. Wagar, the club's president, being the first applicant.

HARTFORD, Conn.—At a recent meeting of twenty-five motorcyclists preliminary steps were taken toward the organization of a motorcycle club. A committee was appointed to draft by-laws and constitution, to be submitted at another meeting to be held at an early date, at which time officers will be elected and steps taken toward the establishment of club quarters.

DETROIT.—The Detroit A. C. enjoyed a very pleasant run Tuesday evening to its country clubhouse on Birmingham road, fourteen miles out of the city. About 200 Japanese lanterns were strung over the grounds. It was a go-as-you-please run out and about 125 members and friends participated. Luncheon was served on the lawn under the lanterns and the affair, the first of its kind this year, was a great success.

NEW YORK.—The New York and Philadelphia Limited is the name by which the New York Motorcycle Club designates a club run to Philadelphia and return called for August 28. The title is derived from the limitations of eleven and fourteen hours as the minimum and maximum times within which the run must be made. The distance for the round trip is 200 miles—the longest single day's run ever organized by a motorcycle club, but the roads are unsurpassed.

SPRINGFIELD, Mass.—At a recent meeting the Springfield Automobile Club decided to start a campaign to require all vehicles used at night to be provided with lamps, as are bicycles and automobiles under the existing laws. Steps will be taken at once to secure the passage of such a law. The question of speed regulations was postponed until a later meeting. The club members disclaim any intention of supporting any one in violation of the law, but object to being continually harassed by the country constables who, they say, are out for their share of the fines.

SPRINGFIELD, Ill.—The temporary organization of automobile owners of Springfield has been made permanent by the formation of the Springfield A. C., the following officers having been elected for the ensuing year: Burke Vancil, president; Henry M. Merriam, vice-president; R. B. Seymour, secretary, and Ralph N. Baker, treasurer. A special committee has been appointed to confer with the Board of Park Commissioners in an effort to have them reconsider their order prohibiting automobiles from the park after 6 o'clock, and other restrictions.

BIRMINGHAM, Ala.—Several members of the recently organized Birmingham Motor Club, accompanied by their families, will make a tour to St. Louis and return, leaving Birmingham about August 15. The distance between the two cities is 520 miles, and it is expected they will be able to make the trip in five days each way. Those now scheduled to make the trip are R. S. Munger, president of the club; Dr. J. E. Dedman, Don H. Bacon, F. G. Kinney and Mr. Brown. The entire club membership will escort the tourists out of the city and as far as Pinson.

A daily newspaper contains the following somewhat startling advertisement: "For Sale—261 horsepower gasoline touring automobile. * * * Reason for selling, owner purchasing larger machine." The natural query is, what will be the horsepower of the new car?



The resolutions adopted by the Board of Governors of the Automobile Club of America at their last meeting, to prefer charges against Magistrate Cornell, of New York city, who has made himself famous by his alleged remarks concerning the shooting of automobilists, bore fruit with wonderful promptness, the magistrate losing no time in publishing a general denial of the correctness of the popularly accepted version of the story. A short time after his "shooting talk" the board of governors of the A. C. A. wrote to Magistrate Cornell asking if he had been rightly reported, and if not, that he give his version of the affair. The magistrate's answer was that he saw no reason why he should comply with this request; and he did not. But the ink was hardly dry on the newspaper reports of the automobile club's decision to prefer charges against him before Magistrate Cornell was busy dictating a full and complete statement of the matter.

He says it occurred in this way: A bicycle policeman brought an automobilist before the magistrate, charging his prisoner with furious driving and having badly scared a lot of pedestrians and forced a cab to take to the sidewalk. After having heard the case the magistrate said in an aside to the bicycle policeman, whom he had known for years, that if any of the people had been run over he would not have blamed any of them so very much if they had shot at the chauffeur. This remark, the magistrate admitted, was an unwise one, but was not intended for publication. The magistrate says that he informed a reporter who interviewed him the next day that probably the only thing that would have stopped an automobilist who almost ran him down was shooting, but that this was not his notion of the proper way to put an end to reckless driving, which, he thinks, can best be cured by imprisoning the drivers. Moreover, he declared that his remarks, as quoted, were not responsible for the revolver practice of Deputy Sheriff Wicks at Patchogue, L. I., and that he has a document to prove it. The deputy sheriff, curiously enough, is said never to have heard of Magistrate Cornell.

President Scarritt, of the Automobile Club of America, after having read Magistrate Cornell's statement, issued an announcement through the club that the charges would be withdrawn.

* * *

Deputy Sheriff Wicks, of Patchogue, L. I., is now confronted with the certainty of having to shoulder the consequences of his act in shooting bullets from his revolver into the automobile of John Foley, of New York, on July 17, because Wicks claimed the automobile was running at an illegal speed and was not stopped when he ordered. The Automobile Club of America has taken the matter up and is standing behind Mr. Foley in the matter. Wicks was arraigned August 5 before Justice John R. Vunk on the charge of felonious assault preferred by Mr. Foley. Waiving examination, the deputy sheriff was held in \$500 bonds for trial by Grand Jury, which meets at Riverhead, L. I., in September.

* * *

The automobilists of New York city will, it seems, have either to put up with the

refusal of the ferry companies to allow automobiles to board ferry boats under power, or else bring a test case into court to settle the question. The committee of the Automobile Club of America appointed to go to Washington and endeavor to secure from Secretary Metcalf, of the Department of Commerce and Labor, a correct interpretation of the law forbidding the carrying on passenger steamers of gasoline in automobiles with lighted fires, has returned without having been able to accomplish its object. Mr. Metcalf stated that he would have to give the matter further consideration, and would give a reply later. It is believed, however, that the Secretary will find himself without power in the case. Jefferson Seligman, of the board of governors of the club, and W. W. Niles, the club's counsel, who composed the committee, stated that a legal fight may be necessary to bring the matter to a conclusion.

* * *

Only two American entries have been received for the Vanderbilt Cup race, set for October 8, both entries having been made by the White Sewing Machine Company. Two foreign cars have been entered by the Panhard & Levassor agency, and these four cars constitute at present the entire list of competitors for the cup. Correspondence is now being carried on between the racing board of the American Automobile Association and S. F. Edge, who is expected to enter a Napier car. American gasoline cars are so far invisible.

Chairman A. R. Pardington, of the racing board, calls attention to the fact that the entry list will be absolutely closed September 8, and that entries must be accompanied by a letter bearing the signature of the secretary of the automobile club the car will represent in the race.

* * *

Secretary S. M. Butler, of the A. C. A., went to Hammonton, N. J., Wednesday, August 10, to endeavor to round up a man who has been firing charges of buckshot into passing machines on the road that runs between Atlantic City and Philadelphia. The identity of the shooter is not known, but a reward of \$500 will, if necessary, be offered for his apprehension. Mr. Butler will continue his investigations in Philadelphia. Automobilists throughout the city and district are very indignant regarding the reckless use of firearms, and some have taken to carrying revolvers in self defense. Hold-ups and robberies in the name of the law by enterprising highwaymen are regarded as the probable next step in this sort of lawlessness.

* * *

Broadway is blocked at Kingsbridge, just across the Harlem River ship canal, on account of a squabble between paving companies concerning the right of the firm doing road work at that point to use a certain kind of paving block. The result is that for the past two weeks automobilists going north have been forced to turn out of Broadway and take Kingsbridge avenue and the steep and rough hill that forms the approach to the bridge over Spuyten Duyvil creek. Many cars are unable to negotiate these grades. The only other way for automobiles going north through Washington

Heights to get out of the city is to go back to Amsterdam avenue and take Washington bridge. It is possible that several weeks may elapse before the controversy is settled.

* * *

A trap for automobilists has been set at Lawrence, L. I., and machines are timed over a stretch of road by means of a telephone system. When a car has been timed as going faster than the legal speed an armed deputy jumps out of the bushes and holds up the chauffeur—very likely at the muzzle of a revolver. Most ironically, one of the first motorists to get caught was the instigator of the scheme.

* * *

One of the trapped automobilists was Samuel L. Herzig, of New York, whose case was taken in hand by the Automobile Club of America. The trial was set for Tuesday, August 9, and when the appointed time arrived the little court room at Lawrence was filled with New York automobilists, much to the surprise of Justice Tyson. The trial ended abruptly when it was discovered that Mr. Herzig's name had not been entered in the records, no defendant being mentioned in the complaint. Justice Tyson said a new warrant would be issued in correct form, but it is believed this is not legal. Mr. Herzig declared that he preferred being re-arrested in order that the case might be fought out, but it is doubtful if this can be done.

* * *

James B. Dill, of New York, has reached his destination at the Rangeley Lakes, Maine, after touring by automobile to Quebec and from there to Rangeley through the Canadian pine woods. The roads for the most part were found to be good, or at least fair, comparatively few really bad stretches having been traversed. A large quantity of gasoline was sent ahead by freight, as this fuel is very scarce in parts of the country passed through. Mr. Dill has made a complete set of descriptive charts for the guidance of future tourists over the same route.

* * *

Police Commissioner McAduo, of New York City, is considering the advisability of mounting a squad of policemen on motorcycles, which would enable them to overtake anything that came down the pike. One of the members of the force was provided with a machine a short time ago as an experiment, and the Commissioner was so pleased with the result of the test that he is said to have asked the Board of Estimate and Apportionment for the necessary funds to equip the entire bicycle squad with wheels.

* * *

It is believed by the police that burglars who have been helping themselves to the valuables of wealthy New Yorkers residing along Long Island Sound, have been traveling in an automobile. The tracks of a heavy car and traces of oil were found in front of houses that had been robbed.

Policemen out West are reported to be practicing revolver shooting so they can puncture the tires of scorchers who decline to stop. They seem to have had very poor luck so far, the tires proving hard targets to hit.



B. M. Shanley, Jr., is a recent purchaser of a 12-16-horsepower Decauville, fitted with a tonneau and folding canopy top.

R. W. Massey, of Cadillac, Mich., has secured the agency for the Northern automobiles.

The Reeves Pulley Company, of Columbus, O., has decided to commence the manufacture of automobiles, and will enter upon this class of work at once.

C. J. Durheim, dealer in bicycles and automobiles at Muskegon, Mich., has filed a petition in bankruptcy, giving his assets at \$3,700, and liabilities, \$6,600.

Walter Crawford, formerly with the Cleveland Automobile & Supply Company, has become identified with the Automobile Exchange on Prospect street, Cleveland, and has obtained the agency for the Crest.

Neff E. Parish, president of the Parish & Bingham Company, of Cleveland, has resigned his position to go into other business.

J. H. Jones and L. M. Taylor, of Charleston, S. C., have completed arrangements for the operation of an automobile passenger service between Spencer and Salisbury, N. C. One 'bus has already been received at Spencer, where headquarters of their company will be located. The Yadkin River Power and Park Company, recently organized at Spencer, will also have four automobiles running over the same route within a week.

The Auto Coach Transportation Co., now being formed at Rochester, N. Y., will soon put in operation an automobile passenger coach line between Rochester, Fairport and Penfield. The vehicles will be of thirty horsepower, and have a carrying capacity of twenty-five passengers.

Herman K. Haupt, superintendent of the garage of the Washington Electric Vehicle & Transportation Co., of Washington, D. C., has been arrested on a charge of embezzling certain funds of the company and has been held in \$1,500 bond to await the action of the grand jury. Haupt has been connected with the company for the past five years.

The Peerless Motor Car Company has sold a special 24-horsepower car to John D. Rockefeller, who recently sent invitations to all the Cleveland automobile dealers to send cars for his inspection to his summer home east of the city. The Peerless took his fancy and he ordered a special body with silver trimmings and pearl inlaid steering wheel. The car will cost him \$5,000.

Through the courtesy of the Washington Jockey Club the Central Labor Union has made arrangements to hold automobile races at the Bennings race track, at Washington, on Labor Day. The Washington Automobile Racing Association has sanctioned the undertaking, and will lend its support toward making the event a success.

A three-cylinder Thomas Flyer took part in the Toronto (Canada) automobile races Saturday, August 6, and won first place in the five-mile race for stock cars and was a close second in a two-mile race for cars costing less than \$7,000. The machine was a new one, fresh from the factory.

The District Attorney of San Mateo County, California, has prepared and presented to the board of supervisors an ordinance limiting the speed of automobiles in the county to five miles an hour on the

mountain roads and fifteen miles on the main country roads. Operators must procure a permit from the county clerk, at a fee of \$1, and the applicant must show that he is a skillful operator of at least two months' experience. There are various other provisions and a maximum penalty of \$500 fine or six months' imprisonment is provided for violation of the ordinance.

The Boston Automobile Trade Association has been organized with seventeen charter members. The officers are: President, W. W. Burk; secretary, A. T. Fuller; treasurer, A. P. Underhill. The board of directors consists of the officers and W. E. Eldridge and A. H. Bangs. A committee consisting of W. E. Eldridge, Benjamin Smith and A. F. Underhill has been delegated to make application to the N. A. A. M. for a sanction to hold a one-week show immediately after the New York automobile show, or as soon thereafter as possible.

The manufacturers of the G & J tires, Indianapolis, Ind., are calling attention to the fact that every one of the twenty-three motorcycles that participated in the recent New York-Albany endurance run of the F. A. M. were fitted with G & J tires. George Breeze, of Newark, N. J., was scheduled as using tires of another make, but in a letter to the G & J Tire Company he stated that this was an error, his tires, which he is still using, being the same as the others.

The Packard Motor Car Company's representative at the St. Louis Exposition will be Arthur Visick, formerly with the English Napier Company.

A Michigan light touring car, recently purchased by Dr. F. J. Dudley, of Cerro Gordo, Ill., was driven by him from the factory at Kalamazoo, Mich., to his home, a distance of about 250 miles. It is reported that the trip was a very successful one, and that Dr. Dudley intended entering his car in the St. Louis run.

The plant of the Providence Steel Casting Company, Providence, R. I., has been enlarged to meet the growing demand for this class of goods. The new foundry is 166 feet long and 118 feet wide, and is completely equipped for handling both raw materials and finished castings. The plant has a capacity of 100 tons a month and handles work weighing from a few ounces up to tons.

Trials of steam railway motor cars have been so successful on branches of the Great Western Railway Company, of England, that they are now being used on three divisions of that road. The cars are built after the American plan, with a center aisle running the length of the car. The vertical boiler is in one end, separated from the passenger space by a partition. The engine has two cylinders with piston rods driving direct to the truck wheels, locomotive fashion. Power enough is developed so that an ordinary car can be hauled as a trailer. The motor cars accommodate fifty passengers and cost \$9,733 each.

The Boston branch of the Pope Manufacturing Company will hereafter be under the management of W. J. Foss, formerly of Washington, W. E. Eldridge, the former manager, having resigned.

A party of Indianapolis automobile tourists arrived in Buffalo last Saturday after-

noon on their way to Boston. The party consists of Mr. and Mrs. F. M. Ayres, Miss Hoegh and W. C. Bobbs. They are travelling in a 40-horsepower Premier touring car. They left Indianapolis last Tuesday and made 180 miles the first day. It is planned to reach Boston by Thursday. Mr. Ayres said the roads in most places were fairly good.

The Chicago, Burlington & Quincy R. R. is experimenting with electric motor cars with a view to adopting them for use on the line between Sterling and Shabbona.

Superintendent T. M. Ellis, of the Rockford and Interurban Railway Co., Rockford, Ill., is using a Pope-Waverley in overseeing the work on the various lines of the company.

An ordinance regulating the speed of automobiles, providing for their registration and numbering, and taxing owners \$1 for a permit to operate them on the streets is now in force in Birmingham, Ala.

The Covenant Baptist Church of Chicago has recently been holding a series of street meetings, using an automobile in lieu of the conventional horsedrawn gospel wagon.

The town council of Pottsville, Pa., has passed an ordinance limiting the speed of automobiles to a mile in twelve minutes going down a declivity or turning a corner, and eight miles an hour on level ground. It provides a fine of \$100 for violation.

The Golden Gate Park Commissioners of San Francisco have announced that in addition to the South Driveway the automobilists will in the future be allowed the use of the East Boundary Driveway of the park, which crosses the ornamental park bridge and gives a short straight route to the surf-line at automobile beach.

The California Auto Express Co., of San Francisco, which was organized to conduct a general automobile business, is now preparing to put in operation in connection with its other business a general freight and passenger service, using a type of vehicle similar to that now in use by the General Omnibus Company of London. The company will also have the agency for several well known cars.

Representatives of the Packard Motor Car Co. appeared before Judge Phelan, in Detroit, last week, on the complaint that they had duplicated license numbers. The company employs a large number of demonstrators and every day is sending machines out for their road test. The duplication of the license numbers was confusing to the police and Judge Phelan suggested that it would be much better if the company would purchase a license for each demonstrator in its employ and require him to put his license tag on the machine he is taking out. If the licenses were kept in the name of the demonstrator no confusion would result. The company could then send notice of the dismissal or retirement of the demonstrator from its employ to the secretary of police, and a correct record could then be kept. The purpose of the law, Judge Phelan explained, was not to keep track of the machines, but of the operators. The company agreed to take up the method and it is regarded so favorably by other local manufacturing concerns that it is thought others will follow suit shortly.

THE AUTOMOBILE

WEEKLY

NEW YORK—SATURDAY, AUGUST 20, 1904—CHICAGO

10 CENTS

AUTOMOBILE WEEK AT THE WORLD'S FAIR.

City and Exposition Given Into the Hands of the Tourists and St. Louis Club Members, Who Hold a Monster Parade Through the Fair Grounds.

Special Correspondence.

ST. LOUIS, Aug. 12.—In a blaze of glory and very hot sunshine, the sixty-eight cars of the successful tourists, escorted by nearly 200 local and visiting machines, started from the Jefferson Hotel this afternoon for a parade of the city and the Fair grounds. Many of the local and some of the tourists' autos were gay with flags, colored tissue and bunting, and for nearly two blocks the wide street was choked with cars and brilliant with color before the start. Half the pretty

women of St. Louis seemed to be in the machines, and the other half, after a couple of miles through smooth but not aristocratic streets, were discovered on the porches and lawns bordering the route of the parade.

The start was made at 1.30 p. m., and the paraders were piloted to Forest Park, through which they passed before they entered the Fair grounds, by the city's police automobile, bearing Chief of Police Kiely and three officers, and by Mayor Rolla Wells in his white Peerless and President

A. B. Lambert, of the St. Louis Automobile Club, carrying the members of the police board. Behind them came the tourists, headed by Augustus Post, with President Whipple, of the A. A. A., as passenger. With two or three exceptions, the tourists were arranged in the numerical order of their cars. Behind them swarmed the escort cars, their immaculate paint and gay colors in striking contrast to the dusty and weather-worn Easterners.

The route was via Chestnut, Twenty-sec-

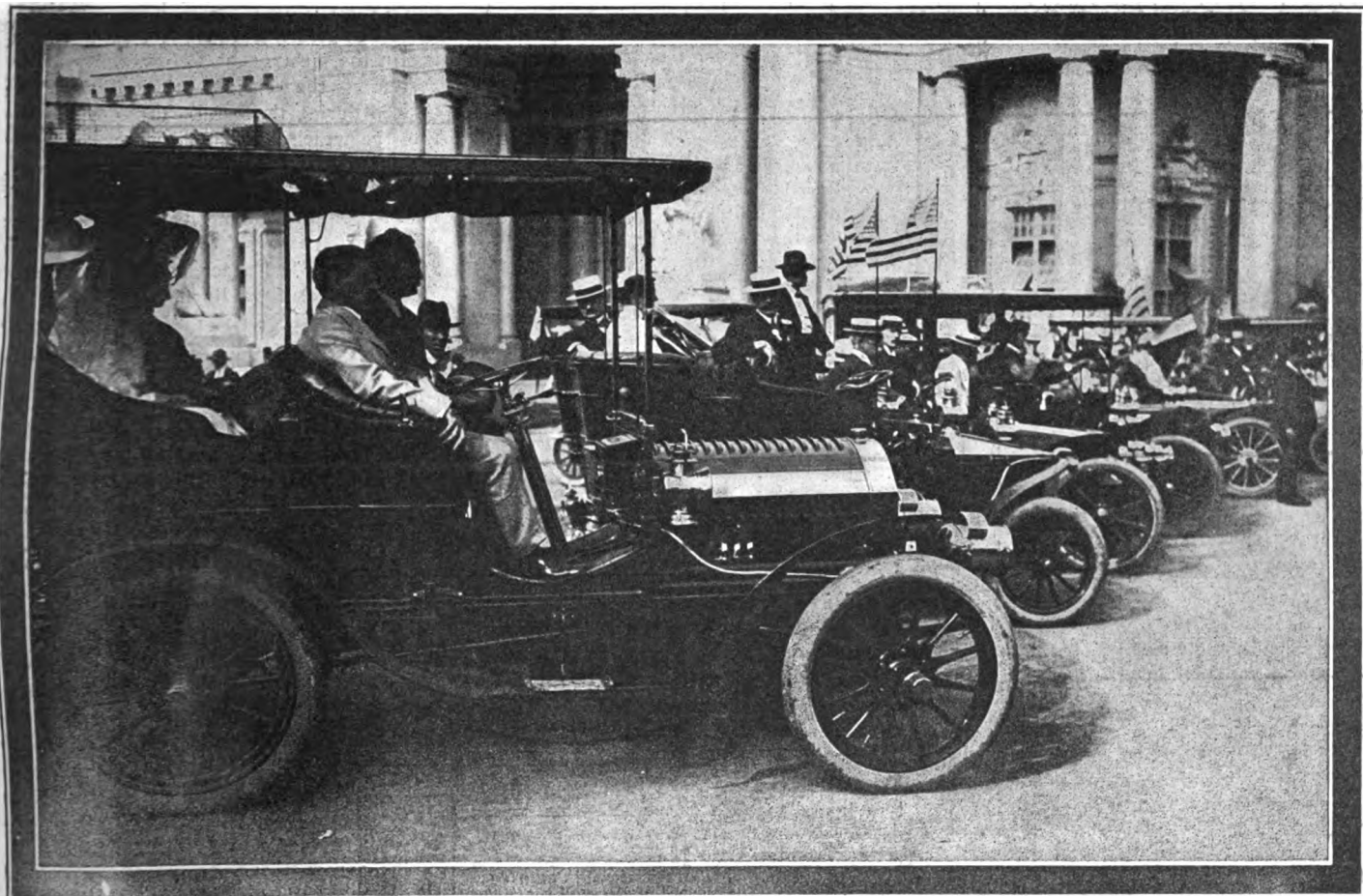

PRESIDENT FRANCIS, OF THE EXPOSITION, AND PARTY REVIEWING THE PARADE IN FRONT OF THE ADMINISTRATION BUILDING. President Francis Occupies the Left Front Seat in the First Car.

ond and Pine streets and Lindell Boulevard, and the inevitable waits at the start and at the entrance to the Fair were atoned for by fair speed along the way. Each car was furnished with a special permit admitting it and its occupants to the Fair, with the understanding—to which no one seemed to pay much attention after the reviewing stand had been passed and the parade was officially over—that no occupant was to leave the cars.

Because the paraders were on wheels, a very long line of parade could be laid out, and nearly every portion of the immense grounds was traversed, only the "Forest," the Philippine exhibit, and the agricultural and horticultural sections being left out.

At the States entrance the paraders were met by President D. R. Francis, of the Exposition; Willard A. Smith, Chief of Transportation; Gen. Edmund Rice, Grand Marshal Fest, and Major Hammond, of the Jefferson Guards, and the chiefs and leading officials of the Exposition, together with a band, in three of the big electric breaks used to take parties of visitors about the grounds. These now led the paraders through their devious journey past the States buildings, the palaces, halls, and statues, through the Plaza of St. Louis, and by the lagoon, and down The Pike; and at length President Francis drew to one side, and Messrs. Post and Whipple, and John Farson, of Chicago, who, though unable to join the tour, had come down by train with his new white Thomas car, drew to the opposite side of the road near the Government Building, and between them the paraders passed in review. The little delay thus caused gave some of the tourists an opportunity—promptly seized upon—to secure the Wild Man of Borneo, the Hindu juggler, and several Chinamen, and give them the ride of their lives.

Following the official end of the parade, a dash was made for stands purveying liquid refreshment. Soon there were many attractive glimpses to be seen about the piazzas of the open-air restaurants, each with a group of empty automobiles in the foreground, on the piazza little groups of becaped and cheerful motorists seated beside nut-brown maids and matrons with the inevitable badges, before them tall glasses and mammoth steins, and around them the ruralite, thirsty but for the most part speechless in the midst of tuneful snatches of "Meet Me at the Fair," "The Star-Spangled Banner," and "Dixie," all against a background of awkward waiters and of staff and stucco rather the worse for wear. As a "big beer" costs a quarter at these most hospitable refectories, the visitors could not be blamed for getting as much fun as they could for their money.

Personal Impressions of the Parade.

Special Correspondence.

ST. LOUIS, August 12.—This city went wild over automobiles to-day. One could

almost have run his machine down through the busiest sections of the city on the sidewalk and no one would have questioned. Every policeman came to attention and saluted, and everyone turned to look at the machines as they passed along the street. The only way to get arrested was to run down and kill a man, for nothing short of manslaughter would have called out an official reproof.

It was Automobile Day at the Exposition, and the "bubbles" had right of way over everything. Even the cast iron regulations for vehicles at the Fair grounds were broken, and among other things the sacred Pike itself was invaded by "devils"—red and other colors.

The parade was the longest, the grandest and the most gorgeously decorated affair of its kind ever held in America. In line were machines of every color, style of propulsion, size and design, from the motorcycle with a chair strapped on for an extra passenger, to the gigantic triple-deck electric 'bus used as an observation stand and weighing several tons.

There were cars from the East and cars from the West, from the North and from the South, as well as many cars made and owned here in St. Louis. Nearly every large city in the country was represented, and the tourists took pains not to conceal their identity. Scores of signs on the cars showed what city and State the vehicles hailed from, and the general appearance of the tourists' machines plainly showed the battles they had gone through on the roads, good, bad and indifferent, in order to be at St. Louis in time for the procession.

As these vehicles formed in line, some as early as 10 a. m., the crowd surrounded them and plied the drivers with endless questions, many of them unanswerable. By 1 o'clock, the time for the parade to start, the entire street was alive with moving automobiles and the curb on either side for several blocks was thickly lined with motor cars. Chief interest centered in those that had come on the tour, but the local private owners and dealers turned out in numbers, and many a stock wagon that was never intended to be taken out until sold went into the parade.

Like most big parades, it was utterly impossible to get it under way in anything like good order or time. At 2 o'clock it started, headed by Chief of Police Kjely in his new municipal automobile, followed by Mayor Wells in his new 24-horsepower machine and an escort of twenty policemen in big electric automobiles. Then came the members of the St. Louis Automobile Club in more than one hundred machines, followed by the tourists, whom Messrs. Tucker and Downs had been frantically endeavoring for two hours to straighten out according to entrance numbers. The parade was in pretty good order when it started, but there was a changing of places throughout the march occasioned by the dropping out of some whose machines went wrong and the

crowding in of some of the unattached automobilists, who were scheduled to bring up the rear section and didn't like that position so much as one ahead. There were bumps, and lots of them, during the six-mile parade to the grounds, and lamps to the value of several hundred dollars were damaged.

After passing in review over several miles of streets inside the grounds, the motorists were allowed to roam at random and take such short cuts over sidewalks and lawns as they pleased. The machines entered the grounds and whirled around curves in a way that led many to prophesy numerous accidents before the day was over, but the skill of the drivers prevented any such occurrence.

Before the parade started each driver was handed a permit to take his machine in the grounds, but was forbidden to drop out of the line or to allow any passengers to get out. It was the first visit of the majority of the tourists to the Fair grounds, and it was necessary to invent some excuse for dropping out of the line in an honorable way. The only thing to do was to have a breakdown of some kind, and these occurred more frequently on the two or three-mile parade around inside the grounds than they ordinarily would on a hundred-mile stretch of country road. At any rate, when the parade proper withdrew from the grounds, fully 100 machines were still within the gates, some really crippled, but the majority deserted by their occupants, who were taking in the sights.

Among the curious things that one noticed during the parade through the city was the wearing of automobile goggles by the motormen on the St. Louis street cars.

A number of the machines stopped at different concessions along the Pike while the parade was passing through, and loaded up with "freaks." Denzer and Jay captured the "Wild Man from Borneo" at the Ostrich Farm on the Pike and piled him into their car, which was occupied by several newspapermen. In this manner they rejoined the procession and finished touring the grounds. Harold Pope, not to be outdone, made a descent upon the Japanese village and loaded his big Pope-Toledo down with pretty Japanese maidens attired in their native costumes. Other machines followed suit, and it is doubtful whether there were any freaks worth while left on the Pike after the parade had passed.

Each machine, with all its occupants, was admitted to the grounds free. The regular price of admission is 50 cents a person, and a like charge is made for taking an automobile in the grounds, even when the operator is fortunate enough to hold such a permit. All of this was overruled on Automobile Day, and everyone in the machines was admitted without charge.

The parading was over at 4 p. m., and those who did not remain within the grounds slowly filed back to their hotels, and the tour was a thing of the past.

From a Woman's Point of View

Special Correspondence.

ST. LOUIS, Aug. 12.—From a woman's viewpoint, the automobile parade was most imposing in a multiplicity of ways. The picture in front of the Jefferson Hotel at 1:30 this afternoon was worthy the brush of some impressionistic artist who wishes to paint American life at its fullest. Under a Western breadth of sky and the high sun was the Jefferson as a background for the scene—a modern light grey brick hotel distinctively American in its skyscraper outline, and in front of this building on Twelfth street, one of the broadest cross-

parade, and appeared unwashed and unkempt, loaded outside with soil transferred from New York State to Missouri. However, these cars had the "ginger" when it came to the chug-chug of big, impatient motors. Most of the cars had some pedigrees placarded in large letters: "White Mountain Record Run," "From Arizona," "From Dixie," and "Second Trip, New York to St. Louis."

Seated in these gayly decorated cars were women from the East, West, North and South. All were attired in fetching holiday gowns. Delicately tinted chiffon veils, white hats, and dainty dresses were completed by bewilderingly pretty parasols. The tilting

eleven years. Everybody admired the plucky little woman who had brought her boys overland from the Southwest to see this World's Fair. Mrs. F. C. Donald, from Chicago, wore a white linen suit made with wide lace insertions. She wore white canvas shoes, a large white picture hat, and a white chiffon veil. She had her four-cylinder Pope-Toledo car decorated with bouquets of yellow roses and purple asters—purple and gold are the Chicago Automobile colors.

Mrs. C. J. Glidden, of Boston, wore a mauve silk shirt waist suit. Mrs. Swan J. Turnblad, of Minneapolis, wore a white india mull gown, and her daughter, Miss



PARADING AUTOMOBILISTS PASSING THROUGH FOREST PARK JUST BEFORE ENTERING THE WORLD'S FAIR GROUNDS.

town thoroughfares in the United States, were gathered automobiles of every size, and nearly all of the machines were chic in gay decorations. Bunting in green and white and red, the American Automobile Association colors, was festooned in a hundred artistic ways through wheel spokes and over canopies. Flags of many countries, but principally the stars and stripes, floated from visiting automobiles. German tissue paper streamers in a myriad design of bright colors enveloped some of the cars. Some had only bouquets of roses tied with wide satin ribbon to the great brass headlights of the autos. A few immense cars—racing types—tabooed the conventions of a smart

of these sunshades was so evanescent that the line of color moved up and down and around like a Florodora chorus.

Mrs. Frank X. Mudd, of Chicago, was gowned in a cream cloth skirt, white silk shirtwaist, white hat and white automobile veil. Part of the time she wore a Russian green silk cloak. Mrs. W. C. Temple, of Pittsburgh, was resplendent in white. Mrs. S. J. Kiefer, of St. Louis, was gowned entirely in white, while beside her in the tonneau sat "Jerry," a white bulldog decked out in smart dog auto fashions. One woman from Arizona, dressed in seal brown, drove her own car and carried her three boys, youngsters who ranged in ages from six to

Turnblad, wore a grey silk auto cloak while in the Knox car. Mrs. Wilkins, in a jaunty little Olds car, was sensibly dressed in a white silk shirt waist, and brown cloth skirt. She had a pongee automobile coat. Mrs. L. A. Woods, of St. Paul, was dressed in a white linen suit with a blue and gold chiffon toque. She wore only a face veil, and not the long motoring hat covering. Mrs. C. M. Hamilton, a recent bride of New York, wore white, while in the same Peerless car was Mrs. T. C. Collins, of Cleveland, who also was dressed entirely in white. Mrs. Harry Turner, of St. Louis, wore a white linen suit with an auto veil of blue chiffon. Mrs. A. M. Husted, of

Uniontown, Penn., drove in a rich brown street suit. In all there were about 175 women in the automobiles including St. Louisans and visiting motorists. The costumes made the principal color feature of the brilliant summer scene.

CHICAGO DELEGATION HAPPY.

President Farson Leads Division in Parade with New Car Expressed to Fair.

Special Correspondence.

ST. LOUIS, Aug. 12.—One of the cleanest and handsomest cars in the parade to-day was driven by President John Farson, of the Chicago Automobile Club. This car is a brand new Thomas Flyer which arrived in Chicago Wednesday night from the factory, and it was at once expressed to this city for the parade to-day. The car is pure white with red cushions—Mr. Farson's favorite color combination—and has a birdseye maple top, with brass trimmings.

This car is the fourth addition to the Farson garage this year, and, like the Sultan's wives, the last one being the favorite, it was honored by being put in the St. Louis parade.

Mr. Farson was too busy to go on the run from Chicago with the regular tour, but he "made good" by going to the first night stop on the train, where he welcomed his constituency from the Chicago Automobile Club.

At Pontiac his sporting blood was stirred, however, and after sending a few telegrams back to Chicago, he stayed over night and made the next day's journey in Augustus Post's car. From Springfield he went back to Chicago, and Friday morning found him, accompanied by Mrs. Farson and the two



[JAMES L. BREESE PASSING ANIMAL CIRCUS IN THE PIKE WITH HIS MERCEDES.

boys, John, Jr., and William, at the Jefferson Hotel in this city, ready to try out the new car at the head of the Chicago delegation.

Fourteen dust-begrimed, tireworn, but happy pilgrims from the Chicago club followed the Farson car—not looking so pretty, perhaps, but happy nevertheless.

George A. Crane, with a Knox, carried a big banner—"Chicago"—which brought forth much cheering along the line, especially on the Pike, the Pikers sending up a shout of welcome at seeing something from home. Mr. Crane's car won distinction on the downward trip by having more punctured tires than any other car in the run and at the same time making as good time as any, the motor running perfectly

and not a moment being lost on account of the engine.

An Astounding Proposal.

Staff Correspondence.

ST. LOUIS, Aug. 15.—Among the automobile exhibitors on the ground the one subject of conversation to-day is the extraordinary change of heart exhibited by the city and Fair officials on Automobile Day at the Fair—last Friday. Hitherto the official classes generally have not only been not enthusiastic, but actually hostile. The most serious manifestation of this spirit was the petition of the State Executive Commissioners' Association addressed to President Francis. In this extraordinary document he was requested to place pilots on "each and every automobile maintained and operated within the Exposition grounds, with distinct orders to cut the tire and place powdered emery on all delicate working portions of the mechanism whenever such vehicles are operated at a speed in excess of one mile per hour while within the confines of the Louisiana Purchase Exposition."

This ruffianly proposal evidently did not meet with the approval of President Francis, for nothing has been done toward giving it the force of an executive order. The commissioners were apparently annoyed by the privileges which the demonstration of exhibition automobiles enjoyed and which were not extended to "outside" automobiles and took advantage of the speed indiscretion of some drivers to ask for the destruction of cars. A vigorous protest was made by the exhibitors and as a result of the feeling caused by the request it looked for a time as if no automobiles would participate in the Transportation Day parade.

Exhibitors are now wondering whether the splendid demonstration made by the local owners and World's Fair tourists on Automobile Day will result in a permanent improvement in relations.

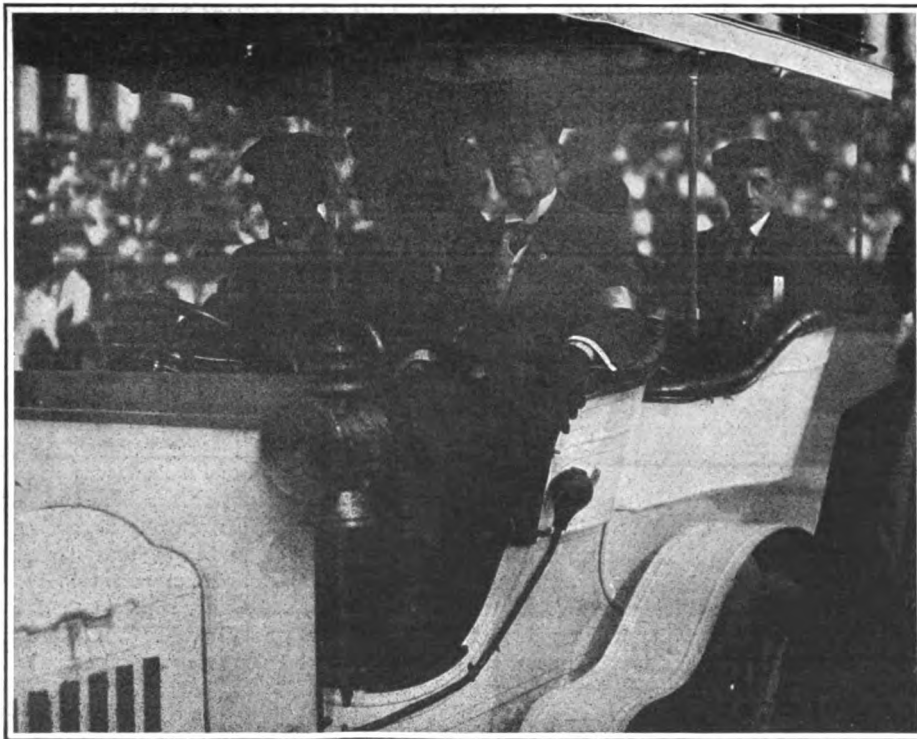

PRESIDENT FARSON, OF CHICAGO CLUB WHO LED CHICAGO DIVISION IN HIS NEW THOMAS.

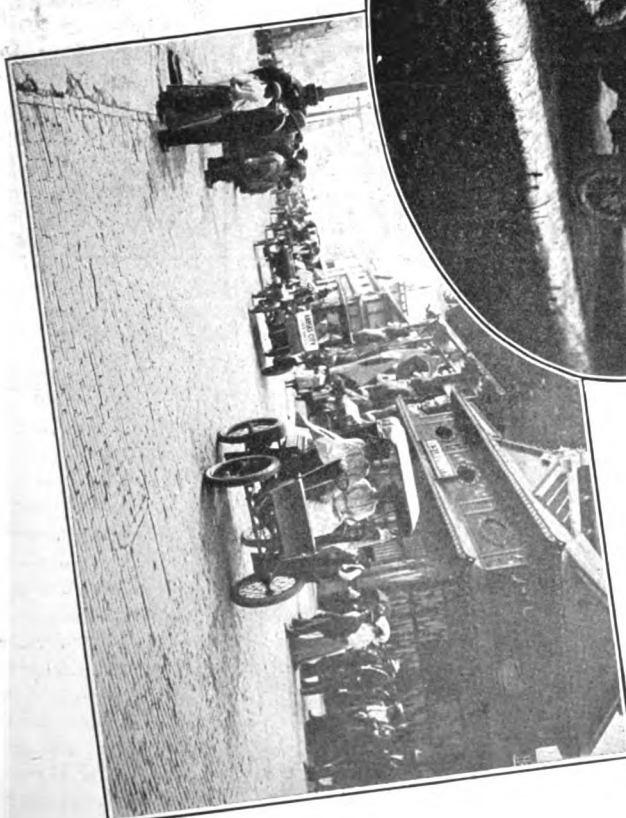
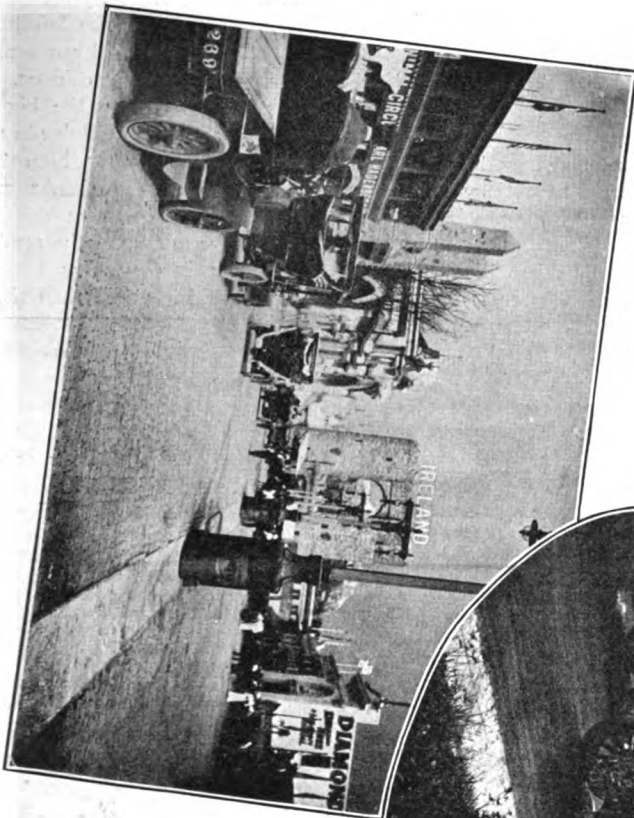
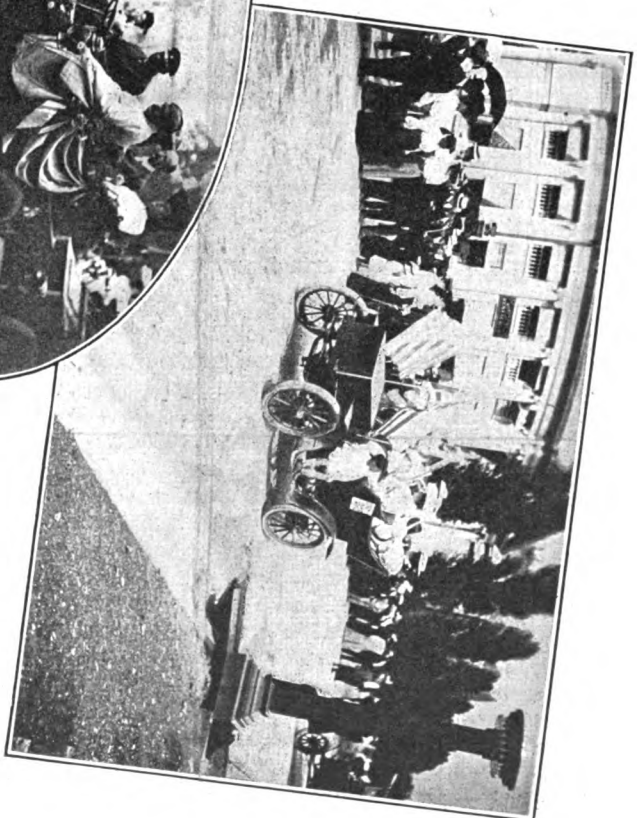
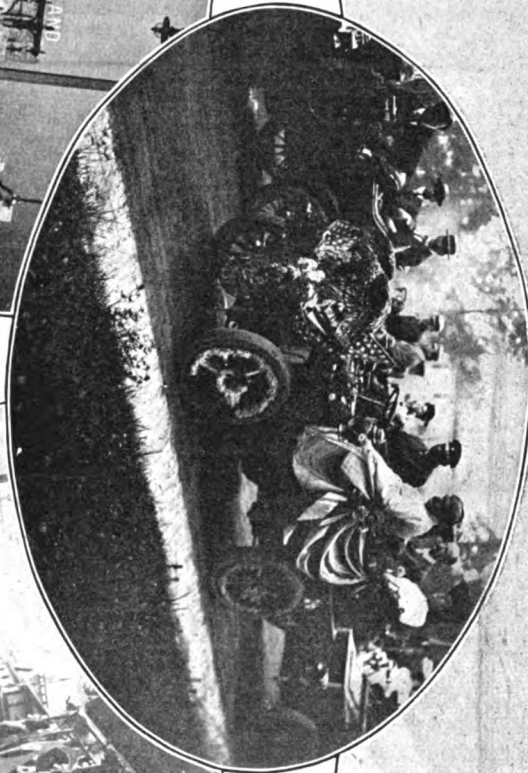
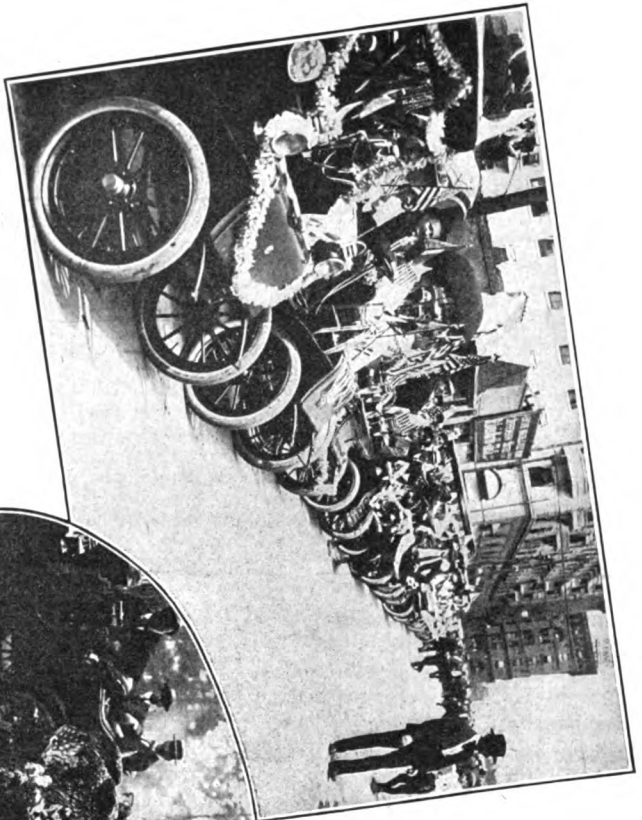

Gaily Decorated Cars Lined Up for Start of the Parade.

A Patriotic Decoration—American Eagle and Flag.

G. C. Brown's Party from "Dixie" (Birmingham, Ala.) in the Parade.

Procession Moving Down the Pike in Front of the Irish Village.
SNAP SHOTS OF AUTOMOBILE DAY PARADE IN ST. LOUIS, AUGUST 12. THE GREATEST DEMONSTRATION OF THE KIND EVER HELD IN ANY COUNTRY

The Procession Enters St. Louis.

Thousands Watch the Tourists Parade Over Eads Bridge to Jefferson Hotel—Participants Relate Their Experiences.

Special Correspondence.

ST. LOUIS; Aug 10.—Motorists began to arrive at 2.30 o'clock to-day at the City Hall Square in East St. Louis, where they lined up in the order of their touring numbers and made a formal entry over the Eads bridge into St. Louis. More than fifty automobiles—dusty, mud-bespattered, and with tires chain-wrapped, showing that their occupants had made a strenuous journey—arrived promptly at Eads Bridge during the following half hour. The cars hailed from Boston, New York, Cleveland, Baltimore, Philadelphia, Pittsburgh, Uniontown, Pa., Columbus, O., St. Paul, Minneapolis, Chicago and other western cities.

A local committee and a number of prominent St. Louis motorists, went over

were dusty and sunburned, no one looked extremely weary. One woman from Boston, who had been two weeks on the road, remarked as she stepped from her car, "I'm sorry it's all over." Everybody was in a good-humored frame of mind. W. B. Saunders, of Philadelphia, had come in at 1.05 p. m., so he was neatly dressed in a business suit and waiting to watch the arrival of the other tourists. Mr. Saunders, accompanied by his chauffeur, J. J. Laughlin, came in a twenty-horsepower Winton. Instead of going to Gettysburg, he came through Chambersburg and Hagerstown. In an interview to-day he said:

"Yes, they say I am the first one of the eastern party to arrive here. The trip was

comobile into a plate glass window. Every-one was very courteous; the merchant took my card and said he would send a bill for the glass."

A little out from Springfield these tourists met a woman who left her horse and buggy in the road and ran across the road-bed hopping like a chicken. The horse paid no attention to the big motor, and when Mr. Saunders indulged in a laugh, the Illinoisan called after him, "Sir, this is nothing to laugh at!" At another place four women who were driving, left the horse in the middle of the road alone while the motor car went past. The women were more frightened than the horses. It was a noticeable fact that cows evinced no alarm at the automobile.

When asked about the other Philadelphians, Mr. Saunders said that the Allison's, who went on ahead in a Pope-Toledo car, jumped a rail fence four miles out from Reading. Just out of Uniontown, Penna., they had a tire go down and he had not

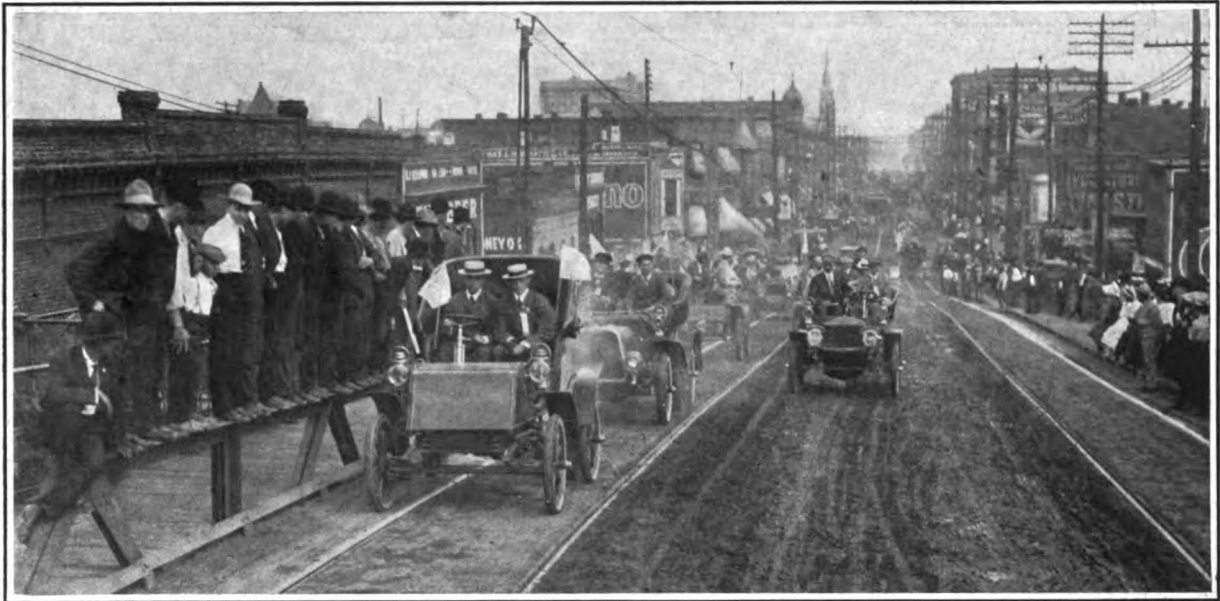

TOURISTS FROM THE EAST ASCENDING APPROACH TO EADS BRIDGE IN EAST ST. LOUIS IN PARADE ORDER.

to East St. Louis in spick and span automobiles, painted in white, and claret cars with gay moldings, to assist advance committees in escorting the visiting tourists over to the Jefferson Hotel. The jubilant parade was greeted by continuous crowds all along the thoroughfares. Flowers were tossed into the cars, and at every corner more cheers greeted the travelers.

A big crowd awaited the parade at the Hotel Jefferson and gave the cars a hearty welcome as they rounded the corner from Washington avenue. All of the tourists did not enter with the parade; in fact, cars kept arriving at short intervals until midnight. Among the first in the parade after the committees were Mr. and Mrs. Whipple, Mr. and Mrs. C. H. Gillette, Augustus Post, Mr. and Mrs. Chas. J. Glidden, and Mr. and Mrs. W. C. Temple.

Most of the motorists had eaten a good dinner in East St. Louis, and although all

all right. My three days of mountain climbing were the most strenuous. Sometimes I would go for three or four miles on the low gear up some steep grades, and then for the same distance, perhaps, go down grades with the emergency brake on. I shipped two tires and some other things back to Philadelphia. Anything that needed repairs I sent home. My car behaved handsomely. I smashed a rear wheel once, but that was my own fault, as I lost control of the machine. I got a new one and came ahead. At Springfield, Ill., when we started out, about 1,000 people were gathered around to see us off. Going down the main street a man with a bicycle was crossing the street. I turned out to go past him but just as I did this he became dazed and turned back directly in front of my car. To save him I turned the machine and swerved into a Locomobile standing in front of a store. My Winton knocked the little Lo-

heard from them since. Mr. Keeley and his two sons got as far as Pittsburgh, but he did not hear from them after that. Mr. Saunders says he found the National Pike much better than he expected it would be.

At Columbus this Philadelphian met the Buckeye car, a four-cylinder air-cooled car driven by L. A. Frayer, who invented his own motor and is giving it its first long road test on this run. The new motor did remarkably well.

The Popes, of Hartford, say that this run has demonstrated American cars to be equal to any foreign models. Albert L. Pope, Arthur W. Pope, and George Soules came through in a Pope-Toledo car which was taken out of stock at Providence, R. I. They did not decide to come until the day before leaving, so there was no extra preparation. "Some of these western roads are no roads at all, merely fields," said Albert Pope to-day. The party came in on time

and with no mishaps. At Chicago they picked up O. F. Weber and brought him on to St. Louis.

Harold L. Pope drove a 10-horsepower single cylinder Pope-Hartford car from Springfield, Mass. The second day out he went over a 30-foot embankment and bent an axle, but he repaired it and came through with the others.

W. G. Schmunk, George H. Lowe and J. Sheldon, who came through from Boston in a White steamer, report that they did not even tighten a screw from the time they left Boston two weeks ago last Monday until they reached here this afternoon at 3 o'clock.

E. F. Meier, of South Bend, Ind., arrived with his right arm done up in a sling. He and R. S. John had just started when their car overturned and Mr. Meier's arm was broken. The arm was set, the car righted and on they came, with no other mishap.

Pekin, Ill., a city of 11,000 inhabitants, had two cars in the trip. Mr. and Mrs. H. C. Frings, Miss Olga Commentz, and C. G. Herget came in a 20-horsepower National. V. P. Turner also came in a car of the same make and power, bringing his son Robert and his two daughters. He said the roads were bad enough, although he had no trouble with his car.

W. C. Hurlburt, of Detroit, arrived at 1.30 to-day, having driven from New York, and H. E. Newman was not far behind. Mr. and Mrs. C. C. Cockrell, of Pittsburg, Kan., and Roy Sarborn, of Kansas City, arrived at 2.30 yesterday afternoon after a pleasant run across country. They found the sandy roads bad near Glasgow, but otherwise made excellent time. They will remain in St. Louis until after Automobile Day on Friday.

W. S. Shrigley, of Boston, also arrived yesterday, but expects to return to Boston to-night.

A. B. Tucker, assistant secretary of the A. A. A., opened official headquarters at the Jefferson Hotel yesterday morning. He

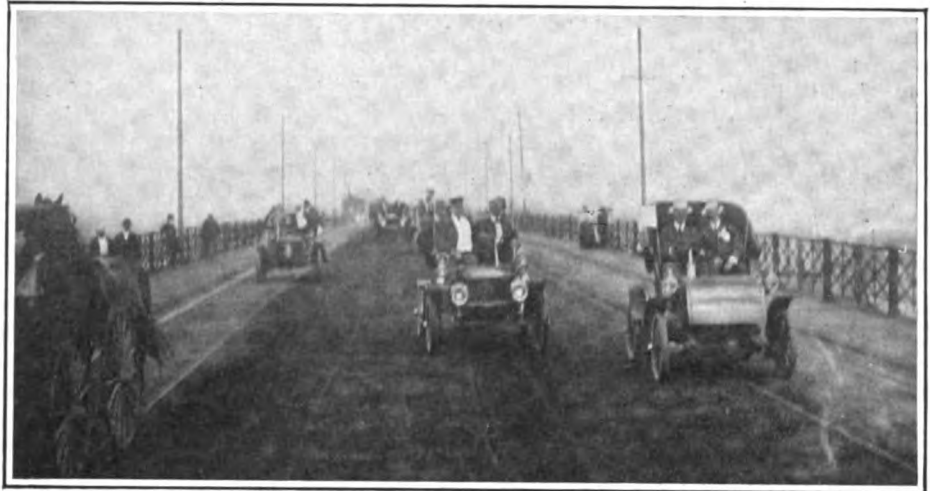

CROSSING EADS BRIDGE OVER MISSISSIPPI RIVER, WITH DESTINATION NEAR AT HAND.

is equipped with badges, buttons, flags, and a fund of information for the tourists.

Mr. and Mrs. Walden Shaw, of Chicago, with their chauffeur, came in Monday night, having made the trip in eighteen hours actual running time.

A. D. Rogers, T. K. Pinkard, C. O. Howard and Starling Rogers arrived from Columbus, O., last night. They started last Friday in two cars and made the trip in twenty-five hours' running time. From Columbus to Terre Haute they reported the roads in excellent condition, but from Terre Haute to St. Louis, particularly in Illinois, they experienced almost every kind of road trouble.

About three-quarters of an hour after the procession to the Hotel Jefferson ended to-day Mr. Manross's party from Bristol, Conn, arrived in a Columbia 24-horsepower car. They reported that when the pilot car exhausted its supply of *confetti* it resorted to the use of rice, pumpkin seeds and corn, which was promptly picked up by chickens and the motorists got lost. "We broke three springs between Buffalo and

Cleveland, and broke the body hanger this side of Springfield," said Mr. Horton, of the party. "Between Albany and Buffalo the roads were bad, and between Springfield and here they were bad." All said that this run would show what can be done by automobiles, and better roads will result.

Early in the afternoon Dr. H. C. Hendel and Louis F. Siebenthaler, of Cincinnati, arrived. They were so covered with mud that one newsboy shouted to another, in answer to the question, "Who are they?" "Mudturtles, sure!"

The following motorists designated by the numbers of their machines, have registered at the headquarters of the American Automobile Association to-day:

- No.
1. H. W. Whipple, Mrs. Whipple, C. J. Donahue.
 3. C. H. Gillette, Mrs. Gillette.
 4. Carl Page, W. R. Greene, M. H. Newton.
 9. E. S. Morton, R. H. Johnston.
 10. Augustus Post, John Hantch.
 12. W. C. Temple, Mrs. Temple, H. Mashie, L. Wilson.

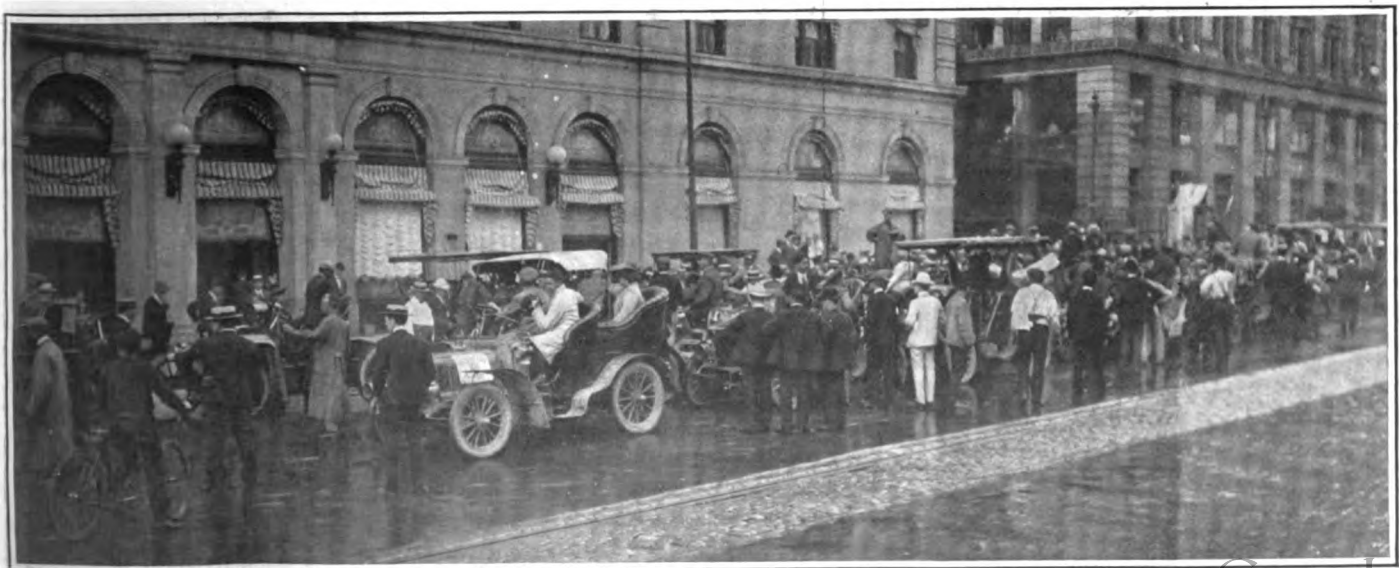

ARRIVAL AT END OF JOURNEY IN FRONT OF A. A. A. HEADQUARTERS IN JEFFERSON HOTEL WEDNESDAY AFTERNOON, AUGUST 10.

13. E. T. Fetch.
15. C. J. Glidden, Mrs. Glidden, C. Thomas.
18. G. S. Waite, Mrs. Waite.
19. Jas. L. Breese.
20. F. C. Donald, M. C. Green.
21. H. Frederick Lesh, Thos. Lesh, Mrs. Champ R. McClellan, J. Darling.
24. C. H. Burchwood, C. S. Arnold.
30. George H. Lowe.
31. Ray D. Lillibridge.
32. Webb Jay, C. E. Denzer.
34. P. F. Megargel.
35. Dr. W. H. Gifford, George Johns.
38. W. C. Hurlburt, John Speck.
39. F. N. Manross, Robert Manross, W. W. Horton, H. A. Warner.
47. H. C. Esselstyn, G. Harris.
50. J. M. Waters, E. B. Gitchell.
51. P. P. Pierce, George Ulrich.
53. F. E. Spooner, D. B. Huss.
54. F. C. Gates, Mrs. Gates.
55. H. L. Pope, J. W. Zeigler.
59. A. L. Pope, George Soules.
60. A. J. Seaton, J. W. Seaton.
61. A. D. MacLachlin, George Bowler, F. Miller.
64. H. Hoag, E. S. Frittner.
65. H. P. Dyer, H. S. Trenhauef, A. Jones.
70. S. J. Turnblad, Mrs. Turnblad, Miss Turnblad, H. Hamer.
71. C. B. Judd, Mrs. Judd, Miss McWhatter, Mr. Austin.
78. L. A. Wood, Mrs. Wood, Allen Wood, George Heigus.
79. B. A. Ledy.
86. Mr. and Mrs. Welhius.
101. W. R. Smith, Mrs. Smith, R. Fairchild.
104. J. R. Blakish, Mrs. Blakish.
105. T. C. Collings, Mrs. Collings, C. M. Hamilton, Mrs. Hamilton.
117. L. E. Myers, Mrs. Myers, W. R. Dixon.

Impressions of Women Tourists

Special Correspondence.

ST. LOUIS, Aug. 13.—The fact that a number of women motorists made this overland journey of about 1,400 miles by automobile shows that there is a new epoch opening for long distance auto touring in America. These women not only stood the trip, but enjoyed it. They are already planning on next year's run. Several of the ladies expressed themselves that they would prefer to return the way they came to Pullman accommodations. Some found the journey a little too strenuous, and would prefer a rest of a day after each two or three days' touring. In interviews with these feminine motorists a diversity of opinion was apparent in regard to the journey.

Mrs. L. E. Myers, of Chicago, said she considered motoring the most fascinating sport she knew. She and her husband started in a Columbia car, 32-horsepower, which weighed 3,600 pounds. This was the record car which went from Chicago to New York, a distance of 1,375 miles, in 76 hours. But on this last trip the carbureter began acting badly, and the occupants of the car came into St. Louis by train from Springfield, Ill. The chauffeur, Holcomb, repaired the machine, and drove it into St. Louis on Friday.

Mrs. Frank X. Mudd, of Chicago, said she could stand any amount of motoring if

she had three good meals a day and a bed to sleep in at night. "I think American women should go in more for this sport. It is healthful, invigorating and delightful. We came in a little one-cylinder Cadillac run-about. We expected a four-cylinder tonneau, but couldn't get it. We didn't have a bit of trouble, not even a tire puncture. At one Illinois farm where I stopped to get a drink the woman of the house asked me "How much do them things cost?"—meaning automobiles. When I told her the prices ranged anywhere from \$900 to about \$6,000 she raised her arms in amazement, and exclaimed, "Why, that would buy a good farm, now, wouldn't it?" Another countrywoman in Missouri met Mrs. Mudd on the route and explained that her horse's name was "Old Nick," and he proved it suddenly by kicking out the dashboard of the countrywoman's buggy.

Mrs. C. J. Glidden, of Boston, in summing up the automobile trip, said it would create a unique interest in the sport of motoring. Through Massachusetts and New York State the scenery was very interesting, but they couldn't see much because of bumping up and down. The trip would have been charming had the roads in these States been good. "The sections of New York State traversed mile in and mile out were worse than the Western roads," said Mrs. Glidden. Albany ladies say they have good roads, but they seem to be mostly up around Lake George and through the tourists' sections. Another observation was that most American cities have bad approaches. Mr. and Mrs. Glidden, who are making an auto tour around the world, have traveled 17,677 miles, and they say that on this last run they found the worst roads of all.

Touring in their 24-horsepower Napier car, they travel two or three days and then

countries one visits. Mrs. Glidden said this overland run was a little strenuous because so long continued with only a break on Sunday. They drove principally in the morning hours to avoid the heat and dust.

Mrs. W. C. Temple, of Pittsburg, found the trip very enjoyable, except on the first day and the last. She rode in a 24-horsepower Pierce Great Arrow car. "We came through with as little trouble as any, I imagine, for we had only four punctures on the way. I am a little disappointed in the automobile show here, but the Tyrolean Alps are fine."

Mrs. A. M. Husted, of Uniontown, Pa., came with her two sons. On the Old National Pike she went up such a hill that she thinks the White steamer could climb a telegraph pole, after that grade. She enjoyed the trip, and is going back by automobile.

In the St. Paul and Minneapolis contingent were Mrs. L. A. Woods, Mrs. Swan J. Turnblad and Miss Turnblad, Mrs. Sherer, and Mrs. B. A. Ledy. There were no confetti trails for them; their husbands, who drove the cars, had to be their own pathfinders as far as Chicago. In one sand road all the ladies got out and helped push the machines up the grade one by one. They enjoyed the trip all the more because most of their troubles came the first two days and were then over. At first they tried to keep the four cars together, but it was found impracticable, and they soon paired off, part of the time each one going alone.

Mrs. C. M. Hamilton and Mrs. T. C. Collings, who came from Cleveland in a Peerless car, say that they intend to come in next year's run. Miss Ada and Miss Vinca Turner came with their father in a National car from Pekin, Ill. They report the roads as "bad enough, but we had



DIRECTING FRANKLIN CAR THROUGH EAST ST. LOUIS TO BRIDGE.

rest for a day. They are taking their trip, not to roll up mileage, but because they enjoy meeting people, studying their habits and customs, and they consider this an excellent way to get some knowledge of the

no trouble." Mrs. H. C. Frengs and Miss Olga Commentz also came through from Pekin in a 20-horsepower National.

All the women enjoyed the trip and hope there will be another each year.

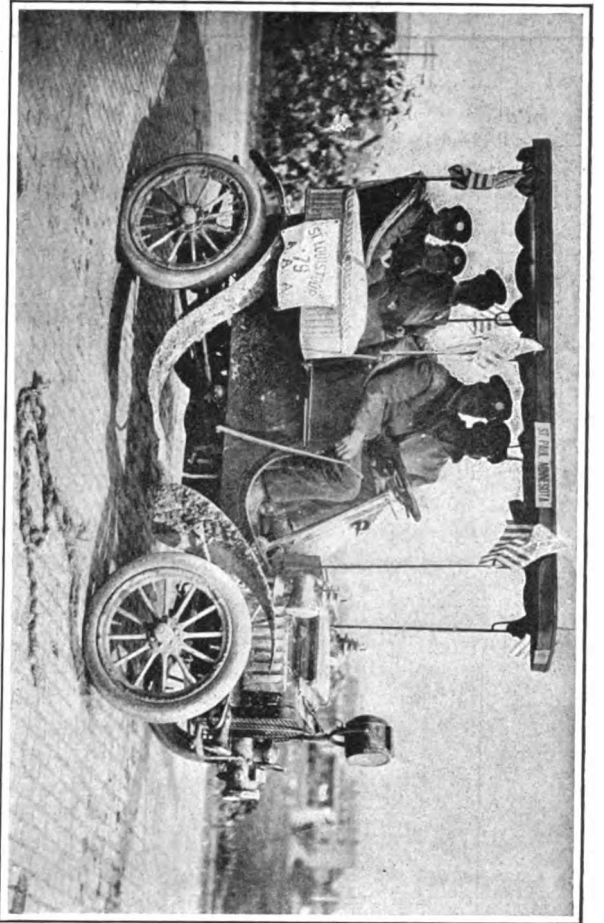

B. A. Ledy and Family, from St. Paul, near City Hall, East St. Louis.

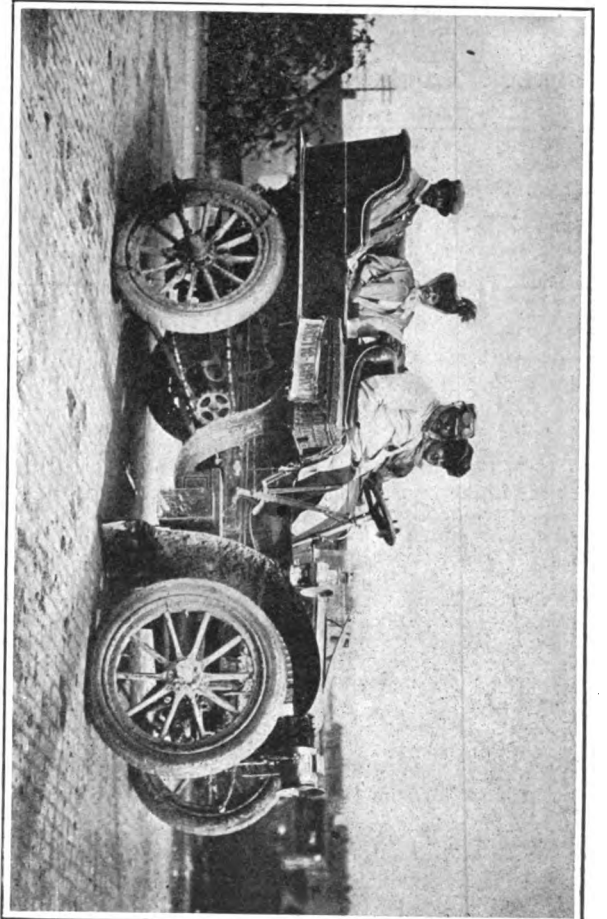

Mr. and Mrs. Charles D. Giddens, of Boston, in Their "Arctic Circle" Car.

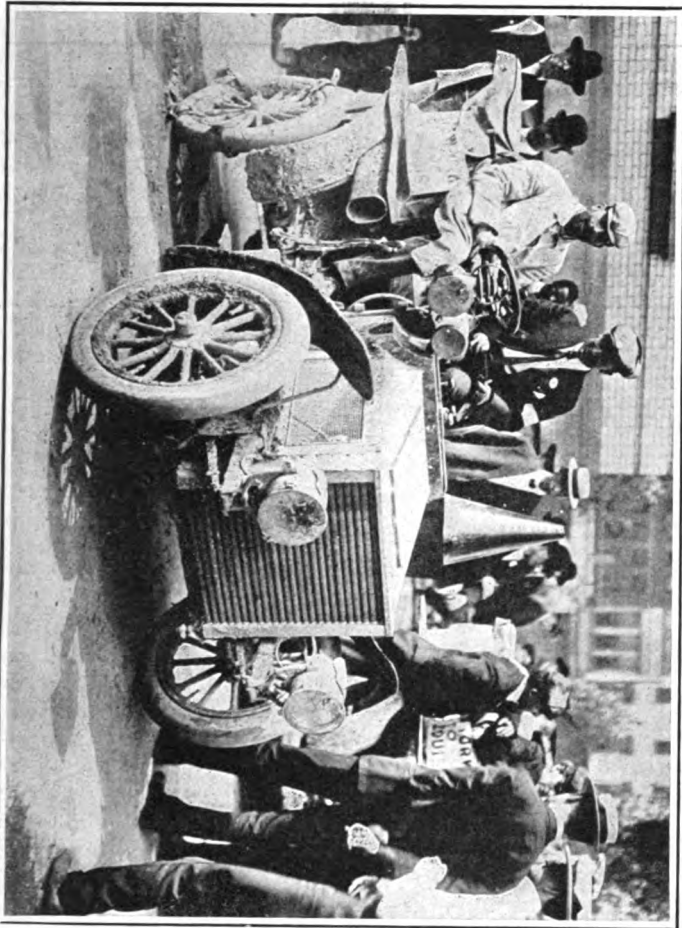

Augustus Post, Chairman A. A. A. Tour Committee, and Windsor T. White, PROMINENT MOTORISTS FROM WIDELY SEPARATED SECTIONS, PHOTOGRAPHED AT AND NEAR CITY HALL, EAST ST. LOUIS, WHERE THEY MET TO ENTER EXPOSITION CITY.

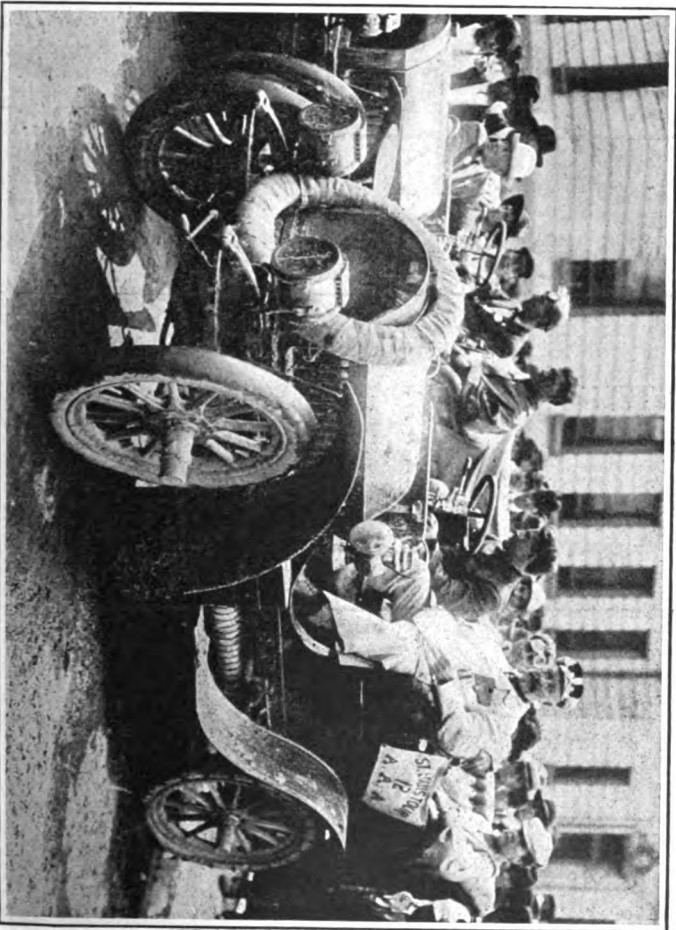

W. C. Temple, President Pittsburg A. C. and Chairman Pittsburg Division, W. C. Temple, President Pittsburg A. C. and Chairman Pittsburg Division, WHERE THEY MET TO ENTER EXPOSITION CITY.

ARRIVALS AND CERTIFICATE WINNERS.

ST. LOUIS, Aug. 13.—According to the official lists, as corrected to-night, out of seventy-seven cars known to have started from various points, north, south, east and west in the tour, sixty-nine have reached this city. Under the rules only those that followed the official routes and registered at the designated stopping places are entitled to certificates, which to the number of forty-nine have been issued at this writing. An exception was made in the case of J. R. Blakeslee, Jr., who had started from Cleveland in a Winton, and who got in with the early arrivals at East St. Louis. When about to cross the Ead's Bridge into St. Louis proper, however, he had the ill luck to break the crank-shaft of the motor, and so had to be towed across the bridge. Practically he had completed the tour, and the decision to give him a certificate was very generally approved.

There are other special cases under consideration, in which, for one reason or another beyond their control, tourists were unable to qualify under the rules, though they actually got to St. Louis in good time. These cases will be considered and a decision reached later.

The official record of arrivals lacks just eight of the total of actual starters, and one-half of these eight entrants did not meet with any mishap, but completed only portions of the journey; the remaining four were put out of the running by accidents. Of the former George Otis Draper, No. 46, entered only for the run from Worcester to Albany. Elliott and Lee, No. 5, started from Boston and stopped in the rain at Pittsfield, and G. T. Thompson covered the route from Rochester to Cleveland, as he had planned. William Monypeny, Jr., chairman of the Columbus Division, joined the tour at Columbus with the intention of coming through to St. Louis,

but at Indianapolis he received word of the serious illness of a member of his family and hastily returned home.

Of the four stoppages due to accident, the most serious was that of R. P. Scott, No. 14, whose car rammed an express train at Perrysburg, Ohio, and was damaged beyond repair, though, most fortunately, none of the occupants was seriously hurt. Broken crank-shafts accounted for the permanent disablement of Harlan W. Whipple's car (No. 1) about thirty miles from St. Louis, on the run in, and of E. H. Wallace's car (No. 40) near Toledo, Ohio. The remaining mishap was the destruction by fire of the Olds, entered by F. A. Benson (No. 116) at Pontiac, Ill., due to the carelessness of a local mechanic.

The original entry list contained the names of 110 entrants. Of this total a considerable number did not start at all; in fact, the records now show that thirty-three cars either did not start or else started and up to this time (Saturday night) did not get through. Some cars that are included in the following list of arrivals got in at various times after the official finish of the tour on Wednesday, and it is not unlikely that the absentee list will be still further reduced within the next day or two.

Following is the official list of starters, corrected to date. The names of those to whom certificates have been awarded are printed in *italics*. The names of those credited with arrival at St. Louis are printed in SMALL CAPITALS, and those who do not come under either classification are printed in ordinary lower case type. Those in which the number of the car is preceded by an asterisk (*) are included in the special cases already referred to, which the committee has under consideration. The list gives the name of the entrant, the official number of the car, the points between which the entrant traveled and the kind of car driven:

No. 116—Mr. F. A. Benson, Chicago, Ill., Chicago to St. Louis, by Main Line. Oldsmobile destroyed by fire at Pontiac, Ill.

No. 60—Black Diamond Automobile Co., Utica, N. Y. New York to St. Louis, by Main Line. Two passengers. Buckmobile, 16-horsepower.

No. 104—J. R. Blakeslee, Jr., Cleveland, Ohio. Cleveland to St. Louis, by Main Line. Two passengers. Winton.

*No. 19—JAMES L. BREESE, New York. Buffalo to St. Louis, Main Line Route. Mercedes, 40-horsepower. Member A. C. A.

No. 123—G. C. BROWN, Birmingham, Ala. No. 96—C. C. Cockerill, Pittsburg, Kas. Pittsburg to St. Louis, via Kansas City. Two passengers. Stevens-Duryea 7-horsepower.

No. 105—Mr. T. C. Collings, Cleveland, Ohio. Cleveland to St. Louis, by Main Line. Four passengers. Peerless car.

No. 115—GEORGE A. CRANE, 1251 Michigan avenue, Chicago, Ill. Chicago to St. Louis by Main Line. Four passengers. 20-horsepower touring car. Member C. A. C.

No. 114—F. Cecil Davis, 86 East Lake street, Chicago, Ill. Chicago to St. Louis, by Main Line. Four passengers, including chauffeur. Special car, 16-horsepower. Member C. A. C.

No. 20—F. C. Donald, Tribune Building, Chicago, Ill. Chicago to St. Louis, Main Line. Four passengers, including chauffeur. Pope-Toledo, 24-horsepower. Member C. A. C.

No. 46—George Otis Draper, Hopedale, Mass. Worcester to Albany. By New England route. Two passengers. Chauffeur. Packard, 22-horsepower. Member Massachusetts A. C.

No. 65—H. P. Dyer, Cleveland, Ohio. Cleveland to St. Louis, by Main Line. Three passengers. Winton, 24-horsepower.

No. 13—E. Tom Fetch, Detroit, Mich. Erie, Pa., to St. Louis, by Main Line. Two passengers. Packard, 24-horsepower.

No. 47—H. H. Franklin Manufacturing Company, Syracuse, N. Y. New York to St. Louis, by Main Line. Franklin, 10-horsepower.

No. 54—F. C. Gates, Cleveland, Ohio. Cleveland to St. Louis, Main Line. Two passengers. Winton, 20-horsepower. Member of Cleveland A. C.

No. 35—DR. W. H. GIFFORD, 773 Prospect street, Cleveland, Ohio. From Cleveland to St. Louis by Main Line. Two Passengers. Drives White Touring Car. Member Cleveland A. C.

No. 3—C. H. Gillette, 31 West Forty-second street, New York City. Secretary American Automobile Association. New York to St. Louis by Main Line. Two passengers. Pope-Hartford Car, 10-horsepower.

No. 15—Charles J. Glidden, 10 Post Office square, Boston, Mass. Boston to St. Louis by New England and Main Line Routes. Four passengers, including chauffeur. Napier, 24-horsepower. Member A. C. A.

No. 121—ROBERT G. HAUSLEIN, 284 Ohio street, Chicago, Ill. Chicago to St. Louis, by Main Line. Three passengers and chauffeur. Rambler, 16-horsepower.

No. 24—Haynes-Apperson Company, Kokomo, Ind. New York to St. Louis, Main Line. Two passengers. Haynes-Apperson, 12-horsepower.

No. 112—E. R. HIBBARD, 216 Maple avenue, Oak Park, Ill. Chicago to St. Louis, by Main Line. Two passengers. Searchmont, 12-horsepower. Member C. A. C.

No. 64—Harold Hoag, Lockport, N. Y. Buffalo to St. Louis, by Main Line. Two passengers. Covert, 6-horsepower.

No. 38—W. C. Hurlburt, Detroit, Mich. New York to St. Louis. Main Line. Three passengers. Chauffeur. Cadillac, 8 1-2-horsepower.

No. 66—A. M. Husted, Uniontown, Pa. Uniontown to St. Louis, by National Highway. Three passengers. White steamer.

No. 118—W. H. STEPANEK, Chicago, Ill. Chicago to St. Louis, by Main Line. Four passengers. Rambler, 8-horsepower.

No. 32—Webb Jay, Cleveland, Ohio. New York to St. Louis. By Main Line. Chauffeur. White Touring Car. Member of Cleveland A. C.

No. 9—R. H. Johnston, New York City. Cleveland to St. Louis by Main Line. Two passengers. Peerless, 24-horsepower.

No. 119—CHARLES B. JUDD, Grand Rapids, Mich. Grand Rapids to St. Louis, by Main Line. Four passengers. Austin, 16-horsepower. Member Grand Rapids A. C.

*No. 42—F. A. LAROCHE, 147 West 38th street, New York City. New York to St. Louis by Main Line. Two passengers. Chauffeur. Darracq, 15-20-horsepower. Member of A. C. A.

No. 89—OSCAR LEAR AUTOMOBILE CO., Columbus, O. Columbus to St. Louis, by National Highway. Two passengers and chauffeur. Buckeye, 20-horsepower.

No. 79—B. A. Ledy, 712 Osceola avenue, St. Paul, Minn. St. Paul to St. Louis, by Main Line. Four passengers. Rambler, 16-horsepower.

No. 5—Elliot C. Lee, 40 State street, Boston, Mass. Boston to Pittsfield, by New England and Main Line Routes. Chauffeur. Drives a White Touring Car. President of the Massachusetts A. C.

No. 21—H. Frederick Lesh, 597 Atlantic avenue, Boston, Mass. Boston to St. Louis, Main Line. Five passengers, including chauffeur. Pope-Toledo, 24-horsepower. Member of Newton A. C.

*No. 31—RAY D. LILLIBRIDGE, 170 Broadway, New York City. New York to St. Louis, by Main Line. White steamer.

No. 30—George H. Lowe, 509 Tremont street, Boston, Mass. Boston to St. Louis, by New England Main Line. Three passengers, including chauffeur. White Touring car. Member of Massachusetts A. C.

No. 39—F. N. Manross, Forestville, Conn.

Bristol, Conn., to St. Louis, by New England and Main Line Routes. Four passengers. Columbia, 24-horsepower. Member of Hartford A. C.

No. 75—*Marion Motor Car Co.*, Indianapolis, Ind. Indianapolis to St. Louis, by Main Line. Two passengers and chauffeur. Marion Car, 16-horsepower, driven by D. J. Hayden.

No. 34—*Percy F. Megargel*, Rochester, N. Y. New York to St. Louis, by Main Line. Two passengers. Elmore, 12-15-horsepower.

No. 117—*MR. L. E. MEYERS*, Chicago, Ill. Chicago to St. Louis, by Main Line.

No. 16—*William Monypeny, Jr.*, Columbus, O. Chairman of the Columbus Division. Columbus to Indianapolis, National Highway. Four passengers, including chauffeur. Stearns, 24-horsepower. Member of Columbus A. C.

Mich. New York to St. Louis. By Main Line. Two passengers. Oldsmobile

No. 120—*D. C. OLIN*, Kalamazoo, Mich. Kalamazoo to St. Louis, by Main Line. Two passengers. Cannon, 18-horsepower.

No. 122—*J. H. PATTERSON*, Marengo, Ill. Marengo to St. Louis, by Main Line. Three passengers. Rambler, 16-horsepower.

No. 51—*Percy P. Pierce*, 18 Hanover street, Buffalo, N. Y. Boston to St. Louis. By New England and Main Line Routes. Chauffeur. Pierce Arrow, 24-horsepower. Member of Buffalo A. C.

No. 72—*Frank H. Pietsch*, Eighteenth street and Canalport avenue, Chica, Ill. Chicago to St. Louis, by Main Line. Three passengers, including chauffeur. Autocar, 12-horsepower. Member Chicago A. C.

*No. 59—*A. L. POPE*, Vice-President, Pope Manufacturing Co., Park Row Build-

way. Two passengers and chauffeur. Special, 10-horsepower.

No. 61—*Royal Motor Car Co.*, Cleveland, O. New York to St. Louis, Main Line. Four passengers. Royal Tourist, 16-horsepower.

No. 48—*W. B. Saunders*, 925 Walnut street, Philadelphia, Pa. Philadelphia to St. Louis. Philadelphia-Pittsburg and National Highway Routes. Two passengers. Chauffeur. Winton, 20-horsepower.

No. 14—*R. P. Scott*, Baltimore, Md. Chairman of Baltimore Division. New York to Perrysburg, Ohio, where car collided with express train and was badly damaged. Main Line Route. Six passengers, including chauffeur. Special Peerless, 70-horsepower.

No. 73—*WALDEN W. SHAW*, 174 East Fifty-first street, Chicago, Ill. Chicago to St. Louis, by Main Line. Two passengers



TOURISTS FINISHING THEIR LONG JOURNEYS AT PUBLIC SQUARE, EAST ST. LOUIS, WATCHED BY INTERESTED SPECTATORS.

No. 97—*E. P. Moriarty*, Kansas City, Mo. Kansas City to St. Louis. Two passengers. Stevens-Duryea, 7-horsepower. Member of A. C., Kansas City.

No. 11—*Frank X. Mudd*, Fisher Building, Chicago, Ill. Chairman Chicago Division. Chicago to St. Louis, Main Line. Five passengers. Chauffeur. Austin touring car.

No. 43—*G. Douglas Neare*, Union Trust Building, Cincinnati, O. Cincinnati to St. Louis, by National Highway. Two passengers. St. Louis, 10-horsepower. Member of Cincinnati A. C.

No. 25—*Hart D. Newman*, 212 Carondelet street, New Orleans, La. Baltimore to St. Louis, by National Highway. One passenger. White Touring Car. Member of New Orleans A. C.

No. 53—*Olds Motor Works*, Detroit,

ing, New York City. New York to St. Louis, by Main Line. Two passengers and chauffeur. Pope-Toledo, 24-horsepower.

No. 55—*Harold L. Pope*, Pope Manufacturing Co., Hartford, Conn. Springfield, Mass., to St. Louis, by New England and Main Line Routes. Two passengers. Pope-Hartford, 10-horsepower.

No. 10—*Augustus Post*, 31 West Forty-second street, New York City. Chairman of Touring Committee A. A. A. New York to St. Louis, Main Line. Chauffeur. White Steamer. Long Island A. C.

No. 90—*Rodgers & Co.*, Columbus, O. Columbus to St. Louis, by National Highway. Four passengers and chauffeur. Special, 10-horsepower.

No. 91—*Rodgers & Co.*, Columbus, O. Columbus to St. Louis, by National High-

and chauffeur. Pope-Toledo, 24-horsepower. Member Chicago A. C.

No. 74—*GEORGE J. SHERER*, Minneapolis, Minn. Minneapolis to St. Louis, by Main Line. Two passengers. Knox Touring Car. Member Minneapolis A. C.

No. 101—*W. R. SMITH*, Chicago, Ill. Chicago to St. Louis, by Main Line. Three passengers. Pope-Toledo, 24-horsepower. Member Chicago A. C.

No. 57—*Guy Stone*, Cora Building, New Orleans, La. Cincinnati to St. Louis, by National Highway. Two passengers. Rambler, 16-horsepower. Member New Orleans A. C.

No. 26—*Sam Stone, Jr.*, 818 Common street, New Orleans, La. Baltimore to St. Louis, by National Highway. One passenger. White Touring Car. Member New Orleans A. C.

*No. 58—SWINEHART Co., Akron, O. New York to St. Louis, by Main Line. Three passengers. Yale, 16-horsepower.

No. 108—B. G. SYKES, 1354 Michigan avenue, Chicago, Ill. Chicago to St. Louis, by Main Line. Four passengers. Locomobile, 16-22-horsepower. Member Chicago A. C.

No. 12—W. C. Temple, Farmers' Bank Building, Pittsburg, Pa. Chairman Pittsburg Division. Pittsburg to St. Louis. Four passengers, including chauffeur. Pierce Great Arrow, 24-horsepower. President A. C. of Pittsburg.

No. 87—George T. Thompson, Onondagua, N. Y. Rochester to Cleveland, by Main Line. Five passengers. Winton, 20-horsepower. Member Rochester A. C.

No. 70—Swan J. Turnblad, Minneapolis, Minn. Minneapolis to St. Louis, by Main Line. Three passengers. Knox Touring Car. Member of Minneapolis A. C.

No. 18—George S. Waite, 23 Rockwell street, Cleveland, Ohio, Chairman of Cleveland Division. Cleveland to St. Louis, Main Line. White Steam Car. Member Cleveland A. C.

No. 40—E. H. Wallace, Freeport, Pa. Pittsburg to St. Louis. Two passengers. Rambler, 7-horsepower. Broke crank shaft at Toledo and retired.

No. 50—James M. Waters, 80 West Fortieth street, N. Y. New York to St. Louis, by Main Line. Chauffeur. Panhard, 24-horsepower.

No. 102—ORLANDO F. WEBER, 390 Wabash avenue, Chicago, Ill. Chicago to St. Louis, by Main Line. Four passengers and chauffeur. Pope Toledo, 24-horsepower. Member Milwaukee A. C.

No. 103—Dr. H. C. Wendel, 519 West Micken avenue, Cincinnati, O. Cincinnati to St. Louis, by National Highway. Two passengers. Pope Toledo, 24-horsepower. Member Cincinnati A. C.

No. 1—Harlan W. Whipple, Andover, Mass., President of A. A. A. From Boston to St. Louis, by New England and Main Line Routes. Chauffeur. Mercedes Car, 20-27-horsepower. Member of A. C. A. Broke crank shaft about 30 miles from St. Louis.

No. 4—Windsor T. White, Rose Building, Cleveland, O. New York to St. Louis, by Main Line. Chauffeur. White Steam Car, driven by Carl H. Page, President of the National Association of Automobile Manufacturers.

No. 86—W. J. Wilkins, 300 Eastwood avenue, Chicago, Ill. Chicago to St. Louis, by Main Line. Two passengers. Oldsmobile.

No. 78—L. A. Wood, 757 Dayton avenue, St. Paul, Minn. St. Paul to St. Louis, by Main Line. Three passengers and chauffeur. Winton 20-horsepower touring car.

Greetings to Mayor Wells.

Many of the tourists carried letters from the mayors of their home cities addressed to Mayor Rolla Wells, of St. Louis. August 11 was originally set down on the calendar of events as St. Louis Day at the Fair, and it had been planned to present these letters all in a body on that day. Not knowing that any change had been made in the date for St. Louis Day, the letter bearers arrived in a body at the City Hall on Thursday noon. As an escort nearly everyone in the touring party attended, and there was a notable gathering as some twenty-one letters, borne by as many different tourists, and backed up by fully twice that many more who came to see that the thing was

done up right, arrived at Mayor Wells' office.

Letters were brought as follows: Gov. Odell, New York, J. L. Breese; Mayor of Boston, C. J. Glidden; Mayor of New York, C. H. Gillette; Mayor of Worcester, C. H. Page; Mayor of Springfield, H. F. Lesh; Mayor of Poughkeepsie, H. A. Warner; Mayor of Albany, N. Y., Augustus Post; Mayor of Utica, N. Y., A. J. Seaton; Mayor of Syracuse, H. C. Esselstyn; Mayor of Buffalo, D. B. Huss; Mayor of Cleveland, Geo. S. Waite; Mayor of Toledo, H. W. Whipple; Mayor of South Bend, F. N. Manross; Mayor of Chicago, F. X. Mudd; Mayor of Joliet, J. M. Waters; Mayor of Pontiac, Ill., A. D. McLachlin; Mayor of Baltimore, S. Stone, Jr.; Mayor of Philadelphia, W. B. Sanders; Mayor of Detroit,

Association is en route to St. Louis from the east, with a view of assisting in the celebration of Automobile Day, August 11th, 1904. The association, with automobiles carrying its members, expects to be in St. Louis on August 11th.

With sincere congratulations on the occasion of the festivities on August 11, and bespeaking the courtesies of yourself and the City of St. Louis for the eastern tourists, and recalling with sincerest pleasure my own recollections of your magnificent Exposition, I am,

Very truly yours,
CARTER H. HARRISON, Mayor.

CITY OF BOSTON.
Mayor's Office.

July 18, 1904.

Hon. Rolla Wells,
Mayor of St. Louis, Mo.

My Dear Sir:—

This will be presented by my friend Mr. Charles J. Glidden, an enthusiastic auto-



PLUCKY LITTLE WOMAN WHO DROVE FROM ARIZONA WITH HER FOUR BOYS.!

W. B. Hurlburt; Mayor of Pittsburg, W. C. Temple.

The letters all contained the best wishes of the Mayors who signed them to Mayor Wells and congratulated him on the splendor of the World's Fair. Following are three of the letters:

CITY OF NEW YORK.

Office of Mayor.

July 25, 1904.

Hon. Rolla Wells,
St. Louis, Mo.

Sir:—

The American Automobile Association, by its representatives touring from New York to St. Louis, conveys this message of congratulation from the City of New York to the City of St. Louis on the achievement of the Louisiana Purchase Exposition, with a special hope for the signal success of Automobile Day, August 11th.

Respectfully,

GEO. B. McCLELLAN, Mayor.

CITY OF CHICAGO.

August 6th, 1904.

Hon. Rolla Wells,
Mayor,
St. Louis, Mo.

Dear Sir:—

I understand the American Automobile

moblist, who is chairman of the New England Division of Tourists, and who is on his way around the world in an automobile. (As he says, he don't know whether he can make it swim, so he will have to take a ship part of the way.)

I take pleasure in sending my greetings to St. Louis by this new and pleasant means of transportation.

We had a strenuous time during convention week at St. Louis and I was denied the happiness of making a call upon you. The convention passed off happily; the Fair is gorgeous, and the visit was in every way memorable.

I am,

Yours faithfully,
PATRICK COLLINS, Mayor.

Mayor Rolla Wells acknowledged the letters in a cordial speech of welcome, and assured the visitors of the courtesies of the city during their stay in St. Louis. After a handshake all around the tourists returned to their cars and scattered to the Fair and other points of attraction.

There are forty-five automobile owners in Salt Lake City, and the prospects point to a largely increased list before the beginning of the new year.

Fun at Thursday Evening's Smoker.

Special Correspondence.

ST. LOUIS, Aug. 12.—Tickets were issued to the tourists upon their arrival at the Jefferson Hotel inviting them to attend a smoker at the Hotel Washington Thursday evening. Just who was giving the smoker, the tickets failed to say, but as a fact it was made possible by a subscription raised among local motorists and the trade representatives at the World's Fair.

No pretensions of a formal reception were made, although a few of the tourists who had shipped evening clothes on by rail appeared thus attired, as did the local reception committee, which awaited the tourists at the hotel. Each man was seized as he entered the door by two or three enthusiasts and escorted to the sideboard, where dainty sandwiches and other things that St. Louis is as famous for as even the good city of Milwaukee, were in waiting. As it was the first time the tourists had assembled at a smoker since the glorious Pope-Toledo spread at Toledo, the tourists were in a mood for sociability.

Speeches were made by several of the visitors, including Chairman Post, President Whipple, the "unfortunate" Mr. Scott, the very witty Mr. Temple, and others.

President Whipple said in part: "There was a time when any one who wanted to go to St. Louis went by mule-back, and it took many weary weeks of travel. Now we can make the trip in automobiles in a comparatively few days," and then as a general titter went around, Mr. Whipple added, "of course I didn't get here in that way," (the speaker's machine having gone wrong, necessitating his coming the last twenty-five miles by train). "I think the average driver of an automobile to-day is careful, and I have heard little or no complaints from abuse of the speed law in the towns through which I have passed on this run. In fact, it is generally just the contrary, for they shout at me as I come trailing along: 'Hurry up and you'll catch them! Go on!'"

At the conclusion of President Whipple's address and the usual toast to the president that followed, A. J. Seaton, of Utica, took the floor and, with an appropriate address presented Messrs. A. B. Tucker and M. L. Downs with two beautiful gold watches as mementos of the occasion, and as evidences of appreciation of their services by the tourists, each of whom contributed toward the purchase of the timepieces. The two young men had officiated throughout the tour as the representatives of the A. A. A., doing all checking up of vehicles and attending to the registration of the drivers as well as the securing in advance of hotel and garage accommodations, and these matters of incessant detail were most capably attended to.

Chairman Post, of the A. A. A. touring committee, was then called upon. He said in part: "We started out immediately upon concluding the New York-Pittsburg endurance run to boom the St. Louis tour. It

took a long time and a lot of planning before the project came to a head, and it was not really until the meeting of the A. A. A. held at New York during the automobile show, that we felt sure the tour would be a success. The first endurance run was from New York to Buffalo, about 400 miles, the Pittsburg run was about 800 miles, and the St. Louis run was in the neighborhood of 1,500 miles. Too much credit cannot be given my associate in this matter, Mr. C. H. Gillette, secretary of the A. A. A., who has worked most faithfully for the success of the tour. Formerly touring to St. Louis was done by prairie schooners, but the time is fast approaching when traffic will be by automobile. All we want is good roads, and it is the automobile that is benefiting the country by getting those in authority to build good roads. The locomotive demands good rails and the automobile good roads."

W. C. Temple, who, were he not a successful business man, could make a fortune as an "entertainer," took the floor at the urgent call of his friends, who are legion. Mr. Temple said: "Boys, I will not attempt to talk on good roads, good automobiles, or anything of that kind, but I will tell you some little incidents that have come to my attention on this and other automobile runs.

"I had had my machine only a couple of days, and was not very expert at steering and managing the other half dozen cranks and levers at the same time. Coming down one of the Pittsburg streets I saw a man in front of me, and before I could get things straightened out I had run him down. Just at this time I managed to shout 'Look out! Look out!' The man, as he slowly regained his feet, turned a wild look on me and said: 'What's the matter, are you coming back?'"

In a preliminary speech Mr. Skiff, one of the World's Fair Commissioners, had made the statement that the three greatest of recent discoveries were the automobile, radium and the wireless telegraph. This was too good an opportunity for Mr. Temple to miss, and he said: "Yes, radium, the automobile and wireless telegraphy can well be classed together. When the automobile breaks down, use radium to look into its insides, and then take the wireless telegraph and send for a horse to drag the blank thing home.

"Our good friend Scott, whose troubles on this run have been the means of making the newspaper men rich, had a little conversation with a farmer the other day that, while I promised him I wouldn't give him away, I think I must tell. He was having trouble, as usual, along the roadside, and was trying to remedy it when a farmer came along and asked: 'Are you taking an automobile tour?' Scott, who was in a peculiar frame of mind at the time, replied: 'Yes, and if I don't get things so they run a little better, I'll take an axe to her.'

"Gentlemen, I am not mentioning any names, but there is certainly one man on this trip who is a hoodoo. He was traveling in his own car for the first week, and something went wrong every day. One day he rode in Mr. Whipple's car, and Mr. Whipple had seven punctures that day; then he took a train, saying, 'I can't put the train on the bum,' and do you know, the engine blew out a cylinder head before it had gone ten miles, and it finally arrived seven hours late.

"Do you know, the farmer who scatters corn and beans in the road, must do so because he don't need the chickens. Why, the day that Mr. Mudd is accused of strewing corn and beans as *confetti*, I followed the clearest trail that I have found since leaving home, and it wasn't corn or beans, either, it was chicken feathers—white, russet, speckled and black—a better blazed trail it has never been my lot to encounter.

"A good many of you know 'Billy' Vanderbilt, one of the greatest automobilists of the day. Well, one day he was out for a ride in that hoodoo machine of his, the *White Ghost*, and just as he was passing a hedge a farmer popped out so suddenly that he was almost hit by the flying automobile. 'Billy' swerved hard over to the other side of the road, and out jumped a dog so suddenly that there was no escape this time, and Mr. Dog went down and out. Vanderbilt stopped and, backing up to the farmer, said he was sorry, and the farmer said he was, too. Then, taking out his big roll of greenbacks, he tore off a fifty and handed it to the farmer, saying: 'Will that do?' 'Yes, I suppose so,' replied the farmer, still looking at the dead dog. Vanderbilt threw in his gear, and just as the *White Ghost* moved off on her slow speed he heard the farmer say: 'Waal, you poor old dog; I wonder who owned you, anyhow.'"

Calls for "Scott!" "Scott!" brought that portly gentleman to his feet. He said: "Yes, 'tis true, I'm sorry to say, that every automobile I step into breaks down. My machine has been shipped home, a complete wreck; Mr. Whipple's lies out on a lonely country road miles from anywhere, and even the locomotive hauling me into St. Louis blew out a cylinder head. Now, I don't wish that I had never seen an automobile, but I do wish I had looked deeper before going into the game. But once an automobilist, always an automobilist. I have got the fever, and despite my many mishaps on this trip, I am really fond of touring and will probably come out again another year—but not in the *Great Scott*; a smaller car will suit me better, thank you."

The majority of the tourists attended the smoker, going in their automobiles, which were backed up to the Washington hotel curb in a long line, augmented by those owned by local parties in attendance at the smoker. It was 1 a. m. before the last of the tourists started back to the Jefferson, all voting that they had passed a most enjoyable evening.

Reception to the Women.

Special Correspondence.

ST. LOUIS, Aug. 11.—The reception this evening at the Washington Hotel given to the visiting women motorists was one of the cosiest and most informal affairs of the World's Fair season. While the men enjoyed a smoker in one wing of the large hotel, the women motorists were entertained in the Blue Room of the Washington, the same room that was used by Prince Pu Lun for his small receptions during his recent visit to St. Louis. Mrs. L. L. Fest, of Chicago, received, assisted by Mrs. R. W. Slusser, of New York, Miss Rose Rowley, of Chicago, Mrs. E. R. Estep, of Chicago, Mrs. A. B. Tucker, of New York, and the St. Louisans, Mrs. L. B. Walbridge, Mrs. Jesse French, and Mrs. S. J. Keiffer.

Among the women present who had participated in the run were Mrs. L. E. Myers, of Chicago, Mrs. Frank X. Mudd, of Chicago, and Mrs. Gillette, of New York. Not all the ladies were present, owing to a misunderstanding as to the date of the function.

This evening has been given over to funny incidents of the journey overland, and feminine views of motoring trips. Mrs. J. M. Husted, of Uniontown, Pa., and Mrs. Mudd said they had absolutely no troubles on the way, but some of the others, who, by the way, were obliged to come into St. Louis by train, threatened to put these jubilant visitors out of the Blue Room if they didn't stop praising their cars and their drivers.

"We're all telling our troubles," said the most beautiful woman present, "and here you come in and affirm you traveled as easily as in a rocking chair, and that not even a bolt needed to be tightened. We'll put you out for this!"

R. W. Slusser came in at intervals to tell the ladies what was going on in the Smoker: "Mayor Wells, of St. Louis, is making a speech over there now, and just imagine you hear his climax, and give him a good cheer." So when the ladies thought it was time Mayor Wells had finished his peroration, they clapped enthusiastically. "Tell us when Mr. W. C. Temple, of Pittsburg, speaks; we'll applaud him, too," said a bevy of the feminine motorists.

A. B. Tucker, who was presented by the A. A. A. with a handsome gold watch for his services in connection with the meet, brought his gift into the Blue Room, where all present admired it.

The occasion was informal. Some ladies came in full evening dress with pearls and diamond ornaments, while others appeared in tan shoes, short silk skirts, and automobile veils. Several, not knowing that the reception was this evening, had dressed for the Pike, but when they learned the reception was on, and that their presence was desired, chauffeurs were directed to turn the big cars back from Lindell Boulevard Entrance to the Pike, and drive to the Washington.

Observations of a World's Fair Tourist.

Recapitulation of the Instructive Features and Incidents of the New York - St. Louis Run.

Special Correspondence.

ST. LOUIS, Aug. 11.—With the hands of the big clock in the rotunda of the Hotel Jefferson pointing to 10.30 P. M., the lobby of the hotel itself filled with tired and dusty automobilists, more than two score bespattered and soiled automobiles of all makes and sizes standing by the curb, and the faces of Chairman Post, of the touring committee, and his able assistants, Messrs. Downs and Tucker, wearing looks of relief, the greatest tour of automobilists that has ever been held in this or any other country came to an end, officially, last night. Additional machines with their tired drivers continued to roll into the city all night, however, and other belated ones will probably come in singly at various hours for several days to come.

One great fact that the run of this year has demonstrated to the world is that the little runabout and the lightweight touring car, of from 800 to 1,500 pounds, are better adapted for such a trip than the powerful touring car weighing two or three times as much and costing from three to ten times the amount of money. The largest and heaviest machine on the run, Mr. Scott's combination of Peerless and Mercedes design, built in Baltimore, of about 80-horsepower, had a series of misfortunes throughout the first half of the tour, ending disastrously at Perrysburg, O., by collision with an express train. The tourists who occupied the tonneau completed the journey by Pullman, stopping each night with the touring party, and apparently enjoying the trip as much as the more fortunate clubmates whose machines were holding out.

Quite in contrast with the troubles experienced by the Scott party in their huge car, new from the factory, was the trip of our own little car, *Pathfinder*. This car, as the readers know, had just completed one round trip from New York to St. Louis via Chicago and return via Indianapolis and Pittsburg, arriving in New York at 1 A. M. Monday morning, and started out on the second St. Louis run at 9 A. M. the same day. We had troubles, as has almost everyone who attempts to drive 1,500 miles in fourteen days, but they were minor ones. We never had to put up at a repair shop along the road nor send to the factory for parts. The car weighed about 1,300 pounds and entered St. Louis among the first arrivals at 4.30 o'clock, carrying in addition to the writer and his brother approximately 200 pounds of luggage, and, from Springfield to St. Louis, another passenger.

What was true of the behavior of our car applied also to the Cadillac and Oldsmobile, the three machines selling in the order

named at \$850, \$900 and \$950. So smoothly did these low-priced machines run over the 1,500 odd miles from New York to St. Louis that many if not most of the tourists have changed their minds regarding what the little machines can do. Other small cars, not classed with the three mentioned because they sell at more than \$1,000, but whose performances placed them among the leaders, were the Haynes-Apperson, operated by C. H. Birchwood; Pope-Hartfords, driven by Harold Pope and C. H. Gillette; Buckmobile, driven by A. J. Seaton, and Franklin, driven by H. C. Esselstyn. There were other small cars in at the finish of the run, but they did not join until the tourists had covered the first 400 or 500 miles, which was about the hardest part on the entire trip.

A feature of the run of which too much can not be said was the presence of a number of women enthusiasts. Among these Mrs. C. H. Gillette deserves special mention. Securing a nurse to look after her three young children, she set out with her husband from New York City with the intention of riding as far as Syracuse in Mr. Gillette's comfortable Pope-Hartford, the tonneau of which had been left off for the trip. Upon arriving at the Yates in Syracuse, tears came into her eyes at the thought of leaving her husband and returning via rail. An extension of time was arranged with the nurse by telegram, and Mrs. Gillette was to continue west as far as Buffalo. The trials of that ride through the mud between Rochester and Syracuse and the scorch on to Buffalo made no unfavorable impression upon this enthusiastic woman, and after more telegrams to Hartford it was agreed that Mrs. Gillette should go on through to St. Louis, providing, of course, she did not tire of the journey before the World's Fair city was reached. Mrs. Gillette did not tire, and the smile on her countenance as No. 3 passed on parade, containing the Gillettes, showed only too plainly how much this true motorist had enjoyed the tour of 1,500 miles by her husband's side.

Another woman tourist who readily accepted every hardship as it came and really enjoyed every minute of the ride was Mrs. F. C. Gates, of Cleveland, who accompanied her husband from that city in his Winton touring car. Mr. and Mrs. J. R. Blakeslee, of Cleveland, accompanied Mr. and Mrs. Gates, the four touring on their own schedule and making a pleasant party that kept out of the main crowd's dust and incidentally away from the racers.

Of course, all generally credit Mr. Scott with having the hardest luck while on the

tour, his big special being wrecked, but two other individuals deserve special mention for their perseverance in the face of hard luck. These two are President Harlan W. Whipple, an old tourist, and B. Clifford Swinehart, a new recruit to the ranks of tourists. Mr. Whipple had trouble with his Mercedes from start to finish, not that there was anything radically wrong with the machine, but it seemed to fall to Mr. Whipple's lot to have more than his share of petty troubles. To commence with, he had a different make of tire on every wheel, and first one and then another would go wrong. Then his magneto did not seem to function properly, and he had to be towed into town on more than one occasion. Once when being towed in, by the Pierce Great Arrow—Mr. Whipple's chauffeur at the wheel—such clouds of dust were raised by the Buffalo car that the steersman of the Mercedes could not even see the car that was towing him, and when that car eventually turned out for a wagon on the road the big German car crashed into the wagon, carrying away one hamper and a dust guard. This seemed to be only luck, and Mr. Whipple was trusting that "luck" would change until the last day, when the crankshaft itself broke, with the cars miles from St. Louis. The Mercedes was then down and out. Yet James L. Breese, in his big Mercedes, a car larger and more powerful than the Whipple car, came through with the leaders without experiencing a break.

Mr. Swinehart certainly had his full share of ill luck, and yet he was most persistent in his efforts to get through. He started from New York, accompanied by a photographer who knew nothing about automobiles. Things went wrong from the start, the gears refusing to work properly. An investigation on the second day out revealed the fact that some fool mechanic, either at the factory or at the garage where the machine was put in trim for the trip, had

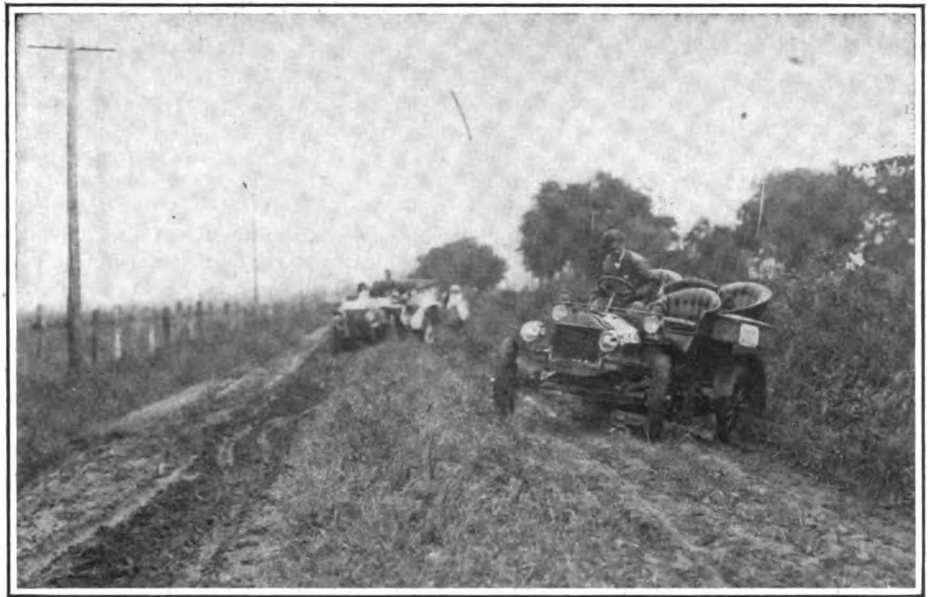

AFTER A "SHOWER" IN SOUTHERN ILLINOIS, WHERE WHEELS WERE WRAPPED WITH CHAINS.

left a file in the gear case. The tool had run through the gears and stripped them all, putting the Yale completely out of business. There was only one thing to do, and Swinehart did it. He loaded the automobile on a car and shipped it by express to the Toledo factory. When the "bunch" struck Toledo, there was Swinehart in his Yale ready to rejoin. On Wednesday, the last day of the run, Swinehart started early—we started late. As we were bowling along the country road about ten miles from Springfield we saw a man wearing the cap pin of the American Automobile Association flying toward us in a buggy, the gray mare attached to the vehicle hardly touching the ground in her haste. A glance showed us it was Swinehart holding the ribbons, and as he went sailing past, he held aloft a broken steering knuckle. A couple of miles further we came across the Yale, with one wheel off and a pile

of bricks under the axle. No, we couldn't help, so we continued on, hoping that our unfortunate friend would connect with a skilled blacksmith or machinist who could straighten matters out in time for him to be in at the finish. He was making the trip to "demonstrate" the Swinehart solid tire.

With the exception of a little shower on the first or second day out of New York, we encountered no rain on the entire trip, and the dust from Buffalo through Chicago to Springfield was pretty bad. It rained in southern Illinois during the night we passed at Springfield, but none knew it. Wednesday morning, the commencement of the end, everyone started fairly early. We started at 8 o'clock, and I think everyone had gone at that time. Mr. Hurlburt, with his Cadillac, left before 4 o'clock, and others who were anxious to be among the first to enter St. Louis, or rather East St. Louis, as we all had instructions to stop at the East St. Louis society hall until the crowd came up, or at least until 4 P. M. For about fifty miles we found little indication of rain, and, in fact, the dreaded city of Litchfield, the bottomless mud streets of which have been photographically displayed in these columns before, was passed without striking any mud to amount to much. Then the rain came. "Only a shower," said the inhabitants, when asked if it had rained hard, and yet fifty to seventy-five vehicles in the tour skidded and side-slipped until axles that had stood the 1,450 miles from New York to Litchfield commenced to spring and bend, chains tightened and squeaked, steering wheels refused to work properly, and trouble such as only an army anxious to be in at the victory could experience came to us all.

For one reason I was rather glad that it did rain a little—just enough to show the stay-at-homes—some of whom were making the run down from Chicago, after



F. A. BENSON AND PARTY, OF CHICAGO, IN OLDS TONNEAU THAT WAS BURNED IN PONTIAC.

having studied the weather forecasts for some weeks in advance—what Illinois mud is like. On our former trip we had carried a camera, and incidentally when we encountered an unusually bad stretch of roadway or a correspondingly good one we made some snap shots. A number of these photographs naturally found their way in print, some good roads and some bad, a newspaper or fairly conducted magazine always giving both sides of the case. One or two individuals took it upon themselves to criticise the writer's good faith in making these pictures for publication.

A fine showing on this run was made by the White cars. So well did these machines keep to a certain schedule drawn up by Webb Jay at the end of each night's run, and so close did they resemble one another in their coats of new white enamel, that the term "White Squadron," as used by me in one of my nightly telegraphic dispatches, was generally adopted on the run, and as the "White Squadron" will the White Sewing Machine Company's fleet steamers be known for some time to come. Augustus Post, chairman of the touring committee of the A. A. A., and to whose individual work the success of the present tour is largely attributed, travels in a White steamer. Mr. Post's car is finished in red.

From Cleveland to St. Louis R. H. Johnston drove a Peerless limousine—"house on wheels," as the natives from one end of the line to the other styled the handsome vehicle. Mr. Johnston was accompanied by E. S. Morton, who ran the car about half the time. While the "house on wheels" was most luxuriously fitted inside, it is doubtful if the "house" itself was ever invaded while en route, both Johnston and Morton preferring to ride on the seat outside. It was the first limousine that the natives had ever beheld, and it surprised more than one tourist that the big machine, with its large plate glass windows, could be so successfully brought through over the bad roads traversed without cracking a single pane of glass. The roads were rough, but the Peerless stood the strain.

Tom Fetch, driving a Panhard, of course, proved the same jolly fellow that steered *Old Pacific* across the continent. Tom's chief delight was to load his car with four representatives of tires who usually accompanied the run via train, and so cover them with dust that people not initiated would think that they, too, had come long distances as tourists.

While referring to the different drivers on this run there is one I wish particularly to mention, and that is A. T. Keely, of Ryersford, near Philadelphia, Pa. Mr. Keely started in a seven-horsepower Rambler, having only undertaken the trip after a most careful perusal of the articles appearing in *THE AUTOMOBILE* during the first trip of the little *Pathfinder*. He followed out every suggestion, even to purchasing blocks and tackle in preparation for Illinois mud, and, accompanied by his two sons, set out in the little machine. Anyone who has attempted a hundred miles a day for about two weeks' steady running, with three in a seat, and in a runabout at that, knows what Mr. Keely's work was. He stuck to it, however, and made every control on time until he reached South Bend. Here, just as he was about to start out with the early risers, his load and limited power compelling him to make an early start each day, his crank shaft broke. Frantically he hurried to Chicago to secure another, but as he had not rejoined the run before our arrival at St. Louis it is doubtful whether he succeeded until too late to make the control that night.

There is only one thing of importance in making an automobile tour of such length as this one, and that is the constant changing of drinking water. 'Tis true, there were some whom I do not think tasted water on the entire trip, and to encourage intemperance the air-cooled Franklin car, driven by H. C. Esselstyn, of New York, bore a big banner on the tonneau door, reading: "We take no water." This changing of drinking water has been known to put an entire army out of commission in a short time, and the same is true of an automobiling party.

The run has demonstrated two things that are weak about American-made cars, and these are the front axles and springs. There was hardly a car made in this country that did not need to have its front axle straightened at least once, while there were many that had to go through this operation repeatedly and eventually landed in St. Louis with the two front wheels almost rubbing the body. Springs were broken by almost every car on the run, big or small. We started out with ours strapped down very tight. Before the run almost every car had its springs strapped down, but even then numbers broke. No use mentioning any names, and it may not have been the fault of the car maker, as

I doubt if many of them make their own springs, but another year they will undoubtedly see to it that changes are made in touring-car springs.

Another great trouble seemed to be the running out of gasoline along the road. Despite all that had been said about carrying an extra or auxiliary tank, few, if any, did so, and consequently when the supply of gasoline gave out along the road there was trouble. I heard of filling tanks by using an oil gun and taking a gun full at a time from some friend's machine, and I also heard of some two and even three-mile walks to the nearest gasoline store, all unnecessary if the tourist would have forethought enough to carry even one extra gallon in a can somewhere in his machine.

A car that attracted more or less attention from Buffalo to St. Louis, it having only joined at the former city, was the little Covert. This car, driven by Harold Hoag, of the Covert factory, bore a placard on the back of the seat, reading, "The Baby," and truly it was the baby of the run. It was too bad that the Covert entry was not made in New York or Boston, in which case a certificate for the full distance could have been earned for the little car, instead of one only reading "Buffalo to St. Louis."

The run officially ended at 4:30 o'clock on Wednesday afternoon in front of the Jefferson Hotel on Twelfth street, St. Louis. The entry of the tourists from East St. Louis, where they had been gathering all day, was one triumphant procession. The St. Louis *Globe-Democrat*, telling about it, says: "Thundering across Eads bridge in a column a mile long the auto brigade of the American Automobile Association's big tour made its entry into St. Louis at 4 o'clock."

Well, I guess that column was pretty nearly a mile long, and there was some thunder when those big machines opened their mufflers in an attempt to climb Eads bridge hill on high speeds. Mayor Cook, of East St. Louis, rode in the first car across the bridge, where his car dropped out and a car containing President A. B. Lambert and the local reception committee took its place. Washington street was lined with people, who cheered the machines as they passed with their begoggled occupants, plentifully decorated with the mud of the day's run.

PERCY F. MEGARGEL.



WORLD'S FAIR TOURISTS' CARS ON THE LAKE FRONT DRIVE, JACKSON PARK CHICAGO.—PASSENGERS LUNCHING IN GERMAN BUILDING.

Buffalo's Record-Breaking Two-Day Meet.

Special Attractions at Kenilworth Track Are the Green Dragon, Gray Wolf, Tornado and Bullet No. 3.

Special Correspondence.

BUFFALO, Aug. 16.—So successful was Buffalo's first automobile race meet, held on the Kenilworth Park track Friday and Monday, that it has already been decided to make the affair an annual event.

Practically the entire day Friday was devoted to the sport. There was a parade in the morning, which formed at the City Hall and wended its way through the principal business streets. A. H. Knoll, president of the Automobile Racing Association, which promoted the meet, led the procession, preceded by a squad of bicycle police. Mem-

had the track smooth and hard for the racers, and the grandstand was thronged with gaily dressed women and their escorts, while many motor cars were gathered behind the stand.

The first day's racing was replete with sensational finishes and enthusiasm. Interest centered on the five-mile race for the Diamond Rubber Company's challenge cup. It was won by Oldfield, but only after the hardest struggle with Harry Lyttle. Oldfield, in the Peerless *Green Dragon*, challenged Lyttle, in the eight-cylinder Pope-

force. Buffalo never saw auto racing before and the way the people took to it bodes well for the sport in the future.

In the ten-mile race for cars weighing from 881 to 1,432 pounds, W. F. Winchester, in a Franklin, won with a flat tire. The tire burst in the second mile, but he kept on to the finish. His performance created much excitement, and he was heartily cheered. Mrs. Eva M. Rogers rode a Thomas motorcycle two miles in 3:28 1-5 against a strong breeze.

The last event of the first day was an exhibition mile by Barney Oldfield, in which his time was :58 2-5. After the races the spectators surged onto the track to get a glimpse of the *Green Dragon* and its driver.

Saturday's program had to be postponed to Monday owing to rain. Two world's records were made in the afternoon, the first in the light car class by Charles

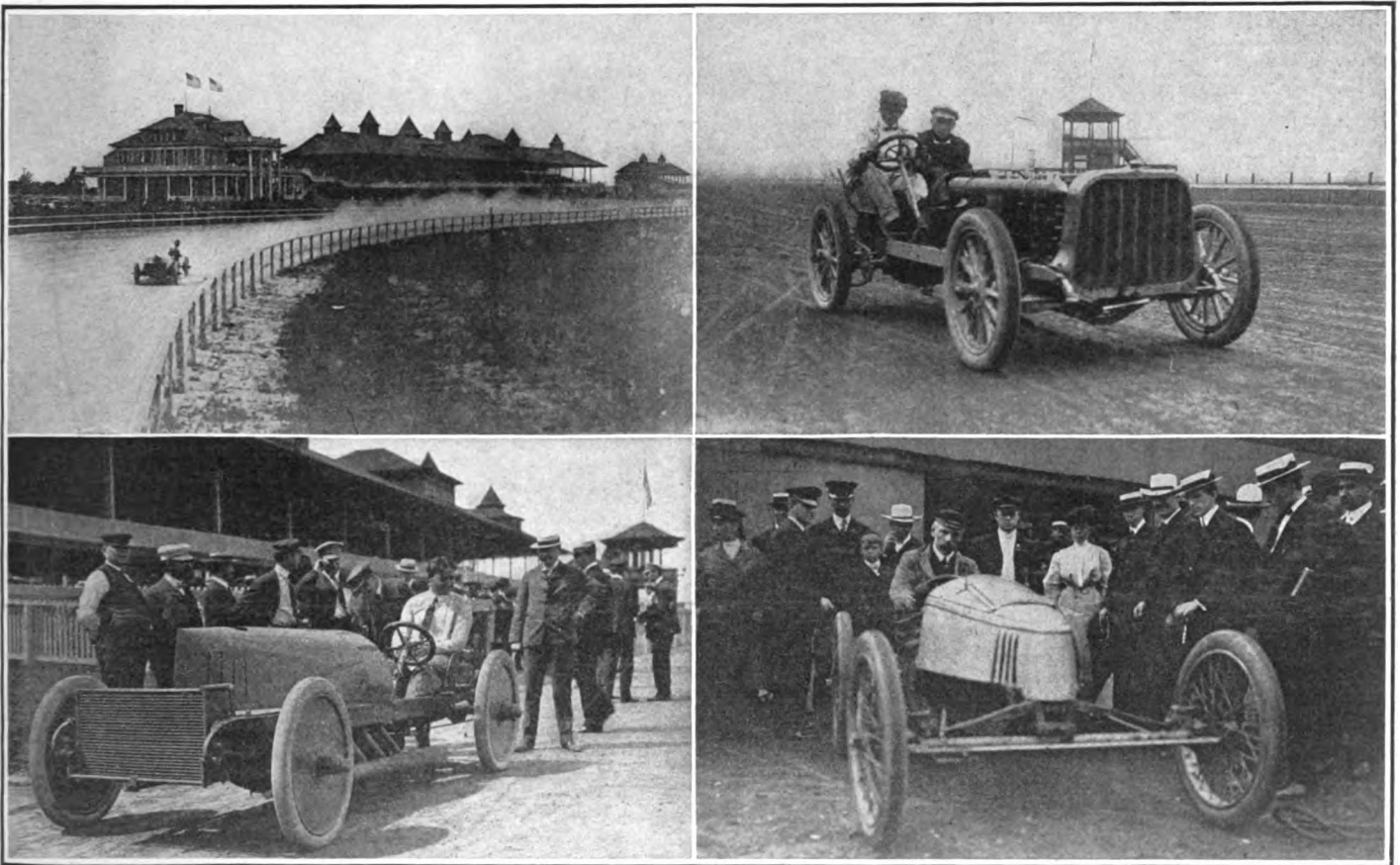

Passing Grandstand and Clubhouse in Fifteen-mile Free-For-All. Oldfield in Remodeled Peerless Gordon Bennett Racer, "Green Dragon."

Herbert Lyttle in Pope-Toledo Eight-cylinder Racer, "Tornado." Charles Schmidt, in Packard "Gray Wolf," After Breaking Records

bers of the Automobile Club of Buffalo and many other motorists turned out for the event, and there were very few machines in town that were not in line. President William H. Hotchkiss, of the club, was in the line of big cars. Behind the touring cars and runabouts rode Barney Oldfield in his *Green Dragon* and Charles Schmidt in the *Gray Wolf*.

The appearance of the racing cars on the street increased public interest in the races, and street cars going to the track were crowded long before the time for the opening of the first event. Superintendent Judd

Toledo *Tornado*, at the first turn in the third mile and by a tremendous burst of speed got the lead, which he held to the finish. The winner's daring ride was vociferously applauded by the 5,000 spectators. It was officially announced that the time of the race was 5:10, the last mile in 59 seconds. Four stop watches in the boxes in the grandstand caught the time at 4:49, which would have established a new record for five miles in competition on an oval track.

The day was perfect for racing, the crowd was a happy one, and society was out in

Schmidt in the Packard *Gray Wolf*, who drove around the mile oval twenty-five times in 28:32 1-5. Later Oldfield finished a twenty-five mile run in 26:42, a new mark for machines of the heavy class.

Despite the heavy rain last Saturday afternoon and night, which caused the postponement, Superintendent Judd had the track in the best possible condition and the racers were highly pleased.

In the fifteen-mile free-for-all H. H. Lyttle's Pope-Toledo did not put in an appearance, a part of the machinery having been broken Saturday. The only starters

were Oldfield and George Graham, the latter driving Winton *Bullet No. 3*. For the first few miles Oldfield led by only a few yards, but after the third mile he let out the *Green Dragon*, and at the end of the eighth mile *Bullet No. 3* was a lap behind and the distance was steadily increased. At the beginning of the race it had been announced that after the fifteen miles Oldfield would continue in the effort to make a new twenty-five-mile record for cars in the class from 1,432 to 2,204 pounds. The fifteen miles were made by Oldfield in 16:23 3-5, and for the twenty-five miles the time was 26:42, a new record.

The greatest rivalry of the meeting was in the Buffalo Handicap. Charles P. Soules, driving a Pope-Toledo; Erie Mock, driving a Pierce Great Arrow, and W. A. Lutz, in a Pope-Toledo, started from scratch, with C. H. Williams in a Stanley steamer, F. C. Carter, in a Rambler, C. F. Gilmore, in a Ford, and I. N. Stewart, in a Rambler, on the three-quarter-mile mark. Soules, who had removed the tonneau from his car, was soon in the lead of the scratch starters. The scratch men overtook and passed the long markers, and Soules won the race, he and Mock crossing the finish line about half a mile ahead of the others.

To close the day, Oldfield attempted to break the two-mile record of 1:50 1-5. He made the first mile in one minute flat, but on the second lap something went wrong with the carbureter and after circling the track twice in 2:04 4-5, he was obliged to give up the attempt.

Summaries of the two days' racing are as follows:

Friday.—Five-mile motorcycle race.—Frank Robertson, 1st; S. B. Eagan, 2nd; J. S. Willet, 3rd. Time, 7:17 2-5.

Ten miles for cars of any power from 881 to 1,432 pounds.—W. F. Winchester, Franklin, 1st; F. Kulick, Ford, 2nd. Time, 12:24 2-5.

Five miles for touring cars with full road equipment and four persons.—C. P. Soules, Pope-Toledo, 1st; H. H. Lyttle, Pope-Toledo, 2nd. Time, 6:40 1-5.

Two miles for Ford cars.—Charles F. Gilmore, 1st; F. C. Carter, 2nd; Emil Burkhard, 3rd. Time, 3:29 2-5.

Motorcycle exhibition, two miles, by Mrs. Rogers. Time, 3:28 1-5.

Five miles for cars of any motive power, weighing from 551 to 881 pounds.—W. F. Winchester, Franklin, 1st; F. Kulick, Ford, 2nd. Time, 5:34.

Two miles for Orient Buckboards.—E. R. Durkee, 1st; L. H. Roberts, 2nd; Homer Scott, 3rd. Time, 4:10.

Five-mile free-for-all for Diamond Rubber Company Challenge Cup.—Barney Oldfield, Peerless *Green Dragon*, 1st; H. H. Lyttle, Pope-Toledo *Tornado*, 2nd; W. F. Winchester, Franklin, 3rd; George Graham, Winton *Bullet No. 3*, 4th; Time, 5:10.

Two miles for Cadillac cars.—M. Fisher, 1st, R. H. Yates, 2nd; Jim Johnson, 3rd. Time, 3:48 2-5.

Two miles for Oldsmobiles.—F. C. Carter, 1st; E. Jaynes, 2nd. Time, 5:03 2-5.

One mile exhibition by Oldfield, *Green Dragon*. Time, :58 2-5.

Five-mile exhibition.—Charles Schmidt, Packard non-stop record car. Time, 7:15 1-5.

Monday—Two miles for Franklin cars, road equipment, two persons.—F. R. Alliger, 1st; John W. Gibbs, 2nd; W. H. Baker, 3rd. Time, 3:38 2-5.

Two miles for Pierce cars, road equipment, two persons.—George Ulrich, 1st; A. J. Keller, 2nd; F. Dey, 3rd. Time, 4:44.

Two miles for Rambler cars, road equipment, two persons.—F. C. Carter, 1st; O. E. Yeager, 2nd; M. M. Wall, 3rd. Time, 3:33 1-4.

Twenty-five mile record trial.—Charles Schmidt, *Gray Wolf*. Time, 28:32 1-5.

Fifteen-mile free-for-all, cars from 1,432 to 2,204 pounds.—Oldfield, *Green Dragon*, 1st; George Graham, *Bullet, No. 3*, 2nd. Time, 16:23 2-5. Oldfield's time for twenty-five miles, 26:42.

Two miles for Thomas cars.—Burt Tompkins, 1st; Cal Paxon, 2nd; J. C. Milsom, 3rd. Time, 3:29 4-5.

Two miles for Haynes-Apperson cars, road equipment, two persons.—F. F. Norris, 1st; J. J. Gibson, 2nd; C. A. Cutler, 3rd. Time, 3:54 1-4.

Five-mile Great Buffalo Handicap, cars owned in Erie and Niagara counties.—Charles Soules, Pope Toledo, 1st; Erie Mock, Pierce *Great Arrow*, 2nd; W. A. Lutz, Pope-Toledo, 3rd. Time, 6:46.

Two-mile record, trial.—Barney Oldfield, *Green Dragon*. Time, 2:04 4-5.

Bexhill Three-Day Meet.

Special Correspondence.

LIVERPOOL, Aug. 6.—Bexhill, the well-known sea-side resort on the English south coast, has held several motor race meetings on previous occasions, but a record muster of cars attended the meet held this week, commencing Monday, August 1. Bexhill has the almost unique attraction of having a perfectly laid motor track on the sea front, the length being sufficient for either a flying or a standing kilometer. A kilometer with standing start was arranged, the finishing point being at the top of a sharp rise, known locally as Galley Hill. This is about 150 yards long, and as it has a gradient of 10 per cent., fast speeds were not usual. A strong breeze, dead in the face of the competitors, also militated against fast riding. The track was in fine order, and although usually rather dusty, the several sprinklings with Westrumite made before each day's racing allayed all dust. In fact, even the fastest car left not the slightest signs of dust in its wake.

Under a blazing sun the competing cars, to the number of sixty or seventy, proceeded in single file through the town to the sea front. Here were assembled the lady judges, headed by the Countess de la Warr, who were to choose the three best decorated and most attractive cars. First prize was awarded to Walker Munro's 22-horsepower Napier, second to Gurney Preston's 28-horsepower Mercedes, and third to S. F. Edge's 20-horsepower Napier. The parade was followed by a luncheon given by Earl de la Warr to the prominent visitors and press.

After the luncheon, the principal events of the meet—the races for touring cars—were held. The cars were divided into six classes, according to price. The first class, for cars costing under \$1,000, brought out a large number of competitors, including several American cars. The finals of this class, held on the next day, found the winner in Henry Sturme's 10-horsepower Dur-yea three-wheeler, which covered the kilometer in 1 minute 14 1-5 seconds. A Cadillac, Ford and Oldsmobile also competed.

In the second class, for cars costing between \$1,000 and \$2,000 and carrying four passengers, more exciting racing was seen. An amusing event occurred in the fourth

heat, in which a 9-horsepower Clement was matched against S. F. Edge's 9-horsepower Gladiator. The Clement refused to budge at the start, and the Gladiator rushed off by itself. Half way along the course the Gladiator punctured and stopped; whereupon the driver of the Clement, getting his engine started at last, rushed past Edge and won the heat. W. Whiteway's 14-horsepower French Regal won the final of this event. In the third class, for cars valued between \$2,000 and \$2,750, Mr. Hall's 15-horsepower Darracq proved the winner, another Darracq coming in second.

The fourth class brought out the largest number of starters of any event. This was for cars costing between \$2,750 and \$3,750, and eleven heats were run. In the ninth heat Earl de la Warr, the promoter of these trials, received an ovation when he came in a winner on his 18-horsepower Daimler. The best reception, however, was accorded in the tenth heat to Mrs. Manville, who drove her 18-horsepower Daimler to victory. In the finals of this event, A. H. Walker came in first on his 30-horsepower Darracq, just beating Earl de la Warr.

Next came a most popular event—the section for cars of high power, costing between \$3,750 and \$5,000—and in this some very fine racing was seen. After three fast rounds S. F. Edge won a popular victory on his 20-horsepower Napier in 51 3-5 seconds; second and third places being captured by 28-horsepower English Daimlers.

The last racing event was the class for high-powered cars, irrespective of price, each having to carry five passengers. Six heats were run, and some of the times were very close. A. Guinness, on his 60-horsepower Mercedes, travelled the kilometer in 50 3-5 seconds; Edge, on his Napier, in 52 seconds, while S. Girling, one of the English competitors in the Gordon Bennett race, did fast time on a 28-horsepower Wolseley. In the final, Mr. Guinness did the fastest time of the day, his 46 4-5 seconds representing a speed of 48 miles an hour. Considering the standing start and the incline of Galley Hill before the finish, the performance was very satisfactory. A 28-horsepower Bollée car came in second.

Tuesday the sun shone with even greater intensity than on the preceding day, and as the heat became greater the interest of the spectators began to flag. About 5,000 people were at the track on this day as against the 9,000 or 10,000 on Monday. The events consisted of the semi-final and final races, and the results of these have been incorporated in the account of Monday's events to avoid confusion. An additional spice of interest was added by a motorcycle handicap, which was run with heats of five competitors. After some close work, Genn, on an Eland (with Minerva engine), came in first; Tessier, on a Bat (De Dion engine) being second.

Wednesday's program concluded the meeting with a procession of flower-decorated cars, a battle of flowers, and a gymkhana.

Long Branch Automobile Week.

Staff Correspondence.

LONG BRANCH, N. J., Aug. 16.—Summer residents and natives of this fashionable resort on the New Jersey Coast have been thinking, talking and riding automobiles for a week past to the exclusion of horse and dog shows and the other established attractions which go to make up the average veranda conversation. Some weeks ago "Senator" W. J. Morgan, the originator of the Ormond Beach races and the Mount Washington hill-climb, visited Long Branch, stayed two or three days, and as a result this week is known as "Automobile Week," with a program including an automobile show, a 2,000-mile non-stop run, straight-

report its progress. The aim of Mr. Bowman is to eclipse the non-stop record of 2,017 miles established by D. M. Weigel, of England.

In the afternoon, the straightaway races on the boulevard were held and furnished the principal excitement of the early part of the week. Owing to the shortness of the road and the difficulty of securing proper protection for spectators, the races were limited to quarter and half-mile dashes. At the finish in front of the West End Hotel a grandstand had been erected for the guests of the various cottages. Several thousand persons, mostly women and children,

passed before traveling a quarter of a mile and easily beaten. In the second heat, a rolling start, both of the cars came down to the starting line on second speed. Edward Hawley, the driver of Mr. Thomas's car, threw in his third speed as he touched the line and immediately after the fourth speed, and jumped away from Mr. Harkness. In the finish of this heat Mr. Harkness struck a big dog, killing it instantly, while Hawley, failing to make the turn at the end of the road, jumped over the curb and ran about thirty feet on the grass-plot before he could bring his car to a standstill. Fortunately, anticipating just such an occurrence, there were no spectators at the turn, the officers being particular to keep this part of the course clear.

In the half-mile open event for machines



E. R. THOMAS WINNING HALF-MILE DASH FROM H. S. HARKNESS ON OCEAN DRIVE, LONG BRANCH, AUGUST 15.

away dashes on the beach drive, races on the Elkwood Park track, a floral parade, a gymkhana and an automobile ball on the last evening—Saturday—at the exclusive Hollywood Hotel.

The week opened yesterday with the start of the non-stop run of the Clément-Bayard car owned by Sidney B. Bowman. The car was sent off after being showered with wine by Miss Virginia Harned, the actress, and during the week will travel between Long Branch and Spring Lake, the round trip being about twenty-five miles. The drivers are Clovis Bertrams, F. E. Muscovics, and Sidney B. Bowman. The car will be kept running day and night and a corps of observers have been appointed to watch and

watched the events, and to many of them—judging by the reception they accorded the various competitors—it proved an interesting spectacle. The officials had considerable difficulty in keeping the road clear and avoiding accidents, notwithstanding that half of the entire Long Branch police force—twelve men—were on hand to keep the people on the sidewalks. But after they had seen Harry Harkness's and E. R. Thomas's Mercedes cars travel at speed, the spectators did not evince so great a desire to stand in the middle of the road.

The chief event of the afternoon was the race between these two cars. In the first heat, from a standing start, Harkness got away quicker than his opponent, but was

costing from \$2,000 to \$3,500, Joseph Tracy, in a four-cylinder Royal, beat the Berg car by several lengths. The race for electrics, most of the drivers of which were residents of Long Branch, resulted in Mrs. C. C. Miller, in a Waverley, finishing a few feet ahead of Mrs. A. L. McMurtry, also in a Waverley.

The races were timed by an ingenious device invented by A. L. McMurtry, of the Automobile Club of America. Mr. McMurtry had instruments at the half and quarter mile points connected with the watches at the finish, so that the pressing of a button at these points started the watches going as the cars passed them. A telephone forms a part of the equipment so that the

timers along the course were kept in touch with the officers at the finish. Mr. McMurry's machine, which attracted considerable attention, is equipped to time races at the quarter, half, kilometer, three-quarter and mile marks. The telephones are connected to the wire of any existing telephone line.

Following is a summary of the day's events:

Half-mile, best two in three, for stock cars not exceeding \$650.—First heat: H. L. Lewis, Oldsmobile, 1st; John Hansen, Olds, 2d; F. W. Stockbridge, Olds, 3d; time, 1:23. Second heat: F. W. Stockbridge, 1st; H. L. Lewis, 2d; time, 1:11. Third heat: H. L. Lewis, 1st; F. W. Stockbridge, 2d; time, 1:23.

Half-mile, free-for-all, best two in three.—First heat: Edward Hawley, in E. R. Thomas's Mercedes, 1st; Harry S. Harkness, Mercedes, 2d; time, :40 2-5. Second heat: E. R. Thomas, 1st; time, :31 4-5; H. S. Harkness, 2d; time, :34 3-5.

Half-mile, best two in three, stock machines, \$2,000 to \$3,500.—First heat: Joseph Tracy, Royal Tourist, 1st; time, :51 3-5; Frank Sibley, Berg, 2d; time, :53 3-5; H. R. Lounsbury, Jr., Meteor, 3d. Second heat: Joseph Tracy, 1st; time, :45 3-5; H. R. Lounsbury, 2d; time, :57; Frank Sibley, 3d. An extra heat to decide second place was won by Sibley.

Half-mile, best two in three, for electrics.—First heat: Mrs. C. S. Miller, Waverley, 1st; Mrs. A. L. McMurry, Waverley, 2d; C. C. Miller, Woods, 3d, and Arthur Courdler,

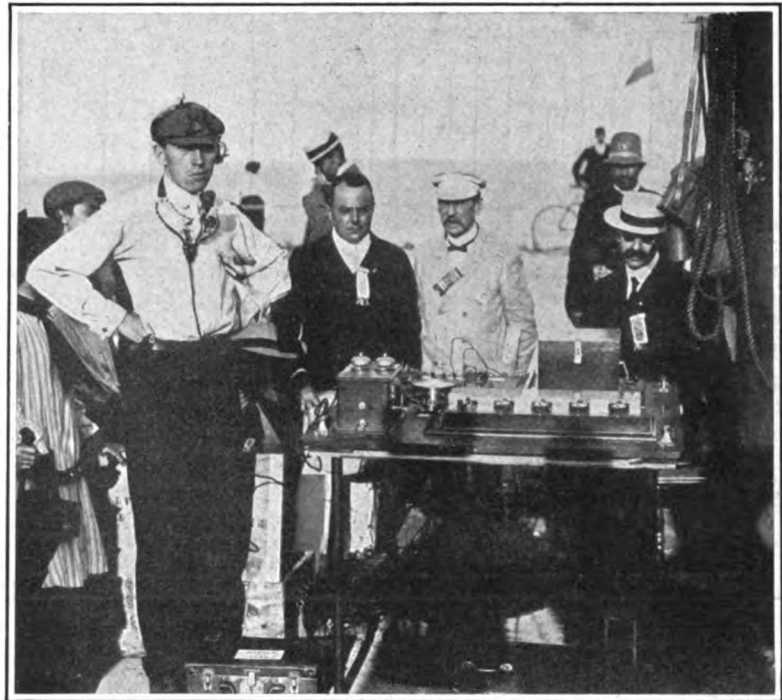

McMURTRY TIMING APPARATUS, SHOWING STOP WATCHES AND TELEPHONE.

Studebaker, 4th; time, 2:03 1-5. Second heat: Mrs. C. C. Miller, 1st; Mrs. A. L. Mc-

Murtry, 2d; C. C. Miller, 3d, and Arthur Courdler, 4th; time, 1:57.

Quarter-mile, best two in three, for machines from \$650 to \$1,600.—First heat: J. F. Johnson, Franklin, 1st; Richard De Gray, Franklin, 2d; F. W. Stockbridge, 3d; time, :44. Second heat: Richard De Gray, 1st; J. F. Johnson, 2d; F. W. Stockbridge, 3d; time, :35 3-5. Third heat: De Gray, 1st; Johnson, 2d; Stockbridge, 3d. Time not taken.

In the evening the automobile show in the Casino, a building which is ordinarily used for dancing, at the rear of the West End Hotel, was formally opened. On the opening night there were fifteen exhibitors as follows:

Worthington Automobile Co., Berg and Meteor cars; Pope Mfg. Co., Pope-Hartford and Pope-Tribune; Packard Automobile Co., Packard; Elberon Automobile Co., a Durkopp car owned by C. C. Miller, of Long Branch; Motor Car Co., of New Jersey, Cadillac and Rambler; Puro Mfg. Co., hand cleaner; Samson Tire Co., protected anti-skidding tire; Hartford Rubber Works Co., Hartford and Dunlap perfected tires; Duerr-Ward Co., four-cylinder Royal; American Automobile Storage Co., two Franklins and an Oldsmobile; Smith & Mabley, Mr. Thomas's 60-horsepower Mercedes; A. L. McMurry, timing apparatus; Continental Caoutchouc Co., Continental tires.

Wednesday's Track Events.

Special Telegram.

LONG BRANCH, Aug. 17.—To-day's racing on the Elmwood Park mile trotting track opened with a 100-mile race, to establish a track record for the distance. This event was won by H. S. Harkness, with his 60-horsepower Mercedes, who was awarded the race at the end of sixty miles, all the other contestants having withdrawn. Joseph



E. P. Nussbaum, Arthur A. Zimmerman, W. J. Morgan, Edward C. Bald. EX-BICYCLE CHAMPIONS OFFICIATING AT LONG BRANCH MEET.

Tracy, in a 36-horsepower Royal, covered thirty-six miles, and Edward H. Hawley, in E. R. Thomas's 60-horsepower Mercedes, covered twelve miles. Harkness's time for twenty-five miles was 28:30 2-5; for fifty miles, 1:01:23 1-5, and for sixty miles, 1:12:40 3-5—track records for fifty and sixty miles. The fastest mile was made in 1:05.



AWAITING REPORT OF THE STARTER'S PISTOL IN THE RACE FOR RUNABOUTS ON OCEAN DRIVE, LONG BRANCH.

R. Newton, in an Autocar, won the one-mile race for machines costing \$650 to \$1,000, best two in three heats; his time for the fastest heat being 1:50 3-5. L. W. Lord, in a Pope-Hartford, was second in 1:51 3-5. Arthur S. Winslow, in a Cadillac, was third.

Harkness made another win in the three-mile race for machines costing from \$5,000 to \$15,000, defeating Hawley, in Thomas's Mercedes, who was second, and Charles R. Greuter, in a 24-horsepower Matheson, who was third. The times were: Harkness, 3:28 1-5; Hawley, 3:38, and Greuter, 4:14 4-5.

James D. Marston, on an Alycon motorcycle, covered a mile in the motorcycle trials in 1:46, the next best time being 2:10 1-5, made by Frank Deterling.

The most novel event of the day was a five-mile race for touring cars, in which four passengers had to be picked up, one at the end of each mile, except the last. This was won by Greuter, in the Matheson car, in 8:48 2-5, A. Murray, in a Panhard, being second, in 9:46 2-5; H. R. Lounsbury, in a Meteor, third, and Frank Sibley, in a Berg, fourth.

E. R. Thomas captured the one-mile free-for-all, best two in three heats, with his Mercedes, taking the first heat in 1:06 2-5, with Harkness second, in his Mercedes of the same power, in 1:09 3-5, and E. H. Hawley taking the second heat, in Thomas's Mercedes, in 1:05 4-5, defeating Harkness, whose time was 1:10 3-5.

The program was concluded by the Clement non-stop car making a round of the track in its 1,100th mile.

The Mayor will issue a proclamation asking the citizens to decorate their houses on Saturday, when the floral parade is held. The exhibition of automobiles is being well attended.

MOTORIST'S IRE STIRRED.

Jersey Physician Brings Complaint Against Policeman for Irregular Proceedings.

The police, village constables and town sheriffs, in their eagerness to gather in cash-paying prisoners, frequently disregard the requirements of the law applicable to automobilists without exciting surprise;

ten days' grace was allowed the owners of a new automobile. The Secretary of State replied that the application was not in proper form, affidavit not having been made to the description of the machine, whereupon Dr. Bell made fresh application, according to the requirements of the law.

Shortly afterward Dr. Bell, while riding in his car in Hackensack with Mrs. Bell, was arrested without a warrant by an offi-

but recently a case occurred in New Jersey which is out of the ordinary.

Dr. J. Finley Bell, of Englewood, N. J., for some time used a gasoline runabout, duly licensed, which, however, he found too small, and recently purchased a touring car. He at once applied to the Secretary of State for New Jersey for a license for the new car, and, pending its arrival, continued to use the machine, believing that

cious policeman and haled before a magistrate under protest. In making the arrest the officer climbed into the car and told the doctor to drive to the magistrate's residence; but the doctor promptly ordered him out, and, leaving the machine standing in the road, accompanied the officer on foot. The matter was explained to the magistrate, who imposed a fine of \$15, the penalty provided by the New Jersey law for failure to carry a license. The doctor was allowed to depart on stating that he would send a check for the amount next day, under protest, however.

The following day Dr. Bell, accompanied by a lawyer, called upon the magistrate and tendered his check for the \$15, asking at the same time for a copy of the records, as he wished to appeal. The magistrate informed him that there were no records of the transaction whatever, and it then transpired that not only was this the case, but that the policeman had made no declaration or affidavit, having simply made a verbal complaint. The magistrate then refused to accept Dr. Bell's check, on the ground that it was not legal tender, and when offered cash in ten minutes, declined that also, saying that he would have to consult the commission counsel on the matter.

Dr. Bell is to lay a complaint against the policeman for having exceeded his authority (according to the Scovil law an automobilist can only be arrested without a warrant when racing with another machine or for a wager on the highway), for conduct unbecoming an officer, and for trespassing on Dr. Bell's property. The complaint of false arrest is now in preparation.

The victim of the irregular proceeding has received a letter from the magistrate stating that the case against the doctor would be dropped, which, however, is not likely to end the matter. "For the benefit of the automobilists in general," said Dr. Bell, "I propose going on with my suit against the officer. Further, the law of New Jersey provides special road privileges for physicians, and I hold that, as these provisions were made for the purpose of expediting the physicians' work, they can in no way be abrogated by the use of the automobile instead of the horse-drawn vehicle, which was the only road conveyance for physicians when the law was framed."



McMURTRY USING THE FIELD TELEPHONE

Details of International Auto-Boat Race.

Special Correspondence.

LONDON, Aug. 6.—The Harmsworth Cup was won this year off Ryde, Isle of Wight, England, by the same boat that won it last year in Ireland—the *Napier Minor*—handled by S. F. Edge, beating the Richard Brasier boat, *Trèfle-à-Quatre*, by 1 minute 24 seconds over the course of 7.7 nautical miles. Her time was 23 minutes 3 seconds, and that of the French champion 24 minutes 27 seconds. These two boats were the only competitors in the final contest, the others having been disposed of in various ways earlier in the contest.

The *Hutton* could not get her motor to run; *Champak*, entered by Thornycroft, and *Fer de Lance*, entered by Lord Howard de Walden, were not ready to start. These are all English craft. The French boat *Bayard* was to have run in the first heat with *Napier II* and *Challenger*, but fouled her propeller on a chain while doing fancy stunts at high speed just before the start, and as a consequence was unable to compete

ner of the heat to be pitted in the final against *Trèfle-à-Quatre*, the only boat that was not either beaten or damaged. This

Minor was permitted to take her place. A protest was entered by *Trèfle-à-Quatre*, but the committee overruled it.

The highest-powered boat in the fleet was the French launch *Bayard*, with engines of 180-horsepower. Next in order was *Challenger*, with 150-horsepower, while *Trèfle-*



AMERICAN CONTESTANT "CHALLENGER," DEFEATED THROUGH IGNITION TROUBLE.

heat developed the finest piece of racing of the whole series, for the boats were close together all the time and running grandly.

à-Quatre had but 82-horsepower. The engines of *Napier Minor* are rated at 55-horsepower only, and those of *Napier II* at 90-horsepower.

The final race was witnessed by the King, who requested a postponement so that he could see it, and also a change of course, which made the finish practically invisible from the shore. His Majesty had a glorious view from his yacht *Victoria and Albert*, while several thousands of his subjects stood on the shore in the rain, which favored the occasion, and strained their eyes the while they wondered what was going on out in the mist.

A boat that promised well was *Mercedes*, but she was ruled out because her hull was not of German build, the rules requiring that every part of a competing boat should be built in the country she represented.



ENGLISH VICTOR "NAPIER MINOR," WHICH HAS WON THE CUP TWICE.

in her heat. The steam-propelled *Serpollet* failed to put in an appearance, and in the first heat of the series *Challenger*, the only American boat, was beaten by *Napier II*. *Challenger* got away first with a good start, and was for a time running faster than the English competitor. Trouble developed in the ignition system, however, and very soon the four forward cylinders refused to work, leaving the remaining half of the engine to drive the boat and the dead half of the motor as well. She finished in 26 minutes 3 seconds, 1 minute 44 seconds later than *Napier II*, which could not get the starboard engine running at the start, which allowed the American boat to gain a lead that might have landed her a winner had her engines not failed.

In the second heat *Napier Minor* went over the course in 23 minutes 21 seconds, considerably better time than that made by *Napier II* in the preceding heat. This was the heat in which *Serpollet* was to have competed.

The third heat was also a walkover, and a slow one at that, the sole performer being *Trèfle-à-Quatre*, and her time 25 minutes 20 seconds.

In the fourth heat the competing boats were *Napier II* and *Napier Minor*, the win-

The winner, *Napier II*, was timed at 24 minutes 7 seconds, *Napier Minor* coming in



FRENCH REPRESENTATIVE "TREFLE-A-QUATRE," DEFEATED BY 1 MINUTE 24 SECONDS.

only 16 seconds later. Notwithstanding her win in the semi-final heat, *Napier II* did not compete in the final, as her hard racing had strained her considerably, and *Napier*

After winning her heat with the French boat, *Napier Minor* circled about the King's yacht, but Mr. Edge was not asked on board, as some thought he would be.

Correspondence

Through the Desert Sands.

Editor THE AUTOMOBILE:

Sir:—Ten days from San Francisco finds us in Ogden. This is about half the time taken by any other transcontinental machine in crossing these wastes of sand. We have hit her hard and left a trail of alkali dust that looked as though the plains were afire. We had quite a coat of this dust on when we pulled in here yesterday at 6 p. m. The car stands it remarkably well; the only break was one in the chain, and we had two punctures. After seven days on the desert, green stuff looks good to our sore eyes. A bathtub was appreciated, and so was a good square meal at the Reed Hotel, where we are stopping. We leave to-morrow for Denver.

Carris is cleaning out the alkali and sage brush from the machine to-day while I write. We are sorry to leave this hospitable city for the wilds of Wyoming. Yea, verily, automobiling in the Far West is no picnic. Carris never saw the sage brush country before, and I guess he won't forget it very soon.

This sand and desert is a corker to him. He never had seen this beautiful desert of America before, living most of his life in New York State, and, to tell the truth, I think he is more scared than the Franklin at the long pulls between water.

Last Sunday night we left Golconda at

"whooping her up" in true Western style. I don't know but I should myself, if I had to live in this kind of a hot bed of alkali dust. We run the chain dry, without oil, finding this best in so much sand and dust, as it keeps bright and shiny, while if oiled it would be a mass of grit and grease.

Ogden, Utah.

L. L. WHITMAN.

Motors in Launches and Autos.

Editor THE AUTOMOBILE:

Sir:—The question has often arisen

would give me a few words of explanation on this matter, and also state if you know of any manufacturer in the United States who equips up-to-date automobiles with two-cycle engines.

E. A. B.

Fort Wayne, Ind.

The four-cycle motor, while necessarily much more complicated than two-cycle, can be run at higher speed and for a given weight will develop more power than the two-cycle motor, as the scavenging of the burnt gases in the cylinder after each im-

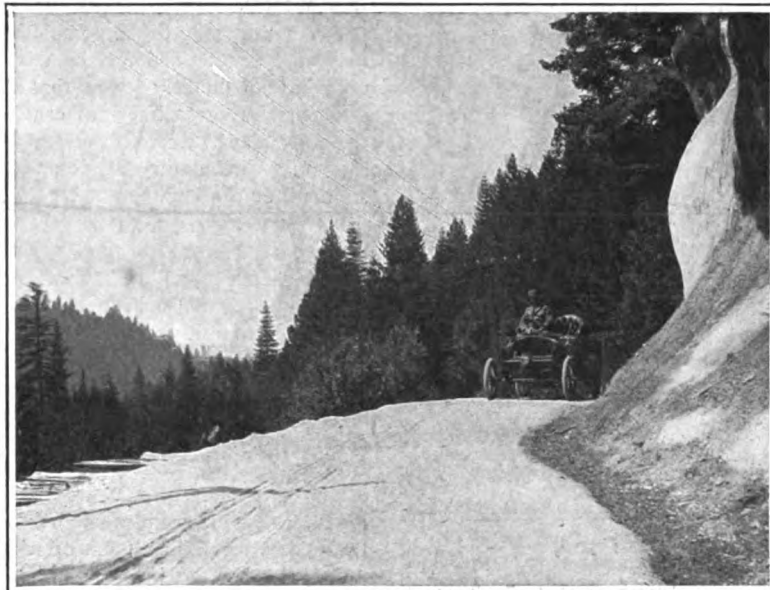

CLIMBING THROUGH THE PICTURESQUE MOUNTAIN COUNTRY OF NEVADA.

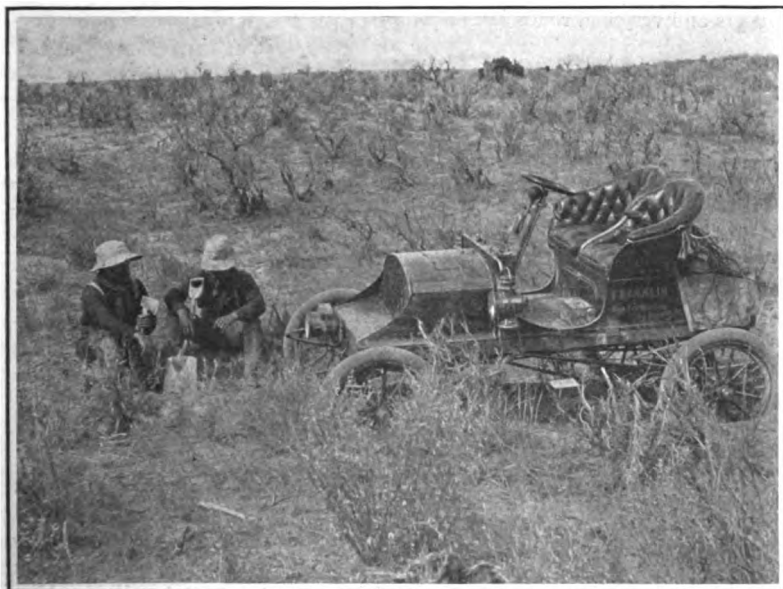

WHITMAN AND CARRIS "HUNG UP" IN THE DESERT AND CONSIDERING.

5.10 o'clock and there was not a drop between there and Battle Mountain, forty-five miles, and not a living soul. We made the run in less than three hours, making one stop for a snap shot, and jerked out the clutch at 8 p. m., just before dark, in front of the hotel in the little settlement of Battle Mountain, Nevada. That place is most all saloon, and most of the inhabitants were

among owners why it is that automobiles are almost always equipped with four-cycle engines having one or two cylinders whereas motor boats almost invariably are equipped with two-cycle engines, although there are probably more four-cycle engines used in launches than there are two-cycle engines used in automobiles.

If it is not too much trouble, I wish you

pulse stroke is more thorough and the fresh charge is uncontaminated. It also has a greater range of speed. The two-cycle engine is used very largely in boats because it is cheaper to build than the four-cycle, is simpler and in a boat the matter of weight is of less importance than in an automobile. All of the auto-boats built for racing are equipped with four-cycle automobile engines, while the two-cycle motor is used almost altogether in the slow-pleasure launches. A. J. Leighton's *Adios* is a notable exception to the rule in racing boats.

The only automobile fitted with two-cycle motors that are on the market, so far as we know, are the Elmore car, made by the Elmore Manufacturing Company, of Clyde, O. Some of them are fitted with single cylinder horizontal engines and others with twin cylinder vertical motors, all of the two-cycle type. One of these vehicles has shown its efficiency by making a round trip from New York to St. Louis and back in June and July, and then immediately starting again in the A. A. A. tour from New York, arriving in St. Louis August 10.

President Frederick D. Underwood, of the Erie system of railways, who is an enthusiastic automobilist, has had one of his machines fitted with flanged wheels, and is now using it in making trips over the lines of his steam system.

THE AUTOMOBILE

VOL. XI.

No. 7

Published every Saturday by

THE CLASS JOURNAL CO.,

Flatiron Building, Madison Square,
NEW YORK CITY.Cable Address - - - Autoland, New York
Long Distance Telephone - 300 Gramercy, New York

SUBSCRIPTION RATES:

United States, Canada and Mexico, - One Year, \$2.00
Other Countries in Postal Union, - One Year, \$3.00To Subscribers—Do not send money by ordinary mail.
Remit by Draft, Post-Office or Express Money Order,
or Register your letter.

FOREIGN SUBSCRIPTION AGENTS:

ENGLAND:—Iliffe & Sons, Limited, 3 St. Beide Street,
Ludgate Circus, London, E. C.FRANCE:—Boyveau & Chevillet, 22 Rue de la Banque,
Paris.

GERMANY:—A. Seydel, Mohrenstrasse 9, Berlin.

To Advertisers—Copy or changes in orders for advertisements should reach us not later than 5 o'clock p. m. Monday for the issue of Saturday following.

Copyright, 1904, by The Class Journal Company.
Entered at New York, N. Y., as second-class matter.

The Automobile is a consolidation of The Automobile (monthly) and the Motor Review (weekly).

Copies Printed This Issue, - - 12,000

" " Since Jan. 1, - 409,800

The Tour to St. Louis.

It seems not impossible that the tour just ended will go down into history as the only one of its kind in this country, at least for many years to come. The tourists were favored beyond all hope in the matter of weather, those running close to schedule being personally exposed to rain only once or twice, and even the night rainfalls being insufficient to cause bad going on more than two or three days. Nevertheless, even under such auspicious skies the hardships of the tour were considerable, especially for those whose cars were not in the best of order at the start, and which consequently needed repairs and patching along the route. Without doubt those who really enjoyed the tour were those with cars of sixteen horsepower and over, who felt under no compulsion to force their machines, and yet could travel fast enough to finish the day's runs in comfortable season.

Aside from the amount of work involved in making such a tour, it must be admitted that the amateur is seldom satisfied to be compelled to stick to a rigid schedule of days and distances. There were very many places where a few hours could have been spent delightfully, and scenes visited or acquaintances made; but everything of this sort had to be foregone if one was to "keep up with the bunch." The noticeable predominance of manufacturers' entries

from points east of Chicago was a natural result of the conditions of the tour.

Perhaps a few years from now a way will be contrived to organize a tour which will appeal throughout to the private owner. The advantages of such a tour as that just ended—and they are not to be despised—are its sociability and the certainty of a good route and of finding supplies and repair facilities. Conserve these, and eliminate the strenuousness, and the necessity for driving regardless of weather, and a tour will need no trade support to make it a success.

But meanwhile the automobiling world may well be gratified for the evidence this tour has so publicly given that American amateurs, driving American cars, can take their machines successfully through a thousand miles of country roads and "turn up smiling" at the end.

We may hope, too, that something has been learned from the roads, not merely that they are good or bad or indifferent, but about the reason for it—how far the bad roads of one community are blamable on poor administration or neglect, how far on ignorant construction, and how far on simple poverty and limited local use; and, *per contra*, what lessons may be learned from another community's success in keeping up its roads. In our correspondence on the tour we have endeavored to touch on these local conditions, most of which could readily be learned by observation and inquiry; and a brief acquaintance with them will aid in understanding many seemingly inexplicable cases of good roads in thinly settled districts and very bad roads in others apparently quite able to have better.



Lessons from the Tour.

Owing to the informal character and purpose of the St. Louis tour, it was out of the question to obtain complete records of road mishaps and repairs, and nothing of this sort was attempted. It seems probable, however that if such a record could be had it would indicate that the greater number of mishaps, small and great, would be found to belong to four classes: those comprising tire troubles, those to the running gear, those to crank and transmission shafts, and those to tanks and radiators. Motor troubles, including those with ignition and carbureter, appear to have been pretty well eliminated from the list of expected things.

The greater frequency of tire troubles in the latter half of the tour was doubtless due mainly to the fact that the tires were beginning to feel the effects of the wear and tear in the earlier half, when most of them were doubtless new. Running-gear troubles attacked chiefly the springs, but also the front axles, several of which were sprung, and the steering knuckles. It is probably true that those bent axles and steering knuckles would have passed unscathed through almost any ordinary usage;

but there is a good deal of wisdom in the principle followed by our European cousins, of making these parts strong enough to stand extraordinary usage as well. Even when one places the limit of his speed at that dictated by regard for personal comfort, there is always the chance of some hidden gully or bump in an otherwise good road which invites to speed. The I-beam is a better section for the front axle than the tube; and as for steering knuckles, they can hardly be too strong. A good feature here is the spring cushion used in many of the best machines in the link between the worm gear and the knuckle. With a gear only partly irreversible it is, of course, not necessary.

Regarding springs, it is probably true again that ordinary usage would have broken few, if any. Nevertheless, if we compare most American cars with the best makes abroad, we see that the former have springs of slightly less play and noticeably greater stiffness. Less attention, too, is paid to attaching clips to the ends of the leaves to prevent them from opening on the rebound. The spring problem is a difficult one, and is not yet wholly solved.

There can be no question that to drive with open throttle over a lumpy road is an important cause of broken shafts. The abrupt momentary checking of the vehicle's speed on striking an obstacle, in opposition to the fly wheel's constant inertia, throws severe stresses on shafts and gears. A spring coupling in the drive shaft would obviate much of this, but with most cars the proper thing to do is momentarily to unclutch when striking a rough spot. It is more than likely that at least one of the several crank and gear shaft mishaps in the tour might be traced to neglect of this precaution.

As to leaky tanks and radiators, it can only be said that they are often made or supported too rigidly, so that they spring leaks from the racking of the road. This is one of the minor details in which practice will one day make perfect. The number of such details still imperfectly worked out is notably less than even a year ago, and there are some cars on the market on which there seem to be almost none left.



If those automobilists who have a gentleman's sense of respect for the rights of other users of the highways and of their own responsibility as motorcar owners and drivers, really want to allay public ill-feeling toward automobilists in general and to maintain motoring in good repute, they can do so by going directly to the root of the evil. By far the majority of automobile accidents in and around New York and in other large cities are caused by irresponsible professional drivers who run the cars with absolute recklessness and in wilful violation of the law when the owner is not in the vehicle. Many of the worst accidents, resulting in serious if not fatal injuries

and in costly damage to the machines, occur when the chauffeur has taken the car out for a night ride with carousing acquaintances of both sexes, without the knowledge or consent of the owner to such use of the vehicle. It is an open question if the owner cannot be held responsible in such cases for the acts of the chauffeur as his agent. The remedy for the evil lies with the owner, who, after employing a driver recommended by the automobile club or the dealers' association, should give strict orders to the managers of the garage where he stores his car to refuse to allow the machine to leave the establishment except upon the owner's personal request either by telephone or note.



Novel uses for automobiles appear to be without end. The latest development is an automobile kitchen service which has been instituted at the Juvenile Asylum at Echo Hills, near Dobbs Ferry, N. Y., where the children are segregated in groups of twenty in separate buildings and the food, which is cooked in a central kitchen, is carried to the various homes in an automobile wagon fitted with an asbestos lined body.



ONE of these days some hot tempered automobilist is going to shoot a farmer or sheriff lacking visible evidence of office who holds him up at the live end of a revolver or shotgun. He will act upon the Western principle that when guns come into play the only safe thing to do is to shoot first. He will plead self-defense when the case comes to trial—and who will say that he will not be acquitted?



THE most interesting picture of the whole tour was the one that nobody took—the midnight turn-out at Pontiac to rescue the cars in the livery stable that burned.

STUDYING THE DUST PROBLEM.

The dust nuisance will be made a matter for investigation by a committee of the A. C. G. B. I., in so far as the problem relates to automobiles. Considering data on this subject was obtained from the 1,000-mile reliability trials last year, the most important point, probably, being the conclusion arrived at that the form of the under part of the car has a great deal to do with the raising of dust. It has been found that the car with the smoothest under side, higher from the ground at the rear than the front, will raise the least dust, and the new committee will make experiments based on this conclusion. Experiments will also be made with the intention of showing what influence the shape of the body has on dust raising, and manufacturers are invited by the club to co-operate in securing definite information. The experiments will cover the influence not only of the shape and position of the body, but also the size of tires, and size, shape and position of mud-guards.

RULES FOR GLIDDEN TOURING CUP CONTEST.

Competition for \$2,000 Trophy Must Be Run of 500 to 1,000 Miles Weekly in United States or Canada—Committee to Draft Conditions—Temple, Whipple and Scott Entered.

Special Correspondence.

ST. LOUIS, Aug. 13.—Suggestions for the rules that will govern the Glidden \$2,000 touring cup competition were discussed at an informal meeting of the officers of the American Automobile Association, at the Hotel Jefferson to-night, and the following were adopted:

First.—The Cup shall be known as the Charles J. Glidden Touring Cup.

Second.—The Cup shall be competed for annually, beginning with the year 1905, by members of the American Automobile Association or by any club in the world recognized by them. Each contestant shall have been a member at least one year.

Third.—The distance driven shall not be less than one thousand miles, nor less than five hundred miles weekly, and shall be over regularly used highways.

Fourth.—The car shall be driven by the owner, or a driver approved by the committee, the owner being a passenger in the car.

Fifth.—The contests for the year 1905, 1906 and 1907 shall be held in either the United States, Canada, or both.

Sixth.—The rules governing the contest shall be fixed by a committee of seven (7) consisting of the president of the American Automobile Association, who shall be chairman; the presidents of the Automobile Club of America, Great Britain and Ireland, France, Germany, and presidents of an automobile club of Canada, to be recognized by the American Automobile Association and the donor; or a representation selected by the above-named persons. The chairman and two members of the committee or their nominees shall constitute a quorum.

A committee consisting of President Harlan W. Whipple of the American Automobile Association, Augustus Post, chairman of the touring committee, and James L. Breese, a governor of the Automobile Club of America, was appointed to formulate the rules and regulations governing the contest for next year and submit the same to the general committee.

W. C. Temple, of Pittsburg, immediately made entry for next year's contest, depositing \$100 entrance fee. This was followed by entries from President Harlan W. Whipple of Boston, James L. Breese of New York, and R. P. Scott of Baltimore.

PROPOSED WILMINGTON ORDINANCE.

Special Correspondence.

WILMINGTON, Del., Aug. 13.—A proposed automobile ordinance is now pending before the Street and Sewer Department of this city and will in all probability become law at an early date. The terms of the ordinance call for the licensing of all drivers of automobiles and motorcycles. The license fee for the first year will be \$2, and subsequent annual renewal will cost \$1. Licenses may be refused or revoked, temporarily or permanently, if the applicant is considered unfit, for any reason, to drive an automobile. The usual numbering regulations are incorporated. The maximum speed limit is to be ten miles an hour, and automobiles and motorcycles must slow down to six miles an hour at crossings and on turning corners.

Each machine must be provided with two brakes or sets of brakes, either of which is capable of stopping the car within ten feet when running at a speed of ten miles an hour. One of the brakes must be independent of the driving gear. Two lights must be carried, one on each side, and numbers must be placed on the lamps so as to be plainly visible at night. Motorcycles must carry one light in front. Nothing is said in the ordinance about tail lights. Automobiles must not be left standing unattended with the engine running. The usual clause regarding slowing down and stopping for frightened horses are inserted. A fine of not less than \$5 or more than \$25 is to be imposed in case of failure to carry a license, or, in default of payment of fine, imprisonment, not more than thirty days in the workhouse.

SEPARATE IMPORTERS' SHOW.

Representatives of Foreign Cars Planning Withdrawal from Madison Square.

The dissatisfaction of importers of foreign automobiles with the arrangements made for their accommodation at the 1904 automobile show, in Madison Square Garden, has been no secret; and it has been almost as well known that, failing in their endeavor to be placed on the same footing with regard to the allotment of space as American exhibitors, some radical move would be made looking to the better exhibition of foreign machines. The climax was reached a short time ago, when the Importers' Automobile Company was organized and incorporated under the laws of the State of New York, with a capital of \$4,000, the incorporators being E. T. Birdsall, C. R. Mabley and E. B. Gallaher, all of New York City.

Work has been going on very quietly, but none the less effectively, and this week a meeting was called for Thursday evening, August 18, for the purpose of arriving at conclusions on a number of questions concerning an importers' show, which it is proposed to hold in the Herald Square hall, over R. H. Macy & Co.'s store, and to continue for two weeks.

Practically all the New York importers will be represented, and the exhibit is expected to be an exceptionally brilliant one. The rule barring out all but foreign cars will, it is intimated, be strictly enforced, as might be expected.

In addition to automobiles, space will be provided for an exhibition of motor boats of any nationality, and which will not be restricted to foreign products. The decorations throughout the hall are to be of uniform character, the individual exhibitors merely placing their exhibits and erecting such signs as will come within the restrictions as to size and position.

The promoters believe that, owing to the interest taken in foreign automobiles by the wealthy classes, the importers' show will be well attended, and, moreover, that those who attend will be mainly persons who, if interested, are able to buy and whom it is worth while to interest.

The importers state that they came to the determination to hold an independent show not on account of any feeling of animosity toward the management of the national show, but because they were unable in any other way to exhibit their machines properly. They could see no reason why foreign automobiles should not be permitted to stand on an equal footing, so far as space was concerned, with domestic machines; but, as this could not be arranged, nothing remained but to hold their own show.

THREE EIGHT-CYLINDER CARS.

Fast Cars and Prominent Officials for Cleveland Meet August 19 and 20.

Special Correspondence.

CLEVELAND, Aug. 13.—The Peerless Motor Car Company will complete a new racing machine for Barney Oldfield the first of next week, and if it works out satisfactorily Barney has promised that he will compete in the Cleveland races August 19 and 20.

The new car will have eight vertical cylinders, each 5 1-2 by 5 3-4 inches, and it is claimed it will develop twice the power of the present *Green Dragon*, which has four cylinders of about this size. Louis P. Mooers, who designed the machine, says he is satisfied that it will defeat anything on wheels.

Talk of a special series of races between Oldfield and Earl Kiser is waxing warmer every day and the race meet officials still have hopes of arranging the matter. Kiser has been trying out *Bullet III*, on Glenville track and has become thoroughly familiar with it. Another entrant in the Cleveland races who is after Oldfield's scalp is Henry Ford, with the Ford-Cooper 999, which has been repaired and is now said to be in better shape than ever, as its bearings and steering arrangement have been improved. With these two drivers handling cars which Oldfield made famous, and now operated by men who will strain every nerve to beat the self-styled champion, there ought to be a series of races in Cleveland the like of which have never been seen in the country. Others who will probably compete in the Cleveland races, having already entered, are H. W. Lyttle, of Toledo, with a new eight-cylinder Pope-Toledo, and Carl Fisher, of Indianapolis, with his eight-cylinder *Comet*. Ed. Harbaugh, of this city, has entered a new Pope-Toledo racer of uncertain speed, while H. N. Franklin will be here from Syracuse with two racers. It is confidently expected that some of the big Eastern cars will be entered later in the week, as the club has had inquiries from several of the best-known men. The fact that the Buffalo, Cleveland and Detroit races follow each other in the form of a circuit ought to attract the best drivers in the country.

So many prominent automobilists have never officiated at a race meet than have been secured by the Cleveland Automobile Club for the races. The list of officials for the two days is as follows:

Judges: Harlan W. Whipple, president A. A. A.; Augustus Post, chairman A. A. A. touring committee; W. C. Temple; E. Schriver Reese, president Cleveland A. C.; C. H. Gillette, secretary A. A. A.; Fred T. Sholes and A. Ward Foote.

Referee: A. R. Pardington, chairman A. A. A. racing board.

Timers: J. Henry Collister, David Post, of Hartford; "Governor" Fred Castle, of New York; Ned Broadwell, of Detroit; George L. Weiss, member A. A. A. racing board; P. L. C. Hussey, and Charles Weaver.

Clerk of Course: Clifford B. Haskins.

Starter: Fred J. Wagner.

Scorers: George S. Davis and "Pop" Skinkle.

Announcers: Ezra Kirk and Charles M. Hall, of Toledo.

ONE CENT PER HORSEPOWER MILE.

Special Correspondence.

CINCINNATI, Aug. 13.—Automobilists of Cincinnati and the cities of Covington and Newport, Ky., just across the Ohio River, are aroused over an attempt by the owners of the Alexandria Pike to drive all auto-

mobiles from that roadway by charging their owners an exorbitant rate of toll. This pike, which runs from Newport through the Kentucky Highlands past Fort Thomas to Alexandria, Ky., is one of the most picturesque in this region and, as it is also one of the best maintained, it has been a favorite with automobilists.

Now, however, a toll rate of 1 cent per mile for every horsepower of automobiles traversing the pike has been established. Members of the Cincinnati Automobile Club have quietly looked up the charter of the Pike company and claim that this charter does not give the company the right to charge any toll whatever for automobiles, providing, they claim, only for toll for horse-drawn vehicles and traction engines.

Therefore a test case is to be brought up in the Kentucky courts in an effort to determine the rights of automobile owners. It has not yet been determined whether the question shall be raised by some automobilist refusing to pay toll, or by paying and then demanding a receipt upon which a suit to recover can be based.

WINNIPEG RACE MEET.

First Automobile Contests in Western Canada Create Appetite for More.

Special Correspondence.

WINNIPEG, Manitoba, Aug. 8.—During the Dominion of Canada Exhibition, which was held here from July 25 to August 6, the first automobile racing that has ever been held in Western Canada took place on the racing track, and considering the fact that the track is practically unbanked some very good performances were made.

The first day, August 2, two heats of a two-mile event, open to cars not exceeding 12-horsepower, were run. W. C. Power (Autocar), T. Boswell (Ford), and R. McLeod (Cadillac) started in the first heat. Power quickly obtained the lead and won by over 100 yards in 4:15, Boswell beating McLeod for second place by a few yards.

In the second heat J. K. McCulloch (Ford) had no difficulty in winning from C. M. Rickutts (Stevens-Duryea) in 3:50.

Thursday evening, August 4, McCulloch drove a stock Ford touring car five miles in 8:20, losing about five seconds on every lap by skidding on the loose surface of the unbanked turns.

There was an interesting brush in a two-mile race Friday evening between George Erzinger (Ford) and W. C. Power (Autocar) for second place, which created tremendous excitement among the 5,000 spectators in the grandstand. Both contestants entered the home stretch on practically even terms and got all there was out of their cars, Erzinger finishing less than a foot ahead of his antagonist. The race was won, however, by McCulloch (Ford) by fifteen seconds, in 3:26.

Although the racing was confined to ordinary touring cars, it was sufficiently interesting to create a desire for further automobile speed events, and an effort will be made to arrange a regular afternoon program during the fall, in which it is hoped that drivers from other parts of Canada will take part. The racing has also had a good effect on the sale of cars, several having been disposed of in consequence of the good impression created by the performance of the cars taking part.

There are 207 automobiles registered in Louisville, Ky., an increase of nearly 200 as compared with the number in use two years ago.

TESTING A MILITARY CAR.

Touring Car Equipped for Signal Corps Work Starts for Coast Military Camp.

Special Correspondence.

SAN FRANCISCO, Aug. 10.—Colonel Parker W. West, aide-de-camp to General Arthur McArthur, commanding the Department of California, and chief signal officer, started for the military camp at Atascadero in the special automobile built by the Winton Motor Carriage Company especially for maneuvers of the United States troops at Atascadero. They were accompanied by Captain C. L. Lyman, U. S. A., retired; five men and S. D. Henson, chauffeur.

It was a three days' run through San Jose and Paso Robles. Supplies for the signal corps, in addition to those carried on the automobile, such as crowbars, post-hole diggers and folding telegraph tables, were sent down by train.

The experimental work with the automobiles and the instruments is expected to be a highly interesting part of the maneuvers.

The car is the first of the kind specially built for military use in the United States. It will be subjected to searching tests to determine its value in military operations, being employed by the Signal Corps for rapid transportation, to make repairs and as a traveling telegraph office. The commanding general will travel in it from place to place, inspecting the troops, and will be able to connect with military telegraph lines.

The vehicle is a 20-horsepower touring car of 1904 model. It is capable of carrying eight men, two in front and six in the tonneau sitting *vis-a-vis*. In the tonneau is a folding table for the telegraph apparatus and in each side of the car are racks for flags, rockets and various appliances used by the Signal Corps. Among other paraphernalia are hatchets, a post-hole digger, climbing irons and straps, brackets, insulators and a coil of wire.

If the car proves serviceable the military authorities will adopt the type and have several others built.

PROGRAM OF DENVER MEET.

Special Correspondence.

DENVER, Aug. 12.—The Colorado Automobile Club has completed all arrangements for its race meet to be held at Overland Park on August 27. Entries will close at noon August 23 at the office of Secretary W. H. Bergtold, 624 Fourteenth street. The events are scheduled to start at 2 o'clock p. m. with a parade around the race track of all the automobiles in attendance. The program as arranged follows:

Five-mile non-professional, for stock gasoline cars, American make, not exceeding 10 horsepower; five-mile non-professional, stock American gasoline cars, not exceeding 16 horsepower; five-mile non-professional, stock American cars, steam or gasoline, not exceeding 24 horsepower; five-mile non-professional, stock steam cars, not exceeding 10 horsepower; special five-mile touring car race, full adult load, touring equipment, each contestant required to come to full stop directly in front of flag at grandstand once during the race and start again without stopping engine; special challenge five-mile, George Herring in Stanley *Comet*, open; five-mile semi-professional, gasoline cars, not exceeding 10 horsepower, stripped; cowboys vs. automobile, ten-mile, cowboys relay each mile; five-mile, non-professional, gasoline or steam cars not exceeding 20 horsepower; two-mile stock car, for ladies; five-mile, semi-professional, open to any car; motorcycle race, distance not named.

THE AUTOMOBILE

WEEKLY

NEW YORK—SATURDAY, AUGUST 27, 1904—CHICAGO

10 CENTS

G. A. R. VETERANS CATCH THE FEVER.

Special Correspondence.

BOSTON, Mass., Aug. 18.—The automobile trip to Lexington and Concord, which was given the delegates to the National Encampment of the Grand Army this afternoon, was, for the comparative few who were able to go upon it, the most novel event in the whole encampment week. If the entertainment committee had arranged an air-ship ride or a sub-marine

excursion the old soldiers would not have been more amazed than they were at the speed of the 250 cars that took them over the route of Paul Revere. But in one respect the trip was quite different from what had been planned by the committee in charge. Their plan was to have an orderly parade of automobiles, moving in two separate sections at a rate of about ten miles

an hour. They thought that the principal interest of the veterans would be in seeing where this or that group of Minute Men fired on the British, or where such and such famous English general made his headquarters. But in this they had misunderstood the spirit of the veterans, for before the machines had struck the historic part of the route, the old soldiers were



SOLDIERS OF THE GRAND ARMY STARTING FROM BOSTON FOR AUTOMOBILE RIDE OVER THE HISTORIC PAUL REVERE ROUTE.

so imbued with the automobile fever that all they wanted was speed. And in this the 250 drivers were suited exactly. They had come to the gathering of automobiles in the vicinity of Symphony Hall with their spirits properly toned down for the occasion, with their machines fixed to accommodate as many passengers as possible, and with their minds made up to follow a slow pace, to take what dust they must, to make as little as possible, and to act as guides so far as lay in their memories. But all these good resolutions were dashed to the winds before two miles of the course had been covered and from then on to Concord and back it was a road race such as has not been seen in the neighborhood of Boston in many a day. The police were on the back streets in all the towns to allow the veterans freedom of the towns, and there was scorching along Massachusetts avenue, which, ordinarily, would have resulted in bringing into the courts fees enough to make it worth while to raise the judge's salary.

Of course, everybody did not scorch, and those who did were urged on by their passengers. The old soldiers simply went speed crazy and they wouldn't let anybody pass them if they could help it. When the conscientious chauffeurs would stop to point out some place of particular historic interest with which they were familiar, the veterans got on the anxious seat at once and wanted to know what was the matter. They didn't care much for patriots or British; all they wanted was to keep ahead of the other fellows. There is no doubt that they had the time of their lives and that many of them are now converts to the automobile. The speed naturally raised a great cloud of dust all along the road and when they returned to Boston it was hard to tell whether the veterans wore the blue or the grey. None of them had goggles, but that didn't matter to them.

The tour was started between 1.30 and 2 o'clock this afternoon at Symphony Hall, where the National Encampment held its sessions. The automobiles began to arrive by noon and took their positions in line. As each machine drew up, its driver was given a handsome silk flag with which to decorate his machine and a card upon which he was directed to write his name and the names of his passengers. These cards were for the purpose of keeping a list of those who participated in the trip. When the driver had been checked he was directed to join either division A or division B. Division A formed on Huntington Avenue with President Elliott C. Lee, of the Massachusetts Automobile Club, at its head, and division B formed on St. Stephens Street with Leonard D. Ahl as leader. President Lee drove his White steamer and Mr. Ahl his Rochet-Schneider. In a very short time Hunting and Massachusetts avenues, Gainsboro, St. Stephens and St. Botolph streets, Westlund Avenue and other thoroughfares in the vicinity were filled with



VETERANS ENJOYING A FAST RUN ON THE ROAD FROM BOSTON TO CONCORD.

automobiles of every description, from the imported thoroughbreds to the unostentatious delivery van. In some cases attempts had been made to decorate the cars in addition to the flags furnished by the committee, and some very pretty effects were secured. One car was attractively decorated all over with bunting, and others were prettily decorated with flowers and colored paper. Most of the drivers were men who manipulated their own cars, but in at least three cases machines were guided by women.

An attempt was made to keep the machines in divisions according to power and motive power. Thus, the high-powered touring cars were placed on one street, the lower-powered touring cars on another, the gasoline runabouts on another and the steamers in still another group. By 1 o'clock, the announced hour of the start, 250 machines were ready. Then it was announced that the encampment session had decided not to adjourn until 3 o'clock, and it looked as if the parade would be spoiled. The owners of the machines said that they could not wait and take chances of having to make the return trip in the evening. The committee in charge then passed around the word quietly that the parade would start at 1.30 o'clock whether the encampment adjourned or not. This had the desired effect, and a great many of the delegates left the convention hall. The national officers, including the commander-in-chief, General Black, and the commander-in-chief-elect, General Blackmar, could not leave, and so did not go on the parade. There were enough delegates to more than fill all machines available, however, and the cars in waiting were quickly occupied. The committee had hoped to have 500 cars for the veterans, so as to take everybody who wanted to ride, and 350 had promised but 100 failed to appear at the appointed hour.

No word to start was given, but somebody who thought he had waited long enough, set his machine in motion at about

1.30 p. m. Then, like a great flock of sheep, the others followed, and in the course of a few minutes Massachusetts avenue was filled with automobiles, and the tooting of horns and screeching of steam whistles, mingled with the clang of gongs, made a confusion indescribable. The original plan was for division A to proceed through Cambridge, Arlington and Lexington over the Paul Revere route to Concord, and division B to go through Newton and Waltham, each division to return by the opposite route from that on which it went out. But when the cars started, each driver took his choice of routes, and the great majority preferred to follow the direct route through Cambridge. For this reason there was a long string of machines moving over Harvard bridge and through Cambridge. Until Harvard Square was reached comparative order was kept, and the announced stop was made at the Washington elm. From there on the operators let out their cars and the run to Arlington was made in short time. There another stop was made while the local G. A. R. members presented the excursionists with a book telling of the historic points of the town; but the veterans were not studying history, they were automobiling, and the dash from Arlington to Lexington suited them first rate.

At Lexington Common most of the old soldiers of '61 felt in duty bound to inspect the site of the first battle of the Revolution, and got down from their cars. But the inspection was made as brief as possible and in a few minutes every car had its passengers again, and the trip to Concord was begun. This was another speed trial and the cars arrived in Concord in a little more than an hour after they left Boston. Here the small party that had come out through Newton joined the larger one and together they moved to Concord Square, and to the old Bridge, the site of the famous Concord fight. The local Grand Army men were there to receive them, and while the veterans were looking over

the town the chauffeurs took time to put their machines in order for the return trip. Many of the cars had suffered from the journey, the tires being unable to stand the speed with the large loads. Tire troubles were frequent and in some cases there were mechanical troubles. In general, however, the machines stood the test well.

The return to Boston was made by the main party through Newton, and in coming back the veterans were as anxious for speed as they had been going out. The long line of cars dashed over the fine macadamized roads at a pace that shocked any park policemen who were on watch. The cars arrived in Boston between 5 and 6.30 p. m. and left the veterans at the Hotel Vendome, which is the National headquarters. The veterans had had a good time, and were only sorry that there was no moonlight ride after supper. All along the route of the trip the residents had decorated their homes in honor of the veterans, and at a number of places where stops were planned large numbers of persons had gathered, but the veterans, while acknowledging the compliment, were too busy with their riding to pay much attention.

The committee which had charge of the automobile trip, and to which the credit for its success is due, consisted of Charles H. Baker, chairman; Joseph B. Maccabe, sec-

Flanged Wheels for Rail Tour

Special Correspondence.

St. LOUIS, Aug. 20.—In continuing his journey by automobile westward to the Pacific on his globe-encircling tour, Charles J. Glidden will use the railroad tracks for a highway. For this purpose he received from London last Tuesday a set of wood wheels with the regular steel flanged tires. The now famous Napier car in which he is making his tour is at the Transportation building in the World's Fair, and here the ordinary set of wheels were removed by his engineer, Charles Thomas, of London, who will go along on the entire tour. The wheels are stoutly made, of ash, and closely resemble the ordinary automobile wheels except for the rims.

This is understood to be the first occasion on which a regular road touring car has been fitted with flanged wheels for railroad travel. Probably owing to this fact and the consequent want of experience on the part of the builders, the flanges on

distance to be run on the tracks is about 2,000 miles on the route taken from Minneapolis to Vancouver.

According to the proposed schedule, an average speed of about thirty miles an hour will be maintained on the route. Larger sprockets will be fitted to the car than those used for road work, and the engine will be run on the high speed.

Mr. Glidden has sent ahead about four barrels of gasoline, which has been distributed in twenty-gallon lots at intervals along the line. An additional twenty-gallon can will be carried in the car.

Before the start is made, special forgings will be fitted to the steering gear to keep the wheels pointing rigidly ahead and only the control of the car will occupy the driver's attention, no steering being necessary.

The four steel-shod wheels weigh about 1,000 pounds. The felloes are made in halves and the steel tires are fastened to them with countersunk screws from the outside. At the joints in the felloes hexagon

head set screws are put through from the inside into the rim.

In a brief preliminary trial on the tracks outside of the Transportation Building at the Fair the car seemed to require little power to move it at a moderate speed, and as

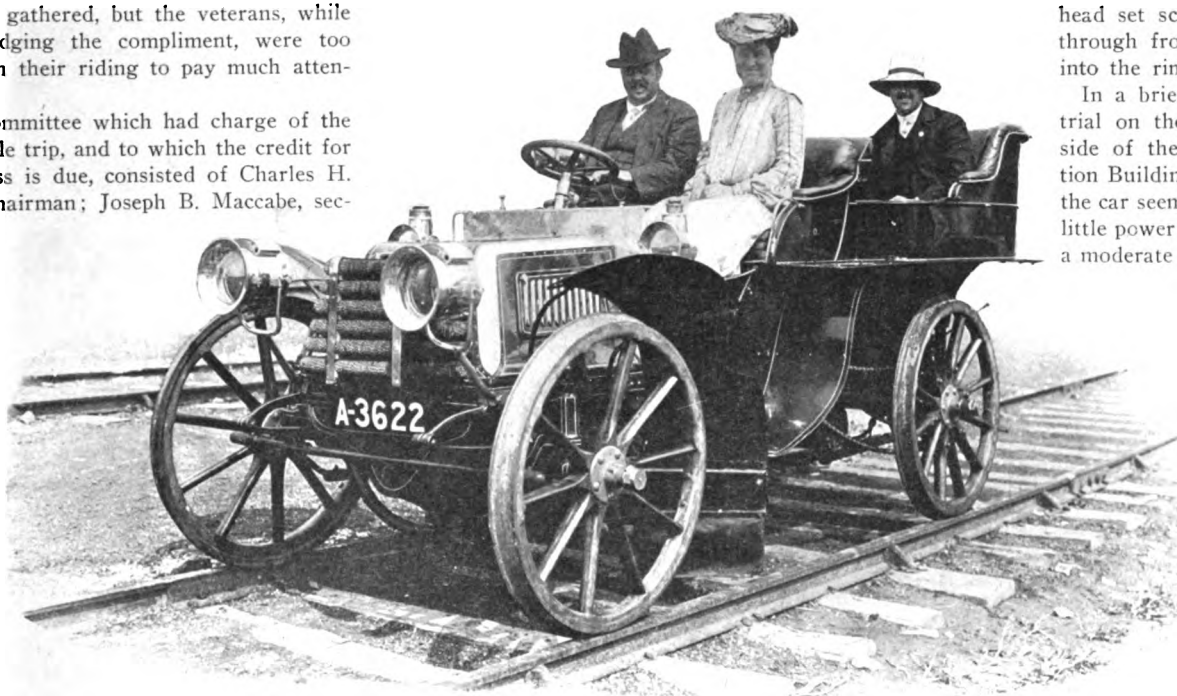

MR. AND MRS. GLIDDEN IN AUTOMOBILE FITTED WITH STEEL-FLANGED WHEELS FOR RUNNING ON STANDARD RAILROADS.

retary; Elliott C. Lee, president of the Massachusetts Automobile Club, and Leonard D. Ahl. While most of the machines were provided by private owners, the Boston agents did all they could to furnish transportation.

Commodore W. R. Huntington, of Elyria, ran into a carriage driven by Vice-Mayor Herbert. The commodore's arrest followed, and Herbert ordered a policeman to escort Huntington to the police station, where he was released on his own recognizance. Meanwhile, Governor Herrick, who had been invited to go to Cedar Point on Mr. Huntington's private yacht, *Thelma*, was compelled to wait until the commodore was released from custody.

the wheels are not correctly shaped and the width of face of the wheels is insufficient to keep the track in passing over switches. A new set of rims will therefore be fitted in some workshop here, and when ready the car will be sent to Minneapolis, where the novel rail journey will commence.

Over the tracks of the Canadian Pacific Mr. and Mrs. Glidden and Engineer Thomas will drive to Vancouver, passing through the scenic magnificence of the Selkirk range in the Canadian Rockies on the way. The car will travel as the second section of a regular passenger train and will be in charge of a railway conductor, who will receive the dispatcher's orders that will control the movements of the car. The

railroad grades seldom exceed 4 per cent., the route will be practically flat and doubtless high speed will be attained on the long straight stretches.

Mr. Glidden expects to resume his journey westward from Minneapolis some time next week.

Dr. W. H. Rand, while making a call with his automobile yesterday, ran into a telephone pole and broke the pole entirely off and never damaged his machine aside from the dashboard. The doctor proved himself the equal to the average circus performer by "looping the gap" and landing on his stomach some distance ahead.—Charlotte (Mich.) correspondence in *Detroit Journal*.

New World's Record for the Track Mile.

Earl Kiser, in *Bullet No. 2*, Lowers the Figures to 52 4-5 at the Glenville Track Meet in Cleveland August 22.

Special Correspondence.

CLEVELAND, Aug. 22.—With a burst of speed that put its circulating pump out of action, the *Winton Bullet No. 2*, steered by Earl Kiser, clipped two full seconds from the world's record of 54 4-5 seconds and established beyond question that it has been the car and not the driver that has been responsible for the long series of victories and records that have gone to the credit of the *Bullet*-Oldfield star combination. And by twice lowering the mile record and easily vanquishing competitors, Earl Kiser, who, speaking comparatively, is a novice at the game, has proven himself to be the peer of any driver on the American track.

The track this afternoon looked anything but a record-breaking course after the rains of last week, as the famous yellow clay surface had been harrowed before it was dry, leaving it in furrows almost an inch in depth. Numerous cars had been sent around the track before the races to smooth it off, and most of them followed a course on the outside of the track. The whole surface was improved somewhat after several races had been run, but it was on this outside course that Kiser and the famous old *Bullet* twice eclipsed all previous mile records.

The first event was a 100-yard obstacle race. Miss Oriana Stevens, a pretty little miss who had been drilled at the game by Walter Baker, of the Baker Motor Vehicle Company, proved even more expert than her instructor, who is a past master at the game of spinning his little runabout around between a lot of barrels. Miss Stevens won in 49 2-5, with Walter Baker second and E. Shriver Reese, with a Locomobile steamer, third.

There were but three entries in the two-mile race for stock runabouts. George Russell with a Cadillac was practically the whole show, as he won by a quarter of a mile from R. Winchester, of Syracuse, with a Franklin and Walter Baker with his bevel-gear *Baker* runabout, which is equipped with the famous Edison battery. Some one protested Russell because his car had no cover, leaving the mechanism unenclosed, but the officials decided it was a stock car all right, and gave him the prize. Time for two miles, 3:47.

Herbert Lyttle, of Toledo, with the big eight-cylinder *Pope-Toledo*, won the five-mile race for the Diamond Cup in one of the most exciting races ever seen on a track. That one event was worth the price of the admission, and while Lyttle got the cup, Earl Kiser with the *Bullet* was the recipient of a round of applause that drowned the racket of the gatling gun racing cars. Three times the officials tried

to get the men off on a flying start, and then they tried the standing start plan, but each time one or two machines failed to start properly. Finally they decided to get them off and let every man take his chances, and a murmur of disapprobation went up when it was seen that Earl Kiser was stalled while the others were off in good shape. Kiser's assistants started to pull the car off from the track, when Earl waved them away, jumped out and started his engine, and went after the flying field, the leaders of which were nearly five-eighths of a mile to the good before Kiser started. For three miles the *Bullet* tore around the



EARL KISER AT THE WHEEL OF BULLET NO. 2, ON GLENVILLE TRACK.

track before it overhauled the first machine, the *Bullet No. 3*, with Charles Gorndt aboard. For two miles the yellow *Premier Comet*, driven by Carl Fisher, had been giving Lyttle with the big *Pope-Toledo* a hard fight. The low lean yellow machine lost breath on the third mile and at 3 1-2 miles Kiser overhauled it. For another mile the *Bullet* tore after the *Pope-Toledo*, gradually cutting down its lead. On the back stretch and lower turn the big red car seemed to take wings, and on the home stretch it was overhauling its competitor like a greyhound after a hare. Two hundred yards from the tape Kiser swerved to go around the *Pope-Toledo*, and crossing the tape they were nose and nose, with the *Pope-Toledo's* nose a shade the longer. Ten yards past the tape the *Bullet* shot to the front, but the spurt had been made too late to win the cup; not too late, however, to clip four-fifths of a second from the world's record of 54 4-5. The applause after this announcement must have been worth the value of the cup to Kiser, for it denoted an appreciation of the fact that with a fair start the little Daytonian would have been an easy winner. Lyttle made a great

ride, but his car seemed to be going badly towards the last, and his time on the last mile was nearly four seconds slower than the others. His times were as follows: 1 mile, 1:00; 2 miles, 2:16; 3 miles, 3:13; 4 miles, 4:18; 5 miles, 5:24.

In the two-mile open for motorcycles, L. E. Manley, with a *Rambler*, came down the stretch looking like an eagle on a pair of wheels, while the other fellows were still on the back stretch. His first mile was 1:38 2-5 and the second 3:13 2-5. H. E. Chubeck, of Toledo, with a *Yale*, was second, and A. B. Koffman, Toledo, with a *Yale*, third.

Kiser was scratch in a field of seven in the five-mile handicap race. J. Soules, with a four-cylinder *Pope-Toledo*, stripped, proved a dark horse in this race. Starting from the three-quarter mark, he was never headed, although Carl Fisher, with the *Comet*, from the quarter, gave him a hard run and finished second, with Charles

Gorndt, with the *Bullet*, from the three-eighths mark, third. Kiser overhauled Winchester, with the *Franklin*, Magoon, with a *Pope-Toledo*, and A. E. Morrison, with a *Peerless*, but he did not have time to overhaul the limit men. The winner's time was 4:53, which is remarkable for a stock touring car not designed for racing.

In the five-mile open for stock touring cars, Soules, with the four-cylinder *Pope-Toledo*, again had everything his own way and won by the length of the stretch. A. E. Morrison, of Boston, with a *Peerless* four-cylinder, was second, and E. Messerly, with a *Royal*, third. Time, 5:51 2-5.

The eighth and last race of the day was a novelty—a three-cornered race between three eight-cylinder cars, said to be the first event of the kind ever held. Kiser, with the *Bullet No. 2*, Lyttle, with the big *Pope-Toledo*, and Fisher, with the yellow *Comet*, tossed for position and Fisher won, taking the pole. With flying start, the *Pope-Toledo* gave the *Bullet* a good race for a mile, and then fell behind. The *Comet* made a spurt on a third mile and seemed likely to win second place, but it began to heat up and miss fire, and on

the fourth mile the *Bullet* lapped it. Half a mile further Kiser passed the Pope-Toledo

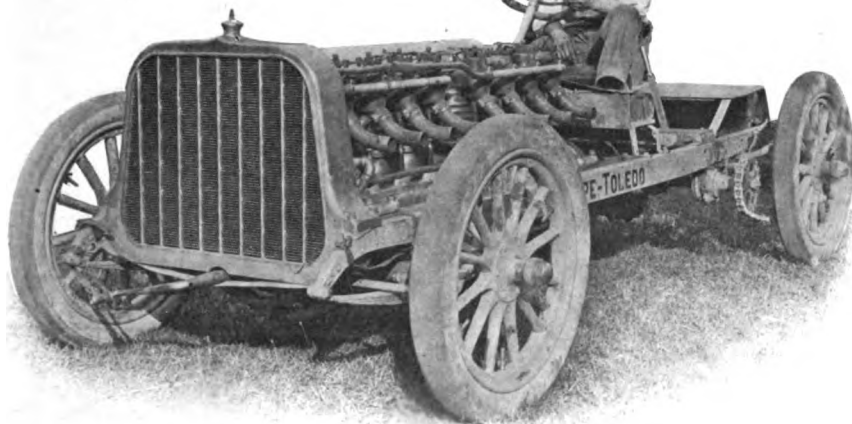

HERBERT LYTTLE IN THE NEW 8-CYLINDER POPE-TOLEDO RACER.

1.00 4-5; 2 miles, 1.58 1-5; 3 miles, 2.55; 4 miles, 3.58 1-5; 5 miles, 4.51.

The meet established the fact that the Cleveland public is intensely interested in automobile racing. The opening races of the meet were scheduled for last Friday, but the weather man had not been consulted and the downpour which occurred in the morning made the track a better place for auto boat races than for automobiles. All Friday night and Saturday morning it rained, and finally the enthusiasts from out of town sitting around the tables at the club rooms in the Hollenden bethought themselves of the fact that Ned Broadwell, from Detroit, bears the reputation of being a rain maker. The race management tried to hire Broadwell to leave town, but he had come to see the races and refused, so the rain continued. Saturday afternoon it looked as though some events might be pulled off, and many people went out to the big oval at Glenville, which was in such

and won by more than a lap. It was noticed that on the last lap the *Bullet* seemed fairly to jump away from the Pope-Toledo, but not a person in the audience was prepared for the announcement that the last mile had broken the world's record in splinters, placing it at 52 4-5, a point where it is likely to remain for some time.

Every one was incredulous, for the big machine seemed to be going faster in the previous races, when it was overhauling other cars. However, there was no doubt as to the authenticity of the time, as all of the timers agreed, and they included such veterans at the game as J. H. Collister, Wm. A. Skinkle, Pat Hussey, Ned Broadwell and Charles Weaver. Alexander Winton and others from the track caught the same figures, and when the announcement of the new world's record was finally impressed upon the audience, the crowd swarmed over the fence and fairly carried Kiser from the track. In its supreme ef-

fort the *Bullet* had damaged its circulating pump, and the last event, a five-mile record

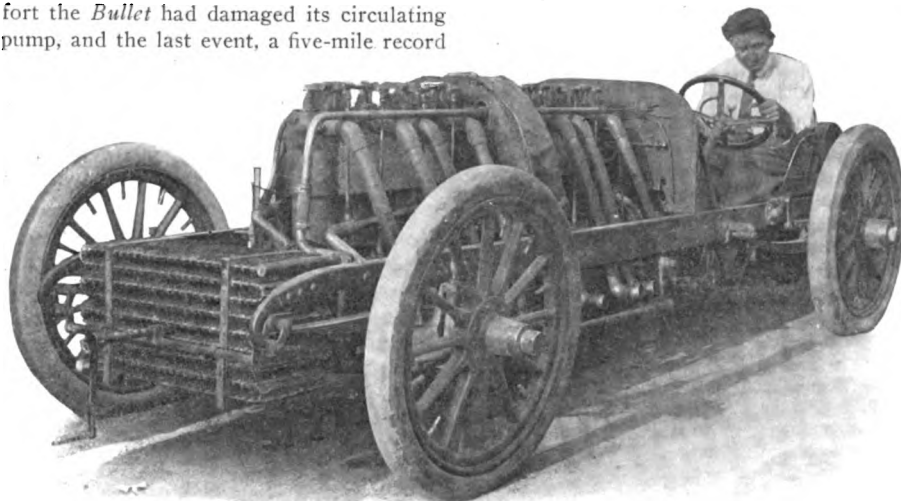

BARNEY OLDFIELD DRIVING THE PEERLESS 8-CYLINDER RACING CAR.

trial by Kiser, had to be called off.

Kiser's time by miles follows: 1 mile.

condition that the races had to be postponed again. Sunday there was more rain, and Monday morning was ushered in with threatening weather which sent cold shivers down the backs of the meet promoters. All the morning it was a ten to one shot that there would be another downpour in the afternoon, but for all that, some 5,000 enthusiasts took their rain coats and umbrellas and went out to see what proved to be the most exciting and one of the most successful day's races ever held in this country.

Not an accident marred the afternoon, and the only disappointing feature was the fact that Barney Oldfield, after spending nearly a week trying out the new eight-cylinder Peerless *Green Dragon*, did not compete. Saturday, Barney packed up his belongings and went to Omaha to compete in races scheduled for Tuesday. The new Peerless showed some very fast work in practice, and Oldfield had plenty of backers against Kiser, but on the other hand, there are those who were unkind enough to say that Barney decided not to remain because he did not fancy the prizes offered for seconds.

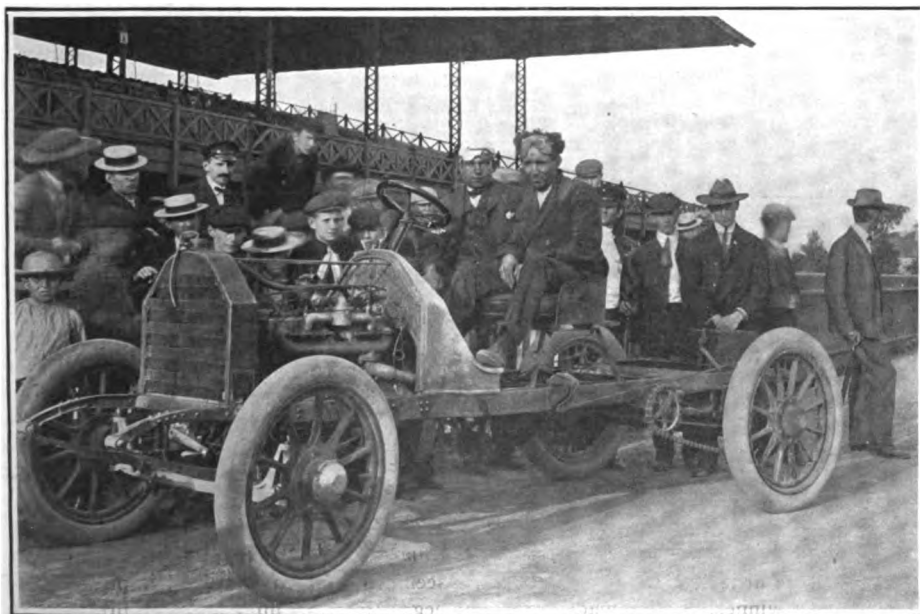

FRANK STEARNS IN THE NEW VERTICAL CYLINDER STEARNS CAR.

Unexpected Events Tuesday.

Special Correspondence.

CLEVELAND, Aug. 23.—At the start of the second day's races of the Cleveland meet *Bullet No. 2* caught fire, from the flooding of the carbureter, from which the gasoline dripped down onto the hot muffler and ignited. Three trials to start the machine were made, but each time the flames broke out anew. The last time the car went about an eighth of a mile when it was seen to be fairly enveloped in flames. Kiser ran the car to the side of the track and jumped out. Alexander Winton, who was seated in the judge's stand, called to one of his men: "Tell them to pull the muffler off and throw sand on it." This put out the flames, but the mechanism of the car was so clogged with sand that it could not compete in the first event, and did not run well during the other events. Kiser tried for the five-mile record of 4:44, but the best he could do was 4:48 2-5, his fastest mile being :57 2-5. Alexander Winton tried to get more speed out of the old machine, and pleased the audience by giving an interesting exhibition, but his time was slower than Kiser's—4:55 2-5, the fastest mile being :58 2-5. In the ten-mile open the *Bullet* balked for about six miles and then finished in fine shape, negotiating the last mile in :56 3-5, the fastest mile of the day.

In the third mile of the ten-mile open the Premier *Comet*, which had passed *Bullet 2* and was overhauling *Bullet 3*, which was in the lead, seemed to leap into the air on the upper turn of the back stretch, then wobble along on three wheels and dashed into the outer fence. Kiser passed the wreck in safety and after the dust had risen Carl Fischer was seen to pick himself up from the ruined car and wave his hand to indicate that he was all right. The accident was caused by buckling of the outside rear wheel as it made the turn. The nose of the car had crashed through the tight board fence and the frame and wheels were wrenched to pieces. The accident came at an untimely moment, for the *Comet* was making a marvelous burst of speed and looked good for second, if not first, place against cars that had previously out-classed her.

In the event for loaded touring cars, Frank Stearns, with his new four-cylinder car, was looked upon as a likely winner, but his clutch slipped and he trailed through the race. In the five-mile race for stripped touring cars, Soules, with the Pope-Toledo, should have been an easy winner considering his work yesterday, but he broke a pump connection and fell out on the second mile. The big eight-cylinder Pope-Toledo would have figured in the ten-mile open but a broken bearing prevented it from starting and retired it for the day.

The attendance was much larger than yesterday, and as the weather was fine, the track side was lined with an array of cars never before equalled in this city.

The summaries follow:

Five-mile for touring cars, road equipment.—R. H. Magoon, Cleveland (Pope-Toledo), first; A. E. Morrison, Boston (Peerless), second; Paul Gaeth, Cleveland (Gaeth), third. Time, 7:04 2-5.

Five-mile motorcycle handicap.—A. Adams, Cleveland (Rambler), scratch, first; J. Sabo, Cleveland (Indian), 30 seconds, second; H. E. Chubbeck, Toledo (Yale), third. Time, 8:05.

One-mile heats, best two in three.—First heat, H. H. Lyttle, Toledo (Pope-Toledo), first; Charles Gorndt, Cleveland (Winton), second; W. F. Winchester, Syracuse (Franklin), third. Time, 1:10. Second heat, H. H. Lyttle, first; A. Soules, Cleveland (Pope-Toledo), second; Charles Gorndt, third. Time, 1:11 4-5.

Five-mile for touring cars stripped.—F. B. Stearns, Cleveland (Stearns), first; E. Messerley, Cleveland (Royal), second; R. H. Magoon, third. Time, 6:19.

Ten-mile open.—Earl Kiser, Dayton (Winton), first; Charles Gorndt, second; W. F. Winchester, third. Time, 10:05 2-5.

Five-mile time trial by Kiser, 4:48 2-5. By miles—57 1-2; 1:55 1-5; 2:03; 3:51; 4:48 2-5.

Ten-mile handicap.—J. Messerley (2 1-2 min.), first; A. Soules (3-4 min.), second; Charles Gorndt (3-8 min.), third. Time, 10:26 3-5.

Five-mile time trial by Alexander Winton (*Winton Bulletin No. 2*).—Time, 4:55 2-5. By miles—58 2-5; 1:57 4-5; 2:57; 3:56; 4:55 2-5.

MINNEAPOLIS RACES.

The Northwest Sees Mile-a-Minute Track Driving for First Time.

Special Correspondence.

MINNEAPOLIS, Aug. 20.—Minneapolis held her first real automobile meet yesterday at the State Fair tracks at Hamline, where a dozen interesting events were run off under the auspices of the Minneapolis Automobile Club. The meet was well attended, and while the program was not run off so promptly as many could wish, the contests were interesting and the club officials gained useful experience. It is possible that another meet will be held this fall, as many are anxious to see more fast sport before the season closes.

The best time for a mile was made by A. C. Webb, in a Pope-Toledo, who circled the mile course in 59 1-2 seconds, the best time ever made in this part of the country. It occurred in the last mile of the five-mile dash. Opposed to Webb was W. H. Winchester, in a 10-horsepower Franklin, stripped. Webb's time for the five miles was 5:07.

Another event which was highly entertaining to the large crowd was a ten-mile race for touring cars in which there were a dozen starters. A Pope-Toledo again scored a victory, H. E. Pence driving a 24-horsepower car of that make over the finish line first in 14:44 1-2. A feature of this race was the appearance of the only woman to participate in the day's events, Miss Macie Cecil, of the Ferris Stock Company, now playing at a theatre in the city, pluckily riding the ten miles with three others in the machine. She was completely covered with dust and dirt thrown up by the big machines when the race ended.

Following is a summary of the results of the day's events:

Minneapolis Automobile Derby, five miles, 40-horsepower or less.—J. H. Queal's Pope-Toledo, first; M. P. Rothschild's Mercedes, second. Time, 7:09.

One-mile dash, flying start, 9-horsepower

or less.—W. G. Benz' Ford, only starter. Time, 1:44 1-2.

Two-mile dash, flying start, 12-horsepower or less.—E. H. Moulton's Franklin, first; F. Joswich's Franklin, second. Time, 3:33 1-4.

Two-mile dash, flying start, 16 horsepower or less.—Thomas' Rambler, first; Clark's Rambler, second.

Five-mile dash, 90-horsepower or less.—A. C. Webb, Pope-Toledo, first; W. H. Winchester, Franklin, second. Time, 5:07.

One-mile challenge race, St. Paul vs. Minneapolis, 40-horsepower or less.—A. C. Webb's Pope-Toledo, first; R. Bagley's Packard, second. Both Minneapolis machines. Time, 1:28.

Three-mile dash, 20-horsepower or less.—R. Bagley's Packard, first; Anderson, Winston & Walker, second. Time, 4:25 1-2.

Ten-mile race, touring cars of 30-horsepower or less.—H. E. Pence, Pope-Toledo, first; Bergstrom, Peerless, second; Dick Ferris' Pope-Toledo, third; Ace Precoust, Winston & Walker, fourth. Time, 14:44 1-2.

Two-mile dash, 90-horsepower or less.—A. C. Webb, in Pope-Toledo, first; W. H. Winchester, in Franklin, second. Time, 2:03 1-4.

Three-mile dash, 24-horsepower or less.—Anderson, in Winston & Walker, first; E. W. Young, Ford, second. Time, 4:19.

Exhibition mile.—A. C. Webb, Pope-Toledo. Time, 1:01.

Two-mile race for motorcycles.—E. J. McCollum, St. Paul, first; F. E. Hopkins, St. Paul, second. Time, 3:31 1-2.

GLIDDEN ARRIVES AT MILWAUKEE.

Special Correspondence.

MILWAUKEE, Wis., Aug. 22.—Charles J. Glidden, of Boston, accompanied by his wife and their engineer, Charles Thomas, of London, England, arrived here yesterday and are stopping at the Pfister Hotel. They have now covered 17,782 miles of their trip around the world, which was commenced three years ago, and has been continued at intervals ever since. From here they will tour to various Wisconsin and Minnesota points, and later will arrive in Minneapolis, where the special wheels for traveling on the railroad tracks will be fitted to the car and it will continue westward over the Soo Line and Canadian Pacific to Vancouver. There the party will take ship for Honolulu, and from that point the route will be followed to New Zealand, Australia, Tasmania, China, Japan, the Asiatic Archipelago, Philippines, India, Ceylon, Egypt, Palestine, Greece, Turkey, Hungary, Italy, Sicily, Tunis, Tripoli, Algeria, Spain, Portugal and France. The completion of the trip will occupy about three years.

Another danger has been added to the automobile habit. A New Jersey couple got married the other day while the machine, which was broken down, was being repaired.—*Aurora (Ill.) Beaver.*

The city council of St. Augustine, Fla., has passed an ordinance restricting the speed of automobiles to six miles an hour, and to three miles when turning corners or crossing intersecting streets. Automobiles for livery must pay a license of \$10.

Manipulation of Spark and Throttle.

BY JOSEPH TRACY.

IN driving a car which is not fitted with an automatic carbureter it is well to bear in mind that the quality of the mixture changes when the motor speed varies. For this reason when starting the car, and just before the clutch is allowed to engage, the spark control handle should be advanced a little, though not to the extent of causing the motor to race. The composition of the mixture should next be regulated until the motor explodes regularly. If the clutch is now allowed to engage, the car of course starts forward.

The heavy load imposed on the motor will slow it down perceptibly, and this reduction in motor speed will be greater, obviously, with a small motor than with a large one. The speed reduction of the motor will also depend on the clutch slippage. If the clutch takes hold suddenly, or "grips," the car will be started abruptly, and the motor slowed down more than if the clutch slipped a little. On account of the reduced piston speed, in either case, the carburation will not be fully effective unless the composition of the mixture is again changed by means of the supplementary air handle, or otherwise. If this is not done the motor may not be able to develop sufficient power to start the car, and may stop altogether. To prevent this the clutch must be withdrawn quickly, so as to allow the motor to speed up again. When the motor has picked up in speed, the clutch should be allowed to reengage gently.

This unclutching and speeding up may have to be repeated several times if the power of the motor is low in proportion to the car weight, plus the load.

Applying the clutch when the motor is racing or revolving fast throws great strains on the gears and transmission, and is very severe on the clutch face, whether it is of leather or metal.

* * *

A good way to start a car which has a non-automatic carbureter is as follows:

After the motor has been started, the ignition should be retarded, and the mixture regulated until the motor runs slowly, say about 300 revolutions a minute. The throttle should be kept open as much as possible. If the motor will not run slowly with the throttle well open, the ignition should be still further retarded. When the motor speed has been reduced to about 300 revolutions the clutch may be allowed to engage and the car started. As soon as the car begins to move the ignition should be advanced gradually. At just what rate the ignition should be advanced will depend on the horsepower, gear and number of cylinders. No general instructions that will apply to all cases can be given.

After a few trials a driver will soon find how rapidly to advance the ignition so as to cause the car to accelerate as quickly as possible. Why a motor is handled in this

way—which might be called the constant speed method—(in contradistinction to the second method, described later on, and which might be called the constant mixture method)—may be explained thus:

A car requires much more power to start it from a standstill and to accelerate it to a given speed, say six miles an hour, than it does to keep it moving at this speed. The power required will depend on the time taken to accelerate the car from zero speed to the given speed. If three seconds is required to accelerate from standstill to six miles, the horsepower necessary to do this will be twice as much as would be required to accelerate to the same speed in six seconds.

Another way of putting it is to say that the rate of acceleration when starting will vary directly as the applied horsepower.

If a car is geared high on the low or starting gear it will absorb more power in starting than if geared low.

From the foregoing it will be readily understood why a motor in a starting effort is often required to develop more power than is ordinarily used in running. When starting a car an energetic pull or tractive effort is what is wanted, in conjunction with a relatively slow rotative speed of the motor, because the slower the motor revolves the slower will be the rate of acceleration and the less engine power will be required. Care must be taken, however, that the motor is not revolving so slowly as to be stopped when the clutch takes hold.

In order to make a gasoline motor run well when fitted with a non-automatic carbureter one of two conditions must be complied with: Either the motor speed has to be kept constant and the composition of the mixture regulated to suit this particular speed, or the mixture must be varied every time the speed is changed. When the clutch engages the motor will tend to slow down, but by advancing the ignition to a certain position the motor will not only be prevented from slowing down but made to maintain the same speed as it had before the clutch was applied. When the car is up to speed on its first gear the motor can be accelerated by advancing the ignition slightly. Usually, when a motor which has not an automatic carbureter is accelerated it misses explosions. This missing, if due to defective carburation, can be stopped by correctly adjusting the proportions of the mixture. If it is not desired to do this the motor may be accelerated as much as possible, the clutch withdrawn, the gear changed, and the clutch be allowed to reengage. It is well at the instant of unclutching to quickly retard the ignition so as to slow the motor. After the gears have been meshed and the clutch allowed to reengage the ignition can be advanced again. These operations should be repeated every

time a change is made from a low to a high gear. After the highest gear has been meshed the car will run along at a constant speed. This speed will depend on the setting of the governor on the motor. If it is desired to go still faster the motor may be accelerated.

* * *

The other method of handling a motor that has a non-automatic carbureter usually calls for some delicate manipulation. For instance, when about to start the car after the motor has been set in motion the engine should be throttled to prevent it running too fast. The ignition should be kept pretty well advanced. As soon as the clutch is engaged the motor will of course slow down. This change in motor speed causes the composition of the mixture to vary, as previously mentioned, and the change in the mixture will have to be corrected by moving the handle provided for this purpose. Every time a gear is changed or when the motor speed is changed this handle will have to be moved, if the best results are to be expected.

Driving through traffic or in any way which calls for widely varying motor speeds will therefore be rather tiring, which is the objection to this method of handling a motor.

The objection to the first method, which may be called controlling by spark, is that it heats up the motor and is likely to damage the exhaust valves. It may also heat the muffler or exhaust pipes red hot. The sound from the exhaust is also much louder when the ignition is retarded than when it is advanced.

Explosions or "popping" in the induction pipe are also caused by running with a late spark. In this case flame remains in the cylinder long enough to ignite the ingoing charge when the inlet valve opens.

All these objections can be minimized by judicious handling and by keeping the ignition retarded as short a time as possible consistent with effecting the necessary gear changes correctly.

While speeding his automobile near Worcester, Mass., to escape a pursuing policeman, Edward M. Tolman, of Syracuse, N. Y., ran the machine over the railing of a bridge into the Millers River. Mrs. Tolman, three children and a nurse were also in the car which landed in five feet of water. All the occupants fell clear of the car except an 8-year old girl, who was caught in a mud guard and held under water. Her father only succeeded in extricating her after a hard struggle. Just as the party waded ashore the exhausted policeman appeared, and so shocked was he at the state of affairs that he assisted in getting the automobile out of the water (it was practically uninjured) and watched it depart, at a very low speed, entirely forgetting the errand which had brought him so hastily to the spot.

Calais-Dover Auto-Boat Races.

Cross Channel Contest Won by "Mercedes IV." at an Average Speed of 21.87 Miles an Hour.

Special Correspondence.

LONDON, Aug. 10.—The Calais-Dover motor boat race, organized by the Automobile Club of France, was run Monday, August 8, the weather being warm and bright and the sea calm. The original entries numbered thirty-two, and of these twenty-one started. All but one managed to cover the twenty-two miles of English Channel separating France and England at this point. The winning boat was the new *Mercedes IV*, a French-built hull with a 90-horsepower German Mercedes motor. Her time was 1 hour 7 2-5 seconds.

The starters in the racing class were *Mercedes IV*, *Napier Minor*, *Princess Elisabeth*, *Titan II*, *Marsouin II*, *Trèfle-à-Quatre*, *Marthe* and *Hotchkiss*. The cruisers were *Vas-y*, *Le Nogentais*, *Suzy*, *Mœmie*, *Camelia*, *Marcotte*, *Triplex*, *Jack*, *Amiral Bruix I*. and *Hummono*. There were also three representatives of the fishing boat class—*Dalifol*, *Maurice* and *l'Aurore*. The winner in the racing class, *Mercedes IV*, was one of the most striking boats in appearance in the fleet. Her hull is aluminum painted and a protecting hatch over the engine and a short exhaust stack are of sheet aluminum, giving the whole craft a bright, silvery look, which, with the clean manner in which she went through the water, made her very conspicuous. The second boat to finish was *Napier Minor*, the craft that won the Harmsworth cup race for England, but did not get the cup. When running at speed her bow sticks far out of the water and she throws out sheets of spray that hide the entire hull except the bow.

The third and fourth boats to finish were the French launches *Princess Elisabeth* and *Titan II*, both fitted with 50-horsepower Delahaye motors and finishing within about two minutes of each other. One of the racers to experience trouble in the race was *Marsouin II*, whose delay on the Channel

was included in her official figures, so that her time is no criterion of her speed. Trouble also came to the famous *Trèfle-à-Quatre* (to which *Marsouin II* is said to bear a certain resemblance), for her crew apparently insisted upon over-dosing her motor with lubricating oil, the result being smoked plugs and the usual accompaniments.

The last boat to finish in the racing class was *Marthe*, made notable by the fact that



AUTO-BOATS IN DOCK AT CALAIS BEFORE THE RACE.

her fuel was kerosene, she being the first racer driven by internal combustion motors using this fuel to cross the Channel.

The only boat that did not finish in this class was the *Hotchkiss*. She had a great deal of ignition and spark plug trouble and did not reach Dover until about 4:30 p. m., when she was towed into the harbor.

The scene at the starting point was lively in the extreme. Calais was in holiday garb, and everything that would float was laden with sightseers, while big passenger steamers, carrying crowds of spectators from both sides of the Channel, stood by waiting for the start. Among these were the *Queen*, an English turbine boat, credited with a speed of twenty-one knots, chartered for the occasion, and *Pas de Calais*, only one knot slower than *Queen*, chartered by the Automobile Club of France for a party of officials, among whom was Comte Récopé, donor of one of the three cups which were given as prizes. French torpedo boats and destroyers, steam and sailing yachts and pleasure craft of all kinds, smart in their clean paint and bright brass-work, gave

lightness and gaiety to the assemblage, while the little competing craft dashed around among their slower kindred, warming up for the work of the day and showing their paces, or quietly rolled on the slow swell making final adjustments. The *Mercedes IV* had her valves out, her cylinder heads off and parts of the motor lying all over the boat, as if the race were a week off, her crew working away unconcernedly, and, as results showed, to good effect.

The starting gun was fired at 1.43 p. m., and, though some of the boats seemed uncertain as to whether their time had come or not and watched each other for a cue, a fairly good start was made. The clean-cut mahogany *Hotchkiss* made a magnificent start and led the fleet, looking as if she were going faster than any of them. She was closely followed by *Mercedes IV*, with *Napier Minor* third and closing the gap slowly but steadily. The other boats were close on the heels of the leaders. All eyes were on *Hotchkiss*, and her stock went soaring, but her triumph was extremely short. Less than a mile from the starting point her motor came to a dead stop, and notwith-



HOTCHKISS BOAT AT SPEED WITH FOURNIER IN CONTROL.

standing the desperate efforts of Henry Fournier, who was in command, to get her under way, she refused to move until even the fishing boats were out of sight, when one or two cylinders consented to work and *Hotchkiss* limped to Dover too late even to join in the shouting.

A desperate effort was made by *Napier Minor* to catch the flying *Mercedes IV*, now in the lead, and for a few minutes seemed to be gaining, but the aluminum streak drew away and arrived at Dover first, her average speed being nineteen knots exactly, or 21.88 miles an hour. The troubles of *Hotchkiss* left *Trèfle-à-Quatre*, sailing under the British flag, in third position, and she also made a supreme effort to catch the leaders, but her motor began to give trouble, and finally stopped altogether, and she was passed by *Titan II*, *Le Nogentais*, *Marsouin II*, *Princess Elisabeth*, *Camelia*, *Amiral Bruix*, *Triplex* and *Marthe*, in the order named. She got started again, however, and overhauled *Marthe*, but was unable to get near the others.

In the cruising class *Vas-y*, which did such fine work at Monaco, proved a winner by a good margin over *Le Nogentais*, the second cruiser in. The time of *Vas-y* was 1:59:19, her average speed for twenty-two miles being 9.5 knots. The fishing boats, *Dalifol*, *Maurice* and *l'Aurore* finished in the order named, the winner's time being 2:54:08, and her average speed 6.6 knots.

One of the surprises of the day was the manner in which the racers kept away from the high-speed passenger boats and the French torpedo boats and destroyers. All of these craft, confident of their superior speed, allowed the leading boats to get a good start, intending to overhauled them at their leisure; but, to their consternation, they couldn't do so. Firing up was at once the order of the day, dense masses of smoke from funnels showed how hard the big fellows were trying to save their reputations. One or two of the torpedo boats managed, with difficulty, to close up some of the gap, but the twenty and twenty-one-knot passenger steamers failed to more than barely keep the leading boats in sight.

Some anxiety was caused the French sportsmen by the fact that *Mercedes IV* crossed the line at the finish in the wrong place, laying herself open to disqualification. No protest was lodged, however, and her victory was undisputed.

The prizes were distributed as follows: *Mercedes IV*, the winner in the racing class, gold medal presented by the French Minister of Marine, M. Pelletan, who watched the race from a steamer; *Napier Minor*, a prize of 1,000 francs presented by the International Sporting Club of France for the first racer that had taken part in the Monaco events to reach Dover. *Vas-y*, a similar prize as the first cruiser to finish, and



AUTO BOATS IN WET DOCK AT CALAIS.—TREFLE-A-QUATRE NO. 8.

this little boat also took the President's Cup. The Coupé Récopé goes to *Marthe*, as the first boat to arrive using kerosene. The Coupé Quinones de Léon was to have been given to the first arrival using alcohol, but as *Noemi* was the only boat using this fuel, the prize was not awarded. The winner in the fishing boat class, *Dalifol*, received a silver medal presented by M. Mill, Deputy for Pas-de-Calais.

Ostend Auto Boat Races.

An attempt was made to start the Ostend Auto boat races on Tuesday, August 2, but the weather was so boisterous that nothing in the racing line could be done. The racers started out to make the circuit of the nine-mile parallelogram which constituted the course, but after shipping a great deal of water and being roughly handled by the seas, had to give

back again to Ostend, the total distance being about 25 miles. Owing to the unsatisfactory termination of the event for racing boats it was decided to run this event again on the following day, which was done, with the result that *Trèfle-à-Quatre* won first place in her class (boats from 25 to 40 feet over all) going 31 miles in 1 hour 55 minutes 24 seconds. In the class for racing boats under 25 feet over all over a 31-mile course *Princess Elisabeth* won, her time being 3 hours 30 minutes, her average speed being about 8½ miles an hour. Second place was taken by *Marsouin II*, her time being but one minute slower than that of the leading boat. A 19-mile handicap for cruisers was won by *Triplex*, winner of the previous day's race for cruisers, in 2 hours 16 minutes 5 seconds, *Lutin* being second.

The last day's racing was held on the Bruges Canal, where the water was of course perfectly smooth, and consisted of mile and kilometer trials for all classes of boats, with standing and flying starts. In these events

Trèfle-à-Quatre



it up. Even some of the cruisers found it too much for them, and had to get in out of the wet. The winner was *Triplex*, a French boat, with a Delahave motor. Their course was from Ostend to Blankenburghe, back to Ostend, on to Raversyde and

MERCEDES IV WINNER OF THE CALAIS-DOVER AUTO BOAT RACE.

had things all her own way, making the best time in every event, *Princess Elisabeth* being a good second. The times of the two first boats were as follows:

	Kilom. Standing start.	Kilom. Flying start.	Mile. Standing start.	Mile. Flying start.
<i>Trèfle-à-Quatre</i>	1:51:1-5	1:44:2-5	3:15:2-5	2:55:2-5
<i>Princess Elisabeth</i>	2:00:4-5	1:45:	3:18:4-5	3:26:

The prizes were in the form of cash, *Trèfle-à-Quatre* and *Princess Elisabeth* each winning \$200 and other boats smaller amounts.

CUP GOES TO FRANCE.

"Trèfle-a-Quatre" Protest Against "Napier Minor" is Allowed.

Special Correspondence.

LONDON, Aug. 12.—The protest entered by the owner of *Trèfle-à-Quatre* against the substitution of *Napier Minor* for *Napier II.* in the final heat of the Harmsworth Cup race, July 30, was under consideration at a special meeting of the International Commission in London on August 9. After due consideration the French protest was upheld and the race awarded to the Richard Brasier boat.

From a strictly sporting standpoint this is the only possible outcome. The race committee should have sent *Trèfle-à-Quatre* over the course alone and permitted her to take the cup in a walkover. No complications could then have ensued. In no other branch of sport would a competitor defeated in an earlier heat of a contest have been put up in the final, if a clause had not permitted the fastest loser to compete. It is with a view to the insertion of such a by-law that the regulations governing the race are to be revised, in order to exclude any possibility of the recurrence of such a difficult position.

The commission has, by its action, annulled the ruling of the race committee.

sion will doubtlessly interest. It is as follows:

"This meeting of the International Commission, having considered the protest lodged by the A. C. de France on behalf of the owner of the *Trèfle-à-Quatre* and having carefully studied the rules under which the race was run, has arrived at the

essarily follows that the winner of Race 4 was the only one of the two boats qualified to compete in the final. 5. In these circumstances the protest is upheld and the race is awarded to the *Trèfle-à-Quatre*. 6. The International Commission recommends that such additions to the rules be made as are necessary to provide against similar occurrences in the future.

NEWPORT LAUNCH RACES.

"Vingt-et-Un" Wins from "Swift Sure" and "Mercedes" in Record Time.

Special Correspondence.

NEWPORT, R. I., Aug. 20.—As a part of the miscellaneous program of aquatic sports which always fills one day of the New York Yacht Club's annual cruise, there took place at Newport last Thursday a real race of motor-boats, with a spirited competition from start to finish, in the course of which some excellent records were made. Three boats were entered in the larger class: *Vingt-et-Un II.*, entered by W. L. Brooks and steered by C. M. Hamilton; *Swift Sure*, owned and steered by N. G. Herrshoff, and *Mercedes*, steered by her owner, H. L. Bowden. The course was a triangle of eight nautical miles, run twice, the first leg being about two miles up Narragansett Bay, around a mark off Jamestown, around Gould Island and home. There was a strong northwest wind down the course, and the tide was near the end of the ebb. The water was quite rough and all hands donned oilers, but the crew of the *Mercedes*, including her designer, W. Starling Burgess, and a mechanic, wore bathing suits under their rubber coats, with swimming collars about their necks.

With a load waterline of about 51 feet, the *Swift Sure*, which is equipped with a special Horreshoff triple expansion steam engine and pipe boiler, rates at 81.90, and



PRESIDENT LOUBET'S SEVRES VASE.

following conclusions: 1. There is no rule which provides what shall be done in the event of two boats of one country being eligible for the final. 2. The Official Programme, however, provided that in the event of any two of the preliminary heats being won by the same country, those two boats should race together in Race 4 for the honor of representing their country in

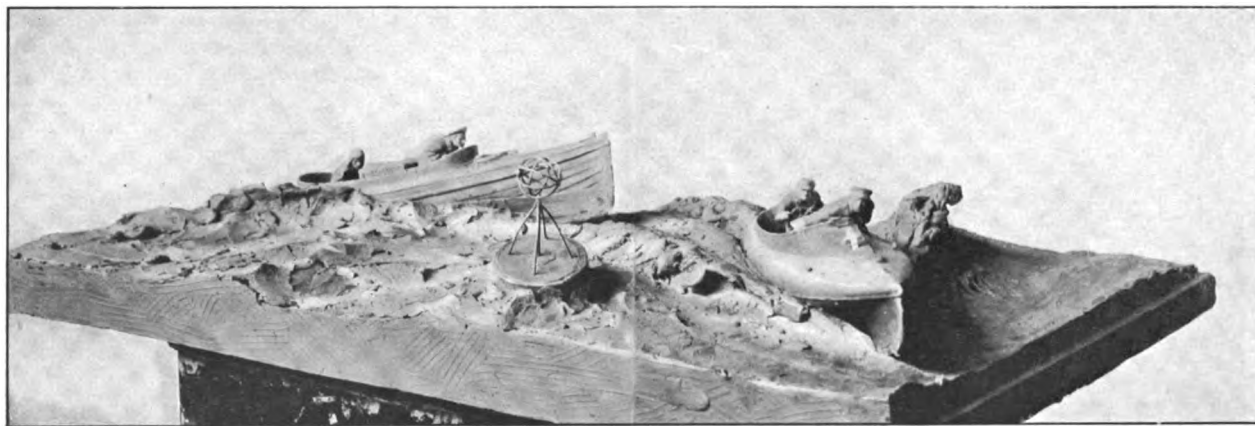

HARMSWORTH TROPHY (COMMONLY CALLED CUP) FOR INTERNATIONAL AUTO BOAT RACE WON BY FRENCH BOAT, TREFLE-A-QUATRE, ON PROTEST.—ENGLISH BOAT NAPIER MINOR CAME IN FIRST AND WAS DISQUALIFIED.

which sent in *Napier Minor* in lieu of *Napier II.*, and this again is probably a precedent.

The case is of the greatest interest, as the disqualification of the winner of an international event is, fortunately, a rare occurrence, and the report of the commis-

the final. 3. The International Commission is of opinion that this is in no way binding on a competing club, which might have refused to race and have decided to nominate its representative for the final. 4. The arrangement suggested in the programme having been acquiesced in, it nec-

allows both the other boats. *Vingt-et-Un II.*, with about 39 feet waterline and a 75-horsepower Smith & Mabley motor, received 1 minute 36 seconds, while *Mercedes*, with 32 feet waterline and a Mercedes motor, received 3 minutes 6 seconds.

The start was given at 12:10 p. m., *Mer-*



RECOUPE TROPHY FOR BOAT USING KEROSENE IN CALAIS-DOVER RACE.

cedes being first away, with *Swift Sure* close after her, and *Vingt-et-Un* last. The steamer soon took the lead, *Mercedes* holding second place to the Jamestown mark, where she shipped some water in turning and fell to third place. The first round was timed as follows:

	Elapsed time.	Knots
<i>Swift Sure</i>	21:34	22.21
<i>Vingt-et-Un II</i>	21:42	22.07
<i>Mercedes</i>	24:32	19.05

After passing the Jamestown mark on the second round *Vingt-et-Un* took the lead, holding it to the finish by dint of hard work, as she had but three seconds to spare at the line. The times on the second round were:

	Elapsed time.	Knots.
<i>Vingt-et-Un II</i>	21:16	22.58
<i>Swift Sure</i>	21:27	22.38
<i>Mercedes</i>	24:56	19.25

FULL COURSE.

	Elapsed time.	Knots.
<i>Vingt-et-Un II</i>	42:58	22.32
<i>Swift Sure</i>	43:01	22.32
<i>Mercedes</i>	49:28	19.15

Vingt-et-Un II. won by 1 minute 30 seconds corrected time over *Swift Sure*, and 5 minutes over *Mercedes*.

At the same time two smaller launches were started to make one round of the course: *Neon*, owned by N. G. Herreshoff, Jr. and *Wayfarer*, by J. H. Hammond, Jr. The former rates at 33.00, but *Wayfarer* was not measured. The latter finished the course in 50 minutes 14 seconds beating *Neon* by 3 minutes 56 seconds, but the latter won on time allowance.

The speeds of *Vingt-et-Un II*. and *Swift Sure* figure out at 25.64 statute miles—the record speed for auto-boats in rough water.

It is of much interest to note that in addition to beating the *Mercedes* and the fastest steam launch ever built, *Vingt-et-Un II*. was run from Larchmont to Newport under her own power and unattended by another boat to demonstrate her sea-

worthiness and reliability over long as well as short distances. She left Larchmont late Monday, stopping at Shelter Island and at Watch Hill for supplies and to await the lifting of the fogs. Early Thursday morning, the day of the race, she started from Watch Hill and made the thirty-mile run from Watch Hill Light to Fort Adams through the open Atlantic, under by no means fair weather conditions, in 1 hour 25 minutes, arriving at Newport just a short time before the start of the race. In this run she was steered and handled entirely by C. M. Hamilton, who had only one assistant aboard.

Vingt-et-Un II. is equipped with an S. & M. Simplex motor weighing, with all its mechanism, about 900 pounds, and developing 75 horsepower.

Not necessarily for the protection of the locomotive, but as an evidence of ordinary prudence, says the *Walnut Express*, the automobilist should check his speed when his machine and a railway train are approaching the same crossing.

The Fort Worth automobile roster now shows a total of forty owners, nearly one-fourth of whom are women.

REGULARITY OF RUNNING.

Packard Gray Wolf, at Buffalo, Shows Remarkable Uniformity in Miles.

BUFFALO, Aug 16.—The analysis by miles of the 25-mile exhibition run of the Packard *Gray Wolf* yesterday, with Charles Schmidt at the wheel, is of interest apart from the fact that the total time, 28:32 1-5, broke the track record for cars weighing from 881 to 1,432 pounds. Study of the time by miles shows a quite remarkable uniformity of running from first to last. The difference in time between the slowest and the fastest mile was but 2 3-5 seconds; the average time per mile was 1:08 2-5, and three miles was made in just this time, while seven others departed from it by only 1-5 of a second—a variation of less than 1-3 of 1 per cent.; and the greatest difference in time between the several groups of five miles was but 5 1-5 seconds. From the sixteenth to the twentieth mile, inclusive, the car showed a variation of but 1-5 of a second per mile, and from the thirteenth to the twenty-third mile its total variation was but 2 seconds to the mile.

Following is the time by miles:

First mile, 1:09 4-5; 2nd mile, 1:09 1-5; 3d mile, 1:09; 4th mile, 1:09; 5th mile, 1:08; 6th mile, 1:07 2-5; 7th mile, 1:08 3-5; 8th mile, 1:08; 9th mile, 1:07 3-5; 10th mile, 1:08 1-5; 11th mile, 1:09; 12th mile, 1:08; 13th mile, 1:08 1-5; 14th mile, 1:08 1-5; 15th mile, 1:09 1-5; 16th mile 1:08 1-5; 17th mile, 1:08 2-5; 18th mile, 1:08 2-5; 19th mile, 1:08 1-5; 20th mile, 1:08 1-5; 21st mile, 1:07 1-5; 22nd mile, 1:08 2-5; 23d mile, 1:09; 24th mile, 1:09 4-5; 25th mile, 1:09 1-5.

Time for first 5 miles, 5:45; for second 5 miles, 5:39 4-5; for third 5 miles, 5:42 3-5; for fourth 5 miles, 5:41 2-5; for last 5 miles, 5:43 2-5.

Father L. E. Wahlmier, of Plainville, Kan., near the Colorado line, has purchased an Oldsmobile touring car in Kansas City for use in his missionary work on the plains. He says the automobile was a necessity because of the great distances he has to cover in his work, the part of the state in which he lives being sparsely settled, mostly by ranchers, and the parishes widely separated.



AUTO BOAT MARTHE, WITH CAZES MOTOR. WINNER OF RECOUPE TROPHY.

Stray Notes on the Saint Louis Tour.

Chickens Fall by the Way but no Mishaps to Mankind are Recorded—Scenes at the Pontiac Fire—Final Dash Through the Mud to the Finish.

Special Correspondence.

ST. LOUIS, Aug. 20.—One of the most unpleasant recollections of the World's Fair tour was the slaughter of domestic fowl and animals along the road. Few automobilists drive more carefully than we do, and if you multiply our record of four dogs and half a dozen chickens by the total number of cars entered in the run, plus the machines used as escorts from different cities and towns en route, the grand total would be in the neighborhood of 400 dogs and 600 chickens, plus an unknown number of cats, turkeys, geese, ducks, rabbits, and even pigs. A trail of feathers marked each day's run, and the dead dogs, pigs and poultry lined the course in increasing numbers as the number of machines passing over the route grew.

Despite this devastation and the frightening of horses and interruption of work on the farms, the rural inhabitants all along the line were greatly interested in the run and did everything they could to add to the pleasure and enjoyment of the trip. Every farmer along the way held "open house" on the day the tourists were scheduled to pass, and his neighbors, who lived on some back road not traversed by the party, came in bevy bringing rocking chairs and hammocks that they might enjoy in comfort the greatest and most novel parade that had ever passed through their section of the country.

The younger spectators danced up and down as each machine hove in sight, their delight unbounded as driver after driver passed by, enveloping them in clouds of dust and giving them but a scant opportunity of seeing the "red devil" of which they had heard so much. Flags were waved and house after house located miles from any city or town was decorated with bunting and flags in honor of the occasion. Apples, pears, plums and flowers were handed or thrown to the tourists as they hurried by, the bouquets in many cases bearing the cards of the donors with a line stating that they would be pleased to hear from the receiver of the flowers as to their safe arrival in St. Louis. Some undoubtedly have received letters of thanks ere this.

Speed laws feared by everyone at the start were entirely ignored by city and village police alike, and in small towns one heard, as he rushed through the thickly lined streets, frequent shouts of "Go on, you'll catch him if you go a little faster, he's only about a mile ahead." Not one arrest was made along the entire route for breaking speed laws, which were sadly violated in many sections. There were no serious accidents either to tourists or to persons

met along the road, and I have not heard of a single collision, the only accidents being the breaking up of the *Great Scott*, as the special Whipple-Scott car was called, the overturning of a White steamer, a Cadillac and a Winton in the mad race for first honors between South Bend and Chicago, and the burning of the Olds tonneau car in the garage fire at Pontiac.

Officials of the A. A. A. having the run in charge made arrangements for one official garage at each town designated as a night stopping place. It was an inspiring sight to see from thirty to 100 automobiles, —American, German, English and French, covered with the mud and dust of a 100-mile spin,—being washed and put in shape for another long run on the morrow. No automobile show the writer has ever seen could compare with this free exhibition, and the residents took advantage of this fine opportunity to look over the machines. It was a good advertisement for the makers to have the cars lined up side by side and have each one gone over carefully by the spectators, but the risk from fire was hardly given any attention.

The aggregate amount of money represented by the machines stored in one of these garages would be at least \$200,000. Had these cars been run in, their power shut off, lights put out and the doors locked, all would have been safe, but nine out of ten of the operators would work on their autos far into the night to get them in perfect condition for a lively run to the next control. Gasoline in gallon measures and in five-gallon cans would be used in filling tanks, some idle spectators would carelessly light cigars or cigarettes and occasionally some mechanic would come in with an uncovered light. I have even seen blow torches and soldering tools at work amidst this array of expensive machines and in an atmosphere saturated with the fumes of the volatile fuel. The marvel is that the inevitable did not come sooner than at Pontiac, as narrated in last week's issue, and at some garage where all the cars, instead of only two, were inside the building.

That night at Pontiac my brother and myself occupied the lower parlor of the Phoenix Hotel. We were aroused by cries of "Fire" and the crackling of the flames, followed almost immediately by an explosion that fairly shook the hotel building. A glance across the street showed the entire front of the livery stable afire, the flames shooting half way across the street.

"I guess the trip ends right here for most of us," said my brother, as he tucked his night clothing into his trousers, slipped

on shoes and vanished out of the window. Realizing that the hotel itself was liable to go, I took a minute longer and packed our suitcase, then with it in my hand followed through the window.

The scene in the courtyard is one that I shall never forget. Shouts came from every direction out of the darkness, while without the slightest warning of horn or bell, machine after machine plunged out of the blackness, making for the narrow exit at full speed. I found my brother frantically endeavoring to crank the engine of our car with the gasoline cock turned off, swearing and panting as the explosions refused to come. Without waiting to get the engine going, I grabbed the first man I saw and the three of us pushed the car out onto the street, and continued to push it down the dark street until we met a man who said, "If you go twenty feet further you will be in the river." Then we stopped.

During the fifteen minutes that it took the Pontiac fire department to put the fire out, the entire town seemed to have assembled, and as all the guests had been aroused in the hotel when that was first threatened, about twenty tourists who had made for their machines without stopping to dress, found it rather embarrassing to sneak back through this throng to their rooms for more clothing. The majority, tired as they were, did not go back to bed, fearing that some lingering spark would strike a gasoline trail and the flames would break out afresh. Soon the peculiar hollow sound of Water's Panhard announced that that gentleman was seeking new quarters at Springfield, about 100 miles further south, where he might spend the next day resting. Others followed, and that fire was responsible for almost every machine getting out of Pontiac before daylight.

Purses were made up for W. A. Copeland, whose entire machine shop, with all its tools, accessories and stock had been destroyed, and for the Pontiac firemen whose quick action and skilled work had undoubtedly prevented a loss of \$100,000 in automobiles. Then we one and all began fully to realize what a dangerous thing it was to crowd all the machines into one garage and to allow workmen, with lights and gasoline, around the cars in their crowded quarters. It seems that the Buckmobile, Packard and Franklin were rescued by President Whipple, assisted by Mr. Sheldon of the Goodrich Tire Company, and Tom Fetch. The Oldsmobile was a complete wreck. There was nothing left that could possibly be used as a basis for a repair job. It was the property of F. A. Benson, who joined the party at Chicago, and it is the second car he has had damaged by fire. He carried \$500 insurance on this one.

In the runs from town to town it was the first cars in that received all the "notice" from the local papers, and with the desire to see their names and the name

of the car they were driving in the daily paper that afternoon or next morning many were the early starters and great was the speed of some cars. There were others who did not care so much for the notoriety gained, but who would rather avoid the dusty roads and crowded highway of mid-day by starting early. Among these was J. M. Waters, driving a Panhard, capable of averaging about forty-five miles an hour. On one occasion we started early, and knowing the Panhard could travel two feet to our one we hustled with our ears wide open for the peculiar hollow exhaust emitted only by a Panhard. It was 4 a. m. when we started, and the cool morning air was so still and clear that we knew we could hear a car miles astern. Eventually we heard it, miles away, but gaining. In vain we opened throttle and advanced the spark, but no car such as ours can successfully cope with a powerful Panhard, and we knew it. As we sat there with the "yellow fellow" coming up behind us, still out of sight, but gaining, these lines came to me, I as a school boy having learned to recite "Sheridan's Ride:"

Up from the North at break of day
 Bringing to small cars fresh dismay
 The affrighted air with a shudder bore,
 Like a herald of haste to the steersman's
 oar
 The terrible grumble, rumble and roar,
 Telling the Panhard is on once more,
 With Pontiac twenty miles away.

When the *Pathfinder* made the trip over these grounds before, one other car among the lot had also had some experience with the mud in southern Illinois, and that was Webb Jay's White steamer. We knew our car, and we slammed it in a manner that caused some of the drivers of the big cars to open their eyes. No, they couldn't follow

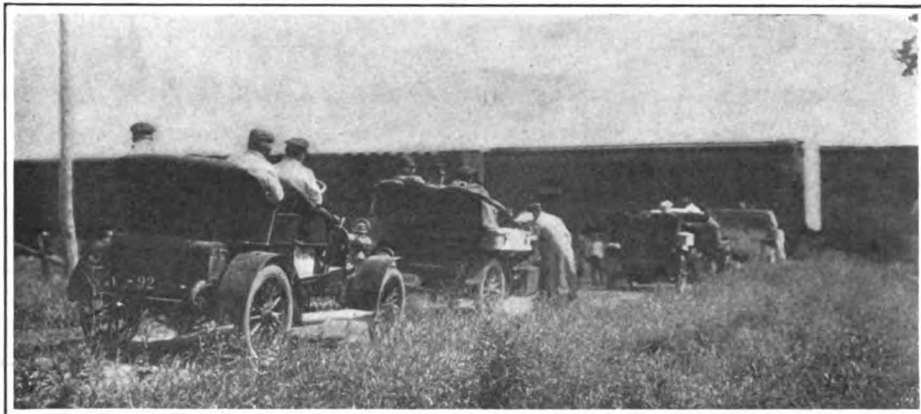

PROCESSION OF TOURISTS HELD UP BY FREIGHT TRAIN AT GRADE CROSSING.

suit, for a twelve hundred pound car can take ditches at a twenty-mile clip that would wreck a heavier car, no matter how well built. In this way we kept on our high speed both uphill and down most of the way, and our engine kept cool. Big cars that had never run on less than their third or fourth speeds were obliged to take their second or third. Water boiled in almost every radiator. This was the way we went into East St. Louis, over the same apologies for roads that that State has always boasted of, and unless someone in the legislature eventually wakes up, always will—probably the poorest roads in the United States.

Frank X. Mudd, the Chicago club man, who had charge of this end of the run, and the man whom the tourists have to thank for the very poorly marked route cards and worse laid trail of confetti between Chicago and St. Louis, had gone so far as to say that the *Pathfinder* on her former tour of inspection purposely went out of her course in order to get photographs of the worst roads. I think the "little shower,"

as the natives termed Tuesday night's rain, and the correspondingly heavy roads Wednesday, showed the tourists on this run only too plainly what conditions they might expect should the run have been preceded by two weeks of almost continuous rain, as was the case when we originally made our trip.

About thirty-five cars belonging to the tourists were in line when the time came for starting the parade into St. Louis. A number of machines that had left Springfield that morning were still missing, but the line was formed at the City Hall in East St. Louis without further wait. The stragglers kept coming in at intervals all the afternoon and far into the night. Tales of mud and assistance from teams and farmers along the last twenty-five miles were plentiful.

Trailing behind the spick and span cars of the St. Louis escort came the tourists. It was no trick to tell who had been in the running. A weather-beaten, road-racked line of dusty pilgrims and stained cars it was. Red devils, green devils and white devils were there beneath liberal splashes of mud. Tires punctured, tires bound with ropes, and extra tires tied on to ever conceivable part of the machines, levers and wheels awry, radiators smashed and lamps bent told the story of a well-earned victory over all kinds and conditions of roads.

The automobiles lined up four abreast in front of the splendid new Jefferson hotel in St. Louis and then backed up against the curb, where they were quickly surrounded by hundreds of spectators. The tourists made a grand rush for the hotel, all clamoring for rooms with baths, and the biggest automobile tour yet inaugurated came to an end.

PERCY F. MEGARGEL.

Eight new motor car routes have recently been established by the Great Western Railroad of England, in connection with its suburban passenger service.

The motorists of Columbus, O., have decided upon a plan to attract attention to the condition of the streets of the city. The Columbus A. C. proposes to hold an obstacle contest on Broad street, offering prizes to the cars that avoid most of the holes.



ON ONE OF THE TYPICAL MUD ROADS NEAR SPRINGFIELD, ILLINOIS.

Fournier and Winton Records Wiped Out.

Harkness, in His 60-Horsepower Mercedes, Makes New Figures from Twenty to Sixty Miles at Long Branch.

Special Correspondence.

LONG BRANCH, Aug. 20.—The last records standing in the names of Henry Fournier and Alexander Winton were wiped from the slate by Harry Harkness with his 60-horsepower Mercedes at the Elkwood Park track here last Wednesday in the 100-mile race. The Frenchman's track records from fifteen to twenty miles had been broken by Paul Sartori in A. G. Vanderbilt's Mercedes at Empire City track July 16, and those from twenty to twenty-five miles—all that remained of the series of records made by Fournier at Fort Erie, Canada, on September 26, 1901, in his big Mors—were cleaned up by Harkness, who, continuing, also, swept away the records from the quarter to the half century figures made by Winton at Chicago, September 18, 1900, and created new ones to sixty miles, at which point the contest was called off, the only other competitors having withdrawn. His time for twenty-five miles was 28:30 2-5; for fifty miles, 1:01:23 1-5, and for sixty miles, 1:12:40 2-5.

The other competitors were Joseph Tracy, in a 36-horsepower Royal Tourist, who maintained a fast even gait for thirty-six miles, when his radiator broke, and E. H. Hawley, in E. R. Thomas's 60-horsepower Mercedes, who withdrew at the end of twelve miles, having lost several miles by stopping to protest that Harkness had crowded him toward the fence on a turn. Harkness' success in breaking records at his comparatively low speed is, of course, due to the fact that no races or speed trials at greater distances than twenty miles since Winton's and Fournier's records were created.

Charles A. Greuter made a good showing with the 24-horsepower Matheson in the five mile "pick-up" race, in which the contestant was required to stop at the end of each mile and take aboard a passenger, finishing with four passengers in the car besides the driver. Greuter's time was 8:48 2-5. The innovation afforded much amusement to the large attendance of society persons summering at this and neighboring seaside resorts, who had come to the track in automobiles and horse-drawn vehicles, which were packed together on the lawn in front of the grandstand, the lion and the lamb, as it were, lying down together in peace. So accustomed have the horses become that they showed no fright when the cars around them were started.

Thursday's events were watched by an even larger crowd than attended on Wednesday, and interest centered mainly in the five-mile handicap and the gymkhana races, which lent a welcome variation to the speed events. In the latter were entered Frank Sibley's Berg, H. R. Lounsbury's Worthington

and Richard Newton's Autocar. In the first gymkhana event the contestants were required to place their cars at the starting line and retreat themselves to a position thirty feet back of them. When the starter's pistol was discharged they dashed forward, jumped into their machines, started them and drove one mile around the track, circling a hurdle at the three-quarter post and another at the $\frac{7}{8}$ -mile mark. The first contestant to finish was credited with five points, the second with three, and the third with two. This was won by H. R. Lounsbury.

In the next heat the contestants made a quarter-mile dash and brought their cars

found that Mr. Lounsbury's Worthington had won with 14 points, Mr. Sibley's Berg being second and Newton's Autocar third.

In the regular races Hawley, in Thomas's Mercedes, won the ten-mile challenge race in 10:40, Harkness' car breaking down after going a few laps.

Joseph Tracy captured the one-mile open for cars costing \$2,500 to \$5,000. He drove the Royal finishing first in 1:19, with C. R. Greuter (Matheson), second, and H. R. Lounsbury (Meteor), third.

There were five starters in the five-mile open handicap, ranging in power from Thomas's Mercedes to Newton's Autocar. The four minutes' handicap given the Autocar could not be overcome by the back markers, and it won in 8:09 15, with Tracy (1 minute), a close second in the Royal and Hawley (scratch), third, in Thomas's Mercedes, in 5:23 3-5.

The mile open for cars costing \$650 and less went to R. G. Howell (Olds) in



AUTOMOBILE AND HORSE-DRAWN VEHICLES INDISCRIMINATELY PACKED AT TRACK.

to a stop as close as possible to the tape. Three points were credited to the car that stopped with the front wheels just forward of the tape, which was again Mr. Lounsbury's, and three points and two points respectively to the next two nearest.

Then came a mile circuit of the track during which women passengers carried glasses filled with water, the one who arrived with the most liquid in the glass getting the most points. This was won on a fluke, by Mr. and Mrs. Newton. No time limit having been set, their Autocar was driven around the course at a leisurely gait, while the others made a dash of it.

The gymkhana contest ended with a quarter-mile dash, during which women passengers were required to put on hats and veils. This was won by Frank Sibley's Berg, Miss Corey showing up at the tape after the dash with her hat on straight and veil becomingly adjusted—a result in no small measure attributed to a mirror carried in the car. However, when the points won by each car were added up, it was

2:20 2-5, with F. Tobias (Olds), second, and W. H. Parker (Olds), third.

The day's program concluded with a woman's mile match for electrics, in which Mrs. C. C. Miller and Mrs. A. L. McMurtry competed with Waverley runabouts. Mrs. Miller won by nearly a quarter of a mile in 3:06 3-5.

On Friday the scene shifted to Spring Lake, twelve miles south on the beach, where straightaway races were held on Ocean road over a course supposed to be a kilometer long, but which had not been surveyed. These resulted as follows:

One kilometer for cars costing \$650 to \$1,000—Charles Howard (Pope-Hartford), first; Harrington Sickles (Cadillac), second; won by 200 yards; no time taken.

One kilometer for cars costing \$1,000 to \$2,500—S. G. Davis (Franklin), first; E. H. Stegge (White), second; time, 1:00.

One kilometer for cars costing \$2,500 to \$5,000—Joseph Tracy (Royal), first; H. R. Lounsbury (Meteor), second; won by a length in 1:00.

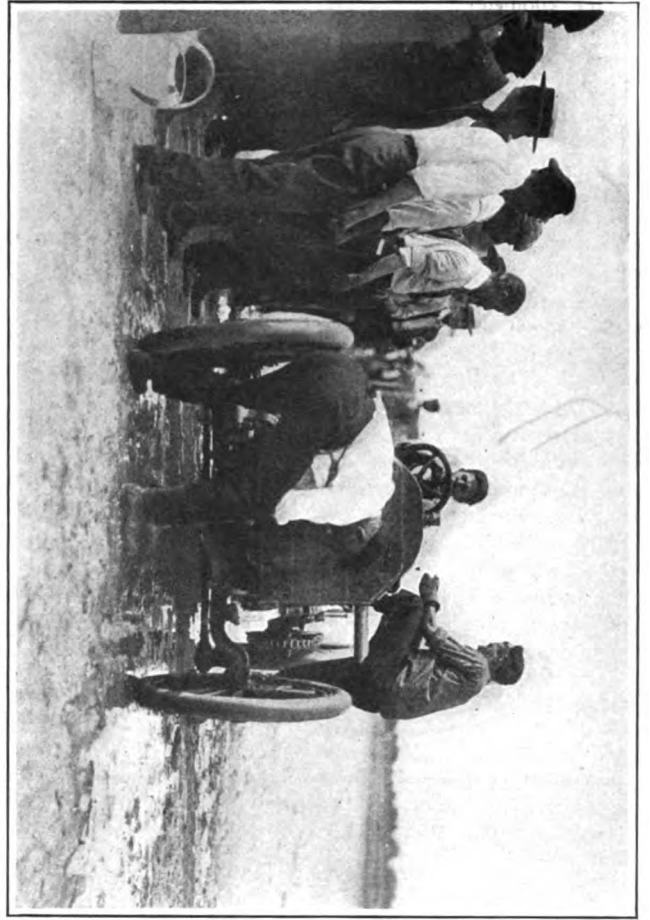

Cranking Engine of Mercedes Car Preparatory to Starting in a Race.

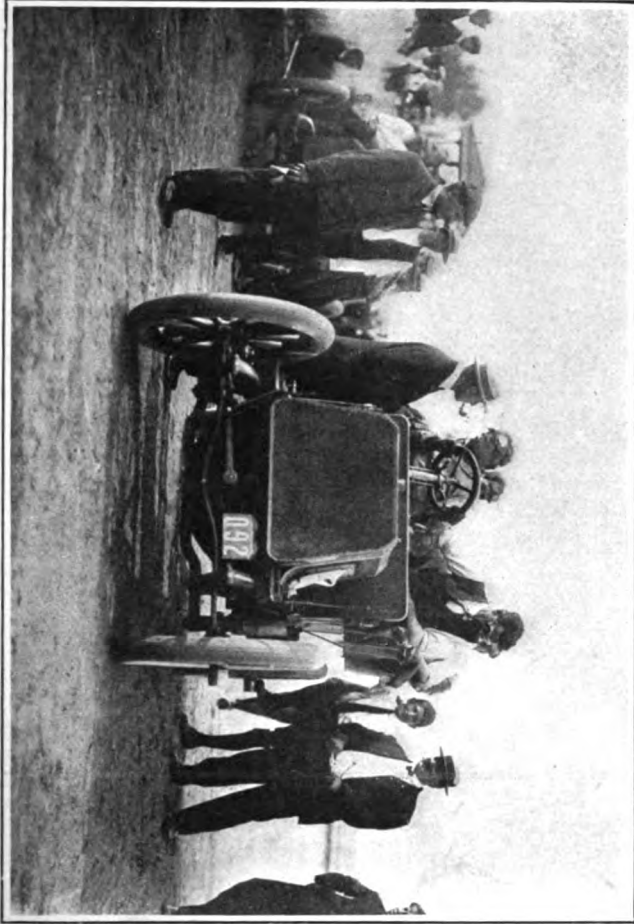

C. R. Greuter in Matheson Car, Winner "Pick-Up" Race, Wednesday.
SOME OF THE SUCCESSFUL CONTESTANTS IN THE RACES DURING THE AUTOMOBILE CARNIVAL AT LONG BRANCH LAST WEEK.

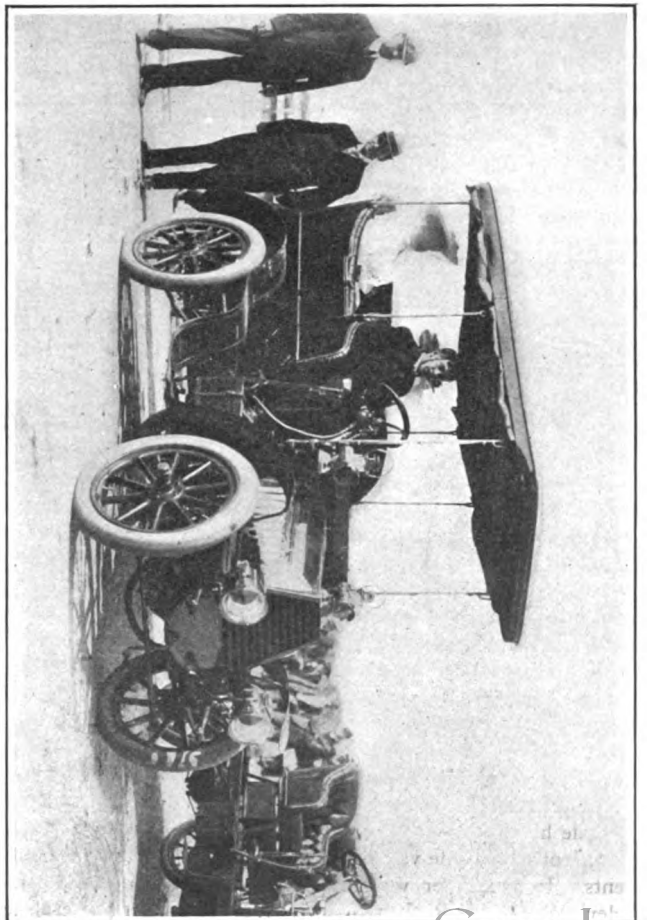

Miss Corey in Frank Shibley's Berg, Winner of the "Millinery Contest."

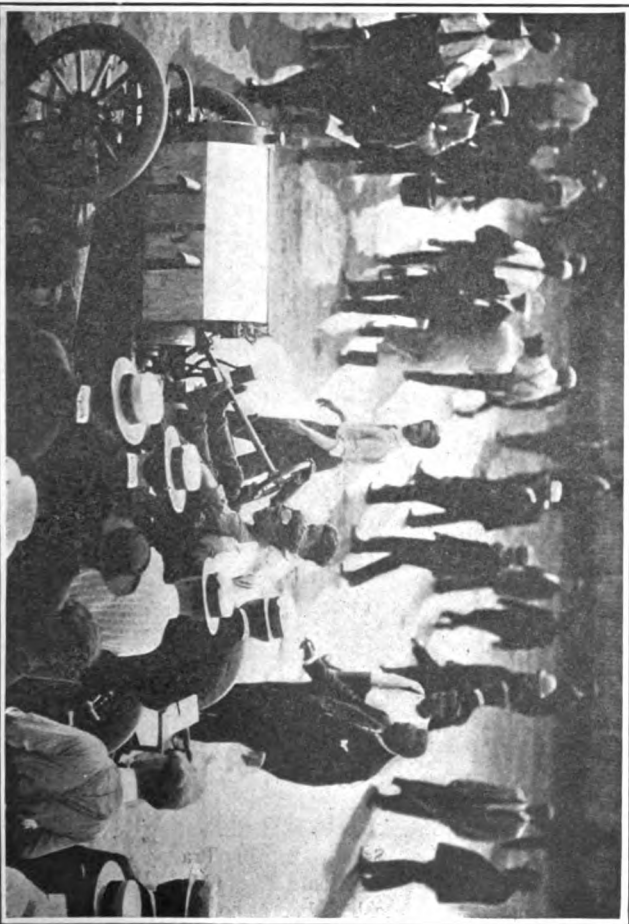

H. S. Hartness' Mercedes Just Coming to a Stop.—Hartness at Center.
H. S. Hartness' Mercedes Just Coming to a Stop.—Hartness at Center.

One kilometer free-for-all—E. H. Hawley (Mercedes), first; B. M. Shanley (Mercedes), second; time, :42.

About seventy-five automobiles took part in a parade that preceded the racing. First prize for the most attractively decorated car was awarded to Samuel E. Wells, of New York, whose Winton touring car was covered with red gladioli and hydrangeas, the young lady passengers being dressed in white and a small boy dressed in red to symbolize Satan, sat on the motor bonnet.

Second prize was given to Col. James M. Schoonmacher, of Pittsburg, whose Packard was hidden in ferns and ivy, and in front of which floated a mammoth butterfly, fluttering ribbons being held by Mr. Schoonmacher's youngest daughter, who was one of a half a dozen little girls dressed in white.

Miss Ryker, of New York, took first prize in the runabout class, other prize winners being Mrs. Zacharias, of Asbury Park, and Mrs. Samuel Highlander and Dr. W. G. S. Shaffler, of New York.

Carnival week concluded to-day with a parade here in Long Branch, where a number of cars were handsomely decorated. The procession moved through the principal streets and was reviewed at the grandstand at the track.

The exhibition of American and foreign cars at the Casino, which was visited by thousands, closed Saturday night.

During the whole week of the carnival Sidney Bowman's non-stop Clement-Bayard car was the center of attraction along the road between Long Branch and Spring Lake. After the second day it was always recognized in the various towns through which it passed by the smiles of the summer girls and the yells of the youngsters. The car covered a distance of 2,055 3-5 miles in 112 hours and 44 minutes.

The observers included newspaper men, tradesmen and residents of Long Branch.

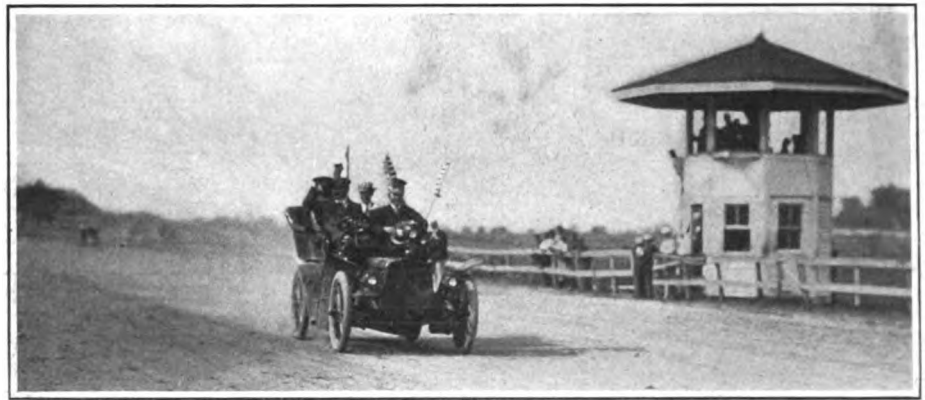

CLEMENT-BAYARD CAR ON THE TRACK AT LONG BRANCH DURING NON STOP-RUN.

At all times the operators were willing to carry extra passengers, and a trip over the route in the car was one of the diversions of the week for the visitors to the

ber of places he narrowly escaped falling into washouts.

On Friday afternoon while passing along the Ocean Drive at Asbury Park a little girl ran directly in front of the machine, and in throwing the brake on the operator stopped the engine. He immediately jumped out, however, and started it again, it is claimed, without any delay. The car was fitted with Continental tires, which even after it had been run back to New York over the roads showed little wear. During the week the tires received two punctures.



DECORATED CAR IN THE FLORAL PARADE.

carnival. During the severe storm of Friday night, when one of the heaviest rain-falls of the season occurred, the car was driven by Clavis Bertrand, and in a num-

PROVIDENCE MEET, SEPTEMBER 10.

Special Correspondence.

PROVIDENCE, R. I., Aug. 22.—Secretary Elliot Flint, of the Rhode Island Automobile Club, has announced the program for the race meet to be held under the auspices of the club at Narragansett Park track, Saturday, September 10. The meet has been sanctioned by the A. A. A., and rules of the association will govern.

The schedule of events as announced is as follows:

Ten-mile, free-for-all; no restriction; five-mile, open, steam cars only; five-mile, gasoline cars, 1,432 to 2,204 pounds or more; five-mile, gasoline cars, 881 to 1,432 pounds; five-mile, gasoline cars, 551 to 881 pounds; speed trials.

Entries will close Thursday, September 8. Full particulars can be obtained from Secretary Elliot Flint, Crown Hotel, Providence.

DELAWARE RIVER LAUNCH RACES.

Special Correspondence.

PHILADELPHIA, Aug. 22.—A special race for auto-boats over a measured course of nine nautical miles on the upper Delaware River will be held Saturday, Sept. 10, by the Riverton Yacht Club. The race will be a handicap, open to all power boats propelled by gasoline engines. Classification and handicaps will be under American Power Boat Association rules, and all boats will receive their handicaps at the start of the race, the boat with the lowest rating starting first. The club contains quite a number of motor boatmen, and an effort will be made to secure the entries of the numerous unattached owners in and around this city.



WOMEN JUDGES IN THE GYMKHANA EVENTS AT LONG BRANCH AUTO CARNIVAL.

Correspondence

Runabout Trip to Beulah.

Editor THE AUTOMOBILE:

Sir:—We left Pueblo Sunday morning, July 10, for a week's sojourn in "Beulah the Beautiful." A delightful trip of two hours and a half, over a fairly good road, gradually rising higher and higher until we dropped over Rock Creek and Beulah Hills, brought us to Beulah, Colorado, the coming summer resort of the State.

The town of Beulah, which is scarcely more than a hamlet with four or five stores and as many rustic hotels, is thirty miles southwest of Pueblo in the midst of scenery so lovely that no pen picture can do it justice.

One of the best features of this place is the beautiful pine timber with which the hills are covered, and the health giving odor of the pine needles fills the air, making deep breathing a pleasure as well as a benefit.

Wild flowers are here in abundance and there are no warning signs to keep off the grass and not to touch the shrubbery.

Nature has been very lavish with her bounty and all are free and welcome to enjoy it.

With the completion of the Pueblo and Beulah Valley Electric Railroad, now in process of construction, of course a change will take place; money will flow in, fine modern hotels will be erected and a summer resort which will outclass Manitou in some respects will be the result. Beulah has the mineral and soda spring among her many attractions and the mountain scenery is wild and picturesque. There are a number of good roads leading in different directions.

The photograph taken on the lawn of the Antlers Hotel, shows our Cadillac B., with the writer and Mrs. Thayer and son in front

and Mrs. Keeler, wife of the landlord, and her little daughter and niece in the tonneau, ready for an evening run among the hills. The marble quarries from which was taken the fine exhibit now at the St. Louis Fair, are located one and one-half miles west of Beulah.

After a very pleasant week we left the hotel Sunday, July 17, early in the morning for the return trip to Pueblo, stopping several times on the way to take pictures one of which shows the car coming up Beulah Hill at the last turn before reaching the top, Beulah Valley and mountains in the background.

The road is very steep and winds around the face of the cliff and thoroughly tests the hill-climbing qualities of a car, and I may add that the Model B. Cadillac is not deficient in this respect.

Every automobile in this part of the State should make this trip. Our visit to the delightful place will always be remembered with pleasure.

Pueblo, Colo.

W. H. THAYER.

Objections to Brass Cylinders.

Editor THE AUTOMOBILE:

Sir:—What would be the objection to using brass as a metal for the cylinder of an air-cooled gas engine in place of that commonly used—cast iron?

Has brass ever been used as a material for cylinders? If so, please tell me what are its advantages.

Akron, O.

F. E. MILLIN.

The objections to brass as a material for cylinders of air-cooled gasoline motors are that it wears faster than cast iron, and that it becomes very brittle when heated to the temperature at which air-cooled cylinders are usually operated. Brass pistons would have to be used in brass cylinders in order to get the best results. Should dissimilar metals be used for piston and cylinder, the expansion due to the heat of

explosions would affect the cylinder and piston unequally. If the piston expands more than the cylinder to which it is fitted it will rub against the cylinder walls and cause excessive friction and wear. Should the cylinder expand more than the piston, leakage on both the compression and explosion strokes will occur.

Brass rings also should be used in brass cylinders. It would be difficult, if not impossible, to give these the necessary "spring" required to ensure a gas-tight joint at high temperatures. Even though brass rings might be made with sufficient spring when cold they would immediately lose it on being heated.

Brass gas or gasoline engine cylinders have never been used commercially to our knowledge.

Two-Cycle Motors in Auto-Boats.

Editor THE AUTOMOBILE:

Sir:—In your reply to the question of E. A. B. in the last issue of THE AUTOMOBILE as to the merits of four and two-cycle motors, the statement is made that "the two-cycle motor is used almost exclusively in slow pleasure launches. H. J. Leighton's *Adios* is a notable exception to the rule in racing boats." I am personally a believer in the four-cycle type, and I expect to see it predominate before many years in the launch as it now does in the motor car, but taking boats and motors as they exist to-day, I think that the statement just quoted might well be amended to read that *Adios* represents a type rather than an individual that is the exception to the rule.

The Leighton launches are comparatively unknown about New York, but they are numerous on the St. Lawrence River; and up to the present time they hold the records for speed. As a class they are not of the "auto-boat" type, but rather strongly and heavily built service launches, used day by day about the river for fishing and



LAST TURN AT TOP OF BEULAH HILL COLORADO.



ON LAWN OF ANTLERS' HOTEL, READY FOR A RIDE.

pleasure excursions. The hulls are of white cedar, single-skin, and of the ordinary carvel build, with plain caulked seam; most of them, like *Adios*, are fully ceiled and panelled in an ornamental manner, with heavy coamings, full complement of fixed lockers, and some have a canopy top, removable for racing. The engines are of the plain, cast-iron, two-cycle type with no pretensions to the refinements of modern automobile engineering. That they are better than most if not all other two-cycle launch engines is due simply to ex-

periments. In a still smaller class, of 21 feet 10 inches length over all (the standard length of a St. Lawrence River rowing skiff), the *Kitten* and the *Pink*, each driven by a three-cylinder engine of 7 horsepower, are making very close to fifteen miles an hour.

These speeds, which are made frequently through the season and are closely approached in scrub races and ordinary running at all times, compare very favorably with the results thus far obtained by the fleet of costly and fragile "auto-boats" launched this year about New York.

There is little doubt that

"Hitting the Sage-Brush Trail."

Editor THE AUTOMOBILE:

Sir:—Sixteen and one-half days ago we left San Francisco, and as former record is thirty days, we think our time very good. Our machine has not delayed us any and not even broken a spring. The chain parted once, and we had two punctures. Since leaving Ogden we have been wandering around in Wyoming along the Union Pacific; sometimes we were on the trail and sometimes on none, but we kept thrashing the brush till we hit something, if it was nothing more than a rabbit trail. Sage hens were quite thick and at one place where we stopped over night we found

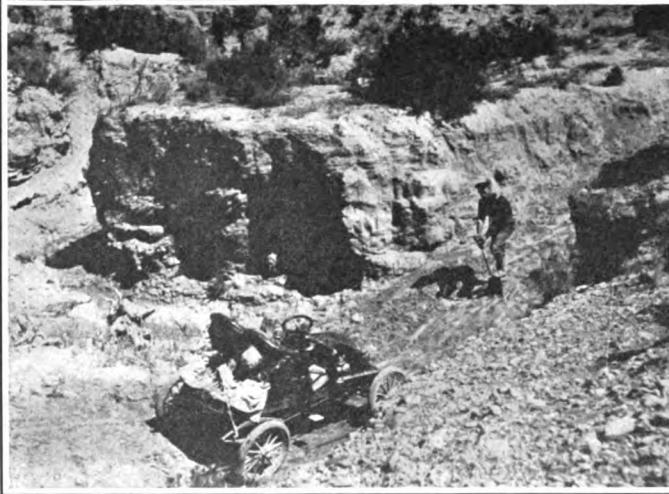
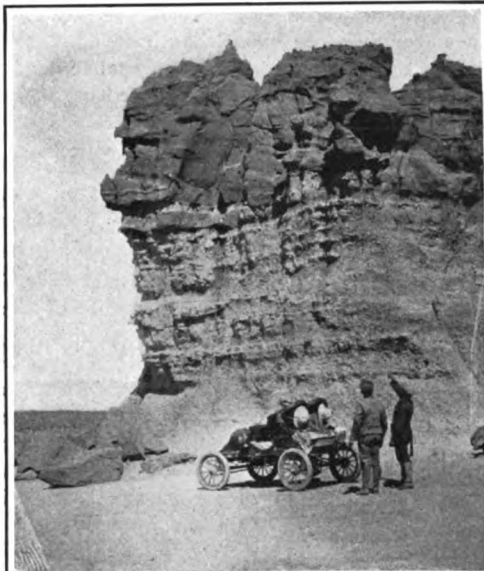

An Object of Interest on the Desert.
Making a Road for an Ascent out of a Gulch.

Pulling up at the Door of a Nevada Hotel.
Among the Majestic Rocky Mountains.

cellence of design and construction along the strictly conventional lines. Compared with the new fleet of speed launches set afloat this year, both hulls and engines are low-priced.

Adios, of 55 feet length with 120 horsepower, may be set down as a twenty-four-mile boat last year and possibly faster this season. The thirty-five feet boats, such as *Hagenena* and *Zaza*, can make from eighteen to nineteen miles, with four-cylinder engines of but 25 horsepower. One of this year's boats, *Chip*, 27 feet long and with a four-cylinder engine of only 10 horsepower, is making about eighteen miles in her first

the automobile motor and the "auto-boat" will exert a great influence on launch building within the next year or two. In order that the full measure of this expected progress may be accurately established, it is necessary that pre-existing conditions should be thoroughly understood.

W. P. STEPHENS.

New York.

Frank Selby failed to reach Bartlett for the reunion until evening on account of a couple of small wrecks to his automobile. —*Murietta (O.) Leader.*

two men that had ninety-four hens for one day's sport. All we had time to hit was chuck holes, creeks and rocks, except once we hit a snag in the road and were both shot out of the rig twenty feet—finest thing you ever saw, no bucking broncho could do better. The machine and ourselves were uninjured. Yesterday a fierce shower hit us in the Rock Mountains near Fort Collins, Colo., and delayed us on account of slippery mud.

L. L. WHITMAN.

Denver, Colo.

Patents

Cooling Device for Air-Cooled Motors.

No. 763,949.—J. C. Anderson, of Jersey City, N. J.

This is an arrangement for utilizing effectively the current of air in the bonnet, when the air-cooled motor has four cylinders arranged fore and aft. The bonnet is made air-tight at the sides, as shown

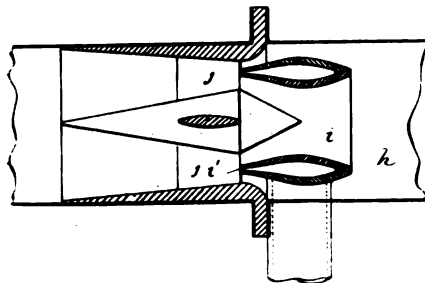
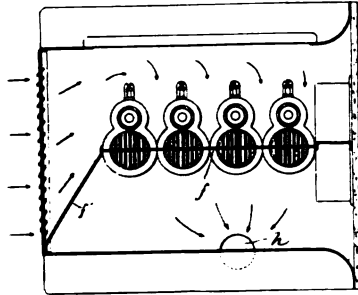

ANDERSON CYLINDER COOLING DEVICE

in the plan section, and the front is open, but with vertical slats placed angularly, and a deflector, *f*, extending from top to bottom. The air currents consequently take the direction indicated by the arrows, and they are compelled by means of a longitudinal plate *f*, which extends from the top of the bonnet down close to the radiating flanges, to pass entirely through the flanges, so that none of the air current is wasted. The bottom of the bonnet is sealed air-tight at the level of the top of the crank-case, and the air passes down through a backward-pointing pipe *h*, in which is placed an aspirator, shown in detail in the lower view, with its position reversed from left to right. The exhaust gases are led into the annular nozzle *i*, in and beyond which is the double conical annulus *j*. The exhaust gases escaping from the annular outlet *i* induce a strong current in the air of the pipe, which keeps the engine from overheating when the car is standing still.

Details of Transmission System.

No. 766,414.—L. Bollee, of Le Mans, France.

This invention covers broadly a three-point support for the motor, a three-point support for the change gear case, and a cardan shaft connecting the two, the purpose being to avoid completely any bind-

ing of shafts due to twisting of the frame. In the drawings, the crankcase is made with wings *9* and an extension *17*. The former are bolted beneath the side members of the frame, and have ends rounded on top (see *16*, in detail sketch) which, in connection with bolts and spring washers *15*, give a slightly flexible connection. Frame *17* terminates in a sleeve *11*, whose rearwardly projecting end enters a hole in a bracket *12* under the main frame. Thus *11* gives a bearing to the starting crank *13*. The gear case has projecting from one end of it the tube *19*, and at the other end are the housing *20*, under the braked drum, and the tube *21*. These tubes, resting in bearings *22*, *23* of the frame, support the gear case and give positive alignment to the bearings *27*, *28* of the countershaft. The front end of the gear box is suspended from a cross tube *10* by rod *24*, having ball joints at both ends. Between the clutch and the first gear shaft is a short shaft *30* with cardan joints at both ends.

Running Gear.

No. 766,226.—W. Dieter, of New York.

Instead of having a single set of long side springs of the character common in runabouts, there are two sets on each side, as shown in the drawing. The axles swivel in blocks *d*, which are attached to the ends of the springs in the peculiar manner shown in the detail sketch. The ends of the springs are connected by a piece *f*, in which is solidly riveted one end of the coarsely threaded screw *e*. The upper portion of block *d* is internally threaded, and is an easy fit on this screw. The intention is that as the springs straighten out under compression, thereby moving the

front axle a little forward or the rear axle a little back, the slight turning of the blocks *d* on screws *e*, owing to tilting of the axle when one wheel only is raised, will compensate for the straightening of the spring by slightly advancing or retracting

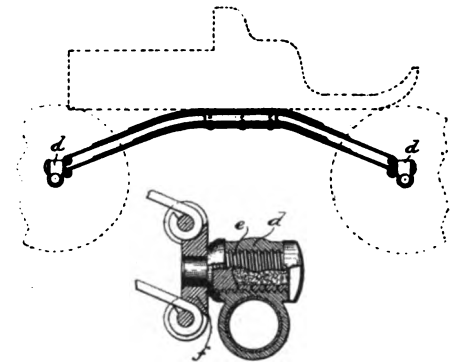

DIETER DOUBLE SIDE SPRING.

the block in such a way as to preserve the parallelism of the axles. The screws *e* are bored hollow and packed with waste, which is saturated with oil and covered by a dust-proof cap, so that the screw and block will always be lubricated and in free working condition.

Vehicle Controlling Mechanism.

No. 766,218.—J. A. Charter, of Chicago.

In this invention an individual clutch speed changing system is combined with a device for throttling the motor and retarding the spark when the clutches are released or the reverse mechanism put in action, also when the brakes are applied. Sweeping claims are made for this invention.

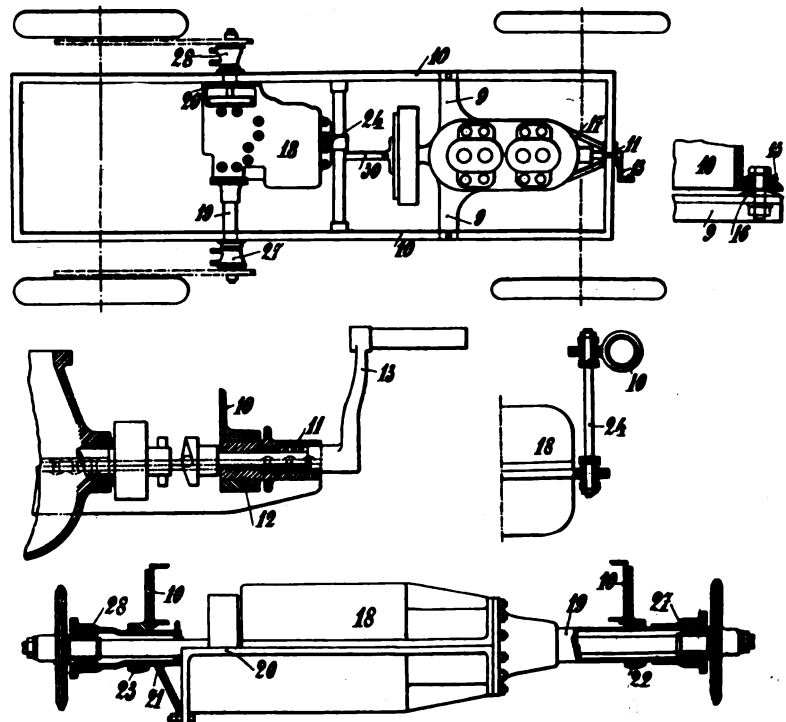

BOLLEE THREE-POINT SUSPENSION OF MOTOR AND TRANSMISSION

Pope-Tribune Runabout.

A number of novel and meritorious features are possessed by the Pope-Tribune runabout aside from its light weight, attractive appearance and low price. The frame is of angle steel reinforced by the strong framework of the body, which is bolted to the main frame. Cross members

third forward, low gear; and fourth position, nearest the dash, reverse.

Two brakes are fitted, one operating on the driving shaft, near the engine case, where the clutch is located, and the other the emergency brake, working on the differential. The regular brake is applied when the pedal which releases the clutch is depressed. The emergency brake is operated

of Hartford, Conn., is a handsomely finished little car. Fourteen coats of paint, it is said, are applied and rubbed down by hand, followed by varnishing. The color is olive green, with gold striping. Brass trimmings set off the finish. The seat is large and comfortably upholstered in leather. Under the seat and under the rear deck are storage spaces. The mud-fenders are of wood, three-ply, and waterproofed. The water and gasoline tanks contain 3 1-2 gallons each, sufficient for a run of eighty or ninety miles. The weight of the car complete is about 750 pounds.



POPE-TRIBUNE 6-HORSEPOWER LIGHT RUNABOUT.

of steel serve both to stiffen the frame and to support the engine and the transmission mechanism.

The motor is carried under a small hood in front. It is one of the vertical, single-cylinder or De Dion type, the cylinder being air-cooled, while the head is provided with a water jacket. The circulating system comprises a small tank, a tube and disc radiator in front and a belt-driven rotary pump. The flywheel of the motor is divided and enclosed in an aluminum crankcase that is oil-tight, the splash system of lubrication being employed. With a 4 by 4 inch cylinder the motor is rated at 6 horsepower at 1,200 revolutions per minute. The flywheels are balanced to reduce vibration and equalize wear of the bearings. The bearings are of phosphor-bronze and tool steel, ground to a perfect fit and the latter hardened.

The motor is set with its shaft fore-and-aft, and transmits power through a propeller shaft with two universal joints to the change-speed gear, the casing of which is attached to the differential gear case by four bolts. Both the change-speed and differential gears are completely enclosed and run in oil. The change-speed gear is of the sliding type, giving two forward speeds and reverse. Spur gears are used in the differential. The carbureter is of the float-feed type, and is fitted with a throttle. Jump spark ignition is used, the spark lever being placed conveniently on top of the steering wheel. Just to the left of the steering wheel column is the speed-changing lever. This has four positions: Rear, high speed; second forward, neutral;

by a foot lever on the right hand side of the steering wheel column.

The wheelbase of the car is 65 inches, and the tread standard. The wheels are of wood, 28 inches in diameter, shod with 2 1-2-inch detachable tires. The front wheels run on ball bearings. The front axle is of heavy steel tubing, strengthened by the novel plan of driving into it a flat steel bar standing edgewise. The rear axle is also of steel tubing, with the solid steel driving axle running through and working



FIG. 1.—COLUMBIA MARK LX ELECTRIC RUNABOUT.

in ball bearings, and is well trussed. The springs are three-quarter elliptic, so that distance rods are not required.

The Pope-Tribune, which is built at Hagerstown, Md., by the Pope Mfg. Co.,

Columbia Mark LX Runabout.

In the Columbia electric runabout, Mark LX, the Electric Vehicle Co. has shown that the principles found to give success in gasoline and steam vehicle design are applicable to electric vehicles as well. Instead of being attached directly to the rear axle, as in most electric vehicles, the motor is hung from the body, and a single gear reduction is provided in the motor casting itself, as photograph shows. From the sprocket pinion on the large gear shaft a chain runs back to the rear axle. No underframe is used. Instead, the body rests on four long semi-elliptic springs, pinned to brackets at their front ends and shackled at the rear. The rear axle is shown in Fig. 3, from which it will be seen that the differential and large sprocket wheels are almost entirely enclosed. The former has four bevel pinions, and the axle shaft runs in four American roller-bearings. The brakes operate on the rear wheel hubs, and are of ample power.

The weight of the battery is about 550 pounds, and the total weight of the vehicle 1,300 pounds. The motor is rated at 3½ maximum brake horsepower, and the Exide

battery has twenty cells, distributed between two trays at front and rear. It has a capacity of 120 ampere-hours at the 30-ampere rate, which is about the normal current of the motor. The runabout is rated to travel

forty miles on one charge, on level asphalt, this being the standard for mileage rating. The bearings are self-oiling, in accordance with the latest street railway practice. They are packed with wool waste, which is to be kept well soaked with oil.

The controller gives three forward and two backward speeds, the high forward speed being fifteen miles an hour. On the second backward notch the vehicle develops

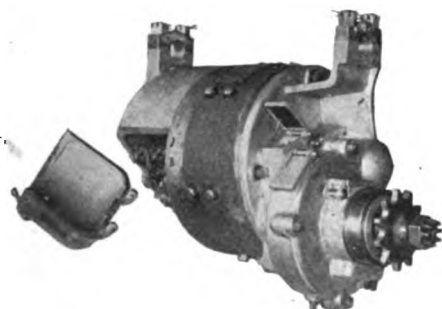

FIG. 2.—MOTOR SHOWING OIL WELL COVERS.

Rope in Place of Tires.

If a tire is injured on a run so that it cannot be repaired, and if a substitute is not available, a rope can be wound on the wheel rim and the car run slowly to the nearest repair station. Before applying the rope the car must be jacked up and the tube and shoe removed from the rim. The clamps or lugs which help to hold the shoe in place are also removed. Procure a piece of rope, of such diameter that when wound on the rim it will project above the edge or clincher and thus protect it. The rope should be long enough to wind around the rim several times, so as to completely fill the space in the rim ordinarily occupied by the tire.

Before the rope is put on a piece of wire or strong cord should be fastened securely to one end. The free end of this cord or wire is pushed through the valve hole in the rim and fastened to one of the spokes.

over streets paved with stone blocks, the rim may be ruined, if the car is driven at any but the slowest speeds.

It is well to bear in mind that the wheel which has the rope on its rim has a smaller effective diameter than the other wheels, which have tires on. Consequently if either of the rear wheels are roped as described, the differential gear will function as long as the car is moving. For this reason the car should not be driven any great distance under these conditions, as excessive wear of the differential pinions would result.

Ropes on one of the front wheels will interfere with the operation of the car only very slightly, and it may therefore be driven for a greater distance without injury than if one of the rear wheels is roped. If there are any passengers it is well to arrange them so as to have as little weight on the disabled wheel as possible.

Slow-Speed Electric Motors.

Electric motors running at low velocity and connected directly to the wheels of a vehicle without any intermediary gearing, are being experimented with by a Parisian firm, the Société Electromotion, and, according to a report from the United States Consul at Rouen, with great success. The motors are attached to the road wheels, the armatures turning at the same speed, and the motors may be placed either on the front or rear wheels, or on all four. The inventor claims that, other things being equal, his motors will give a carriage a mileage of from 20 to 30 per cent. more than vehicles with geared motors.

It is evident that there should be a total absence of noise in a well-built vehicle of this sort, but in order to get sufficient power from motors running at such slow speed it is necessary to make them considerably heavier than high-speed machines, which would probably more than offset the slight saving in weight resulting from discarding the usual gearing between the motors and road wheels. The French firm made trials with a comparatively imperfect equipment built for experimental purposes, but the results are said to have been most satisfactory. Five forward speeds were provided, and there was a total absence of jar and noise. The motor wheels are said to be very clumsy in appearance, but this could easily be overlooked if the arrangement equalled the expectations and claims of the inventor in other respects.

Anxious to test the law compelling vehicles to take the right-hand side of the road, a young man in New York recently ran his automobile for two or three blocks on the wrong side. His test was most successful, for he was taken before a magistrate and fined \$10.

County School Superintendent George W. Conn, of McHenry County, Ill., has invested in an automobile with which he now visits the rural schools of his county.

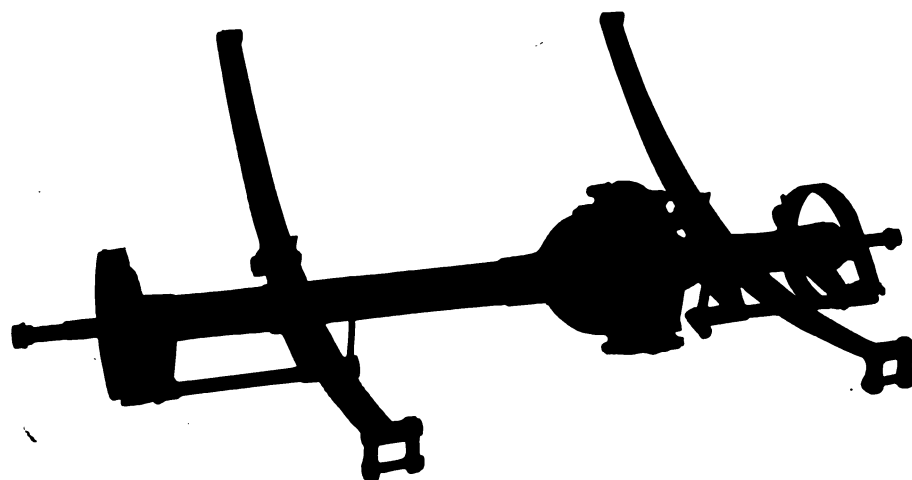

FIG. 3.—REAR AXLE ASSEMBLED, SHOWING BRAKES AND SPRINGS.

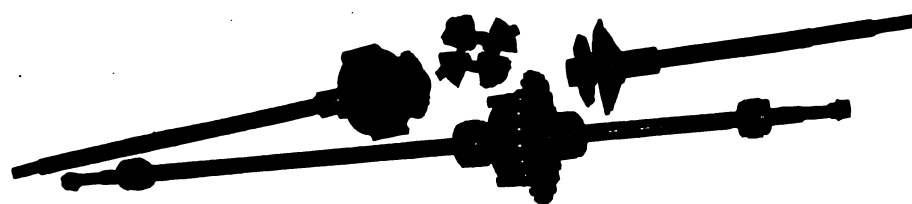

FIG. 4.—DETAILS OF REAR AXLE SHOWING FOUR-PINION BEVEL DIFFERENTIAL.

its pulling power, although not its maximum reverse speed, and this enables the operator to back out of any unusual depression in the ground. It also avoids the trouble experienced in turning around on narrow roads with ditches on both sides.

The wheelbase is 64 inches, and the tread 48 inches. The wheels are 30 inches in diameter, front and rear, with 2½-inch double tube tires.

Andrew Kendall, of Bluffton, Wis., has filed a petition in bankruptcy, in which he claims that most of his liabilities are for money borrowed to repair an automobile, the machine originally costing \$600, while more than \$2,000 has been expended in repairs.

After one of its ends is thus secured, the rope can be wound on the rim. Care should be taken that the rope is wound on as tightly as possible. To do this an assistant will be, usually, required, who should turn the wheel slowly while the rope is laid on under tension. The other end of the rope is now secured by means of a piece of wire or cord, passing through one of the clamp holes and fastened to a spoke, as already directed.

After the car has been lowered down and the jack taken away, the motor may be started and the car driven slowly to the nearest repair station. When driving a car having ropes on a wheel rim as described, great care is necessary. When passing over car or railroad tracks, or when passing



VOL. XI.

No. 8

Published every Saturday by

THE CLASS JOURNAL CO.,
Flatiron Building, Madison Square,
NEW YORK CITY.

Cable Address - - - Autoland, New York
Long Distance Telephone - 300 Gramercy, New York

SUBSCRIPTION RATES:

United States, Canada and Mexico, - One Year, \$2.00
Other Countries in Postal Union; - One Year, \$3.00

To Subscribers—Do not send money by ordinary mail.
Remit by Draft, Post-Office or Express Money Order,
or Register your letter.

FOREIGN SUBSCRIPTION AGENTS:

ENGLAND:—Iliffe & Sons, Limited, 3 St. Beke Street,
Ludgate Circus, London, E. C.

FRANCE:—Boyveau & Chevillet, 22 Rue de la Banque,
Paris.

GERMANY:—A. Seydel, Mohrenstrasse 9, Berlin.

To Advertisers—Copy or changes in orders for advertisements should reach us not later than 5 o'clock p. m. Monday for the issue of Saturday following.

Copyright, 1904, by The Class Journal Company.
Entered at New York, N. Y., as second-class matter.

The Automobile is a consolidation of The Automobile (monthly) and the Motor Review (weekly).

Copies Printed This Issue, - - 12,000

“ “ Since Jan. 1, - 421,800

A Chance for the Scorchers.

Among the many useful things demonstrated by the St. Louis tour, we venture to submit that it has proved the necessity of an American road race. Nothing less than an out-and-out race, and a long and hard one at that, will satisfy the inward cravings of the many trade representatives on the tour who, when they got the chance, raced *sub rosa* with all their might, and, when they got to their destination a couple of minutes before or behind the other fellow, blandly denied that they had raced—really raced—at all; at the same time hinting that the reckless devil in the other machine had driven her wide open through chuck holes and ruts, and had scared a dozen horses within an inch of their lives.

Now, that isn't sportsmanlike, and the chances are much against either assertion being true. Nevertheless, it became so common an incident in the latter half of the run as to compel the inference that all these men, each with the very finest car America could produce, were simply spoiling for a chance to have it out with each other in a formal race, the crown to the victor and devil take the hindmost. But here is the Vanderbilt Cup race, the very chance for which they were yearning, within less than two weeks of the time of closing entries; and the only American concern so far entered is one whose cars didn't

race at all in the tour! Amazing situation! Can it be that the admirable self-restraint with which these d'Artagnans of the steering wheel credited themselves in the tour was at bottom due to the suspicion that a real race might strain their machines? Of course not—never, no, never:—and yet how horribly uncomfortable some of them must feel, inactive with the world looking on and wondering just what is the reason after all.

Speaking seriously, is the international character of the Vanderbilt Cup race really a sufficient reason for our builders, with all the advantages of locality in their favor, surrendering the trophy to Europe without a struggle? Grant that we have nothing in the same class as the 1904 Gordon Bennett racers: the whole world knows that already, and in the cup race we can at least try out our own machines under road conditions instead of in worthless track contests. No one whose knowledge of automobiles is worth anything, and no publication in the field, will refuse to give the American cars credit for the best showing they can make in their own class. We may wish that the race had been made an American affair instead of international; we may regret that a horsepower limit was not imposed to confine competition to touring models; but at present the race is the best we have, and it is our only chance for a speed contest on the road. To have only a corporal's guard of American contestants for it would be humiliating in the extreme.



Horses and the Automobile.

A correspondent who lives in a small town in Pennsylvania, who only recently joined the ranks of automobilists, writes us that he has become thoroughly discouraged on account of his troubles with frightened horses. With the best of intentions he purchased a light touring car and on his very first trip with a party of friends, to whom he wished to exhibit the good qualities of the car, he caused a runaway accident. He noticed the horse attached to an approaching carriage acting in the excited manner that frightened horses usually adopt, and he stopped his automobile. Nevertheless the horse "turned short around, tipped over the carriage, and threw out the driver and a little child and scattered the carriage along the road for about half a mile." In this case the damage was entirely to property. Since then, however, he has spoiled the outings of several ladies in the town, who were accustomed to take a daily drive, but who now do not dare venture out in their carriages because of the red devil.

The situation, though unusual, is not the first of its kind, and our correspondent's plight is doubtless the same as others who do not write. He is really only having the experience common to all pioneers. It falls to their lot to educate their public. It was so with the original railway pioneers and with the early trolley car builders. There

is, however, some compensation in the knowledge that one is a pioneer, a herald of progress in a community which, later, when it comes to appreciate the splendid usefulness of the automobile, will freely give our correspondent the credit for its introduction by his practical example.

We judge from his letter that he is a good-hearted fellow, perhaps a trifle super-sensitive. He should recollect that he has right on his side, that the use of the road is for all citizens and all rational means of transit and that it is up to the other road users quite as much as himself to take measures to prevent runaways.

While standing squarely on his rights, we suggest that he propose to the neighboring owners of horses that they take time off and with his co-operation get the horses accustomed to the automobile. The demonstration can be carried on on the nearest wide road. The horses can be driven slowly past the machine when standing and also when in motion. Just as necessary will be the education of the drivers to the certainty and safety of the automobile. Let him take each horse owner out for a demonstration and then they will lose that fear that is founded largely in prejudice, and will not communicate it to the fool horse when they are driving on the same road with the automobile.

Our correspondent will be surprised at the good results of some patient missionary work, and by showing a considerate spirit will soon turn fear into friendliness.



Touring Car Body Needed.

From the report elsewhere in this issue of interviews with two well-known French carriage builders, it may readily be inferred that the automobile in France has passed through the sporting phase of its development, and by the larger number of its users is now regarded as a vehicle of utility. That this should occur has from the first been recognized as inevitable, and most desirable as well; but it is apparent at once that utility in this case does not mean simply commercial utility. There is an immense field for the automobile in touring, and here at least this field has yet been hardly scratched. But we still lack the right body design to encourage this sort of utility. In France the closed car is temporarily the most popular for touring, on account of the protection it affords from dust and rain. The closed car, however, while ideal for wet weather, is by no means ideal for such weather as the sensible tourist generally prefers. If not too hot, at all events it restricts the view; and when one is touring at twenty miles an hour he must have a good outlook if he is not to miss something.

To meet this situation various combination bodies, partly open or with folding tops, have been devised, few of which have yet been seen on this side of the water. Some are based on the canopy top, others

on the landaulet, limousine, or victoria. All of them are compromises, and will probably undergo numerous changes before final types are evolved. What seems to be needed is a cover combining the folding feature of the Cape cart hood with the rain-tightness of the regular closed bodies; but certainly it is hard to say just how we shall come by it.



The news item on another page of this issue, reporting the unusually consistent running of one of the competing machines in the recent Buffalo race meet, is worthy of notice from the statistical evidence it gives of the pitch of perfection to which the best American machines have been brought. Generally speaking, it is easier to make a single or double-cylinder car perform with exact regularity than a four-cylinder, and when the makers of the particular car referred to were building single cylinder cars it was for the avowed reason that one cylinder was less troublesome than more. But practice makes perfect. We have had various examples of consistent running in some of the French racers brought here, and it is pleasant to be able to prove that America has cars in the same class.



E. Noceti, Calle Peru, 521, Buenos Aires, Argentine Republic, writes that he wants to secure the agencies for American automobiles and accessories. Manufacturers who are interested will please write to him direct.

A chauffeur who took his friends for a midnight ride in his employer's automobile has paid for his sport with his life, while his friends, though not seriously hurt, were painfully scratched and bruised. The victim was Charles H. Reilly, of East Orange, N. J., who was employed as night watchman at the garage of Frederick L. Knapp, at 440 Main street, East Orange. When leaving the garage at about 9 o'clock on the evening of August 11, Mr. Knapp told Reilly to close up as soon as all the cars were in, and went home. Shortly after midnight, however, Reilly invited two friends to go for a ride with him, and later on a third was picked up. After visiting several saloons, the party started to return to the garage. In making a turn into a cross street at Vailsburg, Reilly, who was handling the car, did not cut down his speed, but tried to turn short while running rapidly. The car upset, throwing all but Reilly clear. The unfortunate driver was pinned under the steering wheel, and so seriously injured that he died later at a hospital. His companions were arrested and held in \$500 bail on the charge of stealing the machine, to which they pleaded not guilty, stating that they simply accompanied Reilly at his invitation. The man who was picked up on the way said he got in because he thought Reilly was too drunk to handle the machine properly.

The matter of awarding certificates to entrants in the St. Louis tour whose records, though not technically perfect, were still so good as to deserve special consideration, will be taken up at the next meeting of the Board of Directors of the American Automobile Association on Tuesday, September 6.

FRENCH BODY BUILDERS TO OPEN AGENCIES.

Representatives of Rothschild and Kellner Concerns Arrive in New York on Their Way to World's Fair and Discuss Their Business Intentions—Styles in Bodies.

M. Léon Auscher and Georges J. Kellner, members respectively of the celebrated French carriage building firms of J. Rothschild & Cie. and J. Kellner et des Fils, are stopping for a few days in New York, on their way to St. Louis, where they are to serve on the international jury of awards in the automobile section. M. Kellner, who is president of the Chambre Syndicate des Carrossiers, heads the list of French members of the jury, the remaining members being MM. Blin, of Malicet & Blin, G. Clément, L. Lemoine, and L. Auscher.

In the course of an interview, M. Auscher stated that his firm intends to open an American branch store, probably in October, by which it is thought that a good deal of time will be saved customers on this side. They will fit bodies to either American or foreign cars, as they will be supplied with the standard chassis dimensions of all the leading makes. They had some thought of opening a factory here, but decided against this on account of the difficulty of finding a sufficient supply of skilled labor. The manager of the new establishment, Mr. Auscher said, will be an American, but no more specific information could be given at present.

M. Kellner also confessed to entertaining some thoughts of an agency, but in his case the intention was rather to furnish bodies for foreign cars, samples of which will be exhibited with the bodies in position.

Both gentlemen declared that the tonneau has seen its best days abroad, where 90 per cent. of this year's demand is for side entrance cars, as being far more convenient and—on account of the rear axle being further back—more comfortable as well. Closed and semi-closed bodies—limousine, landaulet, and coupé models—are likewise in high favor for long tours, as well as for town use. In a word, the demand now is for comfort, speed being secondary. Ladies in particular, they said, objected to being constantly exposed to the dust and wind, and to the consequent restrictions on costume.

VANDERBILT CUP RACE.

Permission of Authorities to Use Course on Long Island is Obtained.

The course for the Vanderbilt Cup race has been selected and the Board of Supervisors of Nassau County, L. I., have granted the necessary permission for the contest, which means that, for the purpose of the race the road will be ruled and governed by the race authorities. The pumping station on the Jericho Road will, barring changes of plans, be the starting point, and the course will take a triangular form, leading through Westbury, Queens, Jericho, Hicksville and Hempstead. The total length of the course is 32 1-2 miles, and the racers will cover the ground ten times, finishing at Hempstead. The roads are, almost without exception, excellent, and though there are some rather sharp turns, it is expected that fast time will be made when the contestants come together on October 8.

American entries for the great event are still in the background, though entries will

not be received after September 8. The only American machines actually entered are the two White steamers entered by Webb Jay and Rollin T. White. William Wallace, of Boston, is to drive one of the Gordon Bennett F. I. A. T. machines, and the Automobile Club of Turin, Italy, has sent an official endorsement of his entry. Alfred Vanderbilt and Harry Harkness have expressed their intention of entering their 60-horsepower Mercedes cars, and two Panhards have been entered by the local agents for that machine. A Pope-Toledo entry is also expected, as well as one or more F. I. A. T. cars of the regular touring type. There is a rumor that the formidable Jenatzy will come over with a powerful Mercedes car to represent Germany, but this has not been confirmed.

CAMPAIGNING BY AUTOMOBILE.

Special Correspondence.

MILWAUKEE, Wis., Aug. 22.—A two-cylinder, 20-horsepower Winton touring car will be used by Gov. LaFollette, of Wisconsin, in conducting his campaign for re-election this fall. The car was formerly owned by Louis Allis, of the Allis-Chalmers Company here. It will comfortably seat five persons, and has been fitted with a new canopy top and with extra strong lamps, and it is expected that this week will see the Governor and his retinue well along on their novel tour of the farming districts. The automobile campaign scheme is said to have originated with Attorney Henry F. Cochems, of this city, one of Gov. LaFollette's right-hand men. Mr. Cochems is to accompany the executive on his auto stumping tour.

COLUMBUS CARS IN THE RUN.

Special Correspondence.

COLUMBUS, O., Aug. 22.—The Columbus automobilists who took part in the St. Louis run have returned well pleased with it. They were much interested in the machine driven by L. A. Frayer, of this city, a member of the party, who covered the distance from Columbus to St. Louis, approximately 433 miles, in 19 hours 7 minutes. He made the run back in two days, no attempt being made at record-breaking time. Frayer was delighted with the performance of his car, and further experiments are planned to test its speed and endurance. It was made in this city by the Lear Company, and is a 20-horsepower air-cooled machine.

T. W. Pickard and C. O. Howard, of Columbus, who were also in the run, covered 222 miles in their Imperial runabouts in one day between Greenup, Ill., and Richmond, Ind., while returning.

SAINT LOUIS RACES POSTPONED.

The automobile races which were scheduled to take place at the track in the Saint Louis Fair grounds on Sunday, August 21, and which were expected to bring out some particularly fine contests, had to be postponed on account of the heavy rain that fell during the latter part of the week, rendering the dirt track entirely unsuitable for racing. A large number of those who expected to take in the termination of the tour of the American Automobile Association and the automobile races while in Saint Louis were disappointed. The events will be contested on Sunday, August 28, if the track can be used at that time.

ARDUOUS ILLINOIS RUN.

Trip of 360 Miles Through Mud and Darkness in Twenty-five Hours.

Special Correspondence.

CHICAGO, Aug. 20.—A heavy waterspout and the bad streets of Chicago proved a combination which spoiled the attempt of one of the members of the Chicago Automobile Club to establish an official record from St. Louis to Chicago last Saturday.

Saturday morning George A. Crane, of Chicago, accompanied by his brother, Herbert W. Crane, of Milwaukee, Wis., and Robert W. Spangler, assistant secretary of the Chicago Automobile Club, left St. Louis in a 20-horsepower Knox car. The start was made from the Jefferson hotel at 4.30 a. m., the intention being to go over the

Joliet ended the official timing, as the driver got lost shortly after leaving that city. After prowling around over country roads for an hour the right road was again found, and ten minutes later it was lost again. A heavy fog had risen and the road could not be distinguished ten feet ahead, although two powerful searchlights were used. Back and forth around curves, up and down hill the car was driven, but no lights or houses could be found. There was no south, east, west or north, and the occupants of the car were utterly bewildered. The road began to get muddy and traveling was necessarily slower on this account in order to prevent skidding.

Western avenue at Morgan Park was fully six inches deep with slimy mud, and progress was hardly perceptible as the ma-

at the clubhouse, and the average time for the last forty-seven miles was about eight miles an hour.

On the entire trip of 360 miles there were no engine troubles and only one tire was pinched. Stops were made only to oil up and renew the gasoline.

New York News.

The report that an automobilist named Simon Kameski was shot from an ambush near Worcester, Mass., was investigated by Secretary Butler of the Automobile Club of America and found to be to a great extent a "hot air" story. A man of that name was shot while driving a wagon, but his injury was very slight, having probably been caused by a pellet from a "pea-rifle" in the hands of a small boy. No automobile or automobilist figured in the affair in any way whatever.

* * *

There are still things doing in Lawrence, L. I., in connection with the automobile trap that was laid near there recently. Frank L. Tyson, the newly appointed police justice who attended to the business of fining the automobilists who were caught, has been summoned to appear before Supreme Court Justice Dickey in Brooklyn on the complaint of William Willard, Jr., counsel for L. B. Sharp, of Far Rockaway, who was arraigned before Tyson charged with speeding his automobile and held in bail to appear later. Lawyer Willard charges that Mr. Tyson's appointment was irregular, as he had not been a resident in the county long enough to qualify for the position. The yearly salary of the police justice of Lawrence is \$100, in addition to fees.

* * *

The old, old story of hunting for a leak with a match was the cause of an automobile fire at 127th Street and Seventh Avenue, New York, on August 21. The motor of the car refused to go and someone struck a match to see if the gasoline had leaked out. The leak was immediately found, and a wise genius carrying a pail of gasoline was so interested in the spectacular discovery that he moved up closer and the flames promptly laid hold on the contents of his bucket. The fire was extinguished just as the firemen arrived with their apparatus, and the automobile will probably be none the worse for the experience after new paint has been applied.

* * *

Secretary Butler, of the A. C. A., has discovered that the man who fired a charge of buckshot at an automobile near Hammondton, N. J., two weeks ago, was Antonio Larro, an Italian farmer living near Elm. A warrant was issued for the man's arrest, but it was then found that he had disappeared, whereupon Mr. Butler promptly offered a reward of \$500 for his apprehension. A vigorous campaign will, Mr. Butler states, be instituted by the club against the senseless and lawless but increasing persecution to which automobilists are being subjected.

* * *

The Brooklyn (N. Y.) Ferry Company now refuses to allow its employees to push automobiles on and off ferry boats on account of the delay thus occasioned, demanding that the automobiles be towed. This means many an odd dollar for the teamsters, who are quite pleased with the arrangement, as their services will be in demand. Even the occupants of automobiles will not be allowed to push the machines for the same reason.

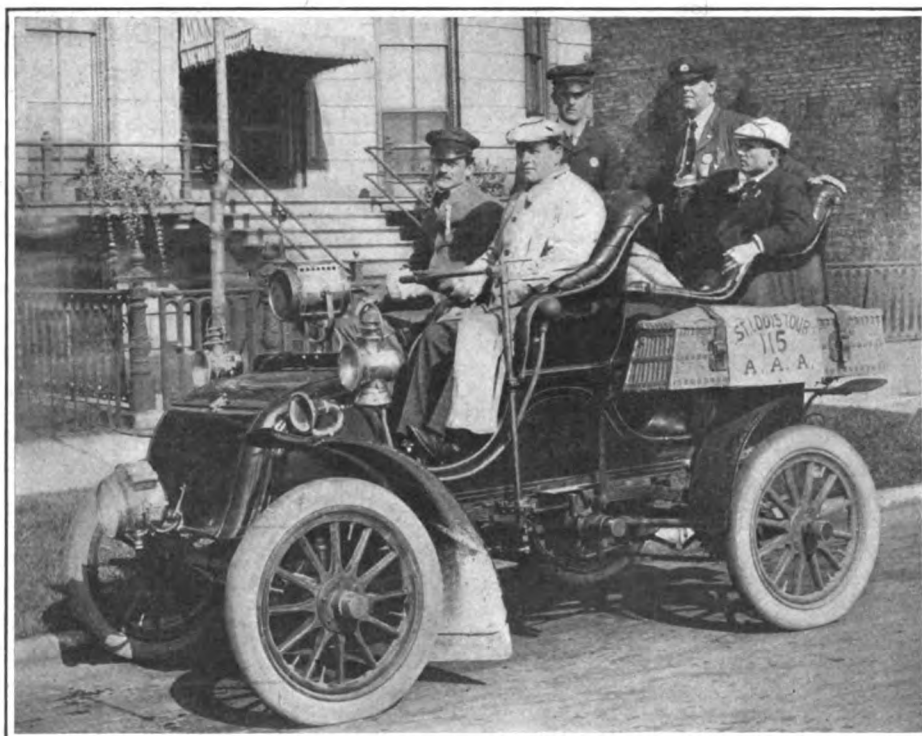

GEORGE A. CRANE AND PARTY WHO MADE ST. LOUIS-CHICAGO CONTINUOUS RUN

A. A. A. tour route which had been covered by the car during the first three days of the week. This program was adhered to for about fifteen minutes, the first mishap being the losing of the way. Probably an hour was lost during the day in inquiring the way and doubling back to find the right road. The road to Springfield was fairly good, and that city was reached at 10.35 a. m., the distance being 113 miles by cyclometer. Twenty-three minutes of this time was lost by a tire being pinched, making the running time 5 hours 42 minutes. Bloomington, 196 miles, was reached at 3.35 p. m., and Pontiac at 6.30.

When Joliet was entered at 10.45 a policeman stepped up and began asking questions about the run, the time and the distance. He was told that the distance was 313 miles, and it had taken 18 hours and 15 minutes elapsed time to make the run.

chine wallowed from side to side, so that every moment the occupants expected to upset in the ditch. After a mile or so of slow progress the lights went out, and there was not a match to be found. One of the party secured matches half a mile away, and with the lights again going another start was made. Slowly the car pulled through the mud, and after what seemed an interminable time the street lamps of Chicago appeared. A Burlington railroad train held the party up at a crossing for twenty minutes, and when the bumps and holes of Western avenue were finally negotiated and the clubhouse was reached it was 5 o'clock and broad daylight.

Twenty-five hours of continuous riding made a record that exceeded most of those made in the endurance run of 1903, and the trip had been as dangerous in every respect. The cyclometer registered 360 miles

AT SWORDS' POINTS OVER SHOW QUESTION.

Inequitable Division of Profits From Previous Boston Exhibitions Causes One Faction of Dealers to Try to Forestall the Other with an Earlier Show Next Year.

Special Correspondence.

BOSTON, Aug. 20.—Differences between the two factions of automobile dealers in this city growing out of the local automobile show question have been given a new turn by the proposal of the recently formed Boston Automobile Trades Association to hold an exhibition in Boston immediately after the New York show, instead of in March in this way checkmating the Boston Automobile Dealers' Association, which has the lease of Mechanics' Hall for March. The whole trouble arose over the division of show profits last March. These profits were large, and some of the larger exhibitors thought they had taken most of the responsibility and ought to have the major share of the profits. This matter, however, was finally settled, but almost immediately there was a new move which tangled up the affairs of the Boston Automobile Dealers' Association again.

It was the dealers' association that ran the shows of both 1903 and 1904. Soon after the show last spring an organization called the Boston Automobile Show Association was formed by three dealers, who obtained a three years' lease of Mechanics Hall, knowing that the dealers' association had voted to hold its show next March in that building. When the show committee of the dealers' association went to arrange for leasing the hall the show association offered to give the lease to the dealers' association for 50 per cent. of the profits.

This attitude of the show association, whose members were also leading members of the dealers' association, naturally aroused the ire of the other dealers, and they refused to take a lease on such conditions. The next move of both parties was to secure the incorporation of the dealers' association, and both tried hard to get the incorporation. The show association members, together with eight other dealers, won out, however, and a few hours before the other party went to the State House for the purpose a charter was issued to the Boston Automobile Dealers' Association, Incorporated. Kenneth A. Skinner, agent for the De Dion-Bouton and other foreign cars, was named as president, and J. H. McAlmun, of the Locomobile agency, as treasurer.

Having failed to secure the corporate name, the other dealers got together and formed the Boston Automobile Trades Association, whose plan for the show is that all the exhibitors shall share in all the profits. The officers of this organization are: President, W. W. Burk, of the Electric Vehicle Company; secretary, Alvin T.

Fuller, of the Packard and Northern agency, and treasurer, A. P. Underhill, of the Knox agency. These officers, with W. E. Eldridge, the Pope Manufacturing Company's agent, and A. R. Bangs, the Franklin agent, constitute the board of directors. The committee in charge of the show matter consists of W. E. Eldridge, Benjamin Smith, agent for the Olds, and A. P. Underhill. The association has seventeen charter members, and any bona fide Boston dealer may join and exhibit in the show on the same basis as the charter members. In short, the new organization proposes to run a show on the same basis as the previous shows have been run by the dealers' association. A circular was sent out by the association which, after announcing the organization of the Boston Automobile Trades Association and giving the officers, said:

"A committee was appointed composed of W. E. Eldridge, Benjamin Smith and A. P. Underhill, to make application for a sanction for the holding of a show. Application has been made on a blank furnished by the National Association of Automobile Manufacturers for the week following the New York show, or as soon after as possible. It was thought by everyone that the holding of a show in March kept the opening up of the business back and that an early show will be better for all concerned. * * * It is of great importance that each of the members write to the manufacturers of the cars that he represents asking them to give the application of this association for a show their sanction and active support."

As this circular indicates, the all-important thing to both the dealers' association and the trades association is the N. A. A. M. sanction, as, according to a rule of the manufacturers' association, its members cannot exhibit in any show not sanctioned by the association. The Boston Dealers' Association and the Boston Show Association, which are practically one, are relying on the standing of the manufacturers whom they represent to secure the sanction. If the sanction cannot be obtained they claim that their houses will break away, and that a separate show will be run. The trades association is also counting on getting the sanction and taking the wind out of their opponents' sails by holding a show a couple of months earlier than the proposed dealers' show. If the show cannot be held in Mechanics' Hall, Symphony Hall may be used again. The dealers' association has Mechanics' Hall for March and has behind it the agents of some of the leading makes of machines. The trades association has the larger membership and the earlier date for the show, as the dealers' association could not well hold a show before the New York show.

FAST RACING AT OMAHA.

Special Correspondence.

OMAHA, Aug. 24.—On the half-mile track of the Omaha Driving Association yesterday

afternoon Barney Oldfield twice broke the mile record for a half-mile track, first placing the figures at 1:15 2-5, and later reducing this to 1:13 2-5. The former record of 1:16 was held by Oldfield. In a five-mile competition event the only starters were Alonzo Webb and Oldfield. Oldfield won in 6:34 2-5.

"THE MOTOR PIRATE."

This is the season of the year when some motor enthusiasts having nothing better to do on a rainy day, may find entertainment in reading a new novel under the above title, written by G. Sidney Paternoster and published by L. C. Page & Co., of Boston. It is a ludicrously improbable account of the "blood and thunder" acts of the Pirate, with suspicions of a love story woven through, and bristling with odd Englishisms and ungrammatical construction.

The hero writes in the first person of his encounters with and fruitless endeavors to catch the Pirate, whom any reader with the least perspicuity knows after the first twenty-five pages is his neighbor and rival for the affections of a neurotic young girl, who, toward the end of the story, falls an easy subject to the hypnotic power of the Pirate. The villain, who is of an inventive turn of mind, reconstructs in his shop a deliberate, noisy old motor car, equipping it with a "turbine engine driven by liquified hydrogen," with which he tears about the country at speeds never less than sixty and more generally at 100 miles an hour, save when he wishes to elude capture or identification when passing through towns. At such times he removes a curious boat-shaped hood, and inverting it at the rear forms a tonneau, and, cutting off the liquid gas, resorts to the noisy old "petrol" engine.

Among the mad exploits of the Pirate are the holding up of the Brighton mail, which he robs of a package of diamonds valued at £200,000, and the holding up of "an August Person"—obviously the King—in the royal motor car. It is this last exploit that leads to his identification, however; but he is never caught, as his turbulent career comes to a timely finish at Land's End, where he deliberately dashes over the cliff into the sea to avoid capture by the author and a Scotland Yard detective, who have followed him for five hours at a pace of 80 to 100 miles an hour in his own car, which the Pirate has abandoned for a new one that he built himself. This cross country race constitutes the climax of the story, as the villain had kidnapped the heroine with his car. Of course, the heroine escaped.

In one of his rawest Englishisms the author says: "My tub pulled me together to some extent, but I still felt restless when I went downstairs." Elsewhere he writes: "When he had greeted me I had observed that Colonel Maitland's face had worn a slightly resigned expression." Early in the story he mentions a "handsome 22-horse Daimler," with which they "were running nearly sixty miles an hour."

AMERICAN AND FOREIGN AUTOMOBILE AND AUTO BOAT FIXTURES.

Aug. 22-Sept. 4.—French Industrial Vehicles Trials, Paris. A. C. of France.
 Aug. 25-28.—Del Monte Race Meet. Del Monte, Cal. A. C. of California.
 Aug. 26-27.—Race Meet, Groase Point Track, Detroit, Mich. Detroit A. R. A.
 Aug. 27.—Larchmont Yacht Club Races. Long Island Sound.
 Aug. 27.—Race Meet, Oakland Park, Denver, Colo. A. C. of Colo.
 Aug. 28.—World's Fair Race Meet. St. Louis Fair Grounds Assn.
 Aug. 29-Sept. 3.—British Small Car Reliability Trials. A. C. G. B. & I.
 Sept. 2.—Chateau-Thierry Hill Climb, France. A. C. of France.
 Sept. 10.—Race Meet, Narragansett Park, Providence. R. I. A. C.

Sept. 10.—Lake Lucerne Motor Boat Races.
 Sept. 16.—Race Meet, Poughkeepsie, N. Y., Dutchess Co. Agricultural Society.
 Oct. 5.—Dourdan Kilometer Trials. *Monde Sportif*.
 Oct. 8.—Vanderbilt Cup Race, Long Island, N. Y.
 Oct. 9.—Gallion Hill-Climbing Contests. France. *L'Auto*.
 Oct. 14-22.—Leipzig Cycle and Motor Show, Germany.
 Nov. 20.—French 100-Kilometer Trials, Algeria.
 Dec. 9.—Opening of Paris Salon. A. C. of France.

R. E. OLDS STARTS AGAIN.

Organizes a \$1,000,000 Corporation in Lansing and Will Build Huge Factory at Once.

Ransom E. Olds, who, it will be remembered, severed his business connection with the Olds Motor Works and the Olds Gas Engine Works on January 1, 1904, is to be at the head of a new company, the R. E. Olds Company, capitalized at \$1,000,000, which will build automobiles in Lansing, Mich. Reuben Shettler, of Lansing, is to be vice-president of the new company, and Edward F. Peer, also of Lansing, will be secretary-treasurer.

The automobiles to be manufactured are of entirely new design or pattern, it is said, but no information as to their features is available. A factory is to be erected in Lansing at an early date, and, pending the completion of this, operations will be started in a temporary factory in an existing building. Workmen are already preparing for the installation of machinery and making the changes necessary to adapt the place to its new purpose. All machinery will be of the newest pattern, especially adapted to the work. It is hoped that the permanent factory, the erection of which will be begun in a few weeks, will be ready for occupancy not later than December 1, and that the first automobiles will be on the market during the first days of 1905. It is expected that when in full operation the plant will employ from 900 to 1,000 men. All parts of the machines will be manufactured in the plant.

Mr. Olds is the largest stockholder in the new company and owns a controlling interest, and Mr. Shettler is the second largest stockholder. Others holding shares are Mr. Peer, Mayor Hugh Lyons, of Lansing, Elgin Mifflin, Charles P. Downey, James J. Baird, B. F. Davis, F. S. Porter, Lawrence Price, J. Edward Roe and W. H. Porter. These are all Lansing men and have taken up all the stock.

Mr. Olds believes that there is plenty of room in the automobile manufacturing business for builders of good automobiles, and states, according to the *Lansing State Republican*, that the new concern is started without the slightest idea of antagonism or hostility toward either the Olds Motor Works or any other automobile manufacturing concern. There are already several manufacturers of automobiles, including the Olds Motor Works, in Lansing, as well as manufacturers of stationary motors and other machinery, and it is said to be the ambition of Mr. Olds to make Lansing one of the largest automobile manufacturing centers in the country.

TO INVADE CANADA.

Ford Motor Company Organizes Branch to Build Cars in Walkerville, Ont.

Special Correspondence.

TORONTO, Aug. 22.—The opening of the season of 1905 will see the manufacture of gasoline automobiles on a large scale in Canada. At present all machines sold are imported from the United States, subject to a duty of 25 per cent. Prices, naturally, are high, and as the automobile craze seems to have taken hold of the Canadian public in earnest this season, with the prospect of even larger sales next year, the opening for home manufacturers is an attractive one.

Among branch factories of American concerns that will start in Canada next season is that of the Ford Motor Company of Canada, just incorporated with a

capital stock of \$125,000. This company will turn out Ford cars, the factory being located at Walkerville, Ont. The Ford Motor Company, of Detroit, retains controlling interest in the Canadian company and the manufacturing will be entirely under the supervision of Henry Ford, of the parent Company. The provisional directors are John Curry and A. D. Bowlby, of Windsor, and Merle Walker, W. L. McGregor and G. M. McGregor, of Walkerville. The stock is all subscribed.

The company is to occupy the works formerly occupied by the Walkerville Wagon Company. As soon as the charter is issued the election of officers will be held and manufacture commenced.

PIONEER SALE ENJOINED.

Director of California Garage Company Stops Transfer to President Brinegar.

Special Correspondence.

SAN FRANCISCO, Aug. 16.—Directors of the Pioneer Automobile Company of San Francisco have been enjoined from selling any of the property of the corporation at

present is worth only \$30 a share, so that the company would lose \$7,000 on this part of the transaction.

In addition to the agencies the company, which is capitalized at \$200,000, also owns the fine garage on the southwest corner of Golden Gate avenue and Octavia street, facing Jefferson Square. The building is considered the handsomest structure devoted to automobiles in the United States.

A new company, named the Auto Livery Company, has been incorporated with a capital stock of \$25,000 by Max L. Rosenfeld, H. M. Blakeslee, Eugene S. Watson, W. T. Robertson and E. E. Peabody. H. M. Blakeslee has been connected with W. A. Scott in the automobile livery business, employing Winton cars stabled in the Pioneer Automobile Company's garage.

RECENT INCORPORATIONS.

The Auto Livery Co., San Francisco, Cal.; capital, \$25,000. Incorporators, Max L. Rosenfeld, H. M. Blakeslee, Eugene S. Watson, W. T. Robertson and E. E. Peabody.

Hanson's Auto Works, Chicago; capital, \$1,500; to repair and store automobiles. In-

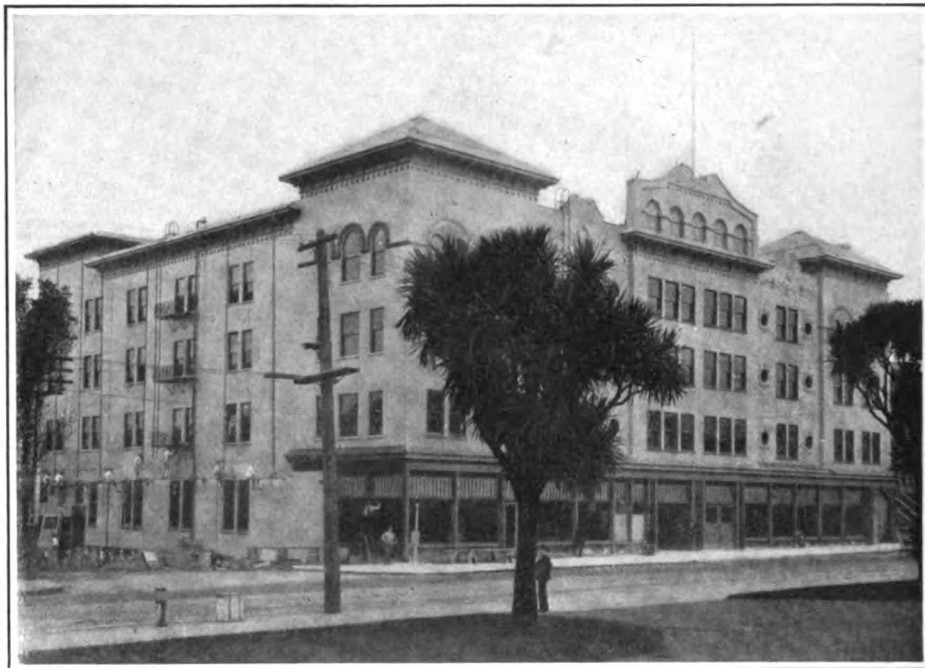

NEW GARAGE OF PIONEER AUTOMOBILE COMPANY IN SAN FRANCISCO.

less than its actual value by a restraining order issued by Judge Hunt, of the Superior Court, upon the showing made in an application by Max L. Rosenfeld, one of the directors, against his fellow directors, E. P. Brinegar, J. S. Andrew, R. H. Davis, J. J. Avis, L. E. Lee and W. A. Stringer.

The suit was brought by Mr. Rosenfeld to prevent the sale of the stock of the concern and the Locomobile, Oldsmobile and Winton agencies, which it holds, to E. P. Brinegar, president, on terms already arranged. Plaintiff alleges that the company is controlled by E. P. Brinegar, the president, and L. E. Lee, the secretary and largest stockholder, that it has been losing money and the proposed sale is to be made to E. P. Brinegar, who is to get the three agencies—alleged to be worth \$20,000—for nothing, the supplies at cost price and the automobiles now on hand at their actual value as fixed by appraisers. In part payment Brinegar is to turn over to the company one hundred shares of stock at \$100 a share. Rosenfeld says that the stock at

corporators, John Hanson, C. O. Mueller and L. A. Mueller.

Newark Pneumatic Puncture Proof Tire Co., Kearny; capital, \$25,000. Incorporators, Henry Willoughy, Jr., John Millar and Edward K. Patterson.

Automobile Appliance Co., San Francisco, Cal.; capital stock, \$100,000. Incorporators: L. E. Sperry, Max I. Rosenfeld, Eugene S. Watson, J. P. O'Brien, Charles H. Robinson and A. D. McMillan.

Sultan Motor Co., New York; capital, \$200,000. Incorporators: Henri de Buren, Nelson Hiss and H. V. Rutherford, of New York.

Boston Automobile Garage Co., Boston; capital, \$25,000. Officers: Edgar A. Cook, president, and George C. Gouther, treasurer.

Columbus Automobile Engine Co., Columbus, O.; capital, \$100,000. Incorporators: F. M. Stechner, F. E. Stevens, Harvey Cockell, A. D. Sanderson, F. F. Main, E. G. Savage, S. B. Nace, E. B. Evans, M. A. Corbett, M. H. Neil, Albert Ross and W. E. Moling.



CHICAGO CLUB WINS AGAIN.

Injunction Prevents City from Enforcing New Numbering Ordinance.

Special Correspondence.

CHICAGO, Aug. 20.—A signal victory for the Chicago Automobile Club was won last week by its attorney, Sidney S. Gorham, when Judge Elbridge Haney granted an injunction forbidding the enforcement of the new law governing the use of automobiles in Chicago. The writ forbids the city police and attorneys from taking action to enforce the law, and also forbids the board of automobile registry from requiring drivers to take examinations before it.

The petition for the injunction was signed by President John Farson and the 378 members of the club, and the protection extends specifically only to them. New members who join the club will have their names added to the list.

The points made by the club in its bill are:

Numbering leads to confusion and the arrest of innocent persons, since bogus numbers are often used.

Numbering is "an easy-going method of apprehending violators of the law and is of no practical benefit."

Automobiles usually are operated in boulevards which are under the control of the park commissioners and patrolled by mounted police who are capable of arresting offenders.

The ordinance gives the automobile board and the mayor the power of discrimination.

Without an injunction "a multiplicity of suits at law and criminal prosecutions to enforce the ordinances and the collection of the license fees immediately will follow."

For reckless driving the State laws provide ample remedy.

Enforcement of the ordinance would prevent competent drivers from operating machines.

CITY OFFICIALS INCENSED.

The city officials are particularly incensed because they were not notified that the injunction was being sought, and they will use every possible means to cause annoyance to the users of automobiles. Mayor Harrison has taken the initiative by saying that he intends to enforce the ordinance governing the speed of all vehicles. He says that as soon as the stockyard strike is over he will order the entire police force to arrest all automobile drivers who violate the city ordinances, and if necessary he will have the flying squadron detailed on the work of making arrests.

Corporation Counsel Tolman said that he was certain that the injunction does not prevent the regulation of the speed of automobiles, no matter what is said about other sections of the ordinance. He said that it was practically certain that the Appellate Court would decide that the injunction was binding, as it had ruled that way once before in the Banker case, but the city intended to take the matter to the Supreme Court and hoped to have it dissolved there. He criticised the action of Judge Haney in issuing the injunction without notifying the city officials that he intended to do so. He stated that he had requested all the judges sitting in the county courts to notify him if an application was made for an injunction of the nature of the one ob-

tained, and he quoted the law in an attempt to show that it was necessary for the judges to give this notice. Major Tolman intends to attack the manner in which the injunction was obtained in legal proceedings which will be separate from those begun to ascertain whether or not the automobile ordinance is constitutional.

WARNED AGAINST SPEEDING.

In a letter to members of the Chicago Automobile Club, issued just after the granting of the injunction, Attorney Gorham said:

"The speed limit of ten miles an hour remains in force and unaffected by this injunction; and it is regarded as highly essential to the interests of automobilists that they exercise caution and drive at a reasonable rate of speed, in the hope that it may be demonstrated to the city authorities that the licensing of drivers and the numbering of machines are not essential to the enforcement of proper and reasonable regulations as to the speed of automobiles on the streets of Chicago, and by this means prevent the necessity of further litigation as to licensing and numbering.

"You will be notified immediately of any modification of the terms of the order entered by Judge Haney, and until such notification it will not be necessary for any one who was a club member on August 11, 1904, to be examined or to carry a number on his car."

MILWAUKEE CLUB DRAFTS ORDINANCE.

Special Correspondence.

MILWAUKEE, Aug. 22.—The Milwaukee Automobile Club held a special meeting in the clubrooms at the Pfister Hotel last Thursday night and drafted a new automobile ordinance which is designed to cover all the points about which the members of the Milwaukee common council and the local automobilists have been at constant war for months past. The new measure includes stringent rules relating to the use of automobiles and is expected to convince the council that the club is working with the council in the effort to secure an equitable ordinance.

The ordinance requires all owners of machines to register with the city clerk, who, upon the payment of \$1, will give the applicant a number which must be placed upon the rear end of his car. Each figure must be at least four inches high and five-eighths of an inch wide. Another important feature is that the engine must be stopped when the car is standing unattended in the street. Speed is limited to twelve miles an hour on a straight street and to four miles when turning corners. The sections pertaining to punishment for violation of the regulations has been taken bodily from the old ordinance.

NASHVILLE MOTORISTS ORGANIZE.

Special Correspondence.

NASHVILLE, Tenn., Aug. 22.—The automobilists of Nashville met in the office of the Cumberland Telephone Company last Saturday night and formed the Nashville Automobile Association. The initiation fee was set at \$10 and the following officers were elected: Geo. M. Ingram, president; Dr. Charles Brower, vice-president; J. C. Symmes, temporary secretary and treasurer. Lealand Hume, Thomas J. Tyne, E. C. Andrews, John Chester, John T. Landis, to-

gether with the president and vice-president, were named as a board of directors.

The club appointed a committee to investigate the possibility of securing some suitable building as a garage and to negotiate for the services of a permanent secretary and treasurer. A charter will be secured and another meeting will be held in the near future to complete the organization.

NEWS NOTES OF THE CLUBS.

CHICAGO.—The racing committee of the Chicago Automobile Club is now working on plans to hold a race meet in the latter part of September, or the first week in October, at Harlem. The committee is composed of John E. Fry, chairman; Jerome A. Ellis and F. C. Donold.

NEWPORT, R. I.—The Newport A. C. has opened its membership list to the cottagers. Alfred G. Vanderbilt is the first to become a member. The club will at once apply for a charter and it is the intention to hold a series of races on the Second Beach early in September.

WORCESTER, Mass.—The Worcester A. C. will have a club run to Putnam, Conn., August 31, to attend the Putnam Fair and automobile races, to be held in connection with the fair. It is expected that a large number of cars will be in the run, as there are several Worcester entries in the races.

PATERSON, N. J.—At its recent annual meeting the North Jersey A. C. elected the following officers for the ensuing year: G. A. Post, president; F. R. Reynolds, first vice-president; Frank Van Cleve, second vice-president; Robert Beattie, Jr., secretary-treasurer; I. W. England, captain, and C. Horand, lieutenant. The club now has an active membership of seventy-odd, and is in a prosperous condition.

TOLEDO, Ohio.—The Toledo A. C. has, through a special map committee, issued a book of road maps of Lucas, Fulton, Henry, Wood, Sandusky and Ottawa counties, showing the roads and routes best suited to automobiling. This first issue is of an experimental nature, but if it meets with success, other maps and information bulletins will be issued at intervals until the entire vicinity of Toledo is covered.

DUNKIRK, N. Y.—The Chautauqua Automobile Club has been formed here with the following officers: A. W. Dodds, president; C. E. Hequembourg, vice-president; J. W. Ware, secretary and treasurer; C. D. Fields and C. M. Rathbun, members of the board of governors, which also includes the officers of the club.

SPRINGFIELD, Mass.—The clambake of the Springfield A. C., given at Geisel's Grove on August 17, proved a most enjoyable event. Thirty-eight machines conveyed the members and guests to the grove. Dr. George H. Finch, chairman, assisted by Adolf A. Geisel, C. A. E. Cameron and Dr. H. C. Martin, composed the committee on arrangements. T. J. Halfer, of Boston, representing the Diamond Rubber Co., was guest of honor, and after the bake he was informally entertained with a few of the leading local motorists at the Worlhy Hotel.

DAVENPORT, Ia.—The Davenport A. C. held its regular weekly run August 14, going to the Joslin fair grounds, twenty-five miles, and return. Ten machines started, and eight completed the trip, arriving at the grounds about noon, where the occupants were royally entertained by the horsemen training at the track. The trip both ways was made without serious mishap, nothing worse than a punctured tire being reported. All reached Davenport about 6:45 p. m., and went at once to Schuetzen Park, where a spread awaited them. Another run will be held August 28.

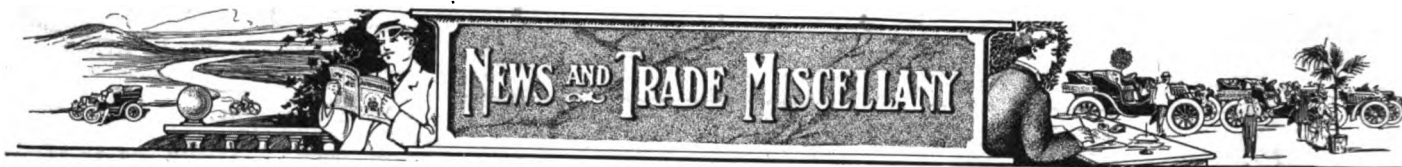

The Buffalo Racing Association is now planning another race meet, the date proposed being September 24.

The Fuller-Johnson-Shugart Co., of Council Bluffs, Ia., has recently added the Clark and Buick cars to its line of automobiles.

The Alfred James Foundry Company, of La Crosse, Wis., will soon begin the manufacture of automobiles.

Charles F. Murphy, the Tammany Hall leader, is a recent purchaser of a Fiat car, and for the past few days has been enjoying the roads of Long Island.

Burton D. Parker, recently with the Hartford Rubber Works, is now connected with the Olds Motor Works, of Detroit, having accepted a position in the office of R. H. Chapin.

The Standard Automobile Company, of Manhattan, recently purchased a tract of land in Long Island City, on which will be erected a factory for the manufacture of automobiles.

The register of the Province of Ontario shows 180 automobiles for the year 1903, as against 289 up to the present time for the year 1904, the majority of which are in the city of Toronto.

Albert Clement, Jr., who drove so well in the French Gordon Bennett and Circuit des Ardennes, is a sure starter on his 60-horsepower car in the race for the Vanderbilt cup.

At the recent Minneapolis race meet the Pope-Toledo 24-horsepower car won first place in every event in which it started, lapping five out of eight of the starters in the ten-mile race.

Dr. Joseph H. Chandler, of Centreville, Del., whom the regular Republicans have nominated as their candidate for Governor of Delaware, is believed to be the pioneer medical automobilist of the State.

Barney Oldfield is scheduled to give some exhibition speed trials at Nashville, Tenn., during the race meet to be held there on Labor day under the auspices of the Cumberland Park Driving Club.

Sheriff Clark, of Los Animas County, Colo., recently brought an automobile, to be used in the pursuit of criminals and to convey prisoners to and from the jails and asylums.

Peter C. Rutan has secured the agency for the Cadillac cars at Port Jervis, N. Y. He has recently received two touring cars of this make, which he will use in his livery business.

The Topeka Automobile & Cycle Co., of Topeka, Kan., has filed notice of dissolution. L. B. Wyman, a former member of the company, has assumed all obligations of the concern, and will continue the business at 109 East 8th street.

E. T. Weiant has resigned his position as treasurer and manager of the Consolidated Supply Co., of Denver, and will open a new store at 1534 Glenarm street, Denver, where he will carry a complete line of Fisk tires and automobile supplies of all kinds.

C. H. Foster has succeeded L. J. Ollier as manager of the Cadillac Automobile Company of Illinois, at 1312 Michigan Ave., Chicago. Mr. Foster has had considerable experience as an automobile salesman, and will push the Cadillac with vigor.

E. R. Thomas, president of the E. R. Thomas Motor Car Co., of Buffalo, is now making a trip in one of his well-known cars to Pittsburg, Philadelphia, New York and Boston. He is accompanied by his family and chauffeur.

The growing importance of the automobile trade in Canada is shown by the Government trade returns recently issued for the season ending April, 1904, which gives a total value of automobiles imported into the Dominion from the United States of \$178,000.

L. W. Conkling, formerly of the National Sewing Machine Co., of Belvidere, Ill., has recently accepted a position with the Packard Motor Car Co., of Detroit, and will act as right-hand man to Mr. Waldon. Mr. Conkling makes this change after seven years' connection with the former company.

The first Long Branch automobile carnival and race meet was sufficiently encouraging to cause the hotel proprietors and W. J. Morgan, promoter of last week's sports, to practically decide to make the affair an annual event. The experience gained in this first attempt will aid in furnishing a still more interesting meet.

The Haynes-Apperson Company, of Kokomo, Ind., has leased the premises at 1713-1715 Broadway, between Fifty-fourth and Fifty-fifth streets, Manhattan, where it will soon open a branch establishment under the management of F. S. Carrie. Frank Nutt, from the home office, will also be located at the New York branch.

Evidently American engineering and manufacturing methods are highly esteemed by German concerns, one firm in Dresden having sent Willy G. H. Pfitzner, M.E., of the Royal Technical High School, Dresden, to the United States to make a study of American manufacturing methods in general, and the building of automobiles in particular.

The Logan Construction Co., of Chillicothe, Ohio, has been organized to succeed the Motor Storage & Mfg. Co., of the same place. The capital stock of the new concern is \$100,000 and the officers the same as in the original company. A building has been purchased at East Second street, which is being remodeled for the new occupants and will be fully equipped with modern machinery for automobile manufacturing.

Robin Damon, a prominent automobilist of Salem, Mass., was recently saved from being fined for fast driving by being in a position to swear that the speed of his vehicle had at no time exceeded the legal rate, according to the readings of a Jones Speedometer which he carried. The judge accepted the testimony of the speedometer as being more likely to be reliable than that of the \$5 stop-watches used by the police of that locality.

A number of New England automobilists refrained from entering the recent St. Louis A. A. A. tour and taking their families, for fear that it would end in a free-for-all race, much to the discomfort of the passengers. Among these may be mentioned A. L. Potter, of Norwich, Conn., accompanied by his family, who started in his 24-horsepower Thomas a few days ago. Glen Tindale, of Providence, also expects to start for the Fair on September 1, using his Thomas touring car.

E. G. Ping is the first resident to own an automobile in Mason City, Ill., having purchased a gasoline runabout.

Mr. and Mrs. J. A. Pendleton, of New Orleans, are touring the country in their 24-horsepower Pope-Toledo. They left New Orleans June 1, going up the Mississippi valley as far as St. Louis, and then east through Illinois, Indiana, Ohio and West Virginia, crossing from there over to the Jersey coast resorts. They are now touring New York State, after which they will turn west for a second trip to St. Louis. Mr. Pendleton is a prominent Louisiana sugar planter, and is making the trip solely for pleasure.

The auto-boat which Hollander & Tange-man are building to take part in the contest for the American Power Boat Association's cup will be named the *Macaroni*. It will be 30 feet long, and fitted with a 60-horsepower Fiat engine. The forward part of the boat will be covered with a turtle back, in which the steersman will sit, protecting him from the spray. The engine will be covered and will have a short stack similar to the European racers. The boat is being built after the designs of Burgess, of Boston, and it is expected will be in the water in about two weeks.

The plan of carrying pupils of the primary classes to and from school by automobile, adopted last season by the trustees of the Adelphi College of Brooklyn, has proved so successful that it has been determined to extend the system to include all of the pupils. Instead of running two automobiles, the college will, at the beginning of the fall term, operate six electric, heated opera 'buses, two large combination cars and three gasoline touring cars for the long routes through the Flatbush section. So far as known, this is the first school in the country to adopt the automobile as a means of transportation.

Frank L. Steen, manager of the Hymera Coal Mining Co., of Indianapolis, was instantly killed and Seth Burnett painfully injured in a grade crossing accident in that city. The men were in Mr. Steen's automobile and were run down by the incoming C., H. & D. train while crossing the tracks in South Liberty street one afternoon last week. The machine was hurled a distance of about sixty feet and completely wrecked. The Liberty street crossing, though one of the most dangerous in the city, is not provided with safety gates, and the narrow street is so built up to the tracks that it is impossible to see trains until the tracks are reached.

A very complete guide with maps showing the best roads for automobiles in the vicinity of Chicago and Milwaukee has been issued by Rand, McNally & Co., Chicago. In addition to maps, tables of distances of cities, towns and lakes from Chicago and Milwaukee are given, and also descriptions of various routes and trips. The maps are of Chicago, the Chicago boulevard system, Milwaukee, the Chicago-Elgin-Aurora territory, the Chicago-Joliet-Kankakee territory and the small summer resort lakes region of northern Illinois and southern Wisconsin. A great deal of valuable information is condensed into a small booklet of convenient size for carrying in the pocket.

THE AUTOMOBILE

WEEKLY

NEW YORK—SATURDAY, SEPTEMBER 3, 1904—CHICAGO

10 CENTS

VANDERBILT CUP RACE PREPARATIONS.

ARRANGEMENTS for the course on Long Island over which the Vanderbilt cup race will be run have been about completed. The course, which is described in detail in the following pages, lies chiefly in Nassau county and partly in New York City. Under the provisions of the Hill automobile law in

person by reason of the road race. In the resolutions passed by the supervisors the clause designating so much of the course as is under their control reads as follows:

"The highways over which permission is hereby given to conduct speed tests and races of motor vehicles are known and designated in the County Road System as

sects the aforesaid highway at or near the Long Island Railroad at Queens; thence easterly along the line running through the middle of said highway known as the Jericho Road to the point where said road is entirely included within the bounds of Nassau County; thence easterly along said Jericho Road to Jericho, thence along the

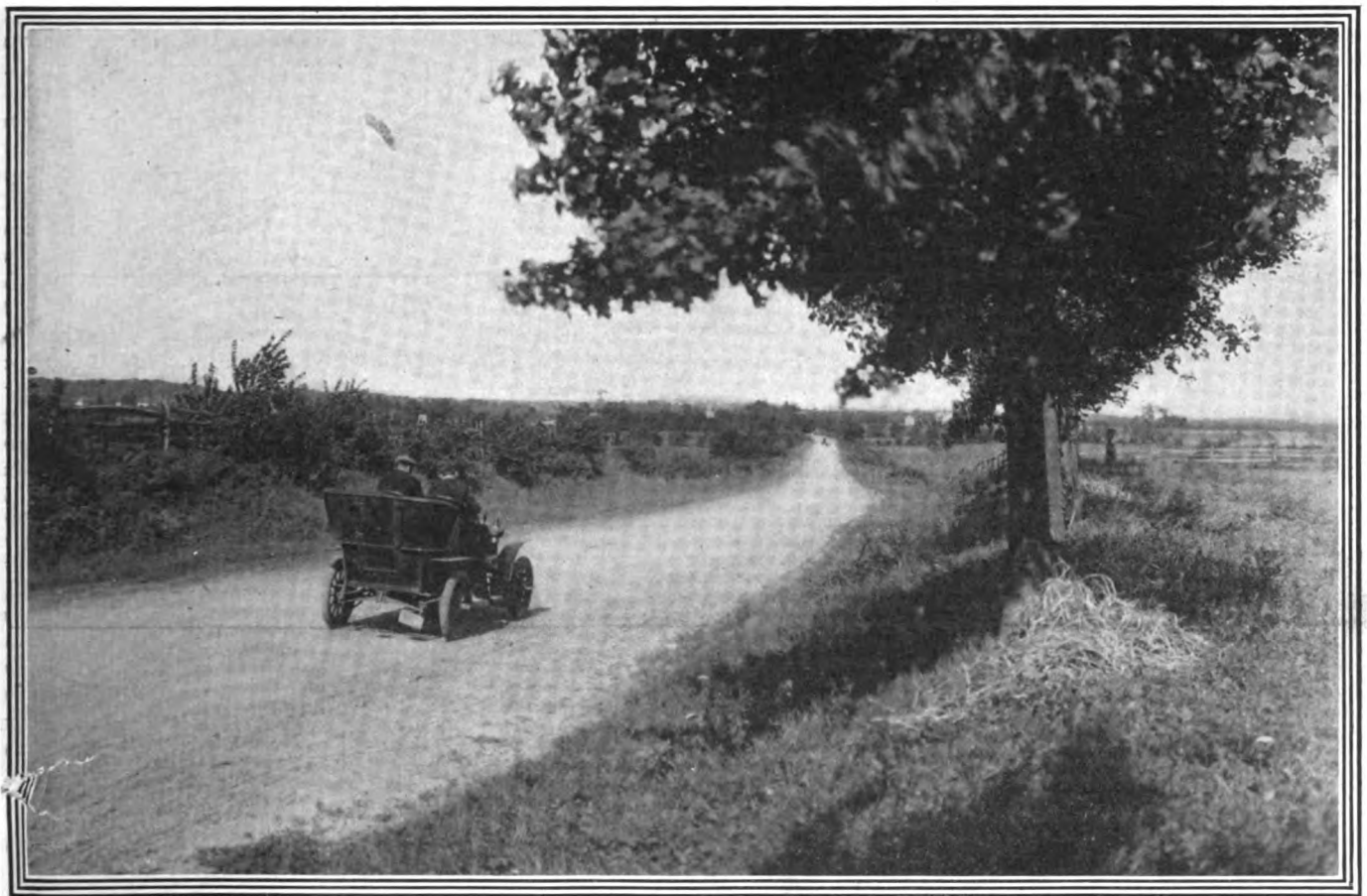

LOOKING EAST ON THE JERICHO TURNPIKE—CHARACTERISTIC VIEW OF SCENERY ALONG THE VANDERBILT CUP COURSE.

New York, the consent of the county supervisors has been secured for the use of the road from 5 a.m. until 3 p.m. on Saturday, October 8, the day of the race. This permission has been granted to the American Automobile Association which is to "hold harmless" the County of Nassau for all damages that may be incurred by any

follows: Jericho Road, so much thereof as is subject to the jurisdiction of the Board of Supervisors of the County of Nassau, being the southerly half of said Jericho Road, beginning at a point in the highway or county road, where the line dividing the City of New York on the East from the Town of Hempstead on the West, inter-

Jericho-Hicksville Road to Hicksville; thence southerly through Hicksville along the Massapequa Road to the Bethpage Turnpike, also known as the Plain Edge Road; thence westerly along the said Bethpage Turnpike or Plain Edge Road to Fulton Street in said Village of Hempstead; thence along and over said Fulton Street

in said Village of Hempstead to the public highway known as the Hempstead-Jamaica Plank Road, to the easterly line of the City of New York."

At Westbury the start and finish of the race will take place at a point marked by a pump on the roadside. This gave rise to the statement that the start would be made at a "pumping station" on the Jericho Turnpike, but there is no such pumping station in existence.

On the Turnpike there is a crossing of the Oyster Bay branch of the Long Island railroad, a short distance east of Mineola, and during the race all the competing cars will have to slow down about 200 yards west of the crossing and approach the tracks at not more than 10 miles an hour, making a full stop before actually passing over the rails. There is a good deal of railway traffic at this crossing, but it is not a dangerous one as trains coming in either direction can be seen for a long distance.

There will be only two controls on the route, one at Hicksville and the other at Hempstead. Through these the cars will pass nine or ten times during the race. This has caused a misunderstanding among foreigners who supposed that there were twenty controls on the course on each round, and are said to have held back entries on this account.

At Hicksville the control is 500 yards long. As the cars enter the town by a left-hand turn they also enter the control which is about 200 yards from the railroad. The outward boundary of the control is in the main street where the business houses give place to residences, and is immediately opposite a large Roman Catholic church. The cars are compelled to take not less than three minutes to pass through this control. At Hempstead the route does not lead through the business district but through the principal residence avenue, and the control covers the town limits, a distance of about 1 1/4 miles which



VILLAGE OF QUEENS, N Y CITY, NEAREST SETTLEMENT TO APEX OF TRIANGLE.

must not be driven over at a greater speed than eight miles an hour.

Under the agreement with the county authorities the course will be oiled at the turns and for a distance of about 250 yards at the starting point. The remainder of the course will be watered on the day of the race.

Timing of the event has been entrusted to the Chronograph Club of Boston, which did such good work at the Mt. Washington hill climb. Members of the club will be stationed at the start and at each control, and all these timing points will be connected by telephone, about fifteen instruments being installed for this use.

Notification to the users of the roads selected for the course as to the closing of the roads on the day of the race is to be made by publication in the local papers in advance, and also by posters which are to be placed along the route at the local post

offices. On the day of the race special officers employed by the county authorities will be on duty at the controls and at the Oyster Bay-Jericho road railroad crossing to see that the speed regulations at these points are obeyed.

Entries for the race are so far not numerous. The two White steam cars already entered, which will be driven by Webb Jay and Rollin T. White, will be specially built racing machines, constructed for this contest. Details concerning these machines are not available at present. In addition to the two Panhard cars entered by the New York agents, a third entry has been made by the French firm of Panhard and Levassor. William Wallace, of Boston, will drive a Fiat Gordon Bennett racing car, and his entry has been endorsed by the Automobile Club of Turin, Italy. George Arrents will drive Clarence Gray Dinsmore's 60-horsepower Mercedes, his entry having been endorsed by the Automobile Club of Germany by cable. This entry will, of course, be placed to the credit of Germany.

It is also expected that two Napier cars will be entered. Correspondence has been going on with Mr. Edge, who has made minute enquiries regarding the course, hotel accommodation, garages and, in fact, all details that would have to be considered.

Details of the Course.

Selection of the course for the Vanderbilt Cup race was made evidently with a view to providing a course having long straight stretches of good macadamized road with the least number of heavy grades and sharp turns, the fewest railroad and electric car tracks to cross and passing through the least number of villages. In these respects the course appears to have been well chosen. It is in the form of an irregular isosceles triangle located centrally in the western end of Long Island, with



BEGINNING OF THE HICKSVILLE CONTROL—RAILROAD CROSSING IN THE BACKGROUND

a six-mile north and south base on the Massapequa-Oyster Bay turnpike, a twelve-and-a-half-mile side on the Jamaica-Jericho turnpike and a fourteen-mile east and west hypotenuse on the Bethpage or Plain Edge turnpike, providing a circuit 32 1-2 miles long that is to be traversed nine or ten times by the contestants in a race of approximately 292 or 325 miles.

This triangle lies in the townships of Hempstead and North Hempstead, Nassau County, in the great Long Island market gardening plain sloping down from the hills of the north shore to the marshes of the south shore, avoiding the tortuous roads and excessive grades of the Flushing-Cold Spring Harbor road on the north and the thickly settled but perfectly level Merrick Road on the south. The apex of the triangle lies in the village of Queens, the northeast angle in Jericho, and the southeast angle at the intersection of the Bethpage and the Massapequa turnpikes. The course passes directly through only two villages of notable size—Hicksville, on the base, and Hempstead on the southern leg. Passage through Queens will be avoided by cutting off the sharp angle of the apex

months by almost incessant streams of produce wagons going loaded to the New York and Brooklyn markets and returning empty. The Massapequa turnpike is almost as well traveled, being the main direct road in the west end of the island between the north and south shores. The Bethpage road from the Massapequa turnpike to a point near its intersection of a north and south road joining the Merrick road at the Merrick village is straight and macadamized, but is little traveled and is narrow—the narrowest of any on the course, the crown being only twelve feet wide. Heavy traffic on the other roads makes them smooth over the full width of the macadamized crown, but as an offset leaves them covered with a thick layer of gritty dust that is raised in clouds by the passage of every vehicle, be it wagon or automobile. The less traveled Bethpage road is at the present time sprinkled with innumerable loose pieces of crushed stone of 2 1-2-inch size that have not been rolled into the surface nor yet broken up by the passage of wagons. There are practically no sharp turns in the entire course except at the cross road at Queens and one in

at their top speed of seventy to eighty miles an hour will select points of vantage on eminences overlooking a mile or more of straight level road in unfrequented and unbuilt-up sections between Westbury and Jericho on the Jericho turnpike, north or south of Hicksville on the Massapequa turnpike, or between Queens and Hempstead on the south leg of the course.

Going over the course in detail in the direction of the race, in a careful examination of the course by members of THE AUTOMOBILE staff, during which the accompanying photographs were taken, it was observed that the Jericho road or north leg trended slightly north of east through gently undulating country with the hills of the north shore nearly always in sight from one to three miles away with fields of well-cultivated green corn and cabbages growing luxuriantly in the early autumn sun. At short intervals well kept farmhouses and country residences stand close to the road, freshly painted and wearing the general air of prosperity reflected throughout this section of the island. Crowning the hills to the north one occasionally catches distant views of the magnificent summer homes of wealthy New Yorkers. To the south the vision roams over level or very slightly undulating land well tilled and planted to corn, now nearing its maturity, but which by the date of the race will probably all be harvested and, perhaps, cut for fodder and shocked. Here and there the attractive villages of Floral Park, Garden City, Mineola, Westbury and Hicksville are seen a mile or so to the south, their brightly painted houses gleaming among the dark green foliage of the shade trees lining their streets. Frequently the course itself is lined with single rows of shade trees of uniform size. Features along this side of the course are an old but well-equipped wagon shop 2 3-4 miles from Queens near the fork where the Floral Park road branches off southeast, a curious old weather-beaten barn-like farmhouse with hexagonal cupola a short distance west of the hamlet of New Hyde Park just skirted on the north by the turnpike, the beautiful Westbury nurseries near the Westbury crossroad, and the mile running track and hurdle course on the W. C. Whitney estate of the intersection of the Jericho turnpike with the Wheatley road.

The turn in Jericho is marked for a couple of miles down the course by the big yellow general store and postoffice that stands directly across the end of the road facing west, as shown in one of the photographs.

The Massapequa turnpike stretches generally straight and almost due south between large cabbage patches and corn fields, succeeded by extensive unfenced grazing lands extending uninterruptedly for a mile or two on either side. A prominent landmark between Jericho and Hicksville is the St. John's Catholic Rectory, whose white buildings stand close to the road

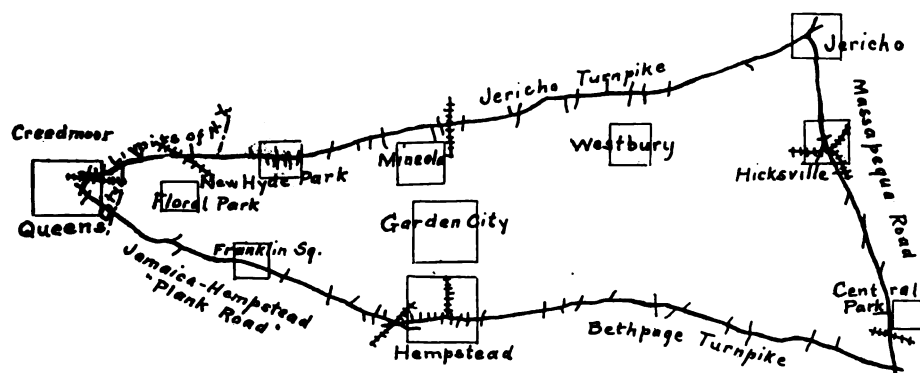

ROUGH SKETCH MAP OF THE VANDERBILT CUP COURSE ON LONG ISLAND, NEW YORK.

where the Jericho and Hempstead roads fork, using for the purpose probably the Springfield road, lying just at the eastern limit of the village. Mineola, lying north of Hempstead, is just skirted on the north by the Jericho leg of the course. Jericho is a hamlet rather than a village, comprising barely a dozen residences, a general store and a hotel or roadhouse.

Railroad tracks are crossed only five times in the thirty-two miles, and at one place—Central Park, near the intersection of the Bethpage and Massapequa roads—the track is a single line road that has not been used at that point for years. This branch ends at Creedmore, north of Queens, crossing the Jericho road on a viaduct north of Floral Park.

The elevation of the roads varies from sixty feet above sea level at Hempstead village to 200 feet at Jericho, the grades in no case being either long or exceeding 4 to 5 per cent. The roads themselves are in all cases macadamized and are well maintained. The Jericho and the Jamaica-Hempstead turnpikes are traveled every day through the year except in the winter

Jericho and another at the southeast angle; all others are bends or sinuosities.

Spectators intending to see the race will have their choice of going out to the village or hamlet nearest their selected observation point the evening before the race and staying over night at one of the numerous small hotels or roadhouses, of taking a Long Island Railroad train at about 3, 3.30 or 4 a.m. from Brooklyn or Long Island City, or of starting by automobile between midnight and 3 o'clock. The apex of the triangle at Queens, the nearest place on the course to New York City, is thirteen miles out and cannot be made with certainty by automobile in less than an hour, as much of the road, though in first-class condition for fast driving, lies in closely built up sections of the city where traffic is heavy. Those among the spectators who will want to watch the machinery of an international race will, of course, go to the starting point at Westbury, where they can see the contestants sent away toward the east and returning past the official enclosure from the west. Others who prefer to see the racers moving

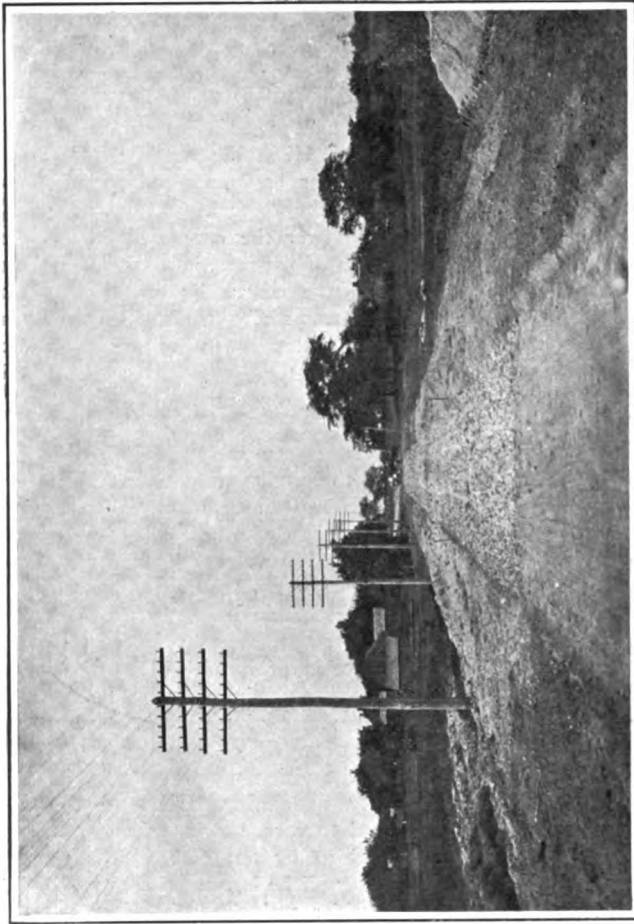

Road Makers at work on the Bethpage Turnpike or Plain Edge Road.

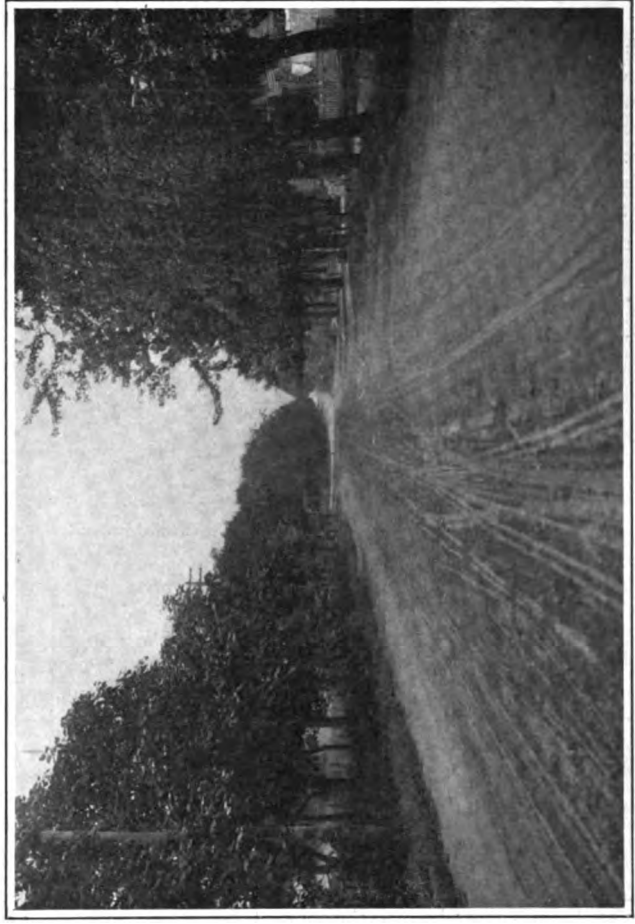

Approaching Elchaville Control. Cup Course bends sharply to left at house in middle distance.

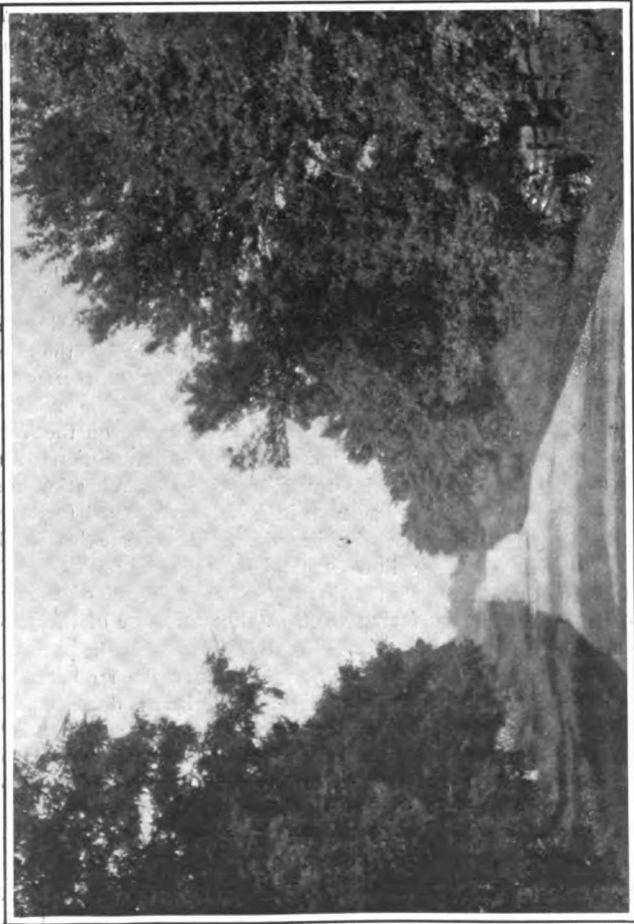

Looking toward Westbury on Jericho Turnpike.—Note Undulations of Road.

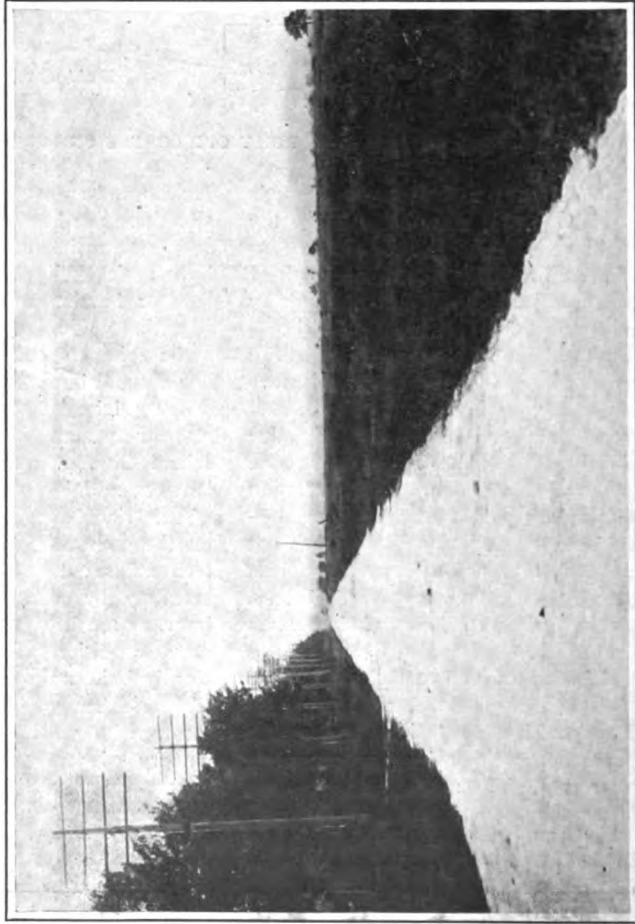

A Straight Stretch looking North on the Massapoquus Road near Central Park.

PHOTOGRAPHS SHOWING GENERAL CHARACTER OF ROADS AND SURROUNDINGS SELECTED FOR THE VANDERBILT CUP RACE, WHICH TAKES PLACE OCTOBER 8 NEXT.

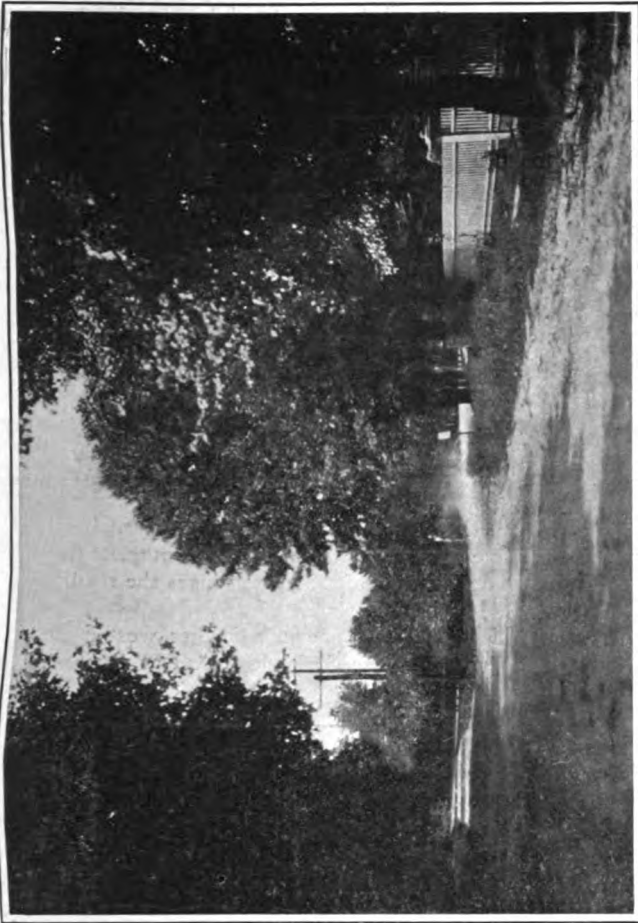

Approaching Entrance to the Hempstead Control.—Course bends to right.

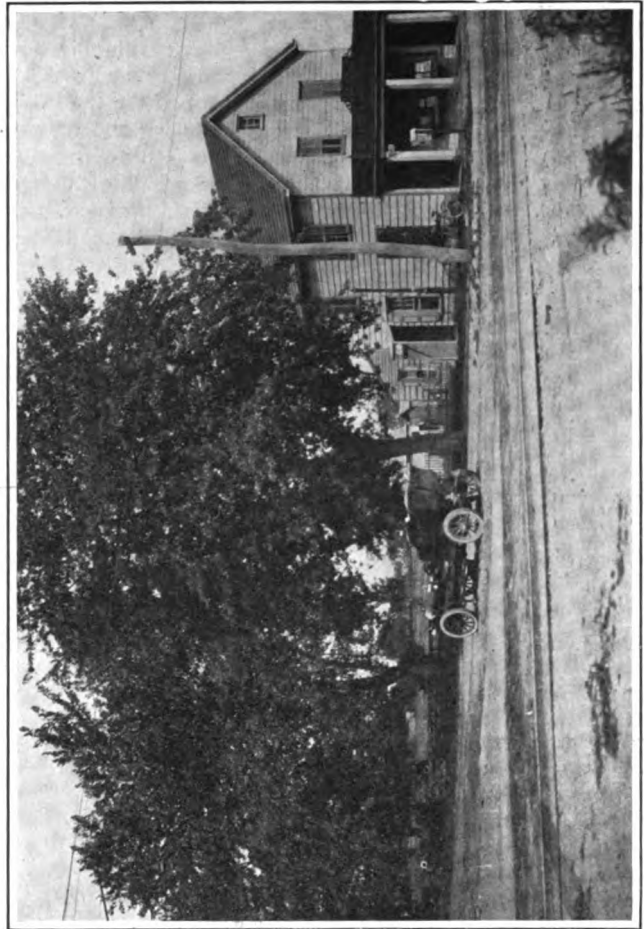

Road House at turn from Jamaica-Hempstead Plank Road into Springfield Road.

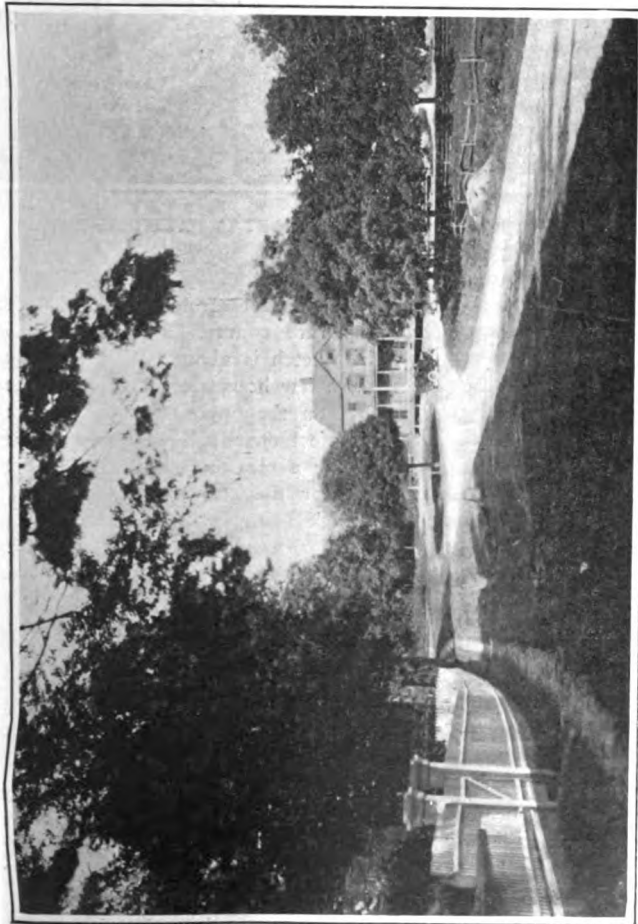

Approach to Jericho. Yellow House in Background.—Course turns sharply to the right.

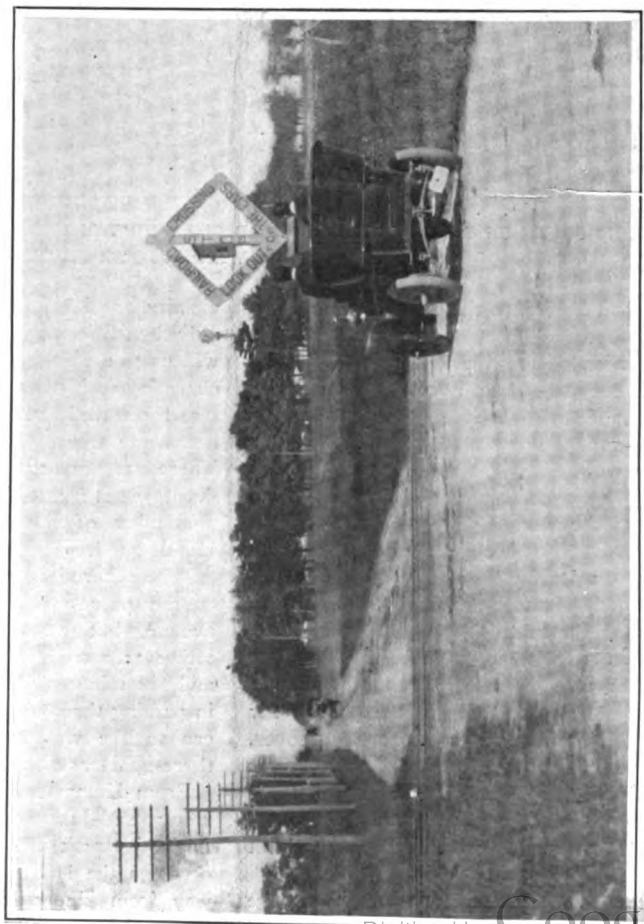

Crossing of Oyster Bay Branch of L. I. R. R. on Jericho Turnpike, near Mineola. SMAP SHOTS TAKEN AT IMPORTANT POINTS ALONG THE ROUTE OF THE VANDERBILT CUP COURSE IN LONG ISLAND.—RACE IS SCHEDULED FOR OCTOBER 8 NEXT.

on the right-hand side a short distance north of Hicksville.

Hicksville, where one of the controls is situated, is a village of 1,600 inhabitants, having several fairly large hotels, a bicycle repair shop where supplies can be secured, telegraph and telephone stations and where the main line of the Long Island railroad is crossed. Here, as at Jericho, the road has had a first experimental application of crude petroleum this summer to lay the dust. The treated part extends for half a mile through the village and is very effective. Hicksville is a little more old-fashioned and rural in aspect than either Queens or Hempstead, and vine-covered homes nestle beneath heavy shade trees in flaming old-fashioned gardens just now in full bloom.

Beyond Hicksville the course continues on straight south between more cabbage and corn fields and open prairie land, through the hamlet of three or four houses dignified by the splendid name of Central Park, and across the single track of unused railroad

miles in plain view, bisecting an extensive prairie with only three or four farmhouses standing along the highway. Two miles west of the turn laborers are now at work widening and raising the level of the road two feet, and macadamizing the surface to the width of twelve feet in the middle. This work is covering a section half a mile long. The road is unfenced all the way to the Merrick avenue cross road, a distance of three to four miles. On this stretch the landmarks are a group of large white barns topped by a windmill an eighth of a mile north of the course at this point, Vandewater's roadhouse on the right side of the road 2 1-2 miles east of Hempstead and an automobile supply and repair shop two miles east of Hempstead.

The course passes through the beautiful village of Hempstead on Fulton Street, which is merely the local name for the Bethpage Turnpike, which is also known as Plain Edge Road and as Hempstead Boulevard. Owing to this multiplicity of names it is difficult to get road directions in the

traveled. Country homes and farmhouses are closer together along this turnpike than on the Jericho road. Occasional vistas open to the north as far as the north shore hills. At stop No. 27 on the electric road stands a blacksmith shop and at stop No. 18 is a fine old residence standing in a dense grove of tall pines. Four and a half miles from Hempstead is a second blacksmith shop and two large roadhouses on opposite sides of the road. Perhaps the most prominent feature in this stretch is the new Belmont race course, which when completed is to be the biggest and finest in the world. The grounds extend for a couple of miles on the north side of the way, fenced off by a tall iron fence. Work has been proceeding for the last two years in the laying out of the track and construction of grandstand and stables. Two years more will be required to complete the work. A row of tall pines fringes the road in front of this place.

About one mile farther west is the turn onto the Springfield road at Queens which



LOOKING SOUTH ON THE MASSAPEQUA ROAD CLOSE TO THE BETHPAGE TURNPIKE—AUTOMOBILE ON THE RIGHT IS MAKING THE TURN, WHICH IS MARKED BY THE HOUSE ON THE LEFT.

mentioned before, to the intersection of the Bethpage turnpike, a quarter mile beyond the hamlet. Here the worst turn in the course occurs. Both roads are narrow—fifteen and thirteen-foot surfaces, respectively—and the turn is considerably less than a right angle. The usual traffic here is in such directions that the turn from the north to the west is seldom made so that no attempt has been made by the road builders to provide an easy curve. A drain pipe extends from a manhole almost in the center of the crossing to the inner angle of the turn, where it ends abruptly close to the edge of the road, leaving a bad hole concealed by grass that the wheels of a car are almost certain to drop into. Moreover, a shade tree with a five-inch trunk stands close in the angle, making it impossible to cut the corner across the turf. This tree should be removed and an easy turn built here.

After the turn is made, the Bethpage road stretches away due west for several

vicinity, as different persons know the road only by different names. Here the way widens to a village street bordered by most charming residences standing back from the street on well-kept lawns and shaded by handsome trees. The population is 3,500. There are numerous stores, several supply depots where gasoline can be secured, and a number of hotels, including Gardner's Hotel, on Greenwich street, at which meals can be secured at almost any hour. The course passes down the main residence avenue, but avoids the business street. However, a control will be established here, and six minutes will have to be consumed in passing through the town from the eastern to the western limits, approximately three-quarters of a mile.

From Hempstead the course is over the Hempstead-Jamaica plank road to Queens. A single track interurban electric railroad occupies the left side of this road all the way from Hempstead to Queens, but the road is broad, level, smooth, and much

completes the last stretch of the Vanderbilt Cup race course. The turn is easy and the stretch is about half a mile long. There are few houses on the right or east side, but on the opposite side they stand only 100 feet apart. Shade trees on both sides make a pleasant shaded lane of the road. Near the end of the stretch is a triple track railroad crossing, with gates, and another 100 yards brings one to the final turn and starting point from which this description was written.

Queens is a village built up around the fork of the Jericho and Hempstead turnpikes. It consists chiefly, with regard to the race, of a large wagon building and repairing works established in 1854, several roadhouses, a number of "shops" and a railroad station, affording telegraphic and telephonic communication with other points on the course. In addition there are residences sheltering a population of probably 500. Water and gasoline can be obtained here, as well as meals and shelter.

Problem of the Auto Boat.—I.*

Elements of Successful Hull Design Simply Discussed for the Benefit of Intending Purchasers and Users.

BY WILLIAM F. DURAND.

THE so-called auto boat (a gasoline motor boat intended for the highest possible speeds) has taken recently a rapid spring into keen public interest. The races arranged for such boats and the keen demand for new models or types, together with the general attention which the auto boat and its possibilities are now attracting, furnish the best evidence of the extent to which the amusement and pleasure-seeking public is disposed to take up with this latest product of the automobile engineer on the one hand and boat builder on the other.

The problem of the auto boat is, however, very different from that of the automobile, and this is true in so many and in such important particulars that a careful survey of the leading features of the auto boat problem, with special reference to the boat part, may perhaps be of interest to those who are already familiar with the automobile and who may be interested as purchasers or users of such boats, while possibly some features of our study may be likewise of interest to those who are concerned in the design and construction of boats of this character.

The main problem has been already stated: the design and construction of a gasoline motor boat capable of the highest possible speed.

FIRST POINT OF DIFFERENCE.

The first point of marked differences between the boat and the land vehicle has reference to the law of resistance.

In the case of the automobile for level, hard roads and moderate speeds the general relation between speed and power may be represented by a curve such as *O A* in the accompanying diagram, Fig. 1.

If then we take a boat requiring the same power at, say, a speed of eight miles an hour, the power curve for the boat will be similarly represented by some such curve as *O B*.

Corresponding to these curves we have in Fig. 2 diagrams of speed and resistance, *O A* for the automobile and *O₁ B* for the boat. An examination of these diagrams will be fruitful in showing the difference in the conditions which must be met in the de-

velopment of high boat speeds. In the automobile the resistance varies somewhat about as the square root of the speed, while for small boats it increases much more rapidly, the index varying from 2 to 3 or higher. It results that the power for the automobile

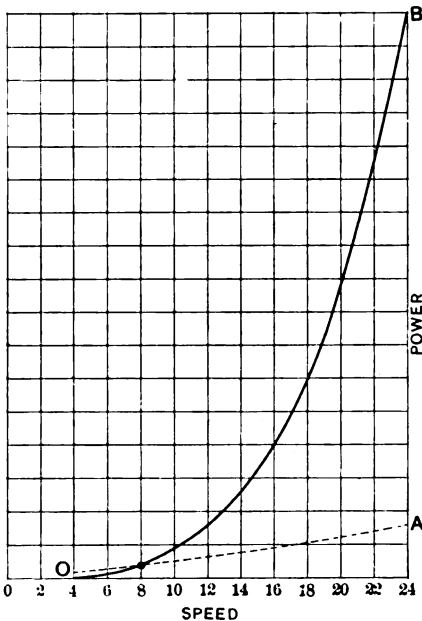

FIG. 1.—RELATION BETWEEN SPEED AND POWER FOR BOAT AND AUTOMOBILE.

will vary with the speed by an index about 1.5, while for the small boat the corresponding index will be from 3 to 4 or even higher. A realization of the meaning of this law may be obtained by comparing the relative power in the two cases for doubling the speed, say from 10 to 20 miles per hour. To effect this increase with the automobile we shall require about 2.5 times the power, while with the small boat from 8 to 10 and perhaps 12 times the power may be required.

While these relations are based on actual experience with boats and automobiles at the same speed, it should be pointed out that a relatively high speed for the latter is very much beyond a correspondingly high speed for the former. Thus with the automobile, speeds of 100 miles an hour and better have been realized, while speeds of 60 to 90 miles are well within the practicable present day limits. These figures correspond in point of attainment to speeds of 20 to 25 miles for the auto-boat, and it should be said that in comparing the two vehicles each at present highest practicable speeds, the comparison is relatively less favorable to the automobile.

This is due to the fact that at the higher speeds for the latter the air resistance begins to play a role of increasing importance as compared with the tire resistance, and since the former varies with the speed by

an index approaching 2, it follows that the total resistance will increase with the speed by an index between 1 and 2, and the power required will correspondingly increase with the speed by an index of 2, and over, at the higher range of speeds.

These general laws furnish an explanation of the very much lower speed limit for the boat than for the automobile, while they indicate that for the latter, due to the increasing importance of air resistance, a similar limiting range of speed will exist, though far beyond and less sharply marked than in the case of the small boat.

HIGH SPEED—HIGH POWER.

The cost in terms of power for high boat speeds is thus seen to be excessive, and this fact must be most clearly and definitely understood as an absolute law of nature, and as a condition which can in no wise be dodged, but which must be met squarely and fulfilled as a price for the attainment of such speeds.

As a second point of difference mention may be made of the excessive handicap under which the small boat must operate, simply due to its small size. The law of resistance for boats is such that the larger the boat the less the power required per ton of boat for a given speed, and the more easily may any given speed be attained.

As a result of this it follows that in the increase of speed on a given size of boat a point is soon reached where the entire weight-carrying capacity of the boat becomes required for machinery, and above this limit further increase of speed could only be attained by cutting down the weight apportioned to the construction of the boat. There thus exists a limit of speed for such boats, higher as the construction of the boat on given dimensions may be made lighter and as the weight of the machinery per unit

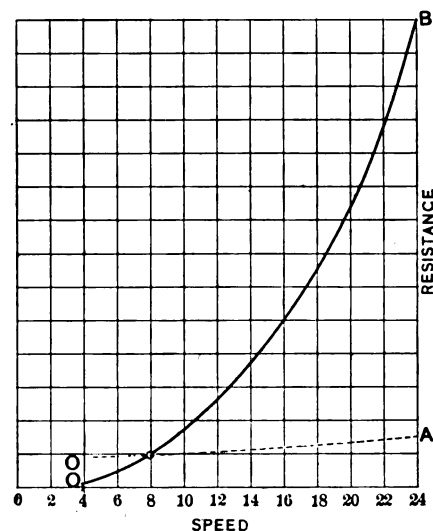

FIG. 2.—RELATION BETWEEN SPEED AND RESISTANCE FOR BOAT AND AUTOMOBILE.

of power is less, but a limit none the less quickly reached and beyond which the speed can not be forced. Such limits exist in the same way for the automobile, and for somewhat similar reasons the small machine is at a similar disadvantage, but the limit is by

At the request of THE AUTOMOBILE Dr. William F. Durand, the eminent engineer and authority on marine construction, has written a series of articles, of which this is the first instalment. In this series the complex auto-boat problem is treated simply, so as to be within the grasp of the non-technical reader, and yet authoritatively, and we believe it will be a most welcome addition to the valuable literature on the subject which is usually available only in a highly technical form. There are so many misconceptions of different elements of the hull end of the problem among automobilists that a careful reading of the series will be found intellectually, if not financially, profitable.—EDITOR'S NOTE.

no means so quickly reached, nor are the consequences so sharply felt.

THE THREE MAIN FEATURES.

It results that the problem of the auto boat involves three main features, as follows:

1. On given dimensions to build a boat with sufficient strength, but which shall involve the minimum weight of structural material, thus allowing the maximum share of the total displacement or weight-carrying capacity for machinery.

2. The selection of such proportions and form of boat as shall insure the minimum resistance at the highest speeds, and thus permit of the maximum speed on a given power.

3. The construction of the machinery on the lightest weight schedule in order that on the allowed share of the displacement for machinery weights the maximum power may be developed.

In brief, then, the auto boat for highest speeds will show on given dimensions, the lightest construction of boat consistent with strength, the form suited to the highest speed with a given power and the greatest amount of power on the weight allowed for propulsive purposes.

Of the three problems above mentioned 1 and 3 are constructive in character and need not be further considered in the present connection. That is, we shall assume that the practical skill of the boat builder may be depended on to give adequate strength on the minimum structural weight, and that from among the splendid examples of gasoline engine construction available, some type may be selected which shall satisfactorily fulfil the condition of maximum power on a given weight.

This leaves us with the second part of our general problem, the determination of proportions and form for minimum resistance.

RESISTANCE OF A BOAT.

We must first note that the resistance of a boat may conveniently be divided into two parts:

1. That which is due to so-called skin friction; a part of the resistance depending on the extent and character of the wetted surface and on the speed, and increasing a little more slowly than with the square of the speed.

2. That due to the formation of waves and general surface disturbance: a part of the resistance which depends chiefly on form, proportion and speed, and varies with the speed by an index which is usually found between 3 and 4.

At low speeds the larger part of the resistance falls under class 1, and if low speeds alone were required, the form and proportions adopted would be such as to give a small wetted surface relative to the size of boat. This would call for a relatively short, broad, deep model, well rounded in form, somewhat resembling a hemisphere with boat-formed bow and stern.

With the advance in speed, however,

wave-making resistance becomes more and more important, and at high speeds usually forms more than half the total. This fact exercises a most important influence on the form and proportions suited to high speeds. The wave-making resistance with its special requirements steps in and demands recognition, with the result of an entire change in the proportion and form to be ultimately adopted.

If wave-making and surface disturbance were the only source of resistance the ideal form would be reduced to the dimensions of a vertical plane represented in idea by a long thin vertical board with knife edge cutwater and stern. Actually a compromise is effected between these two demands, and the best forms for minimum total resistance at high speeds show a long, narrow, relatively deep form with bow and stern formed in accordance with conditions to be discussed at a later point.

CONSIDERATION OF FORM.

Actual proportions, however, are modified somewhat by the conditions of internal space required for the proper installation of machinery, while qualities affecting safety and seaworthiness demand some recognition in the final combination. In particular these considerations force the selection of a somewhat greater breadth or relatively greater proportion of beam to draft and length than would be otherwise considered desirable. These points will be illustrated by an example. Suppose it is desired to develop a form for the highest speed on a total displacement of about 8,000 pounds. This means a displaced volume of about 125 cubic feet and with usual coefficients of fineness for such craft this would mean a total volume of the surrounding box of about 315 cubic feet. That is, the product of length, beam and draft will amount to about these figures. Such a form might then be realized with say 3-foot beam, 3-foot draft and 35-foot length, showing nearly 12 beams in the length. Such a form would undoubtedly show relatively low resistance at high speeds and would admit of being driven to such speeds with a relatively moderate expenditure of power. A beam of 3 feet would, however, be insufficient for the installation of machinery, nor would it provide space for crew nor sufficient beam for the needful stability. A readjustment is therefore called for, especially between beam and draft, and on the same length a beam of 4 feet and a draft of 2 feet 3 inches, or a beam of 4 feet 6 inches and a draft of 2 feet would provide conditions insuring a much more serviceable and safer boat than with 3-foot beam and 3-foot draft. Of course, a wider beam up to 5 feet or 5 feet 6 inches with length decreased to 30 feet and draft at about 2 feet would make a boat still more generally serviceable and to some extent safer, but as the proportion of length to beam is decreased we rapidly pass out of the class of high speed boats with which we are especially concerned at the present time.

Generally speaking, the best modern de-

signs for high speed show a length to beam ratio reaching upward toward 10, and with such draft as the weight conditions may demand. We also find that the proportion of length to beam is much more important than that of beam to draft, and that we are therefore justified in selecting the best value of the former which the conditions will permit, and of leaving the draft to be determined by the resultant weight conditions of the boat.

(To be continued.)

Motor Bike Device.

In England the motorcycle has taken a strong hold upon all classes, and such is its popularity that it considerably outnumbered the automobile. It is therefore not surprising that new and fearfully wonderful devices frequently make their appearance, though that is about all many of them do. The latest thing is a motor attachment for an ordinary bicycle consisting of a small air-cooled motor with all its accessories, except batteries and coil, which are attached to the bicycle frame, mounted on a diminutive rubber-tired wheel. Means are provided for connecting this arrangement to the rear of the bicycle in such a way that the little wheel trails behind the rear wheel of the bicycle and supports the power plant, while the transmission consists of a chain running from the motor to a sprocket on the rear wheel of the bicycle on the left side. The little wheel is pivoted to allow it to take curves, and the connection with the bicycle is so made that power plant can hop up and down on a rough road independent of the bicycle. What would happen to the motor in actual use on a dusty or muddy road is a matter for conjecture only so far as the amount of road material collected on it is concerned. An hour's ride after a rain storm ought to bury the motor completely out of sight. A shield could, of course, be fitted, but this would interfere with the cooling of the cylinder; indeed, it is doubtful if the cooling will be as efficient as it should be even without the shield. The jolting of the small wheel on rough road might be expected to be terrific. Carbureter troubles on motorcycles of the ordinary type are frequent enough when there is much dust flying, and in the case of this machine it is doubtful if a carbureter could be kept in commission for any length of time. The trailer might also be expected to affect the steering somewhat. However, time will tell what the device is good for.

While the automobilist is liable to locomotor ataxia, the man who ventures to cross the street is liable to a sudden attack of rigor mortis.—*Jerseyville (Ill.) Democrat.*

The city clerk's register shows fifty-three automobiles now owned and operated in Atlanta, Ga. This is more than twice the number in use there a year ago.

Sunday Meeting in Saint Louis.

Barney Oldfield in Ten-Mile Race Crashes into Fence, Killing Two Men—Track in Poor Condition and Dusty.

Special Correspondence.

ST. LOUIS, Aug. 29.—The races held at the St. Louis Fair Grounds race track yesterday were the first automobile speed contests of importance that have yet taken place in St. Louis, and there were not less than 20,000 spectators. The sensation of the afternoon occurred at exactly 4:30 o'clock, when Barney Oldfield, blinded by the dust of an opponent's car, crashed through the inclosure fence and killed two men. He himself sustained injuries, though they did not prove serious. His car was entirely demolished. The two men killed were leaning over the fence watching the races. One was a watchman at the track, the other a negro. John Scott, the watchman, had both legs cut off by the racing machine, and was killed instantly. The negro, whose body was torn and horribly cut, lived for an hour, but died while being carried to the hospital. Oldfield was thrown from his machine into a clump of bushes and was too dazed to know what had happened when he was put into A. C. Webb's car and brought down to the clubhouse. A corner of the board fence struck his left breast, leaving a gash an inch wide. His face and lip were badly cut and his right leg seemed to be useless. As soon as his wounds were dressed he was taken to the Missouri Baptist Hospital.

ACCIDENT IN FIFTH EVENT.

The accident occurred in the fifth event, the ten-mile race for the \$500 World's Fair trophy. There were six entries and five starters. The flying start was bad, only Oldfield and A. C. Webb getting their machines in motion. These drivers dashed around the track at a tremendous rate of speed. The starter stood in the center of the track as the men were finishing their first mile, and motioned them to stop, but the dust shut out the view of his waving flag, and the contestants shot past like balls from a cannon. When three-fourths around on the second mile Webb, who had the inside track, was 18 yards ahead. Oldfield, increasing his speed, swerved to the side to pass his opponent and the dust from Webb's car completely obscured his view. He turned his wheel slightly to the right, desiring to pass Webb, who would shoot in on the pole. Oldfield was nearer the fence than he realized, and his car dashed through the inclosure, killing the two spectators. The machine literally climbed up a large maple tree, broke heavy limbs from the top, overturned and fell facing the track.

SPECTATORS WERE CHEERING.

While this occurred the spectators at the grandstand were cheering Webb and waiting expectantly for Oldfield. When he did not come they glanced eagerly to-

wards the dust-clouded track, but could see nothing. Webb, in coming to the turn on his third mile, saw something was wrong and slackened speed, and stopped his car. He helped Oldfield into the machine and brought the injured driver to the clubhouse. The policemen on duty in their own automobile drove to the scene, and another motorist brought a doctor. The negro was given stimulants, and an ambulance was called. The policemen picked up the legs of the dead man and laid them beside his body, covering the corpse with newspapers till the coroner arrived.

It is only just to say that the police had repeatedly warned spectators away from this fence, the line having been patrolled less than twelve minutes before the accident.

ONLY MISHAP AT RACES.

Aside from this accident the races passed off without incident. One driver was intoxicated and was therefore ordered from the track early in the afternoon. The feature of the afternoon was the ten-mile race, which was called again half an hour after the accident. A. C. Webb, with his 60-horsepower Pope-Toledo car, was easily first, making the run in 10:52. Webb Jay, in a 10-horsepower White touring car, was second. G. P. Dorris, in a 24-horsepower St. Louis Motor car, did not finish. No other contestants entered in the second trial for this event. Webb rode fearlessly, his car literally bounding around the curves and skidding frightfully in the dust. Each time he would catch up with his own

dust of the round before. In five times around Webb had the lead by a mile, then he slackened speed, but came in a mile and a half ahead of his opponents. In an interview afterward, Webb said: "No, I did not let my car out to the full. I took no risks with the dust. I don't feel good about winning; I wanted to race with Barney. I said when I saw the accident, 'If Barney's killed I'm through with racing.'"

As soon as the race was over Mr. Webb went to the hospital to see Oldfield, but was not admitted, as it was after visitors' hour. He then returned to the track. When presented with the cup he was also given a handsome basket of flowers fashioned as an automobile. A dinner was given later in the week to the winners of cups.

OLDFIELD GIVES EXHIBITION.

One of the pleasantest features of the afternoon was the special three-mile exhibition riding by Barney Oldfield. This came early on the program. Oldfield's time was 3:15 2-5 and :56 1-4 for his best mile.

Webb Jay made quite a record for himself and his 10-horsepower White. Out of the eight events he took three first prizes, one second, and one third. W. F. Winchester, of Syracuse, N. Y., won first place in the first two events, and had not an accident happened to his Franklin car he would have made a splendid showing.

IN THE FIRST EVENT.

In the first event the cars ran around the track at a nimble gait, everybody betting on Winchester with his queer "gatling gun" engine. The spectators, largely from the country, were so accustomed to the language of horse racing that in the first race one man cried as the competing cars came into line: "Here come the horses for race No. 1." Winchester was cheered

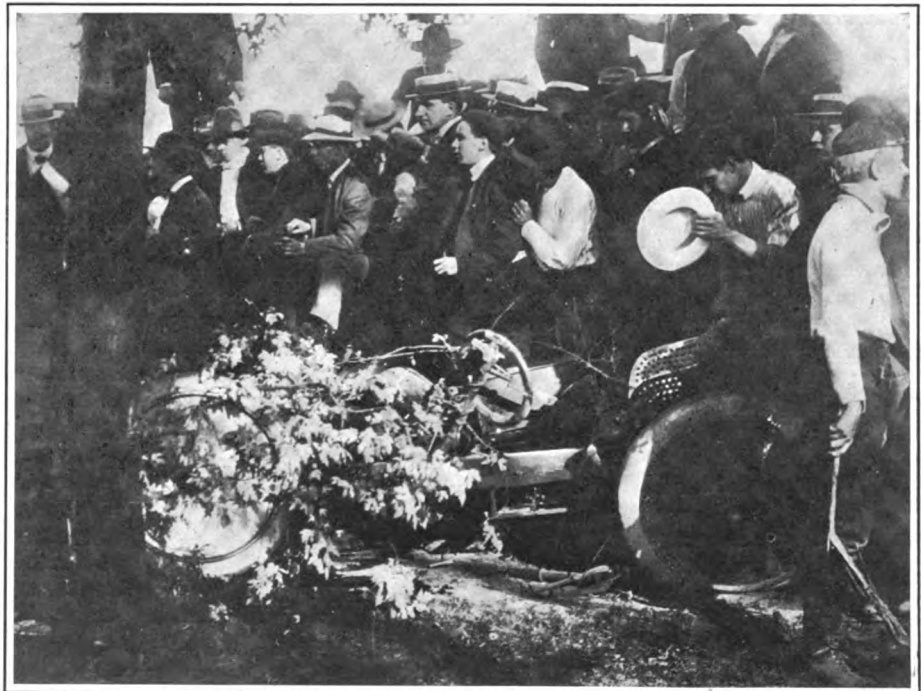

CROWD GATHERED AROUND OLDFIELD'S WRECKED PEERLESS AT SCENE OF ACCIDENT.

loudly when he came in ahead at the home stretch, making the five miles in 6:33 1-2. None of the races was run off in very fast time, but everybody was out to enjoy the sport, as these were the first automobile events for St. Louis.

ANHEUSER-BUSCH CUP.

In the second five-mile event for the Anheuser-Busch Cup there were four entries, but Winchester again led, making the distance in 7:04. After this Barney Oldfield, in his bright green powerful Peerless racer, made his special three-mile exhibition, which was cheered to the gallery. His time was 3:15 2-5.

Webb Jay's White steam car was the star of event number 3, which was a special race with a flying start. He drove to the time of 7:16, and was easily ahead of G. P. Dorris, who came in second, with his St. Louis Motor car, A. H. Halsey, in a 10-horsepower Franklin, was third.

In the fourth event, which was a special race of five miles, open to stock cars carrying four passengers, Barney Oldfield did not compete, A. L. Dyke did not start and H. S. Turner had a breakdown. Of the

other competitors to start, for they knew that Oldfield and I would run away from them with our higher powered cars. The dust was so thick that one could hardly see twenty yards ahead."

In speaking of the automobile's speed at the time of the accident, Secretary Geo. B. Seidener said: "When Oldfield's automobile struck the fence it was traveling at the rate of 62 miles an hour. Webb had been timed in .32 for the first half mile, while Oldfield was traveling two seconds faster, in order to pass Webb, and was rapidly gaining on the Toledo man when he struck the fence."

SECOND MISHAP FOR OLDFIELD.

This is the second accident in which Barney In September last year he was racing at Grosse Pointe, Detroit, when the steering gear of the *Bullet* refused to work and his machine dashed off the high banking, struck a man, and killed him.

It is quite a coincidence that at the St. Louis track two weeks ago on the same curve where Oldfield's accident happened a horse was killed and a driver seriously

the World's Fair Horse Show stables were gathered with the motor cars. However, a large number of automobilists and horse-men preferred the safer distance of the grandstand, and 100 motor cars and about half as many horse-drawn vehicles were put into the stables at the rear of the track.

The summary:

Five miles, open to vehicles weighing 881 to 1,432 pounds: W. F. Winchester, Syracuse, N. Y., 10-horsepower Franklin, first; G. P. Dorris, 24-horsepower St. Louis Motor car, second; Webb Jay, 10-horsepower White touring car, third. Time, 6:33 1-2.

Five miles, open to vehicles weighing 551 to 881 pounds: W. F. Winchester, 10-horsepower Franklin, first; J. A. Scott, 10-horsepower Bloomstrom, second. Time, 7:04.

Three-mile exhibition. Barney Oldfield. Time, 3:15 2-5.

Police wagon exhibition. One mile. Time, 3:12.

Special race. Five miles, flying start Cars weighing 881 to 1,432 pounds: Webb Jay, 10-horsepower White, first; G. P.

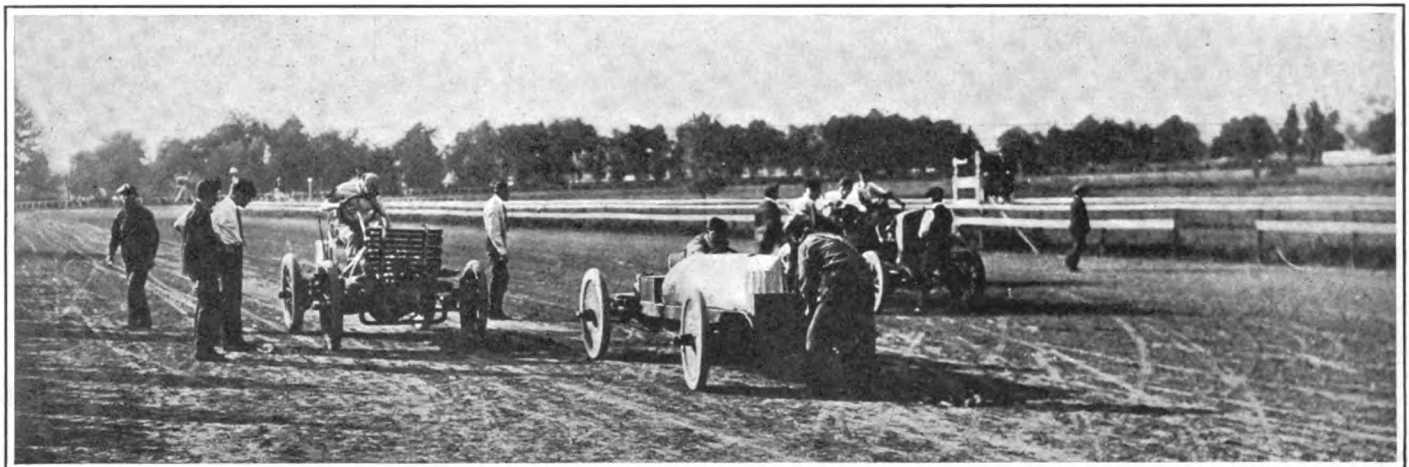

GETTING READY FOR THE START OF TEN-MILE RACE IN WHICH OLDFIELD MET WITH MISHAP. PEERLESS RACER, WITH OLDFIELD IN THE DRIVER'S SEAT, IS IN THE CENTER OF THE PICTURE.

two remaining cars, Ed Godsey, with a St. Louis machine, was first, and G. P. Dorris, with the same make of car, second. Godsey's time was 9:37 1-2.

EVENT NUMBER FIVE.

Event number 5 was called off until after the motorcycle race. Then followed the ten-mile lap race, in which Webb Jay won, making the rounds in 15:12. This driver also won the last race of the day, a special five-mile race, in which his time was 7:05.

Barney Oldfield, when seen after the race, said: "I will never ride in another race. This is my last; but I may ride in exhibitions. The track was not the best, the bankings were low, permitting machines to skid and raise clouds of dust, thereby obscuring our vision. The accident is deplorable and lamentable."

When seen after the race, Webb said: "The officials should not have allowed the

injured. The horse dashed through the fence, a piece of the board killing him instantly.

The track where the races were held has no connection with the World's Fair, though in the same city.

SITE IS PICTURESQUE.

The site is a picturesque one, surrounded as it is by trees. In the morning the officials of the racing events urged that the track be sprinkled, but the contestants all objected, saying that the cars would skid in the mud. The contestants preferred to take the chances with the dust. Promptly at 2:30 the races were called. On the veranda and lawn of the clubhouse were smartly-dressed women and a few men. The grandstand was crowded and every box taken. In the ring were seventy-five automobiles filled with onlookers. Most of the cars were decorated. Four-in-hands and every kind of fashionable turnout from

Dorris, 24-horsepower St. Louis Motor car, second; A. H. Halsey, 10-horsepower Franklin, third. Time, 7:16.

Special race. Five miles, cars weighing from 1,432 to 2,204 pounds: Ed Godsey, 24-horsepower St. Louis Motor car, first; G. P. Dorris, 24-horsepower St. Louis Motor car, second. Time, 9:37 1-2.

Ten miles. Flying start, for vehicles weighing from 1,432 to 2,204 pounds: A. C. Webb, 60-horsepower Pope-Toledo, first; Webb Jay, 10-horsepower White, second. Time, 10:52.

Ten-mile lap race. For vehicles weighing from 881 to 1,432 pounds: Webb Jay, 10-horsepower White, first; W. W. Leathers, 10-horsepower White, second. Time, 15:12.

Special race. Five miles, open to cars weighing from 1,432 to 2,204 pounds: Webb Jay, 10-horsepower White, first; G. P. Dorris, 24-horsepower St. Louis Motor car, second. Time, 7:05.

French Body Experts are Interviewed.

Side Entrance Has Practically Superseded the Tonneau—Aluminum Abandoned and One Maker returns to Wood.

DURING the recent visit of MM. Auscher and Kellner, the well-known automobile body builders, to this city, on their way to St. Louis, an interview by a representative of THE AUTOMOBILE elicited a number of interesting facts regarding tendencies in body design in France.

M. Auscher, who was first seen, began by showing his interrogator a bunch of

bodies built this year have side entrances; adding that he expected the proportion next year to be 99 per cent. The side entrance necessitates a long wheel-base, but this really adds to the comfort of the rear passengers, who in the tonneau are behind the rear axle and therefore receive a sort of teeter-board motion when the road is rough. The "double phaeton," a surrey with

an extension in course of erection is finished they will have a floor space of about 165,000 square feet. Their annual capacity is 2,000 automobile bodies, and they turn out also about 200 horse carriages annually.

M. Kellner, speaking of the life of closed bodies, conceded that absolute rigidity was both impracticable and undesirable in chassis frames, but pointed out that the body strengthens the frame, and laid stress on the importance of easy spring suspension. The platform rear spring, with two side members connected at the back by a transverse member attached at its center

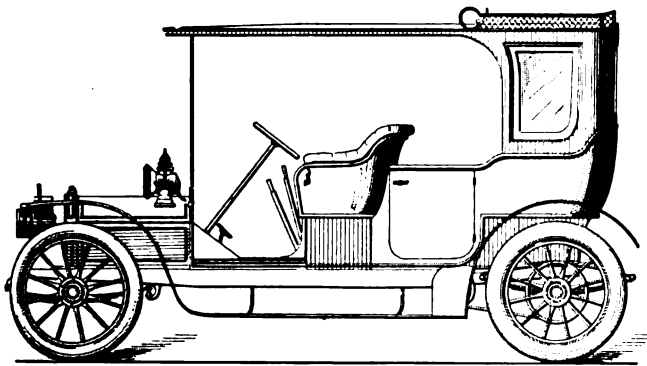

FRENCH DESIGN FOR DOUBLE PHAETON WITH CAB TOP.

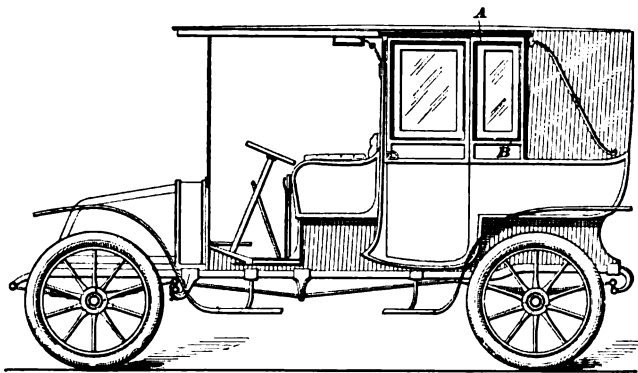

DESIGN FOR LANDAULET—LIMOUSINE ON RENAULT CHASSIS.

blueprints of new designs of his firm—J. Rothschild et Fils—from which three were selected for reproduction herewith. Of these three, one shows perhaps the newest thing in the way of French touring car bodies, the "landaulet-limousine," having the seating capacity of the limousine—four inside passengers, instead of two as in the landaulet—with the folding rear top characteristic of the latter. The difference in length between the two bodies is represented by a side window just behind each door, which lets down into the panels like the windows in the doors themselves. The top parts at A and B on each side after the windows are let down, and the rear half, which is of leather, folds back like a victoria top. This arrangement is intended to combine protection in wet weather with freedom of outlook and air in dry, at the same time protecting the passengers from the dust so far as practicable. M. Auscher stated that he considered it a very practical body for American conditions on account of its lightness as compared with the regular limousine. The latter, also, it might be added, is perhaps rather too close for summer use in most parts of this country, whose extremes of temperature surpass anything found in France.

Of the other bodies illustrated—there are three in all—one has a fixed canopy top with the back seat housed in at the sides and back. The third body is a large limousine, of which the seat plan is as indicated.

Tonneau designs were noticeably few among the blueprints shown, and M. Auscher stated that fully 90 per cent. of the

side walls, giving it much the profile of the tonneau, but with side doors, has nearly displaced the tonneau.

Regarding closed bodies, M. Auscher stated that at present they divide the honors almost equally with the open bodies for touring. The demand now, he said, is for comfort, elegance, smooth and silent running, rather than for speed. Questioned whether the closed bodies did not rack to pieces much sooner than the open, he said that on good roads they do not, but about

to the frame, he pronounced much the best for use with a closed body. Like M. Auscher, he was non-committal regarding the effect of rough roads. He added that his firm had found aluminum an unsatisfactory material for bodies, as in time it became brittle at the joints, crumbling "like sand," he said. Whereas, last year they had twenty men employed hammering aluminum sheets for bodies, this year they have but five. After trying steel plates without much success, they have gone back to wood

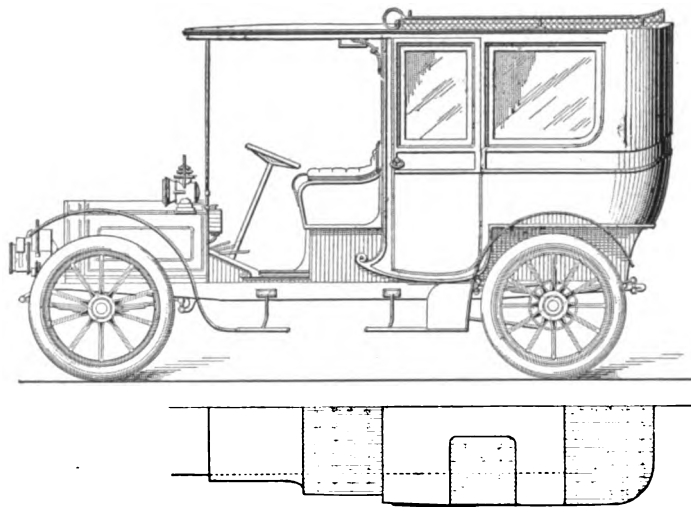

DESIGN FOR LIMOUSINE, WITH HALF BODY PLAN SHOWING SEATS.

American roads he could not say much, not having experienced them.

The works of J. Rothschild et Fils, at Levallois, near Paris, are the largest of their sort in France. They employ, said M. Auscher, about 700 workmen, and when

—ash, elm, tulip and mahogany. The tulip wood, which makes a very light body, comes from America.

When asked if the popularity of the closed body for touring did not indicate a decline in the speed craze, he replied hear-

tily in the affirmative. The automobile in France has nearly passed through the sporting period, he said, and is now considered as a means of utility. Ladies in particular demand protection from the elements, and the present tendency may be compared with the evolution of the railway coach from the primitive imitations of stage-coaches on the first railway lines. The tendency is more and more to differentiate the runabout and touring cars, about 10 horsepower being considered right for the former and 24 for the latter; though in hilly districts 30 or even 40 horsepower

Humorous Auto Posters.

Samples of a series of humorous cartoons printed in colors which are used to advertise the Peerless cars are shown in the accompanying reproductions. In the sketches the artist, R. F. Outcalt, has shown what the child of his imagination, "Buster Brown," can do at the wheel of a red devil. It is indeed an appropriate vehicle for the little imp to do stunts with, and there is just enough truth in the situations to give them the merit of genuine humor. The series is copyrighted by Burr Mc-

land is president. The objects of the club are mainly social, and in accordance with this idea the club has, besides the usual committee room, two drawing rooms, known from the style of their decoration as the "White Room" and the "Red Room" respectively. The former is opened to the members and their friends, and as such will be extensively used for receptions and entertainments, whereas the Red Room is for the use of members only. Besides the drawing-rooms the club has two sleeping rooms, which are intended principally for the convenience of visiting country mem-

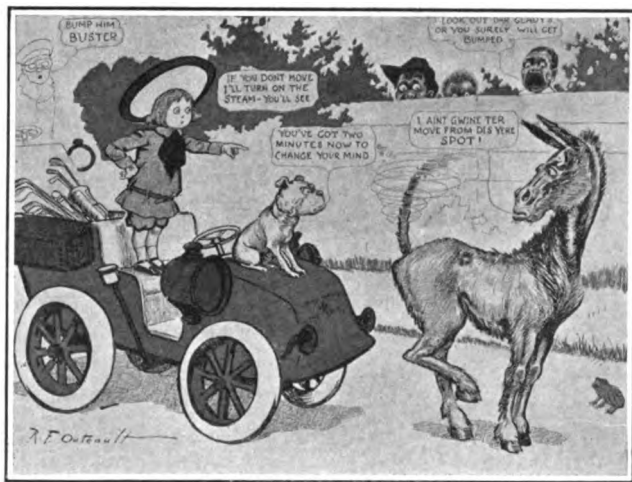

"LOOKING FOR TROUBLE"

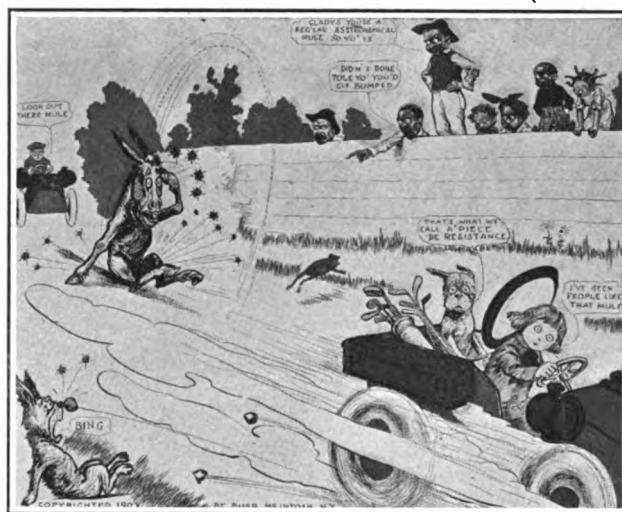

"A GOOD BUMP"



"HANDS UP"

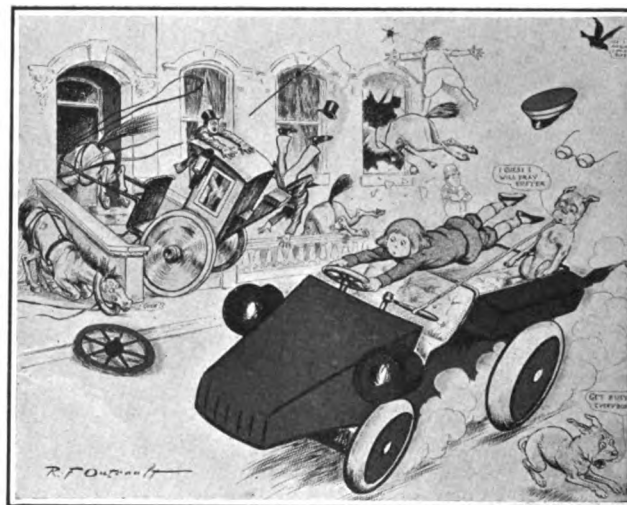

"A QUIET DAY IN TOWN"

is preferred. Naturally, with each class of car serving a definite purpose, the body styles tend to equally sharp distinctions, with the phaeton, dogcart, spider, hansom and coupé on one side and the double phaeton, tonneau, limousine, and landaulet-limousine or touring brougham on the other.

Frank Selby failed to reach Bartlett for the reunion until evening on account of a couple of small wrecks to his automobile. —Marietta (O.) Leader.

Intosh, the well-known artistic photographer in New York.

After a temporary residence at the House Crescent, the Ladies' Automobile Club of Great Britain and Ireland has moved into a handsome suite of apartments at the Clarendon Hotel, London. This club, membership in which, like that of most of the other automobile clubs of Great Britain, confers on its members the privileges of the Motor Union, has now over 260 members. The Duchess of Sunder-

bers. They have proved very popular, owing to the central position of the hotel and the numerous privileges in the way of reduced hotel rates, and the like, allowed members. Miss d'Esterre-Hughes, erstwhile temporary secretary, is now the regular secretary.

Two hundred and fifty automobilists stopped at the Pantatorium to get their clothes cleaned and pressed before making their appearance in St. Louis.—Morrison (Ill.) Sentinel.

Correspondence

Amount of Clearance Volume.

Editor THE AUTOMOBILE.

Sir:—I am going to build a motorcycle engine in a short time and don't know what proportion the compressor space should be of the cubical piston sweep. The cylinder will be 3 inches bore, by 3 1-2 inches stroke, and there will be no valve chamber, both valves being in the cylinder head. If you will answer this question for me I shall be very much obliged.

W. W.

Denver, Colo.

For an engine such as you describe the clearance volume may be about 25 per cent. of the volume swept by the piston.

Worried About Scaring Horses.

Editor THE AUTOMOBILE:

Sir:—I am a constant reader of THE AUTOMOBILE, and have had some very helpful information from its pages. The series "Hints to Touring Car Purchasers" is especially good and practical. I would like to have the views and comments of other drivers as to their methods of procedure when meeting teams along the road. If there is anything which can be done to avoid causing accidents let us have it at once.

I recently purchased a model K Rambler and, after the usual delay in delivery and nervous suspense (with which every purchaser is acquainted), the car arrived. It was a beauty and only needed the filling of the tanks and a turn of the crank when we were off. We ran the car home, forty miles, without any trouble and my expectations were fully realized. The next morning, of course, I wanted to show



Probably the first person to adopt the automobile as an up-to-date means of staking out a homestead claim was Marion Cramer, shown herewith in the Rambler car, in which he drove sixty miles over the prairie of No Man's Land to stake out a claim in Badger County, O. T.

it off and took several loads of friends for a spin. On one of these trips, when nearly in the center of town, I noticed a single horse approaching which seemed very badly frightened. I stopped at once, fully 200 feet away, but this 20 year old colt (the old ones are nearly always the worst) turned short around, tipped over the carriage and threw out the driver and a little child and scattered the carriage along the road for about half a mile. Fortunately no one was seriously hurt, but you can imagine my feelings when I had to sit there and could not do a thing to help. I had some parties with me who were becoming interested in motor cars, but seeing this accident fixed them. We have several ladies in town who used to drive horses, but no more driving for them. Of course, they look upon me as the red devil who spoils their pleasure and think that I am a constant menace to the lives of the innocent public.

Now it may sound foolish, but I positively have not the nerve to take my car out

for a country run. I have always been extremely careful, but every time I see a horse coming, especially if a lady is driving, I tremble for fear of what may happen. My car runs beautifully, have never had the least trouble with it, goes over our hilly roads with five up with perfect ease, but until the horses get used to it there will be no pleasure whatever for me. I have found that by being careful and talking to a horse, feeding him candy and a little coaxing he may be induced to allow you to rub his nose against the car or even eat an apple off the seat, but let me meet the same horse on the road and he is altogether a different animal. My car stands in the barn waiting for the first buyer and unless I can get over my foolishness (for I know it is foolish), it will go very cheap.

I would like to know if other drivers have the same trouble and what they take for it.

DEJECTED DESPONDENT.

Canton, Pa.

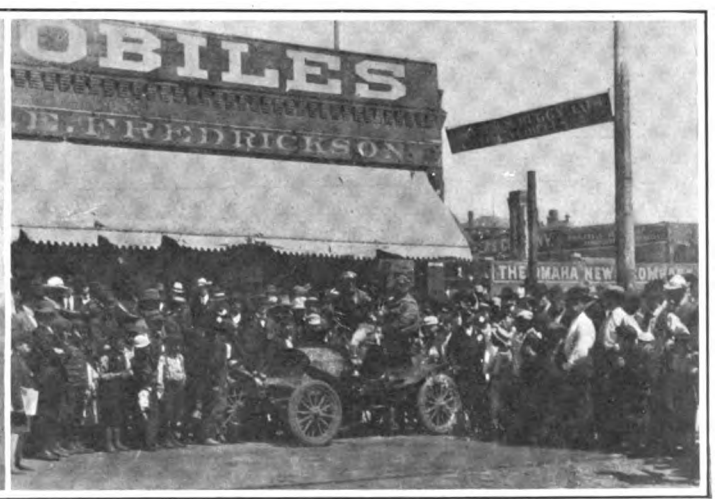

The picture to the left above shows L. L. Whitman and C. S. Carris, the transcontinentalists, meeting another party of automobilists on the Laramie plains in Wyoming. The one to the right shows the arrival of the ocean-to-ocean tourists in Omaha. Writing hastily from Toledo on August 27 Mr. Whitman stated that they had then been on the road twenty-seven days out of San Francisco, and that they would arrive in New York in a few days. They made the run from Denver to Chicago in seven days—quite a contrast to Mr. Whitman's previous trip, during which he was delayed a week in Omaha by heavy rains. On the present trip they passed through Nebraska during a dry period. If they reach New York this week they will have reduced the previous transcontinental record of 61 days by almost one-half.

Two Days' Racing at Grosse Pointe.

Fourth Annual Meet at Detroit Draws Great Crowd—No Records Broken but Good Sport is Provided.

Special Correspondence.

DETROIT, Mich., Aug. 28.—Two days of racing Friday and Saturday at the Grosse Pointe has given the people of Detroit the greatest automobile treat in the history of the city. This was the fourth annual race meet for the track and was held under the sanction and rules of the American Automobile Association, E. H. Broadwell managing the meet locally and making a big success of it from start to finish. In the two days not less than 15,000 persons saw the "auto devils" tear up the track, and while records were not broken, there was excitement enough in the races.

Aside from the trials against time and exhibitions there were twelve events, six each day. The most interesting was the first, when Barney Oldfield and Earl Kiser met twice. Oldfield is the auto idol of Detroit, having worked here and raced here, and at all times he was the popular favorite with the crowd as well as the most spectacular figure on the track with his big *Green Dragon* Peerless racing car. His victories were wildly applauded, although the crowd was generous to the other winners, Kiser getting his share.

In the two days, Oldfield and Kiser met three times, Oldfield being the victor twice and Kiser once, the latter winning the best race of the meet. The important event of the series in which they met was the local heat in the series for the Diamond Cup, and it was won easily by Oldfield in record time for the event since its inception in 1902. The time for the five miles by the Peerless green flyer was 5 minutes flat, which was 10 seconds better than previous time for the cup made by Oldfield himself at the Buffalo meeting this year. This makes four heats on the cup for Oldfield, although driving different machines.

The following table gives the interesting history of the Diamond Cup concisely, and another win by either a Ford or a Peerless machine will make the beautiful trophy the permanent property of the factory.

WINNERS OF THE DIAMOND CUP TO DATE.

Winner.	Place.	Date.	Driver.	Time.
Ford "909".	Detroit	Oct. 25, 1902	Barney Oldfield	5:28
"Bullet 2".	Cleveland	Sept. 4-5, 1903	Barney Oldfield	5:25 3-5
Ford "999".	Detroit	Sept. 8-9, 1903	Tom Cooper	5:32 3-5
Darracq.	Brighton.	Nov. 2, 1903.	F. A. LaRoche	6:03 3-5
Peerless.	Buffalo	Aug. 12-13 1904.	Barney Oldfield	5:10
Pope-Toledo.	Cleveland	Aug. 22-23 1904.	H. H. Lyttle.	5:24
Peerless.	Detroit	Aug. 26 1904.	Barney Oldfield	5:00

In the big cup race there was never any contest between Oldfield and Kiser. Garndt furnished all the racing there was with the Peerless driver. Oldfield jumped away right at the start, and although Overdurff, in the Mohawk, put after him for a few seconds in the first mile, the latter was

soon lost. Garndt, driving the *Baby Bullet*, then became the only rival, but never had a chance. At the end of the second mile Oldfield had a lead of a quarter of a mile, at the third three-eighths, and he lapped the two other cars in the fourth. He finished the race better than half a mile to the good. The second mile was run by Oldfield in 0:56 4-5, which is the record for the track and the fastest mile of the meet this year. Kiser and Overdurff did not finish, and Lyttle, in the Pope-Toledo, was third.

After Oldfield's victory in this race the 15-mile open was a surprise to the spectators, Kiser taking it from Barney in a Garrison finish. It was the finest exhibi-

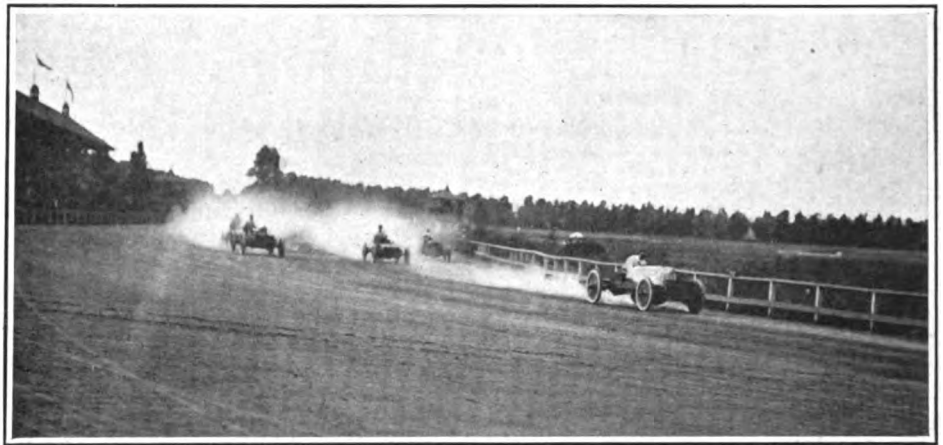

START OF FIVE-MILE EVENT AT DETROIT AUTOMOBILE RACES, OLDFIELD IN THE LEAD.

tion ever seen on the local track. Oldfield, Kiser and Garndt came to the tape and Oldfield shot away at the gunfire with a good lead. For the first few miles the only interest was in a see-sawing match with the two Wintons, and Oldfield had a good quarter of a mile lead. From the fifth there was excitement. Kiser began to hold his own and at the ninth started to gain. At the end of the tenth Kiser showed through the dust in the stretch as Oldfield crossed the tape, and in the next

three miles gained perceptibly, so that there was not more than a sixteenth of a mile between them. In the fourteenth Oldfield made a dying effort, but Kiser fast closed up the gap, and in the fifteenth at the half mile Kiser had his quarry. Barney shot the *Bullet* off around the last turn, hugging

the fence dangerously close and forcing Kiser to skid wide, but getting into the stretch Kiser let out, passing Oldfield half way down and beating him off in the last furlong, winning by about twenty lengths. It was a wonderful finish and the spectators went wild.

In the five-mile handicap Oldfield at scratch again had it easy, winning from Frank Kulik, in the new Ford 10-horsepower, the *Baby Bullet*, and George Soules, in the Pope-Toledo. Kiser did not appear in this race.

This new Ford racer is a marvel for its class, and scored a victory in the five-mile open for cars under 1,432 pounds, setting a new mile mark for the class of 1:04 4-5 in the third mile. The real race in this event was between Kulik, in the Ford, and Winchester, in the Franklin. After the first mile the Ford had it all its own way. Kulik was one of the men to meet with accident on the second day. He was driving an exhibition mile when he lost himself in the dust, crashing into the inside

fence and tearing a considerable length of the bar away. The machine was damaged but slightly, and Kulik was uninjured. The machine was rushed to the factory, repaired, and rushed back to the track to compete in the afternoon events, but did not show well after this. Another accident was when William Newman, driving a Pope-Toledo 24-horsepower in the five-mile handicap, had the choice of running into a Buick or taking the fence. Newman pluckily took the fence, tearing it up dreadfully and making a wreck of his machine. He made a hero of himself, however, by the plucky act, and the crowd made an idol of him.

Racing on Saturday.

On the second day the only event in which the two big fellows were entered was the first 10-mile open of the afternoon. Oldfield lowered Kiser's colors so easily in this race that it was uninteresting. Lyttle, in the Pope-Toledo, worried Kiser for six miles, holding him back as much as possible, and the real racing was between these two. At one time a collision was

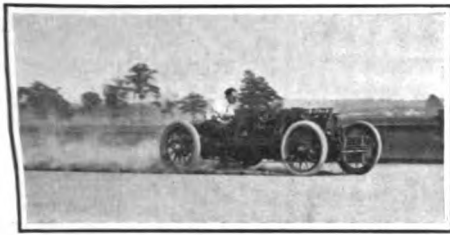

OLDFIELD IN THE PEERLESS.

narrowly avoided, Kiser checking up short just in time to escape hitting the tail of the hyphenated car a terrible bump. This was at the turn, Kiser trying to cut in close and Lyttle swerving just at the same instant. Oldfield took an eighth of a mile lead early in the race. On the fourth mile Kiser passed Lyttle in the back stretch, but the Pope-Toledo made a spurt and again forged ahead of Kiser. Kiser again passed Lyttle in the fifth, and in the eighth mile shook him off. Barney gained steadily every mile but one, and after the fifth mile, when the cars were doing a 57-58 second clip they all slowed some and the last mile was done in 1:04 2-5, Oldfield crossing the finish with Kiser only at the three-quarter pole. It was a walkaway.

The real race of the day was in the second 10-mile open of the afternoon, won by the Pope-Toledo, driven by Lyttle, from Garndt, in the *Baby Bullet*, by about three lengths. Kiser started with the *Bullet No 1* in this event, but his water pump went wrong and he was forced to slow down almost to a standstill in the second and drop out entirely in the fifth mile. Oldfield did not appear for this event, his tires having been damaged from skidding around the turns. Kulik, in the new Ford 10-horsepower, was the only other starter. Lyttle got away well and held his lead up to the third mile, when Garndt began to gain. On the fifth mile Garndt gained fast, until not ten lengths separated them as they passed the judges' stand. Lyttle

was taking his turns wide and Garndt close in. Garndt passed Lyttle in the sixth at the first turn, and both had a great sprint in the back stretch, going at a 1:04 clip, but Garndt held his lead. At the seventh the Pope-Toledo came up and was but a few feet behind at the stand. For two miles they held in this order, and as they turned into the stretch for the finish Lyttle shot in between Garndt and the fence, taking the lead and holding it to the finish by not more than 40 feet.

W. F. Winchester showed up well with his 10-horsepower Franklin, taking the five-mile open easily from a Cadillac driven by W. B. Hurlburt and the five-mile handicap. In this Lyttle, with the Pope-Toledo, was scratch. Franklin had 5-8 mile handicap and Garndt, in the *Bullet No. 2*, had 3-8 of a mile. Winchester won handily, neither car having a chance to catch him.

Considerable interest was manifested in the Detroit owners' handicap, won by E. S. George, with a big Peerless. Three were entered; a Peerless, scratch, an Elmore and a Ford with a 3-1 mile handicap. The cars were in touring condition and the time made, 7:47, was very good, considering this. Peerless caught the Elmore at the three-quarter pole in the fifth mile and beat her down the stretch easily.

There was but one accident and that not serious. Charles Schmidt tried to drive the Packard *Gray Wolf* for an exhibition five miles. At the last turn of the fifth mile a sliver of horse shoe punctured his right rear tire and, losing control of his machine, he collided with the fence. He was unhurt and the machine was practically undamaged.

The two motorcycle races, one each day, were interesting, J. G. Willett, of Buffalo, with an Auto Bi, taking the five mile open Friday and L. I. Lutes, of Detroit, with a Mitchell taking the five mile handicap Saturday.

Friday morning an auto parade was held.

100 cars participating, many of them being artistically decorated. First prize went to George Grant, whose White machine was decorated all in white with passengers dressed to match. Charles Grant, with a Ford, done in pink, took second honors, and A. Bemp, with a Cadillac, took third.

The summaries of the auto races for the two days are as follows:

FIRST DAY.

- Event No. 1.—Five-mile open. Cars under 1,432 pounds.
 - Frank Kulik (Ford)..... 1
 - W. F. Winchester (Franklin)..... 2
 - W. L. Marr (Buick)..... 3
 - Time—5:40; by miles, 1:15 1-4, 1:06 4-5, 1:04 4-5, 1:07 1-5, 1:06 4-5.
- Event No. 2.—Ten-mile open. Any weight. Stock touring cars, stripped.
 - George Soules (24-hp. Pope-Toledo)..... 1
 - William Newman (24-hp. Pope-Toledo)..... 2
 - Time—11:58 4-5; by miles, 1:18 2-5, 1:10, 1:13, 1:11 3-5, 1:10 4-5, 1:13 1-5, 1:10 4-5, 1:11, 1:10 1-5, 1:09 3-5.
- Event No. 3.—Manufacturers' Challenge Cup.
 - Barney Oldfield (60-hp. Peerless)..... 1
 - Charles Garndt (40-hp. Winton)..... 2

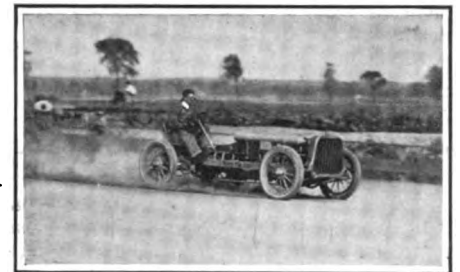

LYTTLE IN 8-CYLINDER POPE-TOLEDO.

- H. H. Lyttle (50-hp. Pope-Toledo)..... 3
- Time—5:00; by miles, 1:03 3-5, 0:56 4-5, 0:58, 1:04 4-5, 1:00 4-5.
- Event No. 4.—Five-mile handicap, 3-4 mile limit, standing start.
 - Barney Oldfield (60-hp. Peerless), scratch..... 1
 - Frank Kulik (10-hp. Ford), 3-8 mile..... 2
 - Charles Garndt (40-hp. Winton), 1-4 mile..... 3
 - George Soules (24-hp. Pope-Toledo), 1-2 mile..... 4
 - Time—5:13 1-5.
- Event No. 5.—Five-mile motorcycle. Open.
 - J. G. Willett, Buffalo (2 1-2-hp. Auto-Bi)..... 1
 - E. E. Dennison, Buffalo (3-hp. Auto-Bi)..... 2
 - Maurice Canutson, Detroit (3-hp. Orient)..... 3
 - Time—7:03 2-5; by miles, 1:29 3-5, 1:22, 1:34 1-5, 1:18 2-5, 1:21 2-5.
- Event No. 6.—Fifteen-mile, open. Any motive power or weight.
 - Earl Kiser (80-hp. Winton)..... 1
 - Barney Oldfield (60-hp. Peerless)..... 2
 - Charles Garndt (40-hp. Winton)..... 3
 - Time—14:51 1-5; by miles, 1:03 3-5, 0:57 4-5, 0:58, 0:57 4-5, 0:57 4-5, 0:58, 0:58 2-5, 0:58 1-5, 0:59 4-5, 0:59 4-5, 0:58 4-5, 0:59 2-5, 0:59 1-5, 0:59 2-5, 1:05 1-5.

SECOND DAY.

- Event No. 1.—Five-mile, open. Cars under 1,432 pounds.
 - W. F. Winchester (Franklin)..... 1
 - W. B. Hurlburt (Cadillac)..... 2
 - Time—7:12 4-5; by miles, 1:40, 1:25 1-5, 1:20 2-5, 1:25 4-5, 1:21 2-5.
- Event No. 2.—Detroit Owners' Handicap, five-miles, open, standing start; limit of handicap 3-4 mile.
 - E. S. George (Peerless)..... 1
 - J. J. Miller (Elmore)..... 2
 - A. Y. Malcomson (Ford)..... 3
 - Time—7:47; by miles for scratch car Peerless, 1:40 2-5, 1:30, 1:29 2-5, 1:29 4-5, 1:27 4-5.
- Event No. 3.—Ten-mile, open.
 - Barney Oldfield (60-hp. Peerless)..... 1
 - Earl Kiser (80-hp. Winton)..... 2
 - Harry Lyttle (24-hp. Pope-Toledo)..... 3
 - Charles Garndt (40-hp. Winton)..... 4
 - Time—10:04 2-5; by miles, 1:02 4-5, 0:58, 0:58 1-5, 0:57 2-5, 0:58 3-5, 0:59 2-5, 1:01 3-5, 1:01 3-5, 1:02 3-5, 1:04 2-5.
- Event No. 4.—Five-mile motorcycle handicap.
 - L. I. Lutes, Detroit (3-hp. Mitchell), 1:45 htcp..... 1
 - Maurice Canutson, Detroit (3-hp. Orient), scratch..... 2
 - J. G. Willett, Buffalo (2 1-2 hp. Auto-Bi), 0:15 htcp..... 3
 - Time—3:31 2-5.
- Event No. 5.—Five-mile handicap, open; standing start; limit of handicap 3-4 mile.
 - W. F. Winchester (Franklin), 5-8 mile htcp..... 1
 - Charles Garndt (Winton), 3-8 mile htcp..... 2
 - H. H. Lyttle (Pope-Toledo), scratch..... 3
 - Time—4:58 2-5, by miles for scratch car Pope-Toledo, 1:08 2-5, 1:01, 1:01 4-5, 1:01, 1:01 4-5; scratch car time 5:13 3-5.

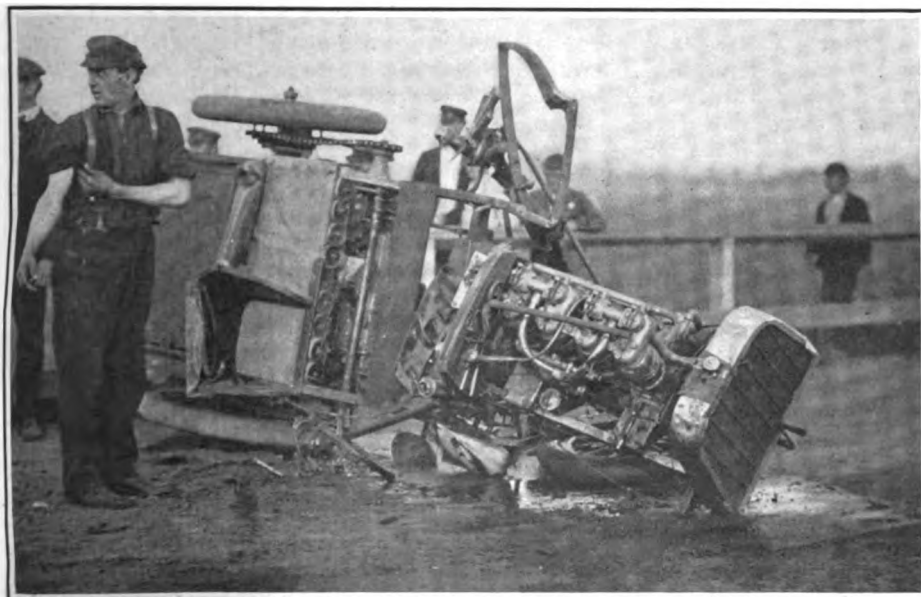

WRECK OF THE 24-H. P. POPE-TOLEDO, DRIVEN BY NEWMAN IN FRIDAY'S RACES.

Event No. 6.—Ten-mile, open. Any motive power or weight.
 H. H. Lyttle (50-hp. Pope-Toledo)..... 1
 Charles Garndt (40-hp. Winton)..... 2
 Frank Kulik (10-hp. Ford)..... 3
 Time—10:42; by miles, 1:04, 1:02 1-5, 1:05 2-5, 1:05 2-5, 1:06 1:04, 1:03 4-5, 1:03 4-5, 1:03 2-5, 1:04, 1:04.

Event No. 7.—Record five-mile trial of Gray Wolf Packard Motor Car Co. Charles Schmidt driver. Bursting tire threw car into fence at three-quarter pole of fifth mile. Time for four miles—4:24 1-5; by miles, 1:06 3-5, 1:05 2-5, 1:05 4-5, 1:06 1-5.

British Reliability Trials.

Special Correspondence.

LONDON, Aug. 22.—The A. C. G. B. I. are holding their annual car trials from August 29 to September 5. Instead of running the cars from London as a starting point, as in previous years, Hereford will this year be the headquarters. A daily run of 100 miles will be made, about 600 miles being covered altogether. This year the trials are open only to light cars, that is, moderate-powered motors not costing more than £200. Up to the time of writing over forty entries have been received, and still more are expected. Public attention has been greatly drawn to these trials, and the performance of the "motors for men of moderate means" will be closely watched. As light-car building is one of the branches of the motor industry in which the English manufacturers hold a very high position, the cars entered may be depended upon to give a very good account of themselves.

PARADE AND RACE IN WASHINGTON.

Special Correspondence.

WASHINGTON, D. C., Aug. 27.—Weather conditions being favorable, the automobile race meet to be given at the Bennings race track on Labor Day, September 5, by the Central Labor Union will undoubtedly draw the largest crowd that has ever attended a sporting event in Washington. Eight events have been provided by Chairman Ratigan and his associates on the racing committee and the entry list is filling rapidly. Washingtonians are eager for automobile racing, having had but a taste of it last summer, and they can be expected to crowd the Bennings grandstand as it has never been crowded before.

As a preliminary to the races an automobile parade will be held on the morning of Labor Day. At the time of writing more than 135 machines have been entered for the parade, and it is expected that more than 200 machines will be in line when the signal to start is given. Washington is waking up to the fact that there are vast possibilities for sport in the automobile, and the near future will see racing and parades that will compare favorably with those given in other leading cities.

W. H. Farnsworth, superintendent of the speed department of the Interstate Live Stock Fair Association, is making arrangements for an automobile race, to be held during the fair at Sioux City, Ia., September 5 to 10.

Notes on Electric Spark Plugs.

BY JOSEPH TRACY.

WHEN selecting spark plugs see that the porcelain does not touch the metal-shell, either on the inside end which goes into the cylinder, or the outer end, and that the porcelain is concentric with the inside of the shell. A plug which has the porcelain touching the metal will not usually last long, because the porcelain will crack owing to the difference in expansion between it and the metal. This liability to crack the porcelain is greater on air-cooled engines than on water-cooled. In air-cooled cylinders the plugs get hotter and consequently expand more than similar plugs in water-cooled cylinders.

USE OF PLUG WRENCHES.

When the plugs are located in the cylinder in such a way that it is necessary in order to remove them to use a "box" or "socket" wrench, care must be taken that the wrench does not come in contact with the metal tip on the end of the porcelain, because if it presses against this tip or against the porcelain even lightly it is almost sure to crack the latter. For the same reason it is well to remove the thumb nut or screw which fastens the wire to the plug terminal. On some kinds of spark plugs the nut or screw is so large that it is next to impossible to put a socket wrench on the plug without cramping the nut, and so cracking the porcelain. When connecting the wire to the plug, this screw or nut should be tightened up with the fingers, because if pliers are used, the central wire which goes through the porcelain is likely to be twisted and loosened.

On other types of plugs the binding screws are slotted so that a screwdriver can be used to tighten or loosen the screws. The screwdriver should be small and used with care.

MAKING ELECTRICAL CONNECTIONS.

To make good electrical connection in a jump spark ignition system the high tension cable should have its insulation removed for a distance of about 1 1-4 inches from the end, and the strands composing the wire twisted together. The bared wire should then be bent into the shape of a hook, or half circle. When clamping the spark plug screw the end of the connecting wire should point in the same direction as the screw rotates in when being screwed home. Thus the friction of the screw helps to keep the hook from opening, while if the wire loop is put on with its end pointing in the opposite direction, the screw will tend to open the loop at the end.

Care should be taken not to allow the ignition cable to hang from a plug without any other support, as a heavy cable will soon break the porcelain. This applies to plugs which are set horizontally more than to vertical plugs.

In putting in and taking out plugs it is

always advisable to use a spanner which fits exactly, and not a monkey wrench, as the latter has a tendency to wear the corners off the hexagon. When putting a fresh plug in place a little graphite and oil or graphite grease should be put on the threads. Plugs so treated will be found very easy to remove. Be careful not to get graphite on the porcelain, or a short circuit will be caused.

TREATMENT OF PLUG GASKETS.

Often when a plug is cracked the driver has a spare one but not a spare gasket. It then becomes necessary to use the old gasket and to exercise great care in removing it from the defective plug. Such a gasket is usually made of asbestos-copper, and can be used at least twice if carefully handled. The gasket can be removed by prying it away from the shoulder of the plug, either with a pocket knife blade or a thin screwdriver. Care must be taken that it is pried off evenly all around, and not one side at a time, because the copper sheath is easily cracked and the gasket thus rendered useless. When it has been removed about an eighth of an inch from the shoulder, it can be grasped with the fingers or a gas pliers and unscrewed. To put an old gasket on again, it will have to be *screwed* on, not pushed.

It is obvious that when a new gasket is put on a plug and the latter tightened up in place, the gasket will be compressed in such a way that it flattens on the inner circumference and so grips the threaded shank of the plug. In the event of a gasket not being obtainable, a piece of soft sheet copper about one-sixteenth inch thick may be substituted.

HOW TO CLEAN SPARK PLUGS.

For properly cleaning spark plugs which have become sooted or carbonized, a tooth brush and gasoline are required. Take care not to rub the sparking points too vigorously, or they may be broken off. If the plug is carbonized badly, it will be found difficult to clean it with the brush; in this case, a blunt knife, or one having a soft blade may be used. A hard blade will scratch the glazing on the porcelain and so tend to develop cracks. Emery cloth does the same and should *not* be used.

When using a plug of different design to those already in use, make sure that the spark points do not project so far that they short-circuit the bottom of the plug recess, or inlet valve, or whatever else is closest to them. If this happens the plug should be removed and an extra gasket put on. Such makeshifts should be used only when a suitable plug is not obtainable.

A good way to cure a horse which is afraid of the cars or automobiles is to tie him securely where he will get used to them.—*Utica (Ill.) Gazette.*

Patents

Muffler.

No. 768,013.—N. T. Harrington, of Detroit, Mich.

A muffler in which the course of the exhaust gases is as shown, from pipe *M* through chambers *H*, *G*, pipe *I*, and chamber *F* to outlet *N*. The threaded thimbles *J* hold the pipe *I* in place and bind the whole structure together.

Storage Battery Detail.

No. 767,554.—T. A. Edison, of Llewellyn Park, N. J.

An arrangement for preventing explosion of the gases liberated during charging. It

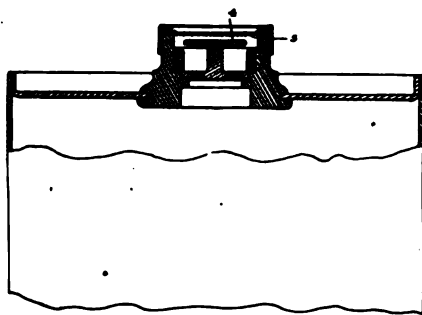

EDISON BATTERY GAS VENT.

a Greek cross, which is drilled hollow and filled with grease or heavy oil introduced through the plug *14*. The bearings have cap bushings *9*, which retain the oil while allowing it to work out gradually to the bearing surfaces. These bushings are locked against unscrewing by the plates *11* and screws *12* as shown. Used in the Autocar.

Inlet Valve Control.

No. 767,794.—A. P. Brush, of Detroit, Mich.

The control device of the Cadillac runabout. The rod *l* is connected at one end to an overhung pin *w* projecting from the 2 to 1 gear, and its free end rests on a roller *n* (dotted in the principal view) at the end of an arm *m*, seen in the detail

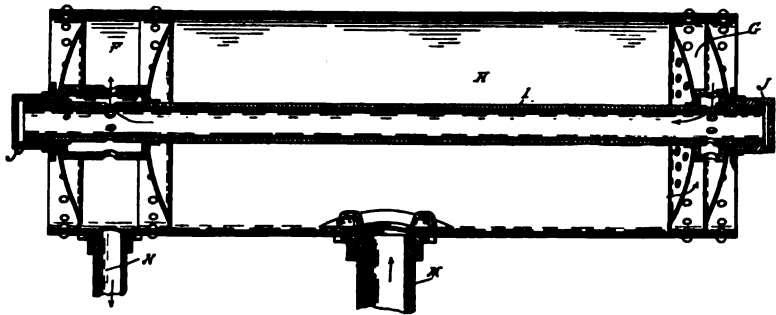

HARRINGTON PERFORATED BAFFLE PLATE MUFFLER.

be produced by rotating the eccentric *b* which connects *l* with the overhung pin *w*; and a governing device is indicated on another drawing, whereby the eccentric may be rotated automatically to keep the engine from racing.

Compressed Air Starting Device.

N. 766,525.—F. Reynolds, of Syracuse, N. Y.

An arrangement for admitting compressed air through separate inlet valves to the cylinders of a gasoline engine for starting. In combination with it is a device for introducing gasoline to the compressed air pipe. One lever opens the compressed air main valve and actuates the device for introducing gasoline, and the same movement opens the valves whereby

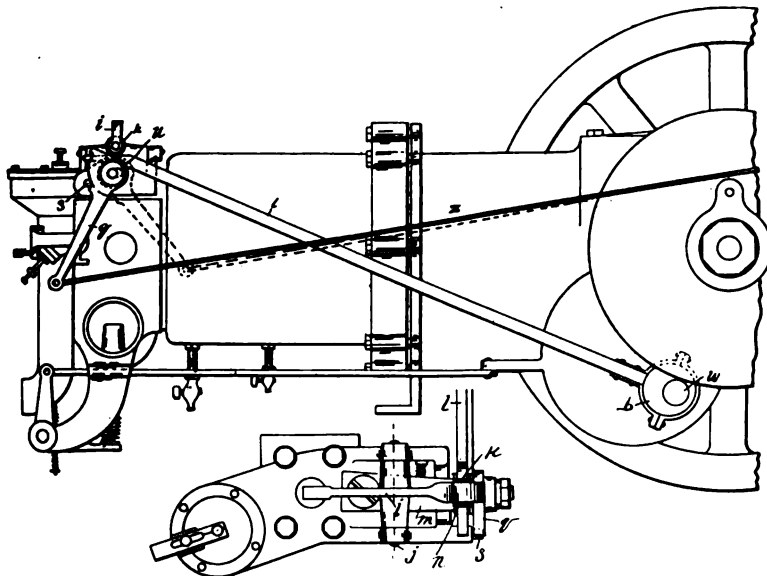

BRUSH CENTRAL DEVICE FOR THE CADILLAC RUNABOUT ENGINE.

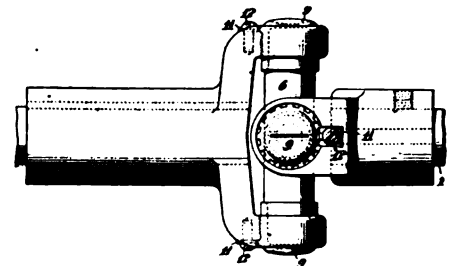

SPEIRS & DEY UNIVERSAL JOINT.

consists essentially of a wire gauge screen *5*, which, on the principle of the Davy safety lamp, prevents any flame, of explosion or otherwise, outside the cell from spreading to the interior. The disc *4* spreads the escaping gases so that they do not concentrate at any one point of *5*. This saves the latter from possible overheating in case the gases catch fire outside.

Universal Joint.

No. 768,200.—J. C. Speirs and Harry E. Dey, of Ardmore, Pa.

A joint with its center *6* in the form of

plan. Rod *l* terminates in a wedge-shaped portion and a straight finger, and roller *k*, at the end of inlet valve lever *i*, rests on it. As *l* reciprocates on *n*, its wedge face *u* rides up on *n*, pushing up *k* at the proper time to open the inlet valve. Arm *m* carries at its extremity the cam-faced lever *q* working against the stop pin *s*. By pulling *s*, *m* is made to shift slightly on its pivot screw so that *u* strikes and rides up on *n* a little earlier than with *m* in the normal position shown. This produces a greater opening, and for a longer period, of the inlet valve. A similar result may

the carburetted compressed air is admitted to the cylinders.

Steam Vehicle Bonnet.

No. 768,320.—R. H. White, of Cleveland.

The bonnet of the White steam touring car. It is closed by the condenser in front, and between the latter and the engine is a shield bent like a rounded wedge, which deflects the air passing through the condenser out at both sides of the bonnet, the latter being covered only by coarse wire netting.

Auto Boats on the St. Lawrence River.

Shifting of the Racing Center from New York Harbor to the St. Lawrence—Races Held August 27.

Special Correspondence.

ALEXANDRIA BAY, Aug. 27.—The center of motor-boat racing, which at the opening of the present season was in New York City, has almost in a week shifted to this place, and it is probable that next season will see such a development of power boating in all forms of racing and cruising as is unknown to this country or abroad. One of several causes for the failure of motor-boat racing about New York lies in the geographical situation, the home waters of each of the local clubs, such as the Hudson River abreast the city where the Columbia Yacht Club is located, the Lower Bay and Narrows, where the Atlantic Yacht Club races are held, and the open Sound off Larchmont and Greenwich, are by no means suited for small and lightly built launches;

The summer population of this region is intent primarily on sport and recreation, numbering many wealthy men from all parts of the country whose island homes are only rivalled in cost and elegance by the yachts which lie at their docks.

OPEN LAUNCH AN OLD FAVORITE.

Naturally enough the small open launch has long been known in these waters, and for some years past some of the fastest boats in the country have been found here. During the present season many new boats of the modern type have been launched, some the work of New York builders, though the Leighton boats are in the majority. The noted *Adios*, though hailing from Syracuse and Onondaga Lake, is a visitor to the river, by way of Lake Ontario

that he might have some racing before the season closed.

MR. KILMER BUYS VINGT-ET-UN II.

One of the new boats that as yet is hardly in racing form is the *Too Easy*, designed by H. J. Leighton, and built by J. L. Leyare, of Ogdensburg, for W. S. Kilmer, of Binghamton, a very enthusiastic motorist and launch owner. She is 34 feet 6 inches over all, with forward raking stem and an ogee torpedo stern that is different from the older Leighton boats; her power is the regular four-cylinder Leighton motor of 25-horsepower, with three-bladed reversing wheel. Mr. Kilmer has been using her about Clayton and this place, getting her into shape for racing, but after the record made by the *Vingt-et-Un II.* at Newport last week, he purchased the latter boat from Smith & Mabley, and ordered her shipped by express to Clayton for the race of to-day.

STANDARD ALSO PURCHASED.

These two launches are now fixtures on the river, and on her way to join them is the third of the trio of American record

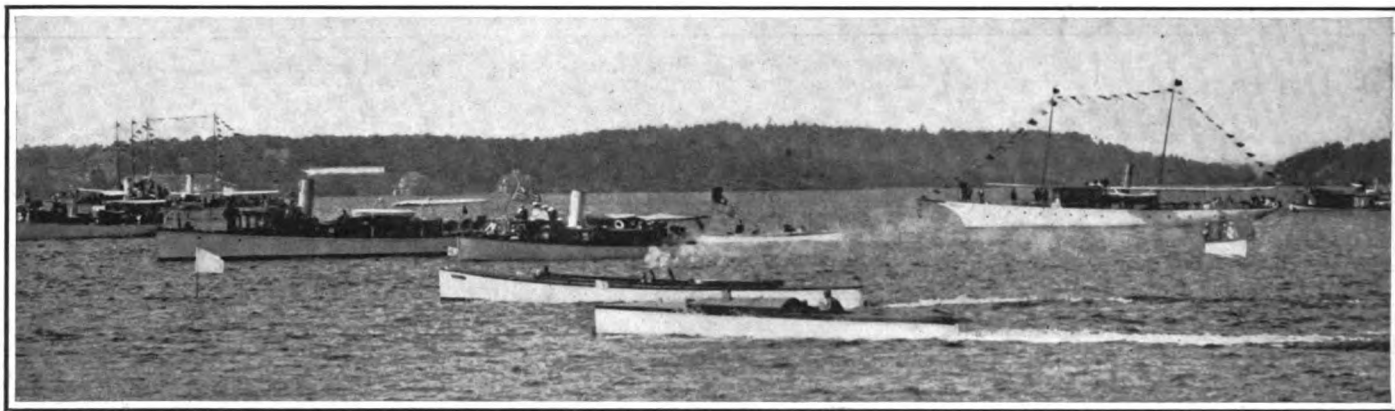

START OF FIRST LAUNCH RACE AT ALEXANDRIA BAY, AUGUST 27.—"VINGT-ET-UN II" IN FOREGROUND, "PRISCILLA" JUST BEYOND.

while all of these points are separated by swift and dangerous tidal waters such as the East River and Hell Gate, through which the launches must pass on their way to and from the races.

CONDITIONS ARE DIFFERENT.

On this great river the conditions are different. The section of the St. Lawrence between Kingsbridge and Ogdensburg, the sixty miles of the Thousand Islands district, is the natural paradise of the racing launch. The waters are non-tidal, the height merely varying by a foot or so in different seasons, so that stages and boathouses are designed for about one level. Though there is a constant downward current, running up to very high speeds in some of the famous rapids of the lower river, this is a negligible quantity above Ogdensburg, and there are many quiet courses where no current is perceptible. The natural conditions are always picturesque, often wild and romantic, but at the same time the whole region is inhabited; apart from the towns and the many large hotels, every island has its dwelling, varying from a canvas tent to the most magnificent stone villas and castles.

and the New York canals, and she has taken part in several races of late. Two sister hulls, the *Carmencita* and the *Priscilla*, are powered with similar motors of four instead of eight cylinders, 60-horsepower.

RACING BOAT COMANCHE.

It was expected early in the season that the honors of the racing would go to a new auto boat, the *Comanche*, designed and built by the Gas Engine & Power Co. and Charles L. Seabury & Co. for S. H. Vandergrift, of Pittsburg, owner of the Seabury steam yacht *Cherokee*, the launch being built under a guarantee of 30-mile speed. With an over-all length of 66 feet the light hull of triple veneer carried nine cylinders, each with ten inches bore and eight inches stroke, everything being sacrificed to speed. In her trials about a month since in New York waters, the *Comanche* failed to make the contract speed by several miles, and it is reported that four connecting rods were broken; so that she was not accepted. Yesterday the *Adios* was purchased by Mr. Vandergrift, the price being \$10,000, in order

holders, the *Standard*. She has just been purchased by Price McKinney, of Cleveland, Ohio, who will use her among the Thousand Islands. In the hands of keen and enthusiastic private owners, with time and money to follow up the sport to the last limit, these three boats are likely to fight out the battle of speed to the end.

AUTO BOAT RACING.

The race was under the management of the new Frontenac Motor Boat Racing Association, with silver cups as first and second prizes under the A. P. B. A. rules. The course was a triangle, run three times to make twenty miles. The wind was strong down the river, kicking up a sea which hindered the smaller boats and cut down the speed of the larger. A very large number of spectators was present in launches, steam and sailing yachts and on the excursion steamers. The river towns, both of New York State and Canada, are noted for the general interest in all aquatic sports, and as in the old days of the sailing skiffs all hands turned out. The established reputation of *Adios* and the news of the recent achieve-

ment of the *Vingt-et-Un II.* at Newport aroused a lively interest in the pair, while local rivalry centered about the smaller launches. Unfortunately a pipe in the circulating system of the *Vingt-et-Un II.* was cracked in transit, and it gave way about a quarter of an hour after the start of the first race, a handicap for launches of under 60 rating; this put two cylinders out of commission and put the boat in fourth place. *Too Easy* won, her time being 1 hour, 5 minutes, 7 seconds, with *Priscilla* second, *Pappoose* third, *Picton* fifth; *Roma* and *Radium* withdrew. *Pappoose*, owned by Mr. Fitzhugh, of Brooklyn, is 40 feet by 4, with a Barber motor, four cylinders, 32 horsepower, cylinders 6 1-2 by 6 1-2 inch; *Radium*, owned by Dr. E. E. Campbell, is of similar model.

The second race, for launches under 60 rating, brought out the *Kitten*, owned by George Hall, of Ogdensburg, a Leighton boat, 21 feet 10 inches long over all, with 7-horsepower motor. *Teal*, designed and built by Captain H. S. Johnson, of Clayton, 24 feet 8 inches over all, with the same motor. *Sure Thing*, *Yenadize* and *Putsey*. *Teal* won, her time being 1 hour, 20 minutes, 57 seconds; or 15 miles an hour. She is a very staunch and able little launch, of handsome model, with no freak features, and strongly and substantially built. She is particularly buoyant and dry in rough water.

The final race, an open event, proved a disappointment owing to the absence of the *Vingt-et-Un II.*, only the *Adios* and the *Priscilla* competing. The latter made a good race, holding the lead over the first round, but the *Adios* finally won in 57 minutes 5 seconds.

On Thursday, Friday and Saturday of the week ending September 3, a series of races for all classes of power yachts and launches will be held here, under the A. P. B. A. rules, and the *Adios*, the *Standard* and the *Vingt-et-Un II.* will meet in what will probably be the great event of the year.

LAUNCH RACING AT MILTON POINT.

A special race of autoboats has been arranged for Sept. 3 under the management of the American Yacht Club, the course being a triangle on Long Island Sound. The new autoboat designed and built by Robert Jacob for W. K. Vanderbilt, Jr., which was launched on Aug. 25, will enter, and also the *Challenger*, which returned from Europe about a week since. A new *F. I. A. T.* will probably be ready, designed by Burgess & Packard, and the Boston *Mercedes*, of the same designers, owned by H. L. Bowden, will start. The new Vanderbilt launch is 40 feet over all, with an almost plumb stem but a long tapering stern, the hull is lapstrake and she is fitted with a 60-horsepower Mercedes car motor.

Twenty-seven automobiles are owned and operated in Columbia, S. C., but no efforts are being made toward the formation of a club.

Paris-Trouville Boat Race.

Results of the six days' auto-boat racing from Paris to the sea, down the River Seine, conducted August 20, show a victory for *Mercedes IV.*, which won the race of 220 miles in a total running time of 7:34:16. She not only won the race, but she made the fast run each day of the six stages, with the exception of the fifth day, on which she was beaten by *Hotchkiss* by 1 min. 32 sec. Second prize in the race fell to *Hotchkiss*, whose total running time was 8:58:56. The *Trèfle-à-Quatre* ran second the first day, beating *Hotchkiss* 9 min. 1 sec., but on the second day her time was two hours slower than that of *Hotchkiss* and almost exactly double that of *Mercedes IV.* On the third day she was withdrawn to be put in shape for the Gaston Menier cup race at Trouville on Sunday following the conclusion of the Paris-Trouville race. The *Gardner-Serpellet*, the only remaining boat in the class for racers from eight to twelve meters in length, also retired the third day.

First prize for launches under eight meters was won by *La Rapée II.*, by a big margin in the total running time of 9:38:05. She finished first on each of the six days, her running time on every day but the first being less than two-thirds of that of her nearest competitor, *Louloute*, winner of second prize in 13:52:04. The remaining boats in this class, *Titan II.* and *Princesse Elisabeth*, both retired before the end of the contest.

Channel Race Notes.

PARIS, Aug. 16.—It has been ascertained that the cause for the failure of the *Hotchkiss* in the Cross Channel motor boat race, August 8, was to be found in the inexcusable carelessness of her crew. She was equipped with magneto ignition, and the contact breakers had been worn during the extensive trials given the boat before the race. By oversight or neglect these had not been looked after, and during the race three out of the four blew out, completely disabling the boat for the time being. The accident was greatly to be regretted, as the boat showed great speed in the early part of the race, and was apparently faster than the *Mercedes IV.*, the ultimate winner. The speed of the latter, 21.87 knots, was equal to 25.17 statute miles per hour.

The trouble with the *Trèfle-à-Quatre* is said to have been due to the almost total choking of the inlet pipe by a bunch of cotton waste, which had been drawn in or else left there and forgotten. As the *Trèfle-à-Quatre* had lately passed into English hands, naturally many Frenchmen think that if she had stayed in her native country she would have won the race.

The *Mercedes IV.* is fitted with a 90-horsepower Mercedes motor of 170 mm. bore by 140 mm. stroke. Her time of 1:00:07 2-5 for the 22 nautical miles across the Channel has only once been beaten by any

craft, and that was by the 9,000-horsepower turbine passenger steamer *Queen*, which in this race conveyed many of the spectators. The *Napier Minor*, which finished second in 1:05:25, has cylinders 165 mm. bore by 152 mm. stroke. Her length is 10.66 meters as against 12 meters for the *Mercedes IV.*

In the cruiser class a great diversity of design was shown, especially in the proportion of cylinder sizes to length of hull. The winner, the *Vas-y*, is 10.5 meters long and her engine is 135 mm. bore by 130 mm. stroke. Her time was 1:57:19.

A noticeable feature of most of the boats as compared with American motor boats was the more complete protection of the machinery from water, many of them having a metal hood over the forward part of the cockpit. It would seem from the results of the race that this feature ought to be applied to all boats of high speed, and that protection ought also to be afforded the occupants. It is probably necessary also to provide some means of muffling the exhaust of the motors, which in the case of the larger boats made an almost unbearable racket.

Much remains also to be done in the matter of hull design to utilize the extreme powers put in these boats. The *Napier Minor* in particular is almost smothered with spray when going at speed, whereas the *Mercedes IV.* and the *Trèfle-à-Quatre* go through water with comparatively little fuss.

English G. B. Notes.

At the meeting of the Races Committee of the A. C. G. B. I. entries were received from Messrs. S. F. Edge, Ltd., Lionel de Rothschild, John Hargreaves and Lt.-Col. Mark Mayhew for the forthcoming Gordon-Bennett race, for which the A. C. G. B. I. has formally challenged the French club. As Mr. Hargreaves only entered provided there were selection trials, it was decided to arrange an eliminating race, in connection with the next Gordon-Bennett event and Mr. Orde was instructed to visit the Isle of Man and other proposed routes in Yorkshire and Bristol, with a view to their suitability. It is also interesting to note that the English club proposes to hold another race, presumably on the Manx course, next year on the lines proposed by Claude Johnson for the alteration of the Gordon-Bennett event. This race will most likely have an international character.

"Herbert has been running an auto so long that he has forgotten all about horse-back riding."

"What did he do when the horse balked?"

"He crawled under it to see what was the matter."—*Cleveland Plain Dealer.*

Civic officials in Paris have decided to place a tax on motor vehicles offered for hire in the streets after the manner of horse-drawn cabs. Heretofore no tax has been placed on such cars.

THE AUTOMOBILE

VOL. XI.

No. 10

Published every Saturday by

THE CLASS JOURNAL CO.,
Flatiron Building, Madison Square,
NEW YORK CITY.

Cable Address - - - Autoland, New York
Long Distance Telephone - 300 Gramercy, New York

SUBSCRIPTION RATES:

United States, Canada and Mexico, - One Year, \$2.00
Other Countries in Postal Union, - One Year, \$3.00

To Subscribers—Do not send money by ordinary mail.
Remit by Draft, Post-Office or Express Money Order,
or Register your letter.

FOREIGN SUBSCRIPTION AGENTS:

ENGLAND:—Hiffie & Sons, Limited, 3 St. Bride Street,
Ludgate Circus, London, E. C.

FRANCE:—Boyveau & Chevillet, 22 Rue de la Banque,
Paris.

GERMANY:—A. Seydel, Mohrenstrasse 9, Berlin.

To Advertisers—Copy or changes in orders for advertisements should reach us not later than 5 o'clock p. m. Monday for the issue of Saturday following.

Copyright, 1904, by The Class Journal Company.
Entered at New York, N. Y., as second-class matter.

The Automobile is a consolidation of The Automobile (monthly) and the Motor Review (weekly).

Copies Printed This Issue, - - 12,000

“ “ Since Jan. 1, - 433,300

Vanderbilt Race Precautions.

In the permit voted by the Nassau County supervisors for the holding of the Vanderbilt Cup race, the following clause occurs among the conditions on which the race is permitted:

“At all railroad crossings, cross-roads, and at all traveled set-offs from the afore-said highways, a flagman shall be stationed and equipped with a red and white flag and a white one. It shall be the duty of each flagman between the hours of 5 a.m. and 3 p.m. on said 8th day of October, 1904, to warn every person using said highways that the speed tests of the American Automobile Association are being conducted and that the roads upon which the said flagmen are stationed are set apart for the purpose of said speed tests. Each flagman shall be further instructed to constantly wave in full sight of any person on said highways or approaching said highways along any intersecting road a red and white flag so long as any motor vehicle is in sight approaching the station at which such flagman is placed, and when no vehicle is in sight approaching such station to keep in view a white flag.”

We are informed by Chairman Pardington of the Racing Board of the A. A. A. that the foregoing represents only in a tentative way the precautions which will be taken to safeguard the course. The flagmen and others stationed to keep it clear

will be chosen so far as possible from the local constabulary, and when not regular constables they may not improbably be sworn in as special deputies. The turns will be oiled, and therefore free from dust. Notices warning all persons off the course for the day of the race will be posted, beginning September 15, at every crossing, in every hotel, and in every postoffice along the route; and advertised warnings will appear in the local papers from September 1.

What further precautions to keep the course clear may be taken is not now known, as the arrangements are not yet completed, but we are convinced that every automobilist of experience will agree with us that the foregoing, though excellent so far as they go, are by no means sufficient. They might serve in France, where the peasantry is accustomed to such affairs, but the American public at large has no conception of what a mile-a-minute speed on the highway signifies. Without the most stringent regulations, and ample means to enforce them, it will be impossible to keep the crossings clear at the proper times. There are not a great many crossings from which an approaching car can be seen a mile away; and yet, except where slow-downs are necessary, a mile will be the absolute minimum of clear view to make a crossing safe. Sixty seconds is none too much to allow a heavy wagon to get across the road. Where the approaching view is less, crossings should be absolutely barred to all vehicles; and in this land of the free the only way to bar them will be to erect barriers—iron posts and wires—the night before the race, and station a constable at each crossing. Pedestrians, doubtless, may be allowed to cross, but it will in every case be necessary to watch carefully for the possible coming of a second car in the dust of the first, and this applies especially to crossings open to vehicles.

Assuredly the safest plan would be to bar all crossings, large and small, as was done in the Irish Gordon Bennett race, but, if this be impracticable, at least an announcement can be made in advance, naming the crossings to be closed and those to be kept open. This will save trouble for public, constabulary, and contestants.

The contestants, indeed, are rather apt to be forgotten in discussions of this sort. The A. A. A. owes a duty to them, to make their work as safe as possible, just as surely as it does to the unsophisticated public.

Automobilists, both those intending to compete in the Vanderbilt Cup race and others, are requested by the Race Committee to refrain rigidly from speeding their machines on the cup course before the race. Not only would this be an act of discourtesy to Nassau county, and a very poor return for the favor granted by the latter, but, if any serious accident should occur from such speeding, it will result

in the race being definitely called off. Mr. Pardington, in making this announcement, points out that the course can be surveyed as well from a touring car as from a racer, and much more safely. It is to be hoped in the interest of sport and fair play that the request will be generally heeded.



Road Law Amendment.

There is nothing spectacular about highway legislation. It is as important in its way as pure food legislation, and perhaps more important, because less difficult to enforce than the trust-busting variety. But it gives no chance for fireworks, and we may doubt if one in 500 of the citizens of New York State has heard of the recent changes in the Highway Law of that State, from which the friends of good roads hope for notable improvement in the roads of the Empire State.

These changes, however, have little or nothing to do with the building of new roads; for the needed facilities in that direction we must look to the hoped-for passage of the constitutional amendment authorizing a \$50,000,000 highway loan. But there has long been crying need of a system, in place of the lately existing chaos, for maintaining the improved roads already built and building.

Up to this year, practically all the highways of this State, outside of the cities and incorporated villages, have been cared for by the highway commissioners of the several townships; and these commissioners, even when the roads had been built or were being repaired with State aid, were accountable to no authority save their own local constituents. As it happens, road building is something of a science, and many of these commissioners, even with the best intentions, have not known how to utilize the resources at their disposal. Again, with county and State defraying 35 and 50 per cent. of the cost of a new road, the temptation is strong for a town to put all its road money into new construction, and then neglect to keep it up.

The anomalous situation, of the largest contributor to the road cost being unable to protect its outlays from being wasted, has been corrected by the addition of Sections 55c and 55d to the county road law. In effect, these sections bring the repairs of roads built or maintained by State aid under the control of the county engineer, if there be one, or of the State engineer direct when there is no county engineer, whenever in the judgment of the State engineer this step is demanded for the proper care of these roads. The county engineers are appointed and may be removed by the Boards of Supervisors, but their management of the highways is subject to the approval of the State engineer. Till now they have had no means of enforcing their recommendations, and have frequently been mere figureheads; but now, if the highway

commissioners neglect the roads in their care, the county engineer may cause the same to be repaired by the county, and the cost either charged to the county or added to the next tax levied by the county on that town. Moreover, the State engineer may withhold from any town neglecting its State aid roads whatever State moneys it would otherwise be entitled to for either repairs or new construction.



About two months ago we called attention to the danger as well as annoyance created by the thick dust clouds raised on the turns of tracks during races. Since then the inevitable fatality has occurred to make it plain that this dangerous nuisance has been too long winked at. Nothing could be more ominous than the fatal ease with which Barney Oldfield, momentarily blinded in the trail of another car, crashed through the pole at St. Louis, August 28. Any driver is at any time liable to do the same, unless the track be properly wet-trimmed, oiled or sprinkled. In the case at St. Louis, our correspondent reports that the management desired to wet the track, but the contestants protested, saying they did not want to race in mud. The safety of all, public and performers, demands that the laying of dust by a modern process be obligatory and it is plainly a case where the A. A. A. should make suitable regulations for future protection.



The statement on another page by a well-known French builder of bodies, that he has found aluminum too brittle a material to be durable, will surprise a good many builders and users on this side of the water, whose experience—shorter, it is true—does not coincide with that quoted. Nor does the latter seem to be borne out by the practice of the other distinguished builder quoted in the same article, nearly all of whose bodies we understand to be aluminum. The question seems to be still unsettled.



It begins to look after all as if the European automobile makers are the only ones who believe they can gain any lessons in design and construction from long distance road races and secure valuable advertising without breaking the laws.

The New York and Chicago Road Association has printed a report of its Erie Convention, held last March in the interest of continuous lines of improved interstate highways. The report includes addresses by Col. Albert A. Pope, Senator A. A. Latimer, of North Carolina; Hon. Horatio S. Earle, of Michigan; James H. Macdonald, of Connecticut; John Farson, and a number of others, all prominent men influential in the good roads cause. Copies of the report may be had free by writing W. L. Dickinson, Springfield, Mass., or Arthur H. Battey, 154 Nassau street, New York city.

THE AUTOMOBILE.

THE AUTOMOBILE.

THE AUTOMOBILE.

THE AUTOMOBILE.

THE AUTOMOBILE.

THE AUTOMOBILE.

John Farson Arranges Demonstration for Information of City Officials.

Special Correspondence.

CHICAGO, Aug. 29.—The habits of Streeterville were given a genuine new-fashioned automobile brake test and racing exhibition last Friday, and they enjoyed it quite as much as did the city officials and the members of the Chicago Automobile Club, who participated.

The tests were under the supervision of President John Farson and F. C. Donald, chairman of the racing board of the club. Nine cars left President Farson's downtown office promptly at 2 o'clock in the afternoon, and a short tour of the crowded downtown district was made in order to give the city officials and the newspaper men an idea of the difficulties encountered in threading a way through the wagons and drays and carriages and street cars and over the rough pavements.

President Farson, with his 60-horsepower Apperson, led the way, followed by his Thomas and his Packard, making a patriotic display of red, white and blue, these being the respective colors of the cars. After the Farson fleet came Director F. C. Donald, Pope-Toledo; Secretary Sidney S. Gorham, Winton; John E. Fry, Apperson *Jackrabbit*; Chas. H. Tucker, Winton four-cylinder; Charles Shanks, Winton; Paul Picard, Renault. Among the guests were City Electrician Ellicott, Health Commissioner Dr. Arthur C. Reynolds, Assistant Corporation Counsel John C. Beckwith and several representatives of the daily newspapers.

After the brake tests a few exhibitions of speed were given by the two Apperson cars, the *Jackrabbit* slightly distancing the big sixty, which was encumbered by a top. The cyclometer registered 40 miles in this little brush, but the fat policeman on duty never blinked an eye—in fact, he rather enjoyed it and made the small boys stand behind him so he could see better.

The result of the brake tests was as follows:

The 24-horsepower, four-cylinder Winton touring car, weight 2,380 pounds, running at 10 miles an hour, stopped at 6 feet; at 12 miles stopped at 17 feet; at 15 miles stopped at 24 feet; at 20 miles stopped at 40 feet; at 29 miles stopped at 84.6 feet.

The 60-horsepower Apperson car, weight 4,000 pounds, running at 10 miles an hour, stopped at 16.9 feet; at 26 miles an hour, stopped at 67.6 feet; at 37 miles stopped at 132 feet.

The 24-horsepower Thomas car, weight 2,250 pounds, running at 9 miles an hour, stopped at 9.7 feet; at 25 miles an hour stopped at 84 feet.

The 24-horsepower Pope-Toledo car, weight 2,300 pounds, running at 10 1-2 miles an hour, stopped at 19.4 feet; at 11 miles stopped at 10.5 feet; at 14 miles stopped at 21 feet; at 22 miles stopped at 64.4 feet; at 30 miles stopped at 120 feet.

The 24-horsepower Packard car, weight 2,200 pounds, running at 10 miles an hour, stopped at 9.7 feet; at 15 miles stopped at 24.4 feet; at 28 miles stopped at 82.6 feet.

A. C. A. COLLECTS STATE LAWS.

The Automobile Club of America has just published in pamphlet form the complete text of all the State laws on automobiles in the United States. The States having such special laws comprise Alabama, Connecticut, Delaware, Illinois, Iowa, Kansas, Kentucky, Maine, Maryland, Massachusetts, Minnesota, Missouri, New Jersey, New York,

Ohio, Pennsylvania, Rhode Island, Vermont and Virginia. Other States have no such laws, or local ordinances only. As the latter, in States with and without State laws, are frequently changed, no attempt has been made to include them. Occasional foot-notes and italicized passages assist to an interpretation of the laws printed, and a good index is added.

GOVERNOR HERRICK HALTED

Gets Called Down by Cleveland Policeman and Promises to Be Good.

Special Correspondence.

COLUMBUS, O., Aug. 31.—Governor Myron T. Herrick, of this State, is making a name for himself as a motorist. At 6:50 a. m. today he started in his touring car from his residence in Cleveland for Wooster, a distance of sixty-five miles, and arrived at his destination at 10:10 o'clock, which breaks all records between the two cities. As the condition of the road is not conducive to speed, the time is fast.

The governor makes many trips in his automobile to fill engagements in various parts of the State. He is an expert and fearless operator, and he loves to go at a fast pace. In fact, whisper it softly, he sometimes goes more rapidly than the city ordinance allows. A few days ago Policeman Golden, of the Cleveland police force, called up the governor by 'phone, stating that he had violated the speed ordinance and vouchsafing the information that if he transgressed in this respect again he would put him in jail. "Well, if you do that," laughingly replied the chief executive, "I'll pardon myself out." However, he promised Golden he would be good hereafter.

PENNSYLVANIA WAKING UP.

Good Roads Movement Growing—Legal Aid is Invoked.

Special Correspondence.

PHILADELPHIA, Aug. 29.—Commissioner Hunter, of the State Highway Department, is encouraged over the recent workings of his department. For several months following the passage of the Sproul good roads bill, applications for State aid in building roads were almost nil; but now no less than forty-four counties in the State have applied for assistance from his department. The department has already awarded contracts, or advertised to award for sixty-seven miles of road, and plans for upwards of seventy additional miles are well advanced.

The demand for good roads is becoming so insistent in some sections that the law has been invoked in order to spur the proper officials to do some work in that direction. On Saturday last District Attorney McBride, of Venango county, announced that he had prepared indictments against the three commissioners in each of the five townships of Sugar Creek, Irwin, Victory, Scrubgrass and Jackson for "maintaining a common nuisance" in that they had failed to keep certain specified roads in repair. Several recent similar instances are also on record in various parts of the State, action in all cases being taken by the farmers and tradesmen who have occasion to use the roads frequently in all sorts of weather.

There are many automobiles in Quincy these days, but they do not belong to the people who laid the foundation for the present beautiful Quincy—they are all broke and have to walk.—*Quincy (Ill.) Review.*

RACING AT OMAHA.

Records Broken and Start and Stop Races Please the Crowd.

Special Correspondence.

OMAHA, Neb., Aug. 26.—In the second day's racing at the Sprague Street Driving Park yesterday Barney Oldfield, driving the *Green Dragon*, again reduced the world's records for one mile and five miles on a half-mile track. These figures now stand at 1:12 4-5 for the mile and 6:23 1-5 for five miles. The pair of tied races run between Oldfield and A. C. Webb on Tuesday were run off yesterday, with the result of Oldfield winning by a margin of 11 3-5 seconds in the five miles.

Later on Webb, in a special challenge race for four-cylinder machines, drove a Pope-Toledo stock car owned in Omaha, and while driving it he met with the only accident of the two-days' meet. One of his right tires came off, and immediately afterwards the rim broke and the automobile, going down on its right side, swung to the left and broke through the fence, narrowly missing a couple of boys. Webb, however, was unhurt.

Most of the other races were amateur events with stock cars. These began with a closely fought two-mile contest between a Rambler driven by Arthur Gardner and a Franklin driven by H. E. Frederickson. The latter won by a length in 3:08. A stop-and-start race for fully equipped cars, each carrying four passengers, afforded a good deal of entertainment. The requirement was that the cars should stop in front of the grand stand, discharge and take on their passengers, and start the engine, every half mile for two miles. The race was won by Frederickson in 6:05 3-4. The second man, Tom Brownell, driving a Rambler, lost much time through nervousness in starting. The Australian pursuit race brought out a Franklin, driven by Frederickson, a Rambler driven by Arthur Gardner, and a White steamer, with Frank Decker at the wheel. It was won by Frederickson after a chase of ten miles, the Franklin closing up the quarter of a mile separating it from the Rambler and winning the race. In a five-mile race between the same three machines the tables were turned on Frederickson after he had led for 4 1-2 miles, as in the last lap Gardner managed to get past him and won by two lengths in 8:05. After that the steamer was driven an exhibition mile in 1:37, and finally it won a five-mile race from a Thomas car in 9:43.

The attendance was about 2,500, and the meeting was a pronounced success, which no doubt will be followed by many others. It was announced after the first day's meet that Mr. Frederickson had purchased the *Green Dragon*, with which he expects to compete on the track next year. He will not receive the machine until February, after this year's track events are over.

PITTSBURG MEET SEPT. 23-24.

Special Correspondence.

PITTSBURG, Aug. 30.—G. E. Turner, chairman of the race committee of the Automobile Club of Pittsburg, has announced that arrangements have practically been completed for the automobile race meet to be held at Brunot's Island Sept. 23 and 24. The meet will be given under the auspices of the local club and the rules of the A. A. A. will govern. As arranged, the program calls for eight events for each of the two days, for which silver cups will be awarded to the amateurs, and cash prizes to the professional winners. The character of the events will be much the same as in the recent races at Detroit, Cleveland and Buf-

falo. Special arrangements are being made in regard to transportation facilities to and from the track. Members of the race committee associated with Mr. Turner in charge of the arrangements are: W. L. Dickson, W. J. Lewis, E. J. Kent, W. L. Elkins and W. H. Nimick.

DAYTON PASSES LICENSE ORDINANCE.

Special Correspondence.

DAYTON, Ohio, Aug. 27.—The City Council has passed an ordinance which provides that automobile owners shall pay a license of \$3 a year for the privilege of operating automobiles over the city streets. The ordinance also provides that all automobiles shall be numbered.

The city council has also passed an ordinance regulating the speed of automobiles to eight miles an hour in the business district and fifteen miles an hour in the thinly settled residence district. James Cox, a prominent member of the automobile club and the owner of the *Daily News*, was the first driver to be arrested for violating the ordinance. He was fined \$5 and costs in police court.

The city council of Troy, Ohio, has passed an ordinance prohibiting the running of automobiles over city streets at a speed greater than eight miles per hour.

INTERNATIONAL MOTORCYCLE RACE.

The Motorcycle Club of France has inaugurated an international contest, offering a trophy cup and inviting all foreign clubs to compete for it. The first contest is scheduled for Sept. 25, 1904, on a fifty-four kilometer circuit in the Department of the Seine-et-Oise. The race will be five times around the circuit, making 270 kilometers. The French elimination trials for this race will be held Sept. 11, over this course. Under the rules governing the contest, each club can be represented by two or three entrants, the machines not to weigh more than fifty kilogrammes, and each machine must have been constructed in the country it represents. Entries are received at the club quarters, 56 Rue Pergolese, Paris.

FRANKLIN PROTEST SUSTAINED

Judges, Award in Philadelphia Races Changed after Long Delay.

Special Correspondence.

PHILADELPHIA, Aug. 24.—After having given the matter three months' consideration, A. R. Pardington, chairman of the Racing Board of the A. A. A., has notified the Automobile Club of Philadelphia, one of the promoters of the race meet at Point Breeze race track on May 28 last, that the protests of the Franklin Mfg. Co., against the decision of the referee, H. Bartol Brazier, has been sustained.

It will be recalled that the Philadelphia Automobile Club sent out its first program with a simple weight classification, and afterwards sent out a second entry blank in which certain races were changed for stock cars. The Franklin Company entered its 10-horsepower racing machine under the original classification for events Nos. 2, 4 and 8, the first two of which were among those changed. On account of this change the referee refused to award the Franklin Company the prizes for winning these two events.

In the letter accompanying the decision Mr. Pardington says:

"A careful review of all the evidence at hand makes it apparent that the Philadelphia Club was technically in error in changing its original form of entry.

"The adoption of weight classification in this country followed its successful use during a period of a number of years in France. Where the classification has been applied in this country during the present year, general satisfaction has resulted. The introduction of a stock class into a race meet programme immediately makes it possible for the manufacturers to resort to all methods and devices to reduce the weight of his car, change its method of ignition, lubrication and gear, with the result that in some cases the car has been weakened beyond the point of safety. Under weight classification the manufacturer builds his car with the idea of having it compete, either in the class for which it is constructed or in the class next

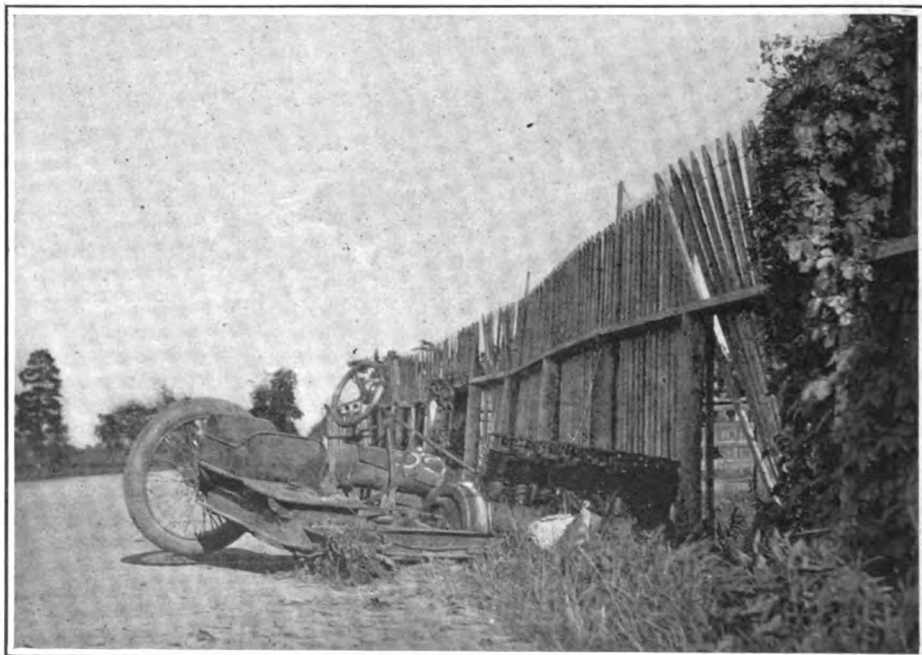

The accompanying reproduction of a photograph shows the wreck of the Premier racing car *Comet*, which was smashed up in collision with the fence in the Cleveland automobile races at Glenville track, Aug. 22. The car was driven by Carl Fischer, who was not hurt in the mishap. The *Comet* was an eight-cylinder air-cooled special racing car built in Indianapolis, in which city Mr. Fischer lives.

above, accepting as a handicap his entry in the next succeeding class."

The finding of the Board is that:

First—The promoter was in error in altering and amending the original form of entry on which the sanction was granted.

Second—That the entry of the Franklin Mfg. Co. was strictly legal, regular in form, was accepted by the promoter, and that the promoter failed to notify the entrant in order that he might withdraw. The entrant having no right to accept the modified form of condition, as had the promoter no right to so modify the original condition.

Third—That the Franklin Mfg. Co., with its declared entry, won events Nos. 2 and 4 and is entitled to the awards incident to his successful competition.

Fourth—That the decision and ruling of the referee is not sustained for the reasons given above.

Fifth—That the protest and appeal of the Franklin Mfg. Co. is sustained, and his protest fee (\$10.00), is herewith returned to him under Rule 43.

No cognizance is taken of Event No. 8, as the entrant who won did not declare his

INSPECTION BY AUTOMOBILE.

Congressional Visitors Are Escorted by Twin City Auto Owners.

Special Correspondence.

MINNEAPOLIS, Aug. 26.—Twin City automobile owners placed their machines at the disposal of the congressional committee on rivers and harbors, which spent the day in the two cities. The primary purpose of the visit was to inspect the work at the Government dam, which will make the Mississippi navigable from St. Paul to Minneapolis.

Upon their arrival at the union station, Minneapolis machines were in waiting. After luncheon at the Commercial Club the party was taken to the dam by way of Lake Calhoun and Harriet, Minnehaha Parkway and Minnehaha Park.

After listening to the merry note of "laughing waters" the party continued down Minnehaha avenue, to the Franklin avenue bridge, and then up to the dam by way of the east river bank drive.

At the dam the Congressmen were met by

usual program of trotting and pacing events which annually enthrall the farmers thereabouts. The races are scheduled for Wednesday and Friday, Sept. 7 and 9. Entries (for which no fees are required) close Sept. 3. The prizes will be cash—\$30 to first and \$20 to second—or cups of equal value, as winners prefer.

ILLINOIS-WISCONSIN CLUB RUN.

Special Correspondence.

MILWAUKEE, Aug. 29.—Fifty-two members of the McHenry, Ill., Automobile Club made a run to this city from Woodstock, Ill., arriving Saturday night and remaining until Sunday morning, when they started on their return trip via Waukesha, through the beautiful lake region of Wisconsin. The party occupied sixteen machines, none of which had any serious mishaps en route. The first stop was made at Lake Geneva, where luncheon was served, and considerable time was spent at Waterford.

Occupants of the several cars were as follows: Dr. Emil Windmuller and Eugene R. Hoy; Geo. C. Murphy, A. P. P. Bert-



AUTOMOBILISTS IN MINNEAPOLIS AND ST. PAUL ENTERTAIN CONGRESSIONAL COMMITTEE ON RIVERS AND HARBORS ON INSPECTION TOUR.

entry at the time of declaring in events 2, 3 and 4. It is presumed that this was a post entry, declared and accepted as such.

(Signed)

A. R. PARDINGTON, *Chairman.*
S. M. BUTLER, *Secretary.*

LEGAL SITUATION IN WILMINGTON.

Special Correspondence.

WILMINGTON, Del., Aug. 30.—Because of the complicated municipal government of Wilmington, the work of passing a local law regulating the operation of automobiles in the streets has to be done all over again. As was reported, a resolution was started in the Street and Sewer Department, which has control of the city streets, but since that time City Solicitor Robert G. Harman has returned from his vacation and has decided that the form of resolution had better be changed, and also that the City Council should pass an ordinance on the subject. Consequently, it is likely that both bodies will take action, in which event, in the opinion of the city solicitor, the law will be binding, even should the matter be taken to the courts.

A movement has been inaugurated here looking toward the formation of an automobile club, the object of which will be to look after the interests of owners of machines, so far as legislation and legal matters are concerned, and also to take an interest in good road work.

St. Paul automobilists, and with them continued on to the Saintry city.

The party was made up of the following:

Theodore E. Burton, of Ohio, chairman of committee; Boswell P. Bishop, Michigan; E. F. Acheson, Pennsylvania; De Alva S. Alexander, New York; J. H. Davidson, Wisconsin; Wesley L. Jones, State of Washington; J. Adam Bede, Minnesota; S. M. Sparkman, Florida; George F. Burgess, Texas; J. H. Cassidy, Washington, secretary; J. H. McGann, Washington, clerk of committee; General Alexander Mackenzie, chief corps of engineers. From St. Paul were Congressman F. C. Stevens, Major George Derby, government engineer in charge of this district; Major John Espy, vice-president of the Upper Mississippi Improvement Association; Louis Betz, city controller. From Minneapolis were Mayor J. C. Haynes, Wallace G. Nye, secretary of public affairs committee; E. J. Westlake, secretary of the Commercial Club; T. W. Stevenson, vice-president of the club; former Congressman Loren Fletcher, John S. McLain, and the following members of the public entertainment committee: Chairman, Henry Deutsch, Asa Paine, George E. Higgins, H. R. Yerxa and C. N. Chadbourne.

PENN STATE FAIR RACES.

Special Correspondence.

PHILADELPHIA, Aug. 29.—The Pennsylvania state fair, at Bethlehem, will have a series of automobile races to help out the

schey, A. J. Mullen and W. W. Chandler; Marvin Sherman, C. V. Sherman, L. F. Sherman and F. A. Walters; F. M. Sunverlin and E. B. Losee; Lester Moreland and J. M. Gardner; A. J. Alson, Dr. Lawrence, Postmaster Chas. F. Renich and Charles Hayes; Harry Cross and F. A. Arnold; Stephen Hoor and Geo. Griffiths; John Whitworth and Emil Arnold; F. W. Buell and J. C. Wells; C. F. Hendricks and M. J. Walsh, of Harvard, Ill.; J. J. Pountain and Asa Udell; Ed. R. Conyes, of Harvard, and Frank Wilcox; A. S. Towne, of Harvard, Richard Phalen and E. B. Manley; Dr. C. M. Honson, of Harvard, and George Manley; E. G. Westerman, of Greenwood, E. W. Toles and Lisle Freeman.

"For the size of the town I believe Woodstock has one of the most enthusiastic as well as largest automobile clubs in the West," said W. W. Chandler, manager of the Woodstock *Herald*. "These runs are annual affairs with us, but this is our first experience this way. The roads were unusually good until we came near Milwaukee, where we had a novel experience. We passed through a toll gate where we all had to pay toll. This is something we were greatly surprised to find, and if any of the party believed that the toll road would be better than those over which we had been passing they were greatly mistaken, inasmuch as we were compelled to plow through from three to four inches of dust for a distance of about five miles. I will say, however, that despite the unfavorable condition

of the roads in Wisconsin they are better than those of Illinois on the stretch we passed over."

NOTES OF THE CLUBS.

BRIDGEPORT, CONN.—At a recent meeting of the Board of Governors of the Bridgeport A. C., Dr. D. M. Trecartin was elected secretary, filling the vacancy caused by the resignation of Dr. D. R. Beebe.

WILMINGTON, DEL.—An automobile club is in process of formation here. The object of the organization will be to assist in the passage of an equitable automobile law and in the prosecution of violators thereof. Steps will also be taken looking to general road improvement.

NEWPORT, R. I.—The Newport A. C., organized last May, now has a membership of fifty. Among those recently admitted are the following cottagers: Col. John J. Astor, Pembroke Jones, George A. Huhn, Marion Wright, Lisperand Stewart, A. G. Vanderbilt, Edgar L. Winthrop, Jr., Benjamin Thaw, Jr., Joseph Harriman, Lorillard Spencer, Lirillard Spencer, Jr., W. G. Roelker, Walter S. Andrews, W. Watts Sherman, J. F. Pierson, Nathaniel Thayer and Dr. H. J. Knapp.

ST. LOUIS, MO.—At a recent meeting of the St. Louis Automobile Engineers' Club it was decided to work for the passage of an ordinance by which all drivers are required to be at least twenty-one years of age, and thoroughly understand the working parts of their machines. This action was taken as a result of the many accidents which, in most cases, are due to the fact that the drivers were young and inexperienced. The present officers of the club are: Ed Doyle, president; O. J. Savin, vice-president; Fred William, secretary, and Claude Bristow, treasurer.

CEDAR RAPIDS, IA.—At its recent meeting the Cedar Rapids A. C. elected the following officers for the ensuing year: Glen M. Averill, president; R. P. Taylor, first vice-president; O. W. Lyman, second vice-president; G. L. Rothrock, secretary, and J. L. Bever, Jr., treasurer. There are now about forty machines in Cedar Rapids, and an effort is being made to have all owners become members of the club. A banquet will be given by the club at an early date, to which all local automobilists will be invited, whether they are members or not. A country club run and picnic are also on the schedule for an early date.

CHICAGO.—The Chicago A. C. has accepted the invitation of the Grand Rapids A. C. to make a run to that city Sept. 9. Arrangements have been made for round trip rates to Holland, Mich., as well as with the steamboat company for transporting the machines across the lake from Chicago. The Grand Rapids club will meet the Chicago motorists at Holland and escort them to Grand Rapids, where they will be entertained Saturday and Sunday, Sept. 10 and 11. A series of owners' races has been arranged for Saturday, in which members of both clubs will take part. Frank X. Mudd, chairman of the runs and tours committee of the Chicago club, has charge of arrangements for the trip.

There are 438 active members of the Automobile Club of America, 403 of whom are owners of automobiles.

It is proposed to have an automobile section at the next Virginia State Fair, Roanoke, Va. The managers of the fair, in soliciting exhibits, state that outside of the St. Louis Exposition it should be the finest display of the kind ever attempted in the South. The president is Jas. P. Woods, and the manager is Cyrus T. Fox, Roanoke.

INDUSTRIAL

MILWAUKEE PLANT CHANGES HANDS.

Special Correspondence.

MILWAUKEE, August 26.—By the closing of a deal to-day for the purchase, by A. O. Smith, of this city, of the plant of the Federal Manufacturing Company, at Clinton and Park streets, one of the biggest concerns making automobile parts in the United States drops out of the trust and reverts to private ownership.

A. O. Smith, who was one of the original owners of the plant, has for some time been managing the concern for the Pope Manufacturing Co., from which he has now arranged to buy it. Articles of incorporation for a \$200,000 company have been filed with the Secretary of State at Madison under the name of the A. O. Smith Co. The concern will manufacture automobile parts exclusively.

The factory was first established by C. J. Smith & Sons several years ago. A. O. Smith was then the treasurer and general superintendent of the company. In 1899, while still engaged exclusively in the manufacture of bicycles and bicycle parts, the plant was bought up by the American Bicycle Company of New York, commonly known as the "bicycle trust." Last fall this plant, with all the other interests of the trust, was bought by the Pope Manufacturing Company. During all this time Mr. Smith has been retained as manager. The plant is well known throughout the country and some of its pioneer experiments are said to have helped materially to bring automobiles to the high state of perfection in which they exist to-day. Besides having trade relations with all parts of the United States, the concern has enjoyed some patronage in several foreign countries, including England, France, Germany and Japan. For the past two years the factory has furnished automobile parts to such well-known automobile concerns as the Peerless, Olds, Cadillac, Packard, Pope-Toledo, Studebaker, Royal, Mitchell, Rambler, Electric Vehicle Company and the Locomobile Company of America.

GARAGES AND IMPROVEMENTS.

TRENTON, N. J.—The John A. Roebing Sons' Co. have just completed its garage on South Broad street, opposite the Plant's office building.

ANDERSON, Ind.—Clark & Beach have recently opened an automobile and bicycle repair shop at Fourteenth and Meridian streets.

BLOOMFIELD, N. J.—A. P. Heyer has opened a garage at 615 Bloomfield avenue, and has secured the agency for the Pope-Toledo, as well as the sub-agency for the Oldsmobile and several other well-known cars.

QUINCY, ILL.—The Quincy Automobile Company is now occupying new quarters on Vermont street, between Fourth and Fifth streets, where it has established a thoroughly up-to-date garage.

PORTLAND, Me.—A new especially built brick garage has been opened at 12 Forest avenue by H. J. Willard. In addition to handling storage, supplies and repair work, Mr. Willard is agent for the Packard, Knox, Pierce, Autocar, Pope-Hartford, Pope-Tribune, Cadillac and Orient automobiles.

MONTCLAIR, N. J.—C. V. V. Gunther has secured the agency for the Knox cars, and is erecting a building on Bloomfield avenue, near Valley Road, which he will occupy as

a garage and storage station. The garage of H. J. Koehler, on Bloomfield avenue and Willow street, is now nearing completion.

WORCESTER, Mass.—A new garage has been established by Birney A. Robinson on Pleasant street, where a repair car is kept ready to send out to disabled automobilists at any time. Mr. Robinson is agent for the Autocar, Cadillac, Waverley, Locomobile, Peerless, Pope-Toledo and Winton cars.

AKRON, O.—Secretary-Treasurer F. F. Miller, of the Akron Automobile Garage Co., has disposed of his interests in the concern to President A. Auble, Jr., who will be sole manager hereafter. The company was organized last year and is agent for several makes of motor cars.

SPRINGFIELD, Ill.—A. J. Smith and J. B. Stevens have formed a partnership under the name of the Springfield Garage Co., and are now conducting a general automobile repair and storage station on South Sixth street, opposite the Leland. The company has secured the agency for the Elmore cars.

LIMA, O.—William E. Rudy is now conducting a general automobile repair and storage station on North Elizabeth street, the growing needs of his business requiring removal from his former quarters on East Market street. In connection with this he also has the agency for the Ford, Rambler and Pope-Waverly cars, and operates an automobile livery business.

ONEIDA, N. Y.—Theodore Coles has purchased the machine shop and repair business of Frank Smith on Phelps street, and will consolidate it with the Oneida Rubber Tire Works, under the name of the Coles Machine Shop Company. Willard H. Merrill and James B. Backer are interested in the new company, Mr. Merrill having charge of the mechanical department of the business, while Mr. Backer will manage the bicycle and automobile department.

RECENT INCORPORATIONS.

The Kahn-Stern Co., Jersey City; capital \$15,000; to manufacture and deal in carriages, wagons and automobiles. Incorporators, Louis F. Kahn, Emanuel J. Stern and F. Goldenhorn.

Laminated Auto Frame Co., Springfield, Ohio; capital, \$10,000; to manufacture, sell and deal in laminated wood frames for automobiles and other vehicles, and other parts, supplies, and materials for automobiles. Incorporators, Orrin L. Parsons, C. C. Bramwell, Horace C. Keiffer, George C. Lynch and William W. Keifer.

Detroit Auto Vehicle Co., Detroit, Mich.; capital, \$150,000; to manufacture automobiles. Officers and directors: F. H. Blackman, president; J. L. Hudson, vice-president; H. H. Lind, secretary; B. Wurzbarger, treasurer; Frank Huetteman, Sr., H. C. Wiedeman, Elias Aberle, A. W. Schilling, and Charles Engelhard, directors. The company will occupy the plant at 71 Catherine street recently used by the Huetteman & Cramer Co.

The autos are getting thicker than chiggers in June, according to the *Nonpareil* of Council Bluffs, Ia. H. H. Van Brunt, after having struggled through two severe attacks of automobilis fever, has come down a third time. This time touring-car symptoms have set in, and a tonneau has appeared, which indicates that the case is hopeless. Van Brunt's machine is a twin sister of Ed Hart's, with a cherry red complexion and the same bad case of bronchitis in its exhaust. Its capacity is five people, thirty miles, eight horsepower, ten gallons of gasoline and twenty-seven unforeseen incidents per hour.



The "New York and Philadelphia Limited Run" of the New York Motorcycle Club, held on Sunday, Aug. 28, brought out nine starters, as follows: A. J. Banta, J. J. McNevin and Raymond Chidester, on Rammers; R. G. Betts, D. F. Miller and H. Mabbie, on Indians; J. F. McLaughlin, Tribune; R. H. Nickerson, Holley, and F. W. Horenburger, Marsh. The riders went to Philadelphia and turned there, finishing in New York. Those in at the finish were A. J. Banta, time 11 hours; J. F. McLaughlin, 11 hours 22 minutes; R. G. Betts and J. J. McNevin, 13 hours 25 minutes, the two last named finishing together. A time limit of 11 hours minimum and 14 hours maximum was set. Much trouble was experienced at the various ferries on the route. At Perth Amboy Mr. Banta just missed the ferry to Tottenville, and rather than lose an hour waiting for the next boat he hired a skiff to take him and his machine across. Betts tried to do likewise, but was unable to find a boat, and so had to exercise all the patience at his command. The roads were frightfully dusty, and a lot of trouble was experienced from dust-choked carbureters. Mr. Chidester reported that he would probably have finished within the time limit but was forced by an automobile into the ditch, getting a bad fall and knocking the tank off his motorcycle. The actual start and finish were at St. George, Staten Island, obviating a run through the city streets.

* * *

An Apperson Bros. 45-horsepower touring car left Chicago at 2 o'clock on the morning of August 24 and made the run of 1,080 miles to New York in 72 hours 46 minutes, breaking the best previous record of 76 hours made by a Columbia car last fall. Elmer Apperson and Arthur G. Schmitt, and Edgar Apperson and Jerome A. Ellis alternated in driving the car. Much time is reported to have been lost on account of storms and incompetent guides. The car, Mr. Apperson stated, behaved extremely well, no repairs being made on the road and the only work done on arrival in New York being the tightening of the connecting rod brasses. Notwithstanding the bad roads the only tire troubles experienced were caused by careless driving on rocky roads.

* * *

A 40-horsepower De Dietrich automobile owned by H. I. Ottman, New York city, has been fitted with a set of wheels of a construction not often seen on this side of the Atlantic, though it is said that such wheels are used to some extent in France. The usual spokes are replaced by steel discs, bolted, one on each side, to the hub flanges and the rims. These discs are not flat, but slightly convex on the outside. Their strength is said to be something enormous. One of the wheels on the car referred to was struck by a trolley car, and several indentations were left as evidence of the severity of the blow. Apart from the marring of the surface, however, the wheel suffered no injury whatever. The steel disc wheel is not made by the De Dietrich Company, but by a separate concern. Mr. Jarrage, the local De Dietrich representative, states that he expects to secure the agency for this novelty. The wheel is somewhat heavier than the average wood wheel, but not enough to

make any noticeable difference to the car. Access to the tire lugs is obtained by means of sunken sections of the inner disc, into which the lugs project.

* * *

The New York city importers of automobiles, in pursuance of their independent course, have incorporated, under the laws of the State of New York, an association called the Importers' Automobile Salon. As already stated in THE AUTOMOBILE, the importers' show, which will be called a "Salon," will be held in the Herald Square Exhibition Hall and will be a two weeks' exhibition, commencing on January 11 and ending on January 24. The officers of the Salon are as follows: President, C. R. Mabley; Vice-President, E. T. Birdsall; Treasurer, E. R. Hollander; Secretary, S. B. Bowman; Executive Committee, E. T. Kimball, F. A. LaRoche, E. B. Gallaher and J. S. Josephs, and Show Manager, J. H. Gerrie.

* * *

Dates for the second race for the American Power Boat Association's challenge cup have been fixed for September 22, 23 and 24. The directors of the association have accepted the challenge recently made by the Manhasset Bay Yacht Club through its representative, H. A. Lozier, for his *Shooting Star*. The cup is now held by the Columbia Yacht Club, having been won by C. C. Riotte's *Standard* in the races held in June. The *Standard* has since been sold and is now in the Thousand Islands, but the Columbia Club expects to have a new boat that be fully able to defend the trophy. Each club in the association may enter one boat for the races, which will be held over the same course as that used in the first series—ten nautical miles up the Hudson River from the stake opposite the Columbia clubhouse and return. Entries will close with Secretary George R. Branson, 75 William street, New York, September 12.

* * *

The meeting of the Board of Directors of the American Automobile Association, which is called for Tuesday, Sept. 6, promises to be one of the most interesting held by that body for some time. The business to be attended to includes the LaRoche non-stop run, official reports of which will be presented by the observers; the Vanderbilt Cup race, the final details of which will be settled, as far as the Board of Governors is concerned; the election of five clubs and some 200 individuals to membership in the A. A. A.; and such of the St. Louis Tour awards as have not yet been made.

* * *

Automobiles will take a prominent part in a parade to be held in connection with the formal opening of the Pelham Bay Athletic Field, on Sept. 10. The grounds are at 168th street and Lexington avenue, in the Bronx, and will be opened by a day of sports, commencing at 9 o'clock a. m. The parade starts at 1 o'clock. Emerson Brooks, chairman of the A. C. A. Touring Committee, states that the cordial invitation which the Park Commissioners have extended to automobilists to take part in the parade is the direct outcome of the New York automobile parade, which had the effect of convincing the Park Commissioners

that automobilists, as a class, stood for good roads for every one and good behavior on the part of automobilists. The Commissioners communicated with the A. C. A. regarding an automobile section in the parade, and the matter was turned over to Mr. Brooks, as chairman of the Touring Committee. As the automobilists will be given the place of honor in the parade, Mr. Brooks hopes that the turnout will do justice to the occasion.

* * *

The case of Peace Justice Frank L. Tyson, of Lawrence, L. I., whose eligibility for a judicial post has been questioned by an automobilist who was brought before him, charged with violating the speed law, is still pending. Supreme Court Justice Dickey, to whom the complaint regarding Mr. Tyson was made, reserved judgment until he should have carefully considered all the circumstances. As a result of the disturbance caused by the promiscuous arresting of automobilists at Lawrence, and the consequent unpleasant notoriety which the little place has acquired, the village trustees have passed a resolution raising the speed limit within the village boundaries to 18 miles an hour.

* * *

A fall automobile tour is being talked of by the Touring Committee of the A. A. A., the idea being to hold a run through parts of New Jersey and Pennsylvania just after the Vanderbilt Cup race, when many automobilists are likely to be in the city. No definite plans have been made, however, everything depending upon the attitude of the automobilists with regard to the proposed trip.

* * *

An automobile race meet will be held at the Empire City track, Yonkers, N. Y., on September 24, when it is expected that many of the bright particular stars of the automobile racing world will compete for the prizes. This meet is one of the "automobile circuit," which includes Providence, R. I.; Poughkeepsie, N. Y.; Detroit, Mich., and Philadelphia.

* * *

Secretary Butler, of the Automobile Club of America, has been taking his summer vacation at Patchogue, L. I., where he devotes himself chiefly to sport on the deep blue sea. Mr. Butler is an enthusiastic sailor, and is skipper of a trim little vessel in which he takes his summer voyages.

* * *

One of the results of the St. Louis Tour of the A. A. A. is that the organization has achieved a standing in the district through which the route passed which it never had before. Previous to the tour the A. A. A. was simply a name to automobilists at a distance; but many of them have now come into actual contact with it, or have seen its workings close at hand, with the result that numerous applications for membership are being received.

* * *

Robert Jacob, the City Island boat builder, has launched the new autoboot ordered by William K. Vanderbilt, Jr. The boat is 40 feet long and is engined with a 60-horsepower Mercedes motor.



Gilbert Loomis, formerly of the Loomis Autocar Co., of Westfield, Mass., has joined the forces of the Pope Mfg. Co., at Hagers-town, Md.

The Fredonia Mfg. Co., of Youngstown, O., has been placed in the hands of a receiver upon application of the estate of J. Arrel Smith.

Last Saturday afternoon Jed Newkirk, driving 999 in exhibition on the half-mile track at Aurora, Ill., covered the mile in 1:12 4-5, and three miles in 3:38.

Colonel John Jacob Astor has joined the Florida East Coast Automobile Association and expects to enter one or more cars in the tournament to be held at Ormond next January.

Alfred I. du Pont, of Wilmington, Del., head of the famous du Pont powder works, is now the possessor of his sixth automobile, his latest purchase being a 20-horsepower Clement-Bayard.

F. M. Hoblitt, until recently connected with the Waverley factory, has accepted the position of general manager of the Indiana Automobile Co., of Indianapolis, vice S. W. Elston, resigned.

The Brooklyn Automobile Co. has secured the agency for the Yale cars, made by the Kirk Mfg. Co., of Toledo. One of the cars for demonstration purposes has been received at the company's New York City garage.

The New York agency for the Richard-Brasier automobile will hereafter be at 141 West Fifty-fifth street, the increase of business since the Gordon Bennett race having necessitated a removal to more roomy quarters.

Sixty automobiles are now registered in Colorado Springs, Colo., the Davie Realty Company being the latest addition to the ranks, having adopted the auto for use in showing its property to intending purchasers.

The dearth of dwelling houses for workmen in Lansing, Mich., has led the Olds Motor Works at that place to erect houses for the use of its employees, of whom there are about 800. Twenty-four houses are already in course of construction.

The Bates Automobile Co., of Lansing, Mich., has commenced the shipment of machines of the touring car type, fitted with three-cylinder 18-horsepower engines. The company is preparing to turn out several hundred cars next season, and is also continuing the manufacture of machines for this year's business.

So well did twelve-year-old Oriana Stevens drive her Baker electric runabout in the recent races at Glenville track, Cleveland, O., that she defeated W. C. Baker, vice-president of the company that made her machine, who drove a similar car. The event was the 100-yard obstacle race, and Miss Stevens' time was :49 2-5.

Leon Rubay, New York, United States representative of J. Jacote & Co., Paris, has moved into the premises at 140 West Thirty-eighth street, recently vacated by the Richard-Brasier agency, and will carry a very complete line of automobile accessories of all kinds, including tires. Electrical apparatus for automobiles will be a specialty, as heretofore.

Arrangements have been completed and a program announced for automobile handicap

races to be run at Sioux City, Ia., during the Interstate Fair, Sept. 9. Four events have been planned, each open only to non-professionals from Iowa, South Dakota, Nebraska and Minnesota, and it is expected about forty machines will participate. Entries close Sept. 8.

Mrs. Josephine Donner, of Cleveland, O., has filed a suit for \$15,000 damages against the Peerless Motor Car Co., claiming to have been seriously injured as a result of a collision between an automobile driven by L. P. Mooers, of the Peerless company, and a horse and buggy in which she and her husband were driving on Woodward avenue, June 15, 1902.

J. C. Fleitman, of New York, who has been touring with his family in Switzerland, has abandoned his intended itinerary owing to the continuous police annoyance, declaring that he was frequently held up for trivial causes, despite the fact that he was driving slowly. Other Americans have suffered the same treatment, and state that they never again expect to visit that country.

H. T. Thomas has been placed at the head of the engineering department of the R. E. Olds Co., recently organized at Lansing. Mr. Thomas was mechanical engineer of the Olds Motor Works up to the time Mr. Olds severed his connection with the company, and since that time has been connected with the Electric Vehicle Co., of Hartford. The new company has adopted the name "Reo" for its cars.

Chas. A. Turner, of Cleveland, O., has filed suit against the Pope Motor Car Co., and the Baker Motor Vehicle Co., asking \$15,000 damages for injuries alleged to have been received during a race on Sept. 5, 1903, in which as a result of a collision between the Pope and Baker machines, the latter was forced into and through the fence, running over Turner, breaking his collarbone and leg, dislocating his shoulder and otherwise bruising and lacerating him.

While chasing a speeding automobile up Lexington avenue, New York, a bicycle policeman was thrown in front of an approaching trolley car through the slipping of his wheel on the track. Before the motorman could stop his car the fender struck the prostrate officer, tearing his clothes almost off his body and scratching him severely. He was picked up and sent to the hospital to have his wounds dressed. His injuries were not serious. The automobilist escaped.

The Badger Brass Mfg. Co., of Kenosha, Wis., makers of Solar lamps, finding their present plant inadequate, have placed a contract for the erection of a new factory, 360 by 90 feet, to be completed within ninety days. The new plant is to be equipped with the most modern machinery for the production of oil and acetylene lamps. Power will be supplied by gas engine and the factory lighted with acetylene gas. Pending completion of the factory, the company will continue manufacturing in its present quarters.

While well-traveled roads are as a whole easier on automobile tires than those less used, punctures are more likely to occur in the well-populated districts than on the rougher roads of sparsely settled country. The Diamond tires on the Franklin car in which L. L. Whitman is crossing the con-

tinental traversed the worst roads to be encountered in the whole trip without being punctured, but near Ogden a nail caused a puncture, and a second puncture, also due to a nail, occurred near Denver. Whitman carries one extra casing, but thus far has had no occasion to use it.

Automobile races will be a feature of the Pennsylvania State Fair, to be held at Bethlehem, Pa., the week of Sept. 5. Wednesday and Friday will be devoted to racing, arrangements for which are in charge of Secretary H. A. Groman, of Bethlehem.

Owing to the criticism of the manner of classification of cars in the recent race meet at Hamline track, Minneapolis, which resulted in several of the races proving little better than a farce, a movement is already under way to hold another meet later in the season. If the Minneapolis A. C. does not arrange for another meeting, it is stated that the local dealers will take up the matter.

Magistrate Breen, in the Jefferson Market Police Court, New York, in trying John Carroll, of New York, for driving his automobile at high speed, said that he thought chauffeurs were rendered "proud and haughty" and oblivious to the rights of other mortals by their high-sounding title, and suggested that their lofty bearing might be somewhat reduced by calling them "motormen, drivers, or something of that sort." The prisoner was held in bail for trial, the magistrate feeling inclined to be severe and expressing his belief that the public wanted more stringent automobile laws than those already in force.

A curious suit has been instituted in Mount Vernon, N. Y., over an automobile which did not come up to the purchaser's expectations. The Mayor of that city bought the machine from a local dealer, so the story goes, and found it to be lacking in power. He told the dealer he didn't want the car, and the dealer said he wouldn't take it back. So the Mayor steered the machine up to the curb in front of the dealer's establishment and left it there; but the dealer ignored its presence. Finally the police took pity on the abandoned vehicle and took it in charge. The question now is, who owns the car? The courts will have to give the answer.

Miss Alice Roosevelt, daughter of the President, had a narrow escape from being one of the victims of an automobile accident at Newport, R. I., a short time ago. Mr. and Mrs. Payne Thompson were taking Miss Roosevelt home in their automobile from a dinner dance early in the morning of August 27, when suddenly the headlight of a rapidly approaching automobile, which proved to be Mr. De Navarro's car, glared at them through the darkness on the wrong side of the road. Mr. Thompson's chauffeur stopped his machine and reversed, backing across the road out of the way just in time for the other machine to pass by the narrowest margin. The chauffeur of Mr. De Navarro's machine, seeing that something was wrong, returned after running a short distance, and it was found that Miss Roosevelt had fainted from the shock. Michael Woods, chauffeur for Mr. De Navarro, was arrested and upon appearing before Judge Baker was recognized as a scorcher whom he had already fined. The judge sentenced him to five days in jail.

THE AUTOMOBILE

WEEKLY

NEW YORK—SATURDAY, SEPTEMBER 10, 1904—CHICAGO

10 CENTS

TOURING THE PHILIPPINES IN AN AUTO.

UNDER a triangular bamboo frame from which hung three buffalo skulls, Antonio, Chief of the Bontoc Igorot, sat at the wheel of the *Pathfinder* to have his "picture took." The result is shown on this page. From the surroundings one might fancy oneself in the new

August afternoon in the suburbs of St. Louis. For it was on the World's Fair grounds that Antonio posed for THE AUTOMOBILE camera.

As a sequel to the trip to St. Louis it was decided to drive the little Elmore in a tour of the Philippines. The proposition was

Among the interesting things at the World's Fair the Philippine exhibit is most interesting of all. What the Eiffel Tower was to the great Paris show, the exhibit of the life and works of the far-away Islanders is to the St. Louis Fair.

In a space of nearly 50 acres of rolling

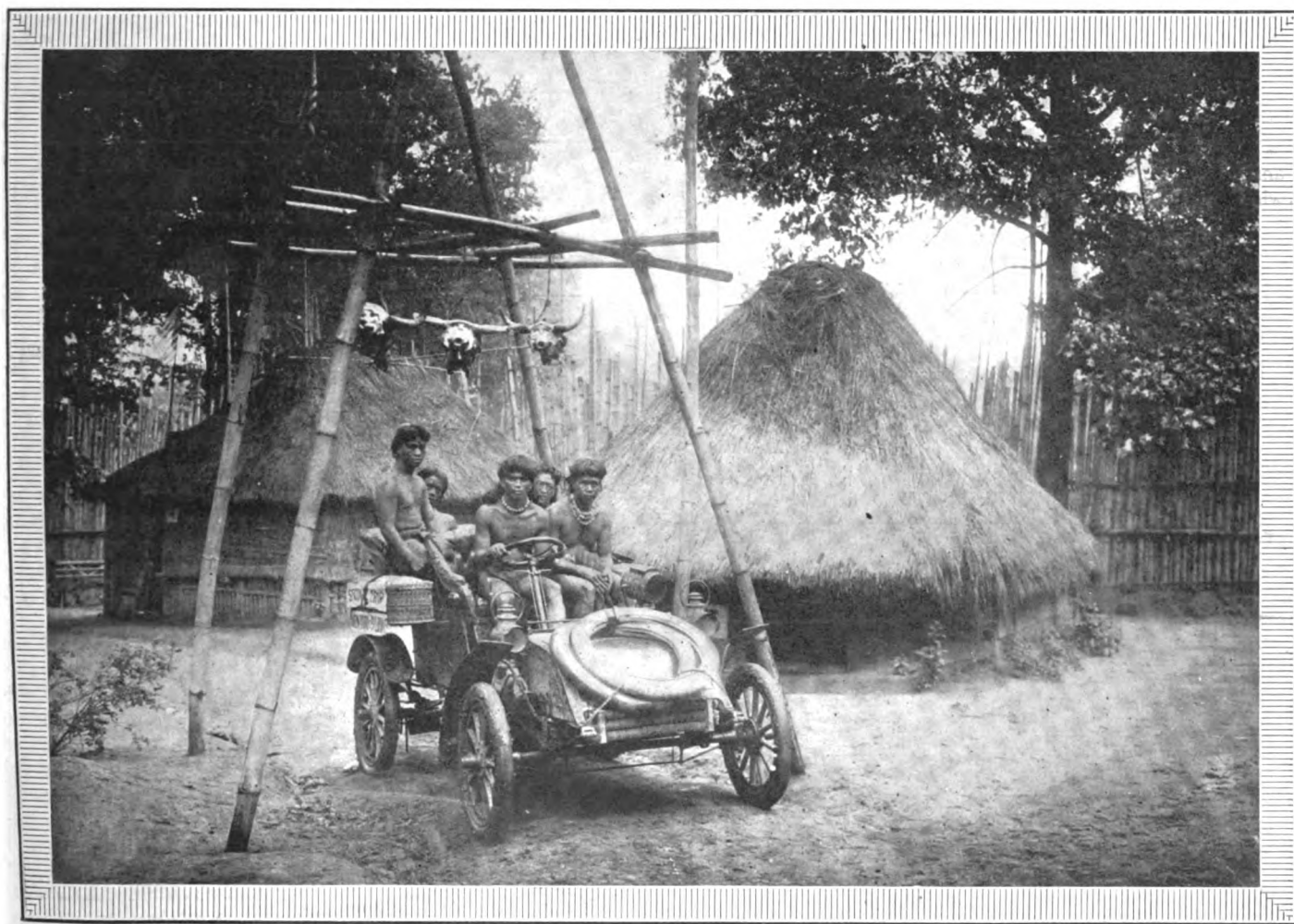

IGOROT CHIEF ANTONIO, HEAD HUNTER BY PROFESSION, DOG EATER BY CHOICE, AT WHEEL OF "PATHFINDER."

Photographed for "The Automobile," by N. Lasarnick, New York.

possessions over the sea—the bamboo stockade that marks the boundary of the village; the thatched huts over which a few scraggly trees spread their leaves, and this effect heightened by the rain which drizzled out of a super-saturated atmosphere on a sultry

novel one to the management, but perhaps that was its merit, for most courteous permission was granted to enter within the walls of the reservation and to follow at will the streets and lanes of the various native villages scattered about the grounds.

woodland, with water in plenty, there are more than 1,300 natives living their daily lives in Missouri just as they would in Mindanao, Luzon or Manila, with just a few concessions to Western prejudices.

The main approach to the Philippine ex-

hibit is by bridge spanning a lagoon, and leading to the arched portals of a fortress which at sight carries one back to the stirring days of '98, when Dewey broke out the flag in Manila Bay. Strangely shaped native boats lay afloat or drawn up on the bank near the bridge and over the enclosure came sounds of tom toms from the native bands of the various villages.

As this entrance is not open to vehicles, the *Pathfinder* had to steer a course around to the rear of the reservation, and enter by a road leading past the encampment of the Philippine Constabulary, before pulling up at the gate of the Igorot village. A little brown sentry, with his gun tucked under what looked like a drab colored Gordon Bennett driver's poncho, stopped in his paces when one of the party started to kick a panel out of the village gate. He didn't challenge anybody, however, when the gate swung open and an astonished guard looked incredulously at the car.

Antonio, the chief, was asleep, after an unusually heavy feast of dog, said the guard, and he feared that, perhaps, the old head hunting spirit might be roused if Antonio were suddenly awakened. The automobilists said they would take the risk, for the Philippine scouts outside were reassuring and into the center of the village the little car chug chugged. Antonio wasn't a bit annoyed when he came out, dressed in a white bead necklace and a turkish bath rubber's sash. Other curious villagers gathered about dressed very nearly in the altogether, and sniffed at the gasoline odor and poked their fingers into the cushions and tires.

Chief Antonio was really interested. He wanted to know how fast and how far it could go, and how much noise it made. Apparently, he thought it was just the proper rig for a head hunting expedition; one could cover so much more territory in the car than afoot and, then, the tonneau would

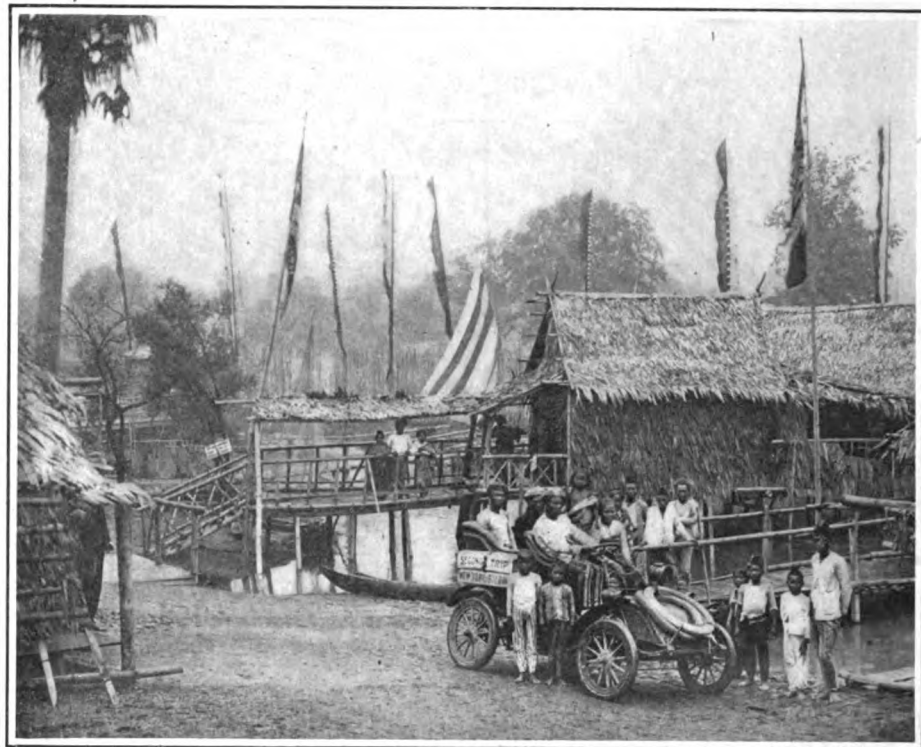

A STREET IN THE SAMAL MORO VILLAGE, DATTO FECUNDI AT WHEEL SURROUNDED BY MEMBERS OF HIS HOUSEHOLD.

hold a bushel of heads. There was room in the basket, too, for the head axe, which is spiked at one end for the blow that kills, and sharpened at the other for swift decapitation. One feature that pleased Antonio was the speed with which the car could be started and stopped. A quick stop for a head and then off and away seemed to be requisite in an up-to-date head hunting car. Perhaps an agent could do a lively business in Northern Luzon after Antonio returns home.

There is lots to see in this village. Weavers and dancers, and houses for wor-

ship and cooking dog, and other outlandish affairs. To the automobile party the village blacksmith was an interesting sight. His fire was on the ground, enclosed by a few loose bricks, and for a bellows he had what looked like two drain pipes on end with a piston in each, the rods in the hands of a brown urchin perched on a stool, who moved the rods smartly up and down when the fire had to be blown.

Though the Igorot is democratic in his dress, he is a bit of a conservative in his manners, for the Bontoc crowd won't have anything to do with the Suyoc tribe and neither will share their dog meat with any one of the Tinguianese settlement, though one bamboo stockade keeps all their canine provisions from roaming about the outside grounds.

On the way out of the village a call was made at a Tinguianese house and it took a good deal of persuasion to get the inhabitants into the seats. They are less ferocious than the Igorot, and don't seem strong on travel. This tribe has taken to clothes and put an upstairs on their houses, with a porch and railing that they can lean over and gossip—a sure sign of civilizing influences.

From the "picturesque" Igorot to the "Squat" Negrito isn't a very far stretch in distance or dress at the Fair, but it's a long step in manners and customs. The Negritos are the aborigines of the Islands. At home they don't live in any regular settlements, but wander about the country eating everything that grows and doesn't poison, and for meat anything from a cow to a cockatoo, that can be brought to the ground by bow and arrow.

The Megargel brothers, who were driving



TINGUIANESE IGOROT DELEGATION READY TO START FROM THE FAMILY MANSION.



PRETTY GIRLS OF THE VISAYAN OPERA COMPANY CHORUS PHOTOGRAPHED IN A TYPICAL VISAYAN STREET.

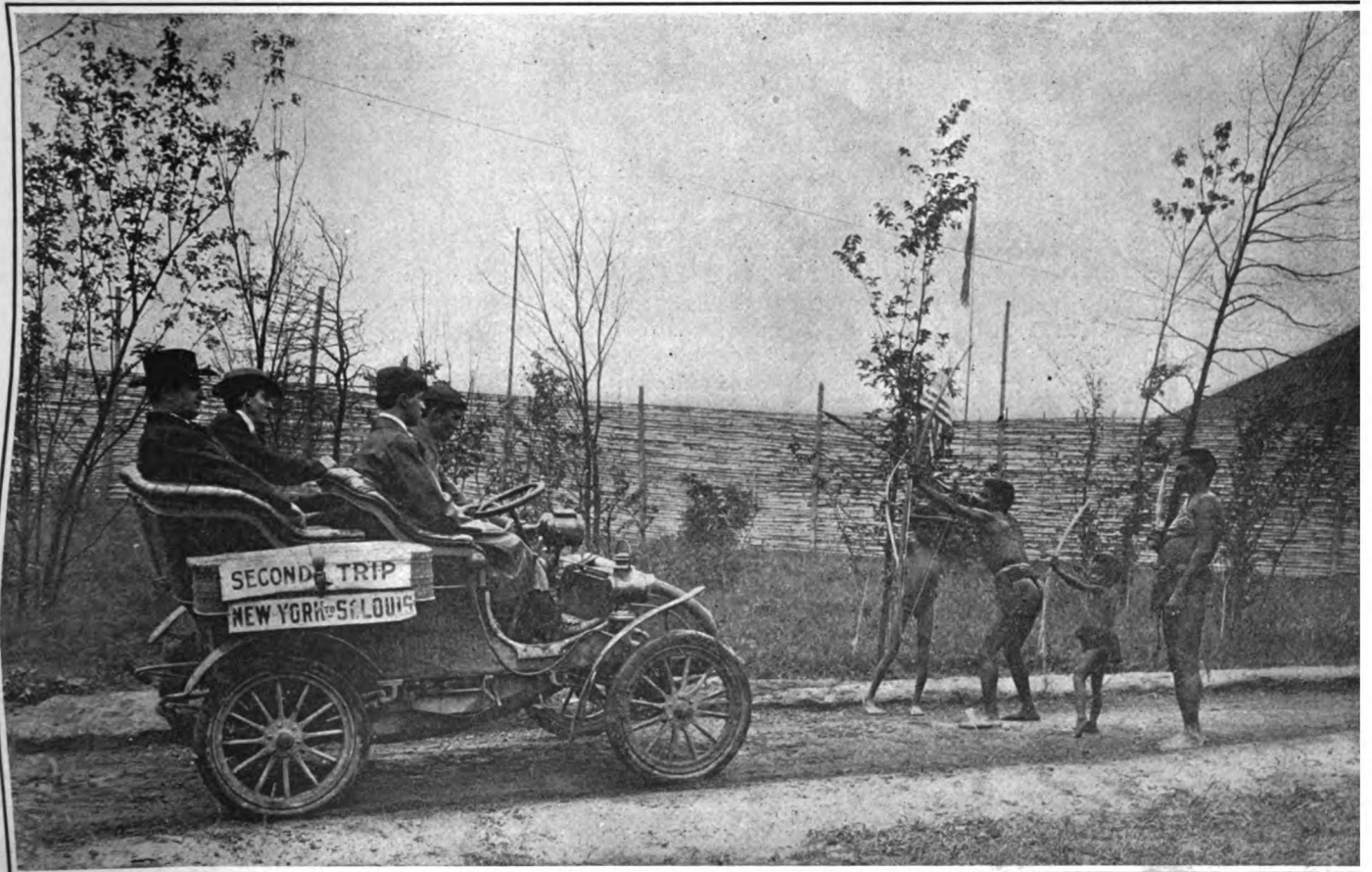

WARRIORS OF THE NEGRITO TRIBE HALT THE PATHFINDER UPON ITS ENTRANCE TO THEIR RESERVATION.



DATTO FECUNDI, PIRATE, STATESMAN, AND FRIEND OF THE UNITED STATES AND ONE OF HIS NUMEROUS FAMILY.

the *Pathfinder*, nearly got into trouble in this reservation. Whether it was because the natives were hungry or because they thought the puff cart a devil indeed, three young bowmen and an old native, who had a knife that would carve an ox, lined up in the path. The interpreter explained to both sides, for he was accused by the whites of putting up a job, and the natives came out of their huts and hovels and got quite friendly. They climbed all over the car, blew the horn and grinned and then stopped just long enough for the man with the box to press the button.

This race is dying out, and from their looks they are shrinking in size as well as in numbers. Though the small ones are cute, the bigger ones look brutish, and all have the true hobo's objection to work.

The little imps sitting inside the tire on the front of the car are famous shots with bow and arrow. It is a sight to see them glide without noise through the reeds and bushes about the camp, bow in hand, with the art of the hunter in every line of their little naked bodies, ready to speed an arrow with deadly aim.

A more risky visit was next on the list—to the Samal Moros, river pirates, cut-throats, and as bad men as ever pulled a gun in the Bad Lands or sunk a schooner on the Bowery. Notices posted about this waterside settlement warn the visitor that he takes pictures at his own risk.

There is safety in numbers, and, anyhow, the car could make as much noise with the muffler open as the Moro girls beating

brass kettles, and this gave the party a great lift in the estimation of Datto Fecundi, prime minister of the whole outfit, and a lot more besides who are waiting his return back to the Philippines. The Datto speaks Spanish, so when one of the party, recalling some lingo picked up on the Mexican frontier, saluted, with *Buenos dias, Senor; Como esta Ud?* the chief led the way into his house.

It is a summery sort of structure, built out over the water, of bamboo piles, to which a bamboo gangway leads. There are windows and doors and a tight board floor and benches to sleep or sit on, but Datto Fecundi doesn't seem to care for parlor suites in plush and ribbons tied to the backs of chairs. There is room and fresh air and a place to slumber and everything is as neat and clean as a battleship's deck, and what more could any river pirate want?

The Datto carries his luxuries on his back, for he is quite a dude in clothes. As he is a Mohammedan he wears a turban. His coat has a sort of fancy pajama effect in color and shape and his trousers of silk are tight and short, and as gay as Joseph's coat. He is a grave, dignified statesman, of middle age, and there is a touch of the Hidalgo in his quiet, courteous bearing.

Above the skyline the village is gay with curious banners of the various clans. When these tribesmen first came to the Fair they brought along a feud with the Lanao Moros, who like to live up a tree. A thatched hut in the topmost branches is the kind of nest they build. But the feud went out when an

Irish copper and his club beat a few local ordinances into their heads, and then, too, food was plenty—and what's the use. There are other ways in which a pirate can follow his trade besides rude assault, and Datto Fecundi has picked up a lot of points at the Fair from the men who sell food and dyed water called lemonade to the out-of-town folk.

The Moro is an amphibian, and no doubt an auto boat would have taken his fancy quite as much as the *Pathfinder*. He was pleased with the latter, and perhaps he will persuade Raja Munda Mand, his brother, and boss in the Islands, to buy a few when he gets home. They have the purse, if they decide to buy, for Messrs. Mand and Fecundi can write a good-sized check, or make their mark on the bottom, which answers the purpose.

From the camps of these strenuous people to the big enclosure of the gentle Visayans, who know the use of a napkin and don't use toothpicks at table, was a pleasing surprise. There are all sorts of diversions and Christian doings in this camp. A nice little theater, a neat little church and a picturesque section of Visayan street, where weavers and tailors and giddy bonnet makers work and chatter and sing. The theater has its string orchestra seated upon the stage and a vivacious conductor, who is too polite to turn his back on the audience. And the chorus girls! They ought to come first, and they certainly do, in the memory of every man who has seen the Fair. They are sweet, and they know it,

and if any Broadway or Market street belle thinks she knows all the arts of coquetry just let her step into the Visayan village enclosure.

"Dee-lighted!" is what they said in Castilian when a ride in the car was suggested. Then the photographer captured their smiles and the picture here printed does the rest. After that a round of the shops, where quick fingers copy Parisian styles and where the click of the shuttle gives them materials to work on and then, good-bye to the girls, and the little car swung out to the more humdrum sights of the big World's Fair.

Not hours, but days, might be spent in the Philippine exhibit. There are troops at drill, native dances and ceremonies and a natural history exhibit to see, and for the merchant, samples of everything the Islands produce.

If Uncle Sam doesn't move the exhibit to New York after the Fair he will make a mistake, and that isn't his style. However, it is better not to take chances, and a visit to the Philippine enclosure makes a trip to St. Louis worth while.

For courtesies in permitting the first automobile trip to the Philippines on this side of the Pacific we are indebted to the kind offices of many officials, and especially to Mr. Herbert S. Stone and Mr. Joseph N. Patterson, his principal aide.

Forty-seven automobile licenses have been taken out to date in Montreal, Can., at a fee of \$10 each.

More Entries for Vanderbilt Race.

Pope-Toledo and Royal Tourist Cars will Represent America in the Gasoline Class—Foreign Entries.

THE race for the Vanderbilt Cup will be, to say the least, an exceedingly lively and interesting event, if all signs do not fail—and if the weather is even half as good as the occasion demands. In spite of the slowness with which entries have been made up to almost the eleventh hour, there are enough competitors on the list to guarantee sport of the most exciting character. What is more important than the matter of mere numbers, the entrants are, without exception, of a character which renders each of them a formidable opponent for the others, and the fact that some are practically unknown quantities, so far as racing of this kind is concerned, gives to the first Vanderbilt Cup Race an added interest.

Thirteen entries have now been received, and it is more than likely that something will occur to place the number where it will not worry the superstitiously inclined. Of the thirteen no less than nine are foreign cars, the remaining four being of American manufacture. Four against nine! The American machines entered have a pretty heavy burden to bear, and any that show up well in the long scorch will cover themselves with glory and will merit the favorable publicity their names will receive, especially

when the racing qualities of the visiting cars are considered. These are the speed machines that the layman vaguely pictures to himself when he refers to racing automobiles—huge mechanical monsters that seem doubly huge and speedy when viewed through the medium of the press, assisted by a lively imagination. They are machines whose speed has been a by-word among racing automobilists for years, and whose records are written in small figures, while the drivers are men who are popularly supposed to feel positively bored at speeds much below a mile a minute.

SEVERAL FOREIGN CARS ENTERED.

The foreigners certainly present an imposing front. There will be three Panhard's, each of 90-horsepower, one driven by Tarte, one by Heath and the third by an expert as yet unnamed. Heath, it will be remembered, is the American who drove a Panhard car to victory recently in the Circuit des Ardennes in Belgium.

The Mercedes will be represented by three cars also, all of 60-horsepower. One of these will be driven by its owner, S. B. Stevens, of Rome, N. Y., a daring amateur. The other two Mercedes cars belong,



A CLUSTER OF NEGRITOS IN THEIR PICTURESQUE VILLAGE AT THE WORLD'S FAIR PHILIPPINE EXHIBIT.

one to George Arrents, of New York City, and the other to Clarence Gray Dinsmore; but who will drive them is in doubt, though Carl Mensel is mentioned as the probable driver of Mr. Arrents' car.

The two Fiats are Gordon Bennett racing cars of 90-horsepower, duplicates of each other. One is owned by William Wallace, of Boston, who will drive it, and the other, the property of Alfred Gwynne Vanderbilt, will, possibly, be driven by Paul Sartori, though this is not certain.

An interesting entry is the Clement Bayard car. This is an 80-horsepower racing machine, with an enormously long hood reaching from the radiator, where it is of comparatively small cross section, right back to where the driver sits over the rear axle, where the hood is much wider and higher. This machine took third place in the Circuit des Ardennes, and ought to prove an interesting contestant. It will be driven in the Vanderbilt Cup race by the same man who drove it in the Belgian contest—A. Clement, son of the manufacturer of the car. This young fellow—he is only 21—is said by those who have seen him drive to be daring and reckless in the extreme, and to take chances that seem to the spectator to invite certain disaster. Doubtless he will do his best to square accounts with Heath, who beat him by only about four minutes in Belgium.

Up to the time of the meeting of the Board of Governors of the A.A.A., September 6, there were but four entries of American machines; the two White steam racers, the Pope-Toledo and the Royal Tourist. The steam machines are being built especially for the Vanderbilt Cup race; but so carefully have they been guarded that not the slightest scrap of information concerning their mechanical features has leaked out—not even the horsepower. All that is known is that one will be driven by Rollin T. White and the other by Webb Jay.

ROYAL TOURIST AND POPE-TOLEDO.

The Royal Tourist, a late entry, is a regular touring machine stripped and fitted with a light racing body and geared to about 75 miles an hour, maximum. It will be driven by Joseph Tracy, and is the identical car driven by him at the Long Branch meet, where a leaky radiator crippled his car after several winnings. The rated horsepower of this machine is 35 at normal touring speeds. The Pope-Toledo car entered is of 60-horsepower; the driver will be A. C. Webb.

In addition to these entries there are a number of cars whose entries are looked for by many. Among these are the Packard *Gray Wolf* and a Smith & Mabley Simplex racer. It is even darkly hinted that by midnight on September 8, when the entry list closes, the American entries will be but little behind the foreigners in numbers.

Very complete arrangements have been

made for policing the course and guarding against accidents to contestants or spectators. Every road crossing the course will be spanned by a wire stretched between posts. This barrier will extend only across the roadway proper, and will not bar the space at each side. One or more officers will be placed in charge of each crossroad and will warn all travelers not to attempt the crossing. If, however, anyone cares to take the responsibility upon his own shoulders and risk it, he may drive around the barrier and cross the course. If trouble ensues he will have only himself to blame.

MEN TO POLICE THE COURSE.

About 125 men will be employed on police duty at the barriers and other points where they may be needed. If this number is found insufficient, more will be added. In order that there may be no lack of knowledge of the use of the roads for the race, legal notices are being run in the local newspapers informing the public on the subject. The publication of this warning was commenced on September 1 and will be continued until the day of the race. Advantage is being taken of every possible means of warning the people of the temporary use of the roads for the race, and it will be strange if, with the publicity the matter is receiving, any possible passers remain in ignorance of the facts.

GRAND STAND TO BE BUILT.

For the spectators a grand stand will be erected at the point selected for the start and finish near the roadside pump at Westbury. Occupants of the grand stand will be able to see the machines as they are sent away, as they pass at speed and as they finish. The stand is planned to accommodate 400 persons, and seats will cost \$5 each. There will also be ten boxes, of which five were spoken for instantly by members of the Board of Governors of the A.A.A. It is announced that if all the seats in the grand stand are reserved by September 15, another stand of equal capacity will be erected.

STARTING THE RACE.

The manner of starting the race, while perhaps not quite so exciting to the unaccustomed spectator as the common method will keep up the interest for some time. The cars will be started at, probably three minute intervals, so that by the time the last car has got away it will be almost time for the first one to reappear. Were it not for the fact that 9 minutes will be occupied in passing through the two controls, at Hempstead and Hicksville, the first car to start would get around about the time the last man was getting his motor under way; but the controls and the necessity for slowing down somewhat at the turns will obviate this possibility. The order of starting will be decided by a drawing which will take place at the clubhouse of the Automobile Club of America on Saturday, October 1,

at 8 o'clock in the evening. Each man's number will indicate the exact time at which he will be sent away, so he will not be hampered by not knowing, until the last moment, just what his starting time will be.

It is announced by A. R. Pardington, chairman of the A.A.A. Racing Board, that any prospective competitor in the Vanderbilt Cup race who is found guilty of exceeding the legal speed limit over the course will be instantly and irrevocably disqualified. The people in the vicinity of the course are very favorably disposed toward the race, and are doing a great deal to help things along; but any complications with automobilists just at this time would be disastrous in the extreme, so far as the contest is concerned.

The A.A.A. Racing Board will have its headquarters at the Garden City Hotel on the day of the race, October 8. A garage at Garden City will be reserved for the exclusive use of the competitors and their cars.

Frank G. Webb, president of the Long Island Automobile Club, announces that the Board of Governors of that club has thrown the club rooms and garage in Brooklyn open to the competitors in the Vanderbilt Cup race and extended to competitors all the privileges of membership from Sept. 15 to Oct. 8. Members of clubs in affiliation with the A.A.A. are invited to make full use of the club while in attendance in the race.

Edge Will not Compete.

Special Correspondence.

LONDON, Aug. 26.—In an interview yesterday regarding his plans as to the Vanderbilt Cup race, Mr. S. F. Edge stated that he had just decided not to enter, as the international entries received do not, according to cabled information, warrant so long and costly a journey. With a better field, he would doubtless have taken part, as he and his cousin, Cecil Edge, have been testing the Gordon Bennett and 6-cylinder Napiers at Baxhill with this in view.

It is hardly probable that Mr. Edge will take personal part in future racing events. The ways of British racing committees, in the motor field at least, have of late been so devious that he is convinced that he will do better to delegate the driving of his cars and boats to other men, while he personally endeavors to see that the rules and regulations are lived up to.

At a recent meeting of the Village Trustees of Lawrence, L. I., a resolution was adopted fixing the speed limit for motor vehicles at not exceeding eighteen miles an hour. The limit formerly was eight miles, but this was last spring raised to ten. The deputy sheriffs, special officers and village police have been instructed to make no further arrests of automobilists unless accurate time has been taken over a surveyed course of a quarter of a mile, and which distance is covered in less than fifty seconds.

Course Seen from Behind the Wheel.

BY JOSEPH TRACY.

IN a general way the proposed course may be said to be practically level. The highest grade does not appear to be more than five per cent. Except the turns at the base of the triangle and where the two sides approach the apex near Queens, the course is generally free from bad turns, though in some cases one cannot see around them on account of intervening trees. There are indeed several turns so blinded on the first leg of the course from Queens to Jericho, and on the Jericho-Hicksville road. The remainder of the course is, as a rule, free from trees, and the road and crossroads can be clearly seen ahead.

PORTION OF COURSE WIDE.

From Queens to Jericho the course is wide, usually from 20 to 30 feet. From Jericho to the junction of the Bethpage road, it is very narrow, less than 15 feet in places. It would seem almost impossible for an overtaking car to pass another one on some parts of this road unless the car in front runs very close to the side. From the Massapequa road to Hempstead and Queens the road is not quite so narrow as the course from Jericho to Hicksville.

The road surface is sandy and loose in many places, calling for careful driving to prevent skidding. Unless the dust is laid by rain or sprinkling, the drivers will have to contend with a serious problem, as the road for considerable stretches is covered to the depth of an inch with this enemy of the racing man.

SOME PARTS ARE ROUGH.

Some parts of the course also are so rough that only at the risk of broken springs and axles may high speeds be attempted.

On account of the absence of bad grades cars for this race may be geared high without disadvantage.

From the starting point, at Queens, the road is slightly down grade and is rough on the sides, although smooth in the middle. The view is obstructed by trees for some distance after leaving Queens. From the start to the iron railroad bridge just beyond the cross road leading to Floral Park, the course is very rough. After passing the bridge it broadens and has a smooth surface, and is suitable for very fast driving.

About a mile from the railroad bridge a church is seen on the right-hand side. A short distance from the church the road makes a sudden dip and at the bottom of the dip is a culvert, the arch of which is raised higher than the road surface, and makes a very bad bump. If this bump is passed over at high speed it would impose an enormous strain on the springs and axles.

GOOD VIEW ON THIS STRETCH.

The course next passes through New Hyde Park, and from thence to Mineola.

The view on this stretch is not interfered with by trees or houses. Approaching the cross road at Mineola the road is straight, and the grade crossing of the Oyster Bay branch of the Long Island Railroad can be seen from a distance of half a mile. This crossing is rough and has three tracks. High speed can be made between the railroad crossing and the next turn, where speed must be reduced slightly on account of a bend in the road.

Next comes a long and straight down grade, near the bottom of which the road is soft at the sides. The route next passes near Westbury, selected as the starting point, and on to Jericho.

From the Westbury cross road to Jericho the road is sandy in places, and undulating and fairly straight, though rough and lumpy as it approaches Jericho. Coming into Jericho a yellow house, which stands facing

The sign at the grade crossing can be seen from a distance of half a mile. About half a mile beyond the track is a cross road which may be distinguished by a farmhouse on the left.

The next point of importance is the turn from the Hicksville-Massapequa road on to the Bethpage Turnpike. This is the worst turn on the entire course, and unless the road is widened and repaired at this point it will be impossible to take the turn at a faster speed than ten or fifteen miles an hour. From this turning point the road is nearly straight for a mile and a half to two miles.

TELEGRAPH POLES AT BEND.

About four miles from the Massapequa turn there is a sharp bend to the left. This bend can be distinguished from a good distance by means of three telegraph poles on the right just at the bend. These poles are used as anchorages for the stays which help to support the line poles. The telegraph line is on the left on this road. After passing this bend there is a fine straight and level

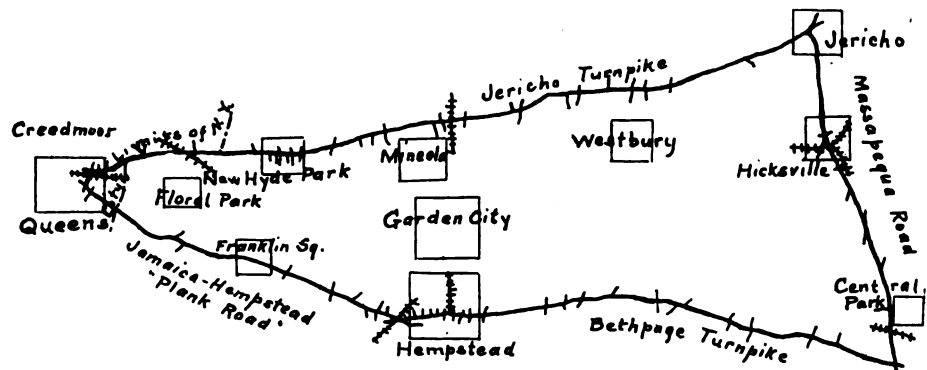

ROUGH SKETCH MAP OF THE VANDERBILT CUP COURSE ON LONG ISLAND, NEW YORK.

the cross roads, can be seen from a distance of half a mile.

THE TURN AT JERICHO.

The turn at Jericho is an acute angle, and will necessitate some smart steering unless taken at low speed. The road surface on the turn is fine, except on the extreme right where it is sandy and loose. After passing Jericho the road winds and is dusty. Probably the fastest time on the entire circuit will be made on this stretch.

At the commencement of the Hicksville control the road bends sharply to the left. Leaving the control the road is wide and has a slight descent which helps to make a fast start. Less than a mile past Hicksville the road narrows to about 15 feet, although the roadbed is good and firm. About two miles from Hicksville and where the first clump of trees is passed on the left there is a sharp bend to the right, which must be taken at reduced speed.

UNUSED RAILROAD TRACK.

About three miles beyond Hicksville a single railroad track crosses the course. This track is grass covered and apparently disused, and can be crossed at high speed.

stretch, and at a distance of about a mile is the Meadowbrook cross road. High speed can be maintained all the way from here to Hempstead.

At the entrance to the Hempstead control there is a fork in the road, and the branch on the right, known as Fulton street, must be followed. From Hempstead to the new Belmont race track on the right the road is good, but undulates and winds slightly. There are some rough spots in the course where it passes the race track. From here on to Queens the road is good, though the turns at Queens are rather narrow and sandy.

"That Mrs. Snaggs is too much of a aristocrat fur me to mingle wid."

"How's that?"

"She was knocked down by a push-cart, and she had it put into de paper dat she was hit by an autermobile."—*Detroit Free Press.*

Chauffeur—You's better be a little careful, sir. My machine might make your horse run.

Farmer Oatmeal.—Do tell! Well, it'll be the first time in thirty years.—*Chicago News.*

Suggestions to the Inexperienced.—VIII.*

A Simple Discussion of the Principles of the Gasoline Car for the Benefit of Novices.

By A. D. RIVER.

THE FLY-WHEEL CLUTCH.

WHEN the individual clutch system is used each clutch has to perform only the work incident to its own change of speed, but when the sliding gear train is used a single clutch serves for all the changes of speed. In addition, as is elsewhere explained, the pedal control system commonly used with sliding gears contemplates a much more frequent and severe use of the clutch than is usual with the other system, and it must be correspondingly more durable and less in need of frequent adjustment.

The latter requirement is fulfilled by engaging the clutch through the pressure of a spring, and releasing it by the muscular effort of the operator, instead of vice versa. The self-releasing clutch of the individual clutch system must be locked in engagement by an arrangement of toggles, or by a sliding thimble on the shaft which, when in place, relieves the operator of the need of further effort, and also relieves the clutch of end pressure. Such an arrangement is hardly feasible when the clutch is to be engaged by a uniformly applied spring pressure, since a certain extra effort is required to force the toggle or thimble home to its self-locking position. Consequently the self-releasing clutch is never used with the sliding gear train.

WEAR ON THE CLUTCH.

A clutch engaged by a spring can evidently suffer a considerable amount of wear without materially reducing its holding power, since the spring tension will be but slightly affected. On the other hand, it is desirable in any clutch in which a constant end pressure is exerted by the spring when the clutch is in engagement, to devise some means of supporting this end thrust otherwise than by a thrust bearing between the shaft and a fixed point, since such a bearing is subject to constant wear while the clutch is in action, and is also hard to lubricate. This may be done by certain arrangements of the clutch parts presently to be described, which cause the thrust of the spring to be taken by the clutch members themselves, which, of course, are turning together without relative motion when the clutch is engaged.

METAL-TO-METAL CLUTCH.

It is possible to make a metal-to-metal clutch embodying the above features, and there are several successful clutches of this sort in use. By far the commonest type of clutch, however, is the conical clutch with one of the acting surfaces faced with leather. It is cheaper and simpler,

and probably more uniform in action also, since the metal-to-metal clutch requires a certain amount of oil for easy engagement, and with too little or too much oil it will grip too suddenly or slip.

A good example of this type of clutch is seen in Fig. 1. The flywheel is riveted to a flange on the crankshaft *A* of the engine, and the end of the shaft is prolonged clear through the clutch as shown, to ensure that its two engaging surfaces shall at all times be perfectly concentric. A short "clutch shaft" *B*, by which the power is transmitted from the clutch to the first gear shaft of the sliding gear train, has a bronze bushing, and turns loosely on the end of *A*. To it is keyed the male portion *C* of the clutch, this portion being made of cast aluminum for lightness and faced with leather on its conical rubbing surface. A coiled spring *D*, one of whose ends bears against the flywheel hub and the other against a ball thrust bearing *E*, forces *C* into normal engagement with the internally coned ring *F*, bolted to the flywheel rim as shown. To release the clutch, pressure is applied by a fork and levers,

ball thrust bearing *E* is therefore inactive.

AN ALTERNATIVE METHOD.

The clutch just described belongs to what may be called the internal or closed type; in Fig. 2 is shown another in which the movement of the clutch cone on release is away from the flywheel instead of toward it. Here *A* is the engine shaft, as before, and *B* is the clutch shaft, which

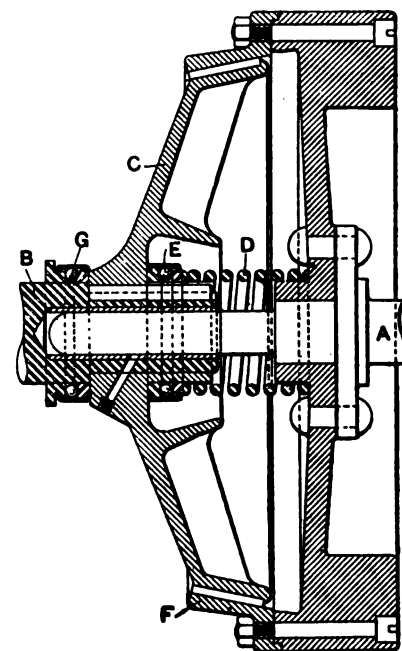

FIG. 1.—INTERNAL FLYWHEEL CLUTCH.

this time is bored out hollow and has its rear end internally squared to receive loosely the squared front end of the first gear shaft *C*, whose function is the same as that of shaft *B*, Fig. 1. Shaft, or rather sleeve, *B*, Fig. 2, has a bushing *D*, which loosely

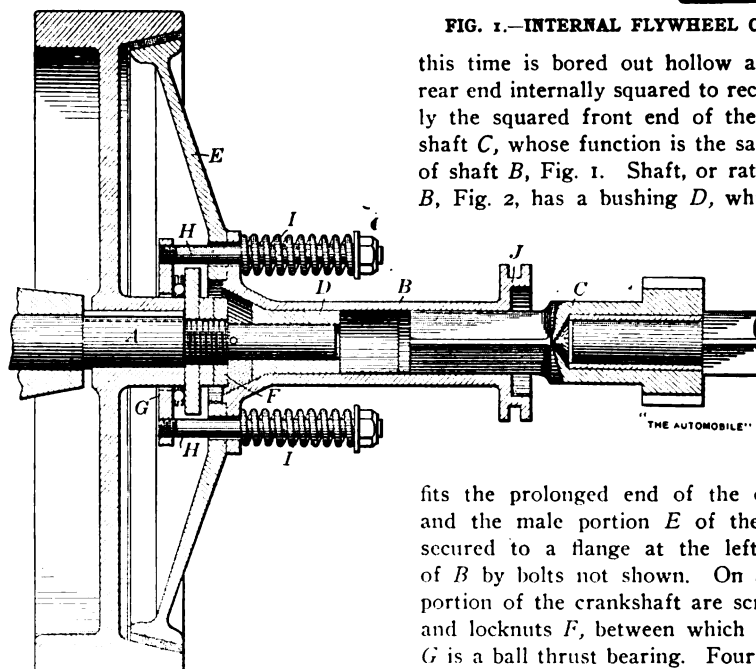

FIG. 2.—EXTERNAL OR THRUST CLUTCH.

fits the prolonged end of the crankshaft, and the male portion *E* of the clutch is secured to a flange at the left-hand end of *B* by bolts not shown. On a threaded portion of the crankshaft are screwed nuts and locknuts *F*, between which and a ring *G* is a ball thrust bearing. Four studs *HH* are threaded into *G* and pass loosely through *B* and *E*, with adjusting nuts on their outer ends. The main clutch springs *II*, one on each stud, bear between the stud nuts and the flange of *B*, thus pulling, as it were, on the studs and ring *G* and pushing *E* into the flywheel. This clutch, like the preceding, is self-contained in thrust when engaged. It is released by a forward thrust applied to *B* by a ring not shown, in groove *J*.

fits the prolonged end of the crankshaft, and the male portion *E* of the clutch is secured to a flange at the left-hand end of *B* by bolts not shown. On a threaded portion of the crankshaft are screwed nuts and locknuts *F*, between which and a ring *G* is a ball thrust bearing. Four studs *HH* are threaded into *G* and pass loosely through *B* and *E*, with adjusting nuts on their outer ends. The main clutch springs *II*, one on each stud, bear between the stud nuts and the flange of *B*, thus pulling, as it were, on the studs and ring *G* and pushing *E* into the flywheel. This clutch, like the preceding, is self-contained in thrust when engaged. It is released by a forward thrust applied to *B* by a ring not shown, in groove *J*.

*Continued from page 179, issue of August 13, 1904.

The point of what has been said regarding the infrequent need for adjustment will be understood when it is considered that the only effect of wearing down the leather on the clutch cone will be to allow the springs to expand a small fraction of an inch more before the clutch is engaged. Allowance is always made for this expansion in the springs, and also in the clutch itself for the fact that the cone must advance further into the flywheel or internally-coned ring as the leather wears down. It is not always, however, thought necessary to provide compensation for the expansion of the springs; that in Fig. 1, for example, having no such provision.

(To be continued.)

Autocar Engine Oiler.

The Autocar two-cylinder horizontal opposed engine is made this year with an oil reservoir cast integral with the cover of the crankcase, so that the heat of the engine while it is in operation always keeps the lubricating oil fluid. The ends of the barrel-shaped reservoir are fitted with glass so that the amount of oil contained is apparent at a glance. On the upper front side of the barrel is a sight feed, easily regulated from above, which enables the operator to see just how much oil is passing to the crankcase.

The action of the oiler, which is automatic, is as follows: The engine crankpins being set at 180 degrees apart, the two pistons move toward and from each other simultaneously. As they come together, the air that is in the crankcase is forced out through a check valve, and as they travel away from the crankshaft they create a partial vacuum in the crankcase which is utilized to draw oil up a suction pipe from the oil reservoir to the sight-feed, whence it drops directly into the crankcase and is distributed to all of the moving parts of the engine by the splash system.

The oiler begins working as soon as the engine is started and the oil is in a fluid condition, and it feeds in proportion to the speed of the engine, stopping the instant the engine ceases running.

A hand pump is provided on the dash to give a first charge of oil to the engine when starting.

The capacity of the oiler is three pints and the normal feed only ten drops per minute. The device is carefully adjusted before the car leaves the factory. In service this automobile oiler has proved reliable and relieves the driver from anxiety concerning the lubrication of his motor.

Judge—"You let the burglar go to arrest an automobilist?"

Policeman—"Yes. The autoist pays a fine and adds to the resources of the State. The burglar goes to prison, and the State has to pay for his keep."—*Fliegende Blaetter*.

Locating an Auto Bug.

The automobile is getting to be a pretty thoroughly understood machine and it rarely gets out of order in any of its details without the cause of the trouble being located with considerable promptness—and the location of the difficulty is about four-fifths of the battle, as a rule. In the earlier days of automobiling matters were in a less happy state, for there were a good many "bugs" and it was some time before they were all run down with sufficient frequency to make automobilists familiar with them. The very hardest of these elusive "insects" to corner usually originated in the electrical apparatus, and the average man's thorough ignorance of the peculiar properties of a high tension current made the proposition a knotty one. But it is doubtful if a harder bug to catch ever was found in any machine than one recently

est automobile supply store, where he bought a quantity of cable with insulation of such thickness that the outside diameter of the covering was about three-quarters of an inch. Every particle of old wire was removed, piece by piece, and replaced by the new cable, the greatest pains being taken to do the work perfectly. When it was finished so sure was the automobilist that his troubles were at an end that he did not even make a test, but let it go after having made sure that the sparker sparked properly.

The next time he went for a ride he had completely forgotten about the "bug" and thoughtlessly reaching for the valve, got a shock just as of yore, except that it was stronger than usual on account of the new batteries put in to replace those exhausted by the leakage. On the verge of tears, he sat down that night in the quiet of his automobile house and vowed to stay there

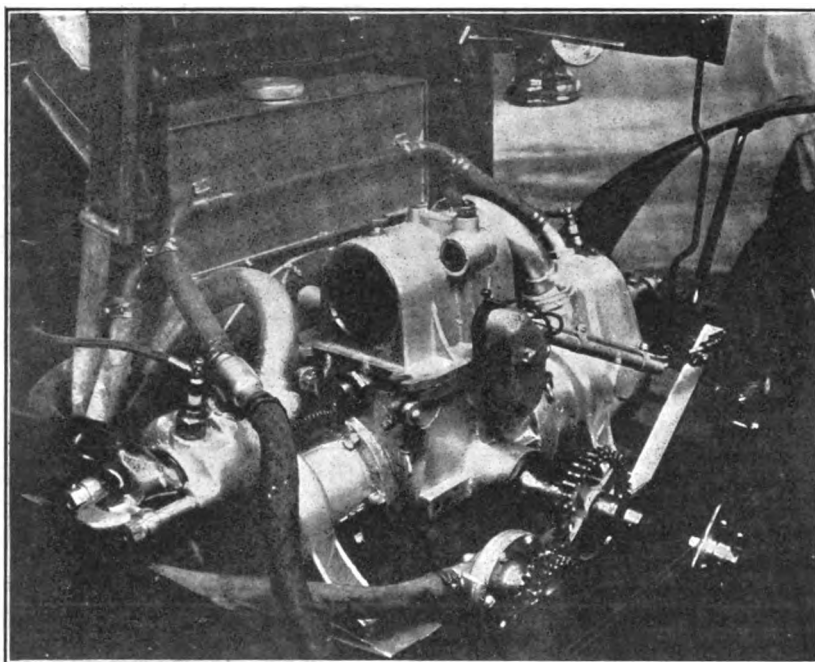

ENGINE OF THE AUTOCAR, SHOWING OILING DEVICE ON TOP OF CRANKCASE.

chased around a small gasoline machine for months before being finally exterminated.

The operator of this car found that if, while driving, he attempted to adjust his gasoline valve, which was done by means of a small lever projecting through the rubber cloth curtain hanging down in front of the seat, he received quite a severe shock. He at once concluded that his insulation was at fault somewhere, and went carefully over the wiring, finding a few places on which some doubt might rest, but no evidences of leakage of current. He fixed up the dubious spots, and thought he had the leak stopped, but on starting up the motor and reaching for the gasoline valve, he got a shock that changed his mind immediately. After a number of spare evenings spent in trying to locate the trouble, the owner was convinced that the thing was bewitched, and hid him to the near-

until the bug was found and dislodged. And he did. He found that the rubber cloth curtain at the front of the seat came in contact with the spark-gap screwed to the front of the coil box, and the curtain, being quite oily and dirty and therefore a good enough conductor for a high tension current, conveyed the erratic fluid to the brass ring around the hole through which the valve handle projected. The operator's other hand, being either on the steering lever or some other part of the controlling apparatus through which the current could pass from the motor, a complete circuit was formed when the ring was touched in handling the valve, and the shock resulted. After a number of tests, proving conclusively that this was the cause of the leakage, the spark-gap was protected from contact with the curtain, and the "bug" was no more.

Physician's Experience with a Runabout.—I.

By HARRY W. FREEBERG, M.D.

IT was in the summer of 1902 that I first took the automobile fever, and when I think of those days now I am convinced that my temperature must have gone very high, as I was induced to trade a valuable horse and Stanhope, with some extra hard cash (never mind how much) for an attractive looking light steamer. This I used, or rather endeavored to use, for about three months; then stored it for the winter, as it was more ornamental than useful.

The remedy, however, was a good one, as it brought my temperature down considerably and came rather near effecting a cure. Moreover, it rapidly expanded my vocabulary. However, with the following spring came a recurrence of the fever and I consulted a leading dealer in Indianapolis, who kindly allowed me a good price for my steamer and sold me one of those popular little Olds runabouts.

At the time I purchased this little car, a neighboring resident of Lafayette bought a big touring car. The weather was inclement, but as we were anxious to get home we decided to run the risk of the trip over the road. The streets in the suburbs of the city were almost impassable in places and we were obliged to run on the low gear for many blocks at a time. The country roads proved to be better, although they were slippery and caused considerable skidding. The big car in front of me would often slide to the side ditch and plow a deep furrow in the earth, throwing sod into the adjoining field. On several occasions I also lost partial control of my car and ran down into the ditch, but no disaster happened, as I had learned to release the clutch and apply the brake instantly when in danger. Only once did the touring car leave me. That was when I turned a horse and buggy over and had to go back and help pick them up. Fortunately for me, the occupants of the buggy were in good humor, having sustained no injuries, and after putting the rig in order they went on their way rejoicing.

STUCK IN INDIANA CLAY.

The next trouble encountered was of an entirely different character. After passing through Royalton a few hundred feet, we came to a small but steep clay hill, all the gravel surface of which had been washed away; and to make matters worse, the farmers had been hauling saw-logs through the mud, leaving ruts nearly hub deep. The first car was successful in getting over the hill but dropped into a deep rut and stuck on the way down the other side, the flywheel sinking into the mud. At the same time my car lay down in despair, as it was impossible to keep out of the deep tracks. The engine stopped running, but the vibrator worked overtime. It buzzed vigorously until one of the men from the

touring car could wade back through the mud and locate for me the point of short circuiting.

By this time all of the men in town, whose previous occupation it had been to hold down store boxes, had gathered upon the scene, which had suddenly become one of unusual action. Members of the fair sex secured box seats in the fence corners. Baggage and hats, coats and vests, and cuffs were piled everywhere on dry plots, and overshoes were used as gum boots. All of the men worked enthusiastically and all had different suggestions to make. They literally lifted my runabout out of the ruts and landed me safely at the bottom of the hill; but with the big machine the problem was more difficult. With a borrowed spade we took turns at digging away the dirt from the flywheel and making a trench

holding the plate over the explosion chamber had pulled off and allowed the gasket to be blown out. A man from Thorntown, who seemed to be considerable of a mechanic, was only a few minutes drilling out the stub and putting in a paper gasket, which was all we had at our disposal. This held nicely until I reached home, when I put in an asbestos gasket that has held ever since.

My machine has the usual $4\frac{1}{2}$ by 6-inch cylinder, rated at about 5-horsepower, but has especially good compression and I can get from 1,200 to 1,400 revolutions per minute. The engine is constructed with mechanically operated intake and exhaust valves that open wide and close quickly. This feature I think gives the engine much greater power. Last fall I had no trouble making a mile in two minutes on a half-mile track.

After possessing the car about six weeks I made a little run of nearly fourteen miles into the country to Yorktown, my old home.



DR. H. W. FREEBERG OF LAFAYETTE, IND., AND HIS LIGHT RUNABOUT.

for it to run in. Then, with rails beneath the axles and planks laid for the wheels to run on, and with willing hands at the wheels, we managed to get the car to solid roadway.

A GASKET BLOWS OUT.

My engine worked splendidly but grew hot, as it was new and the work was very heavy. This necessitated frequent refilling of the water tank—probably every twelve to fifteen miles. After passing through Thorntown I noticed that my engine was losing compression. This trouble continued to increase until presently the rig stopped entirely. I made several efforts to start it but was utterly unsuccessful. Inspection showed that one of the pin-bolts

A young friend was asked to go along. As the day was clear and calm and the roads fine, we decided on the return journey to try to beat the cyclists' record from Stockwell to Lafayette, a distance of thirteen miles. This record was something like thirty-five minutes. It was just 3.12 P. M. when we left Stockwell, with everything working at its best. There was but one hill, which we took on the high speed, but we stopped for two horse-drawn rigs and slowed down for two others and for three bridges. At 3.30 P. M. we had covered nine miles. Then, while running at top speed, we encountered a few small ruts and I lost control of the tiller. We skidded on dry ground to the right ditch, then across the

road and into the left ditch, where we finally stopped, having been thrown from our seats.

I turned and looked back up the road and was convinced that something had happened to one wheel, as our track was strewn

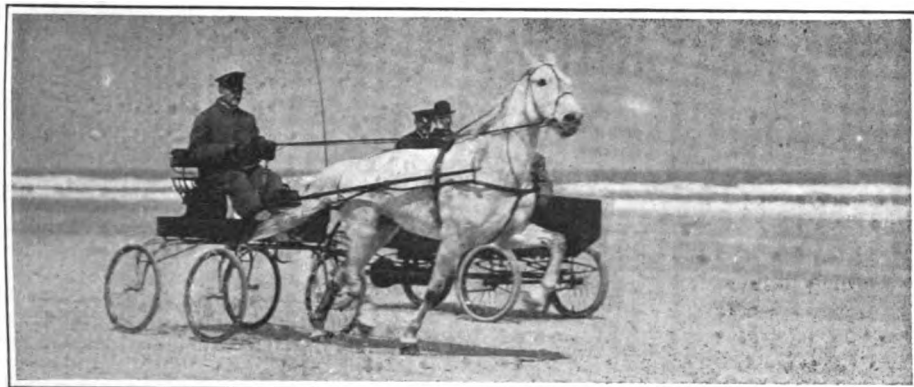

PACING "RED POINTER" WITH AN AUTOMOBILE ON THE ORMOND-DAYTONA BEACH.

with spokes, rim and tire. The fact then dawned upon us that we had been running too fast, and we proceeded to make the best of the catastrophe. Some farmers helped us into a nearby barn and after gathering up the rim and tire, and taking off the hub, we walked the rest of the way home. In forty-eight hours all repairs were made and I was using the machine again regularly.

HARD USAGE STRIPS GEARS.

The only difficulty I had with the run-about during the summer, outside of tire trouble, was the stripping of the gears, which happened on three occasions, costing me from \$3 to \$5 for repairs each time. Once this happened when there were four persons in the rig, and the high-speed clutch was released and the low-speed clutch applied for braking purposes. The next time it happened while climbing a long hill of about 14 per cent. grade. The engine was missing fire and I stopped to speed up the motor and then reapplied my clutch, when the snap came. The third time, it happened as I was pulling into my stable, taking a standing start on loose gravel. As few drivers have had this trouble with their gears, I believed there must be something wrong with the gear-case, so I described my trouble to the manufacturer, who very kindly sent me an entirely new transmission with eight rivet pins instead of five, and since then I have had no trouble whatever.

(To be continued.)

Pacing with an Auto.

The accompanying illustration shows the rather unique performance of a horse being paced by an automobile. The photograph from which the engraving was made is one of a trotter driven by Charles R. Mayers and which was taken on the Ormond-Daytona beach. This beach, which has in recent times become famous as a race course for automobiles, has also been found suitable for trotting. The

idea of pacing horses by means of automobiles is not a new one, but heretofore, so far as we know, it has been tried only on a regular track and not on a straightaway course. The Ormond-Daytona beach, with its wide stretch of hard, smooth sand

124 crates (868) boxes, and valued at \$3,000.

The Hard Manufacturing Company has a two-ton vehicle of the same type, but having a closed body like a moving van. Both vehicles were made by the Vehicle Equipment Co., and are said to be the largest in Western New York State. The Hard company's van has a 40-cell Exide underslung battery and is propelled by two motors of 3 1-2 horsepower each. Superintendent Walker states that it is capable of performing the work of three teams of horses and that the delivery of his concern's goods would be very slow without it.

INJUNCTION AGAINST SPEED LAW.

Special Correspondence.

CHICAGO, Sept. 5.—An injunction restraining the city of Lake Forest from further prosecuting its suit against Franklin P. Smith, a citizen of Lake Forest and a member of the Chicago Automobile Club, who was arrested for violating the speed ordinance on Aug. 14, was secured by Attorney Sidney S. Gorham, of the Chicago Automobile Club, last Thursday from Judge Charles H. Donnelly, of Woodstock, in the Circuit Court of Lake County.

The bill charged that the ordinance limiting the speed to eight miles an hour is unreasonable and void. It was filed by F. P. Smith for himself and other members of the Chicago Automobile Club similarly situated.

This is the first time the right of the city to regulate the speed of vehicles has been raised. Among the affidavits submitted in support of the application for an injunction was one from City Electrician Ellicott, of Chicago, in which he gives it as his opinion

and practically unlimited straightaway course, offers every facility for this purpose, and doubtless in future trotting may be added to the list of sports on the beach.

MOVING SILVERWARE IN BUFFALO.

Special Correspondence.

BUFFALO, Sept. 5.—Many of the manufacturing and merchandising companies of this city have recognized the advantages of the mechanically propelled delivery wagon and now a considerable portion of the distribution of merchandise by the leading merchants is done by power vehicle. The heavy trucking is still done by horse-drawn wagons, however, except by two concerns—the Larkin Soap Company and the Hard Manufacturing Company. These two companies use huge

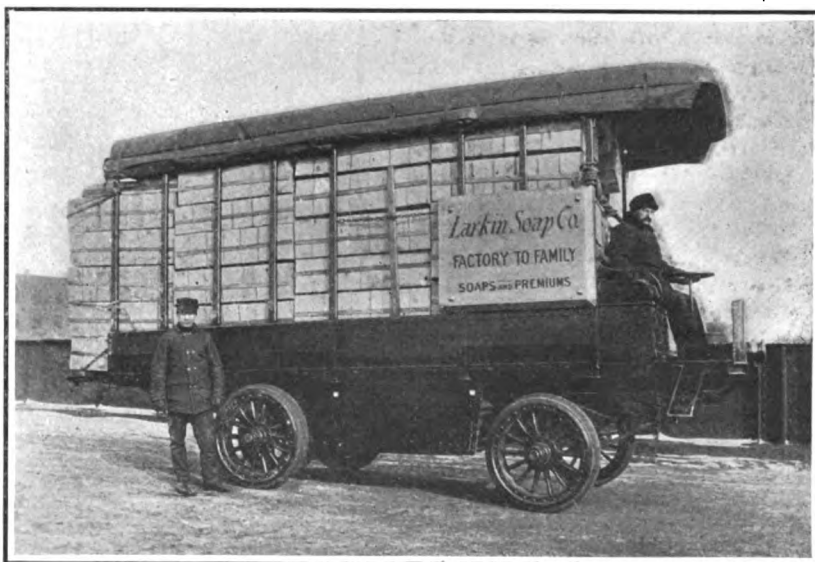

MOVING A LOAD OF 6,460 POUNDS OF SILVERWARE IN BUFFALO.

electric vehicles that always attract attention when seen in the street.

The engraving herewith shows the Larkin canopy top truck loaded with 6,460 pounds of silverware contained in

that the regulations should permit a speed of fifteen to eighteen miles an hour. This opinion was given after the city electrician had witnessed the brake tests given by the Chicago Automobile Club two weeks ago.

Del Monte Three-Days' Tournament.

Tour from San Francisco Followed by Track Races and Hill Climb.—New Amateur Star Developed.

Special Correspondence.

SAN FRANCISCO, Aug. 28.—To-day's hill climbing contests at Del Monte closed the most successful automobile race meet ever held on the Pacific Coast. The track was unusually fast, and the weather perfect. The crowds filled the stands and paddock each day of the racing, and included some of the best known in the social sets of San Francisco and Los Angeles, as well as many among the large number of eastern tourists at Del Monte and Monterey. Many members of the A. C. of California, accompanied by their friends, made the trip by automobile from San Francisco, Oakland, San Mateo, Burlingame, Menlo Park and San Jose by the routes shown in the accompanying map.

The program was carefully arranged so as to give cars of all the makes fair chances, and comprised twenty events, four of which were hill-climbing contests. The competing cars were almost entirely of the stock pattern.

The feature of the meet was the development of a new star among amateur drivers. George P. Fuller, of this city, carried off the main honors of the meet with his 24-horsepower four-cylinder Pope-Toledo and gave a consistent exhibition of driving such as has not been seen on the Coast except in the case of Barney Oldfield's visit last year, and asks little odds even at the hands of that intrepid driver. Fuller is practically new at the game, but he has all the coolness and skill of a veteran and takes his turns with a cleverness that is little short of marvelous. He has a peculiar style of nursing his wheel almost over his right shoulder and his driving throughout is especially remarkable for its steadiness. His fastest mile was made in 1:03 1-5, and his fastest five miles in 5:21 2-5. He was selected as the representative of the Automobile Club of California in the race for the Inter-Club Challenge Cup presented by L. P. Lowe, chairman of the racing committee, Frank A. Garbutt, of Los Angeles, having been chosen as the representative of the Automobile Club of Southern California. No race, however, for the trophy took place, Garbutt's new Stewart-Garbutt car meeting with a mishap that caused it to be withdrawn. The trophy remains in the custody of the Automobile Club of California, and may be challenged for by any recognized automobile club of California in a track race, an endurance contest, a hill-climbing test, or any other event that may be agreed on.

Three Pope-Toledos were raced and gave remarkably consistent performances. The ten-mile race for touring cars, under touring conditions, was won by E. R. Diamond's

Pope-Toledo in 13:24 2-5. The best five miles was made in 6:33 4-5. A Pierce Arrow car was entered by the Mobile Carriage Company, but it was an ordinary stock car, and could not be geared high enough for track racing.

F. D. Ryus' *White Ghost* did excellent work the first day of the meet, but did not get fairly into action on the second day until the five-mile free-for-all, when Ryus made a mile in 1:03 2-5, and covered the total distance in 5:37 4-5. Dr. Hill's 40-horsepower Mors, in which Fournier drove

in the ill-fated Paris-Madrid race, broke down before racing was begun on the first day.

The hill-climbing contest to-day was over Carmel hill, on the famous seventeen-mile drive, and drew the biggest crowd of the meet. The grade is about 12 per cent. and the distance 1 5-8 miles. In places the grade reaches 14 per cent. Bert Dingley, in a four-cylinder Pope-Toledo, made the course in 2:43 and fainted at the finish. The road was rough and the racking something fearful.

The results of the races for the entire meet follows:

FIRST DAY, AUGUST 26.

Five-mile race for gasoline runabouts and light touring cars, 10 1-2-horsepower and less, no restrictions—First heat: A. C. Hull (Cadillac), first; time, 7:49. Second heat: C. H. Lechter (Cadillac), first; time, 7:34 1-2. Final: Lechter, first; time, 7:24.

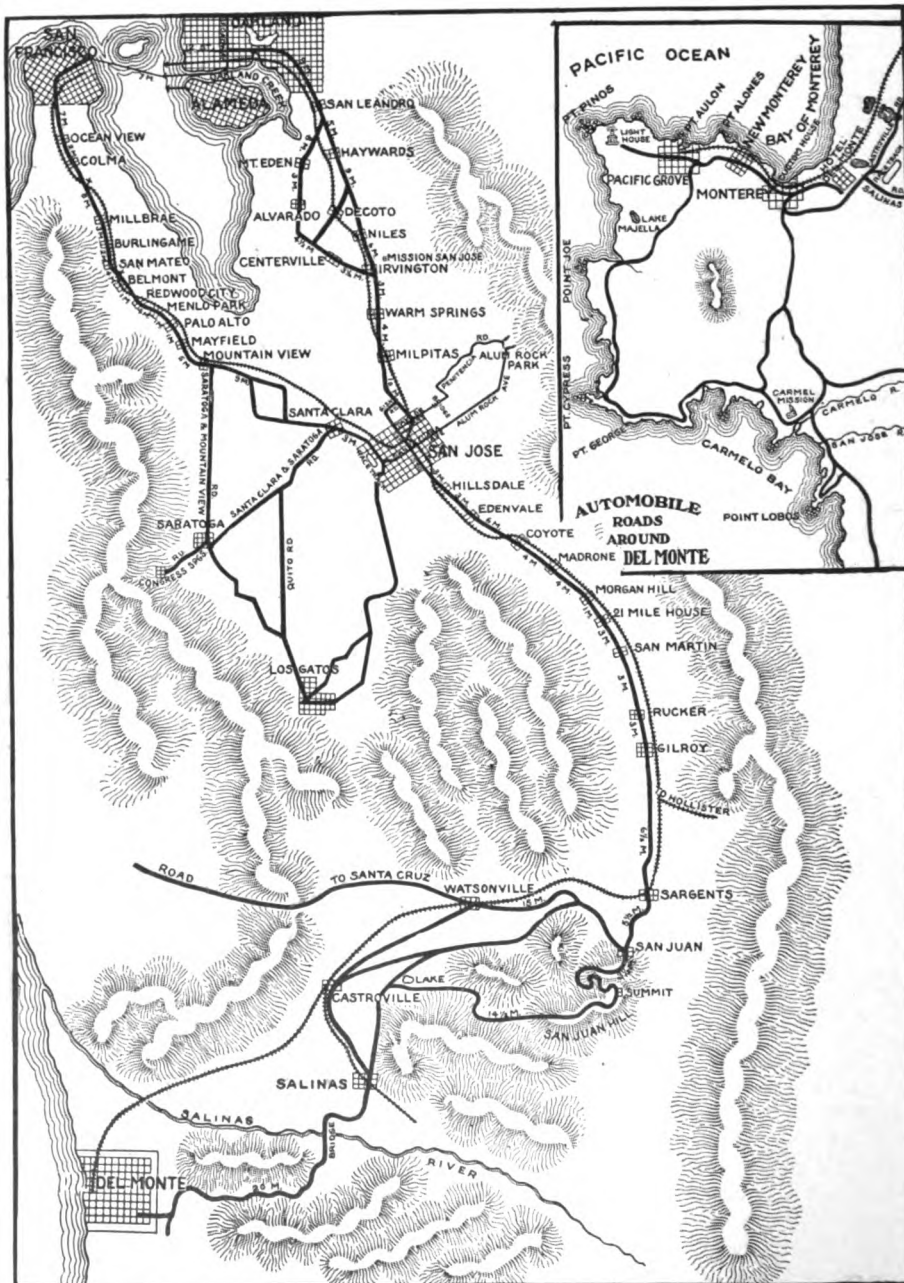

MAP OF ROADS FROM SAN FRANCISCO AND OAKLAND TO DEL MONTE.

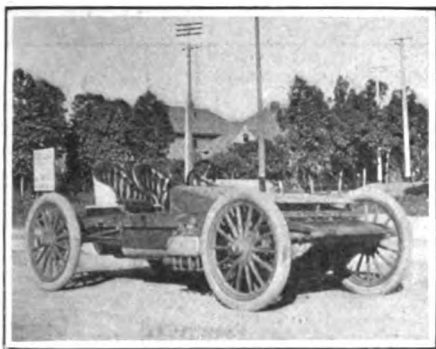

F. A. GARBUTT'S NEW RACING CAR.

Five miles for gasoline light touring cars, costing \$1,500 and less, in touring condition, no restrictions—Henry Cousins (Rambler, \$1,200), first; time, 8:16 3-4.

Five-mile open, for cars costing \$2,000 to \$4,000, no restrictions—First heat: H. D. Ryus (*White Ghost*, \$2,500), first; time, 5:51. Second heat: George P. Fuller (Pope-Toledo, \$3,500), first; time, 5:30 1-2; best mile, 1:04 3-4. Final: Ryus, first; time, 5:25 1-2; best mile, 1:04.

Five miles for gasoline road cars, 10 to 16-horsepower, no restrictions—First heat: J. Schnerr (Cadillac), first; time, 8:17 1-4. Second heat: C. H. Lechter (Cadillac), first; time, 7:30 3-4. Final: Schnerr, first; time, 7:14 1-2.

Five-mile open, for road cars costing from \$1,200 to \$2,550, no restrictions—W. E. Saunders (Rambler, \$1,200), first; time, 6:35 3-4; Walter Grothe (White, \$2,000), second.

Pursuit race for gasoline road cars, costing \$1,000 and less, no restrictions—Lechter (Cadillac, \$900), first; time, 13:05.

Pursuit race, open, for road cars costing from \$1,000 to \$2,550, no restrictions—Saunders (Rambler, \$1,200), first; time, 18:00.

Five-mile free-for-all for Del Monte Cup, no restrictions—First heat: F. J. Swentzel (Pope-Toledo, 24-horsepower), first; F. A. Garbutt (Stewart-Garbutt), second; time, 5:38 1-2; best mile, 1:06 1-4. Second heat: George P. Fuller (Pope-Toledo, 24-horsepower), first; Bert Dingley (Pope-Toledo), second; time, 5:24 1-5; best mile, 1:03 1-4, record for the meet, and claimed to be track record for stock cars. Final: Fuller, first; time, 5:21 2-5 (record for the meet).

SECOND DAY, AUGUST 27.

Three-mile race for gasoline runabouts and light touring cars, costing \$1,000 and less, no restrictions—C. H. Lechter (Cadillac, \$900), first; A. C. Hull (Cadillac, \$900), second; time, 7:39.

Ten-mile open, for touring cars costing from \$1,551 to \$4,000, no restriction as to gearing—R. G. Fowler (Pope-Toledo, \$3,500), first; time, 13:24 2-5; best mile, 1:18 2-5.

Five-mile open, road cars from 10 to 16 horsepower, no restrictions—First heat: W. E. Saunders (Rambler, 16-horsepower), first; time, 6:00 3-4. Second heat: W. K. Cowan (Rambler, 16-horsepower), first; time, 6:31 2-5. Final: Saunders, first; time, 6:01.

Five-mile open for road cars from 10 to 24 horsepower, no restrictions—First heat: George P. Fuller (Pope-Toledo, 24-horsepower), first; F. J. Swentzel (Pope-Toledo, 24-horsepower), second; time, 5:26; best mile, 1:03 2-5. Second heat: W. E. Saunders (Rambler, 16-horsepower), first; time, 5:54; best mile, 1:08 4-5. Final: Fuller, first; time, 6:03 4-5.

Five-mile pursuit race, road cars costing \$2,501 to \$4,000, no restrictions—Bert Dingley (Pope-Toledo, \$3,500), first.

Five-mile free-for-all, no restrictions—F. D. Ryus (*White Ghost*, 15-horsepower), first; Bert Dingley (Pope-Toledo, 24-horsepower), second; time, 5:37 4-5; best mile, 1:03 3-5.

Fifteen-mile pursuit race, free-for-all, no restrictions—Fuller (Pope-Toledo, 24-horsepower), first; Dingley (Pope-Toledo, 24-horsepower), second.

THIRD DAY, AUGUST 28, HILL CLIMBING.

Runabouts and light touring cars, costing \$1,000 or less—A. Hull (Cadillac, \$900), first; time, 4:40 1-5; L. Vidy (Ford, \$900), second; time, 4:52 4-5; Diehl (Ford, \$900), third; time, 5:34 3-5.

Touring cars, \$1,001 to \$2,550—Saunders (Rambler, \$1,200), first; time, 3:04; Cowan (Rambler, \$1,200), second; time, 3:33 1-5.

Road cars, \$2,000 to \$4,000—Bert Dingley (Pope-Toledo, \$3,500), first; time, 2:48 4-5; H. M. Chambers (Pierce-Arrow, \$4,000), second; time, 3:44 3-5; Walter Grothe (White, \$2,000), third; time, 3:45 3-5.

Free-for-all—Bert Dingley (Pope-Toledo), first; time, 2:43; W. E. Saunders (Rambler), second; time, 2:47 2-5; H. M. Chambers (Pierce-Arrow), third; time, 3:25 4-5.

COAST ENDURANCE RUN.

Start of 1,000-Mile California Inter-Club Tour Set for September 21.

Special Correspondence.

SAN FRANCISCO, Sept. 2.—Now that the Del Monte meet is over and has proved so great a success, the energies of the Automobile Club of California are being devoted to the proposed endurance run to Los Angeles and return. Efforts in this direction necessarily lapsed during the weeks immediately preceding the Del Monte meet and the impression has gotten abroad that the

run has been given up. This is far from being a fact. Within a day or two a circular will be sent out by the executive committee of the club, setting the date for starting the run for Sept. 21, outlining the conditions and calling for definite entries.

It had been proposed that the A. C. of Southern California should participate in the run, making its first half of the course on the return trip of the San Francisco automobilists, and completing the run with San Francisco as the starting point. Owing to the lack of replies to a circular invitation to participate, due in part to the uncertainty of the date and the interest in the Del Monte meet, it was given out from Los Angeles that the run proposition had failed.

The Del Monte meet having succeeded so far beyond all expectations, interest in the sport is now at a much higher pitch than ever before in this section, and many inquiries have been received by Chairman L. P. Lowe, of the executive committee of the 'Frisco club, indicating interest in the endurance event and presaging its success. Touring interest is constantly increasing among owners, and such a test as will be afforded by the 1,000-mile endurance run cannot fail to prove instructive and of more than usual interest.

Stella—"Did he propose on his knees?"

Bella—"Beautifully; you see, he's so used to crawling under his auto."—*New York Sun*.

George Unger had a horseless nightmare recently. He dreamed that Dr. Elmer's automobile had run him down.—*Rochelle (Ill.) Independent*.



The engraving shows one of the most tastefully decorated cars in the floral parade, which was one of the features of Liberal Arts Day at the Louisiana Purchase Exposition, St. Louis, on Saturday, August 27. The car shown is a Columbia, and is owned by Mrs. Shouteau Scott.

British 1,000-Mile Motorcycle Trials.

Special Correspondence.

LIVERPOOL, ENG., Aug. 25.—The British Autocycle Club held its second annual trials for motorcycles from Aug. 15 to 21. The trials took the form this year of a tour extending over 1,000 miles, starting from London, going along the East Coast to Scarborough, then south through Coventry and the Midlands to Oxford and London, where the tour terminated. The roads traversed embraced some very hilly districts, and, as will be seen, none but the best machines could get through with success. The day's run averaged from 150 to 160 miles, an hour's stop for luncheon at midday being allowed.

Forty-eight machines were entered for the trials, thirty-nine being single-seated and nine double-seated vehicles. Out of the total number, twelve had chain drive and the rest had belts. Only three had magneto ignition, all the others using the usual high-tension system with accumulators and coil.

The start was made from the garage of the Automobile Club of G. B. & I. in London at 7:30 a. m. Monday, all the entrants appearing except the Alldays and Lagonda tricar, and the Montgomery side-car, all of which had arrived too late for the weighing in the Friday before. Thus three out of the nine two-seated motorcycles were out of the running, rather a disappointing state of affairs, as great interest was centered on the performance of the two-seaters.

The machines had not necessarily to make non-stop runs each day; repairs were allowed, but only with materials actually carried on the machines. All stops were to be reported and would be counted when giving the awards.

All the competitors having been despatched on their journey, the writer set out in a 6 1-2-horsepower De Dion to accompany the band of motorcyclists who were to show the public what motorcycles could do. Through the almost interminable suburbs of the metropolis, we kept well behind the riders, but when Barnet hill was reached we began to overhaul the laggards. At well over the legal limit we dashed along, wishing to reach St. Albans before the competitors. At the entrance to this town the judges arranged an unexpected hill-climb up the sharp rise of Holywell Hill. All had to stop half way up and restart on a stiff gradient. It was hard work, but all managed to go through the ordeal with success. Passing through streets lined with interested spectators, we made a fast run through the rain to Hertford, where the first mishap occurred. A. Van Hooydonk, on a Phoenix tricycle, while crossing a bridge only eight feet wide, ran into the curb and smashed a wheel.

Beyond Hertford the roads became worse, owing to the rain, and a mile further one we

had to ford a stream. The motor-bicycles were wheeled across a narrow foot bridge. Passing through many country villages, where great interest was shown by the rustics, we were glad to reach Colchester, where the stop for luncheon was made. Off again after an hour's rest, we passed through Ipswich, where all turns were denoted by boys with flags. Here the Kynoch chain-driven machine (No. 13) caught fire from gasoline leaking onto the red-hot exhaust pipe. In ten minutes the machine was destroyed.

Without further incident we arrived at Yarmouth, the stopping place for the night. The competitors began to pour into the local garage, all complaining about the weather and the bad roads. The only troubles in most cases were a few punctures and broken belts. The Rover tricar broke an exhaust valve and did not arrive that night. Two other machines had abandoned the contest on the way; hence only forty-one finished out of forty-five starters.

Tuesday's run—the longest of all—was over 210 miles, hence an early start was made, at 6:30 a. m., all getting off merrily, in better spirits, owing to the improvement in the weather, which was perfect. A few miles out, the Noble forecar buckled a wheel in a collision with a cart and retired. Shortly afterwards the Bradbury tricar smashed into a wall. Without a doubt the two-seated vehicles were having the worst of it. At Norwich the police kindly kept the road clear, and at every turn stood a boy, holding a card on which was painted a red arrow pointing out the direction to be taken. We passed many competitors held up by punctures before we reached the stopping place at Ely. The Barnes machine had eight punctures and two burst tires, and did the last ten miles on the rim.

After lunch we passed through Cambridge, and going along the famous North Road we had tea at Bukden. Punctures were again very prevalent. Thirty-six riders finally reached Stamford, where the night was passed. The Bradbury tricar had new wheels fitted, and rejoined us there.

Wednesday was by far the worst day of the week. At 7 a. m. every one was up and expecting a most glorious day. An hour later the competitors were despatched on their 165-mile run to Scarborough, and at the same time rain began to fall. Down it poured all day, and as we plugged along through the mud we were constantly passing riders looking with concern at their belts or plugs. Several machines which had the coils in exposed positions had these quite ruined by the rain. Just before the conclusion of the day's run the riders had to tackle Malton Hill, about a mile of 1-in-8 gradient. Considering the mud on the road—inches deep in some places—the machines

did very well. Some riders had to pedal hard, others dismounted and ran alongside, but the majority surmounted it without exertion. From the crest we had a steep descent into Scarborough, where we found most of the riders, all plastered with mud and almost unrecognizable.

When the start was made for Doncaster, 160 miles away, Thursday morning, the weather had improved somewhat. Nevertheless the roads were very treacherous and the Chase and Tap riders had bad falls through side-slips, the Chase being put out of action by a broken axle. Many others were delayed by tire troubles. Twenty-four riders finished out of the twenty-eight starters from Scarborough.

Oxford was the destination on Friday, 185 miles away. Several competitors were early in trouble. Hulbert cracked his cylinder; another rider had a seized piston. Hooydonk, on the Phoenix, had carburettor troubles owing to rain getting into his fuel. With these exceptions the riders got through without trouble, most of them getting over the Chiltern Hills in fine style. There had been twenty-five starters that morning, of whom twenty-two reached Oxford safe and sound. All were in good form, considering the ordeal they had passed through.

Saturday, the last day of the trials, the 145-mile run back to the metropolis was commenced at 8 a. m. The day was very hot—quite a contrast to the rest of the week—and the roads being of a chalky foundation, were fearfully dusty. The machines were running better than ever, however, and all arrived too early at the control, where lunch was taken. The road surface was good, especially where it had been treated with the dust-laying preparation, Westrumite. Crundall, on the Humber forecarriage, was doubtful whether he could finish, for part of his sparking plug had dropped into the cylinder and was dancing about on top of the piston. After passing through the suburbs of London, the riders made their way to the Automobile Club's garage, where a large crowd awaited them. First to arrive were the Humber and Altina machines, followed by a dozen more soon afterwards. The Griffon rider had so much trouble with his back tire that he discarded it and rode the last ten miles on the rim. Silver—famous for his 6,000-mile tour on a motorcycle in South Africa last autumn—came in on his Quadrant machine quite spick and span, having stopped on the way in to clean himself and his mount. Van Hooydonk, as the only forecarriage rider to get through, attracted much attention to his Phoenix forecar, which has a 3 1-2-horsepower air-cooled engine, chain drive, and two speed gear.

Out of forty-five starters on the first day, only twenty completed the trials. Tire troubles were responsible for most of the failures; engine and ignition troubles—especially the latter—being comparatively rare.

Auto Meet Without Races.

Special Correspondence.

PARIS, Aug. 27.—A successful four-days' automobile meet was held recently by the Automobile Club of Dauphiné, France, opening with a 310-kilometer tourist run. Starting at Grenoble, the course took the participants through Gap, by way of the Laffray Hill—a formidable climb—Embrun, Briancon, and back to Grenoble by way of the French Alps.

There were twenty-seven starters, and of these twenty-three finished in creditable time. The best time for the day's run was made by Vitalis, driving a 35-horsepower Rochet-Schneider, his figures being 6 hours 52 minutes for the 192 1-2 miles. The same car made the best time up the Laffray Hill, the distance of 6 1-2 kilometers (4 1-2 miles) being covered in 10 minutes 42 seconds.

The second day's run was of the same character as the first, but the classes included motor bicycles as well as automobiles. The distance was but 190 kilometers (118 miles), and speed tests on the grade of the Col du Cucheron were made compulsory, the climb being three kilometers long. Vitalis did not compete in the second day's run, owing to mechanical troubles, but another Rochet-Schneider, driven by Ollion, made the best time on the hill—17 minutes 10 seconds. Second and third places in the hill climb were also taken by Rochet-Schneider cars. In addition to the

again at Grenoble, passed through Yenne, Chambéry, Uriage, and back to Grenoble.

On Saturday, the third day, a 500-meter speed trial was held, with standing start and stop, and the day ended with a "Concours d'Elegance." The speed trials were won by Vitalis, who had got his 35-horsepower Rochet-Schneider in shape, in 40 seconds. A Peugeot motor bicycle ridden

Launch Cylinder Measurement.

Whatever improvement may result in time in the measurement rules for auto-boat racing, it is probable that the cylinder dimensions, either linear as in the American and British rules or cubical as in the French rule, will remain a controlling factor. During the present season two serious difficul-



CORMIER, IN 12-HP. DE DION, WHO MADE BEST SCORE, FINISHING 500-METER TRIAL.

by Yourassoff was second, in 44 seconds. A De Dietrich car was third, and fourth and fifth places were taken by motorcycles.

Awards in the touring events were made according to a point system, 600 points being allowed for regularity, 300 for fuel consumption, 100 for water consumption, 300

ties have arisen in the practical application of the rule of the American Power Boat Association in the determining of the horsepower, as it is often impossible to obtain either the cylinder dimensions or the number of revolutions.

In almost every race there are some launches that come in but a short time prior to the start, and, while their hull dimensions may be obtained, there are few owners who care to take off a cylinder head just before a race. There is one remedy for this difficulty which is both simple and practical; the maker of the motor should stamp on every cylinder or cylinder head the exact measurements of length of stroke and diameter of bore. While all that is really necessary in this country is to give these dimensions in inches, it would be a matter of general convenience if every motor, wherever built, had the dimensions in both inches and centimeters plainly marked.

The subject is one that is eminently within the domain of the new Association of Engine and Boat Manufacturers, whose influence would secure the adoption of the practice at home, if not in other countries as well.

"Patti promises to make an automobile tour of the United States. There is one satisfaction, she cannot charge us \$5 for standing by the fence and watching her go by.—*Birmingham (Ala.) Ledger.*

General Booth, the Salvation Army leader, is now conducting an evangelistic automobile tour of England, and since the King and Queen have given their approval of his work, he is reported to be meeting with greater enthusiasm than has been shown since John Wesley rode through that country on a similar mission.

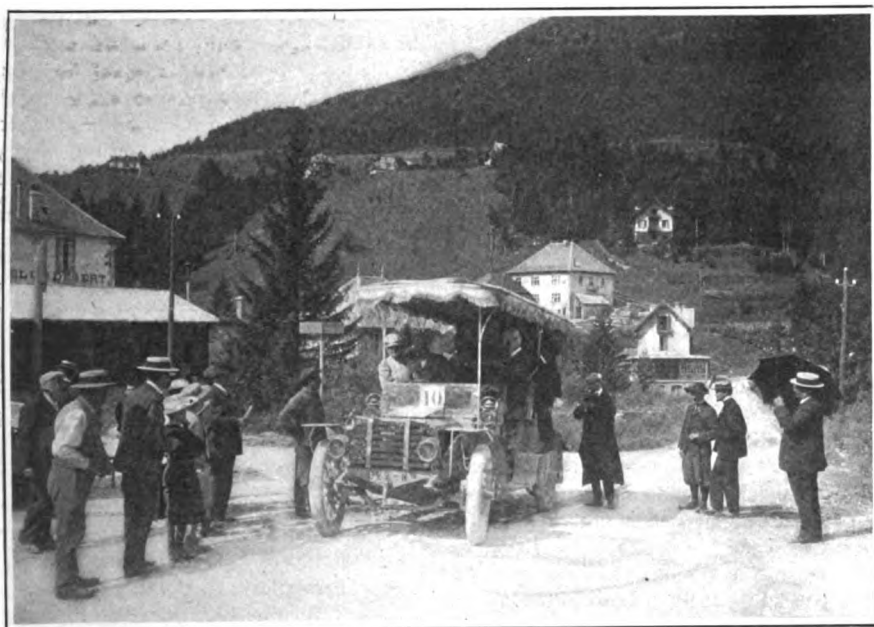

DE DIETRICH TOURING CAR PASSING THROUGH ST. PIERRE IN DAUPHINE CLUB RACE.

twenty-five automobiles in the second day's contest there were twelve motor bicycles, which started two hours before the cars. A feature that marked this day's run was the hostility of the peasants along the route, who scattered nails in the road and bombarded the contestants with harmless, but unpleasant, missiles. The course, starting

for hill speed, 300 for average speed, 100 for comfort, and 200 for chassis cost. Cormier, in a two-cylinder De Dion, made the best score, running up 1,735 points out of a possible 1,900.

Sunday, the concluding day, was devoted to the invariable and ever-popular gymkhana.

HINTS TO AMATEURS ON THE USE OF FILES.

AN automobilist who has a knowledge of the correct way to use tools, even though his knowledge may not be very extensive, has a great advantage over the man who knows what tools are capable of doing, but does not know how to make them do it. Experience will teach one a great many things in the course of time, and skill in the handling of tools is one of them; but there are a good many things that take a very long time to learn in this way, when they might just as well be picked up in some less troublesome, not to say expensive, fashion.

Filing is one of the mechanical arts that is not as easy as it looks. To see an experienced hand working with a file one might imagine it was a simple matter; but it is not. Long practice is required to do really good filing, especially if one starts about it the wrong way. There are many who believe that a file cuts both ways, which is quite the opposite to the truth. The teeth of a file are set pointing away from the tang, so that they "bite" only when the file is being pushed forward, a file being just like a saw in this respect. Therefore no pressure should be placed on the file on the return stroke. In fact, it is better to raise it clear of the work, thus saving wear. It is a fact that the practise considerably lengthens the life of the file. Form the habit of using the full length of the file rather than working in short, jerky strokes and placing all the wear in the same spot. The work should be placed at about the height of the elbow. If it is much lower or higher (especially higher), the file is not under as perfect control as if the height was correct.

* * *

The greatest difficulty in filing is to keep the tool working back and forth in a straight line. The natural tendency of the inexperienced mechanic is to keep the ends of the file going up and down, the result being that the surface of the work will assume a convex form instead of remaining flat. The reason is that, the same pressure being applied at each end of the file, the end that projects farthest over the work will have the greatest leverage and will cause the short end to rise, keeping up a see-saw which is fatal to good work. To remedy this it will be found necessary to lighten the pressure on the long end and bear down more heavily on the short end as the stroke proceeds. This is the only way to accomplish good work with a file.

It is a common thing to see a tyro grasp his file with a terrible grip, stiffen up the muscles of his arm and swing awkwardly to and fro in a desperate endeavor to keep the file straight; but it cannot be done in this way. Furthermore, the only way to take a heavy cut with a coarse file when a large amount of metal has to be removed, is the method described. Stand with the

right foot well back and throw your weight on the file by easing upon your left foot. Hold the handle of the file in the right hand, thumb on top, fingers underneath and the end thrust coming against the palm. For heavy work, place the ball of the thumb of the left hand on the end of the file and let the fingers find their own places. For light work the tip may be held between the thumb and fingers, but there is only one correct position for the right hand. A very little practise will show that this is not only the most effective, but the most comfortable position for working in.

* * *

Hard brass and phosphor bronze are hard on files, and should be worked with new tools. Cast iron is also rather wearing, but a file that will scarcely touch hard brass will work nicely on almost any other metal. In filing new castings, or castings that have not had the rough exterior skin removed, recollect that this skin is exceedingly hard and will spoil a new file very quickly indeed. In fact, it is sometimes difficult to get through the outer surface of a casting. For this work old worn-out files may be used in order to save the good ones. When there is no longer an edge or a corner on old files that can be used for such work they may as well be put out of commission as files. Do not throw them away, however, as there are many other uses to which they can be put.

When filing cast iron, be careful not to rub your hand or greasy waste over the surface on which you are working. If this is done the file will refuse to take hold again until the surface has been cleared of the very slight amount of lubrication necessary to make the file feel as if it was skating around on a piece of hardened steel. In filing wrought iron and steel it will be found that the teeth soon become clogged with particles of metal. This can be obviated to some extent by rubbing the face of the file with a piece of chalk, allowing the filings to be dislodged by a few smart raps of the file on the vise. Aluminium and copper will stick to the file in the same way, especially the former, and as chalk will not do much good, use turpentine on the file, applying it with a rag or a bit of waste. This may seem rather a nuisance, and so it is; but try filing aluminium without it and you will be glad to make use of the turpentine.

* * *

Files will clog up in time notwithstanding these precautions, and may be cleaned by the use of a file card—a brush made of short, stiff steel wires. An even more effective method of cleaning is to take a piece of sheet brass about 1-32 of an inch thick and rub it across the file in such a way that the edge of the brass will be cut into a series of saw-like teeth which will

exactly fit into the teeth of the file. A piece of wood may be used in the same way. A good file should never be used for lead, babbitt metal, solder or other soft metal, as the teeth will fill up so solidly that it may be necessary to melt out the adhering metal, and the melting process is very apt to take the hardness out of the steel.

* * *

After having removed as much metal as is necessary surfaces may be made smoother than by the regular method of filing by "draw-filing." This consists of holding the file in the position of a carpenter's draw-knife and working it lightly over the surface in this position. By draw-filing with a smooth file quite a fine surface can be obtained. In this case chalk should be liberally used and the file tapped at frequent intervals to remove filings which would otherwise probably spoil the appearance of the surface by deep scratches.

* * *

In using round and half-round files, for enlarging holes, for instance, turn the tool on its axis during the stroke and turn to a fresh place quite frequently to avoid local wear. These files are more difficult to clean than flat ones, so be careful not to get them filled up.

One of the most convenient and useful files made is a good-sized square file. It is a splendid tool for taking heavy crust from obstinate metal, as, for instance, hard brass castings. And when its usefulness is almost gone, it has no equal for taking the skin off iron castings to make way for a good file. The corners are much better and more convenient for working in angles than those of a flat file. Of course it is of no use when the angle is sharper than a right angle; in this case a triangular file must be used, or, for very acute angles, half-round or fish-back files. A fish-back file is like a half-round file except that it is convex on both sides, instead of being flat on one side, as is the half-round tool. Old fish-backs are also excellent for getting through the skin of castings and similar work.

* * *

Files that have outlived usefulness in their original forms may be used for many other purposes. Square and triangular files (particularly the latter), make fine scrapers for finishing metal surfaces very smoothly or very accurately. The tang of a file, broken off, ground smooth and sharp on the corners, hardened and tempered and provided with a handle, makes a good rough-and-ready reamer. Files of various shapes, ground to suitable angles, make excellent hand turning tools for metal work. There are many other uses to which the superannated file can be put, but those named will serve to give an idea, and others will suggest themselves as occasion arises.

Welch Gasoline Touring Car.

The gasoline touring car built this year by the Welch Motor Car Co., successor to the Chelsea Manufacturing Co., is a considerable departure from the Welch car of last year and embodies a number of interesting and attractive features, some of which are illustrated herewith. Its special feature is a transmission gear of the individual clutch type, but provided with means for rendering all gears idle when driving in the high gear. The latter is direct, as are many arrangements of sliding gears, but the disconnecting feature may be said to be new.

The engine also embodies some excellent features which should give it high fuel economy and great efficiency.

The running gear is of conventional form, with channel section, pressed steel side members, connected at the rear by a pressed steel channel cross member, and in the middle by two angle bars supporting the gear box. At the front they are un-

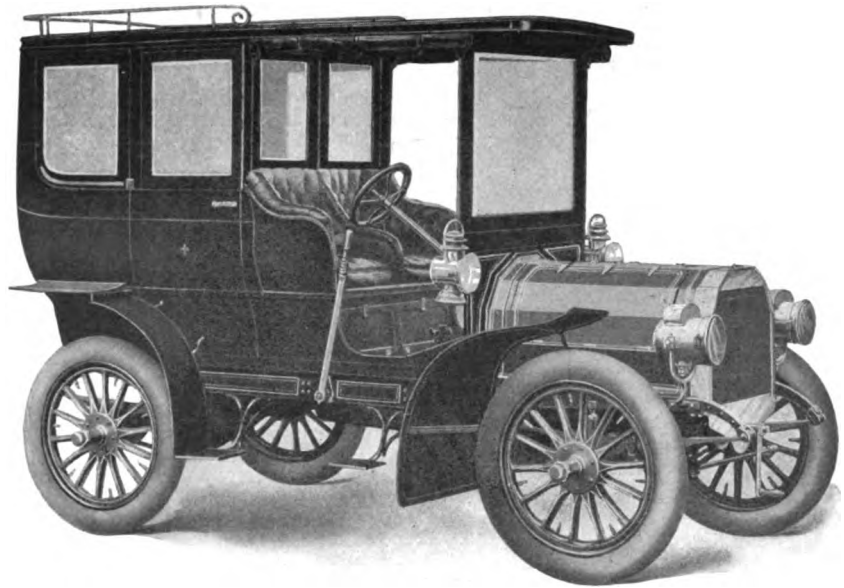

FIG. 1.—WELCH FOUR-CYLINDER CAR WITH SIDE ENTRANCE PULLMAN LIMOUSINE BODY.

The makers state that the combustion chamber is not unusually small, and that which usually heat the incoming charge are absent and the valves themselves are readily

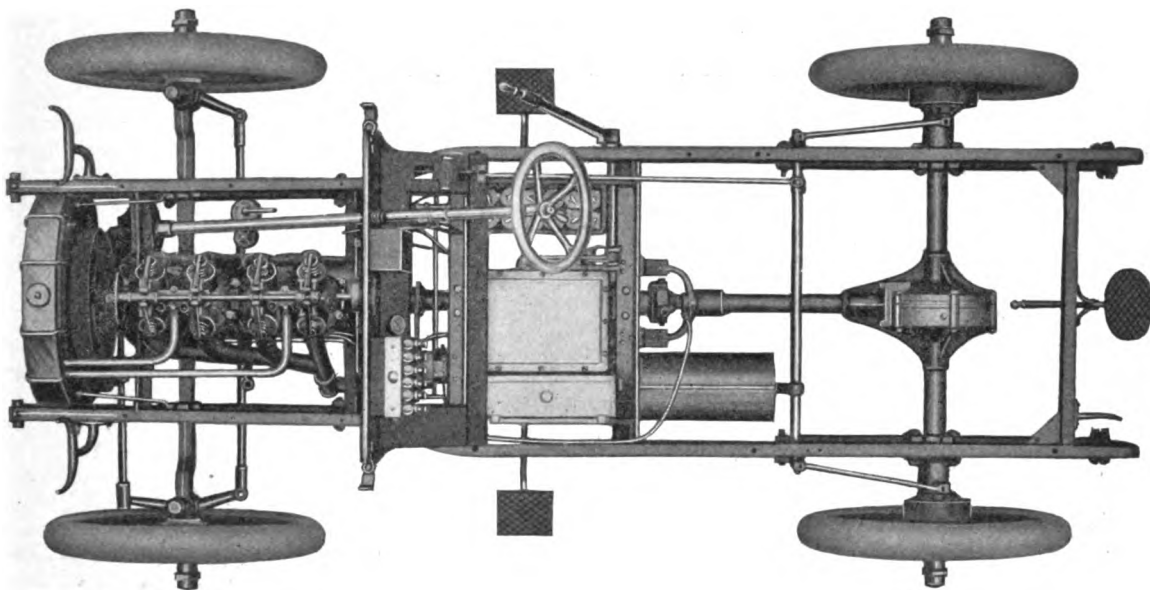

FIG. 2.—CHASSIS OF WELCH CAR, SHOWING CONVENTIONAL FORM AND SHARP RAKE OF LONG STEERING POST.

engine crank-case, which is secured to them very rigidly.

The engine has four cylinders with integral-heads and water-jackets, the cylinders being cast in pairs. The cylinder heads are hemispherical internally, and the piston heads are slightly concave in order to secure a combustion space with the smallest practicable containing wall surface, which favors the maximum rapidity of combustion. The valves are all mechanically actuated from a cam-shaft running in brackets on top of the engine, being driven by an intermediate shaft and two pairs of bevel gears, as the drawing shows. The valve stems are therefore short and are acted on directly by short levers, so that the inertia to be overcome by the valve springs is comparatively small, and the springs can be made correspondingly light.

they get a high compression by getting a large volume—or weight—of mixture into the cylinder, because the valve passages

kept cool. The connecting rods are of I-beam section, and the crankpin bearings are taken up by the taper key and strap end

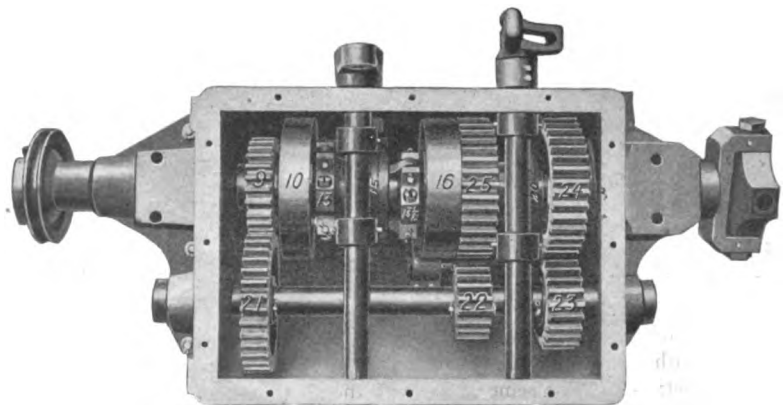

FIG. 3.—CHANGE-SPEED GEAR BOX WITH COVER REMOVED.

familiar in locomotive practice. The shaft has intermediate bearings between all the cylinders, but the second and fourth bearings are quite short.

The engine is provided with a centrifugal governor which automatically advances and

As the spark plugs are placed directly over the pistons, as the drawings show, the lead is much less for a given speed than it would have to be if the spark plug were at the end of a valve chamber at one side. The makers state that the cylinders and pis-

from the driving shaft, and therefore do not turn.

The means whereby this is accomplished is seen in Fig. 4. The first or driving shaft *A* telescopes inside the short shaft *B*, on which is secured the hub of a friction clutch

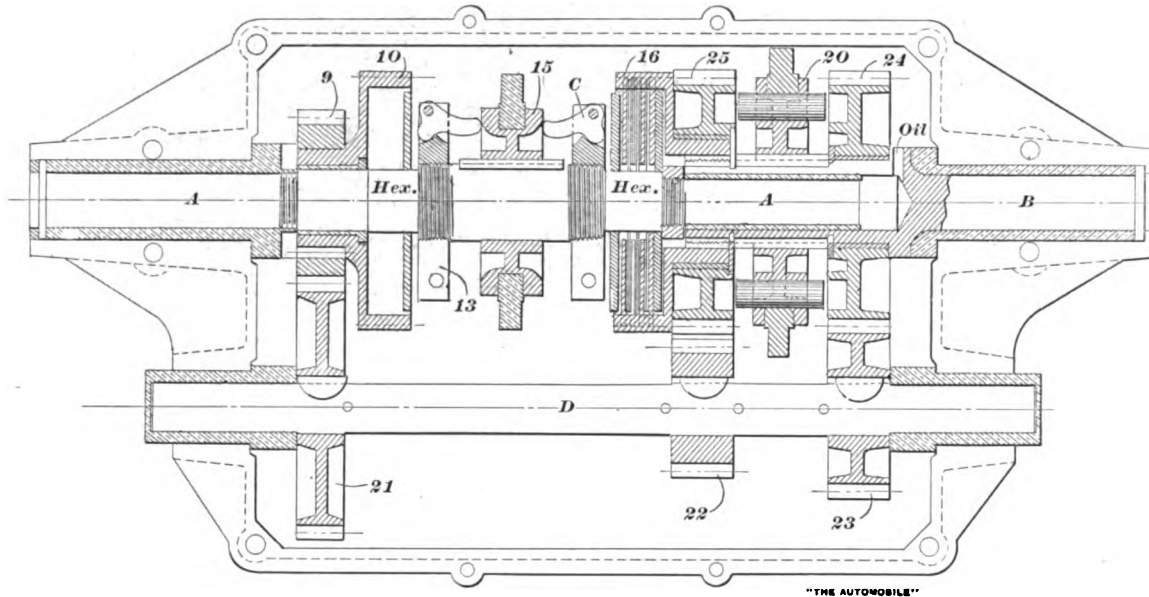

FIG. 4.—PLAN VIEW IN SECTION OF WELCH INDIVIDUAL CLUTCH CHANGE-SPEED MECHANISM.

retards the spark. This is a feature of which less has been heard of late than a few years ago, possibly because in the earlier forms of this device there was no means of modifying the spark advance according to temporary conditions of fuel and weather.

tons are lapped to size, and are perfectly interchangeable.

The catalogue omits to state either the size or horsepower of the engine, but the cylinders are 4½ by 5 inches, so that it should develop 24 to 30 horsepower.

member 16, to be described in detail. By means of the sliding collar 15 and dogs *C*, *A* and *B* are locked together, and *B* drives the propeller shaft through a universal joint of liberal dimensions. Turning loosely on the hub of 16 is a gear 25, and

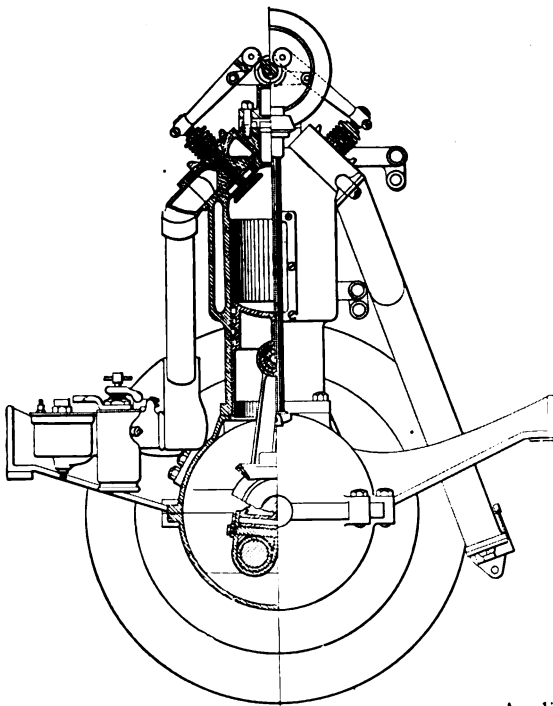

FIG. 5.—ONE CYLINDER IN PART SECTION.

This omission has been corrected in the engine in question, in which the governor is supplemented by a hand control lever, which determines the best position of the governor, and thereafter is not disturbed.

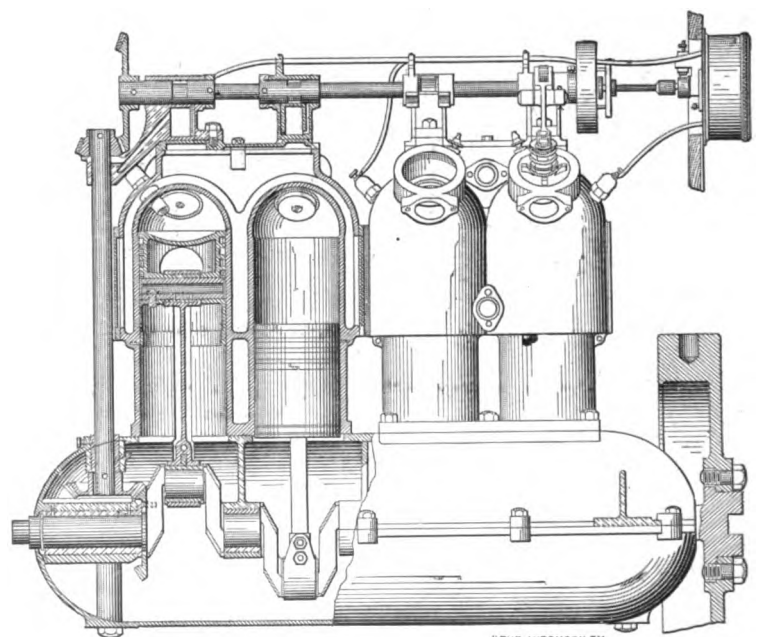

FIG. 6.—ENGINE OF WELCH CAR PARTLY IN VERTICAL SECTION.

A slip joint or loose coupling connects the engine with the first shaft of the transmission gear, which is shown with the top removed in Fig. 3. As above noted, the transmission is through two pairs of gears, in the low speed and reverse, and direct on the high, and in the direct drive the gears, though always in mesh, are disconnected

loose on *B* itself is another gear 24. These gears are in permanent mesh with pinions 22 and 23 on shaft *D*, by which they are driven; and either gear may be locked to shaft *B* by the pin clutch 20, sliding on keys on *B*. These two pairs of gears give the reverse and slow forward speeds respectively, shaft *D* being driven by gear 21 and

loose pinion 9, which is connected to or disconnected from shaft A by clutch 10. When therefore clutches 10 and 20 are released, the gears will turn, if at all, only from the friction of their hub bearings. It is evident that clutches 10 and 16 cannot both be engaged together.

The character of the friction clutches themselves is interesting. They are practically multiple disc clutches, shaft A being formed hexagonally inside of them, and the drums 10 and 16 having internal lobes. Eleven hardened steel discs, with central hexagonal holes, are strung on A for each clutch, and twelve bronze discs, each locking into the drum lobes and cut out at the centre large enough to clear the shaft, are interposed between the steel discs. The discs run in oil, and are squeezed by the clutch dogs between heavy end plates. They slip at first, till the oil squeezes out, when a small pressure suffices to set them. Owing to the large surface, low specific pressure, and ample lubrication, the clutch is said to be practically indestructible. As it takes hold very gradually, it permits starting in the direct drive if desired.

Plain bearings are used throughout the car. Steering is by reversible worm and segment adjustable for wear, and the steering pivots are placed as close as possible to the center plane of the wheels. The front axle is a solid drop forging of the Lemoine type.

Lubrication is effected by a pressure lubricator, with sight feeds on the dash, a force pump puts the oil from 20 to 60 pounds pressure, as desired, and the oil is forced through separate check-valves before entering the cylinders and bearings, which check-valves require a pressure of 15 pounds to the square inch to open them. Consequently there is no chance for an oil-pipe to go dry or to fail to feed so long as oil is passing through the sight feeds. The oil is carried in a 4-gallon tank.

The engine is cooled by a honey-combed radiator and centrifugal pump, aided by a large fan. The throttle is controlled by a hand-lever working on a quadrant on the steering column and supplemented by an accelerator pedal.

The standard body construction is bent wood, and the tonneau comfortably seats five persons.

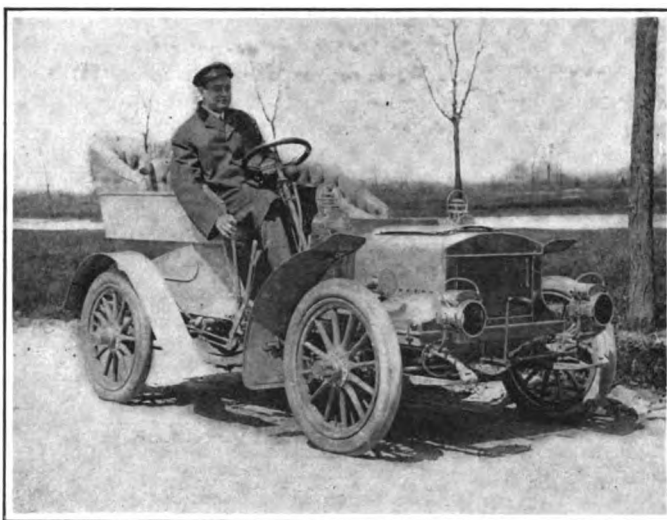

WOLVERINE LIGHT TOURING CAR MADE IN DETROIT.

One of the attractive cars of the year is the Wolverine, the product of the Reid Manufacturing Company of Detroit. It has a cellular radiator and roomy detachable tonneau. The photograph here reproduced shows one of the first of the new Wolverine cars delivered to the Chicago agent, M. K. Frank, who is shown at the wheel. The car has bevel gear drive and sliding gear transmission, with three speeds forward.

Fig. 1 shows the "Pullman Limousine" body, also built to carry seven in all.

Automobile Trestle-Jack.

In the French automobile section at the World's Fair is a trestle-jack for raising motor cars, which is convenient, powerful, and steady. It takes the place of a pit, but is much cheaper and is more useful as it is portable. The apparatus can be used in the shop or taken to cars in distress on the road.

Demonstrations are given daily at the Fair in the setting up of this movable appa-

ratus. As is seen in the illustration, the movable cross-bar drops down as well as the two screw-headed rods inserted therein at their upper ends. One end of the rope is passed over the two cross-bars and tied to the S-shaped fastening, hooked to the connecting pieces or to the spring handles. Then the end of the rope is passed through the iron ring, pulled tight and made into a knot so as to form a slip. The car is raised by turning the hand wheels. The trestle thus erected is very steady, although it appears slender, so light is its construction.

The motor car can be raised to any desired height by turning the hand wheels in an upward direction. These wheels need no brake, as it requires force to turn them downwards as well as to raise the car. The whole car can be raised bodily, if desired, by means of two such trestles, one in front and one in the rear.

ST. LOUIS CLUB GROWING FAST.

Special Correspondence.

ST. LOUIS, Sept. 5.—The recent auto events in St. Louis have given new impetus to the pastime here. The membership of the St. Louis Automobile Club has been doubled within the last four months, and now numbers 138. New enrollments include such names as Mayor Rolla Wells, W. D. Simmons, A. H. Handlan, Captain R. McCulloch, W. W. Gardener, J. W. Bemis, L. G. Kurtzborn and F. H. Britton. The Board of Governors of the club is completing plans for a new clubhouse to be erected on the Clayton road, about four miles farther out than the present structure. A lawn party will be given at the present headquarters Tuesday of next week.

The Connecticut Highway Commissioner has awarded the contract for the construction of 2,984 linear feet of macadam roadway in Waterford, the contract price being \$1.90 a foot.

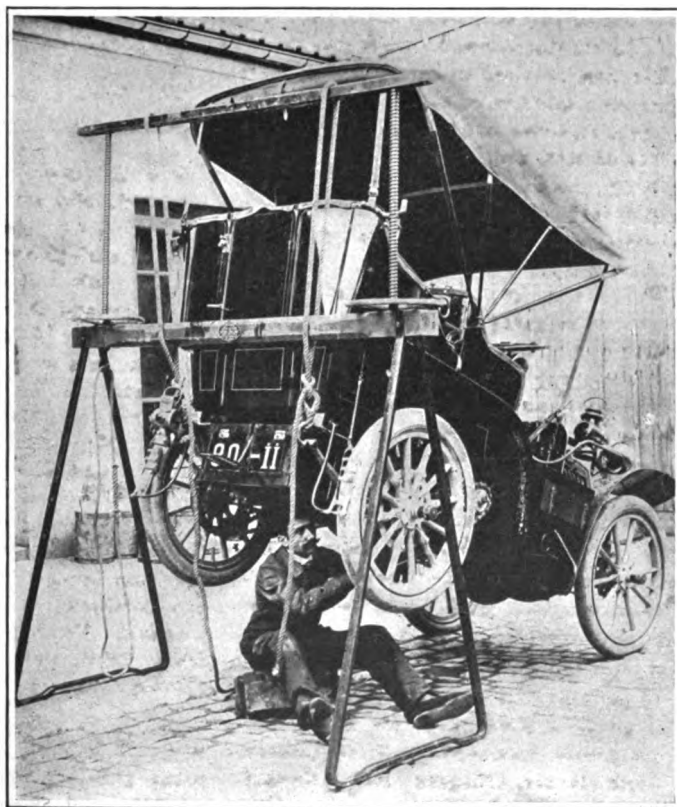

FRENCH TRESTLE-JACK EXHIBITED AT THE WORLD'S FAIR.

Correspondence

Meeting Horses on the Road.

Editor THE AUTOMOBILE.

Sir:—Referring to the letter of "Dejected Despondent" in the issue of September 3, I really believe he has dwelt upon the trouble so much that it has become magnified far beyond its real importance. For his benefit, however, I would like to make a few suggestions to him with your permission about driving on the same roads with horses.

When you are about to pass horses, one method is to drive the car as far as possible to one side of the road, put the brakes on and then stop the motor. Be careful when about to stop in the manner described that you do not run the car into a hole or into mud or soft sand. If the horse, or horses, refuse to go by after the motor is stopped, the next thing to do is to turn the horse or team around, facing away from the car. The car should now be started and driven past at a smart pace—on the high gear preferably. If your car has a muffler cutout, it should not be opened. Neither should the engine be raced. Should the horse get badly frightened and start to run away just as you pass, the best thing to do is to drive as fast as possible until you overtake and finally pass him. When you have passed keep the car in the middle of the road and slow down gradually. The horse or team seeing or hearing the machine in front will slow down also, and stop when the car stops. When the car has come to a standstill stop the motor and take hold of the horse's bridle, at the same time patting his neck and speaking gently to him.

On a wide road a good way to pass horses is to drive as close as possible to the side of the road, and pass at a good speed—not slowly. If you drive past slowly the machine will usually make more noise and the horse will have more time to get frightened than if you drive by quickly.

Try to make as little noise as possible when passing restless horses. In order to do this the motor will have to be handled carefully, and not allowed to race, or explode in the muffler or inlet pipes.

Should you encounter horses on a hill which you are descending, open the ignition switch, stop the motor and allow your machine to coast by.

One of the most dangerous places to meet a horse is on a narrow road which has no fences, and which is built higher than the surrounding ground. If you meet a horse on such a road, and the horse gets frightened, stop your motor and turn the horse's head away from the machine. While one person holds the horse, the car should be pushed by until it is at a safe distance.

If you meet a horse or team on a road which has a steep bank on one side, and a fence or other protection on the opposite side, the safest plan is to stop the car and

have the horse or team driven to the side on which the fence is. Then drive the car by on the bank or dangerous side.

When approaching restive horses it is best to drive to one side while at a considerable distance away from the team of horses, say 100 yards.

Horses as a rule are often frightened by the reflection of the sun's rays from the polished brass work, such as lamps on the front of the car. It would be well, therefore, to take the lamps off before going out with the car in the day time, especially if the sun is shining.

J. S. H.
Philadelphia, Pa.

Places for Honest Chauffeurs.

Editor THE AUTOMOBILE.

Sir:—Are there places for honest chauffeurs? What are the wages? How long does it take to secure the necessary training? I should like to become a chauffeur, and can furnish the recommendations. Please give me the names of some places where I can learn. Will thank you to answer the foregoing questions, and any other information will be greatly appreciated.

H. O. F.
Saco, Me.

There are places for honest chauffeurs. As a rule, however, chauffeurs are not dishonest, and if you have no other qualification except honesty you will have considerable trouble in finding a place.

Regarding wages, this depends upon the chauffeur's experience, also on the make and size of the car he drives. The rates of pay range from \$18 to \$60 a week. Chauffeurs who receive the last-named amount usually have one or two men under them, and, as a rule, do not themselves do much driving.

The time required to learn would depend upon one's aptitude, on the opportunities for running, repairing and adjusting the various makes of cars, and on previous mechanical training. No fixed time can be given, but a man should be able to handle an ordinary American touring car after a month or six weeks' training.

The places to learn to operate and care for machines are garages in the large cities or towns, or the factories where the cars are made, and unless you are a machinist you will probably have to work for small wages during your apprenticeship.

Touring in Canada Made Easy.

Editor THE AUTOMOBILE.

Sir:—As many American automobilists desire to tour through the beautiful province of Ontario, Canada, I would like you to inform your readers that automobile tourists can enter Canada by making a cash deposit of 5 per cent of the value of the machine, and giving a bond of 50 per cent, which latter can be furnished by N. B. Colcock, Custom House, Niagara Falls, Canada. This will enable the tourists to enter Canada and return at any point without delay

or trouble. The cash deposit will be returned and the bond canceled when the machine returns to the United States.

F. W. G.

Niagara Falls, Can.

Soft Solder Repair of Cracked Cylinder.

Editor THE AUTOMOBILE.

Sir:—This is the story of the mending of a cracked water jacket. As usual, freezing of the circulating water was the cause, and a crack three inches long developed at the bottom of the valve chamber. As the car was in constant use, it was decided to make a hurried repair in the best way that could be thought of and leave the task of making a permanent repair till a later day. The crack was scraped perfectly clean all over, the casting heated and soft solder flowed into the crack.

The interesting part of it is that this job was done three years ago, and the crack has never given any trouble. The "permanent" repair was never made, and the "temporary" one promises to last indefinitely.

E. N. B.
Buffalo, N. Y.

Half Size Motor.

Editor THE AUTOMOBILE.

Sir:—Will you please tell me if I could make a motor that would work properly if I made everything just one half size? I have the drawings of a two-cycle gasoline motor, with a four-inch bore and stroke, and would like to know if I could make it two-inch bore and stroke, and also reduce the inlet and exhaust parts, size of crank shaft, connecting rods and the like one half size, would the motor work properly?

H. B. E.

Chicago, Ill.

No. Such a motor would be worthless even as a toy.

G. F. Heublein, a well-known resident of Hartford, who returned a week ago after completing a 3,000-mile tour of Europe, has ordered a 28-36-horsepower English Daimler car with which he will tour abroad next year and then bring home with him to Hartford. The car will carry seven persons, having a sort of a double tonneau with side entrance. It will have a glass front and back, and canopy top. During the past summer Mr. Heublein and his party toured with the Ladies' Automobile Club of London to Rotterdam, Cologne and Hamburg. They spent three weeks traveling through England, Germany and Holland. Mr. Heublein brought back with him a special automobilist's coat which he purchased in England. The upper part is of rubber and fits so tightly about the neck and arms that no rain can enter.

Forty-four counties in Pennsylvania have made application for State aid for good roads, and the Highway Commissioner has awarded contracts for sixty-seven miles of road.

Patents

Crankpin Lubrication.

No. 767,877.—W. R. Fleming, of Harrisburg, Pa.

A crank web on which the oil working out from or dripping down on the crank end of the shaft bearing is carried by centrifugal force out to a circular groove 19, and thence through oil hole 20 to oil chamber 17, reaching the crankpin at 21.

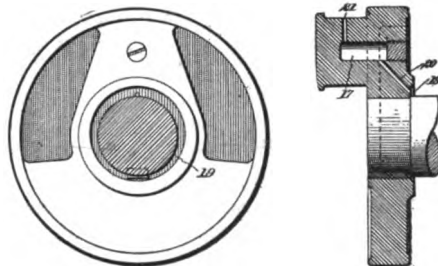

FLEMING CRANKPIN LUBRICATION.

Transmission Mechanism.

No. 768,636.—E. Thomson, of Swampscott, and H. Lemp, of Lynn, Mass.

A reachless running gear in which the rear axle has the driving gears—worm gears

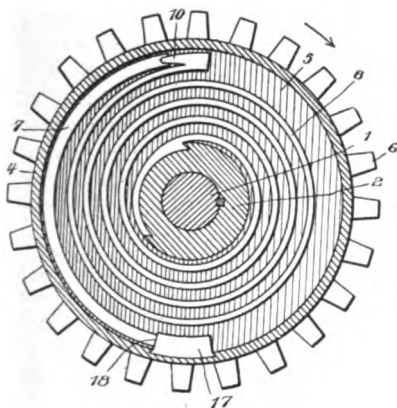

NELSON SPRING SPROCKET.

in the drawings—rigidly incased with it, and the propeller shaft incased within a tube 70 rigid with the axle casing. But one cardan joint is therefore used, this being indicated at 14.

Spring Transmission.

No. 768,883.—P. N. Nelson, of Galesville, Wis.

The sprocket 6, which is to drive the

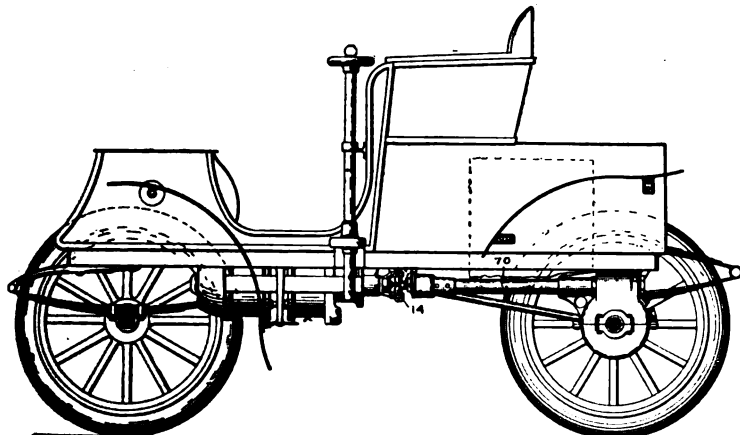

THOMSON TRANSMISSION MECHANISM.

shaft on axle 1, is secured to web 5, which is loose on the hub 2. The rim 4 is connected, not to 5, but to 2, by means of another web cut away in the section. Parts 2

and 4 are therefore the driven members. Rigidly secured to 5 is a semicircular flange 7, one end of which is notched to hold the end 10 of a coiled spring 8, whose inner

end is secured to 2 as seen. The normal drive being clockwise, the spring will be "wound up" till its outer end strikes a stop 17 in rim 4, when a positive drive is produced. On reversing, the end 18 of 7 engages 17, giving positive drive again.

Motor and Gear Box Support

No. 768,862.—R. L. Morgan, of Worcester, Mass.

A casing by which the motor crankcase, the gear box, and the housings and bearings of the cross countershaft are all cast or rigidly bolted together. The structure is supported at points 18, 21, and 22, giving full liberty of movement to the main frame without cramping the shaft bearings.

Contact Spark Igniter.

No. 768,687.—L. J. Phelps, of Stoneham, Mass.

An igniter having an unusual arrangement of parts. A reciprocating stem 21, guided in a bushing 22, which passes through the water jacket, makes contact with the insulated electrode 20, a plug large enough to be rotated to present a fresh contact surface when desired. The stem is actuated by a vertically reciprocating push rod 24, worked by

allows 24 to rise a little after contact is made, thereby applying pressure at the contact. The normal rotation of the cam is clockwise, and 24 is guided at its head by 21, and below by a sliding bar 40, whose face next to 24 is beveled so that the lower end of 24 may be shifted in the plane of the paper, to advance or retard the spark. The space 26 is provided so that 24 can yield to backward rotation of the cam, when lug 41 prevents it from dropping out of place.

Steering Device and Compensating Gear.

No. 766,191.—J. W. Moakler, of New York.

In this invention the rear wheels are connected with the central driving gear on

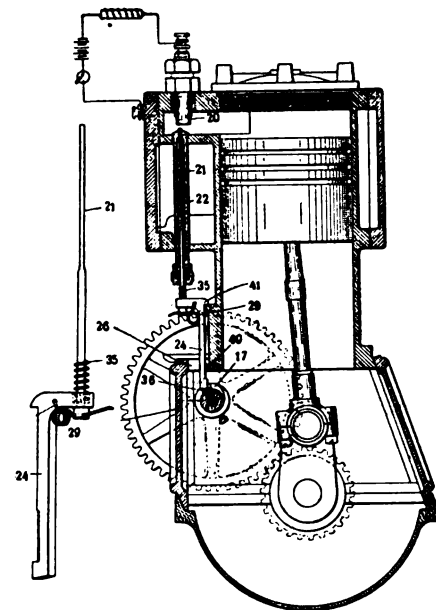

PHELPS CONTACT SPARK IGNITER.

the rear axle by separate conical friction clutches, which are connected to the steering gear in such a manner that the inner wheel on a curve is unclutched from the driving gear by deflecting the steering

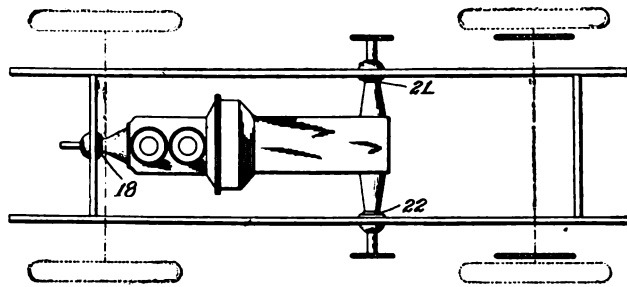

MORGAN THREE-POINT MOTOR AND GEAR BOX SUPPORT.

a snap cam 17. Spring 35 holds 24 against the cam. The lower end of 21 passes loosely through the offset head of 24, and is connected thereon by the coil spring 29, which

mechanism. A further movement of the steering mechanism is made to apply a brake to the inner rear wheel, which is supposed to assist the steering process.



VOL. XI.

No. 11

Published every Saturday by

THE CLASS JOURNAL CO.,

Flatiron Building, Madison Square,
NEW YORK CITY.Cable Address - - - Autoland, New York
Long Distance Telephone - 300 Gramercy, New York

SUBSCRIPTION RATES:

United States, Canada and Mexico, - One Year, \$2.00
Other Countries in Postal Union, - One Year, \$3.00To Subscribers—Do not send money by ordinary mail.
Remit by Draft, Post-Office or Express Money Order,
or Register your letter.

FOREIGN SUBSCRIPTION AGENTS:

ENGLAND:—Iliffe & Sons, Limited, 3 St. Bride Street,
Ludgate Circus, London, E. C.FRANCE:—Boyveau & Chevillet, 22 Rue de la Banque,
Paris.

GERMANY:—A. Seydel, Mohrenstrasse 9, Berlin.

To Advertisers—Copy or changes in orders for ad-
vertisements should reach us not later than 5 o'clock p. m.
Monday for the issue of Saturday following.

Copyright, 1904, by The Class Journal Company.

Entered at New York, N. Y., as second-class matter.

The Automobile is a consolidation of The Automobile
(monthly) and the Motor Review (weekly).

Copies Printed This Issue, - - 12,000

" " Since Jan. 1, - 445,800

**Vanderbilt
Race a
Precedent.**

There are more than merely temporary reasons for wishing that the Vanderbilt Cup race may be successfully carried through. If it is well managed, and passes off without casualty, it is certain to stimulate marked interest in road racing in other parts of the country. To the general public this might not seem much of a reason for wishing success to the impending race, for the general public regards all road racing with a large measure of distrust. It is increasingly apparent, however, that a legitimate outlet must be found for the record-making ambitions of individuals who, owning machines possibly no faster than a reasonable man might desire, insist on giving public demonstrations of what they can do.

When such demonstrations take the form of attacks on the time records between one city and another, and when every pair of cities of importance has one or several persons plotting violence to the local record, the nuisance is evidently a serious one, demanding remedy. If it were possible to suppress unsanctioned cross-country speeding altogether it would be highly desirable to do so; but that would be practically impossible, though flagrant instances could and should be severely dealt with.

On the other hand, it is to be considered that a series of road races, duly sanctioned

and properly safeguarded, would deprive manufacturers and others of all excuse for the irregular speeding now so common. A few annual events, distributed throughout the country, would make it as disreputable to evade the laws for the purpose of getting a record as it now is to hunt game or fish out of season, and for the same reason—that a proper time and place was provided. The desire for road records is in itself reasonable enough, since track racing is notoriously worthless as a demonstration of serviceability, and endurance runs at slow speed seem nearly to have outlived their usefulness.

Obviously road races, to be at once beneficial to the industry and harmless to the public, should be restricted in some manner to prevent the development of a breed of road racing machines which, after one or two races, may be turned loose on the public in possibly unskilled hands. This may be done by the racing authorities establishing various limitations on weight and power, or, better still, by the proper enforcement of existing speed laws.

**Automobile
Club
Activities.**

Now that the summer is over, the revival of club activities suggests consideration of ways in which popular interest may be increased and the usefulness of the clubs enlarged. Although the objects of the average club are mainly social, there are many men who will gladly devote a little time to "the cause" if they see openings for effective work, and there are few localities where a small expenditure of effort in the right direction will not bring useful results.

The most valuable work that can ordinarily be undertaken by a club is the collecting of systematic information about the roads in its territory. The average tourist sees a road once, twice, or thrice in a year, and sees it under a particular set of weather conditions. There are not many tourists sufficiently informed about road construction to be able to tell from once passing over a road what its condition will be in different sorts of weather; but a number of tourists, by comparing notes, can get a very good idea of the character of that road. Such information could be published in pamphlet form, or blue printed with maps, and local items regarding hotels and garages added. A number of clubs, say in one State, could exchange information of this sort to the benefit of all.

Experience nights are among the most useful and entertaining in the club's calendar; and clubs of sufficient size can supplement them with informal addresses by technical men from agencies and factories not too far away, each man describing—with lantern slides if possible, or with detached parts, or a sample car—some particular machine. This was done very successfully by the Long Island Automobile

Club last winter. Open house, of course, should be observed on these nights.

Clubs in the larger cities might establish a better *entente* between user and dealer or garage keeper by inviting some of the latter to address them on their side of the perennial argument; and the difficult chauffeur problem would be helped toward a solution if the garage keepers were able to say publicly what they considered necessary to prevent abuses.

A final suggestion—bold, perhaps, but worth thinking about—is to invite some of the leading horsemen of the locality to state their experiences with motorists and their views as to the basis for amity. A state of war is not usually, in this particular province, the best preparation for a satisfactory peace, because the motorists are but a handful of the population. Neither is the right all on one side, and a mutual understanding will in any dispute work wonders toward evolving concord.

The reproach of chronic paralysis and indifference, so often brought against the clubs, needs only a little active work, intelligently directed, to avert it. Every automobile club ought to be and can be a strong center of public influence in its locality.

**Interdependence
In
Business.**

Business is not so much of a "battle" as is sometimes imagined, and the notion that every man's hand is against every other man is often ridiculously delusive. Each well-formed enterprise is an organization for grasping details and combining forces. There is, however, always room for personality and individuality, and the man or concern which proceeds along the line "there is room enough for all" wins out, while the one who holds back for fear of stepping on the toes of someone else or having his own toes stepped on falls back in the race.

The interests of the automobile industry are closely related to numerous lines of commerce and trade, and they are mutually dependent upon each other. A dullness or depression anywhere on the commercial horizon is certain not only to affect the sum-total of automobile sales, but any decided setback in this industry would help materially to bring about business depression, especially in cities like Detroit, Cleveland and Hartford, where so many mechanics and others are employed at good wages. One thing is frequently lost sight of by agents: the people who sell vehicles, tires or sundries to you are just as anxious to make satisfactory use of your money as you are. They want you to make money because that means more business of the right sort for them. Enterprise thrives on its like, not upon its opposite; this is the fundamental principle upon which substantial business is built up.

The individual agent is not an absolutely

independent person, or the manufacturing industry a mere aggregation of producers. Any great trade is essentially a unity. True, it is made up of what may at first sight appear to be heterogeneous elements; but these are so systemized and adjusted as to become in reality an integer. The tie that binds all of them together is the final uniformity of their effort—the fact that all are working along somewhat parallel lines. The industry is the sum-total of what they do, and each one is of importance to it in proportion as his work contributes to the final results of the associated efforts.

Every thoughtful manufacturer knows—though he may not always acknowledge the fact—that his welfare is bound up with that of his agents. Any prosperity that comes to him at the expense of the man who carry his product to the public could be, at least, but temporary. The contrary is equally true. Although the two wings of the automobile trade—making and selling—are apparently separate, there is an inevitable responsibility between them. They go their separate ways, have different ideas, plans and methods. Yet they pursue the same objects—happily with due regard for the foibles and failings of each other. It is not enough that one party should map out a line that promises a successful issue for himself. He must take care that it proves no stumbling-block to his coadjutor.

Progressive evolution dominates business nowadays. The law of industrial evolution allows that enterprise to survive which is best adapted to meet the conditions of growth. Whenever, therefore, an individual finds himself losing sight of his relation and responsibility to the industry of which he is a part, it is time to consider that he is not a lone whirligig, but merely a cog with an incidental place in the whole machinery. His enterprise is apparently separated, but in reality connected with all others in the same sphere of effort. Upon the conduct of his own affairs hang results vital to the whole trade, and calculated to have a part in shaping the conditions of the future.



"Who is the rainmaker?" is the question that is asked in Detroit. "Ned" Broadwell declines the honor of the title since the recent race meet promoted and managed by him was the first ever held in Detroit that did not have to be postponed on account of rain. He thinks the title belongs to "Billy" Metzger or "Bert" Whitney, his former associates in race meet promotion.



Cows are wholly unconcerned about automobiles that pass them as they graze along the roadside, but not so the bulls and steers. Many accounts of recent encounters between automobiles and males of the bovine family indicate that a man sometimes unconsciously makes a bull by not steering clear of the steers.

AUTO INDUSTRY STATISTICS WANTED.

Census Bureau Preparing to Send Out to Manufacturers Blanks for Information for First Government Five-Year Census Report—Returns Confidential.

Special Correspondence.

WASHINGTON, Sept. 5.—The automobile manufacturers of the country will receive from the United States Census Bureau within the next few weeks schedules of inquiries which they are expected to fill out and return to the Bureau. This will be the first preliminary to taking the first quinquennial census ever attempted by the Government. Congress was induced to provide for this five-year census on the ground that the development of the manufacturing resources of the country demanded more accurate and more recent statistical information regarding the leading industries.

The schedule that will be sent out to the automobile manufacturers includes returns covering character of organization, date when present organization commenced operations, capital invested, number of proprietors and firm members, salaried employees, wage earners, including piece workers, miscellaneous expenses, materials used, value of products, power employed, and various other items. Much valuable information regarding the automobile industry will thus be obtained.

With every schedule is given the pledge of the Census Bureau that all answers will be held absolutely confidential. No publication will be made of the census reports disclosing the names or operations of individual establishments, the information being used only for the statistical purposes for which it is given. Manufacturers may answer fully the list of inquiries with the assurance that nothing will be divulged.

OBJECT TO HEADLIGHTS.

Philadelphia Horse Drivers Divided on Subject of the Dazzling Light.

Special Correspondence.

PHILADELPHIA, Sept. 5.—Some local horsemen are complaining that the brilliant lights carried at night by many automobiles have a tendency to frighten horses and dazzle their drivers, and that something should be done to prohibit their use. Other drivers, whose opinion is equally to be relied upon, aver that while this may be true in a few cases, the compensating advantages of big lights greatly outweigh their disadvantages. Especially is this the case, they say, when a motor vehicle approaches a horse-driven vehicle from behind. Horse-drawn vehicles never carry rear lights, and the driver of a fast-moving automobile passing along a tree-lined road on a dark night would have difficulty in seeing any object ahead were it not for the headlights, and the more powerful these are, the greater the possibility of avoiding accident.

A case in point was the occurrence a fortnight ago of just such an accident. A touring car, returning from Atlantic City after dark, was provided with a pair of ordinary side lamps; there was no moonlight, and at a particularly dark section of the road the motor car, which was not running in excess of the speed limit, dashed into the rear of a carriage occupied by a young couple. The latter could not be seen by the driver of the automobile until he was almost upon it, and the result was a smashed carriage and slight injuries to its occupants. With a powerful headlight such as is carried on many auto-

mobiles such an accident would have been impossible, for the carriage could have been seen 200 yards away, giving ample time to avoid a mishap. On park and country roads such lights seem to be necessary, and unless horse-drawn vehicles are compelled to carry rear lights, as is the case with automobiles, their drivers are in a measure responsible for rear-end collisions.

SHOW MATTERS CONSIDERED.

N. A. A. M. Hears Recommendations and Grants Boston Sanction.

A mass meeting of the executive committee of the National Association of Automobile Manufacturers, Incorporated, was held at the association's offices, at 7 East 42d St., New York, on September 7, fourteen members being present. A report was received from the show committee regarding a conference held with Messrs. Raymond, Post and Gorton of the Motor and Accessories Manufacturers, concerning the allotment of space at the national shows, it being recommended that 10,000 feet be given to the exhibitors of parts and accessories. While this space will be taken by the Motor and Accessories Manufacturers, provision is to be made for the accommodation of all manufacturing members of the N. A. A. M. Other exhibitors of parts and accessories will be located in the upper boxes. It was reported that a resolution supporting the action of the N. A. A. M. regarding sanctioning local shows was adopted by the Board of Directors of the Motor and Accessories Manufacturers by a unanimous vote.

Regulations governing the apportioning of space at the Madison Square Garden show were adopted, subject to the approval of the Automobile Club of America and the Madison Square Garden Company.

The Boston Automobile Dealers' Association was granted a sanction for a show, to be held in March, 1905, subject to the approval of the show committee on space rates. All other local show sanction matters were referred to the show committee with power to take any necessary action.

The October meeting of the N. A. A. M. executive committee will be held on October 7, the day before the date of the Vanderbilt Cup race.

TANK FILLING DEVICE.

A device for filling tanks located under the seats of automobiles, which is ingenious and extremely simple, has been brought out by an English concern. It consists of a sort of funnel permanently attached to the dashboard at a height slightly above the top of the tank. A pipe from the bottom of the funnel passes under the footboards and enters the tank at the bottom. Fluid poured into the funnel will run through the pipe into the tank until it is filled. Just below the funnel is a gauge which shows at a glance the height of the fluid in the tank. The funnel is provided with a strainer and is closed by a lid on the top. There is a cock at the lowest point in the pipe for draining off the contents of the tank if necessary. Provision for releasing the air confined in the tank as the fresh fluid enters may be made by a very small pipe concealed within the larger one. The object of the device is, of course, to obviate the need of lifting the seat cushion and a seat panel, increasing the cap and perhaps inserting a pencil.

Dr. Bossart is the proud possessor of the first automobile owned by a resident of Buckley, Ill.

WORCESTER RACE MEET.

Interesting Events at Agricultural Fair Conducted by Horse Race Officials.

Special Correspondence.

WORCESTER, MASS., Sept. 6.—A series of automobile races was held yesterday—Labor Day—on the Greendale trotting track, under the joint management of the Worcester A. C. and the New England Fair committee. In arranging for these automobile races in connection with an agricultural and horse fair the committee on horses of the Worcester Society made one of the first moves toward bringing to an end the feeling of antagonism that has held sway between the horsemen and the motorists. A few similar opportunities of getting together on the same footing in different sections of the country will open the eyes of both sides to the fact that farmers and horsemen as well as automobilists want good roads, and lots of them, and that neither party desires to restrict or usurp the rights of the other in their use.

The races were well handled by the judges, timers and starters that were to officiate in the horse racing later in the day. The half-mile track was in as perfect condition as it is possible to make a horse track, and to this fact no doubt is due the fast times made. Louis S. Ross drove five miles in a steam car on a half-mile track in 7:43 1-2. Ross holds the world's record of 55 2-5 seconds for one-mile straightaway, made at Ormond last winter.

The special three-mile race was sufficiently exciting to suit the grand stand, but when in the third mile Ross' outside rear tire came half-way off on one of the turns, the suspense was at top pitch, but the tire stayed on to the finish, and Ross won the race, although a section of the inner tube got free just after crossing the tape and suddenly assumed the shape and size of a football, presenting a ludicrous sight as the wheel revolved.

The summaries follow:

Three-mile race for gasoline cars weighing 551 to 881 pounds.—Fred S. Wilder, Pope-Tribune, 1st; Edwin Entwistle, Oldsmobile, 2d; Asa Goddard, Oldsmobile, 3d. Time, 7:57 3-4.

Five-mile race for gasoline cars weighing 881 to 1,432 pounds.—Melvin Dixon, in John S. Harrington's Stevens-Duryea, 1st; A. J. Seaton, Buckmobile, 2d. Time, 10:54 1-2.

Five-mile free-for-all.—Louis S. Ross, Stanley, 1st; Fred Marriot, Stanley, 2d; Melvin Dixon, Stevens-Duryea, 3d. Time, 7:43 1-2.

Obstacle race.—Asa Goddard, Oldsmobile, 1st; John S. Harrington, Stevens-Duryea, 2d. Time, Goddard, 1:06 1-4, Harrington 1:13 1-4.

Three-mile race for steam cars under 1,432 pounds.—Louis B. Ross, Stanley, 1st; N. F. Baldwin, Stanley, 2d; Fred Marriot, Stanley, 3d. Time, 4:34 3-4.

FALL MEETS FOR PHILADELPHIA.

Special Correspondence.

PHILADELPHIA, Sept. 5.—The proprietor of the Point Breeze track is trying to secure the co-operation of the Automobile Club of Philadelphia in the promotion of a race meet, to be run Sept. 24. Application for a sanction for that date has been made by him, but as a meet is scheduled for that date at the Empire City track, New York, it is probable that the date will have to be changed.

On the following Saturday, Oct. 1, the automobile club will pull off its second an-

nual cross-country run, so if the Point Breeze management hopes for the co-operation of the club he will be compelled to select a date in October.

The newly organized Motor Power Association of Philadelphia, which contemplates running a meet this fall, had selected Sept. 28, but could not secure that date, and it is just possible that the new organization may select Oct. 1. President George Banker favors Oct. 1, and says that much of the preliminary work of the meet has already been done.

POOR SPORT IN WASHINGTON.

Big Crowd Cheers Walkovers of a Short Program and Overruns Track.

Special Correspondence.

WASHINGTON, D. C., Sept. 5.—Bennings race track was the scene this afternoon of probably the poorest automobile racing that has been seen anywhere this year. About 10,000 spectators were attracted to the track under the belief that the Central Labor Union, promoter of the races, would provide them with some fairly good sport. No one looked for any records to go by the board, but those who paid to see sport of the character provided certainly should have it back. The management left much to be desired. There were officials a-plenty, but no one seemed to be in authority, and spectators swarmed on the track in hundreds totally oblivious of the fact that they were in constant danger. It was rare good fortune that no accidents happened.

The program as originally framed consisted of eight events, but numerous scratches brought the number down to five. There was not an event that was not won in hollow style, the second man in each event finishing many yards behind the winner. Notwithstanding this fact the crowd was enthusiastic and cheered the winners to the echo, showing that the Capital City is hungry for sport. A series of races with a few well-known drivers competing would draw well and give the game a big boost here. But there is hardly any chance that we shall have anything like that this year.

Frank Kulik, in the new Ford racer, won the first event, a five-mile race for gasoline machines weighing from 881 to 1,432 pounds. H. A. Rhine, in a 12-horsepower Haynes-Apperson, was his only competitor. Kulik finished the five miles in 8:07 3-5, while Rhine was still on his fourth mile.

E. Gruendfelt, in a 10-horsepower Ford, won the five-mile race for gasoline machines, listing at \$1,000 and less for stock cars with road equipment. He handled his car like a veteran and won a round of applause when he came under the wire a winner from Charles Tyser, in a Cadillac, while the other contestants were furlongs behind. The time was 9:12.

Two Franklin cars carried off the honors in the ten-mile free-for-all, any motive power, stock cars with road equipment. J. W. Boyd drove the winner, covering the ten miles in 17:33, and beating the other Franklin by a third of a mile.

The prizes were silver cups and were much too good for the character of the sport afforded.

An automobile parade was scheduled for the morning, but it developed into a farce, only sixteen cars, including an electric 'bus for the band, responding to the call. Assurance was given last week by more than 175 owners that they would have their machines in line for the parade, and it was a keen disappointment to those who got up the parade that so few turned out.

OLDFIELD TO CONTINUE.

Writes that He Wants to Meet Kiser, and He May Be Accommodated.

Special Correspondence.

CLEVELAND, Sept. 5.—Barney Oldfield denies that he has retired from racing. He may have "sworn off" while under the excitement of the fatal accident at St. Louis, but he has changed his mind. He said the same thing after his accident at Detroit last year. In a letter written from the Missouri Baptist Sanitarium to a friend in this city, Oldfield says that he is more anxious than ever to get a fair race with *Bullet* No. 2. He said he was going to Nashville, Tenn., on crutches to officiate in an automobile meet there on Labor Day. His injured ankle is in rather bad condition, and he probably will not be able to step on it for several weeks. He writes that when the wreck occurred at St. Louis the crowd tore the wrecked *Green Dragon* almost to pieces for souvenirs, even cutting up the aluminum bonnet and carrying it off.

So much disappointment was expressed by local racing enthusiasts over the fact that Oldfield did not remain over in Cleveland to compete against Kiser that the Cleveland Automobile Club is considering giving another race meet within the next few weeks, largely for the purpose of giving Earl Kiser and Oldfield an opportunity of fighting out their claims for the championship. Oldfield has been communicated with on the subject, and if he can get around in time, a meet will be arranged. There will probably be a series of match races at different distances for the two big drivers, with a number of other interesting events to fill up a program for one afternoon.

Special Correspondence.

ST. LOUIS, Sept. 3.—Barney Oldfield emerged from the hospital to-day, and in an interview said that he was ready to race against Kiser in the *Bullet*, and had sent a message to Judge Seidener that he would participate in the race meet in St. Louis in October. He is entered for the Nashville races Monday, and will go to Long Island for the Vanderbilt Cup race, Oct. 8. If he gets his eight-cylinder 120-horsepower Peerless car in time he will take part in the Pittsburgh races, Sept. 23 and 24.

ALBANY RACE MEET PROGRAM.

Special Correspondence.

ALBANY, Sept. 6.—Entry blanks for a race meet to be held at the Island Park track Sept. 17 have been sent out by the Albany Automobile Club, under whose auspices the meet will be held. Entries close Sept. 11. Cups aggregating a value of \$1,500 are offered for first and second prizes in the different events. The complete program is as follows:

Five-mile motorcycle race, free for all; two-mile race for steam cars; five-mile for air-cooled cars; ten-mile free-for-all, any make, weight or horsepower; five-mile handicap, for gasoline cars 881 to 1,432 pounds; five-mile handicap, gasoline cars 1,432 to 2,304 pounds; five-mile handicap, gasoline cars 551 to 881 pounds; speed trials; five-mile handicap for club championship, open only to members of Albany A. C.; runabout, 551 to 881 pounds, any motive power, club members only; machines of 881 to 1,432 pounds, any motive power, club members only; machines of 1,432 to 2,204 pounds, any motive power, club members only.

TRANSCONTINENTAL RECORD.

From Frisco to New York in Less than 33 Days.

The distinction of being the only man to have twice crossed the North American continent in an automobile may now be claimed by L. L. Whitman, who, accompanied by Charles Carris, arrived at the Automobile Club of America at 1:40 p. m. on Saturday, Sept. 3, after having made the trip from San Francisco, a distance by road of 4,500 miles, in 32 days 23 hours 20 minutes. The car used was an air-cooled Franklin of 10-horsepower. Mr. Whitman's record supersedes the record of 61 days made by Tom Fetch last year. A letter from the president of the Automobile Club of San Francisco to Winthrop E. Scarritt, president of the Automobile Club of America was carried by Mr. Whitman. Remarkably fine weather favored the tourists, and this fact is responsible in a large measure for the good time made. Practically all the running was done during the day. The machine stood the work extremely well, and mechanical troubles were few and far between. Even the ubiquitous tire "bug" took a rest, and gave the transcontinentalists but little trouble. The route took the party from San Francisco to Sacramento, Truckee, Cal.; Carson City, Battle Mountain, Nev.; Ogden, Utah; Cheyenne, Wyo.; Denver, Colo.; Omaha, Neb.; Chicago, Ill.; South Bend, Ind.; Toledo, Cleveland, O.; Erie, Pa.; Buffalo, Syracuse, Albany and New York City. The air-cooled car has certainly proved itself equal to a long, arduous journey, though many doubts were expressed before and during the journey as to its capability of accomplishing the distance.

CHICAGO DECORATED PARADE

Automobile Section Made a Leading Feature of West Side Carnival.

Special Correspondence.

CHICAGO, Sept. 5.—What was originally started as a sort of impromptu affair developed into a rather elaborate occasion when the automobile parade at the West



W. G. LLOYD'S DECORATED PEERLESS TONNEAU TOURING CAR IN CHICAGO FLORAL PARADE.

Side carnival was given last Wednesday night. Prospects for a good turnout were very poor until the assistance of the Chicago Automobile Club was enlisted. President Farson appointed a committee to arouse enthusiasm, and it was not long before entries began to come in, so that there were over a dozen decorated cars in line, and perhaps a score without decorations.

The parade was started from the clubhouse on Michigan avenue at 7:30 p. m., President Farson leading the procession. The gaily decorated and illuminated cars passed through the downtown business streets and over the river to the West Side, where the carnival was in progress. The official line of march was from Oakly avenue to West Fortieth street on Madison avenue.

First prize, a silver loving cup, was awarded to Jerome A. Ellis, who had his 40-horsepower Apperson car decorated with 150 electric lights in red, white and blue, with his initials on the bonnet in the same colors. The floral decorations were ferns

and asters with a bell made of red flowers hung over the center of the car. Second prize, a Columbia phonograph, was awarded to Carl D. Kinsey, whose Winton car was decorated with pink and white chrysanthemums and American Beauty roses. Third prize, a case of Sunnybrook whisky, was given to President Farson.

The first prize will go to the club, and President Farson has taken a week's vacation to solve the problem of how to dispose of the third prize without showing undue favoritism.

Other decorated cars were driven by C. A. Coey, Thomas flyer; John E. Fry, Apperson *Jackrabbit*; Ralph Temple, Franklin; W. G. Lloyd, Peerless; George A. Crane, Knox; Dr. W. A. Pratt, Pope-Toledo. Several other cars were decorated, but were not officially entered in the parade.

TWIN SCREW AUTO-BOAT.

Special Correspondence.

ALEXANDRIA BAY, N. Y., Sept. 3.—The new auto-boat designed and built by the Electric Launch Company of Bayonne, N. J., for W. B. Hayden, owner of the steam yacht *W. B.*, is expected here shortly. She is somewhat of a novelty, having twin screws driven by twin engines, the two sets of engines being connected so as to run in perfect unison. The motors are the Snecker, built by the Stamford Motor Company, and are four in number—two of 8-horsepower in tandem on each shaft. There is a single flywheel, mounted on a short countershaft lying thwartships between the two main shafts and connected to each by means of bronze bevel-gears of good size. Each main shaft is provided with a reverse of the sliding gear type, enclosed in a box as on a motor car.

The hull is 37 feet 6 inches over all, 38 feet 3 inches on the water line, 6 feet 6 inches beam and has a total draft of 1 foot 3 inches. The stem is straight, with a forward rake, and the stern is of the "torpedo" type. The hull is double-skin, with mahogany outside. The steering wheel is of the auto type, placed in the forward end of the cockpit. The name of the launch is *Artful Dodger*, and with her two screws and the combinations made possible by the double reversing gears she is likely to prove one.

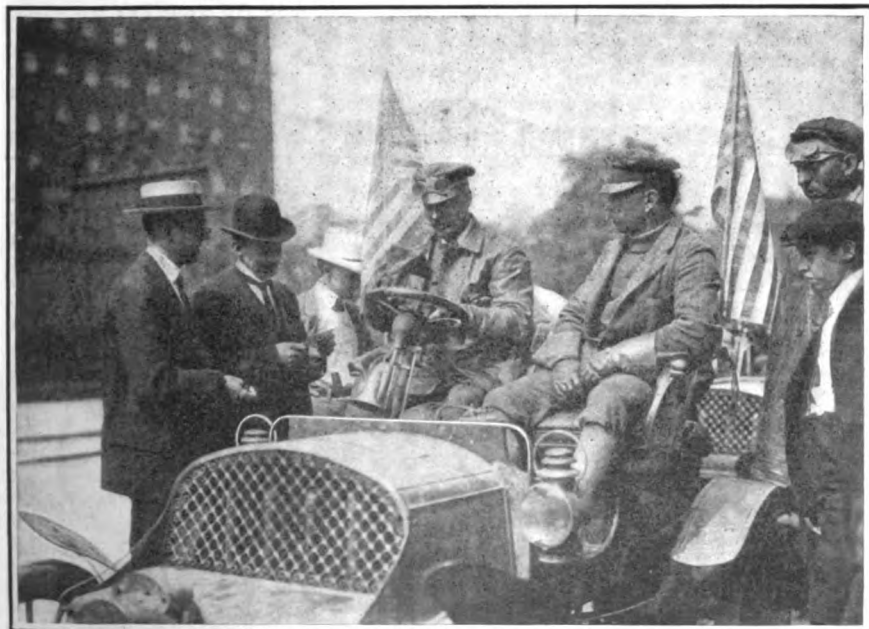

WHITMAN AND CARRIS IN FRANKLIN CAR ON ARRIVAL IN NEW YORK—PRESIDENT SCARRITT, A. C. A., READING LETTER BROUGHT FROM MAYOR OF SAN FRANCISCO.



CALIFORNIA CLUB'S PLANS.

'Frisco Good Roads Organization Getting Ready for Active Campaign.

Special Correspondence.

SAN FRANCISCO, Aug. 29.—One of the most noticeable results of the interest taken in the Del Monte meet is the increased number of applications for membership in the Automobile Club of California. This club is first of all a good roads club, and in no sense a social organization. It has no clubrooms. Its membership includes good roads enthusiasts and its strength is used in behalf of the improvement of the highways and the conditions governing their use. It is, however, the center of automobile interest in this part of the State, and to a very considerable extent of the State generally, for its influence is by no means local. Properly to further the good roads movement, a large membership is necessary, not only for the sake of the income received, but fully as much for the sake of the influence of the names on its membership rolls.

It is the intention to make a determined campaign before the coming session of the State Legislature for uniform and adequate good roads legislation. Ex-Governor James H. Budd and John D. Spreckels are the members of the Legal and Legislative Committee of the Board of Governors and they will soon formulate definite plans for the campaign.

The club is also taking an active part in the work of securing uniform legislation by the counties regarding the use of roads, speed limits and other regulations. At present there is a wide difference both in the general attitude of supervisors of different counties and in the nature of the ordinances in force. In some of the counties there is practically prohibitive legislation. While taking a determined stand against legislation of this character, as unconstitutional, the club holds to the principle that reckless driving should be legislated against and will co-operate with the authorities in securing the full observance of reasonable speed and other regulations. The Executive Committee has engaged the services of W. H. Chickering, one of the best known attorneys of the State, who will appear before Boards of Supervisors in the effort to secure uniform and reasonable legislation.

The club received a valuable impetus during the Del Monte meet with regard to its good roads campaign. In many respects the A. C. of Southern California at Los Angeles, has made more progress in the good roads fight among those who generally oppose automobiling on the public highways than the San Francisco organization. There seems to be less opposition among the farmers and among the county authorities in the southern portion of the State than in this vicinity. At the meeting of the A. C. of California, held at Hotel Del Monte on the first night of the meet, H. C. Brown, chairman of the racing committee of the A. C. of Southern California, told something of the ways in which this was brought about. He stated that his club held a number of educational runs to which officials and others who seemed to have a misunderstanding of the position taken by automobilists as a whole were invited. The members of the club also bought an automobile by subscription and presented it to the Superintendent of the

Board of Public Works, that he might learn from practical experience the sort of roads suitable for the most general travel.

Following Mr. Brown's remarks, a San Mateo county man told of his experience with the sheriff of the county, who favored a four-mile-an-hour speed limit. He invited the sheriff to a ride in his car and took him over the roads at that speed. The result was a constant appeal from the sheriff to "hit it up a bit faster." In one instance the car was run alongside of a hay wagon and as shown by the speedometer, was run at a four-mile gait. The hay wagon beat the car out. Then the sheriff was convinced.

The San Francisco club has in mind a lot of missionary work of this sort. One of the first things to be done is to convince the county authorities that San Francisco is in need of a safe driveway out of the city. With all its excellent park roads, there is not a single road leading out of the municipality that is safe even for light teams. The condition of these roads is disgraceful and it is intended at the first opportunity to point out the fact to the supervisors and members of the Board of Public Works by means of an educational run.

While the increased membership resulting from the interest taken in the meet has been gratifying, the club is still a long way from the number desired upon its rolls, and canvassing will be started immediately with a view to still further increasing the strength of the organization. Thomas Magee, Jr., and F. W. McNear are the special membership and elections committee, and they will open a systematic campaign within a few days. There is no membership fee and the dues are but \$1 a month.

DELAWARE CLUB FORMING.

The DuPonts and Other Leading Business Men of Wilmington Interested.

Special Correspondence.

WILMINGTON, Del., Sept. 5.—Local automobile owners are organizing a club. A preliminary meeting held last Thursday evening at the Wilmington Country Club, was attended by Pierre S. DuPont, Francis G. DuPont, Alfred I. DuPont, Eugene DuPont, Alfred R. Jones, Willard Jackson, William K. DuPont, John Evans, Horace W. Gause, William G. Mendinhall, Joseph Bancroft, Edgar M. Hoopes, Elmer E. Mitchell, Dr. Henry J. Stubbs, Dr. Samuel G. Rumford and Alfred A. Curtis.

Pierre S. DuPont was elected chairman of the meeting, which makes him virtually temporary president, and Alfred R. Jones was elected secretary. Committees on organization and membership were appointed, and also an executive committee, whose duty it is to draft a constitution and set of by-laws. The chairman of the several committees are as follows: Organization, Francis G. DuPont; executive, Alfred I. DuPont; membership, Willard Jackson. A meeting for permanent organization will be called when the committees are ready to report.

It is the intention to make the club a State organization if sufficient interest is manifested outside of the city. It is estimated that there are nearly fifty machines in Wilmington, and there are probably a dozen in the State outside of the city, and the desire

to own and operate machines is being fostered by the improvement of public roads, especially in the upper part of Delaware.

The organization contemplates going before City Council at its meeting next Thursday evening, when an ordinance regulating the operation of automobiles will probably be presented.

FLOURISHING NEW HAMPSHIRE CLUB.

Special Correspondence.

EXETER, N. H., Sept. 5.—The New Hampshire Automobile Club, which was organized in 1902 with five members, has now a membership of sixty, including some of the most enthusiastic motorists in New England. Its by-laws provide for the admission of non-residents of the State to membership, entitled to full club privileges, upon payment of one-half the regular initiation fee and the annual dues. The officers for the current year are: Reginald C. Stevenson, president; Arthur H. Sawyer, vice-president; Willard M. Jenkins, treasurer, and Charles G. Sheldon, secretary.

The club has leased as a clubhouse the New Boar's Head Hotel, at Hampton Beach, and has equipped it with all modern conveniences for the comfort and accommodation of its members and guests. Connected with the clubhouse in the rear is a modern garage, in charge of experienced men and thoroughly fitted for repair work and the care of machines.

The club has held no runs, but is contemplating one to Old Orchard in September to witness the races now scheduled. A 2 1-2-mile course has been laid out on the hard sandy beach near the clubhouse, where some racing is expected later in the season. The roads in this section, while somewhat hilly, are in good condition, and the scenery is beautiful. Excellent fishing can be had directly back of the clubhouse, the club owning boats for the purpose. The clubhouse will be kept open until after the opening of the gunning season, in order to give the members a chance at the birds so plentiful in this section.

The club is in a flourishing condition and promises to be one of the strongest organizations of the kind in this part of the country.

NOTES OF THE CLUBS.

WARSAW, N. Y.—On account of the continued rains, the Automobile Club of Warsaw decided to postpone for two weeks the series of races advertised for the latter part of August, and has fixed Sept. 10 as the date for the meet.

DENVER.—The Colorado Automobile Club is preparing to give a series of racing matinees during the fall, free of charge to the public. A movement is now on foot to secure the City Park track for the purpose, arranging for dates that will not interfere with the racing being held there by the Gentlemen's Driving and Riding Club.

PITTSBURG.—The Automobile Club of Pittsburg has recently dedicated its handsome new clubhouse at the corner of Baum and Beatty streets, and expects to be very active in automobile events during the fall. Its race meet scheduled to take place at Brunot's Island on Sept. 23 and 24, promises to be one of the important events of the year. The present officers of the club are W. C. Temple, president; James Francis Burke, first vice-president; W. H. Nimick, second vice-president; Edward Kneeland, third vice-president; Reuben Miller, Jr., treasurer, and W. Linford Smith, secretary.



The meeting of the Board of Governors of the American Automobile Association at the A.C.A. clubhouse on Tuesday, Sept. 6, was a protracted one, but the announcement of the work done thereat was short, though interesting. The non-stop run from New York to St. Louis and return, made by F. A. LaRoche was, it will be remembered, sanctioned by the touring committee of the A.A.A., though a sanction was refused by the racing committee. This sanction was confirmed by the Board of Governors at their Tuesday meeting, so that the run now has the full official recognition of the A.A.A. The rules and regulations governing the William K. Vanderbilt, Jr., Cup race, having been amplified and perfected in detail and couched in precise legal phraseology, were placed before the Governors by Chairman Pardington of the racing board and approved. No changes were made in the regulations, which remain, so far as their meaning is concerned, as already published in THE AUTOMOBILE of June 11. Some seventy-five individuals were admitted to membership in the A.A.A., and one club—the Detroit Motor Club. Secretary S. M. Butler of the A.C.A. was forced, through the pressure of other duties, to resign the secretaryship of the A.A.A. racing board, and his resignation was accepted by the Board of Governors.

* * *

A fine of \$50 was imposed upon L. B. Sharp, of Rockaway, L. I., when he appeared before Police Justice Tyson, of Lawrence, L. I., for sentence on Aug. 31. This is by \$30 the heaviest fine ever imposed in Lawrence for automobile speeding. The fine was paid promptly, and at the same time William Willett, Mr. Sharp's lawyer, served Justice Tyson with a quo warranto summons to appear before the attorney-general of the State on Sept. 5, when the matter of the alleged ineligibility of Mr. Tyson for the justiceship will be gone into. Mr. Willett stated that if the attorney-general believed Mr. Tyson was not qualified for his position, the latter

would doubtless resign it, failing in which proceedings against him would be instituted in the Supreme Court in the name of the attorney-general and Mr. Sharp.

* * *

At the automobile racing circuit meet at Poughkeepsie on Sept. 16 there will be no accidents attributable to dust if the management of the track can avoid it. The track, which is a one-mile oval, will be oiled early on the day of the meet, and it is further proposed to erect a protective bulwark in front of the grand stand, in case of accident to cars at that point. The track is a good one, well banked, and good racing is confidently looked for. The absence of dust on the turns and the ability of the spectators to see the cars all the time, and not merely when they emerge from obscurity into the stretches, will be quite a novelty, and should be thoroughly enjoyed.

* * *

The New York and Brooklyn fire chiefs will soon be in possession of their automobiles. Two Columbia touring cars have been ordered, one for each chief, and will be delivered within a fortnight. The cars are of the regular stock model, with four cylinder 35-horsepower motors. A large box will be placed in each tonneau for storage. The finish of the machines will be in the most approved shade of "fire department red," and the usual and much-abused horns will be replaced by fire department gongs. There should be no shilly-shallying about getting out of the way of these machines when they are on the way to a blaze. The policeman who tried to hold up one of them for speeding would probably have the time of his life.

* * *

The program of races for the automobile meet to take place at the Empire City Track, Yonkers, N. Y., on Sept. 24, includes five regular events in addition to special match races which are being arranged. There will be a 5-mile race for American touring cars with full equipment

and four passengers. The operator will be required to start his motor when the word is given, and then get into his car and start. It will be a test of agility on the part of the drivers as well as of speed of the cars. The prize for this event will be a cup called the "Old Glory" cup. The "International" cup will be offered for the winner of a 10-mile race to be run in heats of five miles and a final. There will be a heat for each nationality, and the winners of the heats will come together in the final. A 10-mile race for the "Knickerbocker" cup will be open to cars weighing from 881 pounds to 1,432 pounds. The Empire Handicap will be run again, and should bring out some good racing. For cars costing \$1,000 or less there will be the "Yonkers" cup. In this event machines must be in road-driving condition. The driver of the second car in each race will be awarded a cup, which will make the fight for second place interesting. Alfred Reeves, 390 Washington street, New York, will receive entries up to Monday, Sept. 19.

* * *

The annual hill climb up Eagle Rock, West Orange, N. J., will be held, as usual, this year on Thanksgiving Day. Secretary Gilette of the A. A. A. has not yet announced the plans for the climb. These, however, will be more extensive than heretofore, and the largest entry list in the history of the climb is expected.

* * *

M. G. Bernin has sailed for Europe, and it is reported the object of the trip is to purchase a racing car for W. G. Brokaw.

* * *

Work has been commenced on a new building for the Vehicle Equipment Co., whose plant at Flatbush, L. I., was burned down on July 5 last. The new premises include two blocks, and the plans call for a very complete plant. Work will be carried on with all possible haste, as the present temporary quarters must be vacated by Jan. 1 next.

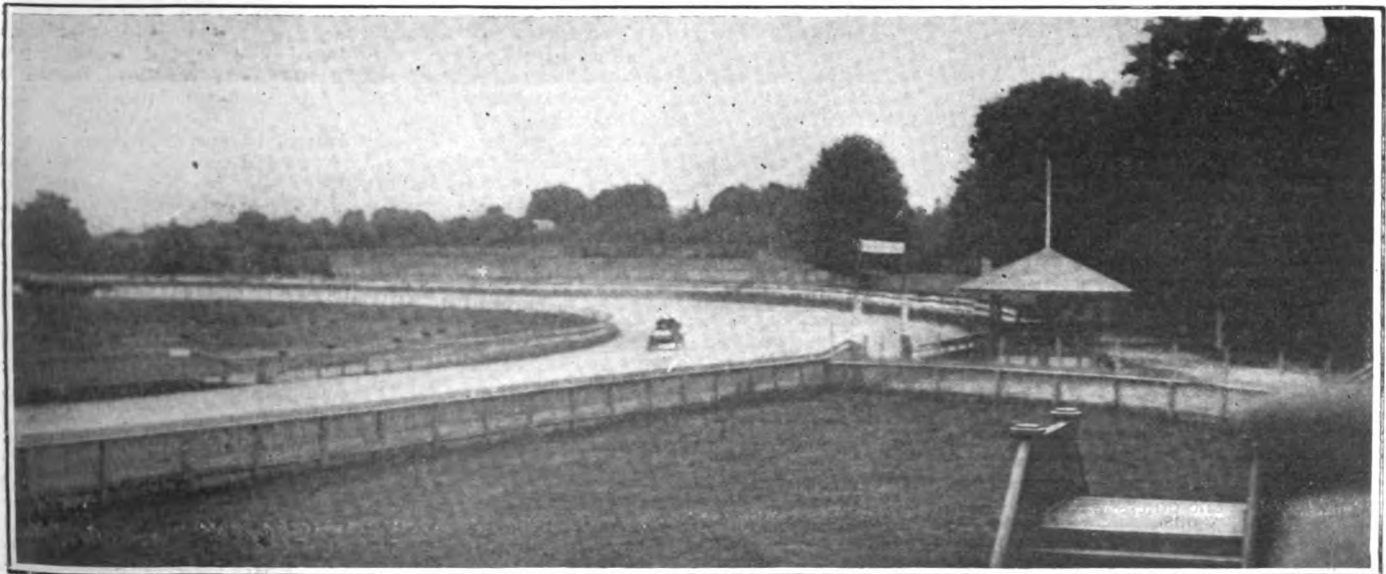

ONE OF THE TURNS IN THE POUGHKEEPSIE RACE COURSE WHERE MEET WILL BE HELD SATURDAY, SEPT. 24.

AUTO BOAT MATCH RACE IS CALLED OFF.

Visitors at Alexandria Bay Disappointed That *Standard*, *Adios* and *Vingt-et-Un II* Do Not Contest For Speed Supremacy.

Special Correspondence.

ALEXANDRIA BAY, Sept. 3.—The end of the Summer season was celebrated by three days of sports of all kinds at Alexandria Bay, including everything from a steam yacht race to war canoe and shell races, with a balloon ascension and walking the greased pole for the amusement of the landlubbers. The main efforts of the committee were centered on a bona-fide race between the *Standard*, the *Adios* and the *Vingt-et-Un II*, all three boats being in the vicinity and their owners presumably having no dearer wish than a clear course and a tank full of gasoline. Valuable cups were offered and the race was widely advertised, the combined attractions of the three days bringing several thousand spectators from all parts of the river. The small launches flocked in from all quarters every morning, many steam yachts anchored off Alexandria Bay for the three days, and excursion boats and passenger craft of all kinds were loaded with visitors from the river towns.

The program for Sept. 1 included among various miscellaneous contests races for the second-class launches, the small pleasure craft, and for the third class, the skiffs with motors.

The great event scheduled for Friday was the meeting of the three fast launches, but early in the day it became known that the *Adios* would not start, being laid up at Ogdensburg. The *Standard* was ready in the bay after some hard work on the part of her handlers, as she had signalized her arrival on the river a few days before by running on a reef and driving her intermediate shaft hanger up into the keel, bending the shaft. The wheel was uninjured, but it was necessary to dock her at Ogdensburg, repair the bottom and straighten the shaft. In launching her a bilge block was dislodged, bending one blade of her wheel and knocking a hole through her quarter-inch planking.

In spite of these troubles she was under way on Friday morning, when the news came from Round Island, a dozen miles up the river, that *Vingt-et-Un II* had just smashed the lugs off of two of her cylinders, so disabling her that she was then being loaded on a car for New York. It is for obvious reasons impossible to quote even mild samples of the comments on auto-boats and their builders and owners from the disappointed crowd. To gratify those who had never seen the *Standard*, she was run over the course from the hotel wharf around Dark Island, the picturesque island on which Commodore Bourne, of the New York Yacht Club, is building a handsome stone house. The distance by the chart is a full twenty miles, and with a good breeze up the river there was quite a sea. Steered by Ernest Serrell, and with Carl Riotte at the engine, she covered the course in 49 minutes.

During the afternoon, in spite of cloudy skies and heavy rains at times, the *Too-Easy*, the *Pappoose*, the *Radium* and the *Romo* ran three rounds of a course marked by Lewis Island below and Cherry Island above the line. The others were outclassed by *Too-Easy*, which won in 48 minutes; *Pappoose* and *Radium* made a close race, the latter hanging close to the former's quarter for several turns. The course was

covered by *Pappoose* in 50:30, *Radium* in 51:30, and *Roma* in 52:30.

On Tuesday, Wednesday and Thursday a match will take place at Ogdensburg between the *Pink*, owned by J. Wainwright, and the *Kitten*, owned by Mayor Hall, of Ogdensburg. Both are Leighton boats, identical in hulls and motors, 21 feet 10 inches overall, with 7 horsepower motors. The prize is a copper kettle, designed by Frederic Remington and made by a local blacksmith. It has not yet been exhibited to the public, but something unique is expected from the peculiar combination of artist and artificer.

A regatta for power boats is to be held on Lake Lucerne, September 10 and 12, under the joint auspices of the *Cercle des Regates de Lucerne* and *L'Auto*. On the first day the cruisers will race in two classes: the first, under 8 metres over all, with not more than 30-horsepower; the second, under 12 metres, with not more than 50-horsepower. The horsepower will be rated on the cylinder volume. On the second day the racers will come together in a "wide open" race for all boats under 12 metres long. The course will be 114 kilometers, or 71 miles, long, starting and ending at Lucerne. Challenge cups and cash prizes, the latter to the value of 4,200 francs, are offered in the three events.

RACING AT NASHVILLE.

Three Thousand Spectators Watch Labor Day Events—Oldfield Disappointed:

Special Correspondence.

NASHVILLE, TENN., Sept. 5.—The second meet of the Nashville Automobile Club was held at Cumberland Park to-day with about 3,000 persons in attendance. The event of the day was to have been a match race between Barney Oldfield and Herbert Lytle, but Oldfield was not able to enter. His new Peerless car did not arrive.

Lytle's Pope-Toledo *Tornado* was the first regular racing machine ever seen here. Lytle attempted to lower the world's record for twenty-five miles on a circular track. He was going well up to the eighth mile when his cooling apparatus failed and his engines became overheated so that he gave up the attempt. His best mile was made in 1:02.

The events for local cars were won by the Dorris brothers in their St. Louis cars. In a five-mile race these cars finished first and second in a field of four, including Oldfield, in a Peerless touring car, and a 20-horsepower Winton. St. Louis cars won first, second and third places in a three-mile race, an Oldsmobile and a White steamer finishing fourth and fifth, respectively.

Motor car racing is a comparatively new sport in Nashville, but automobiling is growing in interest rapidly here, nearly 100 cars having been purchased by Nashville men this year. The excellence of the turnpikes in Middle Tennessee makes motoring a pleasure unexcelled.

SUCCESSFUL MEET IN DENVER.

Special Correspondence.

DENVER, Sept. 2.—Postponed on account of rain last Saturday, the annual race meet of the Colorado Automobile Club was run to-day, under the best of conditions. Even the club did not expect such fast time as was made in the events. Five thousand spectators turned out to see the sport.

G. A. Maxwell, driving A. R. Wilfley's Peerless, put the one, five and ten-mile records to the bad in the challenge race between the Peerless and a Pope-Toledo.

The Peerless touring car driven by Lawrence Fipps, Jr., with a full adult load, had the fifth event, a six-mile race for touring cars, all his own way on time, but S. C. Shearer, in a Haynes-Apperson, won first prize for the most quiet and easily managed car. The Stanley *Comet*, of which the driver alone expected good things, caught fire in the first race, but succeeded in a later event in holding Fipps's Mercedes off for four miles in five and did a good mile in 1:04 1-2.

An event that created much mirth was the race between a cow pony and an auto, the pony naturally making good time with the chug-chugging motor close at his heels.

REORGANIZATION PROBABLE.

Fredonia Mfg. Co. Hopes to Take Youngstown Plant from Receiver's Hands.

Special Correspondence.

YOUNGSTOWN, O., Sept. 3.—The plant and entire business interests of the Fredonia Mfg. Co. are now in the hands of John Shaw, who has been appointed receiver and will operate the plant until final disposition of the property is made by the court. This action was taken by Judge George F. Robinson, of the Common Pleas Court, upon a petition by B. F. Wirt, executor of the estate of J. Arrel Smith, who represented that Smith, since deceased, became surety for the company on various notes, aggregating \$18,600, now due and payable. Plaintiff also alleged that the company is indebted to other creditors in considerable amounts, that it is making no efforts to discharge the debts upon which Smith is surety, that the concern is insolvent, and that the assets are insufficient to discharge its liabilities.

Following the action of the court, a member of the directorate of the company said that the financial difficulties followed the decision of the company three years ago to embark in the manufacture of automobiles. Heavy expenses were incurred in this work, and the completion of the commercially perfected runabouts was delayed from April, 1902, until the following September, when the selling season was over. The company continued to build machines, but only within the last half year had it been able, he said, to so systematize the work as to be able to build them at a profit. The principal stockholder and financial backer of the concern died about a year ago, and the executor of his estate had no authority to continue the financial support. Some time ago a plan of reorganization was perfected and agreed upon, but a threatened suit by a creditor resulted in placing the enterprise in the hands of a receiver.

The directors of the company expect to effect a reorganization in a short time and resume operations, as the Fredonia cars have gained a reputation as good vehicles, and a delivery wagon built by the company and shipped to Montreal two months ago proved so satisfactory in trial that an order for two more was given a few days later.

NEW INCORPORATIONS.

Warner Motor Co., Northampton, Mass.; capital, \$30,000; officers, D. C. Bartlett, president, and R. P. Esty, treasurer.

E. N. Heney Co., Ltd., Montreal, Can.; capital, \$200,000; to manufacture, sell and deal in automobiles and vehicles of all kinds and all apparatus and appliances in connection therewith. Incorporators, Charles R. Hosmer, Herbert S. Holt, Frederick W. Thompson, Frank Paul and Robert D. McGibbon, all of Montreal.

MISSOURI TOUR EFFECTS.

Kansas City-World's Fair Arouses Interest in Roads and Autos.

Special Correspondence.

KANSAS CITY, Sept. 3.—The A. A. A. tour across Missouri had the effect of opening the eyes of the farmers to the value of good roads and the necessity for getting them as quickly as possible. It has shown them the folly of using four horses for a load that two might haul if the roads were better. It has also instilled the desire to own automobiles in the mind of more than one Missourian who is feeling like devoting some of the money acquired in the fat years to the new sport.

The tour was one of education all the way. Thanks to effective press work, every country paper along the route heralded the approach of the tourists weeks in advance and the arrivals found the towns, almost without exception, in the temper to give a grand welcome, even neglecting business while the tourists were in town.

In one way the Missouri tour was more the event that the A. A. A. promoters wished to make than was the trip of the New York and Boston contingent. There

around the cars to study their construction showed clearly the attitude of a people that are ready to take hold of automobiling in earnest. It is only a step from being interested to being an owner of an automobile, where the money is possessed.

Not the least interesting feature of the five-days' tour was the perfect record made by E. P. Moriarty, who drove a Stevens-Duryea the entire 293 miles to St. Louis without even inflating a tire or cleaning a spark plug. Roy Sanborn was his companion. The route included the fords through streams, roads of the roughest type and one stretch of sand five miles long, through which it took four hours to travel.

Before beginning the tour from Kansas City, Mr. and Mrs. Cockerill toured from Pittsburg, Kan., a distance of 175 miles.

OCTOBER MEET FOR ST. LOUIS.

Special Correspondence.

ST. LOUIS, Sept 5.—A new club has been organized here to promote another race meet in October. It will be a big event for the American championship. There is talk of a meeting between Oldfield, A. C. Webb, Webb Jay, F. A. La Roche and Earl Kiser. These men would all drive cars of known speed and efficiency. Oldfield ex-

CONNECTICUT SUNDAY RUN.

Two Score Waterburians Drive to Sound Resort and Enjoy a Shore Dinner.

Motoring interest in Waterbury, Conn., is being stimulated this season by individual enterprise, the E. H. Towle Co., dealers in athletic and sporting goods and automobile supplies, having voluntarily assumed some of the functions of an automobile club pending the organization of such an institution. The photograph herewith reproduced shows the lineup for the start of the second all-day automobile run organized by the company this fall. The start was made shortly after 9 a. m., Sunday, Aug. 28, from in front of the company's new headquarters in West Main street, Waterbury, ten cars and a motorcycle being in line, and thirty-nine persons participating.

The destination was the popular Long Island shore resort at Woodmont, by way of Cheshire and New Haven. The procession was led by Truman Lewis in his 24-horsepower Franklin. New Haven was reached in from 1-4 to 1-3-4 hours, and by noon seven or eight cars had gathered on the lawn of the Pembroke Hotel at Wood-

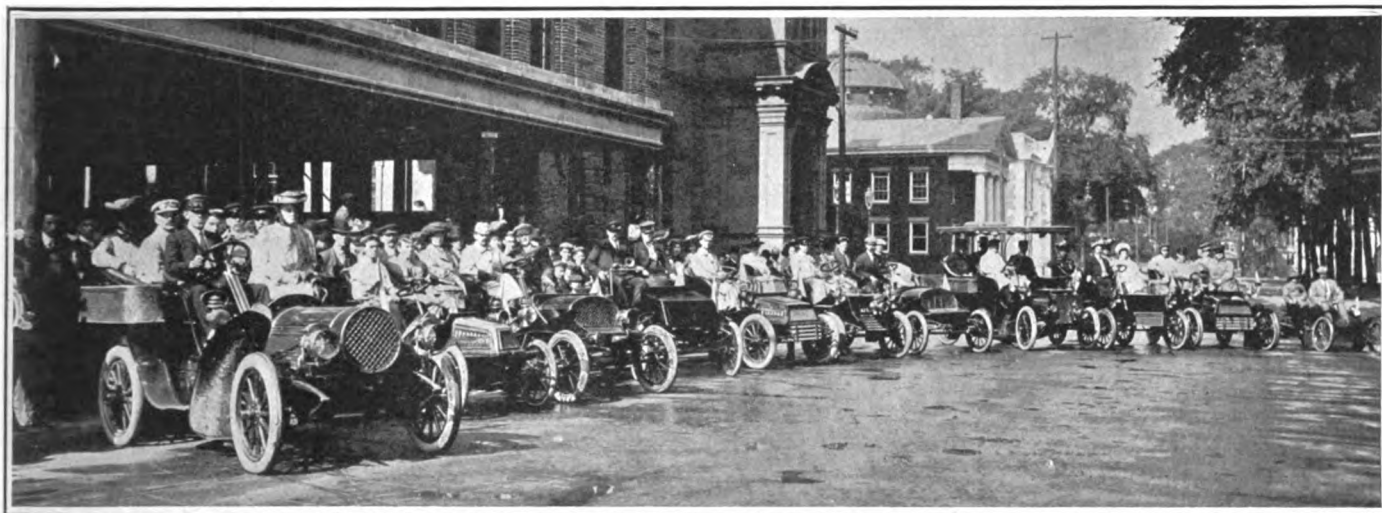

WATERBURY, CONNECTICUT, AUTOMOBILISTS READY TO START FROM TOWLE GARAGE ON COUNTRY RUN TO WOODMONT.

was no speeding, because the roads made this impossible, and the tourists realized their responsibilities in a state where the doctrine of motoring has not been spread as it has in the East, so that they made it their purpose to develop a feeling of friendliness among the people through whose country the route lay. In this respect they were more than successful. No farmers' horses were scared, no chickens and dogs were killed and the farmers had only the friendliest feeling for the motorists. This was clearly shown near Montgomery City, where the tourists stopped at a farmhouse about noon and asked for a drink. They meant to reach town in time for lunch, but the farmer would not hear of it. His three daughters cooked the best meal, so the tourists say, of the trip, and they were almost angered when payment was offered, so Mrs. C. C. Cockerill, who, with her husband, traveled in one of the Stevens-Duryeas, took the three young women and their brother for a ride.

At another place, when a tire had burst, a farmer came out of a neighboring house with a pitcher of cool well water, and some minutes later offered some fine lemonade. These few incidents and the manner in which the inhabitants of the towns crowded

pects his 120-horsepower Peerless, Webb would use a 60-horsepower Pope-Toledo, Jay a White racing car, and Kiser *Bullet No. 2*. St. Louisans are enthusiastic over the prospects of another meeting of expert drivers.

A number of local motorists are making Eastern trips in touring cars. H. S. Turner left this week with a party in his Pope-Toledo for New York, going by way of Chicago, Cleveland, Buffalo, Rochester, and Albany. From New York the party will go to Philadelphia, where the automobile will be shipped back to St. Louis. J. A. Prescott and his family also left for New York this week in a Pope-Toledo car.

The Pope has signified his intention of using an automobile, and the papal secretary has been charged with the selection and purchase of a light and noiseless car to be used in lieu of the light horsedrawn carriage now used in the Vatican gardens.

Having put on his steel helmet, he adjusted his heavy breastplate and the chain armor that guarded his back and arms. "Now," he said, "I will go out for an automobile spin through Summit, New Jersey." —*Cleveland Plain Dealer.*

mont, where by 2 o'clock all had gathered and a shore dinner of shellfish was served. The roads were dusty and a bit rough, and the good natured rivalry of the drivers raised clouds of dust and occasioned a few mechanical troubles.

The return run was begun at 4 p. m., and Waterbury was reached at from 6 to 8:30 o'clock, the route being through Milford, Stratford, Derby and Seymour.

The cars that made the run, with their respective occupants, were:

Franklin 24-horsepower—Mr. and Mrs. Truman Lewis, J. P. Morgan, P. O. Knight, Mr. and Mrs. A. G. Jagel, Herman Turell; Rambler—E. H. Bristol, C. S. Goodyear, Tracy Smith, Richard Nelson; Locomobile—Mr. and Mrs. Louis Maltby; Franklin—E. H. Towle, George E. Towle, R. C. Barber, Arthur Middleton; Ford—F. O. Peabody, Ethel and Ruth Peabody; Pope-Hartford—Mr. and Mrs. C. A. Templeton, Mr. and Mrs. J. S. P. Castle; Franklin—Mr. and Mrs. E. A. Lewis, Mr. and Mrs. Walter C. Palmer; Ford—Mr. and Mrs. George Wright, Mabel and Emma Wright; Pope-Hartford—Charles Thomson, Fannie and Maud Vaden, Mr. and Mrs. H. H. Romer; Covert—Mr. and Mrs. Norman; Indian Motorcycle—John Dower.



Fifteen automobiles are now owned by the residents of Dixon, Ill.

Carson Gilbert has secured the Oldsmobile agency for Boulder, Colo.

Foreman Brothers are agents for the Ford automobiles at Paducah, Ky.

H. A. Babcock, of Waterbury, S. D., has secured the agency for the Ford cars.

The William Galloway Co., of Waterloo, Ia., has secured the agency for northeastern Iowa for the Cadillac cars.

Henry A. Mack, 125 East Market street, Lima, O., has secured the agency for the Haynes-Apperson, Cadillac and Olds automobiles.

H. W. Hawes, manager of the Riverside Music Co., has secured the agency for the Ford cars at Riverside, Cal.

Hans P. Madson is the first resident of New London, Wis., to own an automobile, having recently purchased a Rambler.

Reed and Costello, of Lynn, Mass., have filed a petition of involuntary bankruptcy against the Bouton Automobile Co., also of Lynn.

Conspicuous in the recent G. A. R. automobile parade in Boston were the sixty Oldsmobiles loaned by the New England agency.

The first automobile delivery wagon to be adopted in Davenport, Ia., is an Oldsmobile recently put in use by the Model Laundry Company.

Two John, a full blood Sioux Indian, of Bonesteel, S. D., is a recent purchaser of an automobile, having bought a \$2,000 machine in Omaha.

The automobile factory and repair shop of George A. Patburg, of Mountain View, Calif., has been destroyed by fire. Loss, about \$3,000.

Joseph Thompson and family, of New York, have recently completed a seven weeks' tour of France, Switzerland, Austria and Germany.

The stables of Colgate Hoyt, on Center Island, were destroyed by fire last Sunday night, together with several automobiles, horses and carriages. Loss, about \$75,000.

C. Schmidt & Sons have been given the contract for the erection of an automobile garage for L. R. Elliott, corner Second and Edward streets, Philadelphia, at a cost of \$2,500.

James A. Doidge, a shareholder for \$500, has petitioned for the winding up of the Redpath Motor Vehicle Co., of Berlin, Ont., which was incorporated last November for \$50,000.

The Olds Motor Works, of Lansing and Detroit, has arranged to open a branch at Des Moines, Ia. The business will be conducted by the Olds Engine and Automobile Co., Campbell Brothers, managers, at 409-411 West Ninth street.

It is reported that electric passenger vehicles will be used as feeders for the underground and elevated railways in New York city. The automobiles will take up passengers wherever they may be and, selling through tickets, unload them at the nearest elevated or subway station.

George J. Gould, with his wife and daughter, returned last Saturday, after a two-months' stay in Europe, most of the time being spent in automobile touring in England, France, Austria and Hungary.

A new ordinance passed by the common council of Dayton, O., which became effective September 1, requires the registration and licensing of automobiles, bicycles, and all other wheeled vehicles used on the streets.

A company has been organized in St. Thomas, Ontario, to operate an automobile service between that city and Port Stanley. It is proposed to make hourly trips, carrying not more than twenty-five passengers each trip.

In order to secure better shipping facilities, the Goddard & Allen Company, manufacturers of bicycles and gasoline engines, of Beloit, Wis., will soon remove to Rockford, Ill., where it will occupy the Watchmakers' Institute Building on Walnut street.

The Broc Carriage and Wagon Co., 417-421 Case avenue, Cleveland, Ohio, builders of automobile bodies and trimmings, are enlarging their facilities preparatory to more extensive manufacture, and, in addition, are installing a general automobile repair department, in charge of J. W. Pulford.

George Edwards and William T. Jones, of Detroit, Mich., have entered into partnership under the firm name of Edwards & Jones, and will engage in the manufacture of automobile lamps at 61 East Fort street, Detroit, Mich. Both have had a wide experience in the auto lamp business and are well equipped for their new venture.

The Geneva Automobile and Mfg. Co., of Geneva, O., has been made defendant in a suit for \$15,000 damages filed by Mrs. Rose Ernst, who claims to have been seriously injured in an accident caused by the running away of her horses upon being frightened by an automobile driven by W. F. Adams, tester for the company, on May 19, 1903.

When the common council of Buffalo, N. Y., convenes after its summer vacation Alderman Harp, it is said, will introduce an ordinance that will materially reduce the speed limit now allowed automobilists within the city limits, and provide punishment sufficient to guarantee that all drivers of machines will drive within its provisions.

The Brooklyn Coach Association, an organization of liverymen now being formed, has for its object an attempt to have automobiles barred from the Brooklyn speedway at all hours of the day and night. Motor cars are now allowed to use the speedway only during certain hours. The liverymen declare that the heavy machines have practically ruined the drive by rolling it down almost as hard as a macadam pavement.

Judge Geo. B. Seidener, of St. Louis, gave a dinner at the Monticello Hotel on Monday evening, August 29, to the participants in the recent speed contests held at the St. Louis Fair Grounds track. Besides the motorists who were in the races several local and foreign automobile dealers were invited. R. W. Slusser acted as toastmaster. Among the guests present were A. C. Webb, R. R. Johnson, of Cleveland; Webb Jay, John Boogher, Dr. W. Gardiner, and R. Baumel of St. Louis.

Fourteen automobiles are now registered by residents of Boulder, Colo.

Records of the New Jersey Secretary of State show that 6,997 automobiles have been registered under the automobile law, a large number having been issued to motorists of New York and Pennsylvania.

Otto Nestman, of Holyoke, Mass., well known as the driver of the Stevens-Duryea cars, was severely burned by the ignition of some gasoline in the repair shop of the Stevens Arms & Tool Co., at Chicopee Falls last week. After being taken to his home, the attending physician announced that the burns were deep and he would be unable to use his hands or arms for several months.

Leinbach Brothers, makers of canopy tops and other automobile fixtures, of Detroit, Mich., finding their quarters inadequate for the requirements of the business, have leased and occupied the four-story brick building at 253-255 Jefferson avenue, formerly occupied by Fred Bamford & Co. In their new quarters they have more than 24,000 square feet floor space, have installed modern machinery, and have ample facilities for the conduct of the business.

A comprehensive little volume on "Les Motocyclettes," by Baudry de Saunier and Adrien Gatoux, has just come from the press of Vve Ch. Dunod, 49, Quai des Grands-Augustins, Paris. It takes up in detail all the leading French motor bicycles, also the Werner, and has separate chapters on motors, carburetors, ignition devices, clothing and general care. It is fully illustrated, and is sold by the publishers for 6 francs, or about \$1.20.

Since the Climb to the Clouds last July, Bretton Woods, N. H., has become an interesting center for automobile parties touring in New England. Among the late visitors to the Mount Washington district are Charles Houghton Esty and wife and Howard Parker, of Brookline, Mass., in a Peerless; M. J. Budlong and wife, of Hartford, Conn., in a Columbia; S. A. York, of New Haven, Cadillac; G. M. Brown and wife and Charles L. Way, of New Haven, in a Haynes-Apperson, and E. R. Hoyt and wife and Randall Hoyt, of St. Louis, in a Peerless.

The Packard Motor Car Company, Detroit, Mich., is compiling an exceedingly full and complete report of the recent 1,000 miles non-stop run made by a Model L Packard car. The information given will be of the most minute character. The time for each individual mile will be recorded as well as the time for each five-mile stretch. The exact consumption of gasoline and all other supplies will be given and notes made of every occurrence connected with the test and of all work done on the car or its equipment. The information concerning the behavior of the tires is expected to be particularly interesting owing to the peculiar conditions developed during the test. A noteworthy feature shown by an advance sheet of this report is the remarkable regularity of running exhibited for 25 consecutive miles, all of which were made within less than two seconds of the same time. The fastest mile in this series was timed at 1:45 1-5, and the slowest in 1:46 3-5, a maximum variation of 1 2-5 seconds. This report, when completed, will make a book of 20 pages, and will be bound in a handsome cover.

THE AUTOMOBILE

WEEKLY

NEW YORK—SATURDAY, SEPTEMBER 17, 1904—CHICAGO

10 CENTS

AUTOMOBILE EXHIBITS AT THE WORLD'S FAIR.

MEASURED by the possibilities the automobile exhibit at the Louisiana Purchase Exposition in St. Louis is not a success. Judged by its own merits it cannot be called a failure. The automobile and wireless telegraphy constitute the real novelties in invention that have become part of everyday life since the great World's Fair at Chicago, and the opportunity to thoroughly exploit the former at St. Louis has been utterly lost by the exposition management. Not lost so much as unrecognized, as is manifest not only in the housing of the American exhibit in par-

ticular but in the attitude of those in immediate authority toward automobiles in general.

In the great Transportation building in the Fair the American automobile exhibit occupies more than 50,000 square feet of floor filled with a good representation of the cars manufactured here, but all screened off so effectively from the main aisles that a comparatively small percentage of those entering the building ever find their way to the newest thing in locomotion.

In another part of the building, open and unscreened, the French exhibit compels at-

ention, and, though smaller in extent, is doubtless viewed by thousands who do not even know that there are American cars under the same roof.

Railroads and railroading have the place of honor, and the automobile is apparently an afterthought.

In the south aisle of the Transportation building the American automobile exhibit occupies a space about 500 feet long and 110 feet wide, the sides of which are formed by the south wall of the building and a 12-foot screen which, except for an opening in the middle and passageways at the ends,

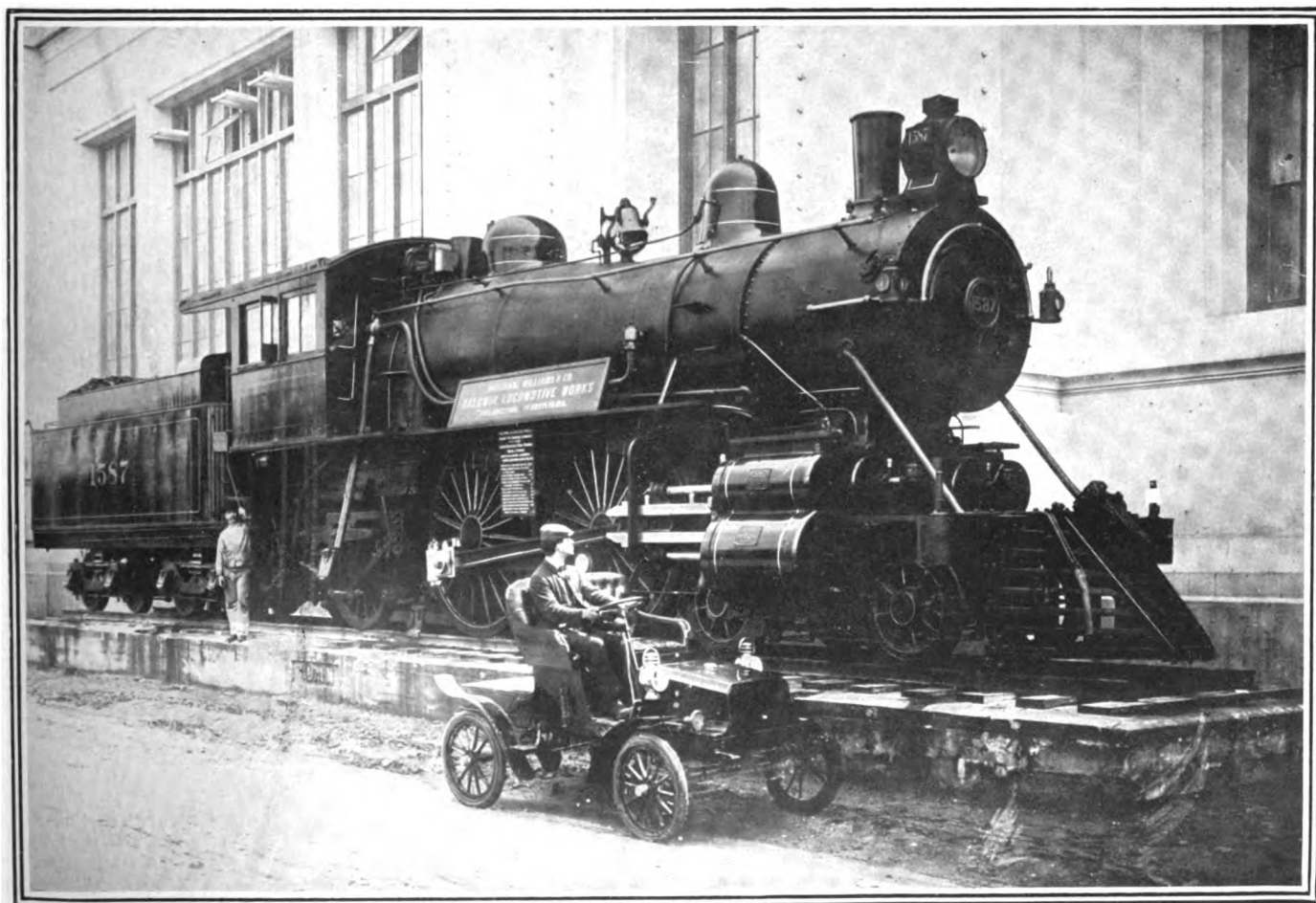

TWO STEAMERS AT THE WORLD'S FAIR—BALDWIN COMPOUND LOCOMOTIVE WITH SPEED RECORD OF 90 MILES AN HOUR, OWNED BY C. B. & Q. R. R., AND GROUT RUNABOUT ALONGSIDE.

runs the entire length of the building, practically an unbroken obstruction. North of this partition wall, which is photographically reproduced on this page, are the main aisles of the building leading to the great entrances at the ends. Through these entrances most of the visitors come into the building, passing down through the railroad exhibits without their attention being attracted by the automobile exhibit as they go through. As the intramural railway parallels the south wall of the building, and there is only a dirt roadway between, there is little movement of visitors in or out of the building through the doors on this side. These conditions will be the more intelligible upon an inspection of the plan view on page 321.

In the northwest corner of the Transportation building the French section has a space about 300 feet by 100 feet, with the wall of the building on one side and on the other nothing to obstruct the view from the main aisles except exhibits. As this side of the building faces Machinery Hall—with a delightful boulevard paved and planted between—the side doors here are freely used by visitors. In every important respect the French exhibit is more advantageously located than the American.

There are many and striking differences between the French and American sections, both as to the cars themselves and their surroundings. As to the former, the American exhibit is inclusive, the French exclusive. The differences in the surroundings are even more marked. Long experience in international exhibitions combined with national taste and artistic perception have given the French a marvellous degree of skill in making a beautiful display of their wares. A first impression of each of the sections is given in the photograph reproduced on page 307. In the American section the visitor looking down the long vista of poles thinks for the moment that he is entering a lumber exhibit, until his eye, wandering upward, catches sight of the pawnbroker's sign on top of each group. To explain the mystery he glances at the glass plate (see page 322) in front of a booth and reads the unintelligible (to him) notice "Nat'l. Assn. Auto. Mfrs."

The deserted appearance of the aisles and stands might confirm the impression pro-

duced by the gilt balls overhead, for the exhibit more resembles a place of storage than a bustling, active fair. This sign of the N. A. A. M., which is sandwiched in between every pair of makers' signs, has been very misleading. Few of the visitors know of the existence or purpose of the organization, and many get the impression that some car that strikes their fancy is built by the maker with the abbreviated name, the real builder not being recognized.

As has been said the American exhibit is inclusive, covering a wide range of vehicles of all sizes and styles. Gasoline, steam and electric cars are well represented by leading makers. While to the initiated there are few novelties in complete vehicles or details of construction, this is an advantage to the interested and unsophisticated visitor, for he can see duplicates of all styles



PHOTOGRAPH OF PARTITION WHICH CUTS OFF THE AMERICAN AUTOMOBILE EXHIBIT FROM THE MAIN BODY OF THE TRANSPORTATION BUILDING AT THE WORLD'S FAIR IN SAINT LOUIS.

of cars now in use and for sale on the market. Freaks and untried inventions do not distract his attention from the serviceable machines of to-day.

In the American section there are three platforms running lengthwise of the building, one on each side, and a wider one in the center with two aisles for the visitors, who are also free to move about among the exhibits. Along the outside edges of these platforms the wooden posts already referred to are placed at intervals and there are no dividing ropes or partitions between the several stands on each platform. As a consequence the inexpert visitor never knows when he passes from one exhibit to another for few of the cars are adequately labeled and many of the exhibitors have no representatives on the floor.

The Transportation building, like nearly

all the other structures on the grounds, is built of wood. Viewed from the outside it is very attractive and gives promise of artistic beauty within, which gives place to disappointment when the antiquated looking roof beams and rough supporting pillars meet the eye—a striking contrast to the fine geometrical shapes of the new buildings of the Chicago Fair. In many exhibits, as in the Secret Hall for example, this would not be a matter. For an automobile exhibit, in which artistic form and color play so considerable a part, an artistic setting is a necessity. To overcome the bad effect of the interior the American section is draped overhead with colored bunting which serves the purpose very well, though it screens a good deal of light from above.

The overflow from the section along the side of the building is placed in spaces on the transverse aisles at the west end, where a wide door opens southward onto the roadway used by demonstration automobiles.

Early promises that the cars at the Fair would be largely shown in operation have not been fulfilled. For several weeks after the opening of the Fair the demonstration of cars within the grounds was not permitted at all. When permission was finally granted the cars were allowed to use only certain specified roads which lead from the State Buildings Entrance in a circuitous route to the Transportation

building. Much of this route is over soft dirt roads that on wet days are almost impassable, and there are some very steep pitches along the way. For this reason little use is made of demonstration cars and also because the automobile representatives fear they will be subject to many petty annoyances on the part of the armed guards and other World's Fair employees.

In the American section the display of sundries, accessories and component parts is not nearly as representative as that of complete machines. A few stands of makers of accessories are lined along the south wall of the building, and there are also more inclusive exhibits by dealers, but the showing is not comprehensive. There are no tires displayed in the American section, those exhibited being placed among other rubber goods in one of the large buildings



PHOTOGRAPH TAKEN IN ONE OF THE AISLES OF THE FRENCH AUTOMOBILE SECTION SHOWING PORTION OF THAT EXHIBIT—NOTE THE INDIVIDUAL STANDS AND THE DECORATIONS WHICH DO NOT OBSTRUCT THE VIEW OF THE MACHINES.

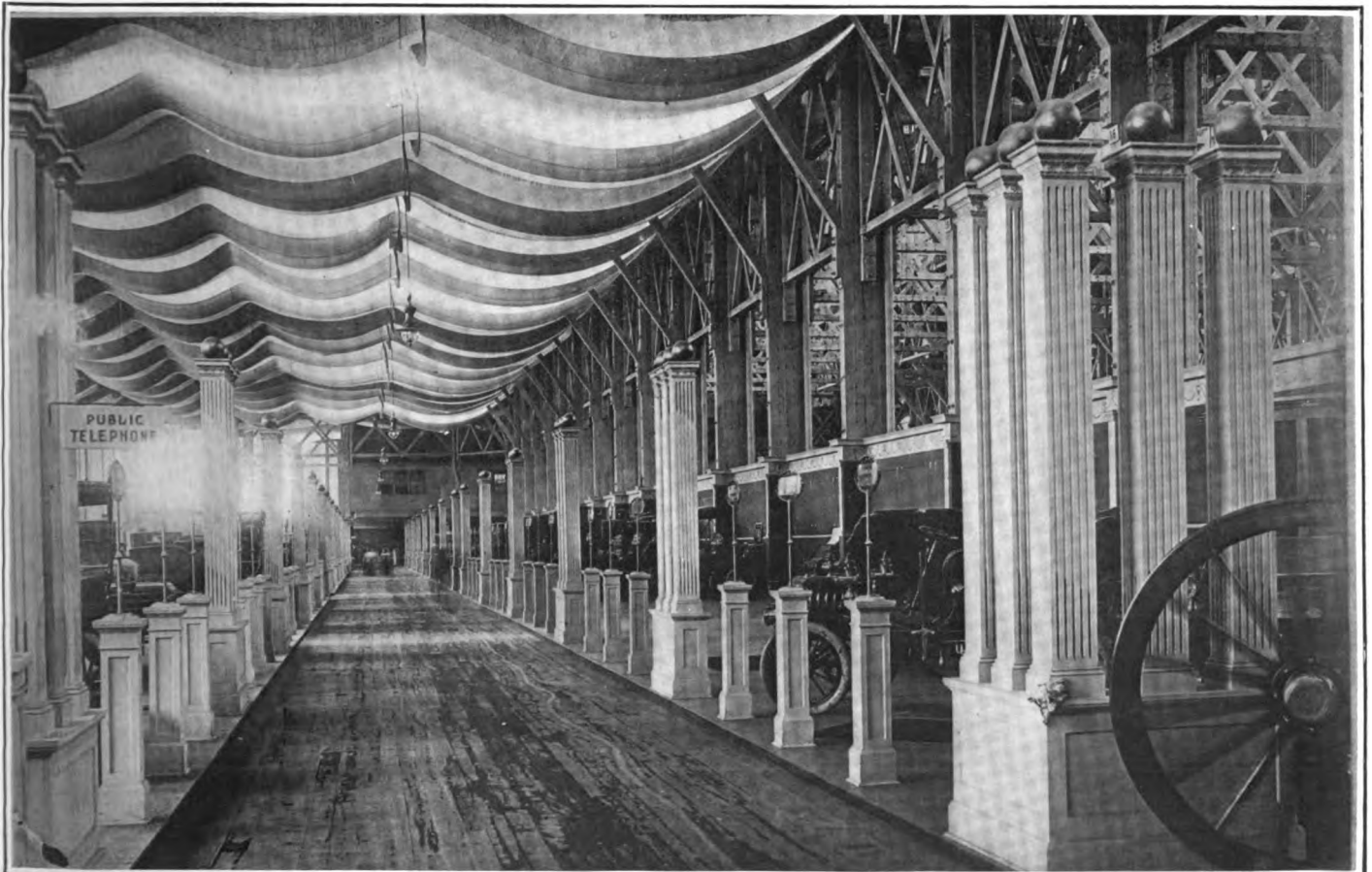

PHOTOGRAPH IN ONE OF THE AISLES AT THE BEGINNING OF THE AMERICAN AUTOMOBILE SECTION IN THE TRANSPORTATION BUILDING—NOTE THE PROMINENCE OF THE PILLARS AND POSTS WHICH OBSTRUCT THE VIEW OF THE CARS AND DISTRACT THE ATTENTION FROM THE VARIOUS EXHIBITS.

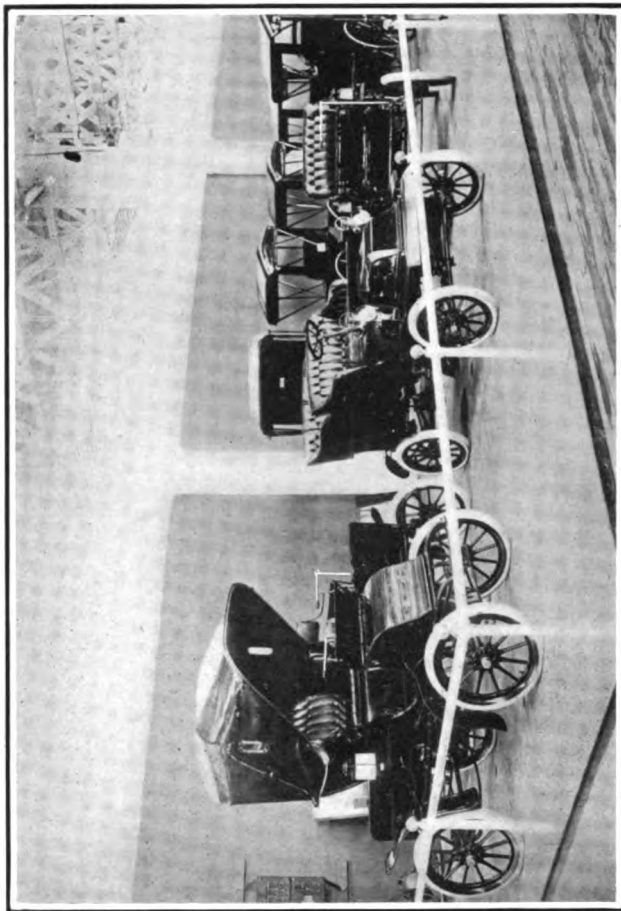
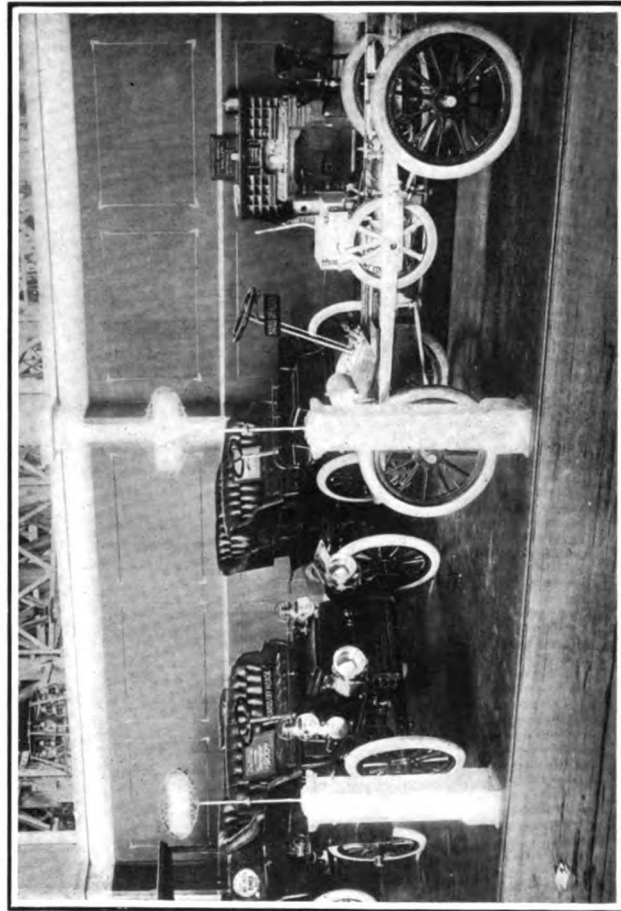
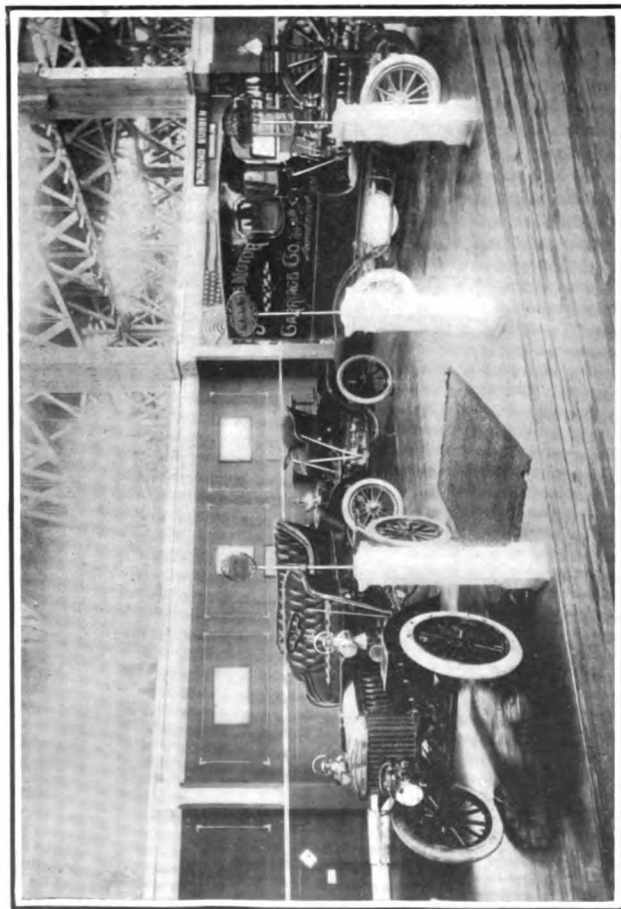

Exhibit of the Studebaker Automobile Co., Showing Electric and Gasoline Cars.



Complete Cars and Chassis Shown by the Cadillac Automobile Co.



Stand of the St. Louis Motor Carriage Co., Showing Pleasure and Commercial Vehicles.

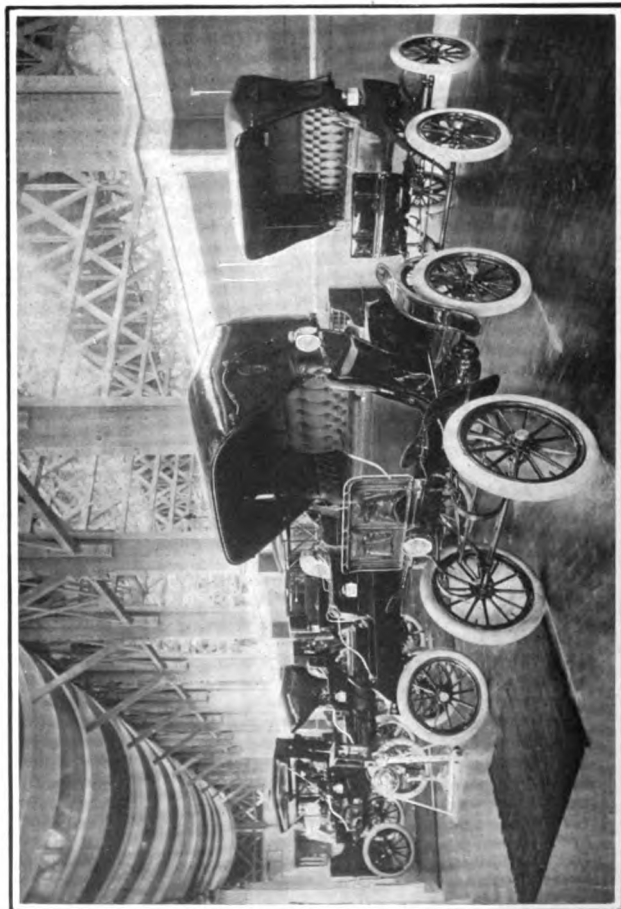

Electric Carriages Exhibited by the National Motor Vehicle Co.

PHOTOGRAPHS OF TYPICAL STANDS OF ELECTRIC AND GASOLINE MACHINES IN THE AMERICAN SECTION OF THE TRANSPORTATION EXHIBIT AT THE LOUISIANA PURCHASE EXPOSITION.

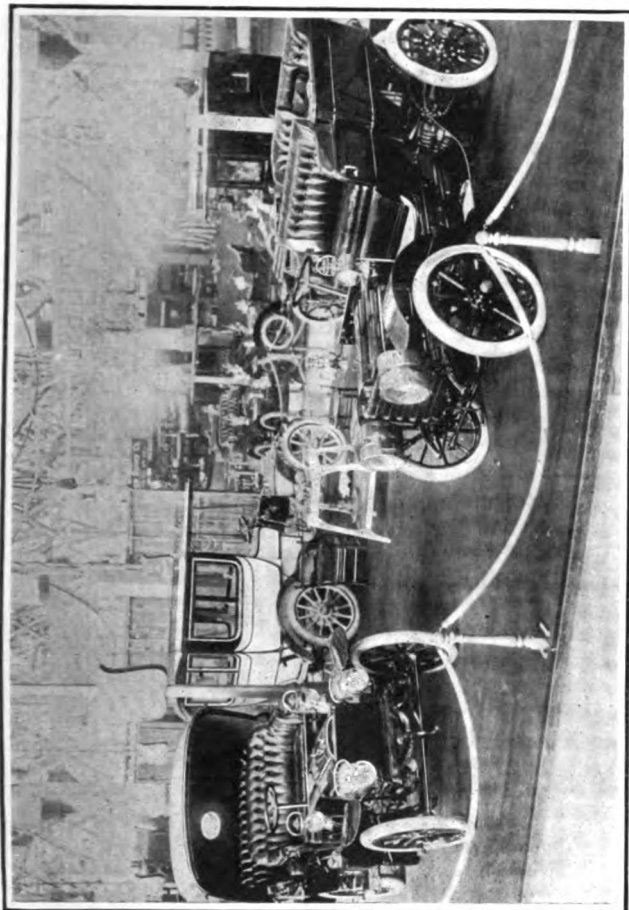

General View of the Mors Exhibit, Showing Enclosed, Semi-Enclosed and Open Cars.

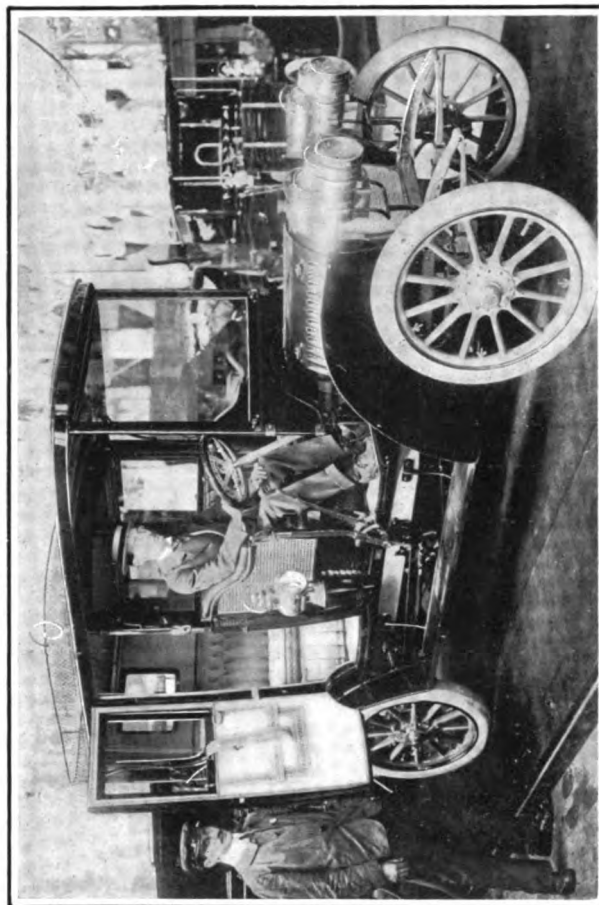

Exquisitely Finished Side-Entrance Enclosed Hotchkiss Car.

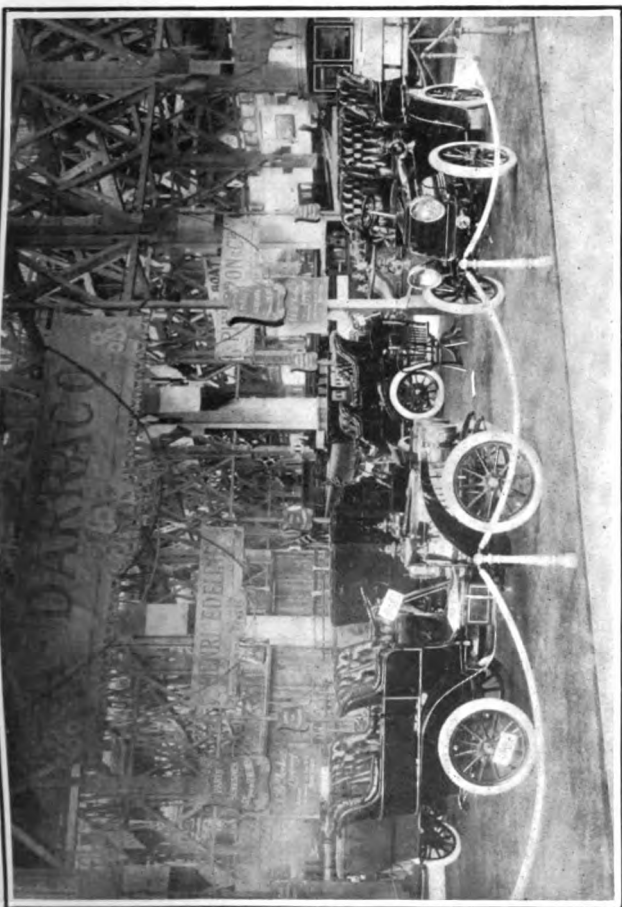

Darracq Stand, Showing Complete Cars with Tonneau and Side Entrance Bodies.

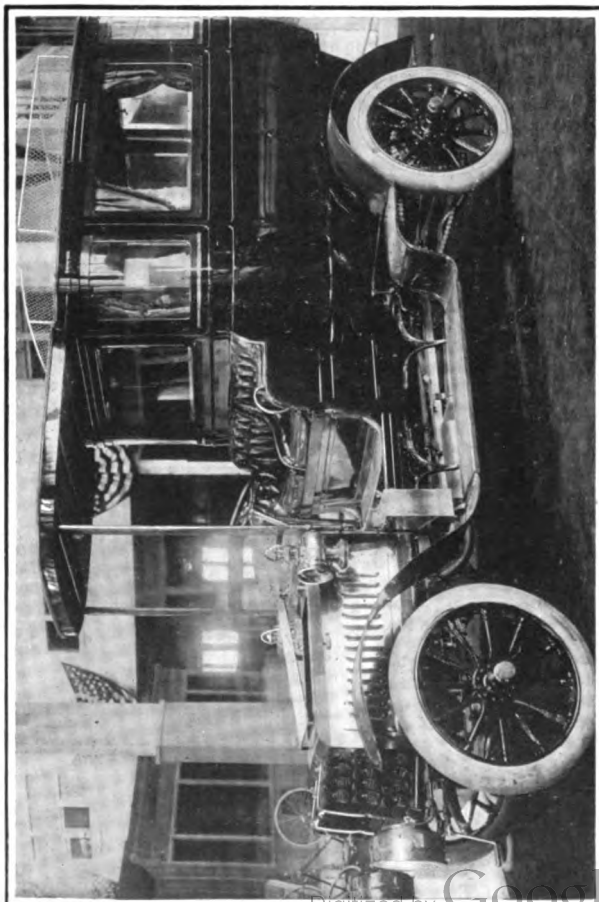

Magnificent Touring Car de Luxe Exhibited in the de Dietrich Stand.

PHOTOGRAPHS OF SOME OF THE NOTABLE EXHIBITS IN THE FRENCH SECTION AT THE LOUISIANA PURCHASE EXPOSITION AT SAINT LOUIS—COMPLETE STANDS AND INDIVIDUAL CARS.

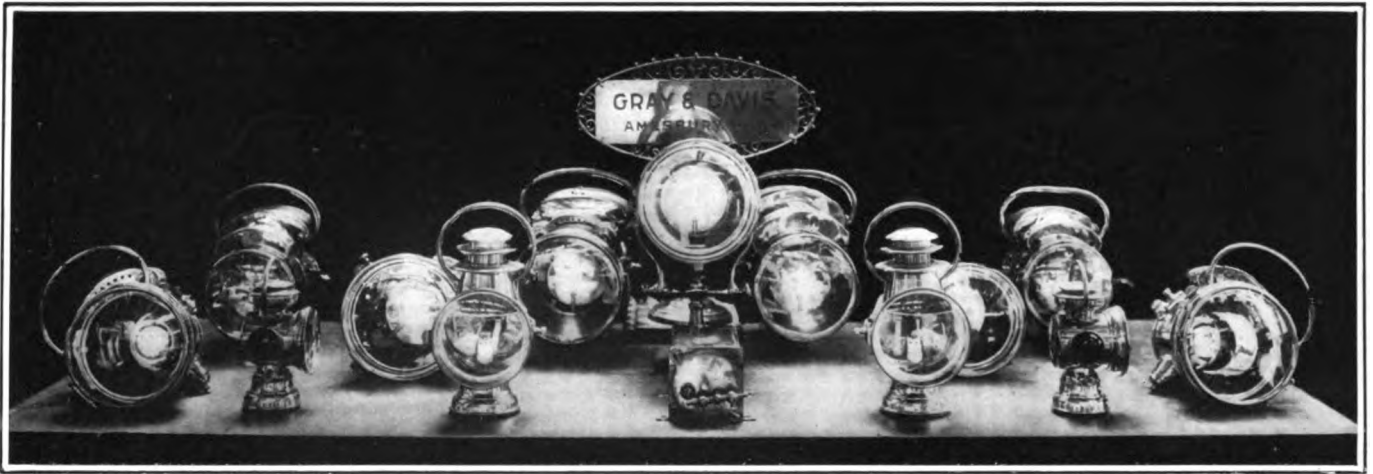

EXHIBIT OF LAMPS MANUFACTURED BY GRAY & DAVIS IN THE AMERICAN AUTOMOBILE SECTION AT THE WORLD'S FAIR.

containing industrial exhibits. In both the French and German automobile sections there are extensive and representative exhibits of tires that add considerably to the interest of the show for automobilists.

Approaching the French section the visitor gets an immediate impression that here is a beautiful display of automobiles. There are no pillars and posts as in the American section to obstruct the view and confuse the visitor, but a broad stretch of floor space on which in individual stands the cars of each exhibitor are artistically disposed. The wide aisles between the stands permit a great number of visitors to walk about freely and obtain close views of all the exhibits. Each stand is on a raised platform covered with cerise red carpet, giving it a warm, furnished appearance. Tall, slender masts support silk velvet signs overhead, that bear the name of the exhibitor in gold letters. Silk cords and tassels help the artistic effect of these signs, which are uniform in color and manner of inscription. The edges of the stands are railed off with short posts and heavy twisted cord strung between. These posts fit snugly in mortices in the floor and can be easily pulled up to permit of the movement of a car on or off a stand. In the American section the large posts are nailed down, and as they are not spaced widely enough apart to allow the passage of a large car between they have frequently to be torn up.

The French exhibit has been arranged with great care, so that it produces an immediate and favorable impression on the visitor. Instead of appearing as a miscellaneous collection of vehicles it is a composition in which all the parts are arranged to produce a harmonious picture. Most of the cars shown are of the luxurious sort, and there are some extremely beautiful examples of coach work and upholstery on view. The color schemes of some of the cars are bold, but produce strikingly pleasing effects. In one of the Kellner bodies fitted to a Hotchkiss chassis there are blended claret, black, red and yellow, the latter painted in clever imitation of cane in the

panels. Many of the cars seem to have been specially well finished for show purposes, and the exhibits of component parts and accessories are manifestly show products, of beautiful design and workmanship.

Nearly all of the stands have permanent attendants, some of whom can speak several languages, and M. Faive, representative of the French manufacturers' association, has an office close by and is always in attendance ready to take unlimited pains with visitors during the Exposition hours. French attendants dressed in neat uniforms also patrol the aisles ready to give information to visitors, or perform any needed service for the exhibitors.

American manufacturers would be well repaid for a visit to the Fair if for no other purpose than to personally examine the French methods employed. In artistic arrangement and convenience for visitors, in its perfect organization and in the knowledge of exposition needs displayed by the personnel it far surpasses not only the American section at the Fair but anything in the way of an automobile show ever held in this country. Personal interests have been subordinated to the general good of the French industry. As an example several of the exhibitors of complement parts have given imperative instructions to the management not to take any orders, the exhibits being made so that the French section might be representative of the industry.

Among the automobile exhibitors, in the American section especially, there is not much enthusiasm left. The attendance has not been what was expected, either in quality or quantity. Except for a few weeks earlier in the season the visitors to the automobile section have been what one exhibitor termed a "lunch basket crowd." Repeated explanations of the construction of a gasoline car have time and again resulted in the final query of a visitor, pointing to the ignition wiring: "So this is an electric car." Leaky roofs, which on wet days threaten to spoil valuable exhibits, and an uninterested if not antagonistic set of Fair officials with whom the exhibitors come in contact all

add to the depressing influences, and the initiated visitor never feels glad except when he leaves the gloomy automobile exhibit and walks out into the sunshine and beautiful scenes in the grounds.

In both the French and American sections there is a noticeable absence of attractive literature for distribution. This seems to be a mistaken policy, for while temporary curiosity might cause many visitors to take away catalogues, yet all would not be wasted, and the educational possibilities of such an exposition are tremendous. The merely curious of to-day may be the eager customers of to-morrow.

Without considering here what might have been done to promote a correct and wider knowledge of what the automobile really is at this World's Fair, the exhibits of themselves are adequate in number and representative in quality and kind. In the domestic section the visitor sees cars of moderate price, built especially to meet the conditions of American travel. Cars that crossed the continent and cars that toured from New York to St. Louis are on view just as they finished their trips alongside of the same styles of machines as they came out of the shops. The visitor can make his own comparisons. In the foreign section the luxurious side of automobiling is presented in many exhibits.

Thus the most economical and the most extravagant are on view with all the intermediate grades, and there is a splendid opportunity for the intending buyer to study styles and satisfy his particular tastes. And when to the display of automobiles is added the enormous number of other attractions, serious and amusing, that the 1,200 acres of the Fair contains, the question of a personal visit permits of only one reply: "Yes, go to the Fair."

Those who are within touring distance of St. Louis will doubtless prefer to make a visit an excuse for an outing. There are fine accommodations for man and machine in St. Louis, and if the automobilist keeps off those streets that trolley companies practically own he will greatly enjoy his visit.

American Automobile Section.

THE American automobile exhibits at the Fair disclose very little not already made familiar by the shows last winter and spring and by the technical press. Many things, such as exhibition chassis and parts, have already done duty at New York, Chicago and elsewhere, though, of course, they are new to many of the visitors at St. Louis. Evidently there are not now many manufacturers who make changes in model in the midst of the selling season; but if the exhibits show few novelties, they are complete and instructive. Nearly every American make of importance is represented, and several exhibits of parts, accessories and clothing are also shown.

After the termination of the St. Louis tour a number of makers put their tour entries on exhibition for a longer or shorter period. Mr. Glidden's Napier was for several days ensconced among the railway exhibits at the west end of the Transporta-

tion building, and the Pope-Toledo and Pope-Hartford were among the cars added to the regular exhibits.

One brand-new model, the 1905 White steamer, was put in place a few days after the end of the tour, and naturally attracted much interest.

To the technically inclined the French automobile section was much more interesting than the American. This was due, of course, both to the high grade of engineering skill displayed in these machines and to the fact that several makes shown were entirely new to the American public. Evidently the French makers had done their best to make a good impression, and if they did not wholly succeed it was by reason of no fault of their own. The fact is that few buyers in the West are educated up to the refinements of French automobile engineering, and the larger number of the visitors, knowing the imported cars to be as much out of their walk of life as

the German and French art objects in the Varied Industries and Liberal Arts buildings, casually admired—and went their way. From this standpoint the American makers who showed low-priced runabout and light road models displayed sound business judgment. The kind of public interest that spelt profits was all captured by them.

The Haynes-Apperson Co. shows, in addition to samples of its present year machines, what is without doubt one of the oldest, if not the oldest, gasoline automobile in this country. It was built by Elwood Haynes in 1893, and has, like the present machine of the company, three forward gear changes. The motor and countershaft, which latter is driven from the motor by separate sprocket chains and individual clutches, are mounted on an underframe connecting the axles. The front axle swivels vertically on a horizontal king-pin, and the compensating gear appears to be a pair of ratchet clutches. The motor is a single cylinder, vertical, two-cycle engine, apparently capable of developing 2 horsepower. The regular exhibit com-

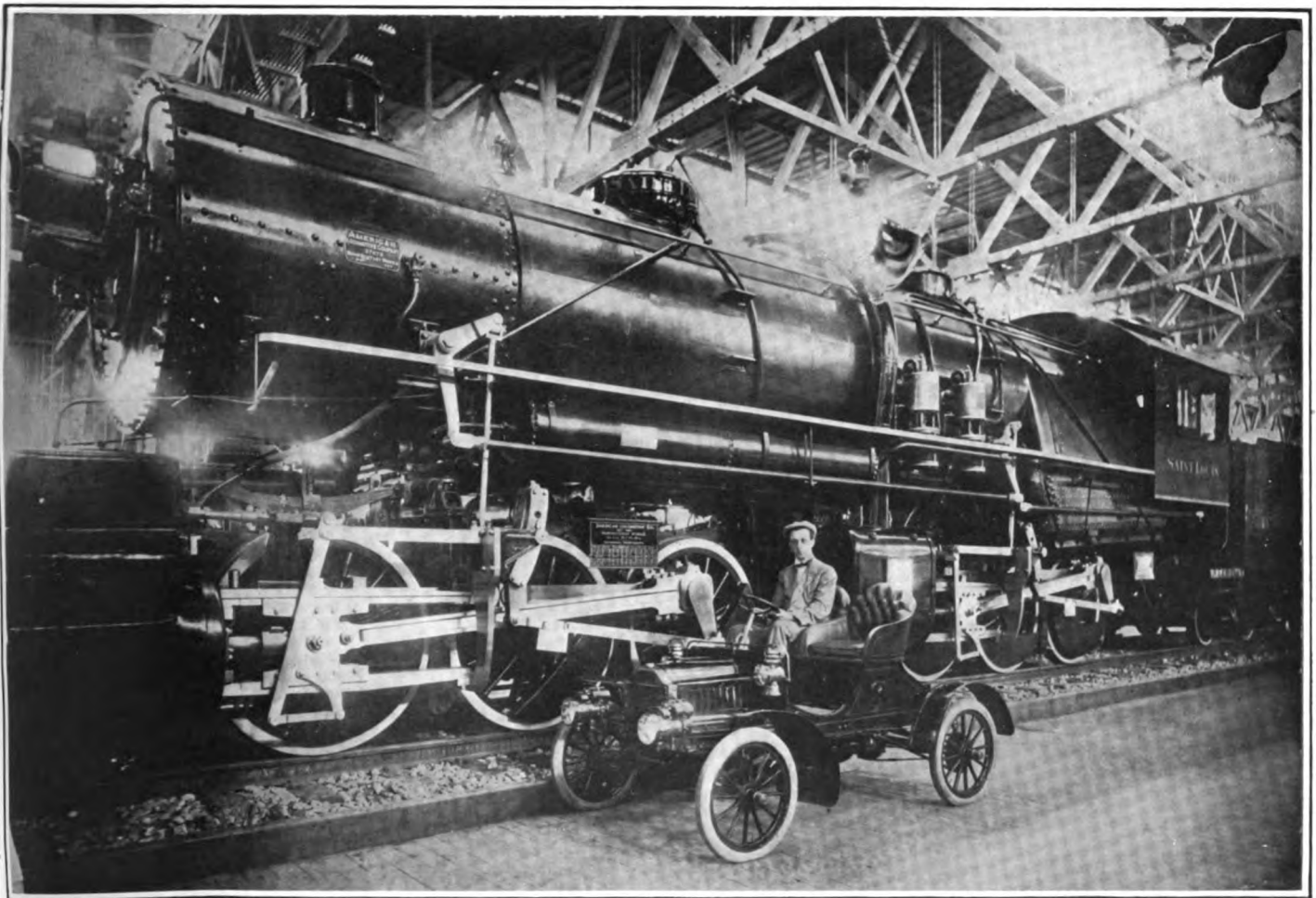

Photographed for *The Automobile*.

By N. Lazarnick, New York.

A CONTRAST IN DIMENSIONS—OLDSMOBILE RUNABOUT ALONGSIDE B. & O. ENGINE "ST. LOUIS, LARGEST LOCOMOTIVE IN THE WORLD.

The locomotive, which was built at Schenectady, N. Y., is an articulated compound with twelve driving wheels and weighs 480,000 pounds ready for the train. (Note the distance from the front of the smoke-box to the rear of the cab.) The Oldsmobile is one of the regular touring cars of 7 horsepower and weighs complete 1,200 pounds. Considering the confined space in which to place the camera, and the poor light, this photograph is remarkable as it is practically free from distortion.

prises two light road cars with folding tops and one tonneau touring car.

The St. Louis Motor Carriage Co. shows three machines, a 9-horsepower runabout, one tonneau touring car, and one delivery wagon, each of 12 horsepower. All three machines have single cylinder engines, but the runabout has only two forward speed changes, while the larger cars have three. In each case the speed change is effected by sliding gears which are mounted in an extension of the crank case, and the final drive is by single chain. The arrangement of the gears and shafts in the 12-horsepower car, which is a little out of the usual order, is as follows: Mounted on the crankshaft is a disk clutch tightened by a sliding thimble and dogs in the usual manner. The clutch serves to lock a loose gear fast to the crankshaft, and this gear meshes with another loose gear on the sprocket pinion shaft just back of the crankshaft. This gear is made rigid with its shaft by a

this writing put its exhibit in place, and the same is true of the Matheson Motor Car Co., the Eisenhuth Horseless Vehicle Co. and the Consolidated Motor Vehicle Co. Smith & Mabley have several imported machines in the French section, referred to elsewhere, but nothing was to be seen at their space in the American section except four packing cases.

The Pope Motor Car Co. shows two Pope-Hartford runabouts, one being the machine driven by Harold L. Pope in the St. Louis tour; a Pope-Hartford car with tonneau, a Pope-Tribune, and the Pope-Toledo entered by Albert L. Pope in the St. Louis tour. The electric vehicles shown by the same company comprise seven Pope-Waverley models, including runabouts, tonneau and closed vehicles, and a delivery wagon. The larger number of vehicles have the battery divided between two compartments at front and rear, or under-slung. Internal expanding hub brakes are

suspension rod hanging from a transverse tube, whose ends are attached to the front ends of the full elliptic rear springs. This tube in turn is hung from a short transverse leaf spring attached to the body. In all the lighter vehicles made by this company the front springs are of peculiar form. They somewhat resemble C-springs, and are pivoted at their rear ends to the main frame, while their backwardly curved front ends are attached by shackles to the front ends of the frame. This gives a very easy movement to the front axle. The seven vehicles shown include chiefly runabout and stanhope models.

Samples are shown also of the Exide, Edison and Western storage batteries, the last-named being made by the National Motor Vehicle Co. in its own factory. The exhibit includes also full-size working models of the controller and of the rear axle with motor attached. Reversal is effected by pressing a button in the end

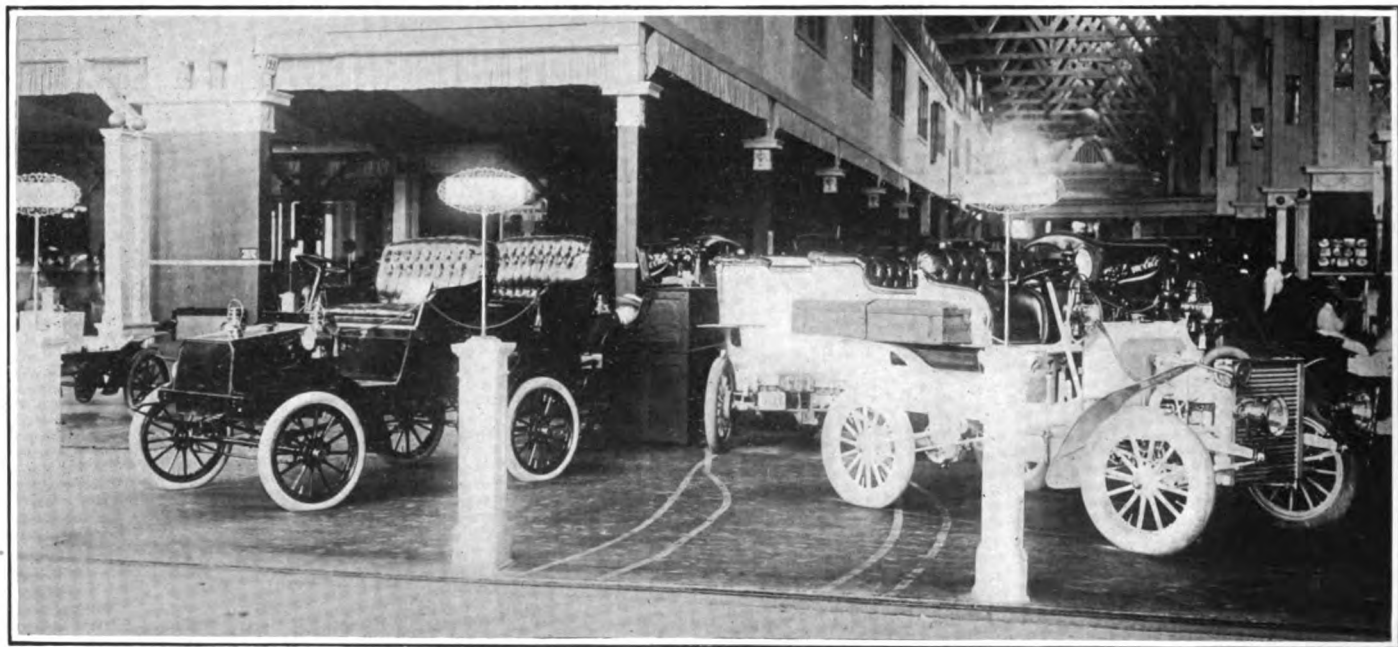

EXHIBIT OF STEAM CARS AT ST. LOUIS IN THE AMERICAN SECTION—WHITE CARS TO RIGHT, GROUT TO LEFT.

claw coupling for the high speed. This second gear is in constant mesh with a third, which is fast to a shaft below. Two other gears of different sizes are also fast to this lower shaft, and one or the other of two corresponding sliding gears on the sprocket pinion shaft may be meshed with them, giving the first and second speeds when the direct drive coupling is released. The reverse is obtained by an intermediate pinion engaged by the first speed sliding gear. The arrangement in the runabout is similar in some respects, but the sprocket pinion is on the lower shaft, not the upper, and a pair of sliding gears on the upper shaft give the lower its first and second speed.

The Royal Motor Car Company shows one of their 35-horsepower Royal tourist cars.

The Peerless Motor Car Co. has not at

used, and the motor suspension is in every case similar. The motor is enclosed in a case which projects forward from the case surrounding the differential and driving gear or gears on the rear axle. It is supported only by the axle, but the latter is steadied by means of a transverse leaf spring attached at its center to the body, and at its ends to the front ends of the full elliptic rear springs, thus preventing the latter from sagging from the weight of the motor. Where two motors are used the principle of suspension is the same, only that the differential is omitted and each motor is geared to drive one rear wheel independently.

The National Motor Vehicle Co. attacks the problem of supporting the motor in a different manner. Here too the motor is encased and attached to the rear axle case, but its weight is carried principally by a

of the controller lever. By means of an interlocking device, it is impossible to press this button down except when the lever is in the off position. When it is pressed down and the lever moved to any running position it stays down of itself. The safety plug has a tapered body and a screw-thread on the end, so that it screws in positively and cannot fail to make a good contact.

The Woods Motor Vehicle Co. shows three vehicles: an extension brougham, with the operator's seat in the rear; a front operated brougham of conventional design, and a front operated victoria with a folding child's seat just behind the operator's seat and fastened to the rear. The Wood Co.'s exhibitor states that they use principally the Edison battery.

An interesting accessory, said by those who have used it to be very successful, is the Brown's dust deflector for tonneaus.

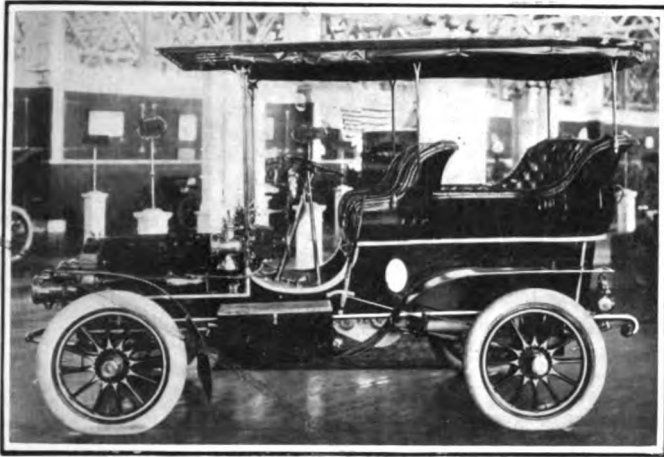

Artistically Finished Haynes-Apperson Tonneau.

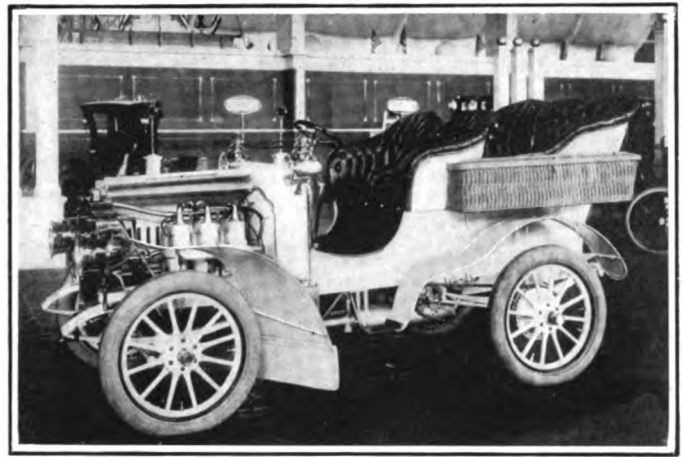

Three-Cylinder Thomas Touring Car, Finished in White.

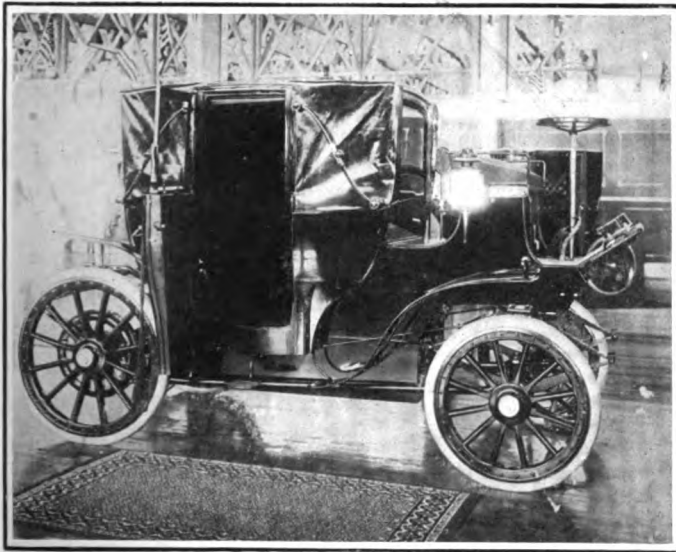

Electric Landau Exhibited by the Electric Vehicle Co.

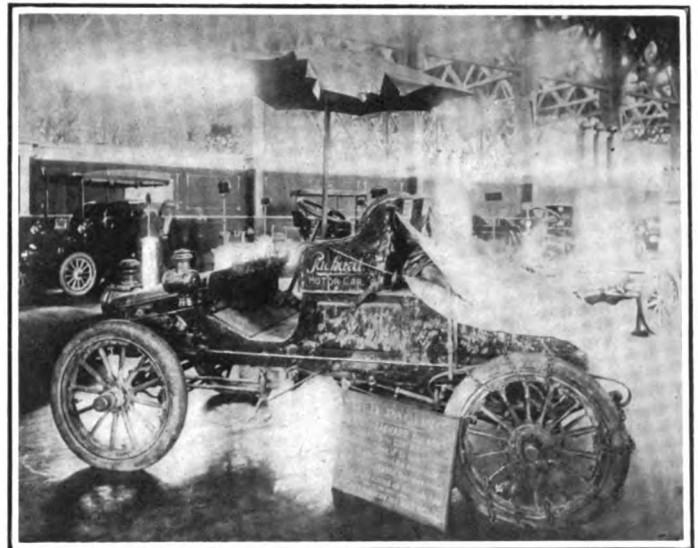

Packard Old Pacific Which Crossed the Continent.

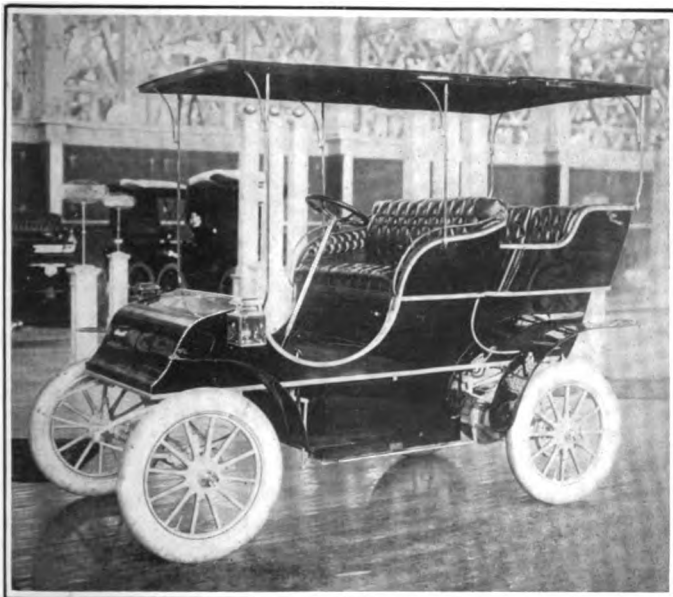

New Pope-Waverley Electric Tonneau, with Canopy.



Pierce Doctor's Carriage with Motor Under the Body.

A FEW OF THE ATTRACTIVE EXHIBITS IN THE AMERICAN AUTOMOBILE SECTION AT THE WORLD'S FAIR IN SAINT LOUIS.

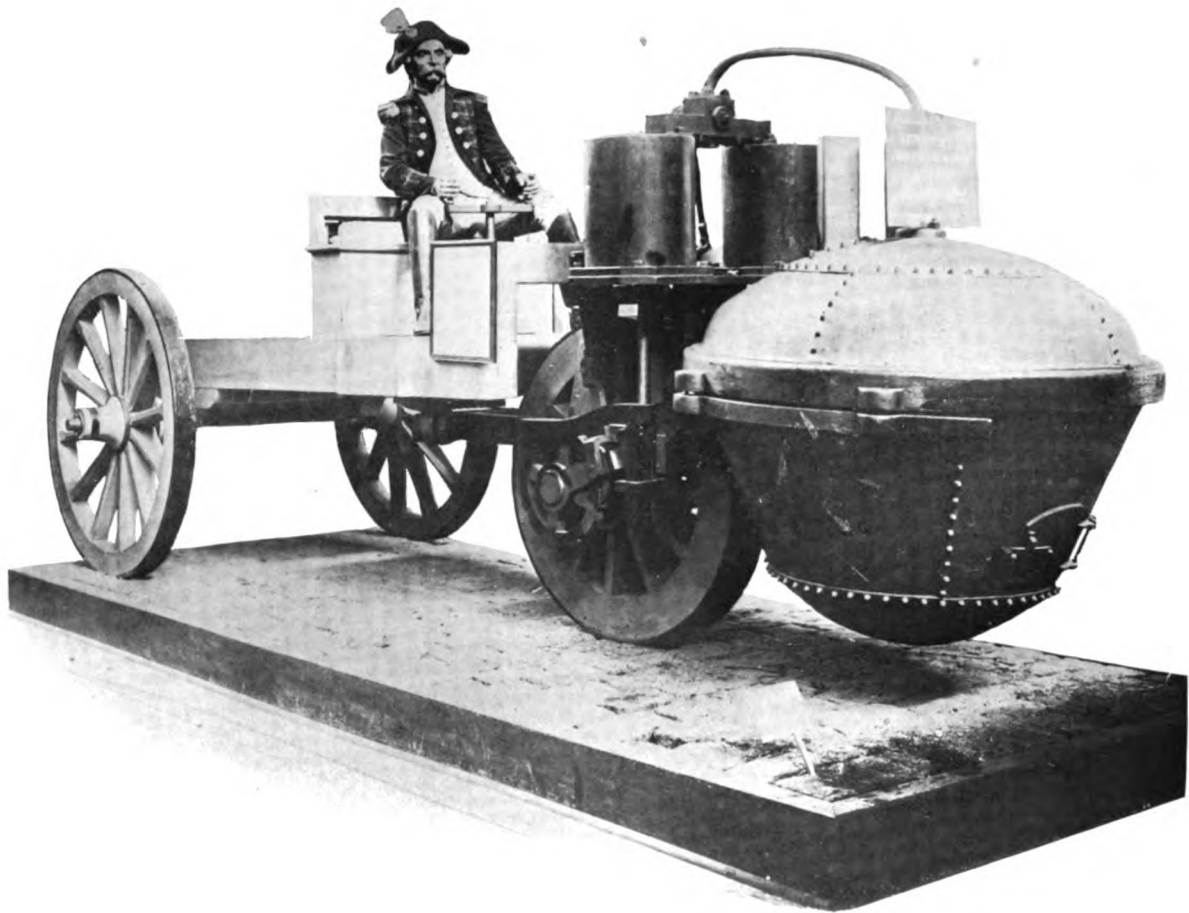

FIRST AUTOMOBILE EVER CONSTRUCTED—PHOTOGRAPH OF FULL SIZE MODEL OF THE THREE-WHEELED STEAMER BUILT BY NICHOLAS JOSEPH CUGNOT IN FRANCE IN 1769, ON EXHIBITION AT THE WORLD'S FAIR. THE ORIGINAL MACHINE EXISTS IN A GOOD STATE OF PRESERVATION IN THE CONSERVATOIRE DES ARTS ET METIERS IN PARIS.

This device consists of a pair of bent sheet-metal wings mounted outside of the backs of the tonneau seats in such a way as to catch the air and deflect it from both sides toward the central space at the back of the tonneau. The air thus directed catches the dust which would otherwise come over the back of the tonneau and drives it astern.

The Graham Company shows a number of samples of its supplementary spiral springs, used to ease the small road jars. They are applied to any automobile in place of the shackles connecting the ends of the rear springs with the spring hangers, and have a range of about 1 1/4 inches. They are intended to close down solid just about the time that the leaf springs begin to feel the load, and consequently they absorb all the minor shocks, which make little impression on the main springs.

The Electric Vehicle Co. shows a heavy stake truck with underslung battery and Westinghouse motors suspended according to the Maxim patents. The two motors are fixed to a swinging frame hung from the body and carrying in rearwardly projecting brackets a pair of countershafts, one for each motor. From the outer ends of these countershafts sprocket chains drive the rear wheels, and radius rods are interposed between the axle and frame close to the countershafts. The rear springs are semi-elliptic, and separate radius rods are employed between the axle and the main frame to

guide the former. A delivery wagon chassis is also shown, which, though a good deal lighter than the stake truck, is of quite similar character. Two regular broughams, one victoria and one surrey, the latter two vehicles being constructed with reach rods between the axles, complete the exhibit, which does not include any gasoline cars.

The Studebaker Mfg. Co. shows four electric runabouts, with Hercules running gear and Westinghouse motors. Two of the runabouts are equipped with tops. One "General" gasoline runabout is shown, and a charging plant, comprising an alternating current motor coupled to a direct current generator, completes the exhibit.

The Duryea Power Co. shows a three-wheeled hansom cab, operated from the rear. It is steered by a sort of bicycle handle-bar, twists of whose handles control the throttle and brake. A four-wheeler, with one lever control, of the familiar Duryea pattern, is also shown, likewise a motor and transmission gear, separately mounted for inspection. A Duryea wagon of the date of 1895 attracts much attention.

The Ford Motor Co. shows a runabout, tonneau car, and chassis, all of the standard 8-horsepower design, with the company's "double opposed" horizontal motor. A motor is also shown in partial section, exhibiting the arrangement of the valves and connections.

The Cadillac Automobile Co. shows only its Model B machines, brought out this year. These comprise a runabout, touring car with tonneau, surrey, delivery wagon, and a chassis, all of 8-horsepower. The Model B machine has a number of interesting features, notably the pressed steel frame and the pressed steel front axle of girder shape, with transverse front spring. The radius rods are tubular and have ball-and-socket joints at both ends. Among the minor details it may be noted that the battery switch is connected with the oil cock, so that closing the former opens the latter, which, therefore, cannot be forgotten. In somewhat similar fashion the operator is protected against the consequence of his own carelessness in attempting to crank the motor with the spark advanced. A guard connected with the spark advancing mechanism obstructs the hole through which the starting crank must be inserted, unless the spark is fully retarded.

The Geo. N. Pierce Co. shows one "Great Arrow" four-cylinder car of 24-horsepower, one stanhope of 8-horsepower, and one doctor's runabout, which is substantially the stanhope with a closed body for use in bad weather. A stanhope chassis is also shown, in which the extreme simplicity and directness of the transmission mechanism are clearly seen.

The E. R. Thomas Motor Co. shows one of its three-cylinder, 24-horsepower touring

cars, handsomely painted in white, with side baskets and complete equipment for touring.

Thomas B. Jeffery & Co. show a full line of Rambler gasoline cars, comprising a single-cylinder runabout, single-cylinder touring car, single-cylinder delivery wagon, and two two-cylinder touring cars, one without the tonneau. These machines follow accepted lines of runabout and light touring car design in most respects. The inlet valves are mechanically operated. The planetary system of change gears is used, and the outboard end of the engine shaft beyond the planetary gears is supported in a bearing attached to a side member of the frame. The engine itself is hung on dropped cross members of angle steel. One rather neat detail observed about these machines is the method of holding down the cover of the carbureter float chamber. Instead of being screwed down or held by a slotted lug and a thumb screw, it is held with no screws whatever, by a bent wire in the form of a U, with the ends curled inward and downward. These ends rest in a circular groove in the cap, and the bottom of the U, which is nearly square, springs under the bottom of the float chamber.

The Packard Motor Car Co. shows a Model L tonneau, a Model F tonneau, and a limousine, Model K; also Model L polished chassis. The Model F car, *Old Pacific*, which made the trip across the continent last year with Tom Fetch at the wheel, is also in the stand, its rear wheels looped with chains and all the stains and scratches of its long journey still upon it.

The Knox Automobile Co. shows a single-cylinder light tonneau car, a double-cylinder tonneau car with canopy top, and a double cylinder chassis, in which the character and arrangement of its characteristic porcupine air-cooled motor is plainly in evidence. A crankshaft and planetary gear of the single-cylinder car, and also a Lemp steering check, such as is used on all the Knox cars, are shown mounted separately.

The White Sewing Machine Co. shows three of its well-known steam touring cars, finished in different colors. Two of the cars are of the 1904 model, and one of the improved 1905 type, which in general appearance closely resembles a gasoline car. Another exhibition is the White steamer which won honors in the memorable endurance run to Pittsburg in 1903, and also in the recent tour to St. Louis.

The Winton Carriage Co. shows a two-cylinder touring car and a chassis, both of the 1904 model.

The Olds Motor Works show no less than eleven vehicles of all sorts in their exhibit, the regular models being as follows: One standard runabout, with the motor partially cut away to show the action of the piston and valves; a runabout with folding top and storm apron; a runabout

with dos-à-dos seat behind; a touring runabout, with the tanks under a front bonnet; a tonneau touring car with canopy, and two delivery wagons. In addition, the transcontinental runabout, piloted by L. L. Whitman and E. J. Hammond, is shown, and likewise a specimen for the antiquarian, the first Oldsmobile, built eight or ten years ago. It is a surrey, almost as high as an omnibus, with a single-cylinder horizontal gasoline engine under it which must have made it nearly as fast. The Olds vehicles this year follow the general fashion in having enclosed hub brakes with internal expanding rings. The differential is larger than last year, and is of the spur gear type. The touring runabout and touring car have worm steering gear, but the little standard runabout retains the tiller.

The H. H. Franklin Mfg. Co. shows one runabout and one tonneau car, both of the 10-horsepower size, with the familiar four-cylinder Franklin air-cooled motor.

Near by is seen Major Davidson's latest automobile gun-carriage, a photograph of which was published in our issue of June 4. It is loaned by the Northwestern Military Academy, Highland Park, Ill.

Grout Brothers show one of their 7 1-2 horsepower steam runabouts, a runabout with surrey seat added, and a runabout chassis. This able little machine has a horizontal motor suspended horizontally with its crankshaft directly over the rear axle, which it drives through a short sprocket chain. The rear end of the engine is supported on the axle by short adjustable radius rods, and the front end on a hinge at

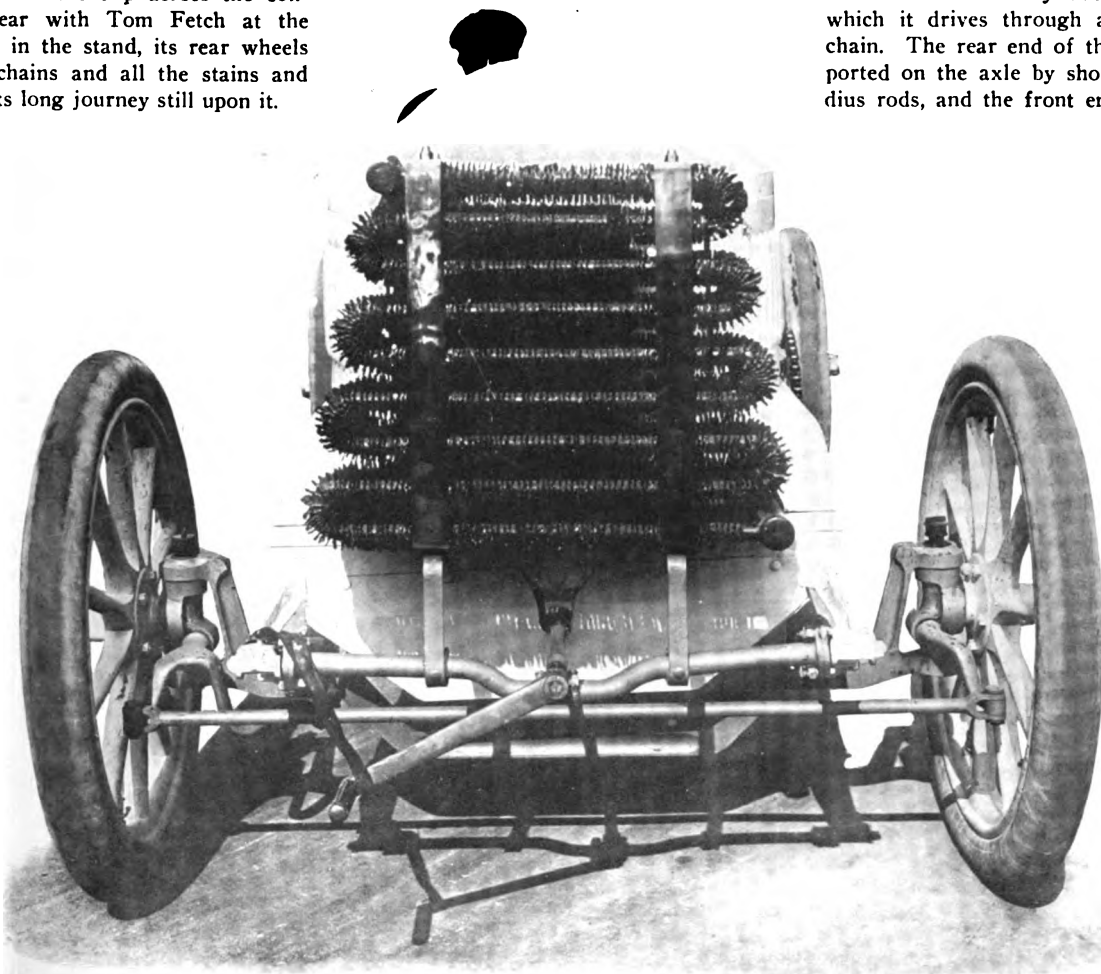

A MODERN RACING AUTOMOBILE—DOG'S EYE VIEW OF THE BIG DE DIETRICH PARIS-MADRID CAR.



Elwood Haynes's First Car Built in 1893.

the back of the boiler, flexible steam and exhaust connections providing for movement due to the play of the springs. The main fuel tank is not under pressure, the gasoline being forced by a small pump, worked from one of the crossheads, into a pressure tank on its way to the vaporizer. A compression spring in the pump plunger automatically limits the effective action of the latter to times when fuel pressure is required. The power feed pump is worked from the other crosshead. The throttle is controlled by a lever under the steering wheel, and pressure on the brake pedal automatically closes the throttle,—an important improvement. The frame is ash, reinforced by steel fitch plates.

The Vehicle Equipment Co. shows two standard broughams, a hansom cab, delivery wagon, stake truck, and one rear-operated victoria, all having the characteristic pedestal running gear, which distinguishes the product of this firm.

The Waltham Mfg. Co. shows one Orient buckboard, with parcel delivery box attached. The Orient buckboard needs no introduction to our readers.

Saks & Co. show a very complete line of automobile garments for both sexes, including cravenette and rubber coats and caps. A new feature about the rubber coats is the construction of the sleeves, which, inside of the regular ends, have inner ends with elastic wristbands to close them snugly about the wrist. A variety of goggles, caps, and horns are also shown.

A. L. Dyke shows a large line of supplies, parts and tools, including tires, wheels, sprocket-chains, speed changing gears, boilers, jacks, lubricators, burners, lamps, and automobile clothing.

The Twentieth Century Mfg. Co. shows the Twentieth Century gas and oil lamps and generators.

The Motsinger Device Co. shows a number of Autosparkers in operation by a large flywheel.

The Veeder Mfg. Co. shows a full line of its revolution counters, cyclometers, odometers, and liquid centrifugal tachometers, many of the exhibits being shown in action. Some of the Veeder Co.'s fine castings for typewriters and similar machines are also shown.

The Badger Brass Works Co. shows two

glass cases of the Solar gas and oil lamps, including two "Phares Solar" of uncommon size.

Gray & Davis show a full line of gas and oil lamps, including their new Bullet headlights.

About midway between the American and French sections, at the eastern end of the Transportation Building is a model of the

historic Cugnot gun carriage, the first automobile that ever ran. It is the same size as the original, and a very lifelike effigy represents the French military officer who drives it. It is perhaps the most interesting of a number of models of early vehicles, chiefly locomotives, which comprise one of the features of the Transportation building.

Foreign Sections at the World's Fair.

It is in the French section, naturally, that the American observer will find the largest number of novelties. Many of the machines are already familiar to our readers, but others are not, and in several instances it seemed worth while to obtain quite full descriptions of the more important

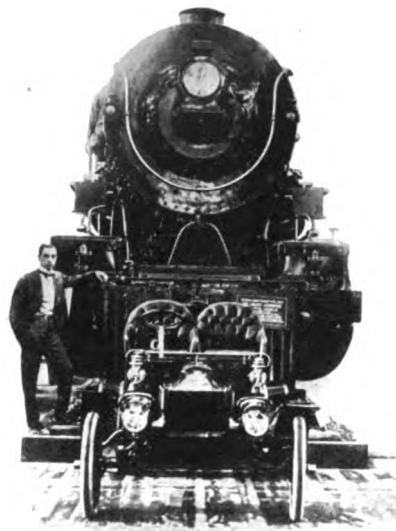

Oldsmobile Runabout in Front of the Biggest Locomotive in the World.

machines. Not all of the exhibits, however, were of 1904 date, several concerns sending over last year's cars. This naturally was especially apt to be the case with body builders, who exhibited their styles on any chassis convenient.

At the De Dietrich stands are shown five cars and one chassis, besides a racing launch, the *Pi-Ouit* (Peewit) II., with a De Dietrich motor of 24 horsepower, and a speed of about 16 miles per hour. Of the cars, perhaps the Paris-Madrid racer, of 55 horsepower, driven by Chas. Jarrott in that event, attracts as much attention as anything. It resembles recent French racers in having the lines of the body carried back as continuously as possible from the huge bonnet. The driver sits right on the floor of the car, and behind him are the gasoline and water tanks, having smooth outer surfaces, tapering to a rounded wedge form at the rear. Underneath the car is a metal pan enclosing all the parts, and giving a smooth passage to the air. The car is driven by two chains, but the sprocket-wheels on the countershaft are as large as those on the rear wheels, so that there is no reduction of speed. The

frame is of armored wood, and the front axle is a drop forging planed away between the spring seats to a slight suggestion of the I-beam design. A neat detail is the arrangement of the filling plug for the gasoline tank. This plug is very large, and is located at the bottom of a fixed funnel about 8 inches in diameter, in the top of the tank. This permits the gasoline to be poured in very rapidly.

The separate chassis is of the 1904 model, and has a number of details of interest. The frame is of pressed steel in channel form. No false frame is used, but the motor is supported on a pair of short pressed steel channels lying fore and aft, hung from the front transverse member, and integral with another transverse member just back of the flywheel. The gear box, like the Panhard gear box, is very long, is hung from two dropped pressed steel channels at front and rear. Between the clutch shaft and the first gear shaft is a short shaft with universal joints at both ends. The engine, which is of 35 horsepower, has the cylinders cast in pairs, with integral heads and water jackets. The inlet valves are located exactly as in the Mercedes engine, over the exhaust valves, and are like them operated mechanically by cams and rocking levers. Both inlet and exhaust cams are on the same shaft, and the inlet valves are very large, although not annularly slotted like the Mercedes. On a corresponding shaft on the other side of

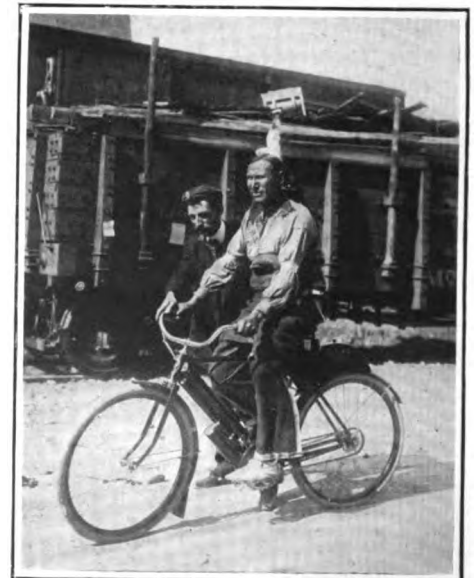

the engine are cams working the contact igniters through light levers. The spark is timed by a spiral sleeve connecting this shaft with the gear which drives it. By shifting the sleeve along this shaft, the latter is rotated with respect to the gear. A Simms-Bosch magneto is used. It is so powerful that no battery is required for starting, a magneto speed even as low as that given by turning it by hand being sufficient to give a fair spark. The current is led to the insulated electrodes of the igniters from an insulated brass rod or bus bar mounted on

valve lever, which is normally held in the closed position by a spring, but is drawn to the open position by the tension of the governor spring when the engine slows down. The hand control lever acts to hold the throttle open. In addition to this there is a connection from the clutch pedal to the throttle lever which pushes the throttle partly shut against the governor when the clutch is released, thus compelling the engine to slow down. The clutch spring shows a departure from common practice in being made a stationary member entirely outside

The rear wheel brakes are of the enclosed expanding type now fashionable. They are supported on the rear axle, and the reducing rods are of unusually rational form, designed to resist both the twisting effect of the brakes on the axle and the pull of the chain. They are of triangular form, pressed from sheet steel, with the base of the triangle attached to the fixed members of the brakes. They are perforated with a number of holes, and the top and bottom edges are flanged over for stiffness. The gasoline is carried in a tank at the extreme rear of



Australian Bushman Rounds Up the Ostriches for Inspection. Among the Totem Poles at the Alaska Exhibit.

Sioux Chief and His Family in Col. Cumming's Wild West. Baby Elephant on the Pike Tries to Gobble a Lamp.

TOURING THE SIGHTS, ON THE PIKE AND OFF, INSIDE THE GROUNDS AT THE WORLD'S FAIR.

the engine, with which four pairs of spring clips make contact. Slotted fiber sleeves are arranged in connection with these clips in such a way that by giving the sleeves a half twist the current may be shut off from any cylinder at will for the purpose of testing the others. The arrangement for controlling this engine is a little out of the ordinary. The governor acts on the throttle

of the clutch. It is above the clutch shaft and attached at one end to a cross member of the frame, the other end being connected to the clutch pedal lever. It therefore imposes a constant end thrust on the clutch, which must be taken up by a ball thrust bearing which is in constant action when the clutch is engaged. On the other hand, it is very readily disconnected.

the frame, and is fed to the carbureter by the pressure of the exhaust gases, a relief valve being provided to avoid an excessive pressure. To start the motor after filling the tank it is evidently necessary to feed gasoline by some other means. This is provided for by a small gasoline cup on the dash, connected with a standpipe, also on the dash, by which the main gasoline tank is

filled. The gasoline is poured in until it rises in the small cup, which indicates that everything is full. Then a cock is closed between the cup and the main gasoline pipe, and the gasoline from the cup allowed to flow by gravity to the carbureter. As soon as the motor starts a pressure is created in the tank which thereafter keeps the carbureter filled. The only objection to this arrangement would seem to be the need of a rather large pipe from the standpipe back to the tank, which might, under some circumstances, lead to broken joints and leakage.

The *Pi-Quit II*, reversing gear is evidently made from a good-sized differential. A short cardan shaft is interposed between the thrust-bearing and keel-stuffing box, and the thrust of the screw is transmitted through the universal joints. The propeller has three blades, and is carried a good deal below the keel. An examination of the under-water body shows that the stern is of the conventional form, with an exceedingly flat V section. The forepart of the hull is practically a wedge, with rounded bottom edges merging into the conventional flat section amidships. The draught is about uniform for the first half of the length, and then slopes upward to nothing at the transom.

Of the complete cars at the De Dietrich stand, one is an omnibus, seating about ten passengers. It has solid rear tires, and the spokes of the wheels enter metal thimbles threaded into the felloe, by screwing which the spokes

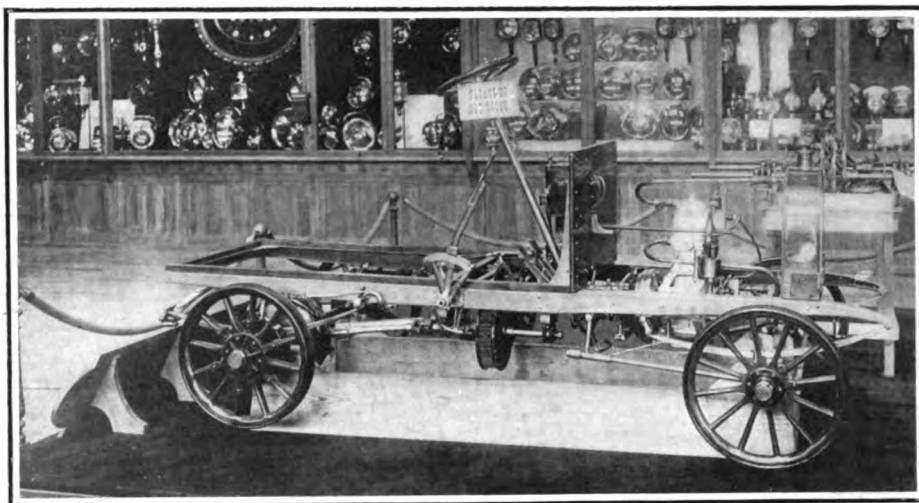

FIRST APPEARANCE OF THE FOUILLARON CAR AT AN AMERICAN SHOW—NOTE TRANSVERSE BELT TRANSMISSION BETWEEN THE STEERING PILLAR AND SIDE LEVERS.

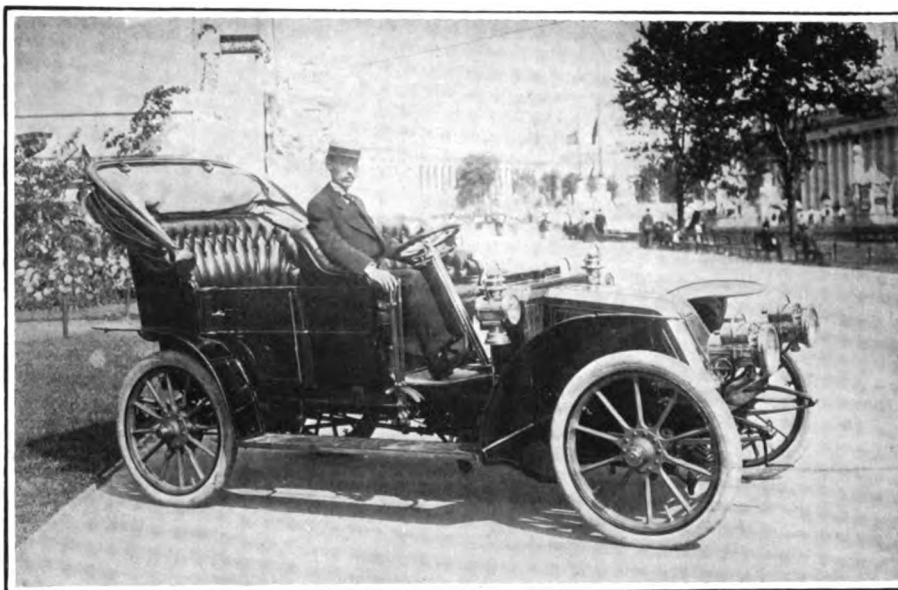

LATEST MODEL RENAULT DOUBLE PHAETON WITH SIDE ENTRANCE AND HOOD AND EQUIPPED WITH THE NEW STYLE OF RADIATOR.

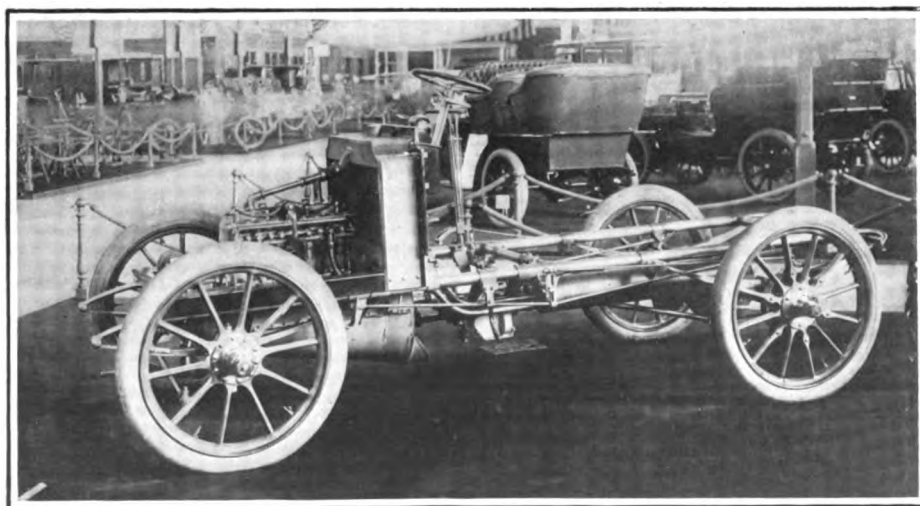

CHASSIS OF RENAULT TOURING CAR IN SMITH & MABLEY STAND IN THE FRENCH SECTION—NOTE POSITION OF RADIATOR IN FRONT OF DASH.

may be tightened. A limousine body by Rothschild is very handsome in design and finish. It has a folding child's seat back to back with the driver's seat, and of course within the glass front. Entrance is from the side. Among the appointments is a speaking tube having an inner flexible end, and at the outer end a bell mouth fixed over the driver's head. Under the top are stretched silken cords fastened at intervals, which serve to hold papers and small parcels. A large tonneau touring car also has a Rothschild body. Both of these machines,

like all the others except the chassis, appear to be of 1903 design mechanically. The last car, with body by Audineau-Martin, is without doubt the most elegant exhibited at the Fair. It is a rear entrance berline of unusual size and richness of design and appointment. Its four separate inside seats are swivel chairs, one in each corner, and on each side between the chairs is a small desk with drawers and parcel space inside. At the front is an electric signalling device for the operator, with eight or ten buttons corresponding to different directions, such as "turn right," "turn left," "slowly," "go home." The general color scheme is green and olive. The body, upholstery and carpets are in different shades of green. The curtains are olive and greenish yellow, and the desks and interior woodwork are in the natural wood and inlaid.

At the Panhard and Levassor stand no striking novelties are shown, the most in-

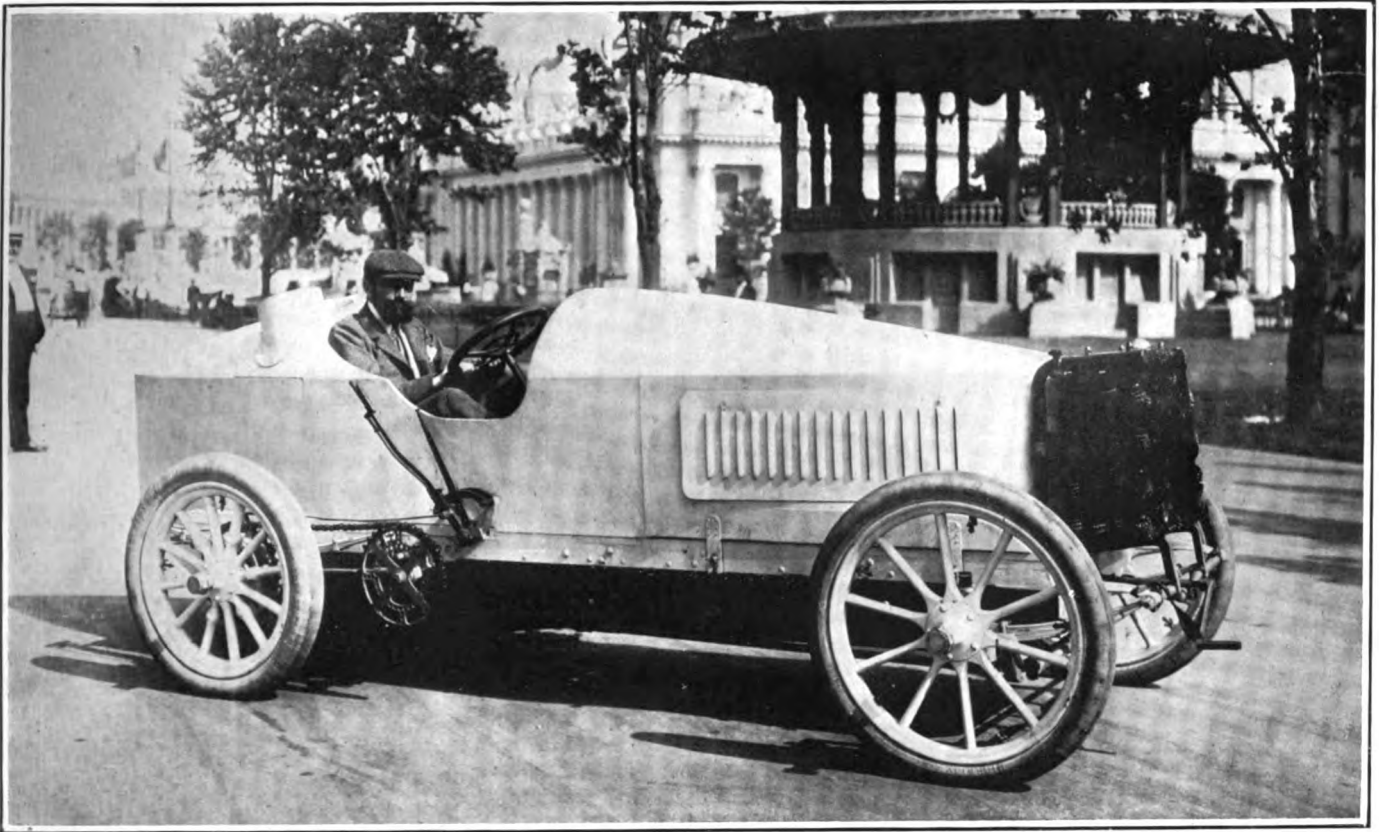

M. COSTIGLIOLE AT THE WHEEL OF THE DE DIETRICH RACER THAT JARROTT DROVE IN THE PARIS-MADRID RACE.

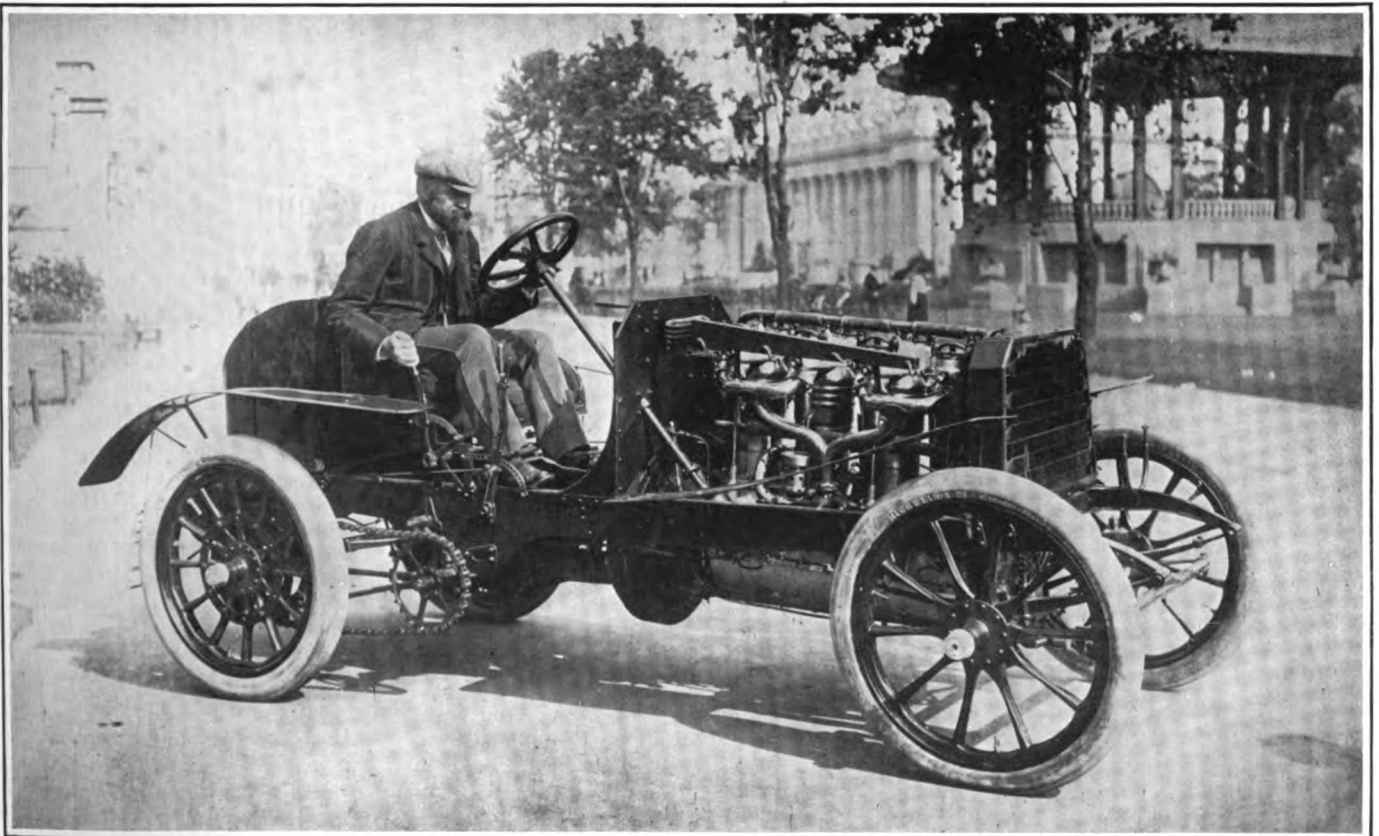

M. FAIVE IN THE DRIVER'S SEAT OF THE PANHARD CAR THAT RENE DE KNYFF PILOTED IN THE IRISH GORDON BENNETT.

teresting machine being the Irish Gordon-Bennett racer driven by René de Knyff. This navy-blue 70 horsepower car is of rather ungainly appearance, which is due mainly to the fact that the motor shaft, instead of being horizontal, slopes downward a great deal toward the front, apparently with the idea of getting the weight as low as possible. The gear box is quite unlike the standard Panhard design, the cross counter-shaft being at its front end underneath the clutch shaft. Apparently three forward speeds and a reverse are provided. The pressed steel channel side members are given a peculiar appearance by large lobes extending downward to carry the shaft bearings. The driven member of the clutch is conical, and appears to be squeezed between the flywheel rim, a conical flange of which is inside the driven member, and an outer and surrounding conical rim attached to a web and moving with the flywheel. The clutch is released by drawing back the outer member.

Two double phaetons with side entrance are shown, one of 35 horsepower, its engine having copper water jackets similar to those of the 70 horsepower racer, and the other of 24 horsepower with integral cast water jackets. Both of these engines have mechanically operated inlet valves opposite the exhaust valves. The larger machine has a body by Kellner, with a rack projecting from the rear for the support of touring hampers. The smaller car has a body by Labourdette, with a victoria top over the rear seat. A light delivery wagon of about 10 horsepower, with pneumatic tires, is also shown.

A Panhard boat motor, apparently of 30 horsepower, is shown ready to be installed.

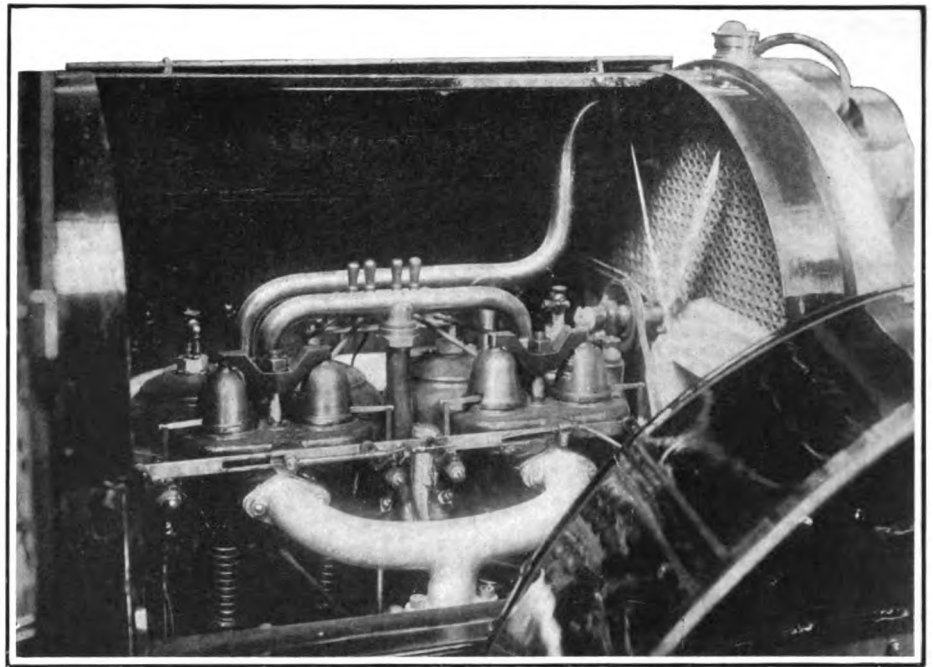

LOOKING UNDER THE BONNET OF THE HOTCHKISS CAR IN THE FRENCH SECTION.

The flywheel is at the rear end of the motor and drives through a friction clutch. At the front end is a wooden A frame, at the top of which is the starting crank, acting through a sprocket chain. Inside of this frame are the spark coil and magneto, the latter being driven by bronze skew gears from the cam shaft gear. On the front face of the magneto is a horseshoe-shaped fiber mounting, carrying the distributor for the secondary current. The spark is timed by a double lobed cam at the front end of the magneto shaft, making two contacts per revolution of the magneto, or one at the

proper time for each cylinder. The distributor consists of four fingers bearing on a revolving fiber barrel with an inlaid metal segment. This barrel is driven by brass gears from the magneto shaft. A single spark coil is used, the distributor sending the current to one cylinder after the other in order.

The spark timing is changed by a spiral sleeve connecting the armature shaft and its gear. Shifting this sleeve rotates the armature shaft with reference to the gear and rotates also the gears actuating the distributor. The motor is supplied with an ordinary (not Krebs) carbureter and governor without accelerator. The inlet valves are automatic and located over the exhaust valves.

The Renault exhibit under the auspices of Smith & Mabley comprises a tonneau and a limousine car, both of 1903 models, and two chassis, one of last year and one of 1904. The last-named chassis, which perhaps presents the finest specimen of refined workmanship and up-to-date design in the Show, embodies several features described in these pages last April 30. Chief among them is the location of the water radiator next to the dash, and the use of an air-tight bonnet and a flywheel fan in such manner as to draw the air first through the radiator outside of the bonnet, then back again between the radiator and the dash into the interior of the bonnet, after which the air is discharged downward and back through the fan blades on the flywheel. The frame of the Renault is of steel tubing, as usual, and in the larger cars the side members are trussed. The rear axle is steadied against stresses due to driving and braking by two radius rods, whose front ends pivot at a common point in a spring socket attached to the frame, and extending backward, one to the top and the other to the bottom of the case surrounding the bevel gears. Thus

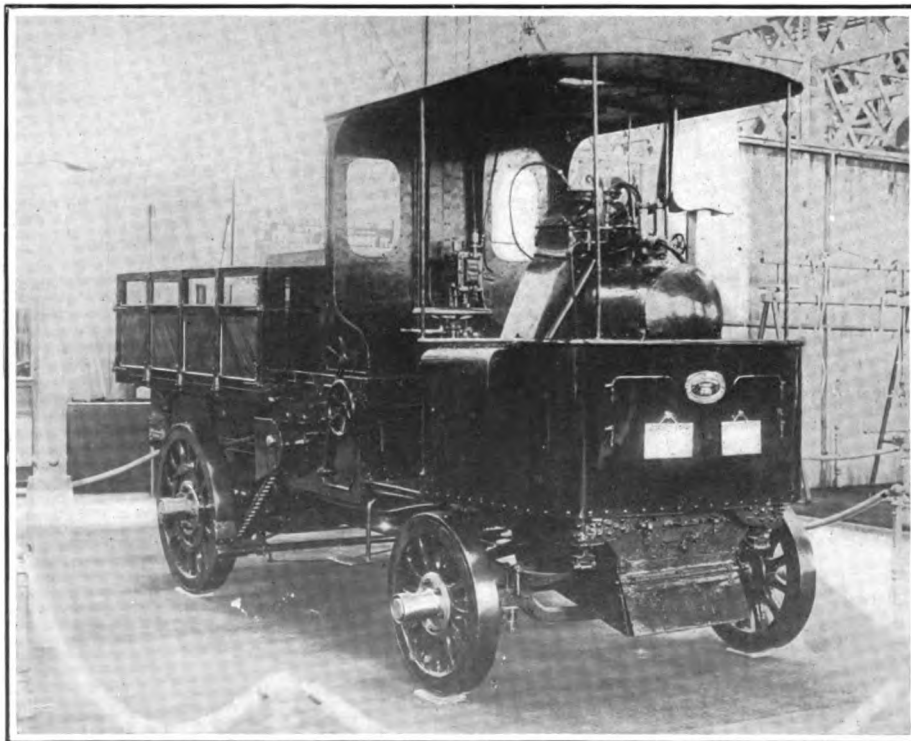

TURGAN-FOY STEAM TRUCK—ONLY HEAVY COMMERCIAL VEHICLE IN FRENCH SECTION.

GROUND PLAN OF THE LOUISIANA PURCHASE EXPOSITION IN SAINT LOUIS (COVERING 1,240 ACRES) SHOWING THE LOCATION OF ALL THE BUILDINGS—AMERICAN AND FOREIGN AUTOMOBILE EXHIBITS ARE CONTAINED IN THE TRANSPORTATION BUILDING IN THE MIDDLE FOREGROUND.



one of the rods is always in tension. The service brake is located at the front end of the short bevel driving pinion shaft, instead of close to the gear box as ordinarily. It is encased, and is operated by the torsional movement of a tube extending back from the brake pedal.

The inlet valves in this and last year's model are mechanically operated, and the lift of these valves is regulated by a device precisely similar to the De Dion exhaust valve regulator. The inlet valve cams act on rollers at the ends of short oscillating fingers, and these fingers are pivoted at their other ends to short arms connected with a rocking shaft controlled by hand. As this shaft is rocked the fingers are moved to or from the cams, and the effect is that they receive from the latter a greater or less oscillation. Thus the motor is retarded independently of the governor.

The Renault carbureter has one fixed inlet, which takes hot air from near the exhaust pipe, and a much smaller cold air inlet which is governed by a shutter regulated by hand. The governor control comprises a cylinder shutter which throttles the mixture and is acted on in the regular way by the governor. The accelerator pedal when pressed down pulls this throttle valve open, and in this position the governor lever merely compresses a spring which connects it with the throttle valve stem. The governor is fully encased, and in fact all of the working parts of the motor are protected from dust as thoroughly as possible. The cylinders are cast in pairs with large hand-hole at the top of the water jackets, which are covered by brass caps held down by studs.

Ignition is by magneto, which is driven by a shifting spiral gear to vary the time of the spark. The steering mechanism comprises a bevel gear at the base of the steering shaft, meshing with a bevel pinion fast to a nut which turns on a steep-pitch horizontal screw connected through a link to the right-hand steering knuckle.

An inspection of the Hotchkiss car exhibited by Kellner showed that it has a pressed steel frame, which is out of the ordinary in that the side members are trussed. Transmission is by shaft drive, and there are long radius rods at the sides, both ends of the rear springs being in shackles; but the springs are not protected against the tendency of the rear axle to rotate forward under the application of the brakes. No false frame is used, both engine and gear box being supported by wide wings cast on the bottom halves of the crank and gear cases, extending up to the main frame. There are four forward speeds and the drive is direct on the fourth. The gear shaft appears to run in ball bearings. A sheet-metal pan extends under the engine and gear box, terminating just back of the service brake, which is of unusual size. The clutch is conventional in form, and its spring is enclosed within the long rearwardly projecting hub sleeve at the end of which two lugs engage a sort of floating ring about

$2\frac{1}{4}$ inches wide, whose rear face has two corresponding notches 90 degrees around from the first two, which are engaged by other lugs at the front of the first gear shaft. This provides the equivalent of an Oldham coupling. The rear brakes are of the enclosed expanding type, and are applied by a compensating wire cable tightened by pulling up a side lever, instead of pushing it as usual. The rear springs are of the platform type.

The engine, which appears to be of about 24 horsepower, has cylinders cast in pairs with mechanically operated inlet valves opposite the exhaust valves. Ignition is by primary contact spark, and the

universal joint just back of the gear box, is still retained. The latter cars, however, have radius rods at both ends of the rear axle. Ignition is by magneto, and the construction of the contact sparkers is unusually simple. Snap cams are used, with their snap faces beveled just enough to permit them to turn backwards without damage, and the push rods on which they act terminate in adjustable buttons, which midway of their return movement strike the fingers of the movable electrodes, thus causing the latter to break contact inside the cylinder.

The cylinders are cast separately with the heads of the water jackets open. The inlet valves are mechanically operated and located opposite the exhaust valves, interchangeable cam shafts being used. The walls of the valve chambers project upward flush with the top of the water jacket, and brass water jacket heads are used, which are cut out to slip over the valve chamber walls, with which a watertight joint is made by threaded screw rings and gaskets. The tops of the valve chambers are closed by large screw plugs. The carbureter is automatic, the auxiliary air inlet being controlled by an automatic valve. The fixed opening is readily adjustable by a shutter.

One Darracq tonneau touring car of 20-horsepower is shown. It is a duplicate of the 20-horsepower car with which F. A. La Roche made his non-stop run to St. Louis. It is of this year's model and contains the up-to-date features which have been referred to in these pages at various times. The pressed steel frame is of the ingenious one-piece construction which attracted so much notice at the Madison Square Garden Show last January. Three forward speeds with direct drive on the high gear are given, and all the gear shafts run in ball bearings. All the brakes are of the enclosed expanding type, and are operated by a powerful cam action. The inlet valves are mechanically operated and opposite the exhaust valves. The governor is on the crankshaft instead of on the time shaft as usual, and this makes a very compact construction on account of the high-shaft speed.

In the Mors exhibit are shown a victoria top double phaeton, a tonneau with very high seats of rather ungraceful design, a coupé seating two passengers inside, and two on the front operator's seat, and a bus or depot wagon seating four passengers inside. The last-named vehicle is provided with a swinging glass front. The Mors machine which is already familiar to our readers, is of very workmanlike but quite conventional design, with mechanically operated inlet valves, contact spark, two-chain transmission, and direct drive in the gear box on the fourth speed, the arrangement in this respect being the same as has been used for two years past.

Two G. Richard-Brasier cars are exhibited. These cars, which have already been described in these pages, have automatic inlet valves in the smaller powers,

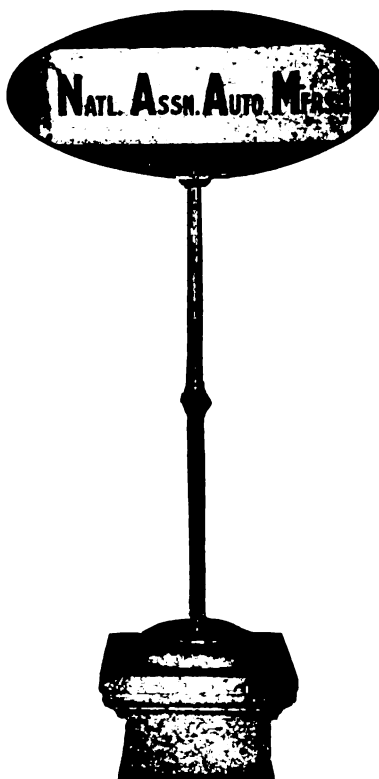

N. A. A. M. BRASS SIGN AT THE FAIR.

details are a little out of the ordinary. Both the insulated and the movable electrodes are contained in a plug, which is located just over the inlet valves and is held in place by a bell quite like that which holds in place the inlet valve cage of the De Dion motor. In the Hotchkiss car, however, the bells are held down two and two by yokes and studs. The timing of the spark in each cylinder is adjustable separately from the others.

Three tonneau cars of various sizes are shown by A. Clement; also one 30-horsepower chassis. These cars have pressed steel frames and motors of two or four cylinders, according to the power. With the lower powers the transmission gives three forward speeds, and with the higher powers four forward speeds, the high gear being direct in both cases. The most characteristic feature of the Clement "Bayard" cars, the propeller shaft with a single

and mechanically opened valves in the larger sizes. They have three and four forward speeds according to size, but do not give direct drive in the higher gear. These cars are among the lightest of French cars for their horsepower, and are correspondingly efficient, while at the same time they avoid extremes in design.

A complete exhibit of Aster motors is shown, including motors for automobiles, boats, and stationary work, all of them of practically the same high speed type. They range in size from 2 3-4 horsepower single cylinder, air cooled motor, up to a 30-horsepower four cylinder engine. The cylinder sizes of the latter are 4 1-4 inch bore by 5 1-2 inch stroke. The smaller motors have automatic inlet valves, and the large ones mechanically opened valves. All of them are fitted with Longuemare carbureters, with the Aster automatic attachment. The latter is quite similar to the Krebs auxiliary inlet governed by a diaphragm, the Aster device having a spring instead of the diaphragm.

For cruising launches these motors are geared down about 2 to 1 and reversed by sliding gear, just aft of the motor. For racing boats, the drive is direct. A 6 1-2 horsepower single cylinder boat motor is shown with a Meissner patent reversing propeller. This propeller is quite similar to many American contrivances of the same sort, but the reversing hub is completely enclosed. The two blades are wide near the hub and taper considerably toward their ends. A little direct coupled motor and dynamo are shown, the outfit developing 13 amperes at 120 volts, the speed being 1,500 r. p. m. A 4-cylinder motor of 20 horsepower with an Aster kerosene or crude oil attachment to the valve chamber is expected to be added shortly.

A steam truck by Turgan Foy is among the vehicles new to this country, at the exhibition. It uses a normal working pressure of 220 pounds per square inch, and liquid fuel is burned. Transmission is by side chains. A compact water tube boiler is the



RAMBLER TOURING CAR AND DELIVERY WAGON AT THE WORLD'S FAIR.

principal feature of the machine, the engine being of conventional pattern.

Another machine which has been built in France for several years, but has not before found its way to these shores, is the Fouillaron runabout, with expanding pulleys. These pulleys take the place of speed-changing gears, and consist essentially of strips of metal, forming elements of intersecting cones with common axes. By bringing the bases of the cones close together the diameter at intersection is increased, and by separating them the intersection comes nearer to the apexes of the cones. A belt, built up of short cross strips of leather with beveled ends, strung or linked closely together edge to edge, runs over the two pairs of cones thus created, and its tension is kept constant, because the controlling mechanism increases the diameter of one pulley in proportion as it decreases that of the other. The machine in the exhibit has on 8-horsepower De Dion motor mounted in front with a clutch just behind it. A claw coupling of very good design, with narrow teeth, having the space between them filled with fibre blocks, is interposed between the clutch and the driving pulley. From the driving pulley the transmission is direct through pro-

PELLER shaft to the rear axle. The pulley diameters are regulated by a lever at the side. A feature of construction in which the chassis exhibited differs from previous models of this moderate priced car is that the belt drive is placed at right angles to the side frames, instead of in a fore and aft direction.

The exhibit of Kellner et ses Fils comprises four automobile bodies, one on the Hotchkiss car, previously referred to; one on a smaller 4-cylinder Panhard, and two on Renault cars; besides two-horse vehicles. The Hotchkiss car body is a saloon-limousine, with side entrance. It is a very luxurious body, seating four passengers inside, besides two on the operator's seat. There are two individual folding seats, which are located close to the doors, when the latter are closed, and which clear the doors when folded up. A speaking tube is provided in addition to the usual interior appointments of card, parcel and mirror holders, and the like. The body on the Panhard car is a doctor's hansom, arranged to be operated from the inside, so that it seats only two passengers. It has a swinging front door, which just clears the dash, and front and side windows. A luggage guard is fixed to the top, and a tool and parcel box is also provided at the rear.

Of the Renault cars, one has a "touring brougham" body, with the invariable side entrance and a low folding seat for one, facing the principal inside seat. The doors have windows, and there are narrow windows just back of the doors; but behind these are sliding shutters in place of windows. The finish is in bright yellow, trimmed with red and black. The other Renault has a landaulet body. It is similar to the limousine just mentioned, except that behind the narrow windows back of the doors is a folding leather top, which may be thrown back for fine weather, leaving the forward part of the structure with the doors and windows untouched.

Among the minor exhibitors may be mentioned Meneveau & Cie, who show samples of bonnets, oil tanks, and lubricators; Grouvelle & Arquembourg, who show circulation pumps, carbureters, and their well-known radiators of flanged tubes bent zig-

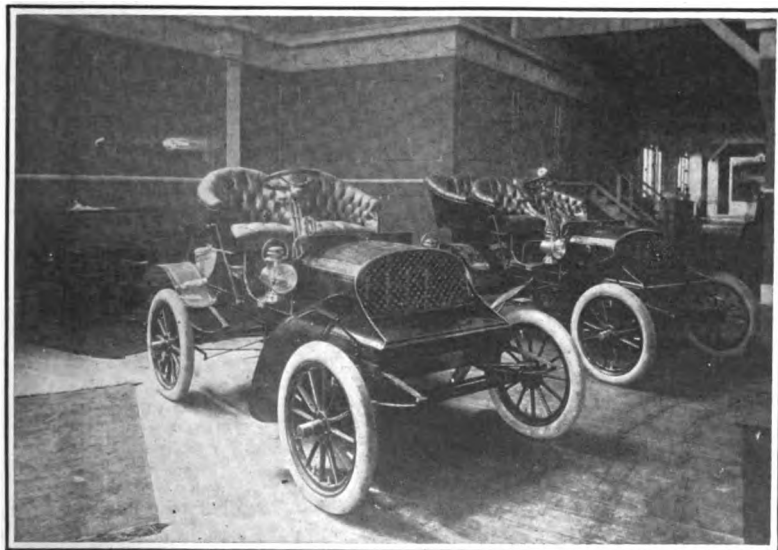

STAND OF FRANKLIN AIR COOLED CARS IN THE AMERICAN SECTION.

zag, and packed as closely as possible into peripheral brass casings; Malicet et Blin, who show numerous samples of gears, axles, and differentials, all of them well designed and of fine workmanship; Pozzy & Potron, makers of axles, springs and hangers, who show a quite surprising variety of fine work in this line, and Morel & Cie and Brosse & Cie, who show sprockets, wrenches, steel stampings, horns and sundries.

Lamps and headlights are shown by Duccellier and by Bleriot, both of whom are well known in this country.

Not the least interesting exhibit is a model of the Henri Deutsch air ship, about 18 feet long. This air ship, which already has some successful flights to its credit, is propelled by a 60-horsepower Mors engine. The model shows that the two-bladed air propeller is geared down to about 8 to 1 from the motor. The air ship is trimmed for upward or downward flight by a car loaded with bags of ballast, which is rolled forward or aft on a little truck near the front end of the framework carrying the motor and propeller.

J. Rothschild et Fils show three bodies on Mors cars. Of these, one is a limousine, with a folding child's seat back to back with the operator's seat; one is a canopy top double phaeton, and the third body is a limousine with a pair of individual folding seats, which, when in use, partly cover the doors. They are made with backs and folding legs, and when not in use they fold compactly out of the way at the sides of the body, between the fixed rear seat and the doors. They are held in either position by a stiff spring. The interior appointments are very complete, including a cigar holder, hair brush and mirror holder, and the cords under the top for holding papers and small parcels.

Another builder of bodies, Th. Botiaux, shows a King of the Belgians tonneau and a side entrance double phaeton, both on Tony Huber chassis. The latter machines, which are not well known in this country, are built with both shaft and chain transmission, and with armored wood frames and brass water-jacketed motors. Another body by the same maker, a phaeton with an upholstered "spider" seat at the rear, is fitted to a light Mors car.

Several light and low-priced bodies are shown by Philippon, the builder of the De Dion bodies. Here five De Dion cars are exhibited, four of them with six or eight horsepower single-cylinder motors, and one front entrance coupé with 15-horsepower two-cylinder motor. Of the smaller cars, one is the well-known 6-horsepower Populaire, one a side-entrance coupé, one a tonneau, and one a light spider phaeton.

A collection of shop jacks and hoists of numerous styles, hardly known on this side, is shown by H. Edeline. Many of the hoists are partly of wood, and have hooks for catching the frame at convenient points at front or rear.

Tires are shown by five manufacturers,

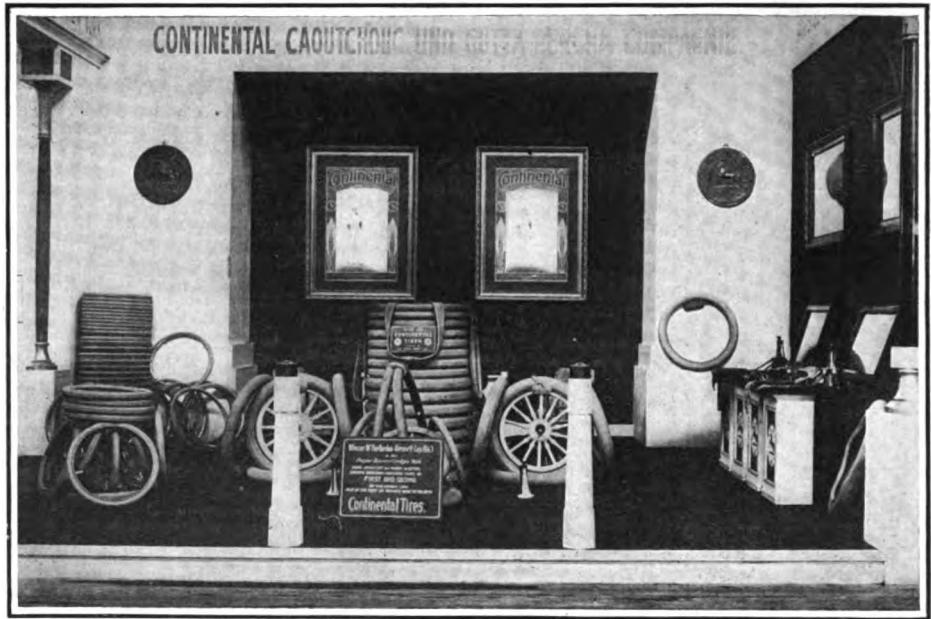

ONE OF THE FEW GERMAN AUTOMOBILE EXHIBITS AT THE WORLD'S FAIR.

including, of course, Michelin. This latter concern has an attractive case, showing tire sections, tire tools, repair kits, pumps and rubber goods in general. Falconnet & Pérodeaud show samples of their tire, which has a raised or thickened and flattened groove tread. Veuve Edeline shows the "Gallus" pneumatic tires, with thickened and flattened tread. Some of the "Gallus" tires are made with puncture-proof tread, this feature comprising a series of thin steel plates lying transversely of the raised and flattened tread. The ends of the plates are bent downward, over the edges of the tread, and are held in place by through pins, one pin to each plate. The tread is strengthened by radial plies of canvas vulcanized into it, and the pins pass through these. Bergougman et Cie show the "Gaulois" pneumatics, some with smooth treads, others with treads like those of the Bailey "Won't Slip" tire, having raised buttons of rubber closely set all over the surface. The same company shows also a miscellaneous collection of rubber goods, including gloves.

In the De Dietrich exhibit is a sample of the American Samson non-skidding tire. This is a pneumatic tire shoe with a leather tread cemented on. To this tread is riveted a second or outer tread of leather about 3 in. wide, the rivets having enlarged outer heads, like flattened cones, which take practically all the wear. It is quite common in France to put a Samson tread on one of the rear or one of the front wheels, but it would seem more rational to use them on both rear wheels, to avoid slipping of one or the other wheel through the differential. James L. Breese's 40-horsepower Mercedes car was fitted with these shoes in the climb to the clouds and also in the St. Louis tour.

Electric vehicles were represented in the French section only by two Jeantaud vehicles, one a hansom cab for two passen-

gers, and the other a coupé. The former vehicle, instead of carrying batteries under and behind the passengers' seat, as is usual in this country, carries them in a sort of house, directly over the front axle, where it serves in lieu of a dash. The weight is thus equally distributed between the wheels, and the wheel base is longer than we are accustomed to in this country, giving a distinctly more graceful design. The controller of this vehicle is very compactly arranged under the spidery seat of the operator. The rear springs are of C-shape, and the front springs comprise two pairs of flat-leaf springs, lying transversely over the front axle. The coupé carries the batteries under and behind the operator's seat, the latter being thus separated from the rounded front of the closed portion of the body by a space of 15 inches or more. The batteries are removed by taking off a side panel to which one of the mud guards is attached. The controller is not built into the body, but is mounted in plain view in a case just behind the dash. This feature arises apparently from the French practice of specialization, as the motor, controller and other electrical apparatus are supplied by Postel-Vinay. The latter concern has an independent exhibit of electrical equipment, comprising electric motors, rear axles, with motors attached, and controllers of various types.

A number of motor cycles are shown, each differing in several respects from those driven by belts, which are not tightened by idlers, doubtless because the latter absorb too much power. Some motor cycles have flat belts, others belts whose section is that of a truncated triangle, so that they run in grooved pulleys. These belts are built up of several thicknesses of leather stitched together. Most of the motor cycles have two braking systems, a brake band acting on the rear hub, and another brake, which may act on the front or rear

wheel. Some machines have brake-shoes rubbing inside the wheel rim on each side of the spokes. An interesting feature was a flexible tube, made from helical coils of piano wire, which is used in many places to guide small wire cables, by which carbureters were regulated or brakes applied. The position of the motor showed no great approach to uniformity, but low or medium height appeared to be preferred, some motors being mounted inside the frames, others as low as possible, the crank case sometimes forming a member of the frame.

Germany is represented, as regards automobiles, by the Continental Caoutchouc and Gutta-Percha Co., which shows in a decorated booth a large number of complete tires, tire sections, repair kits and tools, and the like, and by Benz & Co., of Mannheim. The Daimler Company, unfortunately, sent no exhibit.

A most interesting feature of the Benz exhibit is one of the historic Benz three-wheelers, built in the middle eighties. It has a horizontal engine of one cylinder, and the shaft, instead of being horizontal as usual, is vertical, its weight and that of the large horizontal flywheel being supported by a thrust bearing. The apparent purpose of this singular arrangement was to avoid the gyrostatic effect of the heavy revolving mass when steering. A pair of bevel gears communicate motion to a horizontal shaft, carrying belt pulleys by which a countershaft with a sprocket pinion at each end is driven. The engine is directly over the rear axle, the single front wheel therefore carrying very little weight. The wheels have wire spokes, and the rear wheels are very large, the whole affair resembling an overgrown pedal tricycle.

Besides this historical relic, two finely finished chasses of the Benz Parsifal models

are shown, one with a 2-cylinder vertical engine of 12-horsepower, and one with a 4-cylinder 22-horsepower engine. These engines have cylinders cast in pairs, with the inlet valves mechanically operated and opposite the exhaust valves. The engine and gear case are each supported by four

cast arms springing out to meet the main frame members. Propeller shaft drive is used, and the shaft runs in a case rigid with the axle, so that only one cardan joint is used. The pressed steel frames are highly finished, and the whole presents a very fine appearance.

Lists of American and Foreign Exhibits.

A COMPLETE list of the American concerns that have been assigned space in the automobile section in the Transportation Building at the Fair follows in alphabetical order:

Badger Brass Co., Kenosha, Wis.; Baker Motor Car Co., Cleveland, O.; Brooke, M. E., Denver, Colo.; Brown, W. H., Chicago, Ill.

Cadillac Automobile Co., Detroit, Mich.; Consolidated Motor Vehicle Co., New York; Cook, W. H., Chicago, Ill.

Dayton Electrical Mfg. Co., Dayton, O.; Drew, Chas., St. Louis, Mo.; Duryea Power Co., Reading, Pa.; Dyke Automobile Supply Co., St. Louis, Mo.

Eisenhuth Horseless Vehicle Co., Middletown, Conn.; Electric Vehicle Co., Hartford, Conn.

Ford Motor Car Co., Detroit, Mich.; Franklin Mfg. Co., H. H., Syracuse, N. Y.

Gray & Davis, Amesbury, Mass.; Grout Brothers, Orange, Mass.; Graham Co., The, New York.

Haynes-Apperson Co., Kokomo, Ind.; Hendee Mfg. Co., Springfield, Mass.

Industrial Mfg. Co., St. Louis, Mo. Jeffery Co., Thomas B., Kenosha, Wis. Knox Automobile Co., Springfield, Mass.; Kokomo Rubber Co., Kokomo, Ind.

Lehman Brothers, New York. Matheson Motor Car Co., Grand Rapids,

Mich.; Miami Cycle Co., Middletown, O.; Moffet Vehicle Bearing Co., Saginaw, Mich.; Motsinger Device Mfg. Co., Pendleton, Ind.

National Motor Vehicle Co., Indianapolis, Ind.

Olds Motor Works, Detroit, Mich. Packard Motor Car Co., Detroit, Mich.; Pan-American Polish Co., East Cleveland, O.; Peerless Motor Car Co., Cleveland, O.; Pierce, George N., Buffalo, N. Y.; Pope Mfg. Co., New York.

Racine-Sattley Co., St. Louis, Mo.; Royal Motor Car Co., Cleveland, O.

Saks & Co., New York; Shelby Steel Tube Co., Pittsburg, Pa.; Sintz Gas Engine Co., Detroit, Mich.; Smith & Mabley, New York; St. Louis Motor Car Co., St. Louis, Mo.

Thomas Motor Co., E. R., Buffalo, N. Y.; Timken Roller Bearing Co., Canton, O.; Twentieth Century Mfg. Co., New York.

Veeder Mfg. Co., Hartford, Conn.; Vehicle Equipment Co., Brooklyn, N. Y.

Waltham Mfg. Co., Waltham, Mass.; White Sewing Machine Co., Cleveland, O.; Winton Motor Carriage Co., Cleveland, O.; Wireless Telegraph Co., New York; Woods Motor Vehicle Co., Chicago, Ill.

FOREIGN EXHIBITORS.

The following is the complete official list of the exhibitors of machines, chassis, accessories and sundries in the foreign sections in the Transportation Building:

Benz & Co., Mannheim; automobiles. Bergougnan & Co., Paris; tires. Billy, C., Paris; lamps. Bleriot, L., Paris; headlights, lamps. Boiron, J., Paris; spark plugs. Botiaux & Co., Levallois-Perret, Seine, near Paris; coach work. Brosse & Co., Paris; motorcycles.

Clement-Bayard, Levallois-Perret, Seine, near Paris; automobiles. Continental Caoutchouc & Gutta Percha Co., Hannover; tires.

Darracq & Co., Suresnes, Seine, near Paris; automobiles. De Dietrich & Co., Luneville; automobiles, auto boats. Ducillier, G., Paris; lamps.

Edeline, L., Puteaux, near Paris; tires. Falconnet-Perodeaud, Paris; tires. Fouillaron, Levallois-Perret, Seine, near Paris; chassis.

Grouvelle & Arquembourg, Paris; radiators, fans and carbureters.

Jeantaud, Paris; electric carriages. Kellner & Sons, Paris; coach work.

Lamps Co., Paris; lamps. L'Aster Co., St. Denis, Seine, near Paris; motors. Le-



NIGHT SCENE AT THE ST. LOUIS EXPOSITION—ILLUMINATION OF ONE OF THE BUILDINGS.

moine, Paris; springs, shafts and forgings. Malicet & Blin, Aubervilliers, Seine, near Paris; differential shaft-gear box, clutch cone, pinions. Meneveau & Co., Paris; lamps, headlights and bonnets. Metropole & Liberator, Pantin; motorcycles. Michelin & Co., Paris; tires. Morel, A., Revin; steel stampings.

Panhard & Levassor, Paris; automobiles. Postel-Vinay, Paris; electric motors. Poz-

zy & Potron, Paris; springs, shafts, axles and forgings.

Renault Frères, Billancourt, near Paris; automobiles. Rheims, Auscher & Co., Paris; coach work. Richard-Brasier, Paris; automobiles.

Société Mors, Paris; automobiles. Société Philippon, Neuilly-sur-Seine; bodies.

Turgan, Foy & Co., Levallois-Perret, near Paris; heavy steam truck.

Seeing the Fair by Automobile.

By PERCY F. MEGARGEL.

TO write the experience of an automobilist at the World's Fair at the conclusion of the tour to St. Louis necessitated the possession of a permit that would permit the entrance of our car to the grounds and its use on the various highways and by-ways within. This was a more difficult matter than to secure admission on the day of the big automobile parade in the grounds, when permits were distributed broadcast. When the purpose of the trip was explained to the proper officials, however, a permit was granted to the representative of THE AUTOMOBILE of a most sweeping character, allowing the operation of the car on any thoroughfare upon signing an agreement to hold the exposition management harmless in case of any mishap. Our confidence in the *Pathfinder* and in our ability to keep out of harm's way after several thousand miles of touring was such that we readily signed the agreement, and thus armed against the verbal assaults of vigilant Jefferson guards we drove into the State Buildings entrance, and then by the most direct route headed for the Transportation Building.

In our trip through the grounds we were struck with the unusual number of electric observation automobiles in use on the thoroughfares and the crowded appearance of each. Twenty-five cents is charged for a trip about the grounds, and as each building or place of interest is passed the operator stands up in his seat and cries out the name of the structure, adding any information he may have on the subject. People from the rural districts who have never before ridden in an automobile cling to their seats in these observation cars the greater part of the day.

Another important use that the automobile has been put to inside the grounds is the carrying of the United States mail. Any one who has never visited the exposition, which covers as much ground as the Columbian Exposition at Chicago, the Paris Exposition and the Pan-American Exposition all taken together, can have little idea what a task it is to gather and distribute all the mail that is received. There are thousands of employees and tens of thousands of visitors who have their mail sent in the care of their State building or of some friend who has an exhibit somewhere on the grounds.

It is interesting to note the various means

of passenger conveyance in use at the Fair, some purely for novelty and enjoyment, and many others for the serious purpose of enabling the visitor to cover a greater distance than one could afoot in a given time. There are camels and elephants to ride, wheeled chairs pushed by careful guides, a miniature steam railroad train, boats both electric and gasoline, an air ship, the aforementioned electric automobiles, sedan chairs of the high chiefs in the "Streets of India," horses in the "Wild West," diminutive burros or donkeys in the "Oriental Streets," the great Ferris wheel, a riding ostrich in the "Ostrich Farm," the high two-wheeled vehicles so well known in "Fair Japan," gondolas on the lagoon, an electric trolley road running entirely around the grounds, clumsy but swift-moving scows on the "Shoot the Chutes," and still other means of riding slowly or swiftly as one may desire.

In taking an automobile into the grounds it is necessary to enter through the "State Buildings Entrance," at the gate of which you make out a form of permit and pay \$1. Only owners of machines can sign the permits, no chauffeurs or parties renting machines being eligible to admission with an automobile. A binding agreement is signed, making the owner responsible for all accidents, and it is necessary to fill in the number of your machine and license. The privilege of taking your auto in the grounds, however, is worth all this trouble many times over. Others in the party have, of course, to pay the usual admission.

Any one who attends the Fair with the purpose of seeing it all in one, two or three days will find out that he has undertaken a pretty difficult task. The grounds are 9,500 feet long and 6,000 feet from north to south. This means about 1,240 acres.

In running our machine around the grounds we were struck by two things that always loom up prominently at world's fairs—the great number of strange foreign people, either spectators or connected with exhibits and places of amusement in the grounds, and the general tired feeling that seemed to possess every one. Men, women and children were found sitting on the steps of buildings, on railings, barrels or other rubbish, the grassy plots, and even on the floor of some of the buildings where there was less than the usual amount

of traffic. I remember it was the same at the Pan-American Exposition and also at the Columbian Exposition, and was thankful that we possessed an automobile in which to travel from building to building, and, incidentally, when tired of indoor sightseeing, take an occasional whirl around the outer grounds. It proved very restful to all of our party and enabled us to see twice as much of the fair in the week we were there as would ordinarily be covered by persons walking.

All the buildings close at 6 o'clock in the evening, and then a "hike down the Pike" is in order. The St. Louis Fair Commissioners, thinking the term "Midway" as applied at the Chicago world's fair of '93 a trifle out of date, substituted the word "Pike." All tongues, creeds and customs are in vogue along this variegated street.

To take an automobile on the sacred Pike was something very much out of the usual, and not only needed the most careful driving after you entered the Pike, but necessitated a great amount of effort before in order to get a special permit—we only succeeding with the understanding that we were to take photographs for THE AUTOMOBILE and were to be responsible for all accidents caused.

The first place visited was the Hagenbeck Zoo. Here we had to observe the utmost caution, as the noise of an automobile was liable to excite the animals, causing trouble for the trainers when they attempted to put them through their tricks. We had no sooner entered the portals than our way was disputed by a half-grown elephant who thought we had no business on that part of the Pike at least. He lowered his head and came for our machine with fire in his eye. I thought I saw the finish of the *Pathfinder*, and am free to confess I jumped out. The trainer, however, got his iron to work about that time, and when the hook had entered the delicate ear of the little fellow (he weighed a ton) he was once more peaceful, although he insisted upon smelling the automobile all over, examining the searchlight and passing his trunk over the two extra Goodriches we had strapped on the hurricane deck.

After getting safely past the elephant, we ran around to the back of the Zoo, and here endeavored to get a photograph of some of the animals backed up against the machine, the animals, of course, inside a wire enclosure. The polar bears would have none of it, and retreated to the further side of the big den, nor could any amount of coaxing induce them to come down from the top of their plaster icebergs. The seals did not mind the machine very much, but they did dislike to get out of the water, and went scampering back every time they were poked into position for a photograph. The pelicans and other birds didn't like the automobiles, and would not remain still long enough for us to get a picture, flapping their wings and stretching their necks in signs of displeasure.

Our next visit was to the ostrich farm,

where the feather farmer admitted us through a rear gate to the enclosure, where the giant birds were loose. These birds seemed to have little use for an automobile, for they went running around the enclosure at a thirty-mile-an-hour gait. An Australian bushman then came to our aid. This queer creature was attired almost entirely in ostrich feathers, and while he kept an anxious eye on the feet of the big birds he ran among, he soon rounded them up so that we could take a good snap shot, although every ostrich was craning his or her neck up in great terror, and one big fellow managing to separate himself from the main flock ran directly toward the camera. I thought it was all up with the camera at least, but just as he was almost upon me he suddenly turned and ran back to the other birds at full speed. The manager of the farm then slipped a dark bag over the head of one of the birds. With the light shut off the bird darted here and there, until finally it allowed itself to be led away by the neck. Bringing the bird up to the rail fence, the bushman suddenly jumped from the top rail and alighted squarely on its back. The manager then drew off the black bag and the bird gave that bushman such an exhibition of bucking as no piebald mustang ever equalled. The rider was game, however, and stuck on, holding one wing with each hand, while his knees were tucked in under the wings.

From the ostrich farm we ran into "Mysterious Asia," where the automobile created quite a confusion among camels, donkeys, dancing girls, and excited booth keepers. We loaded the machine down with foreigners for a picture, which went all very well until we asked them to get out. Then they wouldn't have it that way. No, nothing would do but that we must give them a ride. Never had the *Pathfinder* before carried such a motely crowd—dancing girls, donkey boys and camel men piled in, and up the Pike we went at a pretty good speed. It was their first automobile ride, and when we opened the muffler we lost half our load, and would no doubt have lost it all if the tonneau door had not been securely fastened. They were all pretty badly frightened at the sound of the explosions.

From Asia we ran into Colonel Cumming's "Wild West," across the Pike, and there we loaded up with Indians. Redskins from various nations, and some without any nation, piled in and were photographed. This show is one of the largest on the Pike, and comprises several hundred cowboys, Indians, rough riders and soldiers. Roping steers, an attack on the settler's cabin, the hold-up of the Denver stage coach, riding bucking bronchos and wild cattle, running the gauntlet, and similar scenes as pictured in our early histories of the West made up the program for the afternoon's performance.

Another visit that proved very instructive was that made at the Esquimaux vil-

lage. This exhibit was an improvement on the Esquimaux exhibit at the Columbian Exposition at Chicago. There are more men, women, dogs, houses and curiosities than ever. The performance consisted of: An Esquimaux stalking a seal; an exhibition of the marvelous dexterity of the natives in using that most formidable of arctic weapons, the deadly walrus hide whip; an exhibition of native dog driving, in which six dogs are driven tandem attached to a sled; the medicine man curing or killing a sick native, the method employed being to frighten the patient into forgetting his sickness; an exhibition on the lagoon in a native skin canoe, and several native dances. Little Nancy Columbia, the famous little Esquimaux girl who was born at the Chicago fair, was very much in evidence, and is indeed a beautiful and talented child of eleven.

Another show on the Pike which is deserving of special mention is the "Battle of Santiago" and great naval display. There are twenty-eight miniature war vessels, ranging in size from ten to twenty-one feet, and all are exact reproductions of the United States and Spanish vessels. Each

ship is run by electricity, and is controlled by an operator who sits inside the boat unseen by the spectators. The naval show is given on a lake two blocks in area. Actual maneuvering of a fleet may be seen, blowing up ships, encounter with forts, submarine explosions, and numerous thrilling and exciting scenes of real warfare. The program includes reproductions of the naval battles of Manila, Santiago, Port Arthur and other famous sea engagements. This show is always well attended and deserves a visit.

Fair Japan portrays the life in that far away island, and the Japanese village is a very interesting sight. It is supposed to represent a section from the old Imperial gardens at Tokio, and is filled with very old trees trained in fantastic shapes, the Temple of Nikko, all the life of a street in Asakusa, Geisha girls with their dances, and other native sights and scenes.

These are only a few of the things to be seen on the famous Pike and in the several hundred buildings that go toward making the St. Louis Exposition of 1904 by far the biggest World's Fair this country or any other has ever witnessed.

Women's Views of the Automobile Exhibit.

By MARTHA L. ROOT.

WOMEN who visit the World's Fair are interested in many special features of the Exposition. The women motorists go first to the automobile show in the Transportation Building, but for the most part they pass the American exhibits and spend most of their time in the foreign sections. They like the splendid finish of the French cars, and their multiplicity of accessories.

"Look at that galvanized iron piece at the rear of this car, with special leather straps to hold two steamer trunks. I like that, and it doesn't take much space," said a Chicago woman motorist while visiting the French section. Her opinion was quite in agreement with the opinions expressed by scores of women motorists who have noted the little conveniences for travel that seem to have been carefully considered by the foreign constructors. Another woman commented upon the side entrance and the unique attachment on several such cars for holding an extra tire. All the ladies liked a \$6,000 French car with red body and victoria top, which was completely equipped inside with cases a veil, and collapsible pockets for odds and for toilet articles, a small receptacle for ends.

"Some women like to sit in a machine and look pretty, but I want to take my hat off, and do my own driving. I like these French cars, but the mechanism is so complicated, I should think one would need a chauffeur for each different make of carriage. The foreign machine is wonderfully fine, but what's the use of so many gears?

Give me a simple American motor that I can manage myself," this was the statement of a woman who was visiting the French section, and which gave voice to a different point of view.

An Arizona woman looked the display over carefully, and then remarked that one thing the automobiles needed was a receptacle large enough to hold two iron tripods and two rods: "Out West, we like to carry a little lunch with us, and do so, too," she said. "You know we can always pick up sticks anywhere, so we set up the tripods, put two rods across, and make coffee and cook bacon and eggs. They taste good, and we wonder why manufacturers don't put receptacles for these accessories into the cars."

Another woman liked a de Dietrich car best, because it had a buffet and a writing-table that could be converted into a dining-table as well. There were electric buttons with signs in French for the chauffeur. When she expressed a desire for this particular car, her husband remarked: "You'd never have reached St. Louis in a machine like that. Look at the low body. You women see the paint, brass trimmings, and collapsible pockets, as you call them; but a man looks for a serviceable car for American highways. Come back to the American section and I'll show you something better for us." So a bevy of women companions started back to see the American machines.

In the American section women will frequently be found discussing the question of motoring costumes in front of the booth

where auto clothing is shown. One well-known Western woman liked the three-quarters, half-fitting khaki cloth coats with hoods: "I have had more comfort out of my motoring coat of this soldier cloth than with any I have ever tried. They are very inexpensive, can be made as easily as a wrapper, and laundried up in an hour's time at any hotel. They button and the buttons are covered with the same material. The old-fashioned hood keeps the hair perfectly clean. I think they look very businesslike and appropriate."

All the women visitors agree that the automobile veils as shown were very expensive. One Chicago woman said she made her own. She has a dozen of them all in colors of chiffon. Each veil requires one and one-half yards of material. It is gathered in a ring, then slit up the centre to within a distance of 18 inches and hemmed at the ends. An excellent veil for long-distance trips, said another motorist, was one of pongee gathered into a circular band at the top, slit down the front and gathered into a draw-string at the throat. Two inches of silk are left for a ruffle at the bottom of the veil; this ruffle throws the dust away from the neck and keeps one's collar clean.

A Boston motorist expressed the opinion that with a shirt-waist motoring suit it is an excellent plan to have an extra shirt-waist of the same material. It can be packed in the suit case, and after the day's run, when one washes for dinner, it freshens one to put on a clean waist with clean turnover collars. She also advocated a silk motoring coat of the same material as the dress.

A visitor from St. Paul remarked upon the light tan coats in the booth. She thinks the lighter the material in color the less it shows the dust and dirt. The booth has a good variety of motoring coats, caps, and goggles. Women motorists do not agree upon the matter of caps. Some would wear nothing else, others taboo them. Several ladies have designed auto hats. A Pittsburg motorist wears a linen auto hat made upon a wire frame. She designed it herself. The covering can be taken off, laundried, and put on again. The jaunty millinery is tied with wide linen bows under the chin.

Among the exhibits outside the automobile show which the ladies in the St. Louis Fair found of special interest was the Oldbrich rooms in the Varied Industries palace. These rooms have a new method of decoration; the pictures are built into the walls rather than appearing in frames. The wall coverings are different from any seen heretofore. The building looks as if it might be the home of a wealthy man of any nationality, who, being possessed of an artistic temperament, had designed his home in a new and original fashion. The ladies said it lacked one feature—an automobile in the court!

Other places of interest visited by the women were the World's Fair gardens, the

foreign buildings, Japanese work in the Varied Industries, and also the Rookwood pottery in the same building. In the Liberal Arts palace everybody wanted to see the Cloisonne vases and hear the daily lectures upon them. All the ladies liked the art galleries, and said the pictures had a much better environment here than those at the Chicago Exposition eleven years ago. They are not so crowded, and each room has a harmonious setting of wall coverings and carpets. A number of women visited the model playground and all went to the baby incubator on the Pike. A few were interested in the wireless telegraphy demonstrations at the De Forest Tower, and others went to the radium lectures in the Government Building.

However, no matter where else the women automobilists went, they managed to spend the best part of the mornings in the Transportation Building at the automobile show.

FREE ENTRY OF FOREIGN CARS

Conditions Under Which They May Be Imported Temporarily and Permanently.

Special Correspondence.

WASHINGTON, D. C., Sept. 12.—The Collector of Customs at New York has sent to the Treasury Department a number of inquiries in regard to the free entry of automobiles imported into the United States. Assistant Secretary Keep has answered them substantially as follows:

Automobiles of foreign manufacture brought to this country for touring purposes, whether by foreigners or residents of the United States, and whether accompanying the owners or not, if to be actually used by them in this country, are entitled to free entry under bond, for a stay of three months, under the provisions of the Department's circular of June 20, 1902.

Under the provisions of Treasury decision of March 17, 1900, automobiles are classed as household effects, if used as such for the period prescribed by law. Automobiles used in business pursuits are not exempt from duty, as, under the provisions of paragraph 504 of the tariff act of July 24, 1897, the article must be a part of the household economy. In several cases decided by the Treasury Department household effects are defined as "articles which pertain to a person as a householder or to a family as a household, and do not include articles used in professional or business pursuits."

Automobiles used abroad as household effects as above for a period of one year or more, whether consecutively or not, and whether or not the one year of use abroad immediately precedes the importation, are free of duty upon the filing of the usual oath.

Free entry of an automobile is accorded only to the actual automobile used by the owner for one year or more, and cannot be allowed in the case of an exchanged machine which has not been used by the owner

for that period. Automobiles are free of duty if used abroad for one year, although a period of a year or more may have elapsed since such use.

Automobiles, to be free of duty as household effects, must have been used abroad for a period of one year or more by the owner or his family, whether driven by a chauffeur in his employ or not, but the use of an automobile by a chauffeur or friend unconnected with the owner or his family does not meet the requirements of the law.

Collector Stranahan will be governed accordingly.

Autos in the British Isles.

The number of automobiles and motorcycles registered in the British Isles up to midsummer, 1904, and also the number of driving licenses issued are shown in the following table:

	Autos	Motor-cycles	Driving Licenses
England	15,827	18,291	45,987
Wales	476	754	1,460
Scotland	1,373	1,252	3,636
Ireland	664	1,224	2,086
Totals	18,340	21,521	53,169

It will be noticed that the number of driving licenses is much larger than the total number of automobiles and motorcycles, indicating that a great many persons who do not own cars have taken out driving licenses. A large number of the extra licenses are doubtless held by chauffeurs. Another interesting point is the number of motorcycles registered, these far exceeding the automobiles numerically. This brings the motorcycle into prominence as the poor man's automobile, for in the poorer countries—Ireland and Wales—motorcycles are almost twice as numerous as automobiles, while in England, where the average of wealth is doubtless higher, there is less difference in the figures. In Scotland, however, the automobile has a little the best of it, probably because a large proportion of automobile owners in that country are Englishmen of wealth, to whom a high price is of small moment as against luxury. The frugal Scotch are not distinguishing themselves by their eagerness to take up the new mode of locomotion.

MacComb's Dam Bridge at Midnight.

I stood on the bridge at midnight
As the clocks were striking the hour,
And I wondered what I had taken,
A fizz or a whisky sour.

I saw the bright reflection
Of the Harlem under me,
But the things I beheld above it
I had never thought to see.

Scarce had the distant chiming
Tolled off the middle of night,
When there started a strange procession
That froze my wondering sight.

First one, and then another,
Then two and three swept by,
And then they came at such a rate
They dazzled my watching eye.

And some were still as phantoms
That come when the night grows cold,
And some shook the bridge like giants
That strode in the days of old.

New York Times.

Vanderbilt Cup Race Entries Close.

Eighteen Machines Are Entered—White Steam Cars Withdrawn—N. Y. City's Permission to Use Streets Granted.

THE last possible obstruction to the holding of the Vanderbilt Cup Race, barring accidents or unforeseen occurrences, has been removed by the granting of permission, by the New York City Board of Aldermen, for the use of that part of the course which lies within the New York city limits. This includes the apex of the triangle at Queens. Though no difficulty was anticipated in this direction, those upon whom the responsibility rested breathed a sigh of relief when the last link in the chain was completed.

As soon as it was known that all the seats in the grandstand originally planned would be subscribed for, preparations were

Bethpage Turnpike; but it is not at all probable that this will be done, as the work of improving this part of the circuit is well in hand, and when this is completed the worst features will have been eliminated.

Some doubt has been expressed concerning the reported horsepower of the Renault car entered by W. Gould Brokaw, as the Renault people, so far as known, have never built cars of 90-horsepower. Mr. Brokaw himself, however, refers to the car as having a 90-horsepower motor. The car itself is not yet in this country, and is not likely to arrive for at least two weeks.

The de Dietrich machine which has been entered by Mr. Jarrige is the identical car

postmark, which showed that it had been mailed the day before. The delay in getting the entry in was due in a large measure to doubt as to whether the car could be kept within the weight limit of 2,204 pounds. This, however, has been done, and there is a safe margin left. The machine differs in a number of respects from the other cars entered. Although it is essentially a racing car, it has few "freak" features. The motor is a four-cylinder, 75-horsepower engine similar in every respect to that used in the auto-boat *Vingt-et-Un*. The bore is 6 1-2 inches and the stroke 6 3-4 inches. All valves are mechanically operated. The cylinders are cast in pairs, and the exhaust from each pair is carried out through a single short pipe projecting straight out through the aluminum hood. One carburetor supplies all four cylinders, and one spark coil feeds the four plugs through a distributor. A combined tank and cellular radiator, a centrifugal pump driven from

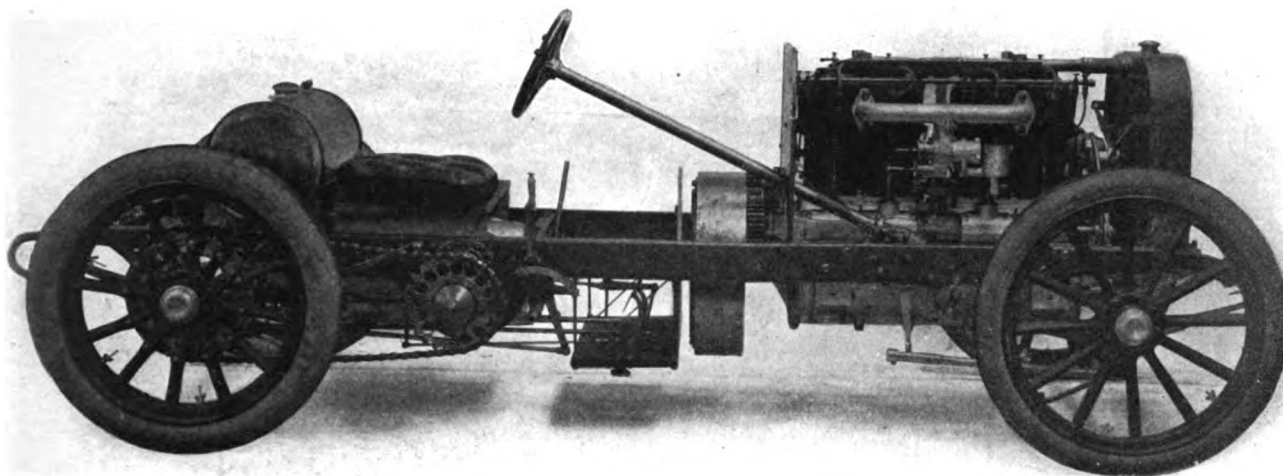

SMITH & MABLEY 75-HORSEPOWER SIMPLEX ENTERED IN VANDERBILT CUP RACE BY FRANK CROKER.

made for the erection of an addition doubling the grandstand accommodations. There will be eighty boxes having a capacity of six persons each, and single seats for 800 spectators, a total capacity, in both stands, for 1,200 persons. Among other distinguished spectators, the Italian Ambassador will occupy a box and by his presence at least will encourage the drivers of the Italian cars to victory.

A recent development in the plans of the A. A. A. Racing Committee is the decision to oil the entire course. This was arranged after a consultation with Mr. Vanderbilt, who thought it advisable to leave absolutely nothing undone that could conduce to the safety of the racers and spectators. The oiling will cost in the neighborhood of \$5,000, and will make the roads perfectly safe for fast driving, so far as the raising of dust clouds by the cars is concerned.

There has been some speculation regarding the possibility of cutting out that part of the course which includes the turn from the Hicksville-Massapequa road into the

driven by Gabriel in the French elimination trials for the Gordon Bennett race.

Entries for the first great American road race came in rapidly during the last few days before the list closed, and there are now eighteen machines scheduled to face the starter. The French entries lead, in point of numbers, with six cars. Germany and the United States are to be represented by five cars each, and Italy by two 90-horsepower Fiat racers. Of the late entries two are 60-horsepower Mercedes cars belonging to E. R. Thomas, of New York, and Isadore Wormser; an 80-horsepower de Dietrich, entered by Mr. Jarrige, New York agent for this make; the 90-horsepower Renault, which W. G. Brokaw has sent his driver, M. G. Bernin, to France to bring over here; a second four-cylinder Pope-Toledo; the Packard *Gray Wolf*, and the Smith & Mabley Simplex racer just turned over to its purchaser, Frank Croker, son of Richard Croker, ex-Tammany boss.

The entry of the Simplex, which will be driven by its owner, was received after the list had closed, and was saved only by the

secondary shaft by gears, and a fan behind the radiator comprise the cooling system.

The frame of the car is of pressed steel of channel form, tapered at the ends. The cross members are also of channel steel, and these are drilled out as much as possible to get rid of superfluous metal. The axles are of steel of I-section, very strong, and are dropped considerably to bring all of the heavy parts as low as possible. In this way the center of gravity has been brought very low, while plenty of clearance above the road is left. The steering knuckles are particularly strong, although not so heavy as they appear, being bored out as much as safety would permit. Wood artillery wheels are used, and the Michelin tires on the rear wheels are 920 by 120 millimeters and on the front wheels 910 by 90 millimeters. The wheelbase is 106 1-2 inches and the tread standard. All wheels run on ball bearings—in fact, ball bearings are used throughout the car except in the motor, in which the bearings are plain. Almost all shafts are hollow.

The transmission and differential are enclosed in the same casing. The four forward speeds are controlled by a single lever on the right, while the reverse is thrown in by a lever on the left. The reversing gear locks automatically so that it cannot be meshed unless the forward gears are clear, thus obviating the possibility of any mistakes in this direction. A pedal-operated hand-brake acts on the differential and a lever operates emergency brakes on the rear hubs in the usual way. A second pedal operates the clutch, which is of the internal type, the cone on the transmission shaft moving backwards, or away from the face of the wheel, to come into engagement. Thus the thrust is almost eliminated while the clutch is engaged, though present to some extent when it is out. The spark and throttle levers are located at the top of the steering wheel, which is inclined at a sharp angle from

The feeling of gratification over the entry of seven American cars has been modified by the advices from Cleveland that the two White steam racers will not be completed in time to take part in the race. This is the more disappointing because the cars were absolutely unknown quantities, and their appearance was being awaited with a great deal of interest. The idea of steam automobiles competing on even terms with the best representatives of the gasoline class over a 300-mile course that would test them to the utmost, caused a great deal of speculation. The White cars were the first to be entered, having been placed on the list by telegraph the day the list opened. The White company does not care to enter the cars used for racing last year, and there will, therefore, be no steamers in the Vanderbilt Cup Race.

The combined horsepower of the remaining cars entered reaches the surprising

odd miles will be close to a mile a minute, the slowing down for turns and controls preventing the possibility of a higher rate.

Following is a list of the cars entered. Some changes may be made in the drivers, but the list as it stands will, in the main, be found correct:

Dr. Danforth had a horseless nightmare recently. He dreamed that Amory Had-sall's auto had run him down and was sitting on him. When he awoke he discovered that his mahogany folding bed had closed up on him during his restless slumbers.—*Genoa (Ill.) Journal*.

At a recent meeting of the Massachusetts State Board of Highway Commissioners to consider a petition from the Winthrop, Mass., selectmen that automobiles be barred from the boulevards along the reservation at Winthrop, the board decided the

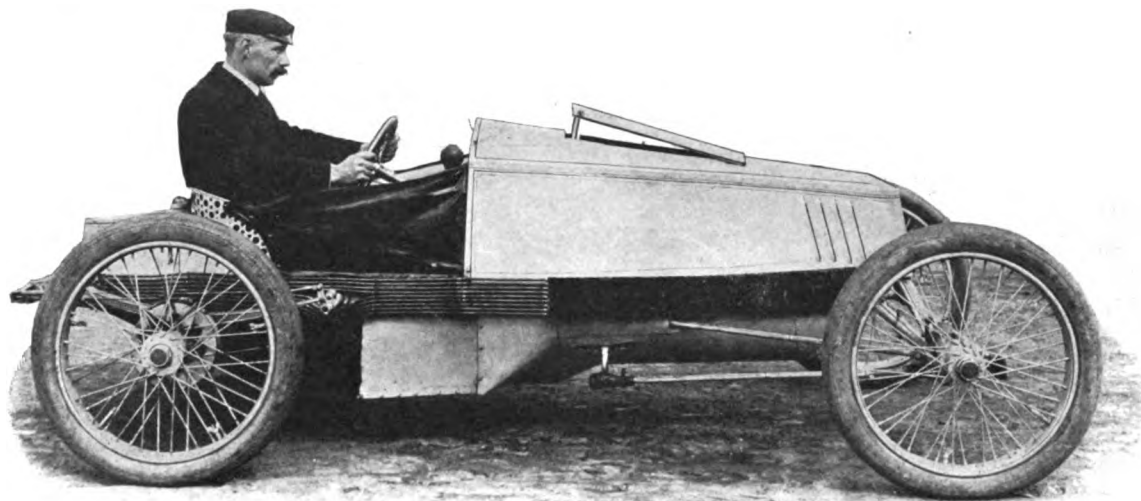

CHARLES SCHMIDT AND PACKARD 24-30-HORSEPOWER RACER, "GRAY WOLF."

the horizontal, as usual in extreme racing cars. The levers are connected to the throttle and spark timer through Bowden wires, which permit corners to be turned without the use of bell-cranks or similar devices.

A peculiarity of this car, and one that will doubtless be appreciated by the driver and his mechanic before the long race is over, is that the occupants will sit with their feet in a sort of rectangular well, thus being in a comfortable position and at the same time very low. The motor is said to be sufficiently powerful to accelerate the car with great rapidity, and the gearing is of extraordinary strength, so that all the power can be transmitted without danger of breakage. The top speed of the car, when geared for the race, will probably be about ninety miles an hour, and the construction is such that the changing of gears is a simple matter. Owing to the turns in the cup course, it will be necessary for the racers to slow down frequently, and a car that can accelerate with promptness will stand an excellent chance of making a good showing.

total of 1,480. Six machines are rated at 90-horsepower each, while the lowest is the 24-30-horsepower *Gray Wolf*. The average of the machines entered is a trifle more than 82-horsepower. It is calculated by experts that the average speed for the 300

danger and inconvenience caused by automobiles on the boulevards was not so apparent as the selectmen seemed to believe. The board took no action on the petition, and the machines may still run along the State reservation.

COMPLETE LIST OF ENTRIES FOR VANDERBILT CUP RACE.

Country.	Car.	H.P.	Driver.	Entered by
United States....	Pope-Toledo	60	A. C. Webb.....	Col. A. A. Pope
	Pope-Toledo	60	H. H. Lyttle.....	Col. A. A. Pope
	Gray Wolf.....	30	Charles Schmidt..	Packard Motor Car Co.
	S. & M. Simplex....	75	Frank Croker.....	Frank Croker
	Royal Tourist.....	35	Joseph Tracy.....	C. A. Duerr
France.....	Panhard	90	Tart.....	Panhard & Levassor
	Panhard	90	Heath.....	Panhard & Levassor
	Panhard	90	Panhard & Levassor
	Clement-Bayard	80	Albert Clement...	Albert Clement
	Renault	90	M. G. Bernin.....	W. G. Brokaw
	De Dietrich.....	80	L. Regan.....	R. E. Jarridge
Germany.....	Mercedes	60	S. B. Stevens, Jr..	S. B. Stevens, Jr.
	Mercedes	60	E. E. Hawley.....	E. R. Thomas
	Mercedes	60	Carl Mensel.....	George A. Arents
	Mercedes	60	Werner	Clarence Gray Dinsmore
	Mercedes	60	Isadore Wormser
Italy.....	F. I. A. T.....	90	William Wallace.	William Wallace
	F. I. A. T.....	90	Paul Sartori.....	Alfred G. Vanderbilt

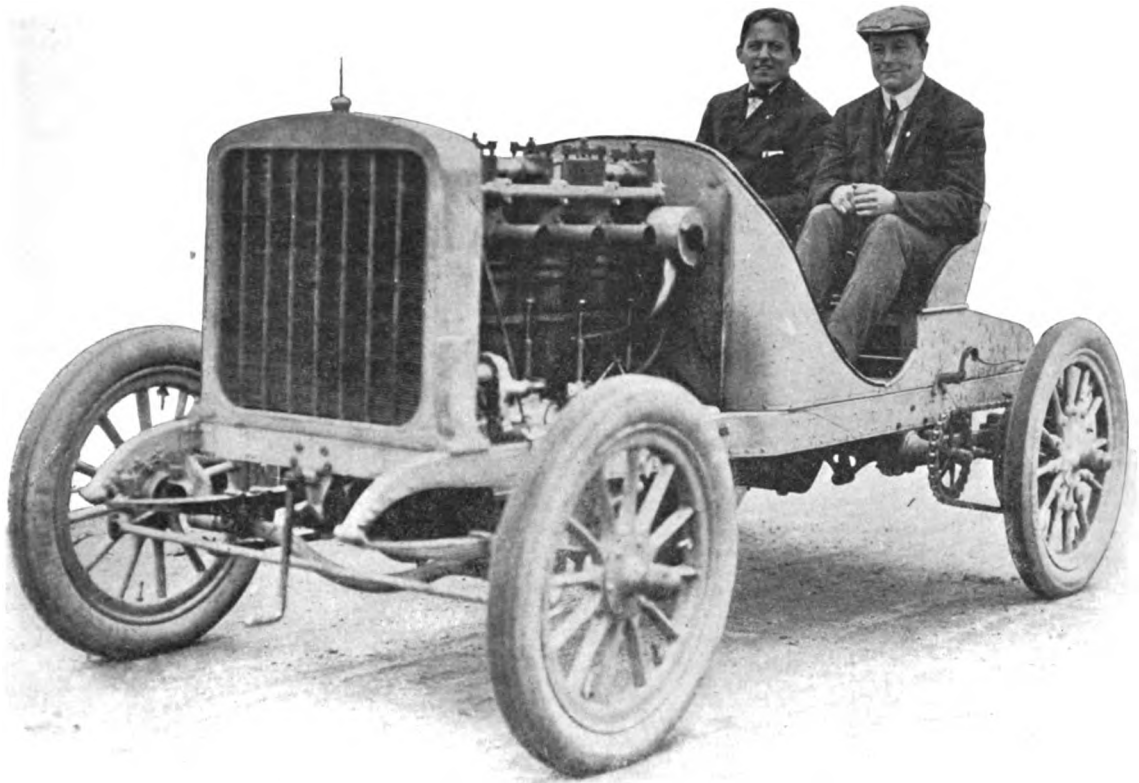

POPE-TOLEDO 60-HORSEPOWER VANDERBILT CUP RACER, WITH A. C. WEBB AT THE WHEEL.



America—Joseph Tracy in the Royal Tourist Vanderbilt Cup Car.

France—Albert Clement at the Wheel of the Clement-Bayard.

CRACK DRIVERS WHO WILL PILOT AMERICAN AND FRENCH CARS IN THE VANDERBILT CUP RACE ON OCTOBER 8.

Problem of the Auto Boat.—II.*

Elements of Successful Hull Design Simply Discussed for the Benefit of Intending Purchasers and Users.

BY WILLIAM F. DURAND.

CONDITIONS AFFECTING THE FORM.

WE shall now turn to some conditions affecting the form of the boat, first under water and second above.

The underwater form at the bow should represent a gently tapering wedge with edge vertical and cutwater sharp. The angle of the wedge will be determined largely by the length to beam ratio, but on this ratio the angle of entrance should be made as easy as possible, advantage being taken in most modern designs of the flat stern to be discussed at a later point, and which permits of carrying the maximum breadth much nearer the stern, and thereby obtaining finer angles of entrance, than with the maximum breadth more nearly amidships.

As between the so-called *U* and *V* forms for bow sections, the former are to be recommended as the better so far as wave-making disturbance is concerned, while they result also in a less pronounced lift at the bow itself and hence in a less pronounced disturbance in the trim of the boat at operating speeds. The general lifting of the boat bodily at the highest speeds and the decreased resistance which this is believed to give may be better determined by a suitable adjustment of the form somewhat farther aft, and the lifting effect thus located will produce a less pronounced disturbance on the trim, and thus leave the boat more nearly in normal trim at operating speeds.

CUTWATER SHOULD BE VERTICAL.

In particular it is desirable that the cutwater shall be nearly vertical and not rounded off, or cut away too much at the bottom. The draft at the bow should be somewhat less than farther aft, but at the same time sufficient to insure the immersion of the cutwater under any lift of the bow or dropping of the stern which the boat may experience at top speed. The obvious purpose of this caution is to avoid a decrease of the effective length of the boat on the water line when at top speed. Of what service is 40 feet in length if the boat at top speed projects her nose out of water and due to the form of bow runs actually on a 30 or 35-foot water line? This is a serious fault in some of the recent designs for auto boats, and the point is one to which the designer will do well to pay special attention.

For the after body the prevailing form for the immersed part of the boat shows a gradually tapering wedge with edge at the stern, horizontal, and at the surface of the water. In other words if we should suppose the upper part of the boat cut off by a plane at the surface of the water, the remaining part below water would show such a wedge-shaped form with edge at the sur-

face at the stern, and base joining the forebody which, as already noted, shows in a general way a like wedge form with vertical edge at the bow.

FORM OF THE STERN.

The "points" of this form of stern are as follows: First, it permits of placing the greatest breadth at a point well aft of amidships, and thus of obtaining finer horizontal or water plane angles at the bow.

Second, it places the surface of the boat at the stern in a position to find support from the water pressures in that locality, and thus to better resist the tendency to settle at the stern so commonly shown by small boats at high speeds and which so seriously disturbs their running trim.

Third, on the same over all dimensions it gives more water plane area than the common ship formed stern, and thus more stability and more safety.

Fourth, for the same reason the part of the boat above water may be made much more roomy at the stern, thus adding to the comfort and general serviceability of the boat.

In connection with this type of stern reference may be made to the so-called tetrahedral form of boat which has been proposed and used in some trial designs, and in which these principles are carried to their full extreme by placing the greatest breadth directly at the stern and thus assimilating in a general way the form of the underwater body to a tetrahedron or four-faced solid, of which one face is horizontal at the water surface and shows a triangular form of water plane with point at the bow while a second triangle dips gently from the surface at the stern and shows its apex at the bottom of the stem piece. Two others are vertical and show their apexes at the stern at the surface and join their bases at the bow. This is the type form, rounded on the lower edges and modified in accordance with structural necessities.

It can not be said at the present time that there is sufficient evidence regarding this type of form to justify any assumption of superiority over more common forms in which the principles involved are not carried to the same extreme, and in which the widest section is somewhat forward of the stern, with a keel line sloping upward from a point more nearly amidships, rather than from the foot of the cutwater.

ALTERATION OF WATER LINE LENGTH.

Mention may also be made at this point of the tendency shown in some recent designs to so adjust the form at the stern that the water line length when at rest shall be considerably less than when under way. This is a matter which has chief rela-

tion to the subject of the classing of boats, and may result in the location of a boat in a lower class than that in which she might belong if measured when running at a moderately high rate of speed. There is no difficulty, of course, in arranging a long overhang of stern which will just clear the water when at rest, and which will therefore not come into the water line measurement, but which is expected to come down to the surface of the water when under way, and thus form a part of the effective length of the boat. This is a matter largely of jockeying for points, and has nothing whatever to do with the scientific design of a boat. The length for rating should be determined by the water line when under way, rather than when at rest, and this would do away with the temptation to resort to such methods of gaining an advantage in the matter of rating. In any event and quite aside from the question of rating, the form at the stern should be so adjusted that with a reasonable and convenient location of machinery and other weights and at the top speed, the round of the lower knuckle or under surface of the boat at the stern will just rest nicely on the surface and without tendency to settle lower and plow a furrow through the water, thus exercising a considerable drag at this point and increasing the resistance of the boat.

In a following article the influence of the form above water will be considered together with some questions regarding the adjustment of the trim, and other minor points which may properly enter into the problem of high speed with boats of this character.

(To be continued.)

MISCELLANEOUS NEWS NOTES.

Three farmers of Mills County, Ia., now own and drive automobiles.

The automobile formerly used by the late Colonel Henry, widely known through his connection with the Dreyfus trials in France, is reported to be the property now of Mrs. William N. Thomas, of Austin, Ill., who uses the car for the purpose of demonstrating an automobile speed indicator that automatically sounds an alarm when the machine exceeds a certain speed. Efforts are being made to have an ordinance passed in Chicago requiring the use of the device upon the machines of that city.

Postmaster F. M. Fisher, of Paducah, Ky., accompanied by his son Harold, have just completed an automobile trip to Portageville, Mo., and return, a distance of about 250 miles. It was the first automobile to be seen in western Tennessee, and caused no little excitement among the natives. Though the roads were exceedingly rough, no serious mishaps occurred and the machine completed the trip in good condition. A stop for a day and night was made to enjoy the fishing at Reelfoot Lake, and other stops were made at Hickman, Ky., and Tiptonville, Tenn.

* Continued from Page 256, issue of Sept. 3, 1904.

New Records Made at Providence.

Figures in Light and Heavy Gasoline and Steam Car Classes Demolished by Kulick, Basle and Ross.

Special Correspondence.

PROVIDENCE, Sept. 10.—New world's track records, for both gasoline and steam cars, were made at the races of the Rhode Island Automobile Club at Narragansett Park track to-day. Barney Oldfield's records from two miles up to ten were cut down by the 90-horsepower Mercedes owned by H. L. Bowden and driven by his chauffeur, Charles Basle. The steam records established by George Cannon were also replaced by new figures made by Louis Ross in the freak steam racer which made its first appearance at the Boston meet.

Cloudy weather in the morning made it look doubtful if the meeting would be held, and it was not until almost noon that the committee decided to start the races. It was fortunate that this decision was made, as soon after the first race was started the sun came out and the 5,000 spectators who had assembled sent up a mighty sigh of relief.

As is usual with the Providence meets, society turned out in numbers, and notwithstanding the threatening conditions of the morning the grand stand and both sides of the home-stretch, where more than 200 vehicles were packed, were gay with color.

The program consisted of nineteen events, an unnecessary number, as this practically turned the event into a series of match races and made it very confusing for the spectators to follow the contests, more especially as, owing to the usual delays, it was impossible to run the heats off in sequence.

In two races during the afternoon tires came off machines in the races, and in one

of them Ross drove his freak steamer over two miles with a tire off one of the driving wheels, giving the spectators a most exciting spectacle as he swung from side to side on the stretches in his endeavor to get control of his vehicle without diminishing his speed. In another race the Pope-Toledo racer finished on the rim after throwing a tire with sufficient force to

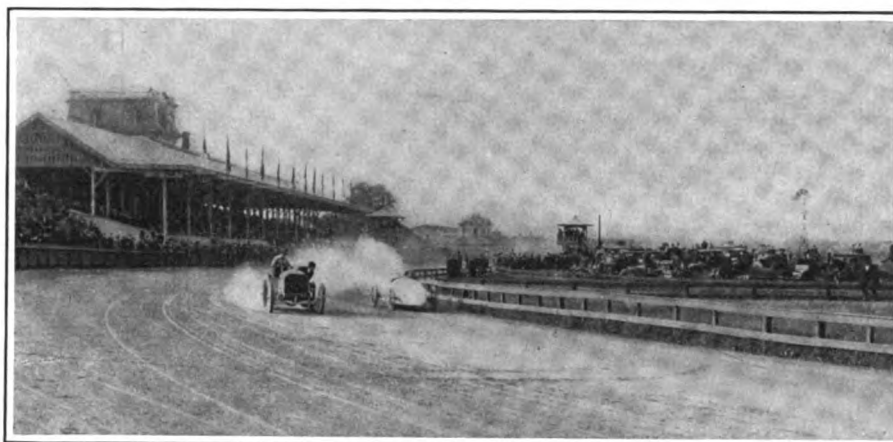

[FIGHT FOR FIRST PLACE BETWEEN GASOLINE AND STEAM CAR AT PROVIDENCE, SEPT. 10.

knock a board out of the fence on the back-stretch.

In the light-weight class the 20-horsepower Ford racer made new figures for vehicles under 881 pounds, although it was not so announced. The little vehicle made the first mile in 1:04 1-5, two miles in 2:05, three in 3:06 2-5, four in 4:07 4-5, and five in 5:09 4-5.

10-h.p. Cameron, second. Time, 5:27 2-5.
 Five miles, special, for 7-h.p. Stevens Duryeas—Won by C. D. Snow; W. J. Chapman, second. Time, 7:44 2-5.
 Five miles, middleweight class—Won by Frank Kulick, 20-h.p. Ford; William Wallace, 30-h.p. Renault, second. Time, 5:09 4-5. New record.
 Five-mile, special for 10-h.p. Franklins—Won by Edward Dauer; H. A. Capron, Jr., second. Time, 8:37 1-5.
 Five-mile, touring class invitation—Won by F. C. Fletcher's 24-h.p. Pope-Toledo, driven by A. S. Lee; J. A. Foster, 24-h.p. Winton Quad, second. Time, 6:31 2-5.
 Five-mile, special for steamers—Won by Louis S. Ross, 18-h.p. Stanley; Paul Durbin, Stanley, second. Time, 5:08 3-5. New world's track record for steam vehicles. Time by miles, 1:05 1-5, 1:00 2-5, 1:00, 1:00 1-5, 1:02 4-5.
 Five-mile, special match—Won by A. S. Lee's 24-h.p. Pope-Toledo; H. E. Rogers, 24-h.p. Peerless, second. Time, 5:58 2-5.
 Ten-mile, free-for-all—Won by H. L. Bowden's 90-h.p. Mercedes, driven by Charles Basle; Louis S. Ross, 18-h.p. Stanley, second. Time, 9:13. New world's track record, and also the following intermediate records except the first mile. Time by miles: :59 2-5, 1:53 2-5, 2:47 2-5, 3:42 2-5, 4:37 2-5, 5:32 1-5, 6:26 4-5, 7:21, 8:17, 9:13. Fastest mile, the third, in :54. Time for Ross by miles: 1:02, 3:07 1-5, 4:08 3-5, 5:12, 6:16 1-5, 7:17, 8:16 3-5, 9:28 1-5, 10:12.



SPECTATORS' CARS LINED UP ALONG THE FENCE IN FRONT OF GRAND STAND.

CHICAGO RACE MEET SEPT. 30-OCT. 1.

Special Correspondence.

CHICAGO, Sept. 12.—An automobile race meet will be given in this city at the Harlem race track on Friday and Saturday, September 30 and October 1, by the Chi-

cago Automobile Club. This was decided at the meeting of the board of directors last Thursday, and the racing committee, consisting of F. C. Donald, Jerome A. Ellis and John E. Fry, was instructed to arrange the details. The committee is in communication with prominent racing men, and it hopes to get an aggregation of talent that, combined with the fast drivers in the local club, will arouse enough interest to make this the greatest meet ever given west of Detroit.

WISCONSIN FAIR RACES.

Automobile and Motorcycle Events at Milwaukee Preceded by Parade.

Special Correspondence.

MILWAUKEE, Sept. 10.—Friday afternoon was automobile and carnival day at the State Fair, which was held in this city from September 5 to 9, and, while the automobile races were somewhat of a disappointment, owing principally to the lack of experience on the part of the officials, the enthusiasm evinced was gratifying to all admirers of the sport.

Eighty automobiles assembled at the Pfister Hotel at 2:30 o'clock in response to invitations to participate in a parade to the Fair grounds, and a very pleasing spectacle was presented when the long line of autos passed through the streets, as many of the machines were prettily decorated with flowers and streamers. Upon reaching the park the cars drew up within the half-mile track directly opposite the grandstand, from which position their occupants viewed the races.

After the horse races had been completed and the announcement was made at 4:15 p.m. that "We are now ready for the automobile races," a demonstration of approval emanated from the stand.

Three machines should have started in the first race, but owing to the ruling of some unknown official, Orlando Weber's Toledo did not take part, leaving Jonas's four-cylinder Peerless and Arthur Gardner's two-cylinder Rambler to compete alone. Fred Tone drove the Peerless, and



The training of horses to pass without fear the growing number of automobiles being used in the White Mountains in New Hampshire is carried on at the Mount Washington Hotel, Bretton Woods, in the way shown above. As motorists are being encouraged to enjoy the beauties of the scenery in that section, and the spirited horses driven over the narrow, winding roads are as yet little accustomed to the power vehicle, the desirability of such training is apparent. The system is recommended in other sections where autos are just beginning to make their appearance. As the first move the cars are driven slowly into the stable while the horses are in their stalls. Then by degrees the horses are induced to eat oats from the cars, which some of them do after an hour's urging. After a few days the animals will allow the machines to be driven about among them in the yard without being frightened.

after the first half mile had been covered it was merely a question of how badly Gardner would be beaten. The Rambler hung on with remarkable tenacity, but was, of course, outclassed by its four-cylinder opponent. The Peerless finished more than half a mile in the lead, in 13:44 1-2 for the ten miles.

Immediately after the race a protest was made on account of the Toledo not having been allowed to enter, and after considerable discussion it was finally decided to allow the Toledo to go against the Peerless. The race was close for the first mile, but after that two cylinders of the Peerless ceased firing and Tone, the driver, decided to withdraw, permitting Charles Soules in the Toledo to finish the five miles alone, covering the distance in 5:58. The second mile was made in 1:07, the best time of the afternoon.

The next race was a five-mile contest for 16-horsepower machines, and was won handily by George Odenbrett, who drove a

Franklin. A White and a Rambler were the other factors in the race, the former dropping out after the second mile and the latter quitting in the third, leaving Odenbrett to finish. His time was 7:27.

The motorcycle races were next in order, and resulted in closer competition. Eight machines started, and Sampson, on an Indian, won, Frank Zerbis, on a Mitchell, crossing the tape a close second. It was a pretty race, Zerbis and Sampson alternating in the lead for two miles, after which Sampson took the lead and maintained it, covering the five miles in 6:50.

The second motorcycle race, a two-mile open, was won by Zerbis in 2:52, with Sampson second.

Following are the summaries:

Ten-mile open—Fred Tone, 24-horsepower Peerless, 1st; Arthur Gardner, 16-horsepower Rambler, 2nd. Time, 13:44 1-2.

Five-mile exhibition—Charles Soules, 24-horsepower Pope-Toledo. Time, 5:58.

Five-mile race for 16-horsepower cars—George Odenbrett, 10-horsepower Franklin, 1st. Time 7:27.

Five-mile open motorcycle race—Sampson (Indian), 1st; Zerbis (Mitchell), 2nd; A. H. Nichols (Rambler), third. Time, 6:50.

Two-mile open motorcycle race—Frank Zerbis (Mitchell), 1st; Paul Sampson (Indian), 2nd; A. H. Nichols (Rambler), 3rd. Time, 2:52.

Seventy-two automobiles are in use in Des Moines, Ia.

"Bring on your automobiles. There may be a few runaways, but the horses will have to get used to them, as they did in the case of the bicycle, and then the increased use of automobiles means better roads. If there is anything Iowa needs it is better roads."—Boone Republican.



PACKARD NON-STOP TOURING CAR AND TOM FETCH AT PROVIDENCE MEET.

Autos in Army Maneuvers.

The United States War Department has begun making tests of the suitability of the automobile in army maneuvers. After considerable investigation, the Department had a special car designed and built for the purpose of making tests. The machine is a telegraph and telephone car, and will be used by the U. S. Signal Corps for running telegraph and telephone lines and also as a portable telegraph and telephone station. It will be regularly stationed at the U. S. Signal Corps Post at Fort Myer, Va., but was sent to Manassas to take part in the maneuvers held last week, in order that the soldiers might become in some degree familiar with its operation.

General Corbin, who with his staff, used a White steam car in moving from place to place during the military operations, expressed himself strongly in favor of the automobile for military work, both staff and field, being particularly impressed with



GENERAL CORBIN, U. S. A., ON CAMP INSPECTION DURING MANEUVERES AT MANASSAS.



U. S. ARMY AUTO TELEGRAPH CAR.

the celerity with which movements could be made, notwithstanding the poor condition of the roads.

The telegraph car, which was built by Winton, is in its main features similar to the regular touring car built by that concern. Instead of the usual form of tonneau, however, there is a special tonneau with two seats running lengthwise of the car and facing each other. The car is equipped

with a table on which the telegraph and telephone instruments are placed. Under the seats there is ample storage space for supplies and equipment of all kinds, and on the sides are iron racks for lances and light poles used for erecting temporary overhead wires. The electrical instruments with which the car is equipped embrace the most improved apparatus, including a special sounder for working in the midst of the noise of battle. The squad detailed to go with the car is composed of eight or nine men, six of whom will act as guards. The machine is officially designated as the "Signal Corps telegraph auto car."

Cast-in Copper Flanges.

An air-cooled cylinder, designed to combine the good features of the iron cylinder cast in one piece with the flanges with those of the separate flange system, while avoiding the objectionable features of both, is illustrated by the accompanying reproduction of a photograph.

The cylinder proper is of cast iron and the corrugated radiators of cast or stamped copper. The radiators are made in sections, each comprising four corrugated wings and extending partly around the cylinder. The most important feature of the cylinder is that the radiators are inserted into the mold and cast into the cylinder wall. The base of each section of copper radiator has

two grooves, into which the molten iron runs and makes a solid joint. A large radiating surface can be secured by spacing the radiators closely, the only limit being

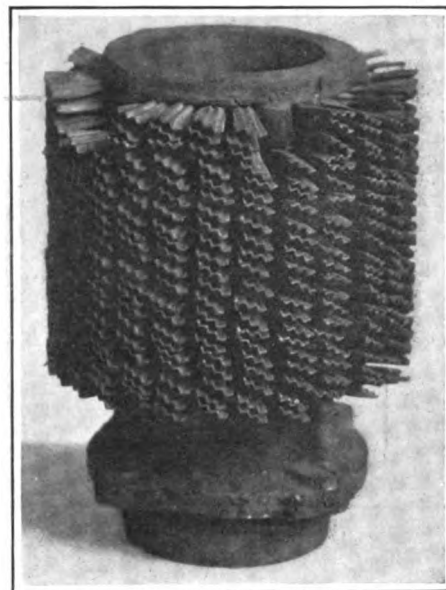

NEW AIR COOLED CYLINDER.

the necessity for leaving sufficient space for the circulation of air.

The greatest possible conductivity between the two metals is secured by this method, which secures the advantage of the superior radiation of the copper without permitting the difference in expansion to diminish the intimate contact between the flanges and the cylinder walls.

These cylinders have been brought out by the Hartford Pattern and Model Company, of Hartford, Conn.

William Morgan, manager of the Philadelphia branch of the Locomobile Company and secretary of the Philadelphia Automobile Trade Association, is investigating the roads in and around the Quaker City for the Automobile Club of America. The results will form a portion of the official records of the Club, and will be printed in convenient form for reference.



U. S. SIGNAL CORPS CONSTRUCTION AND REPAIR WAGON WITH GASOLINE MOTOR.

Auto-Boat Race from Paris to Sea.

Six-Day Contest on River Seine Won by "Mercedes IV."— "Hotchkiss" Captures the Gaston Menier Cup.

Special Correspondence.

PARIS, Sept. 1.—The auto-boat race from Paris to the sea, down the River Seine, through locks and therefore by short stages, was one of the most peculiar racing events on record. The total distance from Paris, where the race was started, to Trouville, the finishing point, is 357 kilometers, or 221 miles. Had it not been for the locks in the river, the whole course could have been covered in two days' racing; but the locks made it necessary to divide the distance into stretches of odd lengths and spin out the contest over six days, from August 14 to 19 inclusive.

The first day's run was 90 kilometers, the second 109, the third 22, the fourth 67, the fifth 55, and the sixth only 14. Some ar-

The first day's run was won by *Mercedes IV.*, and she followed this up by winning every day's heat except the fifth, which was won by *Hotchkiss*. This placed *Mercedes IV.* well up, and she came out a winner of the series quite comfortably. She was pressed closely by *Hotchkiss*, however, and it is thought that had the latter not suffered numerous delays from trivial causes, such as broken ignition wires, weed-fouled propeller and the like, the result might have been different. The beautiful regularity of running exhibited by *Mercedes IV.* kept her continually in the lead.

The second day's run, of 109 kilometers, the longest of the series, proved to be the last for *Trèfle-à-Quatre*. As she was not

Mercedes IV. in the lead as usual and *Hotchkiss* close behind.

In the class for racers under 8 meters, *La Rapee III.* took first place, *Titan*, which would in all probability have beaten her, having dropped out on the last day. In the cruiser classes, the winners were *Titan IV.*, *Arion II.*, *Vas-y* and *Usona II.*, the last being engined with a Lozier motor. Altogether four racers and ten cruisers finished out of nine starters in the racing class, twelve cruisers, twelve "miscellaneous" and one unclassified.

Absence of the English boats from the long race was much commented upon, as their performance would have been watched with a great deal of interest.

Sunday, August 21, was devoted to the Gaston Menier Cup race, a three-mile dash, which was won in magnificent style by *Hotchkiss*, much to the joy of Henry Fournier, who ran her. The competitors were *Hotchkiss*, *Trèfle-à-Quatre* and *Napier II.*, the boats finishing in the order named. The

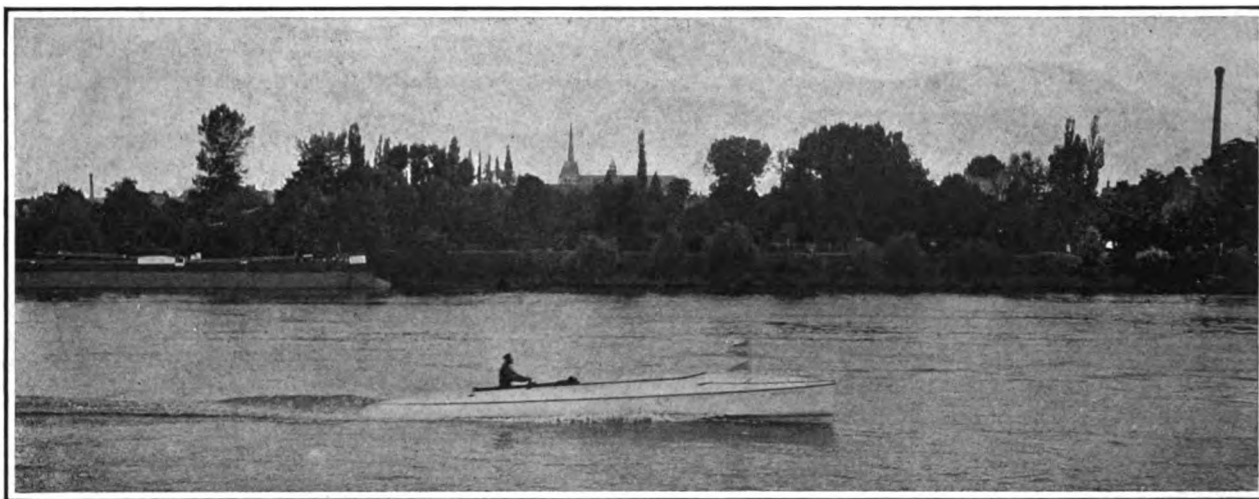

"MERCEDES IV," WINNER OF SIX-DAY RACE DOWN THE RIVER SEINE—CHARACTERISTIC SCENERY ALONG THE BANKS.

angement was necessary whereby the time occupied in passing through the locks would not count against the contestants, so the time of the racers was taken 100 meters on each side of each lock, the intervening time being neutralized. Some of the contestants took advantage of this arrangement to make repairs and adjustments, stopping after leaving a lock and before reaching the departing point to work on their motors. A favorite trick also was to so manoeuvre as to reach the lock gate just too late to get in, when it would be necessary to wait until it opened again, giving a fine opportunity to do a little tinkering.

The start the first day was made at 9:10 a. m., the following boats, from 8 to 12 meters in length, getting away: *Mercedes IV.*, *Trèfle-à-Quatre*, *Hotchkiss* and *Gardner-Serpollet*. In the class for boats under 8 meters *Titan II.*, *Princess Elisabeth*, *Le Titan* and *La Rapee III.* started. Later came the cruisers, among which were *Mercedes III.*, *Vas-y*, *Suzy* and other well-known boats.

running at all well, it was decided to withdraw her and try to get her in proper trim for the speed trials after the long race. On this day *La Rapee* ran second to *Mercedes IV.*, *Hotchkiss*, the usual holder of that place, having stopped to wrestle with a mass of weeds which entangled the propeller.

The third day found the *Gardner-Serpollet* out of the running, owing to an injury caused by the propeller striking an obstruction, leaving *Mercedes IV.* and *Hotchkiss* to fight it out alone in their class. These two boats made a grand race on the fourth day, but *Mercedes IV.* showed a trifle more speed than her rival, possibly owing to the fact that the latter carried four men.

The fifth day's run was captured by *Hotchkiss*, which ran her best and beat *Mercedes IV.* by 1 minute 30 seconds in the 55 kilometers.

The sixth and last day's run was on the sea, and the winds blew and the waves ran high. Nevertheless the frail racers pounded into the seas, pulling through safely, with

times were as follows: *Hotchkiss*, 8:25 2-5; *Trèfle-à-Quatre*, 9:40 3-5; *Napier II.*, 10:11 2-5. The time made by *Hotchkiss* in this race was more than three minutes better than that made by *Napier* when she won last year's Gaston Menier Cup race.

For some reason the *Mercedes IV.* did not enter the Gaston Menier Cup race, the only contestants being those named. This, of course, robbed the contest of a certain amount of interest, as the comparison between *Mercedes IV.* and the *Hotchkiss* would have been most instructive.

MONTREAL LAUNCH RACES.

Special Correspondence.

MONTREAL, Sept. 12.—The first launch races ever held on Lake St. Louis were run Saturday under the auspices of the Royal St. Lawrence Yacht Club, and were very successful. The fourteen boats entered were divided into three classes. The slow boats were sent away first and covered a course of five miles; the launches in the second and third classes covered the same



"LA RAPEE III," WINNER IN SECOND CLASS, ARRIVING AT TROUVILLE, ON THE SEA, THE END OF THE RACE.

course twice. The boats were started at such intervals as previous tests warranted the committee in supposing were their true handicaps, so that the finishes should be close and the boats secure places and prizes in the order of finish.

The two fastest boats were *Cora* and *Edna*. The latter was not entered, but she started with *Cora* and raced against time, covering the ten-mile course in 47 minutes 25 seconds. *Cora* filled with water near the outer buoy.

The results follow:

FIRST CLASS.		Elapsed	
	Start	Finish	Time
<i>Normandie</i>	4:56:00	5:48:40	52:40
<i>If</i>	4:58:00	5:39:40	41:40
<i>Beaver</i>	4:59:00	5:41:55	42:55
SECOND CLASS.			
<i>Mable</i>	4:44:30	6:07:08	1:22:38
<i>Le Balaine</i>	4:53:30	6:08:50	1:15:20
<i>Irene</i>	4:53:50	6:04:08	1:10:18
<i>Dream</i>	4:57:50	6:15:45	1:20:55
THIRD CLASS.			
<i>Le Brochet</i>	5:00:00	6:09:32	1:09:32
<i>Le Nap</i>	5:05:40	6:15:45	1:10:05
<i>Duverney</i>	5:06:40	6:14:55	1:07:35
<i>Jack of Hearts</i>	5:11:20	6:17:42	1:06:22
<i>Le Bouton</i>	5:13:20	6:08:15	1:54:55
<i>Cora</i>	5:21:20	Did not finish.	
<i>Edna</i>	5:21:20	6:08:45	47:25

AUTO-BOAT MATCH RACE.

Interesting Heats Between Leighton Boats of Same Size and Power.

Special Correspondence.

OGDENSBURG, N. Y., Sept. 8.—The match between the two launches *Pink* and *Kitten* was run on the St. Lawrence River here

on September 6 and 7, both races being won by the *Kitten*. The prize was a copper kettle designed and presented by Frederic Remington, and made under his direction by an Ogdensburg blacksmith.

The two launches were built from the same moulds, being 21 feet 10 inches over all, 21 feet 8 inches load waterline, and 3 feet 6 inches breadth. They were designed by H. J. Leighton and built by T. M. Milton, the *Pink* in 1903 and the *Kitten* this year. The motors are also identical, three cylinders, 4 by 4 inches, nominally 7-horsepower, but giving more than 10 in actual running. The *Pink*, owned by Jonathan Wainwright, was steered by Ernest Serrell, while the *Kitten*, owned by George Hall, was steered by S. G. Averell; both motors were handled by professionals. Both launches have three-bladed reversing wheels, and ran without mufflers.

The course was a triangle of 2½ miles, as measured from the chart, four rounds being run, or ten miles in all. The weather on both days was clear and cool, with the water perfectly calm. As both boats and the owners are well known on the river there was much interest in the match.

The first race was started at 11:35 a.m., the *Kitten* crossing within ten seconds of the gun and *Pink* ten seconds later. At the end of the first round *Kitten* led by 31 seconds; at the end of the second she had added 1 minute to this, owing to the missing of one cylinder on the *Pink* for a short time; on the third round she gained 40 seconds; and on the last round 4 seconds.

Her elapsed time for the ten miles was 38:32, an average of a mile in 3:51, or 15.5 statute miles per hour. The *Pink's* time was 40:57, an average of 14.6 miles.

The conditions were equally favorable Wednesday, the start being made at 11 a.m. The *Pink* crossed the line within half a second of the gun, with the *Kitten* half a second after her. *Kitten* soon took the lead, being 1 minute 20 seconds ahead at the end of the first round. On the second round she added 35 seconds to this, on the third 51 seconds, and on the fourth 15 seconds. The *Pink* lost one minute through the slipping of a sleeve on her reverse. *Kitten's* elapsed time was 37:20, or 3.44 to the mile, an average speed of 16.07 miles; *Pink's* time was 40:20½, or a speed of 14.87.

The races were held under very favorable conditions; the water smooth, no wind, and the course partly with and partly against the current; nevertheless, the times are extraordinary for launches of this size and build. The match was under the rules of the American Power Boat Association, but no allowance was necessary. A. R. Porte was referee; E. C. T. Smith, starter, and Allen Newell, timer.

Some time this week a special match will take place between the *Chip*, a Leighton launch owned by Mr. Wainwright, and the *Jack*, owned by S. G. Averell.

UPPER DELAWARE RACES.

"Boomerang" and "Nada III" Win Riverton Yacht Club Auto-Boat Contests.

Special Correspondence.

PHILADELPHIA, Sept. 12.—Last Saturday's motor boat races of the Riverton Yacht Club, on the Upper Delaware, gave local owners of that class of craft their first real chance to try conclusions in their favorite sport, and afforded a large crowd afloat and ashore an opportunity of seeing the latest of aquatic pastimes. That the affair was a success was the general verdict, wind and weather being just right, and aiding materially toward the favorable result.

The course was laid out from a point off the Riverton Yacht Club's house up the river to the lower Hen and Chickens buoy, thence down the river to the buoy off Seven-Mile Point, twice around—a distance in all of ten and one-half nautical



"HOTCHKISS," WINNER OF GASTON MENIER CUP, HENRY FOURNIER STEERING.

miles. With the aid of glasses the contestants were at all times in sight of the officials and spectators.

There were two events—for small boats and forty-footers or over. The former filled well, thirteen boats being sent away, while in the race for the larger craft only two started. In the first race George Balsley's queer-looking *Red Devil* was the favorite, although E. H. Godshalk's *Nada I.* and *Nada III.* were well thought of by reason of the first of these two similarly designed boats having won in its class last June.

In the 40-foot class, *Boomerang*, although rated at nearly the same power as its opponent, *Unique*, was given a start of 12 1-2 minutes over the latter, under the A. P. B. A. racing rules. It was too much of a handicap, and although *Unique* pulled up about four minutes on her rival, the race at no time had the appearance of a contest.

There was more excitement in the little fellows' race, and the handicapping was

a plucky race. Following is the summary:
SMALL BOATS.

<i>Boat and owner.</i>	<i>Elapsed time.</i>
<i>Nada III.</i> , E. H. Godshalk.....	1:02:11
<i>Nada I.</i> , Helen Godshalk.....	1:03:27
<i>Red Devil</i> , Geo. Balsley.....	1:06:45
<i>Now Then</i> , Dr. Rink.....	1:11:40
<i>Nan</i> , J. W. Ott.....	1:18:40
<i>Wizard</i> , R. L. Binder.....	1:41:49
<i>Maud Blair</i> , John Blair.....	1:42:48
<i>Elizabeth</i> , F. F. Waechter.....	1:57:13
<i>Anna Belle</i> , W. H. Wolstencroft..	1:47:14
<i>Wilhelmina</i> , Dr. E. M. Byers.....	1:42:07
<i>May</i> , J. F. Machell.....	withdrew
<i>New Jersey</i> , I. France.....	withdrew
<i>Lovica</i> , C. B. Mitchell.....	withdrew

40-FOOT BOATS.

<i>Boomerang</i> , E. H. Godshalk.....	1:01:48
<i>Unique</i> , H. E. Danzenbaker.....	:58:53

WINNIPEG ROAD RACE.

Good Time over Forty Miles of Bad Road in First Western Canada Event.

Special Correspondence.

WINNIPEG, Sept. 7.—The first automobile road race ever run in western Canada was

first portion being over a prairie trail, followed by a "made" road, which was terribly rutty, and in which many great boulders stuck up in the track to a height of nearly two feet, necessitating constant watchfulness and care to prevent the axles from striking. Where the road approached the turning point it ran through thick bush that prevented the drivers seeing very far ahead.

A great deal of interest was taken in the race, a large crowd having gathered at the Clarendon Hotel to see the start, and at Stonewall practically the whole town had turned out to welcome the pioneers of a new sport. To prevent any possibility of trouble with the police, the course between the Clarendon Hotel and the western extremity of Notre Dame was marked as a control, the drivers being restricted to a speed of ten miles an hour within this stretch.

A friendly farmer gave McLeod considerable assistance in fixing up his car sufficiently well to proceed slowly into Stone-

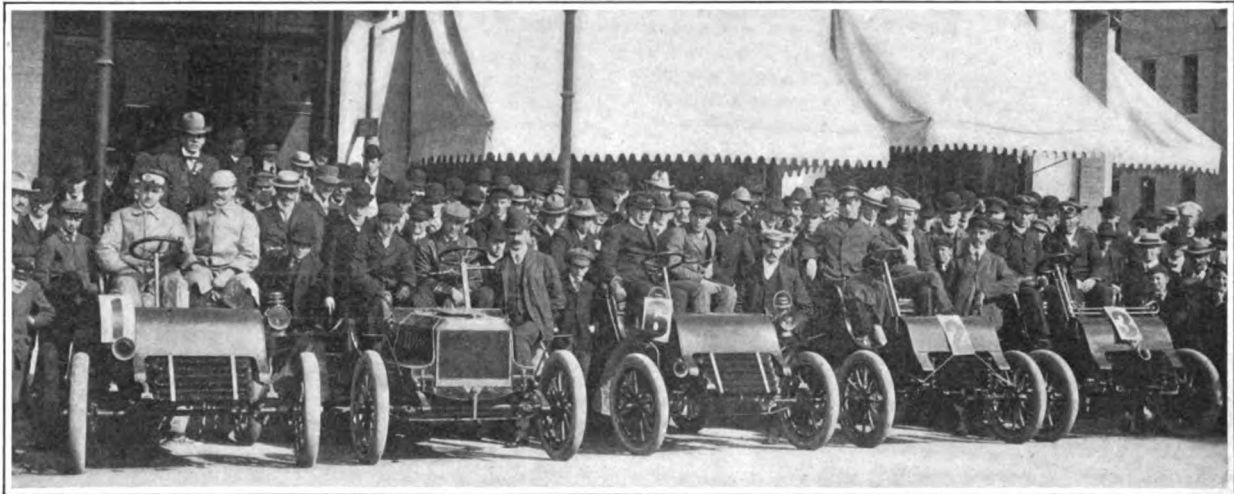

CARS AND DRIVERS THAT COMPETED IN THE FIRST AUTOMOBILE ROAD RACE HELD IN WESTERN CANADA, AT WINNIPEG.

somewhat better. The handicaps varied from 5 to almost 40 minutes, the *Lovica*, with 39 minutes 48 seconds start, being the limit boat.

The two *Nadas* were given about ten minutes' start on the scratch boats, *Red Devil* and *Now Then*, and not only held their own, but pulled away from their pursuers, *Nada III.* gaining about five minutes on *Red Devil* and nearly ten on *Now Then*. *Nada I.* did nearly as well, gaining three minutes and eight minutes, respectively, on the scratch boats. The *Nadas* easily cleaned up everything ahead of them and finished far in the lead, *Nada III.* 1 minute 16 seconds ahead of her sister boat, which was 13 minutes 25 seconds ahead of *Red Devil*, the latter leading *Now Then* across the line by 4 minutes and 55 seconds.

The fastest time over the course was made by Danzenbaker's *Unique*—57 minutes 53 seconds.

Miss Helen Godshalk handled *Nada I.*, and although beaten the young lady made

held Monday, September 5, when five cars were entered for a race to Stonewall and back, a distance of forty miles. The entries were as follows: J. K. McCulloch, 12-horsepower, Ford; H. D. McLaughlin, 12-horsepower Ford; W. C. Power, 12-horsepower Auto-Car; R. McLeod, 10-horsepower Cadillac, and J. Kelley, 10-horsepower Cadillac.

McCulloch won in the extremely good time of 1 hour 40 minutes, with McLaughlin running him very close and finishing two minutes later. Power came in third, completing the full distance in 1 hour 57 minutes. McCulloch lost more than five minutes replenishing his gasoline supply, which which became exhausted a little more than a mile from the finish, having started through an oversight with the tank only partially full.

McLeod had the misfortune to break the distance rod and severely bend the front axle of his car, and Kelley abandoned the race owing to trouble with a faulty clutch.

The road was of a varied nature, the

wall, where repairs were made in the local blacksmith shop by J. McCulloch, who, after he had finished the race, obtained the necessary tools and parts, and returned to Stonewall to help McLeod out of his trouble.

The inhabitants of French towns are "scrapping" with one another as to which place shall have the honor of being the center of the next Gordon-Bennett Cup race. Long Islanders please note.

To decide a wager that he could not cover 50,000 kilometers (approximately 31,000 miles) in twelve months' touring by automobile in Europe and Africa, M. Henriot, the French motorist, accompanied by his wife, started from Ostend last October. He recently arrived in Geneva after a run from Rome, having covered more than the required distance, his itinerary including France, Spain, Morocco, Algeria, Tripoli, Egypt and Italy. Many exciting incidents occurred en route, including being twice robbed by brigands in North Africa.

Forty Miles an Hour up Mt. Ventoux.

Rougier, in His Gordon Bennett Turcat-Mery Racer, Rises One Mile in a 13 1-2 Mile Course in 21:12 3-5.

Special Correspondence.

PARIS, Sept. 1.—The French counterpart of the American "Climb to the Clouds" is the Mont Ventoux climb, organized annually by the Vaucluse Automobile Club and *L'Auto*. The course is a mountain road, situated near Carpentras, and in places has dangerously sharp turns, necessitating the cars to come almost to a stop to get around, while much of the roadway is very rocky. The course is 21.6 kilometers (13.4 miles) in length, and rises from an altitude of 974 feet at the starting point to 6,215 feet above sea-level at the finish line at the top, the average gradient being 8 per cent. This makes a vertical rise of 5,241 feet in the 13.4 miles—or one mile lacking just 39 feet.

The third annual contest was held this year on August 27 and 28, the first day being devoted to competition by touring cars and motorcycles, and the second to racing machines. Thirteen cars competed on the first day, being classified according to price. Best time was made by Ollion in a *Rochet-Schneider*, who covered the course in 31:41 3-5, or at the rate of more than twenty-five miles an hour. Collomb, in a *Mors*, made the ascent in 33:50, taking second prize, and Bablot, in a *Berliet*, made

All of these times, fast as they seem, were vastly surpassed on the second day—Sunday—by the racing cars. Rougier, in a *Turcat-Mery*, made the climb of 13.4 miles in 21 minutes 12 2-5 seconds, breaking the previous record, held by himself, by 3 minutes 37 3-5 seconds. His speed averaged forty miles an hour. Just what this marvelous time means can be determined by computing the vertical lift, which is slightly more than four feet a second—to be exact,



A. FOURNIER, CLIMBING VENTOUX MOUNTAIN IN HOTCHKISS RACING CAR.

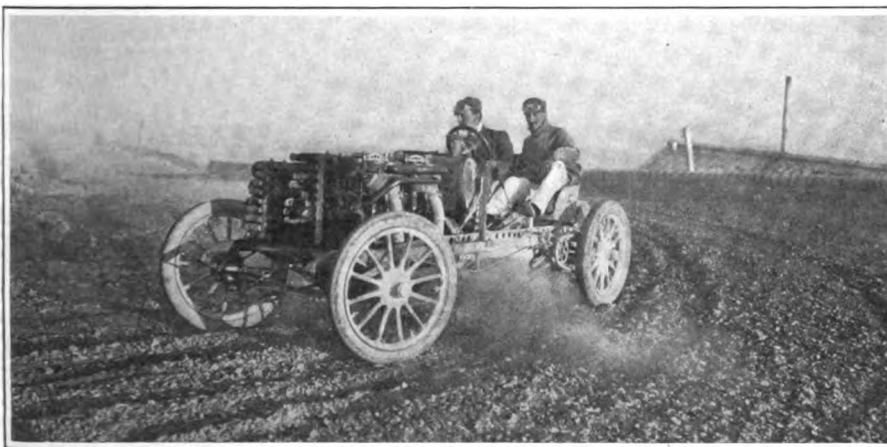

THE WINNER ROUGIER, IN TURCAT-MERY, MAKING ONE OF THE SHARP TURNS.

in 33:55 4-5, winning third. Fourth and fifth places went respectively to Eparvier (*Rochet-Schneider*) in 35:10, and Heusselin (*Rochet-Schneider*) in 35:22 1-2. All of the *Rochet-Schneider* cars were in the class for cars costing \$3,200 to \$5,000, while the *Mors* and *Berliet* were in the class for cars costing more than \$5,000. Vimont, on an *Ariès*, made a good climb in 54 minutes flat in the class for cars costing from \$1,800 to \$2,400, beating by three seconds the best time made in the class above, for cars costing from \$2,400 to \$3,200.

Lamberjack, on a *Griffon* motorcycle, made the ascent in 51:17.

4.11 feet. This is equivalent to 247 feet vertical lift a minute. The fastest passenger elevators in America run at the rate of 450 feet a minute. As the first four kilometers of the course is almost level, it is safe to say that the car rose at the rate of more than five feet a second with its own power. The car used by Rougier was the identical 45-horsepower *Turcat Méry* that Rougier drove in the Gordon Bennett race in Germany.

By way of comparison it may be recalled that Harkness, who made the best time in the Mount Washington ascent, drove 7 1-2 miles and rose 4,600 feet in

24:37 3-5 in his 60-horsepower *Mercedes* last July.

Nearly all the big European racing cars of this year and their drivers took part in the contest. Throughout Saturday night the competitors kept driving up the mountain for practice. The first official ascent was made at 9:30 a. m. by *Lancia* in a F. I. A. T. His time was 23:05 4-5, which gave him fifth place in the final results.

Duray, in a *Darracq*, made the second best time of the day—21:41, Hemery (*Darracq légère*) third—22:26, and Le Blon (*Hotchkiss*) fourth—22:49 4-5.

Hemery's time broke the record in the light racing car class, held by Danjean, by 2:59, and beat the times of the following in the heavier racing-car class: Le Blon

(*Hotchkiss*), *Lancia* (F. I. A. T.), Baras (*Darracq*), A. Fournier (*Hotchkiss*), and M. Fournier (*Wolseley*).

The *voiturette* record was reduced from 43:35 2-5 to 29:25 by Albert on a *Darracq*, Laurent, on a *Richard-Brasier*, being second in this class in 34 minutes flat.

Honors in the racing motorcycle class fell to Inghilbert, on a *Griffon*, whose time was 32:20, beating the times of Laurent and Gaudermann in the *voiturette* category.

After the conclusion of the climbing tests a banquet was held at the top of the mountain, followed in the evening by a reception at the clubhouse at Avignon.

Since the passage of the vehicle registration ordinance in Dayton, O., the city license bureau has licensed eighty-five automobiles, three motorcycles, 1,500 bicycles, and about 1,400 horse-drawn vehicles, the total revenue derived therefrom amounting to about \$4,000. The city clerk's office is still busy issuing permits.

When the smell of gasoline gets so strong that it is likewise a matter of taste, cheer yourself up with the thought that it may perhaps be acquired. Don't forget your triumph over caviar. And then, some day, some way, you may be able to get an automobile of your own, and it is a wise man who always directs his course so that he won't have too much to take back.—*Indianapolis News*.



VOL. XI.

No. 12

Published every Saturday by

THE CLASS JOURNAL CO.,
Flatiron Building, Madison Square,
NEW YORK CITY.

Cable Address - - - Autoland, New York
Long Distance Telephone - 300 Gramercy, New York

SUBSCRIPTION RATES:

United States, Canada and Mexico, - One Year, \$2.00
Other Countries in Postal Union, - One Year, \$3.00

To Subscribers—Do not send money by ordinary mail.
Remit by Draft, Post-Office or Express Money Order,
or Register your letter.

FOREIGN SUBSCRIPTION AGENTS:

ENGLAND:—Iliffe & Sons, Limited, 3 St. Beke Street,
Ludgate Circus, London, E. C.
FRANCE:—Boyveau & Chevillet, 22 Rue de la Banque,
Paris.
GERMANY:—A. Seydel, Mohrenstrasse 9, Berlin.

To Advertisers—Copy or changes in orders for advertisements should reach us not later than 5 o'clock p. m. Monday for the issue of Saturday following.

Copyright, 1904, by The Class Journal Company.
Entered at New York, N. Y., as second-class matter.

The Automobile is a consolidation of The Automobile (monthly) and the Motor Review (weekly).

Copies Printed This Issue, - - 12,500

“ “ Since Jan. 1, - 458,300

Automobiles at the World's Fair. Big buildings and big exhibits do not make an exposition. Big men in control are an essential if the exposition is to be of real value, something more than a glorified county fair. So far as the automobile exhibit at the Louisiana Purchase Exposition at St. Louis is concerned, without reference to other features of the Fair, the conception of the responsible officials is manifestly that of big little men. A great National opportunity to exhibit and exploit the greatest invention of modern times—the automobile—has slipped through their hands and a dry-as-dust collection of cars, shut out for the most part from the bulk of the transportation exhibits, is the tangible expression of their intellectual capacity. In fairness let it be said that doubtless they did the best they knew how. Ignorant of what the automobile is, or what it means to modern intense civilized life, they have given it a certain amount of floor space just as they did private carriages and farm wagons and hearses, and passed on their interest and energies to that monstrous joke in modern transportation, the dirigible balloon.

Thousands of dollars have been expended by the Fair officials in the construction of an “Aeronautic Concourse” and in the promotion and exploitation of fake contests which have neither scientific nor commer-

cial value. The net result has been the malicious destruction of the Santos-Dumont balloon and the complete and utter collapse of the much advertised race in the air. A scientific appreciation of the possibilities of the true flying machine or aeroplane would have secured proper recognition for such work of merit as has been accomplished by real investigators at home and abroad, and this without a taint of circus promotion.

From the viewpoint of the industry it is a question as to what extent the National Association of Automobile Manufacturers is censurable in weakly submitting to this sidetracking of the automobile at the Fair. Its officials seem to have acquiesced meekly in the suffocation of the American exhibit. They knew, if the World's Fair officials did not, that the automobile is essentially an exponent of motion. That an exhibit consisting solely of cars in a static condition is not of any serious educational value to that great mass of the American people which would visit the Fair and of which only a small proportion has any real acquaintance with modern rapid transit on the roads.

To have risen to the opportunity would have meant the construction of a proper track or speedway with adequate garage accommodation and room for the display of cars, so that they could be shown in operation. A well arranged and frequent series of trials, especially such as demonstrated the certainty of control in the automobile, its ability to go up grades, and these supplemented by various economy and efficiency tests, would have given the visiting public some grasp of the automobile as a means of transportation. The expense of laying out such a demonstration park would not have been great, and in the immense expanse of the Fair grounds a location would have been easily found. There was certainly no lack of matériel and the responsibility for failure rests solely with the personnel.



From the Exhibitors' Viewpoint.

Some subtle influences are responsible for the state of armed neutrality that exists between a large number of the automobile exhibitors and the Fair officials at St. Louis. Instead of co-operation there is an evident want of unity of purpose, an indifference upon the part of the Fair management that is resented by the exhibitors who have individually endeavored to contribute to the success of the Exposition. A visitor who did not look beneath the surface would not observe the real situation, but it exists nevertheless and is prejudicial to the best interests of both exhibitors and exhibition. Some of the things which denote this condition seem trivial in themselves; they are pin pricks that when oft repeated stir up anger.

First of these in point of time was the prohibition of demonstrating machines

within the grounds, following the opening of the Fair. When at length permission was granted the route to be used was of such a nature that it did not better conditions greatly. Another cause for discontent was the pettifogging cutting down of the number of lights in the American section, and the occasional turning out of all the lights at night, so that the car cleaners are hindered in their work. The N. A. A. M. employs its men to do this work, and consequently does not make use of the services of the official cleaning bureau, and exhibitors draw their own conclusions.

It is also difficult to police an exhibit properly in the dark and petty thefts in the American automobile section are frequently reported. In the earlier days of the Fair the side doors of the Transportation Building leading into this section were not locked at night.

Leaky roofs are another source of annoyance and on wet days exhibitors are kept busy moving cars out of harm's way.

Transportation Day at the Fair supplied another irritant. Previous to this a transportation exhibitors' association had been formed for the purpose of booming this day at the Fair, and to the funds of this the automobile exhibitors generally subscribed. It developed, however, that in the exploitation of this day the railroad exhibitors were getting the lion's share of publicity. At the same time one of the French exhibitors who had taken a powerful car out into the grounds so as to try whether or not it could be driven slowly enough to take part in the Transportation Day parade was roughly handled by armed guards and the machine damaged. An indignation meeting of automobile exhibitors was the result, and it was at first decided not to enter any machines in the parade, although later several of the American exhibitors were induced to loan cars to help make the parade a success.

Another attack came from the State Commissioners' organization which, however, has no official connection with the Fair management. This organization sought to have the speed of all exhibitors' automobiles reduced to “one mile an hour” within the grounds. President Francis, to whom this request was made, happily ignored it.

Later the situation has cleared somewhat, as visitors' automobiles are now allowed within the grounds under proper restrictions and it is to be hoped that in the closing days of the Fair, which will doubtless be the best attended, a more helpful spirit will be displayed, and that no unpleasant memories will be carried away by the automobile exhibitors.



Automobile Fire Engines.

The rapid spread and brilliant promise of the self-propelled pleasure vehicle is, perhaps, liable to obscure our perception of what is certain before many years to be accomplished with motor vehicles in the commercial and similar fields.

It is a trite observation that the commercial vehicle is a more difficult problem than the pleasure vehicle, because it must demonstrate an economy in operating cost, wages, maintenance and fuel, and a freedom from accidental stoppage, at least equal to the best that can be done with horses, before it is entitled to be considered at all. It is this fact, so wholly unlike the considerations obtaining amongst pleasure vehicles, which has driven all manufacturers into getting their experience with the latter. When the problems of reliability, efficiency and economy have been fully solved for pleasure cars, it will not take long to differentiate the proper forms of running gear, motor and transmission for this and that commercial use.

Among the numberless utilitarian services to which the motor vehicle can, and some day will, be put, perhaps none is more interesting than the fire engine. The present type of fire engine has reached the limit of its development, since it cannot be made materially lighter, and three horses cannot pull a heavier load. To increase the power, it would be necessary to mount the boiler separately from the engine and pumps, which would manifestly be impracticable. Building development, however, has not reached its limit, and the logical necessity for greater power is apparent. Equally evident is the need for greater speed, and this, too, can be had by motor propulsion.

Steam driven fire engines have been, more or less, experimental constructions for the past twenty years at least, and latterly they have been, for experiments, rather frequently reported, both in this country and in England. But we may be sure that the explosion motor is only awaiting its finishing touches, so to say, to become the motive power *par excellence* for this service. It is both simpler and lighter than steam, and when the perfected kerosene oil engine has arrived it will be equally safe. Its possibilities in the way of attaining considerable powers within moderate limits of weight are indicated by the most recent racing machines. These will develop 100-horsepower or more on a total weight, without supplies, of about one ton. Few if any fire engines, we venture to say, develop more than half that power. The self-propelled fire engine would be little more than a highly developed motor wagon, with a pump so attached that the motor could drive either the vehicle or the pump. Such a machine could be built of ample strength and solidity without going beyond the weight of the horse-drawn steam fire engine, and it would have double or treble the power.

"Oh, my, yes, the Fizzletons are a very proud family."

"Have they a coat of arms?"

"No; but their automobile is almost covered with tags and numbers that they had to have put on it in Europe."—*Record-Herald* (Chicago).

CANADIAN MOTORING CENTERED IN TORONTO.

Lively Interest in Runs and Racing Fostered by Thriving Automobile Club—Leading Dealers Handling Many American Cars.

Special Correspondence.

TORONTO, Can., Sept. 12.—Of the 600 automobiles licensed in the province of Ontario, 350 are owned in this city. Toronto is, in truth, the hub of automobiling in Canada, although Montreal, Hamilton and London are beginning to vie with it in enthusiasm. Most of the pioneer Canadian automobilists live here, the first car owned in Toronto, a Winton phaeton, having been imported by John Eaton in 1898. Mr. Eaton now rides in a \$7,500 Packard car.

Last year the sport took hold in earnest of the wealthier citizens, and many new cars appeared, but their number has been more than trebled during the present season.

Under such conditions it is not surprising that the Toronto Automobile Club is flourishing. It is a wide-awake organization of about one hundred members, formed a little more than a year ago. One of its first acts was to assist the Legislature in drafting a bill to regulate the speed of automobiles on the public highways. The speed was fixed at fifteen miles an hour in country districts and at nine miles an hour in towns and cities. The province imposes a license fee of \$3 for the first year, and \$1 a year thereafter.

The by-laws of the club are very strict, requiring members to stop on the highway at the request of the driver of a restive horse. The club discountenances furious driving and stands for a reasonable and careful use of the highway, with due consideration for the rights and comfort of others.

The officers of the organization are: President, Dr. P. E. Doolittle; vice-president, W. A. Kemp; secretary-treasurer, Charles Webster; executive committee, A. E. Chatterton, F. W. Baillie, J. T. Packer, W. C. Gunnex, A. L. Massey and Murray Wilson.

Conditions in Toronto are favorable to the growth of automobiling. Nearly all of the city streets are paved with asphalt, and the abundance of trees and parks renders city runs most attractive. Country roads leading from the city are fairly good, while the scenery is fine, particularly along the shore of Lake Ontario. The three favorite runs are from Toronto to Cobourg, by the Kingston Road; Toronto to Hamilton and Niagara Falls, and Toronto to Jackson's Point, or Lake Simcoe. The automobile club has issued a neat pamphlet giving a complete description of the various routes as a guide to members.

A considerable number of club runs have been made, the more important being to Oshawa, to Cobourg, to Markham, to Buffalo and to Jackson's Point, on Lake Simcoe. At present the executive is planning for a long run to Montreal and Quebec, which will occupy three days.

About a month ago the Toronto club fitted up handsome clubrooms in the King Edward Hotel. The opening of these quarters was the occasion for special visits from the Cleveland and Buffalo automobile clubs, members of which made some fast times on the run between Niagara Falls and Toronto. The visiting sportsmen were entertained by their Toronto fellow devotees with a run around the city during the day, and a supper and smoking concert in the evening.

The first successful automobile race met

in Canada was held at the Exhibition Park track a month ago, under the auspices of the automobile club. Held on a Saturday afternoon, the races were attended by fully 5,000 spectators, and the greatest interest was evinced in the various events, all of which were keenly contested. The feature of the day was the exhibition riding of Barney Oldfield, who did three miles on the half-mile track in 3:57 2-5. F. W. Baillie was the local motorist who most distinguished himself driving an up-to-date Peerless car. The officials of the club were well pleased with the success of the meet.

Three of the leading automobile dealers in Canada have their headquarters here, namely, the Canada Cycle & Motor Company, Hyslop Bros., and the Automobile & Supply Company. The first two concerns have branch houses in Winnipeg, Man.

The Canada Cycle & Motor Co. is the largest dealer in the country, and handles the following American cars: Peerless, Ford, Packard, Stevens, Duryea, Thomas, Autocar and Mitchell. It also sells the Ivanhoe, an electric runabout of its own manufacture, which has become quite popular.

The Automobile & Supply Company has done a large business, selling the Winton, Rambler and Columbia. G. H. Gooderham, a local manufacturer and capitalist, is president of this company.

Hyslop Bros. were former rivals of the Canada Cycle & Motor Co. in the sale of bicycles and, like that concern, have taken up automobiles. They sell the Yale, Cadillac and Oldsmobile.

STRIKE AT UNSANCTIONED SHOWS.

A cast-iron rule and agreement explicitly providing that no manufacturer of automobiles, parts or supplies, who applies for exhibition space at either of the national shows or any of the local automobile exhibitions sanctioned by the National Association of Automobile Manufacturers, Inc., shall exhibit or permit to be exhibited after September 1, 1904, any of his products at any show not sanctioned by the N. A. A. M. under penalty of forfeiture of his space and right to exhibit at sanctioned shows, was adopted at the meeting of the executive committee of the N. A. A. M. held September 7.

The resolution covering the matter is very prolix and involved, having been written with the intention of leaving no loophole by which a maker or dealer could display his goods at an unsanctioned show without suffering the penalty of disbarment from the sanctioned shows, the purpose of the N. A. A. M. being, of course, to get the absolute control of both national and local exhibitions into its own hands, so that manufacturers will not be burdened with an undesirable number of shows and will have a guarantee of good faith on the part of the promoters and managers, especially of the exhibitions in the smaller cities.

Writing from Rouen, American Consul Haynes states that the Ceylon government is considering the proposition of substituting, on all suitable roads, light automobiles for the old stage coaches that are still being used on important routes for mail and passenger traffic. The speed required is thirty miles an hour, and each vehicle must carry six passengers, 300 pounds of letters and 26 pounds of baggage.

Seventy-three automobiles are owned and operated in Des Moines, Ia., of which fifty-one are gasoline, eleven electric and eleven steam vehicles.

CLUB CAUTIONS DRIVERS.

Cleveland A. C. Wants to Allay Public Feeling and Modify Legislation.

Special Correspondence.

CLEVELAND, Sept. 10.—The serious matter of the increasing number of violations of the speed regulations was discussed at a recent meeting of the board of governors of the Cleveland Automobile Club, and it was decided to send to every automobile owner and operator in the city a letter urging the exercise of caution as to speed. It was the opinion of the governors that the recklessness of a few drivers was the cause of growing public animosity toward motorists in general, and that they were responsible for the feeling of the city authorities and the magistrates that the present ordinance regulating the use of motor vehicles does not provide sufficiently stringent punishment for violators.

Members of the city council are contemplating the advisability of amending the ordinance so as to provide for imprisonment as well as for fines. The magistrates, finding that the light fines formerly imposed upon reckless drivers who were brought into court failed to correct the nuisance, have lately been imposing the heaviest fines provided for by the ordinance. Some days ago an attempt was made to send one offender to the workhouse, on the charge of disorderly conduct, but the police judge decided that to be guilty of disorderly conduct one must commit an act that disturbed many persons. He thought an automobile scorcher disturbed only the persons who happened to be in the street in front of the machine. The judge also held that the act of exceeding speed limits was already covered by city and state laws, and that it would not be legal to prosecute offenders under acts relating to disorderly conduct.

MILWAUKEE AUTO REGULATIONS.

Special Correspondence.

MILWAUKEE, Sept. 10.—A substitute for the licensing and numbering ordinance was passed and was signed Friday. It will go into effect next Wednesday. The new measure contains many of the provisions of the previous ordinance, except that it raises the speed limit from eight miles to twelve miles an hour, and substitutes a \$1 permanent certificate for the annual license fee of \$1, which the automobile club holds is unconstitutional.

The salient features of the substitute ordinance are as follows:

Owners of automobiles shall file name and address, as well as description, with city clerk, and shall be given, for a fee of \$1, a numbered certificate. Certificates shall be good as long as the owner keeps his machine.

Owners shall equip machines with number of certificate in Arabic numerals of white metal on a black background, four inches high, two inches wide, and one inch between figures. This number shall be followed by the letter "M" for Milwaukee. Numbers shall be attached in conspicuous place in rear of machine.

No machine shall be operated by persons without full use of both hands and arms and over the age of eighteen years.

Speed limit twelve miles an hour instead of eight.

No part of machine or motor shall be kept running when automobile is standing in street without attendant.

Non residents are exempted from provisions of ordinance if they have complied with a similar law in home city. Otherwise they must apply for registration within forty-eight hours after arrival.

All provisions of the ordinance apply to motor cycles, except that numbers need be only one inch in height.

Secretary Drought, of the automobile club, in discussing the matter, said: "The automobile club is in favor of all just and equitable regulation of automobiles. We deplore the fact that some reckless automobilists are careless in the use of their machines. In drawing up the substitute ordinance it was our object to present a measure to the council that would be fair to the public as well as to the automobilist. If it becomes a law we shall do everything in our power to assist the city in enforcing its provisions."

WHITE MOUNTAINS FALL TOUR.

A sort of celebration in honor of the "arrival," as the French say, of the automobile in the White Mountains, of which the "Climb to the Clouds" was the precursor, will be held at Bretton Woods on the evening of Saturday, October 1, when an automobile tour will be brought to a conclusion by a banquet at the Mount Pleasant Hotel, given by Messrs. Anderson and Price, proprietors of the Mount Pleasant and the Mount Washington hotels.

The tour, which will be called the Bretton Woods Perfection Tour, will start from Boston probably September 29, two days being allowed for reaching Bretton Woods by easy running. A minimum time limit will be set, and those who exceed the speed called for by this limit will be disqualified. Fast driving will not be tolerated. Invitations to the number of 100 or more will be issued for this trip, and participants will be asked to take an observer as passenger. The prizes will be gold, silver and bronze medals.

Given fine weather, this tour should be a most delightful one, for in early October the crisp mountain air, the brilliant autumnal foliage and the picturesque drives are at their best. Full details as to routes, distances and other particulars can be obtained from W. J. Morgan, 1 Maiden Lane, New York.

SEARCHLIGHTS PROHIBITED IN PARK.

Special Correspondence.

PHILADELPHIA, Sept. 12.—The objection of local horse drivers to automobile searchlights, as outlined in these columns last week, have borne fruit in a ukase, issued last Friday by the Fairmount Park Commission, prohibiting the use of searchlights within the limits of the people's pleasure ground.

Colonel Snowton, who presided at the meeting of the commission, was of the opinion that the swinging searchlights frightened horses and that they were not at all necessary in the park, the roads all being well lighted. There was some discussion of the subject, but when the vote was taken on the question the majority was with the colonel.

It was further specified that every automobile shall carry two lights in front—one on each side—and one in the rear.

The Schenectady Railway Company is preparing to install two motor omnibuses on its road between Loudonville and Albany. The vehicles will be of 40-horsepower and of twenty-passenger capacity.

Judge Caleb H. Norris and his wife, of Marion, O., have reached their home after a two weeks' automobile tour. After touring for several days in Massachusetts, the Gettysburg battlefield was visited, and from there Judge Norris drove the machine to Marion without accident of any consequence.

AN INTER-CLUB VISIT.

Three Score Members of Chicago A. C. Are Guests of Grand Rapids Club.

Special Correspondence.

CHICAGO, Sept. 12.—Eighty-nine members of the Chicago Automobile Club, with thirty-one cars, accepted the invitation of the Grand Rapids Automobile Club to be its guests Saturday and Sunday and participate in an owners' matinee race meet open only to members of the two clubs.

The visitors assembled Friday evening at the Michigan avenue clubhouse, where dinner was served, and then the steamer *City of Holland* was boarded at 8 o'clock for an all-night ride across the lake. The run of thirty miles from Holland to Grand Rapids, Mich., was made without particular incident, the Grand Rapids club escorting the Chicagoans.

Frank X. Mudd, chairman of the runs and tours committee of the C. A. C., acted as starter at the races, and the judges were Dr. J. B. Weintraub and Vice-President W. G. Lloyd, of the C. A. C., and Charles B. Judd, of Grand Rapids.

The summary of the races follows:

One mile for runabouts costing \$800 or less—J. C. Bronson, Autocar, 1st; G. S. Chapin, Ford, 2d; Frank X. Mudd, Cadillac, 3d. Time, 2:01 3-5.

Three miles for touring cars costing \$2,000 or less—John E. Thoma, Rambler, 1st; O. E. Schell, Michigan, 2d; A. B. Richmond, Rambler, 3d. Time, 5:29.

Two miles for touring cars, \$1,200 or less—O. E. Schell, Michigan, 1st; John E. Thomas, Rambler, 2d; J. C. Bronson, Autocar, 3d. Time, 3:43 1-5.

Five miles for touring cars, \$3,500 or less—John E. Fry, Apperson *Jackrabbit*, 1st; Mortimer Luce, Royal Tourist, 2d; Walter Austin, Austin, 3d. Time, 8:21.

Ten-mile handicap, free-for-all—Sidney S. Gorham, Winton, handicap 1½ minutes, 1st; Dr. Frank H. Davis, Winton, 2 minutes, 2d; J. C. Bronson, Autocar, 1 minute, 3d; John E. Fry, *Jackrabbit*, scratch, 4th. Time, 20:25 1-5.

NUMBERS REQUIRED IN COLUMBUS.

Special Correspondence.

COLUMBUS, O., Sept. 12.—Some weeks ago the city council of Columbus passed an ordinance requiring automobiles to be numbered, and this week City Auditor Noble is sending out notices to owners of automobiles to appear at the city hall and secure numbers for their cars. The fee is \$1. The number is of aluminum on a black leather background.

In anticipation of the passage of the vehicle tax ordinance, which was drawn to virtually incorporate the identification measure, and about whose constitutionality there was some question, City Solicitor Butler at first advised the city auditor to hold up the numbering ordinance, but later advised that it be put into effect at once as the vehicle tax measure will not pass the council for some time.

PROPOSED SPEEDWAY IN CHICAGO.

Special Correspondence.

CHICAGO, Sept. 12.—A speedway for automobiles is now being talked of by members of the Chicago Automobile Club and the suggestion is made that the strip of land east of the Illinois Central railroad between 29th and 50th streets could be made into a first-class speedway. Several large property owners and residents along the proposed route have expressed themselves in favor of the project, and the matter will be submitted to the city council in the near future.



The Automobile Club of America has received a letter from the Department of Commerce and Labor at Washington stating that the Department has nothing whatever to do with either the interpretation or the enforcement of the law governing the transportation of explosives on ferry boats, which, amended somewhat, restricts the use of ferries by gasoline or steam automobiles to machines having power completely shut off. The only course left open to the club is to bring a test case in the courts or to make an endeavor to have the law changed sufficiently to eliminate the clauses causing hardship to automobilists, who now have to push their cars on and off of the ferries by hand, or else have them towed. The Secretary of the Department of Commerce and Labor further stated that the interpretation of the statute was vested solely in the courts, and no interpretation from any other source could have any value whatever. No definite plan of action has been decided upon by the A.C.A., but it is likely that a test case will be instituted for the purpose of obtaining an interpretation of the law from the courts, and also that Congress will be asked to modify the existing law so as to give relief to the automobilists.

* * *

A meeting of the Association of Licensed Automobile Manufacturers held at the association's headquarters, 7 East 42d street, New York, September 8, was attended by thirty members. Discussion was mainly of an informal character, and consisted of an exchange of experiences, views and opinions concerning prices, and the automobile business generally. It was decided to stop the practice of allowing commissions to persons other than regular agents. It was also decided that contracts between members of the Association and their agents should be made terminable at the will of either party, thus avoiding the possibility of either being hampered, in case of unsatisfactory conditions, by an unexpired agreement.

* * *

Interest in the automobile race meet to be held at the Empire track, Yonkers, September 24, will be augmented by the fact that a silver trophy has been offered for the lowering of Kiser's record of 52 4-5 seconds for the mile. It is expected that Carl Fisher will be on the track with his Premier *Comet* for the sole purpose of attacking this record. Another fast car entered is the skeleton racer recently built by Henry Ford, of 999 fame. Kenneth Skinner and A. E. Morrison, of Boston, are both expected to be among the competitors.

* * *

Much comment has been aroused by the offer of M. Charley, of Paris, the Mercedes agent, to donate \$10,000 as a prize for the first motor boat to cross the Atlantic from Havre to New York. The offer does not extend to boats crossing in the opposite direction. The opinion among automobilists seems to be that such a feat is practically impossible, and doubtless it is, so far as the racing type of auto-boat is concerned. Apparently, however, there is no reason why a properly built cruising launch could not do the trick. The only serious problem would be the storage of sufficient fuel to enable the boat to make the journey. A motor-boat has already crossed the Atlantic without serious difficulty. This was a 38-foot launch with 9-foot beam, propelled by

a 10-horsepower kerosene motor. The launch was of the trunk cabin type, and had not the slightest difficulty in weathering the several storms encountered, although the crew, consisting of a retired sea-captain and his sixteen-year-old son, suffered greatly from exhaustion and exposure. The fuel tanks carried 800 gallons of kerosene, which was found to be more than ample for the trip. The engine, which was of the explosive type, gave practically no trouble, and, with the launch, is still in commission in Australia.

* * *

Auto-boat races will be held September 21, 22 and 23 on the Hudson River off the clubhouse of the Columbia Yacht Club, when the Challenge Cup of the American Power Boat Association will be raced for. The *Standard*, now in the Thousand Islands, won the cup last June, but she will not be on hand to defend her title to it. The list of entries is a most interesting one, and if even a part of the fleet turns up at the starting point some fine racing may be expected. Among the boats are such fliers as W. K. Vanderbilt's new *Mercedes*, *Vingt-et-Un II.*, the Lozier boat *Shooting Star*, the new Fiat boat *Macaroni*, and the *Challenger*, Smith & Mabley's 150-horsepower Harmsworth racer, which has not really had a chance to show her best speed in a race. The other entries are *Marcerene II.*, *Mercedes II.*, *Regina*, *Catch Me*, *Josephine*, *Logarithm* and *Cricket*.

* * *

The dinner and meeting of the New York Automobile Trade Association last week was attended by seventeen members, the principal subject for discussion being the chauffeur problem. It was decided that chauffeurs registering with the association's registration bureau must bring the endorsement of some garage as well as references from former employers. This bureau is in charge of John F. Plummer, of the Locomobile Company of America; H. R. Worthington, of the Worthington Automobile Company, and W. P. Kennedy, secretary of the Trade Association. The names of chauffeurs registered at Albany will be sent to garages throughout the country for the purpose of discovering any drivers who are, for any reason, objectionable.

* * *

The big sight-seeing automobiles which start from the Flatiron building may have to operate under a charter hereafter. The operator of one of the vehicles was arrested a few days ago, charged with driving a stage that was not run under a permit from the Board of Aldermen, as required by the city charter. The magistrate discharged the chauffeur, and advised the automobile company that a permit must be secured. It has been hinted that jealousy of the cabmen and horse-drawn stage company is at the bottom of the trouble.

* * *

Automobiles played an important part in the battle of votes waged recently in Rye, N. Y., the bone of contention being the incorporation of Rye as a village. The votes in favor of incorporation were greatly in the majority, and it is said that the fact that automobile owners used their cars to take voters to the polls had a good deal to do with the size of the vote on the winning side. Most of the voters on the other side

went to the polls in the good old-fashioned way—on foot.

* * *

Newspaper reports of the collision of the Seabury auto-boat *Speedway* with a pier of the 127th street bridge over the Harlem River last week are amusing, in the light of the facts of the case. The boat was not running at full speed at the time, or the results might have been serious. While approaching the bridge on a trial run, the casting on one side of the rudder head gave way, throwing the rudder to one side. Being close to the bridge, it was impossible to avoid colliding with the pier; but, though the bow was considerably damaged, no one was thrown overboard, and Mr. Seabury, who was at the wheel, did not even get his feet wet. The damage has now been repaired and the boat is ready for the water. She is a 40-foot racing machine, and belongs to the Charles L. Seabury Company, by which she was built.

* * *

A fall tour will be held by the Automobile Club of America commencing on October 10 and continuing for five days. The route will be from New York to Delaware Water Gap, Philadelphia, Atlantic City, Lakewood and back to New York a total distance of about 374 miles over roads which are mainly good.

* * *

Magistrate Cornell, in a recent decision, expressed the opinion that if the owner of an automobile was in the machine when it was speeding beyond the legal limit, he, and not the chauffeur, should be made to suffer the penalty of the law, and that he should be sent to jail instead of fined.

*

The Duerr-Ward Co., Broadway and 58th street, Manhattan, has renewed the agency for the Royal Tourist cars for 1905, and has placed a larger order than that of this year. The company sold four of these cars last week.

* * *

The Long Island Automobile Club has extended the free use of its garage and club facilities to competitors in the forthcoming Vanderbilt Cup Race for their racing and touring cars, and all members of clubs affiliated with the A. A. A. are invited to make full use of the club while in attendance upon the race, this privilege extending from September 15 to October 8, the day on which the race will be held.

* * *

Charles Sweeny, of Spokane, Wash., president of the American Smelting Co., has recently purchased through Hollender & Tangeman, of New York, a F. I. A. T. touring car. The machine is of 24-30 horsepower, upholstered and finished all in white.

* * *

Mr. and Mrs. Henry Heert, of New York, are driving to the World's Fair in a 22-horsepower Richard-Brasier car. They are making the trip leisurely, purely for pleasure, and, after a stay in St. Louis, will return to New York in the car.

* * *

E. C. Bald, the former bicycle champion, will make his debut as an automobile racer at the Poughkeepsie meet September 16, when he will drive a stripped Columbia stock car.

AMERICAN AND FOREIGN AUTOMOBILE AND AUTO BOAT FIXTURES.

Sept. 17.—Race Meet, Pittsfield, Mass. Brokshire A. C.
Sept. 17.—Auto-Boat Challenge Cup Races. Hudson River, N. Y. C. American Power-Boat Assn.
Sept. 17.—Race Meet, Island Park. Albany, A. C.
Sept. 21-Oct. 1.—Coast Endurance Run, San Francisco. Los Angeles, Calif.
Sept. 23.—Chateau-Thierry Race for Touring Cars. A. C. of France.
Sept. 23-24.—Race Meet, Brunots Island, Pittsburg. A. C. of Pittsburg.
Sept. 24.—Race Meet, Empire City Track, Yonkers, N. Y.
Sept. 25.—International Motorcycle Race, France. A. C. of France.
Sept. 30.—Gallion Races for Speed Cars, France.

Sept. 30-Oct. 1.—Race Meet, Harlem Track, Chicago. Chicago A. C.
Sept. 30-Oct. 1.—Race Meet, Rockford, Ill. Rockford A. C.
Oct. 1.—Race Meet, Point Breeze, Philadelphia. A. C. of Philadelphia.
Oct. 5.—Dourdan Kilometer Trials. Monde Sportif.
Oct. 8.—Vanderbilt Cup Race, Long Island, N. Y.
Oct. 9.—Gallion Hill-Climbing Contests, France. L'Auto.
Oct. 14-22.—Leipzig Cycle and Motor Show, Germany.
Nov. 20.—French 100-Kilometer Trials, Algeria.
Dec. 9.—Opening of French Automobile Salon. Paris.
Dec. 26-Jan. 2.—Reliability Trials. Motor Union of Western India.

ROCKFORD RACE MEET PROGRAM.

Special Correspondence.

ROCKFORD, Ill., Sept. 12.—Plans for the race meet schedule to be held under the auspices of the Rockford A. C., at the Rockford driving park track September 30 and October 1 are fast nearing completion. The track is being put in shape, and some interesting races are expected. The program as now arranged is as follows:

September 30.—Five-mile race for club stock gasoline cars, 10-horsepower and less; one mile for club electric cars; five miles for club stock gasoline cars from 10 to 16-horsepower; five-mile for motorcycles; ten-mile free-for-all; quarter-mile slow race, free-for-all.

October 1.—Fifty-mile non-stop challenge race for club two-cylinder gasoline cars; ten miles for gasoline machines from 16 to 24-horsepower; fifteen-mile free-for-all; one-mile obstacle race; ten-mile handicap; speed trials; three-mile race for women drivers; three-mile motorcycle race.

CONTRACTS FOR R. E. OLDS PLANT

The R. E. Olds Company, recently incorporated at Lansing, Mich., has purchased for the site of its automobile works a twenty-acre tract—more than eight blocks—in the southern part of the city, and work has been started on the new plant. The property is so located that it affords connection with the Lake Shore and the Grand Trunk railroads, and spur tracks from each have been run into the property. Contracts have been awarded to Lansing firms for the construction of four brick buildings, with concrete foundations, which will comprise the greater portion of the factory. The dimensions of these are 70 by 700 feet, 60 by 500 feet, and two 70 by 500 feet. The plans also include an office building, two stories in height, 50 by 100 feet, and a track for the testing of machines. The contractors' bonds as filed call for the completion and delivery of the buildings within ninety days.

NEWS NOTES OF THE CLUBS.

MONTREAL.—The St. Louis Auto Club has been formed with a capital stock of \$20,000. Articles of incorporation give permission to hold lands, buildings, privileges on land or water in or about Lachine, or elsewhere, to erect clubhouses, and also to promote automobile and other sports.

HARTFORD, Conn.—The Hartford Motorcycle Club has been formed with twenty-two charter members. There are forty-five owners of machines in the city, and it is the hope of the club to induce all of those to become members. The following officers were elected: J. M. O'Malley, president; William Holtz, vice-president; Joseph Dalton, secretary; Alexander Smith, treasurer, and John O'Connor, captain.

LACROSSE, WIS.—Formation of a stock

company with a capital of \$10,000 is the latest development in the plans for the organization of an automobile club at La Crosse. The greater portion of the capital is intended to be used in securing and maintaining a garage. A committee has been appointed to complete the subscription list, and when this is done articles of incorporation will be filed.

CHICAGO.—At a recent meeting of the directors of the Chicago Automobile Club the following persons were admitted to membership: Elmer H. Adams, C. Roy Clough, Felix A. Cyr, A. B. Carson, James Deering, Ezra C. Fahrney, W. H. Fahrney, Otis C. Friend, Glenn C. Forgy, George S. Greenberg, Arthur L. Moore; John J. Mitchell, president Illinois Trust and Savings Bank; Charles Pope; James A. Reising; Byron L. Smith, president Northern Trust Company; Robert C. Tennant, William T. Woodley, Clyde P. Warner, E. C. Noe; John C. Shaffer, publisher Chicago Evening Post.

DALLAS, Tex.—The Dallas Automobile Club has accepted an invitation from the State Fair Association to hold a parade October 8, during the Texas Grand Festival, and also to give exhibition runs on the track on the two Sundays during the Festival. The resignation of Gross Scruggs, secretary of the club, was accepted, and George Schofield was elected to fill the vacancy. It was also decided to begin a campaign to increase the membership, and Messrs. Hill, Scruggs and Cameron were appointed a committee to conduct a canvass among local motorists not now members for the purpose of inducing them to join.

RECENT INCORPORATIONS.

Greater New York Auto-Bus Co., Washington, D. C.; capital, \$250,000. Incorporators, James F. Reddy, James T. Brody, John T. Bradley, all of Philadelphia; S. A. Terry, E. W. McCormick, William Wagner, B. E. T. Kretschmann, and E. M. Freeman.

Auto Engine Works, Minneapolis, Minn.; capital, \$200,000; to manufacture and sell engines, automobiles, launches, inspection cars and other machines, and parts and supplies. Incorporators, Charles H. Scholer, William T. Rogers and William J. West, of Minneapolis.

Northwestern Mfg. Co., Milwaukee, Wis.; capital, \$60,000; to manufacture and deal in dynamos and motors. Incorporators, William P. Harper, William S. Smith and John F. Harper.

The Webb Co., Newark, N. J.; capital, \$50,000; to manufacture motor vehicles and machinery. Incorporators, Walter H. Bond, Paul Munter and Joseph Gerrardt.

Mathewson Automobile Co., Denver, Colo.; capital, \$10,000. Incorporators, Linn Mathewson, Fred W. Bailey and Fred V. Parks, of Denver.

The Consolidated Construction & Power Co., Ltd., Montreal, Canada; capital, \$100,000; to manufacture automobiles.

NEWS AND TRADE MISCELLANY.

The Cadillac Automobile Co., of Detroit, will put a four-cylinder touring car on the market next season, it is reported.

Thomas B. Jeffery, maker of the Rambler automobiles, accompanied by his wife, has recently been touring in New England.

The Ford Motor Company has leased a repair shop, storehouse and store at 147 Columbus avenue, Boston, Mass., where customers can be given the best of attention.

In their automobile trip on rails to the Pacific coast, Charles J. Glidden and wife have reached Moose Jaw in Northwestern Canada. To that point they had traveled 720 miles on the rails.

James Joyce, for some time past superintendent of the Electric Vehicle Co., of Hartford, Conn., has been made general manager of the sales department. George Wesley succeeds to the superintendency.

The sales department of the Black Diamond Automobile Co., Utica, N. Y., manufacturer of the Buckmobile, has been placed in charge of A. S. Robinson, formerly purchasing agent for the Searchmont Automobile Co.

Automobilists of Lincoln, Neb., are planning to hold an automobile race meet during the fair to be held early in October. A committee on arrangements is now trying to interest motorists throughout the State in the races.

An association, with a capital of \$20,000, has been formed in Havana, Cuba, having for its object the promotion of automobile races. Efforts are now on foot to hold a race meet in that city in February, 1905. Local motorists are enthusiastic over the prospects, and it is believed a successful meet can be had.

The Winton Motor Carriage Company has established a European branch at 48 Holborn Viaduct, London, E. C., England, where a complete line of Winton cars and parts will be carried. The new branch will be in charge of William L. Duck, an Englishman who has had a wide experience in the automobile business.

An unprecedented demand is reported at this early date for winter accommodations at Hotel Ormond and the Ormond Inn, Ormond, Fla. An addition of 100 rooms is being added to the former, but from the present outlook the house will be crowded. Many of the guests will go from New York, most of whom it is reported will ship touring cars for use throughout the winter.

September 17 will be automobile day at the State Fair in Topeka, Kan. Three races have been arranged, as follows: Two-mile dash for machines not exceeding 6 horsepower; three-mile race for machines of 10 horsepower, or less, and a five-mile race for machines of more than 10 horsepower. Cash prizes from \$100 to \$300 are offered for the different events, the races being open to all.

THE AUTOMOBILE

WEEKLY

NEW YORK—SATURDAY, SEPTEMBER 24, 1904—CHICAGO

10 CENTS

VANDERBILT CUP RACE ACCOMMODATIONS.

FOLLOWING in public importance the definite location of the Vanderbilt Cup course and the securing of legal consent to hold the race on October 8 comes the question of accommodations for the thousands of automobilists and others who will doubtless be in attendance to witness the race. Although no official an-

is widely known among automobilists in the metropolitan district, is very centrally situated in the triangle formed by the course. As reference to the map on page 349 will show, it is situated about midway between the east and west boundaries of the course and a little north of the centre. Already many of the officials and intending

ment, and consequently the accommodations which are available for race visitors are restricted. There are, however, a number of comfortable houses, styled "cottages," in the thirty acres of park that surround the hotel, and in these many of the automobilists can be housed, the hotel being used for dining. Among the modern features of the



FRESHLY OILED STRETCH OF ROAD ON JERICHO TURNPIKE IN NEW HYDE PARK ON VANDERBILT CUP RACE COURSE.

nouncement has been made on the subject, the real headquarters of the race management and of those most prominently identified with the sport will be at the Garden City Hotel on Long Island. This fine establishment, which was used as country headquarters by the Automobile Club of America for two seasons, and consequently

spectators have taken quarters there, and the official weighing-in will take place in the garage near the hotel on Friday afternoon, October 7.

The Garden City Hotel is much frequented by wealthy New Yorkers, to whom it answers the purpose of a country seat without the cares of an independent establish-

ment that are attractive to automobilists is the big marble pool, in which an invigorating swim is refreshing after dusty travel on the road. Special arrangements are being made at the hotel to serve meals on the day of the race to persons who may drive down for the day only. Good roads lead from the hotel to various points on



BIRD'S-EYE VIEW OF GARDEN CITY, LONG ISLAND.—HOTEL WHERE RACE HEADQUARTERS WILL BE ESTABLISHED ON LEFT.

the course, and the visitor who enters the triangle in the morning can thus drive to and from the hotel without crossing the course. More than 1,000 persons can be taken care of throughout the day in this way. Spectators who occupy seats in the grand stand will also be supplied with luncheons in boxes by giving timely notice of their needs at the headquarters hotel.

Among those who have already secured quarters here are the following:

President W. E. Scarritt, A.C.A.; Col. Albert Pope, Clarence G. Dinsmore, Frank Croker, W. C. Temple, Pittsburg; F. C. Donald, Chicago; F. G. Webb, Harlan W. Whipple, C. R. Mabley, William Wallace, Boston; Windsor T. White, Cleveland.

Accommodations along the course and in its immediate vicinity are not of the most inviting character, except in a very few isolated cases. Nearly all of the so-called "hotels" are merely country roadhouses, a saloon on the first floor being the proprietor's principal source of revenue. These houses are usually small two-story frame structures, standing close to the highway at crossroads, and in which mechanics and local tradespeople are boarded and lodged.

The number of vacant rooms in each available for accommodation of those who will want to sleep on the course on the night of October 7 is small. Many of these roadhouses can provide food for a number of persons in addition to those who are lodged in them. Unless the number of spectators who go out from New York to see the contest is very large, the majority will probably not have to go hungry for any great length of time. But if the race draws out anything like the number that ought to attend the first great automobile road race

ever held in America, the over-night accommodations will be quite inadequate. In all the villages and hamlets on the course and inside of the triangle there are barely forty hotels and roadhouses, and nearly all of these are already well filled with regular "boarders."

A careful canvass of these places by members of the staff of THE AUTOMOBILE this week developed the fact that no special preparations are being made as yet to care for participants in the race or those who will go to see it. Most of the proprietors expressed a willingness to prepare for accommodating an unusual number of per-

sons, especially in the way of providing meals, if they could have some assurance that the people would come, but none of them cared to lay in a stock of food upon mere speculation. One or two days' notice, however, will suffice for them to make preparations to the limit of the capacity of their premises.

By inquiry at all of the public places and some private residences it was found that there will be regular lodging, without crowding, for between 400 and 500 persons, that regular meals can be furnished to from 2,500 to 3,000, and that 250 to 300 automobiles can be stored under shelter, most of them under lock and key. The figures for meals are susceptible of considerable expansion if the proprietors of the Garden City Hotel, at Garden City, and of the Queens Park Hotel, at Queens, are notified a day in advance to prepare for large numbers, as the former can easily provide dinners for 1,000, and the Queens Park Hotel can furnish meals for from 1,000 to 2,000, as it makes a specialty of catering to the large German societies of Brooklyn and New York. This place is directly on the course, only a short distance east of Queens, from which it can be reached by automobile by back roads that do not cross the course, and also by trolley car from Jamaica and Queens, directly along the Jamaica-Hempstead road, that forms part of the course. Surrounding the building and large sheds is a private grove that will accommodate 5,000 persons. This place would make a good headquarters for some large automobile club, as it affords a good view of a fine stretch of the course.

No disposition to overcharge or even to raise the usual rates is manifest at any of the hotels, which con-



FRONT OF THE GARDEN CITY HOTEL.

trasts most favorably with the extortion practised in Ireland and Germany on the occasions of the last two Gordon Bennett races. Rates at the hotels and private houses visited were quoted at 75 cents to \$1 for lodging for each person, and 75 cents for regular meals; at the roadhouses, 50 cents for lodging and 50 cents for meals.

Accommodations for the largest numbers of persons can be secured at Queens, Garden City, Mineola and Westbury (near the starting and finishing point). The two largest villages on the course—Hempstead and Hicksville—offer very little in the way of either lodging or meals. In the accompanying list are given the names of nearly all the hotels and roadhouses on the course and within the triangle, with the number of rooms that will probably be available on the night of October 7, and the number of persons that each house can supply with regular meals. These places were canvassed carefully for the information, which can be depended upon as reliable. Distinction should be made, when referring to this list, between the hotels and private resi-

dences and the roadhouses, the former offering accommodations such as might be expected in villages of 1,500 to 5,000 population, while mechanics and those officials whose duties require them to be at particular points on the course at early hours on October 8 can find fair lodging and food at the places specified as "roadhouses."

Since Queens, the nearest point on the course to the New York City Hall, is fourteen miles out, and the starting point at Westbury is twenty-three miles out, spectators who want to see the first stage of the race will either have to drive out from town Friday and find lodging in some of the houses listed, or in summer resort hotels and boarding houses on the north and south shores of the island, or, as an alternative, must start by automobile or train from New York and Brooklyn in the very early hours of Saturday morning. Doubtless the majority will prefer the early morning drive, as the roads are excellent, and unless congestion on the ferryboats and approaches causes delay, two hours should suffice for the trip.

While the canvass previously mentioned extended only to houses directly on the course or within it, the fact should not be lost sight of that better accommodations for probably a larger number of persons can be secured in the hotels along the Merrick road, on the south shore, which are largely patronized by summer boarders, and in similar summer hotels on the north shore. From these places the course can be reached quickly by automobile over superior macadamized roads, half a dozen of which lead northward from the Merrick road to Hempstead, and several of which lead southward from Flushing and the Great Neck, Manhasset Neck and Cow Neck peninsulas, on the Sound, to the Jericho turnpike at Queens, New Hyde Park, Mineola, Westbury and Jericho.

For the benefit of those who are unfamiliar with the course and who may wish to secure accommodations as close as possible to the best places along the way from which to view the contest, it should be stated that the sections of the course offering the best opportunity to contestants for high speed, and at the same time the most

List of Hotels, Road Houses, and Boarding Houses on the Route of the Vanderbilt Cup Race Course.

JAMAICA.

Pettit's Hotel; 6 large rooms, double beds; can furnish meals to probably 200. Store 20 cars; gasoline at Chipley's auto station.

Jamaica Park Hotel, roadhouse, probably 2 or 3 rooms.

Private house, M. P. Dewey, prop., accommodations uncertain.

Boarding houses, Mrs. Hammond, Mrs. W. T. Brown, G. W. Hawxhurst; uncertain.

HOLLIS.

Belmont Hotel; 3 rooms, double beds; meals for about 50.

QUEENS.

Madison Hotel, Madison ave. and Jericho Turnpike; Frank Blake, prop.; 3 rooms, double beds, 50 meals, gasoline, storage for 6 cars.

Queens Park Hotel, Hempstead Road, 3-4 miles east of fork on trolley line; Joseph Chadil, prop.; no rooms; meals for any number, large dining room seating 400; store 50 cars in fine sheds.

Barb's Hotel, roadhouse; 4 rooms; 15 meals; store 15 cars under lock in barn.

Several private houses along Creed ave. and Jericho turnpike.

Woelfle's Hotel, roadhouse, Jericho turnpike, east of Queens; 5 or 6 rooms, double and single beds.

Large wagon shop with forge and drill press—Thos. Callister's—also storage for 6 cars.

FLORAL PARK.

Floral Park Hotel, Frank Blake, prop.; 10 rooms in hotel; meals for 25, in addition to guests; store 6 to 10 cars, gasoline.

MINEOLA.

East Williston Hotel, roadhouse, Frank P. Krug, prop.; on Jericho turnpike; 4 rooms, 100 to 150 meals; large new barns will store 50 to 60 cars under lock, barrel of gasoline; also lubricating oil.

Murphy's Hotel, roadhouse, Jericho road, 3 rooms, double beds, meals for 20 to 25.

Johren's Hotel, opposite court-house, no rooms; meals for 75 to 100.

Several private houses might take lodgers.

Boulevard Hotel, roadhouse, H. H. Rice, prop.; 3 rooms.

Mineola Hotel, J. McGuire, mgr.; accommodations uncertain.

NEW HYDE PARK.

Miller's Hyde Park Hotel, A. M. Schulz, prop.; 2 large square rooms, double beds, 100 meals, store 6 cars under lock, 12 in open sheds; gasoline and lubricating oil in stores both sides.

Central Hotel, roadhouse; Joseph Filariski, prop.; no rooms; large open shed with running water.

Joseph Kiesling's Hotel, roadhouse; 5 rooms, double and single beds; meals for 20.

Large carriage shop—William Gartrell's—well equipped with machinery, 5 or 6 barrels .76 gasoline.

Two private houses, two rooms each, double beds.

WESTBURY.

Luessen's Hotel, roadhouse; lodge 20 to 30; store 30 cars under lock, electric lights in barn.

McCormack's Hotel, roadhouse; 20 men.

Smith's Hotel, half mile south of Jericho turnpike; 15 to 20 lodgers.

Three smaller roadhouses and several private houses might have spare rooms.

Two blacksmith shops on crossroad to Jericho turnpike.

McKenna's hardware store, 8 barrels of gasoline, barrel of cylinder oil. Cement floor barn will hold 12 cars under lock. Dry batteries and wire.

R. E. Levi's bicycle store, good small workshop and hand tools.

JERICO.

Dewey House; roadhouse, Chas. J. Kinsella, prop.; one mile west of Jericho, half mile from grand stand, 5 rooms, double beds, store 6 cars under lock.

Powell's Hotel, roadhouse, at Jerico turn; may have 4 or 5 rooms, double beds, store 6 cars in stable and shed; two barrels of gasoline at general store across the road.

Large boarding house half-mile north on Oyster Bay road.

HICKSVILLE.

Grand Central Hotel, changes hands Oct. 1; house has 9 rooms, now full, can pro-

vide meals for 50, store 12 cars under shelter.

Broadway Hotel, Frank Reinhardt's Sons, props.; new house, 5 or 6 rooms, double beds, meals for 50.

White House Hotel, no rooms, meals for 12.

CENTRAL PARK.

No hotels or roadhouses. Large boarding house at Massapequa turnpike and Bethpage road crossing—Mrs. S. McHugh—can accommodate 8 or more over night, meals for 24 to 36.

Damman's Hotel, roadhouse, quarter mile south of turn on Massapequa road, at Plain Edge, possibly one or two rooms.

Large private house two miles west of turn on Bethpage road, might take lodgers.

Vandewater's Meadowbrook Roadhouse, 2 miles east of Hempstead, on Bethpage road and Merrick road, no rooms, meals for 15 or 20.

HEMPSTEAD.

Grand Central Hotel, roadhouse, 4 or 5 rooms, meals for 100, storage under shed.

Whaley House, 2 or 3 rooms, meals for 100.

Gardner House, 2 or 3 rooms, meals at all hours for 50.

L. C. Smith's Hotel, no rooms vacant.

The Pines, F. W. Crandell, prop., uncertain accommodations.

Boarding House, Mrs. O. Thomas, uncertain.

WEST HEMPSTEAD.

Maple Grove Hotel, roadhouse, Jacob Etzel, prop., 4 rooms, double beds, meals for 12 to 20. Small blacksmith shop across road.

FRANKLIN SQUARE.

Franklin Square Hotel, roadhouse, August Kalb, prop., 4 rooms, double beds, meals at all hours for 100 or more, store 6 cars under shed. Main cross road passes house.

ELMONT.

Private House, K. R. Burtis, prop., near Queens; 3 rooms, double beds, meals at roadhouse opposite, carriage shop close by.

Elmont Hotel, roadhouse, Philip H. Hoeffner, prop., 3 rooms, meals for 25.

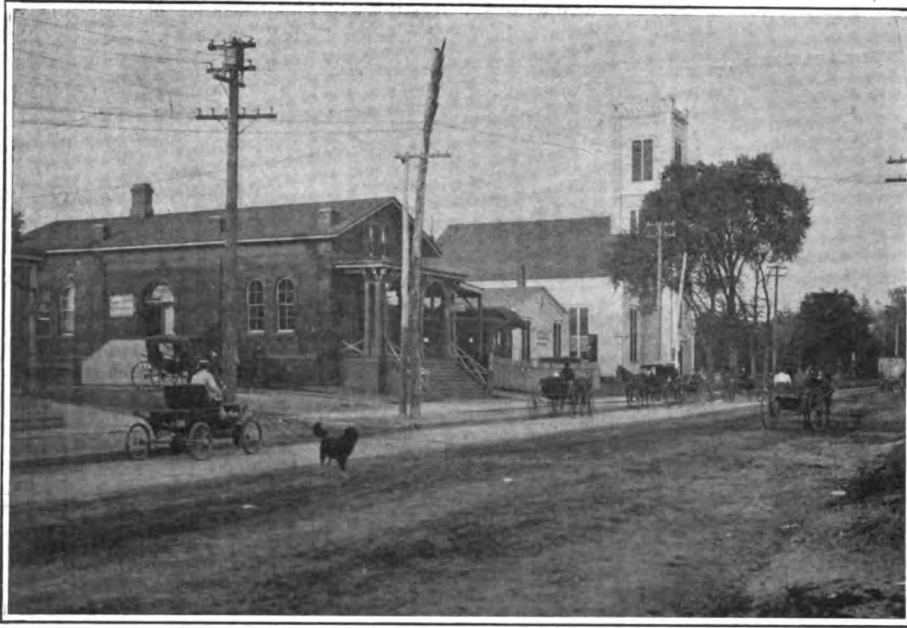

RAILROAD TERMINUS AND CHURCH ON FULTON STREET IN THE HEMPSTEAD CONTROL.

extensive view of the road to the onlooker, are as follows:

First, the Bethpage road from Hempstead east to the intersection of the Massapequa turnpike; this stretch is straight and level for almost the entire distance, much of the road surface being new—in fact, not yet entirely finished, although it will be by the date of the race. The road lies across an extensive open prairie, in which the spectators' cars can be parked a safe distance from the course and yet afford an excellent view of the race.

Second, the Massapequa turnpike from

its intersection by the Bethpage road north to the Hicksville control, which is likewise straight and level, with many good observation points on both sides; also on the same road immediately north of Hicksville, where the road is broader and affords the contestants good opportunity of passing one another. There is an extensive prairie on the east side, where hundreds of cars could be parked well back from the road and from which the race could be watched.

Third, the Jericho turnpike, at or near the grand stand at Westbury, where probably the highest speed in the race will be

attained, the road being broad, straight, level and smooth; at Mineola, where there is a long straightaway; and west of New Hyde Park.

Fourth, the Jamaica-Hempstead road between Hempstead and Munson, and also from Franklin Park to Queens.

Those who would rather have a good look at the cars and their drivers than to see the greatest speed will be able to do so at Hempstead and at Hicksville, where controls are established. While Queens is not made a control, it will be one of the best places to watch the contest, as the two turns close together, with a railroad intervening, on which many trains will pass during the period of the race, will be sure to develop much of interest. From Queens the electric street cars run along the side of the Hempstead road, affording a fine view of the course for six or seven miles.

The location originally selected for the grand stand has been changed for one a little further east on the Jericho turnpike, at the corner of a road leading to Westbury. The only entrance will be from this road through the rear of the stand. About four feet from the front of the stand a heavy, solid bulwark will be erected as a protection to the spectators in case of accident. The stand itself will be built very strongly, so there will be no danger of collapse, and will be in sections, so that it may be taken down, stored away and used again.

On the opposite or north side of the course the stands for the judges, timekeepers and press representatives will be located. Each of these sections will be isolated from the others, and reserved for those actively engaged in managing or reporting the race.

Hotels and Boarding Houses in Towns Within Easy Motoring Distance of the Vanderbilt Cup Course.

From an authoritative source the following list of hotels and boarding houses, situated in various towns on the north and south shores of Long Island, has been obtained. These towns are distant anywhere from 1 to 5 miles from the course, which can be reached by automobile over good

roads. No personal investigation was made of these establishments, but in general they are of a better class than those situated closer to the course. It is possible, however, that at this time of the year some of them may not care to provide accommodations for transients, and it would be well

for any one who expected to stop in any of these houses to write to several different addresses in the localities selected, so as to insure a favorable reply. The rates in these houses for regular guests range from \$7 to \$20 a week. Distances from New York are measured from the City Hall, Manhattan.

VALLEY STREAM.

South of course, on Merrick Road, 16 miles from New York.
Central Hotel, 20 persons.

WANTAGH.

South of course, on Merrick Road, 26 miles from New York.
Wantagh Hotel, 30 persons.

FREEPORT.

South of course, on Merrick Road, 23 miles from New York.
Grove Park Hotel, 200 persons.
Woodcleft Inn, 125 persons.
Crystal Lake Hotel, and cottages, 110 persons.

Freeport Inn, 25 persons.

Okie Villa, 20 persons.

Colonial Cottage, 30 persons.

Benson House, 20 persons.

Randall Cottage, 15 persons.

Plymouth House, 10 persons.

MERRICK.

South of course, on Merrick Road, 24 miles from New York.
Cedar Grove House, 20 persons.

PORT WASHINGTON.

North of course, 18 miles from New York.

Central Hotel, 50 persons.

Port Washington Hotel, 50 persons.

ROSLYN.

North of course, 22 miles from New York.

Mansion House, 40 persons.

SMITHVILLE SOUTH.

South of course, 25 miles from New York.

Pleasant View Hotel, 12 persons.

LYNBROOK.

South of course, on Merrick Road, 18 miles from New York.

Floral Villa, 20 persons.

ROCKVILLE CENTER.

South of course, on Merrick Road, 19 1-2 miles from New York.

The Knickerbocker, 40 persons.

The Sherman, 25 persons.

Rockville Center Hotel, 20 persons.

Welcome Manor, 20 persons.

BALDWIN.

South of course, on Merrick Road, 21 miles from New York.

The Oaks, 30 persons.

Grand Avenue Hotel, 20 persons.

BELLMORE.

South of course, on Merrick Road, 26 miles from New York.

Bell Merrick Inn, 40 persons.

MASSAPEQUA.

South of course, on Merrick Road, 29 miles from New York.

Massapequa Hotel, 200 persons.

COLLEGE POINT.

North of course, 9 miles from New York.
Hotel Grand View, 30 persons.

BAYSIDE.

North of course, 11 miles from New York.

Crocheron Inn, 15 persons.

Maple Lawn Cottage, 15 persons.

GLENHEAD.

North of course, 25 miles from New York.

Glenwood Hotel, 300 persons.

SCALE MAP OF THE WILLIAM K. VANDERBILT, JR., CUP RACE COURSE ON LONG ISLAND, REDRAWN FROM THE U. S. GEOLOGICAL SURVEY SHEETS BY OUR OWN CARTOGRAPHER.



-  Red banner right hand side of road 100 yards from turn to the right.
-  White banner straight ahead intersection.
-  Red banner for right turn near corner.
-  Green banner 100 yards from R. R. crossing.

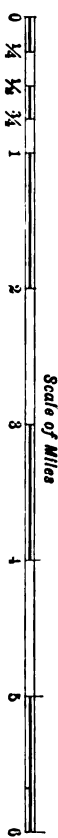

Complete Distance of Course, 30.24 Miles. Distance from New York City Hall to Village of Queens, 14 Miles.

Length of Hicksville Control, 40 Miles. Length of Hempstead Control, 1.40 Miles. Flag and Control Signs are Those Used on the A. A. A. Official Map.

Contours are Fine Curved Lines with Figures Showing Elevation Above Mean Sea Level. Arrows Along Course Show Direction of Race.

Arrangements for Holding the Race.

THE thirty-mile triangle over which the race for the Vanderbilt Cup will take place on October 8 will be practically isolated from the rest of Long Island from 5 o'clock in the morning until 3 o'clock in the afternoon of that day. The roads intersecting those which comprise the course, as has already been stated in THE AUTOMOBILE, will be barred by means of wires stretched between posts, in addition to being guarded by deputy police officers. Between the hours named there will be no way of gaining access to the inside of the triangle except by going to Hempstead, where there will be a control. The control at Hicksville will, of course, be available for crossing the course, but to reach that point necessitates an impracticable journey for those approaching from New York or its vicinity. Mounted patrols will go over the course, starting at 5 o'clock a. m. on the day of the race, to clear the way, and in addition a fast pilot car will be sent around, shortly before the first racer starts, to make a final inspection and give a last warning. Watchmen will be placed at all turns and at any other points where they might be of use, and the railroad crossings will be particularly well guarded; each will be in charge of at least six men—two deputy police officers, two employees of the railroad and two appointees of the A. A. A. Racing Board.

Owing to the probability that the racing cars will be strung out all over the course at comparatively short intervals, the problem of handling railroad trains in such a way as to avoid delay to the racers is a complex one, and all details have not as yet been completely arranged. It has, however, been decided that trains shall stop and wait for a signal to cross, so that whatever delay occurs will affect chiefly the trains. The railroad officials are willing to do anything in their power to facilitate the plans of the Racing Board.

The oiling of the course was commenced this week, the work being undertaken thus early in order that the heavy oil might have ample time to soak into and, so to speak, anchor the dust, before the race. The oil at first lies on top of the dust, and requires some little time to form the binding which ultimately results from this

treatment. By October 8, however, the road surface will be in the best of condition, so far as the laying of the dust is concerned, and a fact which is worth noting is that this condition will not be a temporary one, but should last for at least a year. Chairman Pardington, of the A. A. A. Racing Board, in speaking of this matter, stated that roads which were treated with oil last March are still so free from dust that the cloud following an automobile is sharply cut off immediately an oiled stretch of road is reached. No less than 90,000 gallons of crude petroleum will be spread over the course, which will be sprinkled twice. Special appliances and a thorough knowledge of the proper method of applying the

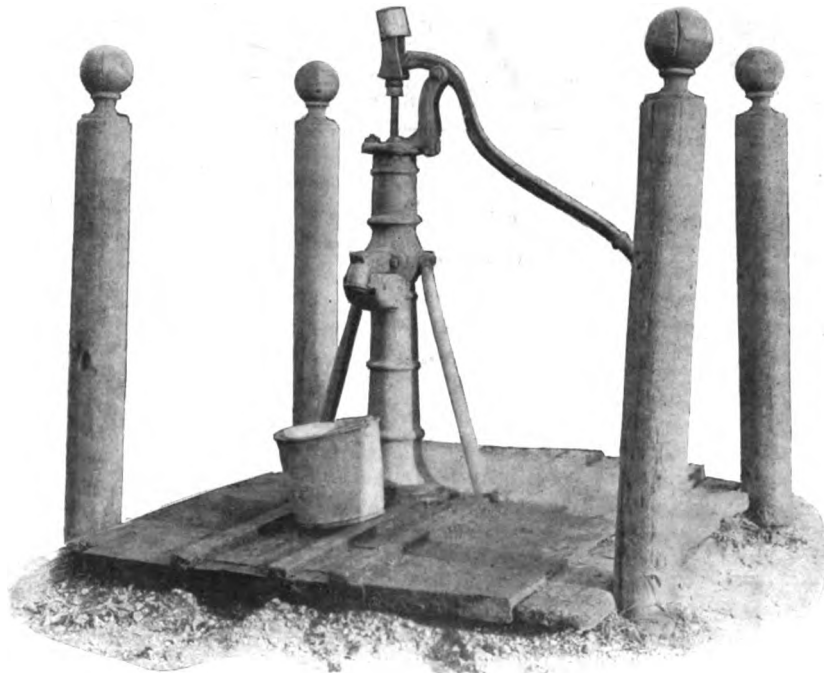

The now famous Pump at Westbury which might have gone into history with the Devery Pump in New York had the Grand Stand Location not been changed.

oil are necessary to ensure the best results.

The grand stand at Westbury will be placed on the south side of the road, inside the triangle, and the starting line will be about in line with the extreme left hand side of the stand. The competing cars will take the direction opposite to that usually taken in track races—that is, they will travel in the direction of the hands of a clock. In this way all the spectators will face the contestants as they start, instead of half of the spectators watching the backs of the contestants, as is the case when the starting line is in front of the centre of the grand stand. The space in front of the stand, as well as for some distance each way, will be kept perfectly clear. Only one car at a time will be at the starting point, and only persons who have business there will be allowed on the road. The judges' stand will be opposite the spectators' stand and directly in line with the starting point. In it will be provided ac-

commodation for the press representative, besides the judges and other race officials.

All who have business connected with the race will be provided with "brassards," such as are used by the officials of similar events abroad. These "brassards" are badges to be worn on the arm, and for members of the press will be white, with the name of the publication in large black letters. Chairman Pardington requests that those who receive badges will wear them without fail, as the rule to exclude from the course all who do not wear badges will be enforced.

On Saturday, October 1, the contestants will draw for numbers, these numbers to indicate the order of starting as well as to designate the car. The drawing will be held at 8 o'clock p. m. at the A. C. A. clubhouse, 753 Fifth Avenue, New York. This drawing is always an interesting ceremony,

for the man who draws No. 1 has the immense advantage of a perfectly clear road, which is shared, in a diminishing degree, by the earlier following numbers. There is also a lurking vein of superstition regarding the hoodoo number 13, even among such practical men as automobilists, and a secret feeling of gratification at not having drawn it, which is just a little comforting to the tail-enders.

The next official act is the weighing-in of the cars, which will take place on Friday, October 7, the day before the race, at the Garden City Hotel, where a platform scale, accurately calibrated, will be in

charge of Messrs. Riker and Birdsall. Quite a number of the cars have taken part in races abroad, where the maximum weight limit of 2,204 pounds is in force, and their weights are well known to their owners and drivers; but with some cars that are about to make their debut as racers difficulty has been experienced in getting down to fighting weight.

The weight of the cars, as officially recorded, will, of course, be less than the actual running weights, as the following extracts from the rules show:

"Vehicles * * * shall carry at least two passengers side by side, of a minimum mean weight of 132 pounds per passenger; it is to be understood that in cases where the mean weight of the passenger does not reach 132 pounds the deficiency must be made up by means of ballast. The weight of the vehicles * * * shall always be computed in the empty state. By weight in the empty state is meant with no

PHOTOGRAPHIC REPRODUCTION OF THE PROCLAMATION POSTED UP BY THE AMERICAN AUTOMOBILE ASSOCIATION IN TOWNS ALONG THE ROUTE OF THE VANDERBILT CUP RACE.

AUTOMOBILE RACES!

NASSAU COUNTY HIGHWAYS !!!

FIRST INTERNATIONAL ROAD RACE

THE WILLIAM K. VANDERBILT, JR., CUP

Will be held over the superb macadam highways of Nassau County on

SATURDAY, OCTOBER 8, 1904

The Distance Will be Between 250 and 300 Miles, and Will Start at Westbury, at About Daylight.

The Board of Supervisors of Nassau County having set apart the following roads, between the hours of 5 A. M. and 3 P. M., all persons, whether on foot, mounted, or driving horse or mechanically propelled vehicles are warned against using the same, and to follow the instructions of the local officers who will be stationed at short intervals along the route, which is as follows:

Jericho Turnpike, Queens to Jericho; Oyster Bay-Massapequa Road, Jericho to Plain Edge; Plain Edge Road (Bethpage Road), Plain Edge to Hempstead; Fulton St., through Hempstead, to Hempstead-Jamaica Road, Hempstead to Queens.

NOTICE:

Automobiles will reduce speed through Hicksville, allowing 3 minutes to pass through, and they will require 6 minutes to pass through Hempstead.

Residents along the above route are cautioned against allowing domestic animals or fowls to be at large during the above race; and are further cautioned against allowing children, unattended, to make use of these highways.

1. If you are careful, there is no danger.
2. Don't cross a street until you are sure that no automobile is approaching. Look each way
3. Chain your dogs, and lock up your fowls.
4. Don't crowd out onto the highway, you will see as much if you remain in close to the sidewalk, back of the curb-line.
5. Positively no postponement of this Race on account of weather.

REMEMBER

SATURDAY, OCTOBER 8, 1904

FROM 5 A. M. TO 3 P. M.

AMERICAN AUTOMOBILE ASSOCIATION

passengers nor stores (coal, petrol,* water, accumulator†) nor tools, nor spare parts, nor luggage, nor clothes, nor provisions. Vehicles which draw the energy required for ignition from a device actuated by the motor shall benefit by an allowance of weight of 15 pounds. The weight of lamps, lamp-holders and horns is not comprised in the said weight of the vehicles."

After having been weighed, the cars will be turned over to representatives of the A.A.A. Racing Board and placed in a garage at Garden City, where they will be closely guarded until the moment they are released to be driven to the starting line. No work will be allowed on cars after weighing without a special permit. The machines will be sent out from the Garden City garage at about 6 o'clock on the morning of the race, and will proceed at once to a crossroad close to the starting point, where they will line up in the order of their numbers. Only one car at a time will be at the starting point, and immediately a car is sent away the next one will take its place before the starter. If for any reason a car fails to start when the word is given it will be timed exactly as if it had actually started, no allowances being made for anything once the signal is given.

The first car, No. 1, will be despatched promptly at 6.40 o'clock, and the others will follow, in numerical order, at two-minute intervals, if the present arrangements are not changed. At this rate the last car should get away at 7.16, by which time, if a speed of about a mile a minute is maintained, the first car will be within three minutes of completing the first round. Thus, after the starting of the first car, the spectators will have but little time in which to become impatient.

Each car will be required to stop at the entrance of each of the two controls at Hicksville and Hempstead. Here it will be officially checked and will then be sent through the control behind a pilot mounted on a bicycle, who will see to it that the correct time is occupied in the passage. This will make the controls perfectly safe. Control entrances will be indicated by large white banners marked CONTROL in black letters suspended over the road where they can be seen without effort on the part of the drivers, and the exits will be similarly marked. All places to which the attention of operators should be drawn will be indicated by white banners 5 feet square, with colored centers, plated conspicuously several hundred yards from the spot of which warning is being given. A red centre will indicate a turn to the right; a green centre a railroad crossing, and a plain white banner will indicate a road intersection.

Two independent telephone systems are being installed connecting the various stations on the course with each other and the judges' stand. The failure of telephone systems installed on race courses abroad

* Petrol means gasoline.

† Accumulators means storage batteries.

has suggested the idea of duplicating the lines on the Vanderbilt Cup course, to forestall the possibility of similar trouble.

The rules governing the race will be the road racing rules of the American Automobile Association, which are based on the French regulations, and these will be supplemented by the special conditions outlined by Mr. Vanderbilt in donating the cup, which have already been enumerated in these columns.

A car which is overtaken is required, by the ordinary rules of the road and by the road racing rules of the A.A.A., to keep to the right as far as the road permits, in order that the overtaking car may pass. At some points on the Vanderbilt Cup course the road is so narrow that in order to allow an overtaking car to pass, the overtaken car would have to run with two wheels on the grass, off the roadway proper. As the matter now stands, the driver of a car overtaken on one of these narrow stretches may, if he chooses, stand on his rights and refuse to turn out beyond the edge of the road, in which case it would be practically impossible for another car to pass. If, however, the driver of the leading car is sufficiently sportsmanlike and courteous, he will turn out a trifle—about three feet would be sufficient—and permit the faster car to go by. Even if the driver of the faster car elected to take his life in his hand and essay to pass by running into the ditch, it is probable that the softness of the ground would decrease his speed to such an extent that he would not succeed, even if no accident occurred.

As the narrowest stretch of road, between the second turn and the Hempstead control, is about 4 1-2 miles long, there is considerable opportunity for sharp team work. For instance, if two cars of a team get together and find they are being overtaken by a competitor on the narrow place, the second car of the team has only to re-

fuse to turn out, and then slow down a little, in order to allow its mate to establish a good lead. In such a case it would be difficult to obtain redress, as no charge could be proved against the jockeying driver, if he were artful enough not to overdo it. Nothing can be done to remedy this state of affairs, and it will be up to the faster cars not to get caught in such a trap; and, on the other hand, it will be up to the drivers of slower machines to show their sporting spirit by doing the square thing and making room for the better car.

A change in drivers which is of interest is the replacing of Regan, who was to have driven the De Dietrich entry, by Gabriel, who drove this car in the Circuit des Ardennes, coming in eighth. No less than four of the contestants who drove in that event will take part in the Vanderbilt Cup race—Heath, the winner; Teste, who took second place; Clement, the third in, and Gabriel.

William Wallace, of Boston, whose 90-horsepower Fiat car is at the garage of Hollander & Tangeman, expected to ar-

rive in New York on Friday, September 23, and to proceed at once to his quarters at the Garden City Hotel. Other drivers are making similar arrangements, so that it is probable that for a fortnight previous to the race a number of the entrants will devote themselves to a minute study of the circuit.

Some delay has been experienced in putting the finishing touches on Frank Croker's 75-horsepower Simplex, and the machine had not, up to the middle of the week, received a road trial. It is expected that by to-day—Saturday—everything will be completed and the car taken to its quarters on the course.

The 90-horsepower Renault car entered by Mr. Brokaw remains as much of a mystery as ever. Doubt is expressed in some quarters as to its ability to make a showing against such thoroughly tried out cars as the majority of the foreign entries, owing to the fact that it is a new car, barely out of the shop, and will only arrive in this country a few days before the race.

Albert Clement and his Clement-Bayard car sailed for New York the latter part of last week, and Tarte and Teste, Panhard drivers, will be here next week. Heath, the third Panhard driver, is already on this side of the Atlantic.

A spectator who will doubtless be greatly interested in the race will be M. Voigt, of the French firm of Charron, Girardot & Voigt, who will attend the contest in a car built by his firm and brought over by M. Voigt.

Clarence Gray Dinsmore's Gordon Bennett Mercedes arrived on the steamer *Blucher* early this week and was taken to the quarters provided at Garden City. Mr. Dinsmore arrived in New York several days ago and will witness the race.

In order that all users of the highways may be made aware of the fact that the race will occur, posters 36 inches high and 18 inches wide have been put up by the A.A.A. Racing Board at all crossroads and branch roads along the course, as well as at other conspicuous places. Men and wagons were employed on this work for several



HAWLEY AT WHEEL OF E. R. THOMAS'S 60-H.P. MERCEDES VANDERBILT CUP CAR.

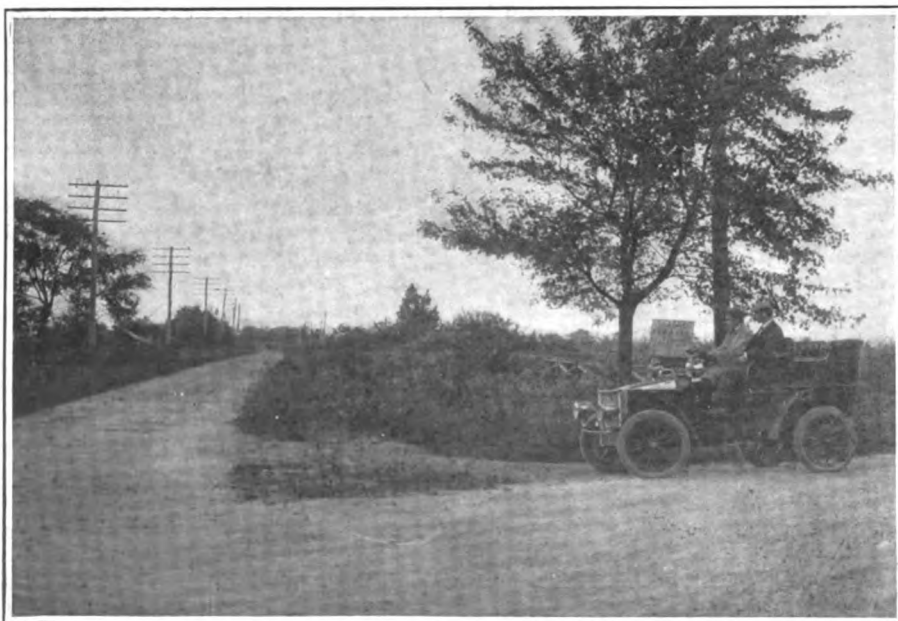

LOOKING WEST ON BETHPAGE TURNPIKE FROM MASSAPEQUA ROAD—A DANGEROUS CORNER.

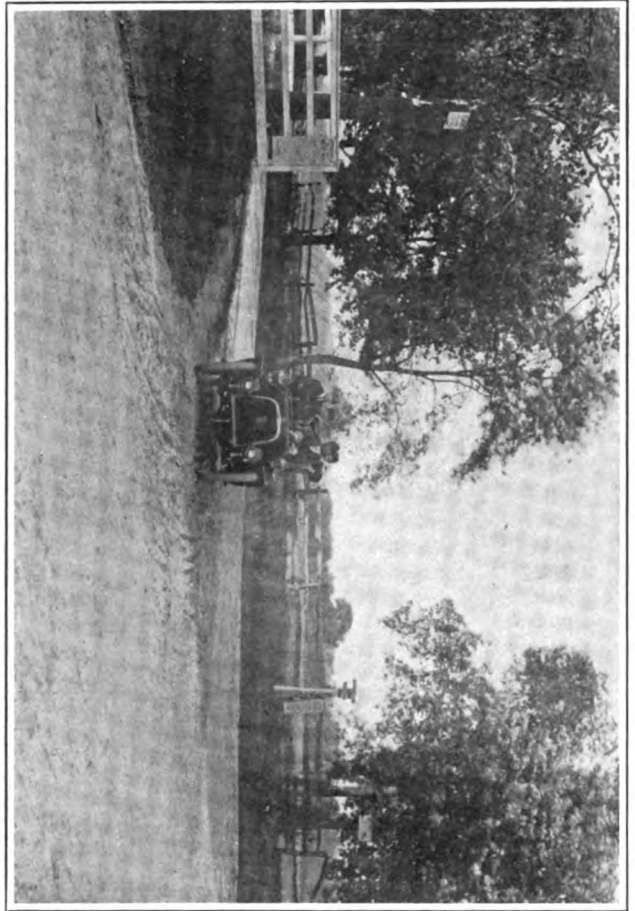

Race Proclamations Nailed on Fence Corners on Jericho Turnpike.

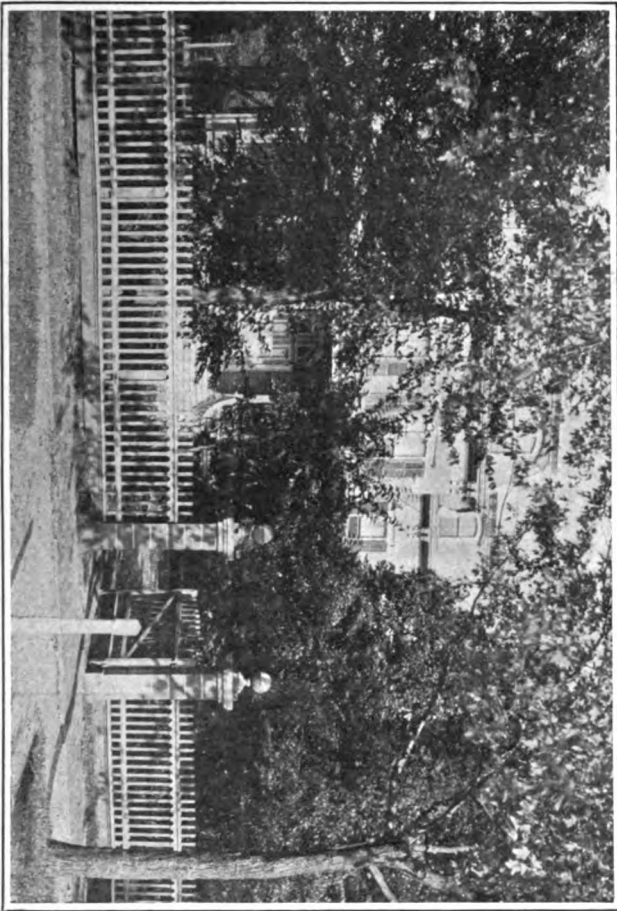

One of the "Cottages" at Garden Hotel Headquarters in Garden City. SNAP SHOTS OF INTERESTING POINTS ON AND NEAR THE COURSE OVER WHICH THE WILLIAM K VANDERBILT, JR. CUP RACE WILL BE HELD ON LONG ISLAND, OCTOBER 8.

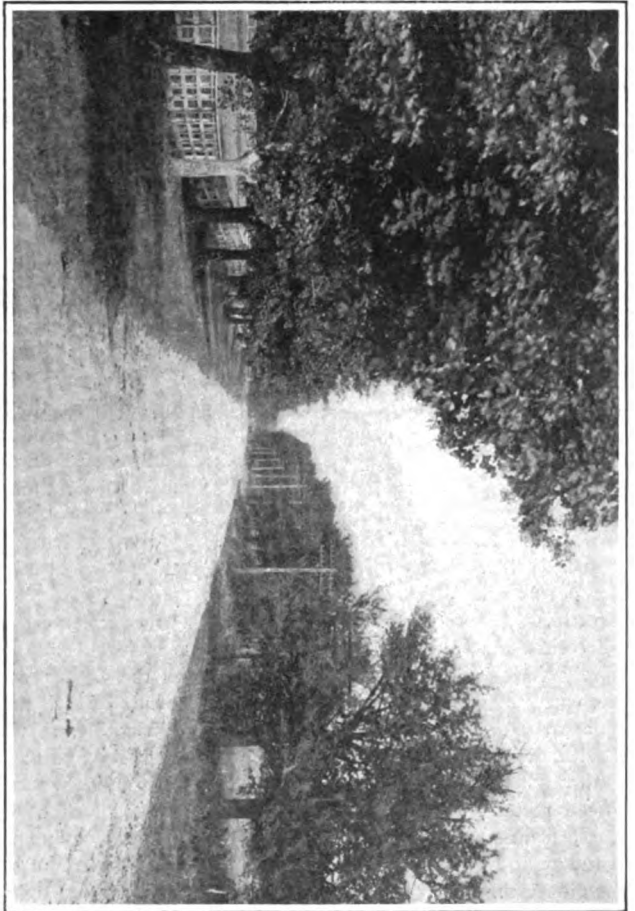

Looking East on the Jericho Turnpike Near Westbury.

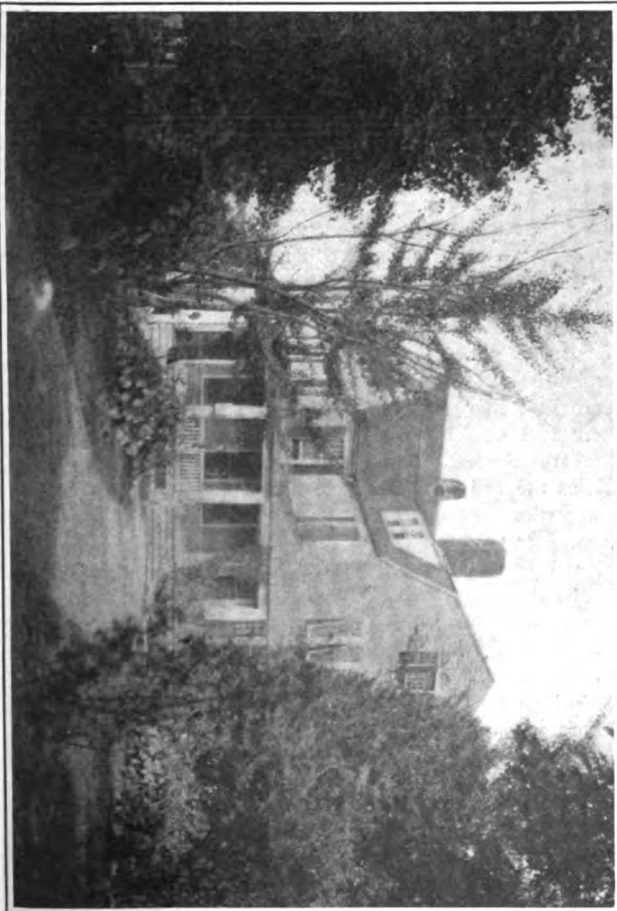

A Homelike Hotel on the Jericho Turnpike Near Queens. A HOMELIKE HOTEL ON THE JERICHO TURNPIKE NEAR QUEENS. THE WILLIAM K VANDERBILT, JR. CUP RACE WILL BE HELD ON LONG ISLAND, OCTOBER 8.

days. A reduced fac-simile of the poster is printed on page 351.

According to the last statement on the poster, the weather will not be allowed to interfere with the starting of the contest. It is to be hoped that the officials in charge

of the race have a pull with the clerk of the weather, for there are few things more depressing than a race in the rain. With bright weather, however, and a little luck, the first Vanderbilt Cup race should prove a great popular attraction.

involved, it would seem plain that the car which handled best, rather than the car intrinsically fastest, would be the likeliest to win; and this should be the car with the highest ratio of power to weight, with the further proviso that the weight should not be too great to permit quick stoppage. It is practically certain that enormous horsepower will not in itself be an advantage, especially if it carries the centre of gravity so far forward that the brakes cannot be used to the best advantage. It is difficult to see how a car of 90-horsepower can utilize all its power after it has been accelerated, for, in addition to the shortness of the stretches, most of these are too narrow to make extreme speed safe. The problem of one car passing another is likely to be a delicate one on this account.

As a matter of fact, in this contest, as in the last two Gordon Bennett cup races, the winning car is likely to be that which runs with the greatest regularity, suffers the least from tire troubles, and whose lubricators, igniters, clutch and brakes function

Comparison with Bennett Cup Races.

A COMPARISON of the course of the Vanderbilt Cup race with those of the Irish Gordon Bennett race last year and the Taunus course, over which the same trophy was competed for this year, suggests some interesting reflections. The Irish race was run over good but quite hilly roads, which, however, were fairly straight and not too thickly sprinkled with settlements. The Taunus course was likewise over roads in the main good, but rather crooked, with bad turns in some of the villages. The country was undulating, with but one grade of note as steep as 10 per

cent., though including a number of lesser grades. The circuit of 85 miles passed through some seventeen towns and villages of all sizes, indicating a rather denser population than is to be found on Long Island.

ville, the nearly straight stretches will be seldom interrupted by need to slow down for precautionary reasons. There is reason now to hope that the policing will be effective, and with the entire course oiled, there will be the minimum occasion for anxiety on the score of possible collisions. On the other hand, the longest uninterrupted stretch—that on the Bethpage turnpike—is only about six miles long, and those from the West Hempstead railroad crossing to Queens, and from the Mineola crossing to Jericho, are barely six. The remaining stretches are four or five miles

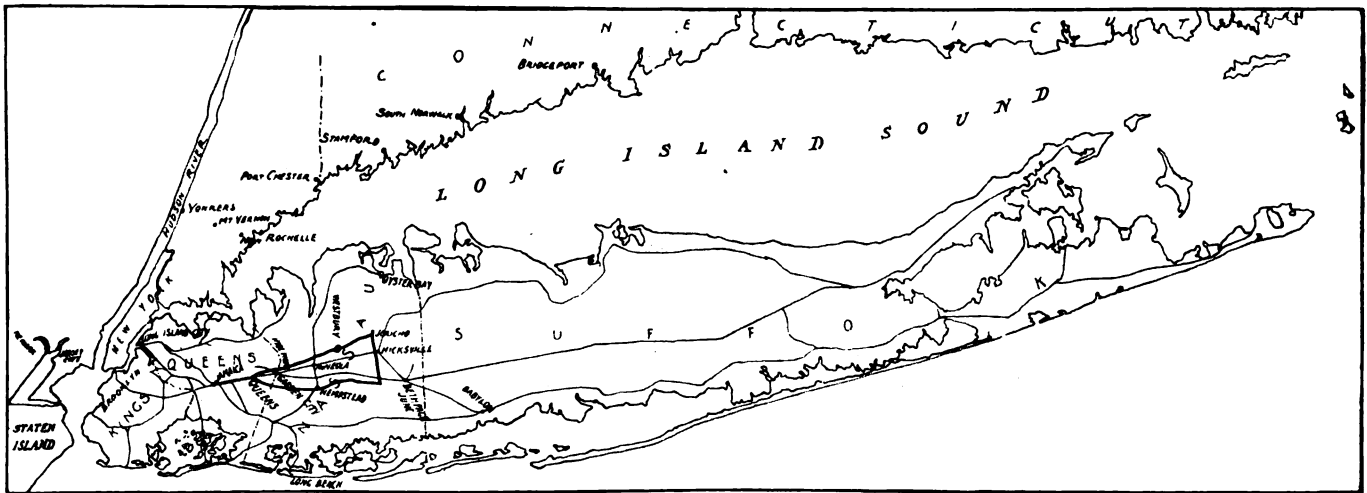

SKETCH MAP OF LONG ISLAND AND ADJACENT COAST LINE.—BLACK TRIANGLE TO LEFT SHOWS VANDERBILT CUP COURSE.

The Long Island circuit, of about 30 miles in length, is certainly much smaller than might be wished for a long road race. The difficulties of selection of such a course, however, in the vicinity of a large city are very considerable, and undoubtedly it was the best available. Then, too, an advantage is that nearly all the turns on the course are, so to say, effective; that is, they are in one direction, the reverse turns being comparatively few. The four corners of the course, each roughly approximating a right angle, are the only sharp turns to be reckoned with. Again, the course is practically level throughout, and no car in the race will need recourse to other than the high gear, except in starting.

As towns and villages are to a large extent avoided, there being none of any size on the course, except Hempstead and Hicks-

in length. Creed avenue, a local name for the Springfield road, which cuts off the apex of the triangle in Queens, is too short to be negotiated at speed, a fact which renders Queens practically a control in itself, particularly as the railroad crossing there is made dangerous by frequent trains. This latter point deserves to be carefully borne in mind by the contestants, as the railroad traffic over this crossing, according to the present railroad schedule, amounts to more than fifty passenger trains between the hours of 5 a. m. and 3 p. m., besides freight. In effect, therefore, there are six controls or slow-downs on the course—at Queens, at the Oyster Bay branch railroad crossing, north of Mineola, at the Jericho turn, at Hicksville, at the turn into the Bathpage turnpike and at Hempstead.

It will thus be seen that the course consists in effect of a series of short, but straight and smooth stretches, over which high speed may be attained, but can be kept up for only a few minutes at a time. If, therefore, no other consideration were

the most perfectly. As nearly all the competing cars have been tried out in other events, on the road or on the track, it may be guessed that the race will be fairly close.

As the exact length of the whole course is 30.24 miles, out of which 1.8 miles are to be deducted for controls, the net length is 28.44 miles. If the average speed were to be as great as in the last Gordon Bennett Cup race—53 miles per hour—the elapsed time for each complete circuit would be 32.19 minutes of actual running time, plus 9 minutes in controls, or a total of 41.19 minutes from starting line back to starting line again.

Owing to the shortness of the course, however, it hardly seems likely that the average running speeds of the winners in the last two Gordon Bennett Cup races—49 1-2 and 53 miles an hour respectively—will be equalled in this race. Nevertheless, it is certain that the spectators along the stretches will see speeds equal to the fastest that this year can produce.

Pittsburg Club's New Home.

Special Correspondence.

PITTSBURG, Sept. 19.—The new clubhouse of the Automobile Club of Pittsburg is the first building of its kind in Pennsylvania and one of the most attractive club homes in the country. The project to build a model clubhouse was first broached nearly two years ago, and last year a site was purchased. This is at the corner of Baum and Beatty streets, East End. No better location could have been found, as it is only a few rods from the four largest automobile establishments in the city, is close to the boulevards and is central among the homes of the club members.

When the club home was formally dedicated some weeks ago more than 100 invitations were issued to motorists outside of Pittsburg, in addition to all the automobile owners in the city. The recep-

ings, which include leather-covered furniture, mahogany tables, and handsome pictures. A costly piano will soon be installed. The club is the meeting place of all the automobilists in the city and the favorite visiting place for dozens of enthusiasts from other towns.

The A. C. of Pittsburg has had a remarkably rapid and successful growth. From the first it has been well managed and has had the active support of many of Pittsburg's wealthiest men and some of the most prominent business and professional men in the city. It has always been a strictly high-class organization and its efforts have been directed to promoting only the best features in automobiling. The club now has 250 members, twenty-five of whom were added at the opening of its new home. The officers are: President, W. C. Temple; first vice-president, James Francis Burke; second vice-president, W. H. Nimick; third vice-president, Edward Kneeb-

of the State, and it is the intention to make it as much a State affair as possible.

At the organization meeting a draft of constitution and by-laws was presented and submitted to the executive committee.

Most of the present members are also members of the Wilmington Country Club, which has a fine clubhouse on the outskirts of the city, facing the Wilmington and Kennett turnpike, which is one of the best roads for automobiling in this section of the country. All of the meetings so far have been held at the Country Club.

DISCUSSED RECKLESS DRIVING.

A meeting of the New York Automobile Trade Association was held on September 21, at which only routine business, which was not made public, was transacted. The matter of reckless driving in the streets of New York, which has been given considerable prominence in the daily press recently, was informally discussed, and C. R. Mabley, who presided at the meeting, stated that it was the feeling of the meeting that, while unduly fast running was to be deplored, and should be stopped, still too much prominence was being given the subject, resulting in injury to the automobile trade and automobiling generally.

ENTRIES FOR EMPIRE CITY MEET.

The entry list for Saturday's race meet at the Empire City track, Yonkers, is well filled, there being a total of fifty entries. Some of the cars, however, are entered in more than one event. The race for which the largest number of entries were made is the Empire Handicap, for which nineteen cars have been nominated, ranging from 10 to 100 horsepower. Carl G. Fisher will drive an exhibition mile in his 32-horsepower Premier *Comet* air-cooler racer, and will also engage in a match race with Charles Basle, of Paris, who will drive a high-powered Mercedes. This will be a pursuit race, the contestants starting at the same time from opposite sides of the track.

WILLIAM WALLACE IN AN ACCIDENT.

William Wallace, of Boston, had a narrow escape from death on Wednesday, September 21. He was driving his 90-horsepower Fiat racing car along Commonwealth avenue, Boston, when a wagon suddenly turned into the road, blocking it completely. To avoid a collision, Wallace turned into the ditch, thinking he could get back into the road again; but the car overturned, throwing out the owner and mechanic and smashing a front wheel, the steering wheel and column, the dashboard and hood and doing other damage. The occupants escaped with bruises. From the information received from Wallace's chauffeur, who came to New York immediately after the accident, it is believed that the car can be repaired in a week, and that, unless some more serious injury is discovered, it will be in good condition for the start of the Vanderbilt Cup race, in which it is entered.



PITTSBURG AUTOMOBILE CLUB'S NEW CLUBHOUSE AND CARS OWNED BY MEMBERS.

tion held in the evening was a brilliant social affair, and a number of members were added to the club that night.

The new building is of stone and timber. It is flatiron shaped and has a handsome plate glass front, with walls trimmed with terra cotta. The garage, which is for the use of members exclusively, is on the ground floor. This will be torn out later, and the large room which it occupies turned over to general amusement purposes. Pool and billiard tables and bowling rooms are also provided on the first floor. The main assembly room and the committee rooms and offices of the club are on the second floor. Here are also ladies' parlors, retiring rooms, serving rooms and lockers. Shower baths are provided for the members.

The building cost \$12,000. More than \$2,500 additional was expended for furnish-

land; treasurer, Reuben Miller, Jr.; secretary, W. Linford Smith.

DELAWARE AUTOMOBILE ASSOCIATION

Special Correspondence.

WILMINGTON, DEL., Sept. 19.—The Delaware Automobile Association has been permanently organized here, and the following officers have been elected for the ensuing year: President, Pierre S. du Pont; vice-president, William G. Merdinhall; secretary and treasurer, Willard Jackson; executive committee, Edgar M. Hoopes, William C. Spruance, Jr., Dr. Samuel G. Rumford, Joseph Bancroft, H. T. Gause, Dr. J. Paul Lukens, Francis G. du Pont, Alfred R. Jones and John H. Evans. Thirty-six signatures appear on the charter roll. Nearly all are residents of this city, but there are several who live in other parts

Crowds Watch Races at Poughkeepsie Fair.

Interest of the Country-folk Divided Between Pumpkins and Mile-a-Minute Dashes—Pope-Toledo Beats Mercedes.

Special Correspondence.

POUGHKEEPSIE, N. Y., Sept. 16.—What was probably the largest crowd that has witnessed an automobile race meet this year was present at the races which formed the leading feature of the Dutchess County Fair to-day. The number of spectators was variously estimated at between 12,000 and 15,000. A large party of New Yorkers made the trip to this Hudson River town and spent a pleasant afternoon among the prize pumpkins, fatted stock, and other features of the fair. To those familiar with the sport the races and their surroundings were exceedingly interesting. After one of the events the announcer, with his voice quivering at the importance of statement, yelled: "La-a-dies and gentlemen, I have the extreme pleasure in announcing that before the next event the world-renown horses, King and Queen, will make a thrilling dive from yonder platform into the pond below." The inclined structure up which the animals climbed to make the dive was in front of the grandstand, sharing the lawn with an improvised stage, on which a little later in the afternoon, while the racing cars were whirling around the track, a series of gymnastic and club-swinging performances were given. There was also a balloon ascension from the field, and some of the fair officials asked that the races be stopped while the aeronaut made his jump with the parachute, for fear he might fall in front of one of the machines. When he did fall the parachute landed several miles from the fair grounds.

That the races were satisfactory to the

fair officials was evident. Of the four days of the fair, it had rained on two, and the crowd attracted by the automobiles meant a balance on the right side of the cash book for the box office. There had been several statements given out to the effect that

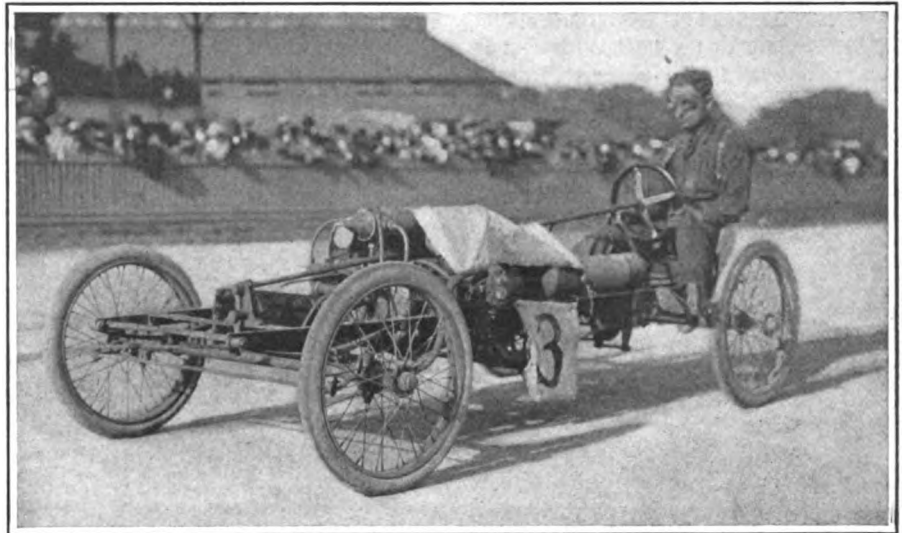

KULICK IN FORD RACER, WINNER GRAND DUTCHESS HANDICAP AT POUGHKEEPSIE.

the track would be treated with oil, to lay the dust; but there was little evidence of any oiling when the machines took the turns, and it is doubtful if the contemplated action was taken. The races were under the management of Arthur N. Jervis, of New York.

The first event, a five-mile race for tour-

ing cars, brought out three entries, a Columbia, driven by Eddie Bald, owned by the Electric Vehicle Co.; a 20-horsepower Mercedes, entered by Col. J. J. Astor, who was on the track at one time talking to his driver, B. Morgan, and a Pope-Toledo, piloted by A. S. Lee. In the first mile the Columbia and Pope-Toledo drew rapidly away from the Mercedes, with the Pope-Toledo in the lead. In the third mile the latter drew away and finished with Bald coming up rapidly. The Mercedes was lapped. The next event, ten miles, for the Poughkeepsie Cup, brought out the

little Ford wonder, which broke all records of its class at the Providence races; a 10-horsepower Franklin, and E. R. Thomas' 60-horsepower Mercedes, driven by E. E. Hawley. This proved the most interesting event of the day, as the little Ford hung on to its powerful foreign rival for over a mile. The Franklin dropped out after the first lap.

The Dutchess County Handicap was run in two heats and a final. The first heat was won by John Van Benschoten in an Autocar runabout, with the Pope-Toledo second and Eddie Bald third. Bald could not get away when he got word to start. The second heat was won by the Ford, which also carried away the final and the race.

The summaries are as follows:

Five miles, free-for-all, touring cars—Won by A. S. Lee, in Pope-Toledo; Eddie Bald, Columbia, second; J. J. Astor's Mercedes, driven by B. Morgan, third. Time, 7:02.

Ten-mile race, free-for-all, no restrictions—Won by E. E. Hawley, in E. R. Thomas' Mercedes; Frank Kulick, Ford, dropped out in eighth mile; W. F. Winchester, in Franklin, dropped out in fourth mile. Time, 10:36 1-5. Fastest mile, 1:02 4-5.

Five-mile race, for Autocars—Won by R. A. Warden; J. W. Wood, second. Time, 10:14 2-5.

Grand Dutchess Handicap, five miles—



EDWARD C. BALD, EX-BICYCLE CHAMPION, AT WHEEL OF COLUMBIA TOURING CAR.

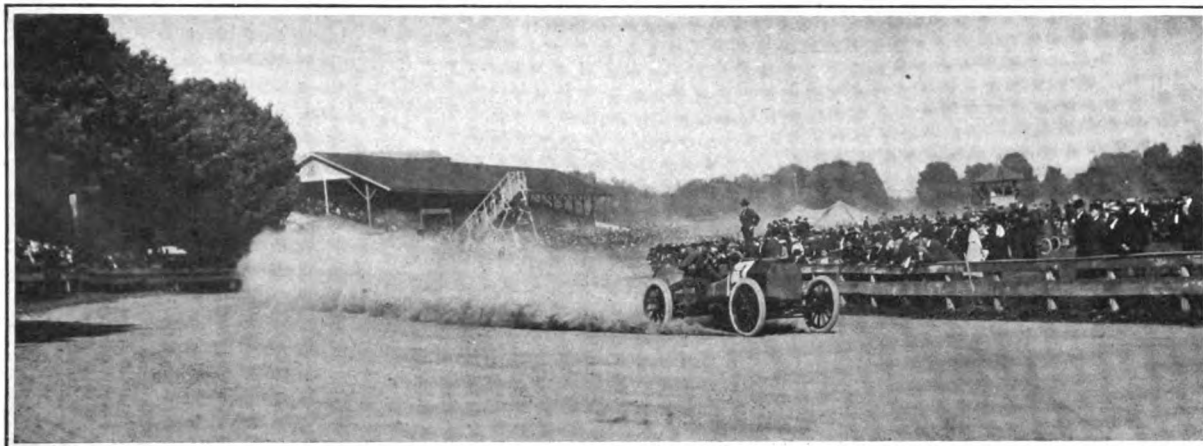

DANGEROUS CONDITIONS AT POUGHKEEPSIE—SPECTATORS CROWDING INNER FENCE AND HEAVY DUST ON TURNS.

Won by Frank Kulick, in Ford, scratch; A. S. Lee, Pope-Toledo, 55 seconds, second; B. Morgan, in J. J. Astor's Mercedes, 2:20, third; J. Van Benschoten, Autocar, 2:50, fourth. Time, 5:24 4-5.

Five-mile pursuit race—Won by E. R. Thomas' Mercedes; time, 5:20. Frank Kulick, in Ford, second; time, 5:26.

JEWELS RECOVERED ELICIT REWARD.

Special Correspondence.

SPRINGFIELD, Mass., Sept. 19.—A. R. Shattuck, ex-president of the Automobile Club of America, who, with Mrs. Shattuck, is touring from New York to Boston, lost from his car a handbag containing diamonds and jewelry to the value of several thousand dollars last Saturday, and two young sons of George P. Houghton, of this city, who found and returned the bag and contents were rewarded by a check for \$300.

Mr. and Mrs. Shattuck spent Friday night in Springfield, and left for Boston Saturday morning. Upon reaching North Wiloraham, ten miles east, the loss was discovered. The Springfield police were notified by telephone, and a search was begun. Mr. Shattuck at once started back along his

route, making inquiries. Meantime the bag had been found beside the road by the boys,

ward. Mr. Shattuck had offered through the police \$250 for its recovery, and he at

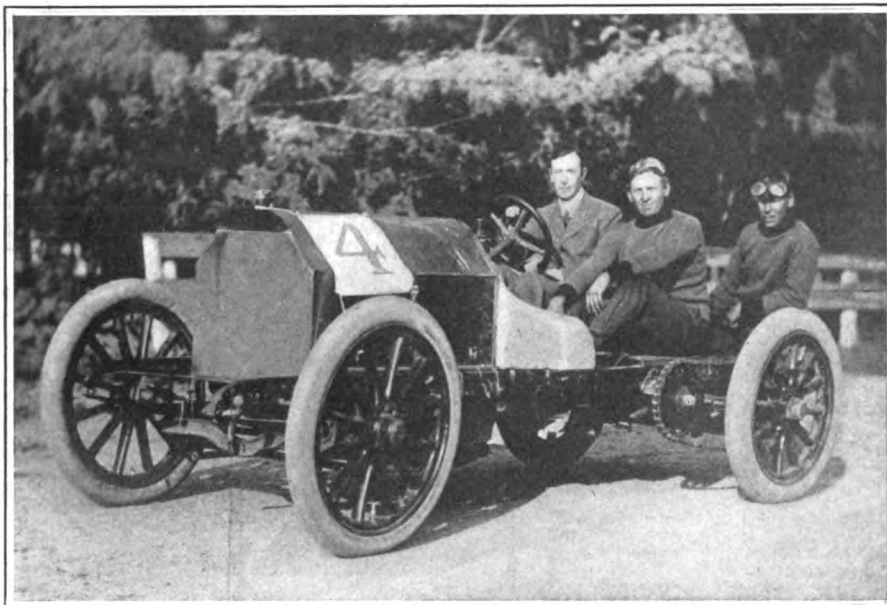

E. R. THOMAS AT WHEEL OF HIS 60-H.P. MERCEDES, E. E. HAWLEY AT HIS LEFT.

who took it to their mother. She returned it to Mr. Shattuck, without thought of re-

once added another \$50 to that amount, asking that bicycles be bought for the boys.

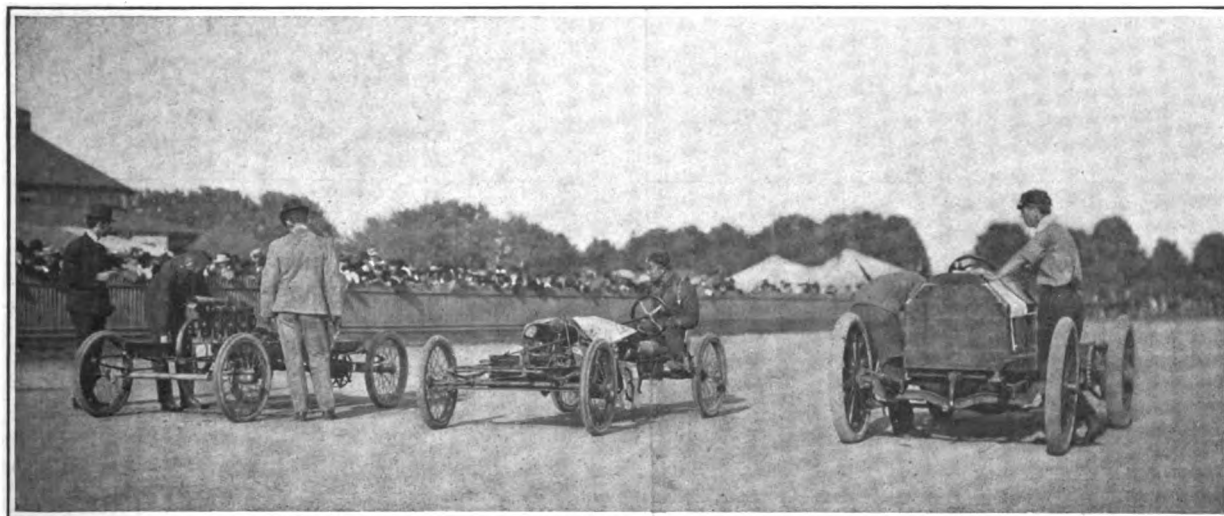

LINE-UP FOR START OF 10-MILE FREE-FOR-ALL—FRANKLIN (Left) FORD (Center), THOMAS'S MERCEDES (Right).

English 600-Miles Light Car Trials.

Narrative of a Week's Daily Runs and Hill Climbing Performances by Thirty-Five Cars Costing \$1,000 and Less.

Special Correspondence.

LIVERPOOL, Sept. 9.—During the week from August 27 to September 3 the Automobile Club of Great Britain held its reliability trials for small motor cars costing not more than £200 (\$1,000). The purpose of these trials was to ascertain for the benefit of intending motorists of limited incomes precisely what merits and what defects were embodied in the small motor cars offered at low prices. The previous trials held by the Automobile Club has been open to cars of all sizes and prices, and the performances of small motors have been quite overshadowed by the successes of their larger brethren; hence the change in the scope of this year's trials. This year, too, the venue of the trials was changed from London to the provinces, and the pleasant agricultural town of Hereford for one week was the center of attraction to English motorists.

The length of the trials was just a bit more than 615 miles, two runs of about fifty miles each being made each day. To allay any fears in the mind of the public that the trials were of the nature of a race, it was made clear that an average speed of eighteen miles an hour was not to be exceeded. The minimum average speed was fixed at twelve miles an hour, except in Class A, in which the low average of ten miles an hour was allowed. Gasoline consumption was carefully noted by reckoning up the number of two-gallon tins supplied to each competitor. The consumption of cooling water was also noted.

Great prejudice had been caused in previous trials by the dirty appearance of the

cars after the first few runs, as no washing of the cars was allowed. This year, however, the cars were run each evening to the Hereford cattle market, where, with the assistance of the local fire brigade, the

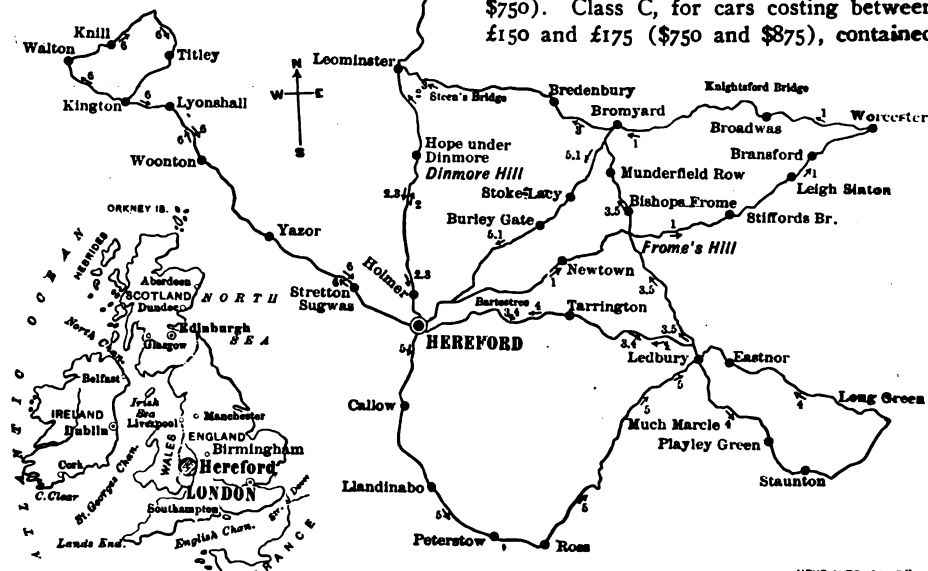

MAP OF THE COURSE AND OF BRITISH ISLES SHOWING RELATIVE LOCATION OF SECTION.

cars were made clean for the next day's run. A further change was introduced, which made the conditions of the trials approximate more to those of touring. A motorist does not object ordinarily to giving a reasonable time for adjustments and repairs to his car when in the garage; what

he particularly dislikes is having to make repairs by the roadside; hence in the trials absolute non-stop runs on the road were required, but a reasonable time—twenty minutes—was allowed for adjustments before starting on the day's run. The same route was followed each day, both in the morning and in the afternoon, two hours interval being allowed at Hereford for luncheon.

Thirty-eight cars were officially entered, and these were divided into four classes. Class A was for cars costing less than £125 (\$625), and contained only three cars. Six entered in Class B, which was for cars selling at between £125 and £150 (\$625 and \$750). Class C, for cars costing between £150 and £175 (\$750 and \$875), contained

twelve cars; while seventeen cars, costing between £175 and £200 (\$875 and \$1,000), were in Class D.

All of these cars used petroleum spirit as the motive power; seven of them had two-cylinder engines; one had even a four-cylinder motor, while the remaining cars had single cylinders. With regard to the seating capacity, three cars—the Horley, Mobile and Cadillac—held four passengers including the driver; three more had accommodation for three riders, while the remaining thirty-two seated two passengers each.

All the cars had pneumatic tires except the 6-horsepower Jackson dogcart (No. 4), which was shod with the De Nevers grooved solid tires.

America was represented in the trials by the 7-horsepower Oldsmobile in Class B, and by the 9-horsepower Olds tonneau and the 8-horsepower Cadillac in Class D.

The cars were stored in the local Volunteers' Drill Hall over Sunday, and soon after 7 a. m. Monday the drivers filled the tanks, and, in company with the club's official observers, who were always with the cars when out of the Drill Hall, and who noted all stoppages and repairs, set off for the main street, where the machines were marshalled in line.

Promptly at 8 a. m. the first car—the



DOROTHY LEVITT, WHO DROVE THROUGHOUT THE TRIALS, MAKING A GOOD RECORD.

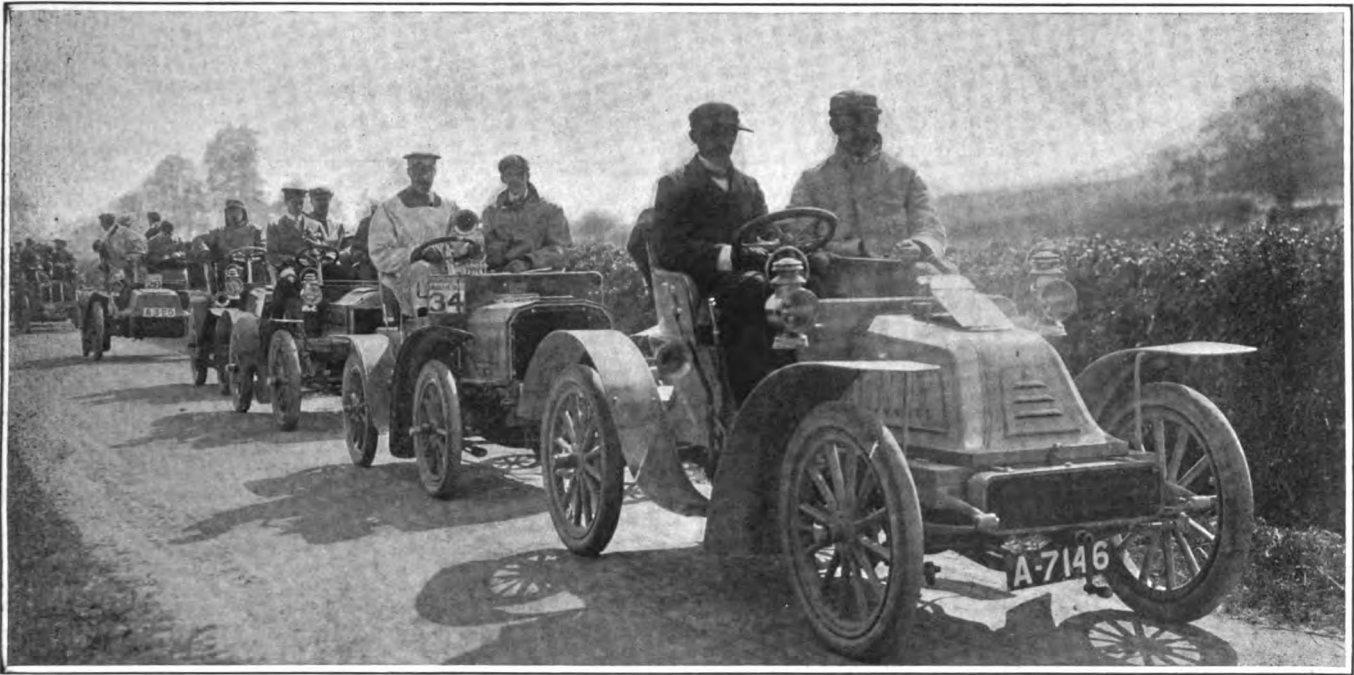

CARS IN ENGLISH TRIALS WAITING TO ASCEND FROMES HILL—OLDSMOBILE AND CADILLAC IN THIRD AND FIFTEH POSITIONS.

6-horsepower Siddeley—was sent off on its fifty-mile journey to Ludlow and back, followed by the other cars at one-minute intervals. In order to prevent any racing along the route, a rule was made forbidding the cars to pass one another except when climbing hills, or with the mutual consent of the drivers in the various cars. Having seen the last car despatched, the writer followed in one of the press cars provided by the Automobile Club. Although the day was excessively hot, the dust did not cause much inconvenience, as the cars kept some distance from one another. Rapidly overhauling the competitors, we reached Dinmore Hill, where the timed hill-climb was held in the afternoon. Half way up the ascent the 7-horsepower Oldsmobile was in trouble with an obstruction in the radiator, which caused overheating. This caused so much delay that the car was withdrawn from the trials—rather hard luck.

Speeding along past apple orchards and hop-fields, we soon passed the 6-horsepower Royal Enfield, in trouble with a water connection. A mile further on we reached Leominster, in the main street of which quaint old-world town we saw the 7-horsepower Downshire—an Irish-built car, with a two-cylinder horizontal engine—abandoned by the side of the road. A broken clutch-fork was, we afterward learned, the cause of the failure. Ten miles through pleasant country, and Ludlow, the scene of many a battle, was entered, *en fête* and crowded with spectators eagerly watching the cars. Indeed, a surprising feature of the trials was the manner in which the people lined the streets' of the villages and towns to cheer the competitors passing by.

Turning around on a piece of meadow land without stopping, the cars returned by

the same route to Hereford, reaching the Drill Hall by 11 a. m. As each car was driven into the shed the driver had only to switch off the current and petrol and then leave the building until the time came for the afternoon run. This prevented any attempts being made to perform repairs or make adjustments without the notice of the observer.

The afternoon's run took place over the same route as in the morning, but this time the cars were timed up Dinmore Hill—just a mile in length. The average gradient was 1 in 18, and the steepest portion had a rise of 1 in 10 for some distance. All the cars easily surmounted this, the best speeds being made by the first 6-horsepower De Dion, whose speed worked out at 16 1-2 miles an hour. Next came the 6-horsepower Wolseley and 7-horsepower Swift, the speed of both being more than fifteen miles an hour. No cars were withdrawn during the afternoon's run, although several stoppages occurred, caused by a puncture to the Royal Enfield and a stuck inlet valve on the Clyde, and carbureter troubles on several cars, due to the dust, which hung like a cloud of smoke to a great height above the road. Drivers and observers returned to Hereford thickly begrimed with white dust, which penetrated everywhere. On the completion of the run the cars were washed in the cattle market and taken back to the Drill Hall, where two stalwart police officers kept out all intruders—press men and officials as well—who had not a permit signed by the indefatigable and obliging secretary, Mr. Basil Joy.

Tuesday was, if possible, even hotter and more dusty than Monday. The run, to Worcester and back, included the ascent of Fromes Hill. Thirty-three cars set

out at 8 a. m., and after an undulating run of ten miles over dusty roads, reached the hill. On the morning run the times were not taken on the ascent, but nevertheless a large crowd of motorists and others assembled to see the fun. The hill is half a mile in length and has an average gradient of 1 in 11, approximately 9 per cent. On turning a sharp corner, which had of necessity to be taken slowly, the car was at once confronted with a 1 in 10 rise, which rapidly steepened to a gradient of 1 in 8 (12 1-2 per cent). This dropped off slightly, and then came a final rise of 1 in 6 (16 2-3 per cent). This last portion proved too much for many of the little cars, which had, some of them, to shed their passengers, some to be ignominiously pushed up. A horse had been obtained by the club, ready to assist any car that got stuck, but fortunately no car fell so low as to require the aid of the animal. About seventeen cars got up without assistance, including the 6-horsepower De Dion, driven by Miss Dorothy Levitt, the only woman driver in the trials. On reaching the summit of the hill Miss Levitt was presented by some kindly-disposed villagers with a bouquet of beautiful flowers. Not to be outdone in generosity, some wags straightway made up a bunch of carrots and thistles and presented it with due ceremony to F. Goodwin, the old cycle racer, when he came up the hill at a good speed on his 7-horsepower Star.

From Fromes Hill the cars ran to Worcester, returning to Hereford via Bromyard.

In the afternoon the speed of the cars climbing Fromes Hill was taken, the 6-horsepower Wolseley doing the best, at a rate of twelve miles an hour. Five 6 and

7-horsepower cars made a speed of more than ten miles an hour, and Miss Levitt attained a speed of 91.2 miles.

When the day's run was over it was found that the 9-horsepower Cadillac had retired through the seizing of one of the gear shafts, while the 8-horsepower Rover had also withdrawn from the contest. The Rover has ball bearings in the engine, gear-box and wheels. One of the balls in the bearing of the two-to-one gear had broken and the pieces had smashed the timing gear pinions. This was very hard luck, as the same car had been driven more than three thousand miles previously without any trouble, and was doing well in the trials. The driver of the Cadillac (Mr. Bennett) remedied the mishap to his car, but when nearing Hereford later in the evening the gear again seized and he withdrew the car from the trials. The day's hill climb had effectually reduced the number of cars which had made all non-stop runs from the beginning of the trials. Whereas Monday night twenty-two cars had made complete non-stops from the start, their number was reduced to eight by Tuesday night.

Thirty-one cars still remained Wednesday morning. The fifty-mile route from Hereford to Leominster via Bromyard, returning home over Dinmore Hill, afforded the third and last opportunity to show their hill-climbing qualities, for the time on the ascent of Dinmore Hill was to be taken on the afternoon run—this time on the opposite side of the hill to the one of Monday's climb. Having survived Fromes Hill, most of the cars pursued their way without trouble. The 6-horsepower Royal Enfield was stopped, however, by a broken oil pipe, and afterward retired from the trials.

Heavy rains came on in the afternoon just as the cars were starting out, and before long the dust was converted into greasy mud. To make matters worse, flocks and herds of sheep and cattle were continually encountered, owing to the fact that it was market day at Hereford. Luckily, no accidents took place; or, at least, none were reported. Five miles from home Dinmore Hill was reached. This ascent was just short of a mile in length, the average gradient being 1 in 16, and the steepest part 1 in 10. No car experienced difficulty in mounting the hill, and although the times of several were spoilt by a herd of cattle which blocked a corner on the hill, the speeds attained by the rest were not bad. The surface of the road was very bad, being nearly an inch deep with red clay and thick mud. The best climb was that of the first 6-horsepower Wolseley, which came up at better than fifteen miles an hour. Three others made the ascent at more than thirteen miles an hour.

Twelve cars made non-stop runs both morning and afternoon; but only five cars—the two De Dions, one Wolseley, the Croxted and the Siddeley—had made non-stop runs every day. These same five con-

tinued to keep their record unblemished until the very last run of the trials, when one of them had to stop.

Thursday morning opened with fine weather, and the roads were in perfect condition after the rain, except at two or three spots, where, sheltered by trees, the road was very greasy and dangerous. Two cars experienced side-slips which brought them to a standstill. However, the judges decided not to count this as a stop. Thirty cars started on this day's run to Ledbury and back, but hardly had the engine of the 6-horsepower Vauxhall warmed to its work when its connecting rod snapped, putting the car out of the trials. A mile further on it was joined by a companion in misfortune—the 6-horsepower Horley, which broke its exhaust valve seating. The remaining twenty-eight cars completed the day's runs without trouble.

An amusing comedy Thursday served to relax the strain so severe in trials of this description. Miss Dorothy Levitt is always accompanied on her car by a little black Pomeranian dog, which attracts much attention. The idea occurred to several drivers to likewise carry mascots, and accordingly the toy shops of Hereford were ransacked for dogs, and in the afternoon nearly every car had a black toy dog fastened in front on the bonnet or radiator, while the drivers wore little china dogs in their coat lapels. Miss Levitt had her revenge by sending a large quantity of dog biscuit to the smoking concert of drivers held that evening, with a note instructing that they be given to the members of the "canine society."

Friday's run was via Ross and Ledbury to Bromyard, and then back by the same route to Hereford. The Malvern Hills provided some magnificent scenery, and the route was one of the most delightful of the week. There were some hard gradients, particularly at Bishop's Frome, near the scene of Tuesday's struggle. This has a gradient of 1 in 7 all the way up, and here the judges decided to hold a test of brakes, to ascertain their power to hold the cars when running backward. Each car was stopped on the steepest part of the hill, allowed to run back by its own weight, and then had to be stopped by each brake in turn. Finally the car had to be started again on the stiff gradient. In most cases both hand and foot brakes were all that could be desired, but in two or three cases the hand brakes would not hold the car quite still without the aid of the foot-brake. In the afternoon another brake test was held on a hill when just entering into Hereford. The cars had to perform the same operations as before, but this time while running forward. All came through the test with success. The cars had by now done 500 miles in a very hilly district, and no adjustments to brakes had been made since the start.

Saturday was perhaps the finest day of the week. A slight shower overnight left

the roads in fine condition, and the air was sweet and pure. The route lay to the border of Wales—to Kingston—then over a loop run of ten miles, through fine mountain country, then back to Hereford by Kingston.

In the morning twenty-six cars started, and of these twenty-three made non-stop runs—not a bad performance, as the route was very hilly. In the afternoon the last run of the week's trials, nineteen non-stops were recorded. Miss Levitt, when ten miles from the end of the trials, experienced her first penalized stop. A loose nut on the needle-valve of the carbureter took seventy-five minutes to repair, and so put her out of the special non-stop awards. Not only this, but the other 6-horsepower De Dion, which made non-stops every time during the week, was also barred from these awards, as these two cars were made to run as a team, and each was to be penalized by the other's stops. Other stoppages occurred to the Speedwell, which broke an exhaust pipe, and to the Mobile, on which the inlet-valve broke.

When the cars were within two miles of Hereford on the last journey they were halted and a procession formed. Headed by a brass band, the competing cars proceeded in single file, followed by about forty cars belonging to visitors and officials. Through the streets of the town the procession went at a slow pace, and the crowds cheered enthusiastically. Thus the Light Car Trials of 1904 came to a fitting end.

With commendable promptitude the judges at once set to work, and at about 1.30 a. m. Sunday morning the results were announced to the expectant press men. These awards were made subject to the committee's final decisions, which will not be made known for some time yet.

Class A.—First award, 6-horsepower Speedwell, 7 non-stop runs. (Highest possible number, 12.)

Class B.—No non-stop award.

Class C.—First award, 6-horsepower Siddeley, 12 non-stops; second award, the two 6-horsepower Wolseleys, 12 and 11 non-stops; third award, 6 1-2-horsepower Humberette, 11 non-stops.

Class D.—First award, 10-horsepower Croxted, 12 non-stops.

In addition, the two De Dions were very highly commended, while the two 7-horsepower Swifts were also commended.

An enterprising undertaker, according to the Greenville (O.) *Tribune*, has invented an auto-hearse, and his daughter says "folks are just dying to ride in it."

Charles T. Higgins, of Pleasant Prairie, Wis., has started a movement to bring about the passage of a State law to regulate the use of automobiles on the roads throughout the State. Petitions have been forwarded to the town chairman of every town in Wisconsin asking co-operation in the movement.

Homeward Bound from the Fair.

Incidents of the Return Journey by One Party of A. A. A. Tourists—St. Louis to Cleveland.

Special Correspondence.

WHILE most of the automobile tourists who participated in the St. Louis tour shipped their cars home, a dozen or more machines were driven back over the roads. Among these was the *Pathfinder*. Hard rain Friday and Saturday caused us to postpone our start until late Sunday afternoon, August 21. Even then the roads were in an almost impassable condition, and we "plugged" through such mud as few States except Illinois can boast.

Crossing from the World's Fair city on the East St. Louis bridge, for which the usual toll of thirty-five cents was paid, we drove as far as Collinsville over the "bumpety" roads familiar to those who were in the run of August 10 from Springfield, the bumps being interspersed liberally with water and mud, in which the axles of the low car went completely out of sight more than once. Highland was reached that night, and quarters had just been secured at the Columbia Hotel when it began to rain once more. Rain fell all

jelly and sauce, cake and home-made pie. While the landlord, who insisted upon waiting on us himself, piled the dishes before us he apologized because he did not have time to roast a chicken, but said he would have it ready for our breakfast, and he did.

After loading up with gasoline, which sells throughout the country between St. Louis and Cleveland at from 14 to 18 cents

were wound around the tires at regular intervals, but they would last only for a mile or so, although the rope was the toughest half-inch hemp we could find. The ten pounds of rope lasted just ten miles, when we stopped for a consultation.

"I guess we'll have to try chain, although I hate to cut the rims," said my companion, and we started on a hunt for chain. All we could find was well-chain at the grocery, a kind of chain made out of what appeared to be heavy wire, the links soldered instead of welded. Enough to wind around the two rear wheels was bought and wound around the tires, jumping every other spoke so as to miss the valve and three lugs. As there are twelve spokes in each wheel, there were

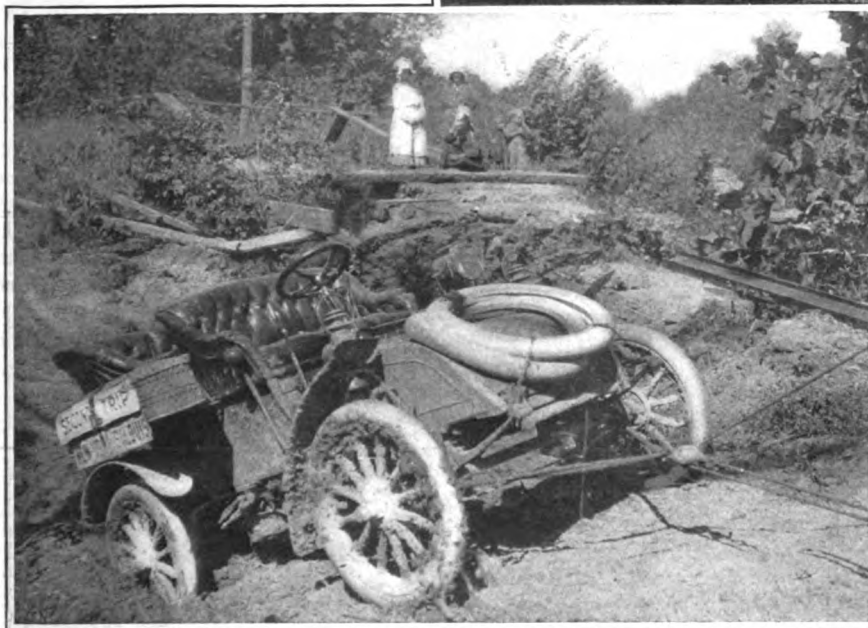

GETTING AROUND A WASHED OUT BRIDGE IN ILLINOIS WITH BLOCK AND TACKLE.

that night and until 10 a. m. Monday morning.

When we drew up in front of the hotel, at 7:45 o'clock, Sunday night, and inquired, "Can we get something to eat?" the proprietor replied heartily: "Well, you bet," and summoned the cook from the side of her "steady" at the side door and put her to work at the fire. In fifteen minutes we sat down to a supper consisting of porterhouse steak, tender and well cooked; corn on the cob, green peas, stewed potatoes, sliced tomatoes, cucumbers, celery, olives, hot biscuit, corn bread, three kinds of

a gallon, we purchased about ten pounds of rope to wrap around our tires, and started eastward along the National pike. We had been through mud before, but with the exception of a short stretch in the Catskills had never been obliged to wrap the tires. Here the mud was so slippery, however, and the hills so steep that it became necessary to do so. At first a long piece of rope was wound around the wheels, passing between every alternate pair of spokes, but this arrangement did not last a mile, the rope cutting through and the loose ends flying around. Then short pieces of rope

AFTER AN ILLINOIS THUNDER STORM.

six rounds of chain. For ten miles all went well, then we heard a fearful racket. The chain links had pulled open and the loose chain ends were flopping around against mud guards and body. The chains had stretched so much that four links had to be taken out of each. After that we had to get out and fix the chains again about every two miles, and to make matters worse it began to rain again, so we stopped at Greenville for the day.

Conditions were a little better Tuesday, and although the road was rough, we made about ninety miles and put up for the night at Greenup, car and occupants so plastered with mud that they were hardly recognizable. At each of the towns named we were told that several St. Louis tourists had passed through on their way home.

Wednesday we ran through Terre Haute to Stilesville, a little hamlet about forty miles east of that city. Supper was eaten at Manhattan, a hamlet still smaller than Stilesville, with a population of thirty-five inhabitants and boasting of a water-tank, a combination store, under the roof of which everything from a paper of pins to a coffin was sold, and the hotel, which was constructed in 1838 and was famous as a stopping place on the old stage line of the early

forties. The dining-room was just large enough for one small table. Its plain board walls were painted a bright red and adorned with a few colored lithographs. A bright rag carpet was spread over the floor. While the furnishings were humble, the supper was all that any one could ask for, cooked in the old home style and including seven different kinds of jams and jellies. The price of that supper for two was fifty cents.

After supper we ran on to Stilesville, arriving at 9 p. m. The hotel, about the same kind as the one in Manhattan, was dark and silent. When the landlord was finally aroused he led the way upstairs, lamp in hand and in his night clothes. The hotel was built without halls, and we were obliged to pass through several other sleeping rooms before reaching our quarters for the night. Although we did not ask to be called in the morning, it seemed as though we had hardly closed our eyes before we were aroused by a voice outside the door, saying: "Wall, the day has come." A glance at the watch showed it was 5 a. m., and we got up. The dining room differed from the one at Manhattan only in being painted blue instead of red. The breakfast, consisting of fried chicken, creamed potatoes, sliced tomatoes, oatmeal, melon, hot corn-bread and jellies, was even superior to the repast of the night before.

After breakfast we lounged in the front room for a few minutes. Crayon portraits of each member of the family hung on the walls or stood on easels, while a "God Bless Our Home" worsted motto and a baking powder poster completed the wall decorations. A grandfather's clock, "tidies" on the backs of the wooden rocking-chairs, a vari-colored rag carpet on the floor and an ancient organ in the corner of the room comprised the furniture. It was worth a 100-mile trip to pass the night at such a place.

From Stilesville we ran into Knightstown, from Knightstown to Lima, and from Lima to Cleveland, through Findley, Fostoria, Fremont, Clyde and Norwalk. The roads in Indiana were generally good, tons of crushed stone being spread on the surface each year. Ohio also possesses good highways, with an occasional bad stretch, and the soil is so sandy that when it rains the roads do not stay wet long. In several places bridges were down, and once the car had to be let down into the stream by blocks and tackle and hauled up the opposite bank by the same means. Some of the hills were steep, and several times the low gear had to be used on grades that must have been nearly 20 per cent.

Just before entering Brazil, Ind., we met two negro automobilists speeding along in an Olds runabout. Inquiry developed that the owner was Dr. Oliver, of considerable fame and a large practice in that locality. He is an enthusiastic motorist, owning three automobiles of different makes and power.

The days of the old "prairie schooner" were supposed to be at an end until we started on this return trip over the National

highway, but we passed no less than twenty-five of these big covered wagons, loaded with farmers moving westward to locate in new fields. They were drawn by all manner of quadrupeds, from diminutive donkeys and oxen to powerful draft horses, and carried in some cases families with more than a dozen children. They traveled by day and camped by the roadside at night, preparing their evening meal over a small bonfire and stretching out on the ground beneath their wagons to sleep.

The wide tread on wagons in Missouri and Illinois did much to retard our progress in those two States. The tread is about six inches wider than the eastern standard, causing the wheels on one side of our car to ride on high, rough ground, while those on the other side ran in ruts. The wide tread, it was said, prevents the mud from clogging between the wheels and the wagon bodies and bringing the vehicle to a standstill.

Dogs in that section seem to have a greater aversion to automobiles than the canines of the East, and our sling-shot, a relic of our former trip, was frequently used to prevent them from getting under our wheels.

Log cabins, seldom seen in the East, are plentiful throughout southern Illinois and Indiana. Some of these houses, many of which were built more than half a century ago, are still used as residences by families that are well to do. They insist upon living in the homes in which they were born, and in some cases in which their fathers were born.

PERCY F. MEGARGEL.

(To be continued.)

Geneva, N. Y., Repair Shop.

Motorists who have occasion at any time to stop in Geneva, N. Y., at the north end of Seneca Lake, will find there every facility for storing and repairing their cars, as J. A. Place has equipped a roomy building with the necessary tools and supplies. The engraving herewith shows a corner of his establishment, at 39 Linden street, in which he has storage room for ten vehicles and the latest machinery and apparatus for the care and repair of cars, even to the rebuilding of machines and the assembling of new engines. In connection with his automobile business he conducts the largest bicycle and general repair business in Geneva.

The chassis seen in the picture shows one of the rebuilding jobs done in this shop. It is the frame of an old Model F Packard from which the single-cylinder engine and transmission were removed and replaced by a Brennan double-opposed 20-horsepower engine and transmission. Since completion this car has given good satisfaction, being a very strong and fast vehicle. Mr. Place is now preparing to equip it with a new force-feed oiler, patented by himself, and which he expects to put on the market soon.

Automobilists who allow oil to drip from their machines onto the asphalt pavements of Chicago are liable to arrest and a fine of \$25 to \$250, according to acting Corporation Counsel Barge, who holds that the matter is covered by the ordinance intended to apply to peddlers of oil.

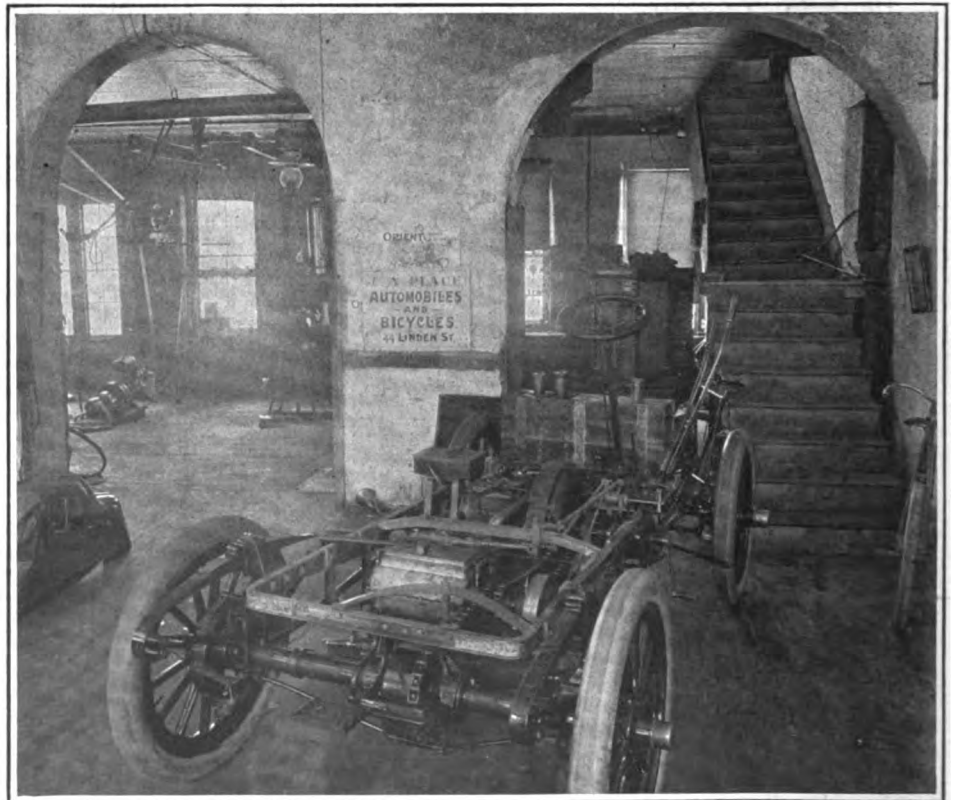

CORNER OF J. A. PLACE'S REPAIR SHOP IN GENEVA—TRANSFORMED CAR IN FOREGROUND.

Thomas 1905 Car.

One of the American manufacturers of automobiles whose aim is to produce machines equal in every respect to the best foreign cars, while built with particular reference to their use on American roads, is E. R. Thomas, of Buffalo, N. Y., head of the Thomas Motor Company. The 1905 model Thomas Flyer, illustrated by the

the same horizontal plane, is an auxiliary frame of angle steel, upon which the motor and transmission are carried. This inner frame is secured to the main frame by angle steel cross-members at the ends and short intermediate braces, the whole forming a frame of great stiffness, well calculated to resist lateral as well as vertical strains. The spring hangers, of forged steel, are attached to the main frame mem-

inches long. The automatic inlet valves are of nickel steel, 1 7-8 inches in diameter, with a lift of 3-16 of an inch. A pressure of one pound is required to open the valve fully. The exhaust valves are 2 3-16 inches in diameter and open 1-4 of an inch. Both inlet and exhaust valves are located on the same side and in the same housing, and both may be removed through the same opening on the top, which is closed by a

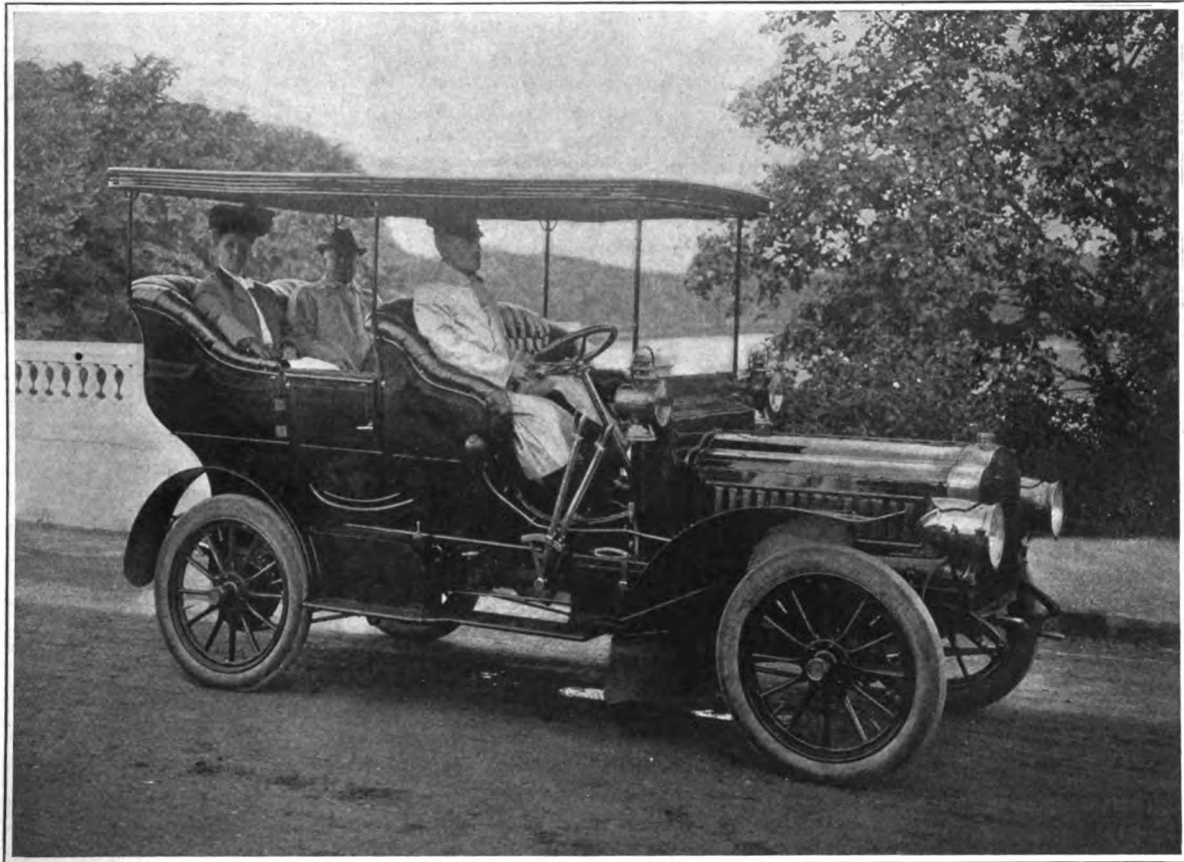

THOMAS FOUR-CYLINDER CAR.—Mr. and Mrs. E. R. Thomas Starting on Tour of North Atlantic and New England States.

accompanying reproduction from a photograph, has been driven by Mr. Thomas this summer for testing out purposes, and has stood up so well under its work that its designer believes he has found the main features of the kind of car he is seeking to build, and that further development will be chiefly in the matter of detail.

The leading Thomas car for 1905 will be a four-cylinder machine rated at 40-horsepower, with side-entrance to the tonneau. The body, which is made entirely of metal, embodies so many novel features that a patent has been applied for. One of the details to which much attention has been given is the provision of stowage room for tires, tools and personal baggage. This has been worked out in an ingenious manner, and the amount of room available for stowing away the hundred and one things the automobilist needs on his tours is really surprising.

The main frame of the Thomas car is of pressed steel, channel section, tapered at the ends. Within this frame, and lying in

bers by hot riveting. The springs, which are attached in the usual way by shackles, are semi-elliptical all round and all have seven leaves. The front springs are 44 inches long and 2 inches wide, and the rear springs 48 inches long and 2 3-4 inches wide. The great length of the springs has a very beneficial effect on the riding of the car. The axles are of tubular steel, the front one 1 1-8 inches in diameter and the rear one 1 3-4 inches, both being dropped inside the frame. The drive being by side chains, the rear axle is not divided, and the differential is placed on a countershaft.

The road wheels and the differential shaft run on roller bearings, these being so arranged that strains are either applied between bearings or equally on each side, obviating twisting strains. The wood artillery wheels are 34 inches in diameter and shod with 4-inch tires.

The motor, hung at the extreme forward end of the inner frame, has four cylinders, with a bore of 5 inches and a stroke of 5 1-2 inches. The connecting rods are 10

brass cap held down by a yoke and two studs. The valve housing caps for all four cylinders are permanently attached to branch pipes, and these in turn connect with the pipe leading from the carbureter. To remove the valves it is not even necessary to loosen the nuts on the studs on either side of the yokes, a set screw placed in the center of each yoke bearing on the top of the cap. The loosening of these set screws and the unscrewing of a single union is all that is required for the removal of the valves. The exhaust pipes are made in a single branched casting, which does away with a good many extra joints. The crank-shaft, a steel forging, is 1 3-4 inches in diameter at the main bearings and 1 5-8 inches in diameter at the crank-pins. The bearings on the crank-pins are 2 1-2 inches long, the three bearings between the cranks 2 3-4 inches long and the main shaft bearings 4 inches long. Chain lubricators are used on the latter and have given satisfaction. White bronze anti-friction metal is employed for shaft

bearings. The aluminum crank-case is divided horizontally, the bearings all being attached to the upper half. This construction makes it possible to remove the lower half of the case without disturbing any of the moving parts; but if required, the caps may be removed from the bearings and the shaft taken down and the pistons removed from the cylinders without deranging the remaining mechanism of the motor, breaking joints or disconnecting the wiring. The cam-shaft is on the outside of the crank-case, the cams being enclosed in brass housings. The two to one pinion on the motor shaft is of fiber, and the gear of steel. The carbureter is of the float feed type and has an automatic device for varying the amount of air admitted as the speed of the motor changes. The water-cooling system comprises a Whitlock radiator and tank combined, containing three gallons of water; a centrifugal pump, gear driven from the secondary shaft, and a fan behind the radiator, driven by belt from the motor shaft.

The dashboard of the Thomas car is one of its peculiar features. Instead of the usual flat construction, it is made hollow, of steel, and the usual attachments are thus protected from accidental knocks and the weather, and are out of the operator's way. The dashboard is divided into three sections. The central section is occupied by the single coil used for all four cylinders; the commutator and the lubricator, the latter being of the mechanical type, having a separate pump for each lead. The switch for cutting off the ignition current is placed on the front of the coil box. On either side of the central section of the dashboard is a compartment fitted with pockets for tools and closed by hinged doors. The bottom of the dash forms a drip pan to catch any oil that may escape from the lubricator.

The power developed by the motor is transmitted to the rear wheels through a conical clutch and squared shaft to the transmission gear, and thence by bevel gear to the differential, which, as already stated, is on a countershaft. The differential is in the same casing with the transmission gear, and the whole is exceedingly neat and compact. The gear-case cover is provided with a large removable section; or the whole cover may be removed, if necessary, without disturbing any of the gearing or bearings. The clutch is self-contained, and is engaged by moving the internal member away from the motor, instead of toward it. The transmission gives three forward speeds, with direct drive on the high gear, and reverse. The transmission from the sprockets on the countershaft to the rear wheel sprockets is through heavy hardened-pin chains.

The controlling system consists of three pedals, two side levers and a small lever on the steering column. One of the side levers is the speed lever, and the other applies the emergency brake. The outside pedal applies the differential brake, the

middle one is the accelerator, and the inner one the clutch pedal. The small steering column lever controls the timing of the spark. An interlocking device is provided which makes it impossible to shift the speed-changing gears unless the clutch is disengaged. The clutch pedal, when depressed to throw out the clutch, draws backward a steel pin which, when the clutch is in, fits into a hole in a quadrant on the shaft which carries the speed lever at one end and the gear-changing arm at the other. As long as the pin is in position it absolutely prevents the rotation of the shaft; consequently the lever cannot be moved to shift the gears. As there is a hole for every position of the gears, the lock is equally effective, no matter what the position of the lever may be. Another interlocking arrangement is set in operation when the emergency brake-lever is pushed forward. Through a substantial countershaft and connecting arms, the ap-

side. Under the tonneau floor there is a space, reached through a door in the rear, in which a spare tire, several inner tubes and tire repair outfit may be placed, while just beneath this is still another space for tire pump, large tools, jacks, waste and other things not constantly in requisition. On top of the suit case box in the tonneau is a sort of shelf, surrounded by a brass railing, where umbrellas and canes may be deposited. In the upholstery of each door is a capacious pocket, covered by a flap, and smaller pockets are formed in the upholstery just in front of the seats. The two tool lockers in the dashboard, already referred to, complete the list of storage spaces.

The wheel base of the 1905 car is 104 inches and the tread standard. Steering is through an adjustable worm gearing. A device that might be useful in a hilly country is a ratchet arrangement on the rear hubs. By dropping a latch on the dash-

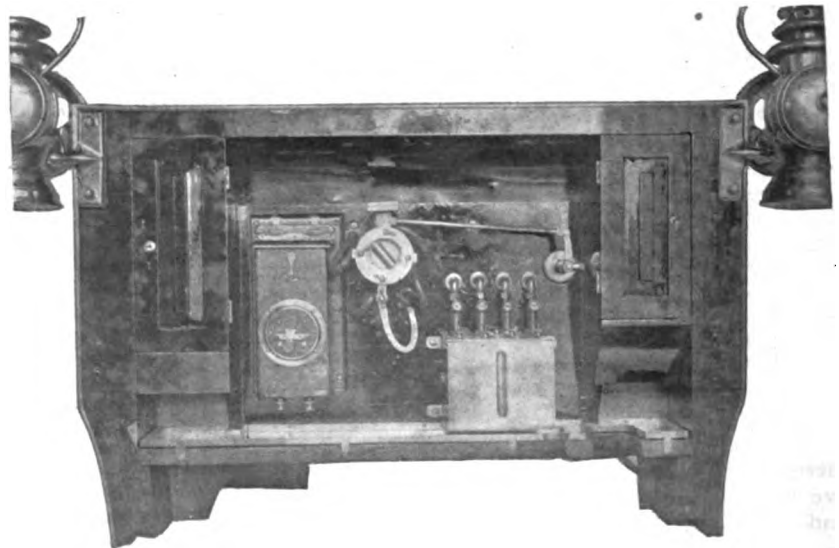

STEEL DASHBOARD OF THOMAS CAR.—TOOL LOCKERS IN UPPER CORNERS.] 5

plication of the emergency brake also applies the differential brake, disengages the clutch and throttles down the speed of the motor. The application of the differential brake also throttles the motor, preventing its racing when running light.

The peculiar form of this new Thomas body is said to have the effect of preventing dust from rising into the tonneau, it being deflected downward by the curves of the rear portion of the body. The side entrance is noticeably wide, and the door, when open, swings right back against the side of the car, leaving a perfectly unobstructed entrance, and one which is very easy to use. The storage room provided should be welcomed by tourists who use this car. Under the tonneau seats is a locker measuring 36 inches long, 10 inches wide and 12 inches deep. In the partition forming the back of the front seat is a space, closed by a hinged door, in which two suit cases will fit nicely, still leaving room for a series of little shelves at each

board pawls are dropped into the ratchets, so that the car cannot run backward on a hill, no matter what may be the condition of the brakes. Speed, up to 40 miles an hour. Weight, ready for the road, 2,500 pounds.

Lament No More

O speak no more of bygone days,
When knights in armored mail
Sang songs of love in roundelays
Amidst the battle's hail.

Nor tell a tale of Gretna Green,
Then sigh: "It is no more."
You hear again the lady's scream,
The postboy slam the door.

And do not dream with half-closed eyes
Of Romance long since dead.
I' faith there's more romance and sighs
Than you or I've heard said.

L'ENVOI.

The days of yesterday are gone,
This much alone I ween:
But days of yester can't compare
With these of gasoline.

—Chicago Post.

Patents

Roller Sprocket Chain.

No. 769,971.—C. E. Whitney, of Hartford, Conn.

An arrangement of pins, bushings and links, permitting easy renewal of any portion without slackening the chain or cleaning off adherent dirt. The bushings *d* are prevented by the flattened ends *e e* from turning in the inner links *b b*, and the pins *c* are prevented by their own flattened ends from turning in the outer links *a a*. The pins,

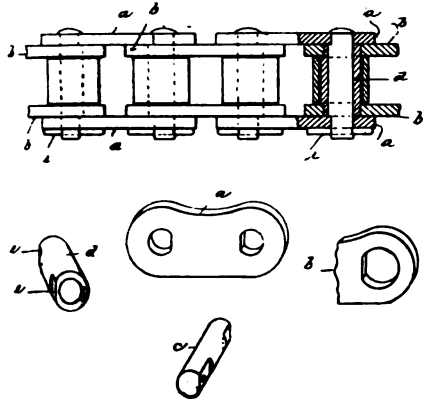

WHITNEY ROLLER CHAIN.

therefore, must turn in the bushings, which gives them a large bearing surface and long life. In addition, the use of cotter pins *i*, to retain the pins, permits the withdrawal of any pin by taking out the cotter.

Storage Battery.

No. 769,975.—J. P. Wood, of Buffalo, N. Y.

A design of the plate lugs, whereby the positive and negative plates are separately suspended, each on its own horizontal rod. The positive plates *2 2* have short lugs *4*, and the negative plates have long lugs *12*, apertured to permit the horizontal suspension rods *6* and the insulating and spacing rings *7* to pass through them. The negative plates *3* are hung from rods *15*.

Reversing Pinion Movement.

No. 769,840.—C. Schmidt, of Warren, O. A device whereby lateral movement of the conventional gear shifting lever is made to

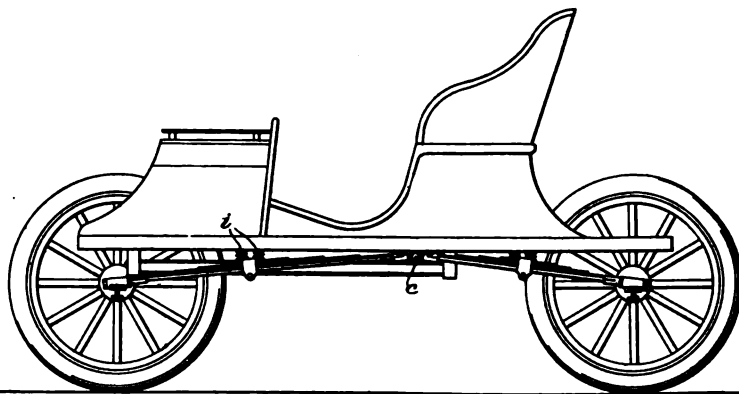

RENNELL RUNNING GEAR SPRING CONSTRUCTION.

engage the intermediate reversing pinion. The gears on the squared shaft *1* are shifted in the usual way, by shift rod *4* and hand lever *11*. When the latter is in the neutral position a lateral movement of it engages the hook *32* and moves rod *28* to rock lever *24*, which, acting on *23* and *21*, carries the reversing pinion *20* downward into face mesh with gears *d d*.

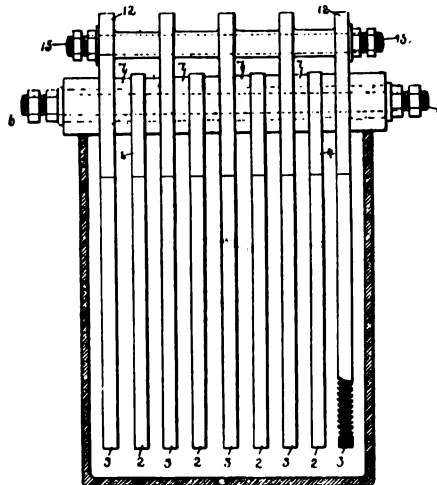

WOOD BATTERY PLATE SUSPENSION.

Running Gear.

No. 766,972.—T. B. Rennell, of Denver, Col.

A running gear having the novel spring arrangement shown. The rear ends of the forward springs, and the front ends of the rear springs, are attached to a transverse tube *c* of the main frame, the other ends of the springs being attached to the axles,

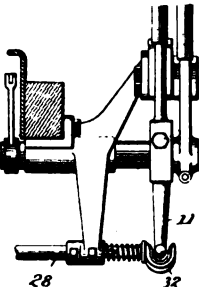

and the body rests on compression springs *i* mounted on the centers of the leaf springs just mentioned.

Lock for Adjusting Screws.

No. 770,194.—C. F. Splittorf, of New York.

A lock, consisting of a stiff helical spring compressed under the head of the screw, so that the latter is turned only with some effort. The device is intended chiefly for use with the contact screws of spark-coil vibrators.

Chain Adjustment.

No. 769,734.—H. Ford, of Detroit, Mich.

The object of this device is to permit adjustment of the chain at the spring seats without touching the radius rods. The spring rests, not directly on the seat or perch *A*, but on a plate *B*, whose position on *A* is adjustable by reason of the slots

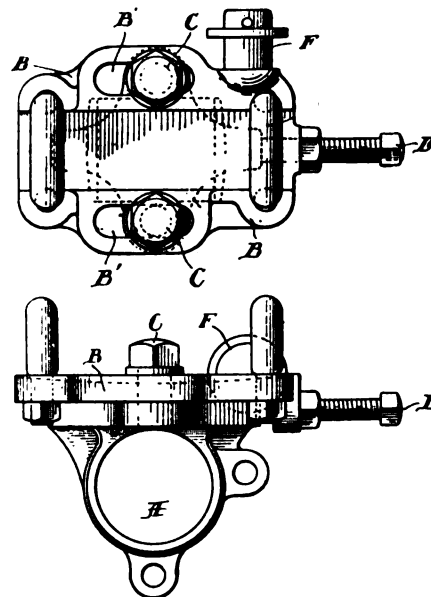

FORD SPRING-BLOCK ADJUSTMENT.

B1, through which the holding screws *C* pass. The radius rods pivot on lugs *F*, projecting from plates *B*, and therefore are of fixed length. The chain is adjusted by shifting the perches *A*, and with them the axle, forward or back, relatively to *B*, by aid of set screw *D*.

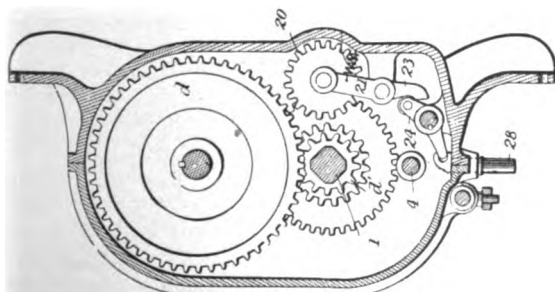

SCHMIDT REVERSING PINION MOVEMENT FOR CHANGE-SPEED GEARING.



VOL. XI.

No. 13

Published every Saturday by

THE CLASS JOURNAL CO.,Flatiron Building, Madison Square,
NEW YORK CITY.Cable Address - - - Autoland, New York
Long Distance Telephone - 300 Gramercy, New York**SUBSCRIPTION RATES:**United States, Canada and Mexico, - One Year, \$2.00
Other Countries in Postal Union, - One Year, \$3.00To Subscribers—Do not send money by ordinary mail.
Remit by Draft, Post-Office or Express Money Order,
or Register your letter.**FOREIGN SUBSCRIPTION AGENTS:****ENGLAND:**—Hiffe & Sons, Limited, 3 St. Bride Street,
Ludgate Circus, London, E. C.**FRANCE:**—Boyveau & Chevillet, 22 Rue de la Banque,
Paris.**GERMANY:**—A. Seydel, Mohrenstrasse 9, Berlin.To Advertisers—Copy or changes in orders for adver-
tisements should reach us not later than 5 o'clock p. m.
Monday for the issue of Saturday following.Copyright, 1904, by The Class Journal Company.
Entered at New York, N. Y., as second-class matter.The Automobile is a consolidation of The Automobile
(monthly) and the Motor Review (weekly).**Copies Printed This Issue, - - 12,000**

“ “ Since Jan. 1, - 470,000

**Rest Cure
for****Furious Driving.**

A great deal of mental energy is expended nowadays in the discussion of the automucker who, from an excess of vanity and an undeveloped brain, rushes through the streets at railroad speed, regardless of law or life. President Winthrop E. Scarritt, of the Automobile Club of America, is quoted in the *New York Herald* of September 21 as suggesting the possibility of stone-throwing being adopted by pedestrians as a protective measure. Mr. Scarritt is a strong advocate of faithful observance of the laws by automobilists, and we doubt if the statement credited to him in the interview was made with deliberation. Of course he did not recommend stone-throwing; he simply suggested the possibility of such acts of violence by a sorely aggrieved public. It is hardly safe, however, for a man of his high reputation and official position among automobilists to make a suggestion of this sort, especially as there are other very effective and thoroughly legal remedies that public opinion can demand and enforce.

The road user who breaks the law himself can hardly expect protection of the law from the automucker. There is one thing that will stop speeding in New York, and one thing only, and that is a term in the county jail. The magistrates of New York are to-day the persons really responsible for the lawless disregard of the speed regulations that is to be seen in the streets at

most any hour. Under the present law they have the power upon a second conviction for excessive speeding to send the guilty party to jail for thirty days. In no single case has this punishment been awarded. There is no place in which these would-be dare-devil drivers can cool off so comfortably as in a prison cell. It would need only a single application of this rest cure to restore the patient to a condition of decent sanity.

It is the fashion to denounce the chauffeur in these discussions. He is not always to blame. Any one who takes the trouble to look will frequently see the owner of a car either driving or sitting beside the chauffeur when the car is dangerously speeding in the city. In such a case he is morally responsible, and it is unmanly and cowardly to punish the chauffeur for the acts of his employer. The chauffeur is responsible only when he is driving and the owner is not in the car.

To enable the magistrates to properly enforce the law, an amendment can be passed at the next session of the legislature authorizing the issuance of licenses to chauffeurs as well as to owners, and making it compulsory that a record of conviction shall in every instance be indorsed on the certificate or license. In case of arrest, the examining magistrate, by looking at the certificate, can determine the number of previous convictions. This rule is in force in England with regard to the certificates of officers of the merchant marine, and accounts largely for the immense care they take in navigating the seas to keep their certificates free from indorsements. Such a rule here would also safeguard an employer, as a chauffeur, before getting a position, would have to show his certificate, and his record would be at once disclosed.

Talking about the speed violations will not do any permanent good; what is needed is action on the part of the magistrates and lawmakers.

**Abuse
of
Gas Lamps.**

While the desirability of using strong acetylene headlights or searchlights on automobiles using the country roads after dark is hardly open to question, the Fairmount Park Commissioners in Philadelphia are not alone in their belief that such dazzling illuminators are out of place on park drives and city boulevards. They point out with reason that the drives are well lighted, so that such lights are unnecessary, while their main effect is to alarm other users of the drives. If our memory does not fail us, the Fairmount Park rules were revised during the height of bicycle popularity so as to require "universal lights"—that is, lighted lamps on all vehicles of whatever character using the drives and boulevards at night. Similar laws were passed in many of the large cities of the country and are very generally enforced. This regulation removes the last reasonable objection to extinguishing, or at

least turning down the light of such lamps when in the parks. The combination of low speed limit, universal lights and well lighted drives renders probability of collision in the parks very slight.

The gentleman motorist will, as a matter of consideration for and courtesy to the many other frequenters of the parks, refrain from flashing into their eyes blinding white light projected by a lens and reflector. The effect of such lights is to render any object behind or at either side of them totally invisible, so that in crowded traffic they increase rather than diminish liability of collision. If they are of the swinging or pivoted type, they are exceedingly confusing, as those who are approaching are unable to tell the exact direction in which the vehicles carrying them are moving, or what turns they are going to make in parks where forks are frequent.

**Importance
of the
Cup Race.**

Two weeks from the date of this issue the Vanderbilt Cup Race will be held on the course selected in Long Island. The contest will be the most important automobile race ever held on this continent, and, indeed, second only in importance to a very few of the now classic events abroad. As a sporting event it is of the first magnitude, for four nations will compete for the honor of winning the William K. Vanderbilt, Jr., Cup. These nations are the United States, France, Germany and Italy. They will all be represented by picked cars, many of them previously tried out in the great foreign races, and they will be driven to win. The drivers on some of the foreign cars will be men whose names have been made familiar by past performances wherever automobiles are used. The cars that will represent Europe are without exception the product of some of the most skilled designers, of long experience in the construction of cars of maximum power for the highest possible speeds.

Viewed from the sportsman's standpoint, the race in all its constituent parts will outclass the track events with which we have hitherto been satisfied, as the *America's Cup* contest in yachting surpasses a race between catboats on the Sound.

Great as is its importance as a sporting event, this is far overshadowed by the influence it will exert over the automobile industry in America. On its success depends the future of road racing here, and on road racing depends the rate of progress of the development and perfection of the American touring car.

In the runabout field, in the electric carriage field, and to an extent in the field of commercial vehicle construction, America now leads the world. For the development of these road races are unnecessary. It is in the higher powered gasoline touring cars that our product as a whole suffers by comparison with the output of the French and German shops. Our builders have had no

opportunity to try out their constructions in the supreme test of racing on the road, which the foreign builder has so long enjoyed. Originality has been stifled, and much of the work that has been done has been necessarily in the direction of blind imitation of foreign design. Unable to carry out the exhaustive tests that road racing provides, our builders have been compelled either to imitate the successes of foreign builders whose cars have withstood such tests, or to build and sell to customers purely experimental constructions. They have honorably chosen the former alternative, which, however, is fatal to supremacy.

The Vanderbilt Cup race, finished without fatality to users of the road, means the extension of such racing to other centers and the gradual advancement of the United States to the position of a world power in the peaceful art of touring car construction.



Racing on the Cup Course.

Coöperation is what is needed to make the Vanderbilt Cup race a success. No person who is even remotely connected with the race, whether by intention of purpose or accident of locality, is free from a certain responsibility in this direction. The race is not for the amusement of a few, neither is it a one man nor one hundred men undertaking. It is a great international event, in which the competitors are spending thousands of dollars to decide on American soil who is the best driver and which is the best car. Self-seeking has as little a place in the coming contest as it would have in an international war—the success of the race is paramount. This depends on the exertions of all, from the responsible officials to the owner of a mongrel dog in a cottage by the course.

On none does the responsibility rest more heavily than on the intending competitors. Already there are rumors, which we trust are baseless, that some of the cars will be tried out at high speed over the course in the early morning hours. Nothing could more surely endanger the success of the race than such lawless behavior. It would only need this excuse to cause some of the disgruntled residents in the vicinity of the course to take legal steps to stop the race.

Aside from the law, courtesy forbids the annoyance of residents along the course by the dangerous speeding of cars, for they have generously donated the use of the highways on October 8. Sportsmanship demands that no contestant shall take an unfair advantage of the others by racing his car over the course before the day of the race. It is the plain duty of the race management and the local peace officials to cause the arrest of any persons who attempt such illegal racing over the course, and not only secure their punishment to the limit of the law, but bar them from any subsequent participation in the race.

ASKED TO REVOKE OWNERS' LICENSES.

Massachusetts Highway Commission Takes Under Advisement Evidence Presented at Hearing of Prominent Motorists Caught in Shrewsbury Trap.

Special Correspondence.

BOSTON, Sept. 19.—Automobilists are much interested in the result of the hearing which was given last Wednesday afternoon by the Massachusetts Highway Commission on the petition of the selectmen of the town of Shrewsbury, near Worcester, for the revocation of the licenses and certificates of registration of seven automobilists, who, the selectmen claim, exceeded the speed limits of the town. This is the first time since the automobile registration law went into effect, more than a year ago, that the highway commission, which has charge of the administration of the law, has been called upon to revoke licenses for illegal speeding. The towns, as a rule, have contented themselves with bringing offenders into court and having them fined. The highway commission has no judicial power in interpreting the law, but it is thought that the position which the commission must now take on the question of timing traps, identification of cars and revocation of licenses will be of much importance to the automobilists in guiding their future actions, both on the road and before the legislature.

The victims who were caught in the Shrewsbury trap were a representative body and included Asa Goddard, president of the Worcester Automobile Club; Frederick L. Ames, of North Easton; L. A. Crossett, of Abington; C. L. N. Cushman, of Boston; G. F. W. Stevens, of Boston; L. P. Sims, of Worcester, and E. F. Bell, of Beverly. They were all charged with speeding faster than is legal. The town was represented by counsel at the hearing and relied upon the testimony of a town constable who had timed the automobiles over a quarter-mile stretch and had taken the numbers of the offending cars.

In the case of Mr. Sims, which was taken up first, the defendant presented affidavits showing that on August 14, the day he was supposed to have been speeding in Shrewsbury, he was in St. Louis. He claimed that his machine was in a station in Worcester all the time he was away. If it was taken out it was without his consent or knowledge. Chairman McClintock, of the commission, ruled that Mr. Sims's whereabouts was of no consequence, as the owner of an automobile is responsible for it, wherever he or the machine may happen to be. In regard to the town's evidence, however, the chairman ruled that in order to prove that the machine alleged to have broken the speed laws was Mr. Sims's, the prosecution must identify it otherwise than by the number; in other words, that the mere number of a machine, without other description as to color or shape, is not a sufficient identity for purposes of prosecution. This ruling is considered of great importance, for the almost universal custom in the State has been to identify machines by their numbers. This ruling will be a severe set-back to the country constable, for he will have to post himself somewhat on automobiles in order to present sufficient evidence to satisfy the commission. Mr. Sims said that he could bring witnesses to prove that his machine remained in the Worcester station while he was away, and his case was continued for future hearing.

Mr. Goddard appeared for himself and said that in his opinion the method of tim-

ing used by the constable was not accurate. Mr. Crossett proved that he had sold his automobile to other parties before the time when he was alleged to have been speeding in Shrewsbury. Mr. Cushman was represented by counsel, who criticised the method of timing. Mr. Ames was not present, and his case will be taken up at some later date.

Before the hearing ended counsel for the town made an argument to the effect that there is great danger to the lives of the people of the state from the fast driving automobilists. They do not care for fines, and when summoned into court, or even when arrested, pay their fines and then go out on the road and speed again. He thought that the time had come when the State must intervene. In closing he said that the town would not ask for a revocation of the licenses of the accused, but would ask that the commission suspend their licenses for a time. The evidence introduced was taken under advisement, and the verdict will be awaited with much interest, for it is thought that the commission may take this opportunity to make public its position in the matter of overspeeding.

OBJECT TO CONFLICTING DATE

Point Breeze Meet Sanctioned for Same Date as Cross Country Run.

Special Correspondence.

PHILADELPHIA, Sept. 19.—Some of the members of the Automobile Club of Philadelphia feel that they have not been given proper consideration by the Racing Board of the American Automobile Association, which has granted to the recently organized Motor Power Association a sanction to hold a race meet on the Point Breeze track on October 1. As that is the date long ago selected by the A. C. P. for its cross-country race for the Brazier cup, it is felt that the A. A. A. should not have sanctioned a counter attraction for the same day in the same city, especially to a rival organization and without consulting the wishes of the older club. The A. C. P. is affiliated with the A. A. A. and pays into its treasury nearly \$200 a year, according to one of the members of the club.

The Runs and Tours Committee of the A. C. of Philadelphia last week sent a pilot car over the course selected for its "cross-country run" and found the roads in excellent condition, with the exception of a nine-mile stretch on the last leg, between West Chester and this city. Arrangements were made for lunch at Phoenixville and for checkers at each of the official controls—Ambler, Phoenixville, West Chester and a point to be selected in this city.

Officials of the Motor Power Association, of which George Banker is president, say they are determined to make their initial race meet a rouser. The program will be made up of four regular events—five, ten, fifteen and twenty mile contests—besides one or more special races. An effort was made to get Kiser and Oldfield for a match race for \$250, but it is understood that they are scheduled for Chicago on the same date.

Americans who contemplate automobilizing in England will do well to remember that when meeting another vehicle in the road the turn must be to the left, and not to the right, as in this country.

An Irish hostelry which makes a specialty of catering to the wants of automobilists rejoices in the suggestive name of the Dew Drop Inn. Doubtless they do drop in.

AMERICAN AND FOREIGN AUTOMOBILE AND AUTO BOAT FIXTURES.

- Sept. 21-Oct. 1.—Coast Endurance Run, San Francisco. Los Angeles, Cal.
 Sept. 23.—Chateau-Thierry Race for Touring Cars. A. C. of France.
 Sept. 24.—Race Meet, Empire City Track, Yonkers, N. Y.
 Sept. 25.—International Motorcycle Race, France. A. C. of France.
 Sept. 30.—Gaillon Races for Speed Cars, France.
 Sept. 30-Oct. 1.—Race Meet, Brunots Island, Pittsburg. A. C. of Pittsburg.
 Sept. 30-Oct. 1.—Race Meet, Harlem Track, Chicago. Chicago A. C.
 Sept. 30-Oct. 1.—Race Meet, Rockford, Ill. Rockford A. C.
 Oct. 1.—Race Meet, Point Breeze, Philadelphia. A. C. of Philadelphia.
 Oct. 5.—Dourdan Kilometer Trials. *Monde Sportif*.
 Oct. 8.—Vanderbilt Cup Race, Long Island, N. Y.
 Oct. 14-22.—Leipzig Cycle and Motor Show, Germany.
 Oct. 23.—Chateau-Thierry Hill Climb France. *L'Auto*.
 Oct. 30.—Gaillon Hill Climb, France. *L'Auto*.
 Nov. 20.—100-Kilometer Trials. A. C. of Algeria.
 Dec. 9-25.—French Automobile Salon. Paris.
 Dec. 26-Jan. 2.—Reliability Trials. Motor Union of Western India.
 Jan. 11-24.—First Annual Importers' Automobile Salon, Herald Square Hall, New York.
 Jan. 14-21.—Fifth Annual Automobile Show, Madison Square Garden, New York. N. A. A. M., Madison Square Garden Co., and A. C. A.
 Jan. 14-24.—Fourth Annual Automobile Show at Brussels, Belgium.
 Jan. 27-Feb. 4.—Fourth Annual Automobile Show, Crystal Palace, London.
 Feb. 4-11.—Fifth Annual Automobile Exhibition, Chicago. Coliseum Building. N. A. A. M. and C. A. C.
 Feb. 4-19.—Automobile Exhibition at Berlin, Germany.
 Feb. 5-10.—Automobile Week, Nice, France.
 Feb. 10-18.—Automobile Exhibition, London, England. Society of Motor Manufacturers and Traders.
 Feb. 20-25.—Fourth Annual Exhibition at Detroit. Tri-State Automobile and Sporting Goods Association.
 Feb. 21-March 9.—National Motor Boat Show, Madison Square Garden, New York. Nat. Assn. Engine and Boat Mfrs.
 Feb. 27-March 4.—Cleveland Automobile Show. Cleveland Automobile Club.
 March 3-11.—Motorcycle Show, Liverpool, England.
 March 6-11.—Third Annual Buffalo Automobile Show, Convention Hall, Buffalo. Buffalo Automobile Trade Assn. and Buffalo A. C.
 March 13-18.—Fourth Annual Automobile Show, Boston. Boston Automobile Dealers' Assn.
 March 20-25.—Philadelphia Annual Automobile Show. A. C. of Philadelphia and Auto. Dealers' Assn. of Phila.
 March 27-April 5.—Fifth Annual Washington Automobile Show. Washington Auto. Dealers Assn.
 April 1.—Light Van Trials. A. C. of Great Britain.
 April 2-16.—Monaco Motor Boat Fortnight.
 June 26.—Mont Cenis Hill Climb

TAME SPORT AT ALBANY.

Dangerous Track and Numerous Withdrawals Cause Disappointment.

Special Correspondence.

ALBANY, Sept. 17.—At Island Park to-day the Albany Automobile Club endeavored to run off a card of twelve events as its first automobile race-meet. The card was too long and only about half of it was successfully worked off, the remaining events, by reason of several entries dropping out, being disposed of by letting the single contestants who were present take the prizes by running over the course.

The trotting track is not suited for auto racing, as the turns are too sharp and the track too narrow. Edward Hawley, who came to give an exhibition with E. R. Thomas's 60-horsepower Mercedes, said he would not attempt any record trials.

The young German, F. Kulick, running the Ford light, high-power racing car, did some pretty work in the ten-mile open, which he won; but the inexperience of the track officers in starting and running the handicap race for gasoline cars from 881 to 1,432 pounds, caused Mr. Ford, who was present, to withdraw Kulick and his machine from further racing, after a false start had put the young Detroit lad and his speedy car in jeopardy. He came down the track from a handicap start while the other contestants were being called back, and only by a quick swerve to one side prevented a disastrous collision.

Hawley, while preparing for his exhibition with the Mercedes, managed to puncture his right front tire, and in saving himself from the ditch at the turn, twisted his steering lever and burst a rear tire. Later he got the car out on the track and did a five-mile turn in 6:09 3-4, his fastest mile being set down at 1:09. Kulick's fastest, made in competition in the ten-mile open, was 1:10, which he made three times consecutively in the race.

"Eddie" Bald drove a stock Columbia car, without stripping, around the track for two miles in 3:07 3-5.

James Lucey made two miles in a White steamer in 5:21.

The track was not sprinkled and the dust was very thick in every race. Hawley was obliged to shut the power off entirely on each of the sharp turns when he ran his big Mercedes and only used power on the stretches.

With a little more experience and some expert to direct the arrangements and handicapping the meet would have been more successful. As it was, 1,200 to 1,500 persons witnessed it and there were about fifty motor vehicles about the track, in addition to those in the races.

The summaries follow:

Motorcycle race, three miles—Roy Robinson, Indian, 1st; Carl Robinson, De Dion, 2d; C. Matthews, Kelecon, 3d. Time, 8:27.

Ten-mile open, any horsepower—F. Kulick, Ford racer, 1st; C. Soules, Pope-Toledo, 2d. Time, 12:09.

Five-mile handicap for air-cooled cars—Thomas Hun's Franklin, driven by T. Lowe, handicap of two miles, 1st; W. F. Winchester, Franklin racer, 2d. No time taken.

Five-mile handicap for gasoline cars—A. S. Robinson, Buckmobile, one-mile handicap, 1st; J. Lucey, Jr., Cadillac (1 1-2 miles), 2d; Winchester, Franklin (1 1-2 miles), 3d. No time announced.

Five-mile handicap for heavy gasoline cars—C. Soules, Pope-Toledo, 1st; Savage, Peerless, 2d. Time, 6:21.

Club championship, five miles, members of Albany A. C.—James Lucey's Cadillac (two mile handicap), 1st; Frank Fiske, Jr.'s De Dion-Bouton (three miles), 2d; Jack Mallet's Peerless (scratch), 3d. No time announced.

Event 7—E. P. Burnham won by default, no other entries.

Event 10—James Lucey won by default.

Event 11—Roy Robinson won by default.

Event 12—Declared off.

ATTRACTIONS FOR CHICAGO RACES.

Special Correspondence.

CHICAGO, Sept. 19.—Great interest is being taken in the automobile race meet to be held at the Harlem race track September 30 and October 1 under the auspices of the Chicago Automobile Club. Carl Fisher, with the *Comet*, and H. H. Lytle, with the Pope-Toledo eight-cylinder car, have already been secured as attractions, and negotiations will probably be closed in a day or so with Barney Oldfield and Earl Kiser. The Franklin racer will be entered in several events, and Edgar Apperson will introduce a new Apperson racing car.

Among the local cars that will be entered are Jack Fry's Apperson, Sidney S. Gorman's Winton, W. R. Mason, Austin; C. A. Coey, Thomas; Frank X. Mudd's Cadillac; George A. Crane, Knox; M. K. Frank, Wolverine.

The complete list of events for the two days follows:

FIRST DAY.

Three miles, starting and stopping race, one passenger to be dropped at end of each mile.

Five miles; cars costing \$1,000 or less; regular equipment, except tonneau.

Ten miles, cars weighing 881 to 1,432 pounds.

Five miles, any motive power or weight.

Ten mile handicap.

Pursuit race.

Special match race, best two in three heats; first heat five miles.

SECOND DAY.

Gymkhana.

Second heat five mile special.

Five miles, Chicago A. C. members with touring cars carrying four persons, full equipment.

Five miles, cars weighing 1,432 to 2,204 pounds.

Ten miles, cars weighing 881 to 1,432 pounds.

Half mile slow race.

Third heat special match race.

Ten mile handicap.

PITTSBURG RACES POSTPONED.

Special Correspondence.

PITTSBURG, Sept. 19, 1904.—The automobile meet which was to have been held September 23 and 24 on Brunots Island has been postponed to September 30 and October 1. The affair will be altogether the most pretentious meet ever held around Pittsburgh. Dozens of well-known motorists from outside are expected and Pittsburghers will probably have the pleasure of seeing Earl Kiser and Barney Oldfield make some hairsplitting records at the track. Preliminary classification for the eight events to be held each day is now being made. Every precaution is being taken to make the contests perfectly fair, and the Automobile Club of Pittsburgh is arranging for the entertainment of the visitors. G. E. Turner is chairman of the race committee and E. J. Kent, M. J. Lewis and M. L. Dixon are his assistants.

J. C. McCoy, of Perth Amboy, has recently returned from Europe, where, with his wife, two sons and a daughter, he spent the summer touring through Switzerland, Austria, Italy, Belgium and England. Mr. McCoy used a 24-horsepower American built car and traveled about 5,000 miles.

REMARKABLE CALIFORNIA RUN

Continuous Day and Night Drive of 500 Miles in 53 Hours 40 Minutes.

Special Correspondence.

SAN FRANCISCO, Sept. 15.—One of the most severe tests ever given an automobile was completed to-day when W. R. Densmore and three companions arrived at City Hall after a continuous run of 53 hours 40 minutes from Los Angeles in a Packard four-cylinder 22-horsepower touring car. The run was made day and night, carrying four people the entire journey over 500 miles, including the crossing of five mountain passes and forty miles of a succession of steep grades close together, where the driving here was the most severe of the route. The time made sets a record between the two cities for a continuous run. In fact, no car has ever before been able to make the journey running day and night.

The men in the car were W. R. Densmore, of the Packard Motor Car Company,

15 inches deep, and have no stretches that can be compared with the first-class macadamized roads in the east. No extra parts were taken, except tires, inner tubes, spark plugs and battery equipment. The valves were ground the day before starting, new tires were put on and there was the general cleaning up that a careful chauffeur would give a car for an ordinary tour and no more. The brakes were left in the condition they were in after the general use to which the car had been put, with the result that at Los Olivos, after 12 1-2 hours' running, an attempt to tighten them resulted in putting the brakes out of commission for the rest of the journey and throwing the full work of checking the car on the grades upon the motor. This break, several bad battery and spark plug connections which had also been allowed to remain without renewal, and two tire punctures comprised the total list of trouble had with the car during the entire run.

The broken brake, however, came very near being the cause of a severe accident on the San Juan grade, a famous bugbear

lanche. Densmore, who was at the wheel, ditched the car against the bank on the upper side of the grade. Larzelere had his foot run over in the act.

The start of the run was made at 5.25 a.m. Tuesday, in Los Angeles, and an excellent run was made to Santa Barbara, over the Canejo pass. Harrison M. Zier, of Pasadena, in a Thomas, guided the party over the road to Santa Barbara.

The route taken was that planned for the endurance run of the Automobile Club of California, which, by the way, has been again postponed, this time on account of a session of the Sovereign Grand Lodge of Odd Fellows to be held here next week. Stops were made along the route only for meals, which amounted to mere lunches, and for gasoline, water and such minor repairs as were necessary. The men caught what little sleep they could in the tonneau while the car was moving. The strain upon the men, particularly upon the drivers, was very great. The night driving was naturally the more severe and became greater when it was found that the guiding was not to be depended upon. Densmore and Larzelere alternated at the wheel. Some of the mountain driving by Larzelere bordered on the remarkable. No attempt was made to figure actual running time, but with all the trouble at road finding, the time made is only a little more than three times as long as the running time of the Owl train between the same two points.

The times of arrival at the various points along the route, with the times of departures where stops were made, may be found in the table below.

POINT BREEZE MEET PROGRAM.

Special Correspondence.

PHILADELPHIA, Sept. 20.—The program for the automobile race meet at Point Breeze track on October 1 has been announced as follows:

Fifteen miles, for gasoline cars weighing 1,432 to 2,204 pounds; ten miles, for cars weighing 881 to 1,432 pounds; five miles, for cars weighing 551 to 881 pounds; five-mile handicap; fifteen miles, for 24-horsepower touring cars, carrying four passengers, weighing not less than an average of 140 pounds.

Arrangements are being looked after by H. D. Le Cato, secretary, 712 Girard Trust Building, Philadelphia.

The Deschutes Irrigation & Power Co. has awarded a contract for the construction of an eighty-mile automobile roadway between Shaniko and Bend, Oregon, and work upon it has already begun. The road will be sixteen feet wide, and is being built at a contract price averaging \$3,000 a mile. The road is for use by traction engines and persons who will drive through the company's tract of land by automobile and buggy to consider investment.



ARRIVAL AT SAN FRANCISCO OF W. R. DENSMORE AND PARTY IN PACKARD CAR.

Detroit; H. B. Larzelere, of the Pacific Motor Car Company, San Francisco, who assisted Densmore in driving; Wallace W. Everett, who acted as guide, and H. A. French, San Francisco, correspondent for THE AUTOMOBILE, who acted as observer. The distance traveled was much more than the 500 miles covered by the direct roads on the route between the two cities, owing to the fact that the guide lost his way frequently between San Miguel and Bradley; the car was run for more than five hours while looking for the right road, which is but fourteen miles in length. Nearly if not quite ten hours was spent in this way altogether.

The car, which came through carrying four men and full touring equipment without serious injury, had been in general use for weeks before the run and was taken only the day before the start and given such tuning as Densmore and Larzelere, neither of whom are trained mechanics, could give. The severity of the roads can be appreciated only by those who have travelled them. They include grades as high as 23 per cent., cover long stretches of sand and dust fully

for California touring automobilists. When near the steepest part of the grade, with a pitch on one side of hundreds of feet into a chasm, the clutch slipped in changing gear and the car started backward. With no brake to hold the car, disaster seemed imminent. Larzelere, Everett and French jumped and tried to check the machine, but might as well have tried to stop an ava-

	Arrived.		Departed.
Los Angeles	9:05 a.m.	Tues.	5:25 a.m. Tues.
Canejo Pass	10:25 "	"	
Ventura	1:25 p.m.	"	2:35 p.m. "
Santa Barbara	5:15 "	"	
Gaviota	6:55 "	"	9:35 " "
Los Olivos	1:00 a.m.	Wed.	1:35 a.m. Wed.
Santa Maria	5:10 "	"	
San Luis Obispo	8:09 "	"	9:10 " "
Paso Robles	2:20 p.m.	"	2:50 p.m. "
Bradley	5:30 "	"	6:30 " "
Jolon	10:25 "	"	11:25 " "
Soledad	12:58 a.m.	Thurs.	2:15 a.m. Thurs.
Salinas	7:48 "	"	8:45 " "
San Jose	11:05 "	"	
San Francisco			

CLOUDS GATHERING IN CLEVELAND.

Plan] of [a Newly Organized Dealers' Association to Secure Show Sanction May Cause Conflict with Former Promoters.—Mutual Interests the Object.

Special Correspondence.

CLEVELAND, Sept. 19.—There is likely to be a contest over who shall hold the local automobile show here next winter. For the past two years the shows have been conducted by George Collister, W. F. Sayle and others, under a partnership arrangement with the Cleveland Automobile Club, for the use of its name. Lately the leading automobile dealers have been discussing the possibilities of conducting the show themselves and the talk culminated in the formation last week of the Cleveland Automobile Dealers' Association.

The chief object of the association is to hold the show, but there are other benefits to be derived from working together. The dealers feel that because of the many agents now in the field the next show is likely to be a great success, and that since they make the show, practically speaking, the dealers themselves ought to participate in the profits.

The former managers, backed by the club, have already made application for a sanction from the N. A. A. M., but the dealers will take a similar step at once. Which will receive the sanction is a question. The dealers feel that they have a good cause and a strong pull, because of the fact that the national association has always given a sanction where there is a dealer's association in a city.

The profits realized from last year's show assisted materially in furnishing the club's rooms in the Hollenden Hotel.

The new dealers' association is officered as follows: Henry Chisholm, of the Chisholm & Phillips Automobile, president; George S. Waite, of the White Sewing Machine Co., secretary, and J. M. Belin, of the Automobile Garage and Repair Co., treasurer.

The meeting held last Thursday evening was merely a preliminary one for formulative purposes. The association will apply for a charter at once. About nine concerns were represented at the meeting and it is thought that practically all the dealers will join. No attempt will be made to raise or regulate prices on automobiles, repair work or parts, and the association does not intend to enter into race meet promotion. It is probable that it will be found advisable to formulate and adopt uniform prices on such matters as repairing tires, charging electric vehicles, cleaning cars, storage, rental, gasoline and lubricating oil, and perhaps on sundries. The question of credits may be given attention, as it is thought that much good could be accomplished if one dealer would give another information in cases where customers are poor pay. Attention will also be given to the matter of employees. It is very difficult to secure good help, and some of the dealers hire a man away from a competitor by offering more money as soon as the man becomes proficient. This will be discouraged. It will be one of the chief objects of the association to create a friendly feeling among the dealers, so that one may feel at liberty to call up another and inquire as to the habits and ability of an applicant for a position.

KANSAS CITY EXAMINERS APPOINTED.

Special Correspondence.

KANSAS CITY, Sept. 19.—John C. Caps and Louis Curtiss have accepted the places

on the board of examiners created by the passage of the new automobile ordinance. They, together with the superintendent of streets, are to examine prospective motorists as to their ability to handle a car before granting them a license for \$1 a year. Both the motorist members of the board are to serve without pay. A meeting will be held in a few days to formulate some plan for conducting the examinations.

Motorists generally censure both Curtiss and Caps for taking the places, as it is generally understood that the ordinance will be carried into the courts before licenses will be taken out. Mr. Caps is owner of a machine shop, and has built several automobiles. Curtiss is an architect and owns the big Walter racer which was shown at the Yonkers track last spring. He says he went at a one-minute clip with it on a straight stretch of macadam near here recently. There were no observers.

CONDITIONS IN MEMPHIS.

Less than 100 Cars Owned There Owing to Bad Roads—Better Prospects.

Special Correspondence.

MEMPHIS, Sept. 19.—Considering its population and wealth, Memphis is behind other cities in Tennessee in the matter of automobiling. Nashville, Chattanooga, and, probably, Knoxville, have more cars per capita than Memphis. Bad roads account in a measure for the scarcity of machines here. The city streets are, as a rule, well paved, but it is practically impossible to go thirty miles in any direction into the country without striking roads that are almost impassable.

While bad roads are given by local automobilists as the cause of the small number of machines here, the dealers tell another story. "We got the double cross," said one. "The manufacturers took our orders and then refused to deliver the machines. We could have sold twice as many machines if we had had them to sell."

Whatever the causes, Memphis at the present time has less than 100 cars—perhaps eighty-five or ninety. A year ago there were probably fifty-five or sixty. But next year the number ought nearly to be doubled. Preparations for a big year are being made quietly and there is little doubt that a large number of cars will be sold.

There is now only one concern in the city that sells automobiles. That is the J. P. Parker Co., which handles the Pope-Toledo and the Olds. Mr. Parker has a good-sized garage and a fully equipped repair shop. Next spring, however, the McDonald Automobile Company, which has been doing a repair business since May, will embark as regular dealers. It hopes to get the agency for the White car and for some good gasoline machine. Its garage is large, but already the floor space has proved inadequate and it is possible that a larger building will have to be secured.

The local speed regulations are very liberal and so far they have not been enforced. They allow a speed of ten miles an hour inside the old city limits, twelve miles inside the new city limits, and fifteen miles outside the city limits. A license number is required, but no license fee is charged.

Up to the present time no arrests have been made in Memphis for violating the ordinances, and no serious accidents have happened.

Local newspapers announce that a corporation, capitalized at \$100,000, is being organized here for the purpose of building automobiles. Herbert M. Pilcher, who is promoting it, states that the name of the

new company will be the Memphis Motor Vehicle Company, and that it will make steam vehicles.

TO DISCUSS SEARCHLIGHTS.

Special Correspondence.

PHILADELPHIA, Sept. 19.—The next meeting of the board of directors of the A. C. of Philadelphia promises to be a busy one, as the recent ruling of the Fairmont Park Commissioners regarding the use of searchlights on automobiles will be considered. Assistant Secretary Gundelfinger, discussing the new law, called attention to an accident that occurred on the Burlington Pike the day after the commissioners' decision was announced. A man in a wagon saw ahead what he supposed to be two bicycles. He kept the center of the road and tried to pass between them. The two women in the automobile tenderly gathered him up and took him to the nearest hospital. A searchlight would have made such an accident impossible. The commissioners have announced that they have no objection to searchlights as fixed side-lights. It is the pivoted article they have legislated against, they say.

NEWS NOTES OF THE CLUBS.

PUEBLO, COLO.—Plans have been perfected for the organization of an automobile club at Pueblo, Colo. There are about twenty machine owners in the city, all of whom, it is expected, will become members of the organization.

ALBANY.—The Albany A. C. has been incorporated with a capital of \$500. The following gentlemen were named in the articles of incorporation: W. E. Millbank, O. R. Quayle, of Albany, and T. B. Taylor, of Rensselaer, N. Y.

CHARLESTON, W. Va.—A movement is on foot to organize an automobile club among the local owners. A parade was held recently for the purpose of arousing interest, and another will be held in a short time. J. E. Skaggs and M. F. Mohler are the leading spirits in the effort to form the club.

HOUSTON, Tex.—At a recent meeting of local automobilists the Houston A. C. was formed and the following temporary officers elected: Dr. W. R. Eckhardt, chairman, and Miss Jennie Bering, secretary. Another meeting will be held at an early date, when a permanent organization will be effected and by-laws adopted.

PHILADELPHIA.—Some members of the A. C. of Philadelphia talk of promoting a "chrysanthemum parade" in early November, prizes to be awarded to the most beautifully decorated car. It is pointed out that some such affair as this, well advertised and run over the more prominent thoroughfares, will create a better impression than a run over country roads or a race meet held within an enclosure, in which events the general public—barring that comparatively small portion which is already sufficiently interested to attend race meets—cannot participate.

BUFFALO.—At a meeting of the Board of Governors of the Automobile Club of Buffalo, held last week, H. A. Meldrum and A. H. Knoll were appointed a committee to confer with the Buffalo Automobile Trade Association regarding the holding of an automobile show in the City Convention Hall, March 6 to 11, next year, the dates set by the American Automobile Association. The last show, under the combined auspices of the club and the association, was highly successful and stimulated local trade in automobiles. It is expected that the show next March will eclipse the last event.



A company called the Manhattan Transit Company has been formed in New York under a charter granted some years ago to the General Carriage Company, of New York, and it is stated by an officer of the new company that arrangements are being made to establish lines of automobile passenger vehicles in competition with trolley cars. Under the terms of the charter the company is permitted to run vehicles over the streets of any city in New York State, and may establish both time and distance services, provided the charge for the time service does not exceed 75 cents per hour for each passenger, or, for the mileage service 25 cents per mile or fraction thereof per passenger. The company may choose its own routes and may make such regulations and rules regarding fares as it may see fit, provided the maximum rates are not exceeded. No special permit shall be required, but the usual hack license fee shall be paid. Section 5 of the charter reads: "All acts or parts of acts inconsistent with this act are hereby repealed as to this corporation." It is stated by officers of the company that fares will be made as low as possible. Manhattan Island will be divided into three districts from the Battery to the Harlem River, the fare in each district to be three cents. There will be no transferring, a separate fare being charged in each district. An officer of the company made the statement that control had been obtained of one of the "Seeing New York" automobile lines, and that the others would be absorbed within a short time.

* * *

At a meeting of the Executive Committee of the National Association of Engine and Boat Manufacturers, held at the Hotel Manhattan, New York, on September 18, it was decided to hold a motor-boat exhibition in connection with the Sportsman's Show to be held at Madison Square Garden February 21 to March 9, 1905. The following officers and members were elected:

Committee on Legislation: J. N. Schoonmaker, chairman; A. Snyder, E. A. Riette, J. M. Truscott. Committee on Exhibition: Henry R. Sutphen, chairman; J. S. Bunting, A. Massenat, S. J. Matthews. Committee on Transportation: H. A. Lozier, Jr., chairman; J. S. Bunting, H. N. Whittelsey, J. B. Smalley. Committee on Agencies: The Executive Committee as a whole. The resignation of Hugh S. Gambel as associate member was accepted and Henry R. Thompson elected associate member in his stead. The following members were elected: Active, James Craig, Jr., W. L. Fay, representing Fay & Bowen Engine Co.; R. B. Clark, representing Giant Gas Engine Co.; Morris M. Whitaker, representing the Canada Launch Works. Associate, C. R. Mabley, representing Smith & Mabley, Inc.; Charles F. Splittdorf.

* * *

The deputy sheriffs of Suffolk county, Long Island, who have been spending the summer in the sport of automobile catching, stimulated by the reward of \$25 per automobile offered by the County Supervisors on June 15, are now going around with long faces. An injunction obtained from Supreme Court Judge Wilmot T. Smith, Riverhead, L. I., has the effect of restraining the Supervisors from paying the

bills of the energetic deputies, one of whom had an account of \$500. Sherman F. Wicks, the young man who suddenly became famous by firing bullets at an automobile, is on the list for \$25, the price of one capture. The total amount involved is about \$4,000. The Board of Supervisors has adjourned until October 11, and meantime the deputies are left wondering. The action was brought in the name of R. G. McNeil.

* * *

On September 19 papers were filed in four suits instituted by C. L. Charley, the general representative for France and America of the Daimler Manufacturing Company, builders of the famous Mercedes automobiles, against James L. Breese, Paul J. Rainey, George Baker and Mrs. Albert W. Scholle. The defendants, all of whom have imported Mercedes automobiles, are said to have purchased them through agents in Paris not licensed by the Canstatt Daimler company.

* * *

M. Charley has tied a very stout string on the \$10,000 offered by him as a prize for the first automobile boat to cross the Atlantic under its own power, by naming two conditions. One is that the start must be made from Havre and the voyage finished in New York. The other is that contestants must agree to rules yet to be drawn up by a committee yet to be appointed. He does not describe the kind of craft he has in mind when he speaks of an "automobile boat," and, in view of the lack of both rules and definition, it looks as if some of the many boats which, it is said, are being prepared for the trip might find themselves without the pale. Fifteen entries are reported to have been made already, among them being Henry Farman, Jean Salleron, M. A. Clement, M. E. Lamberjack and M. Lancia. Boats with 100 to 200-horsepower motors are being spoken of, the high-power idea seeming to have the center of the stage. Plans are already on foot for the organization of long distance preliminary races in which the entrants will have to qualify before starting on the actual trans-Atlantic voyage.

* * *

J. T. Bill and J. W. Leavitt, of the firm of Leavitt & Bill, San Francisco, are making a trip east to inspect automobiles, bicycles and motorcycles with a view to arranging for next season's lines. Address, on October 19 and 20, care of the Duck Brake Co., 335 Broadway, New York. On October 9 and 10, address care of C. K. Anderson, 154 Lake Street, Chicago.

* * *

A novel development of the speed launch or automobile boat is the *Dodger*, designed by Gardner & Cox and built for H. L. Pratt by Wood, at City Island, N. Y. She is a steel hulled craft 94 feet 4 inches over all and 90 feet on the water line, with turtle-backs fore and aft. Her two gasoline motors are rated at 250 horsepower each, and it is said that a speed of 23 miles an hour has been guaranteed. The fuel tanks have a capacity of 1,000 gallons. Owing to the comparatively large size of the boat there is room under the turtle-backs for comfortable quarters for the owner and crew.

An automobile race meet will be held at Brighton Beach track, New York, on Saturday, October 22, two weeks after the Vanderbilt Cup Race, and an endeavor will be made to arrange for the entry of some of the machines that competed in the big road event. The meet is being promoted by the Brighton Beach Automobile Club, with Alfred Reeves as manager, which is an assurance of success. Entry blanks may be obtained from the manager at 140 Nassau Street, New York.

* * *

A chauffeur who evidently reads the daily papers was arrested in The Bronx, New York City, for exceeding the speed limit, and when Magistrate Crane commenced lecturing him on the seriousness of his offense, made the statement that he was not to blame, as he had simply obeyed the instructions of his employer. The chauffeur was released on bail furnished by his employer, and the magistrate told the policeman who had made the arrest that any owners who were found ordering their chauffeurs to drive faster than the law allows would be held for trial.

* * *

The home office of the Continental Caoutchouc Company, Hanover, Germany, has authorized the New York agency for the Continental tires to offer the following prizes for cars fitted with their tires competing in the Vanderbilt Cup race: To the winner of the race, \$1,000; second place, \$500; third, \$250; fourth, \$100. A stock of tires of the latest types has been shipped for the race, and tire stations will be established on the course.

* * *

Automobiles will be placed in the Brooklyn police service on Sunday, September 25, when, according to the statement of Deputy Police Commissioner T. F. Farrell, four cars will be sent out in charge of officers in plain clothes to patrol the boulevards and stop automobile scorching.

* * *

In order that there may be no repetition of the Gettysburg Tour failure of last spring, the Automobile Club of America has sent notices concerning the proposed fall tour to members with a view to ascertaining how many will participate in the run. The replies received so far indicate that a successful run will be held. Monday, October 10, is the date proposed for the start, and the route is laid out for a five days' trip.

* * *

Frank E. Tyson, the Lawrence, L. I., police justice who imposed a \$50 fine on Lewis B. Sharpe, an automobilist, of Rockaway, for speeding in his automobile, has been re-appointed by the village board. Mr. Sharpe submitted to Attorney General Cuneen that Mr. Tyson was not eligible for the position of Justice, and sought to have him deposed; but the re-appointment was, it seems, perfectly regular, and Mr. Sharpe's complaint was therefore dismissed.

* * *

The F. J. Willis Company, Park Place, New York, has arranged to carry a line of automobile and motor-boat clothing, and a catalogue of these goods is now in preparation.



An agency for the American De Dietrich Motor Car Company has been established in Chicago.

An exhibition of automobiles will be one of the attractions at the nineteenth annual fair at Brattleboro, Vt., on September 28 and 29.

The Automobile Club of Philadelphia is now preparing for distribution among its members road maps of Pennsylvania and New Jersey.

George C. Souther, of 75 Columbus avenue, Boston, has been made treasurer of the Boston Automobile Garage Co., recently organized with a capital of \$250,000.

The White Sewing Machine Co., of Cleveland, is increasing its facilities with a view of turning out 1,000 cars the coming season. This year's output was about 650.

We are informed by the United States agency for the Michelin Tire Company that Michelin tires were awarded the Grand Prize for tires at the St. Louis Exposition.

The date of the beginning of the speed trials to be held at Ormond, Fla., has been changed from November 7 to November 14, the former date being that of the national election.

The Moline Automobile Co., of East Moline, Ill., has let a contract for the construction of a two-story brick factory building, 60 by 30 feet, which it expects to occupy by November 15.

E. H. Corson, a Springfield, Mass., motorcyclist, has completed a tour of New York State and Connecticut, not once being compelled to use a railroad train. He is now touring in Maine.

An office has been opened at 242 North Broad street, Philadelphia, by the Rambler Automobile Company. Rambler cars were formerly represented in Philadelphia by A. G. Powell and later by John Wells.

The Danbury, Conn., Fair, which opens October 3 and continues for a week, will hold a series of automobile races on the second and third days of the fair, for which cash prizes and silver trophies are offered.

Paul DeWitt, formerly a well-known cyclist of Atlanta, Ga., but now agent for Winton cars at Havana, Cuba, reports the sale of five Quads. There are now about seventy-five machines in use in Havana, the touring car predominating.

Bids for furnishing an automobile for the use of Fire Commissioner Doyle, of Brooklyn and Queens, have been approved by Corporation Counsel Delany, and an early delivery of the machine is expected.

The Fourth Annual Automobile Show will be held in the Crystal Palace, London, from January 27 to February 4 next. Information as to rules and regulations may be had by addressing Frederic W. Bailey, Secretary and Manager, Automobile Show, Sydenham, London.

The Reverend F. A. Kahler, pastor of the Holy Trinity Lutheran Church, of Buffalo, is the first clergyman in Buffalo to acquire an automobile. He has a large parish and his congregation is steadily increasing. His congregation, appreciating his efforts to visit his parishioners day after day, and seeing with what interest he performed

his ecclesiastical duties, seven of the leading members of the church visited their pastor a few days ago and presented him with a brand new automobile.

W. J. Morgan visited Bretton Woods, N. H., during the first of this week to perfect plans for the banquet to be given on October 1, and also for the Mount Washington tour mentioned in our issue of September 17.

After October 1 the Autocar, manufactured at Ardmore, Pa., will be represented in Philadelphia by the Keystone Automobile Company. Banker Brothers have handled the Autocar in the Quaker City for the past eighteen months.

Harry D. Weed, manufacturer of Weed's Chain Tire Grip, reports that the growth of business has necessitated working his shop overtime, as a result of which he has decided to remove, in the course of a very short time, to new and larger quarters.

G. H. Curtiss, builder of the Hercules motorcycles, is now constructing a plant on his residence property at Hammondspoint, N. Y., which will give him increased facilities for the manufacture of the machines. The new quarters will be ready for occupancy in about thirty days.

The Northwestern Mfg. Co., recently incorporated at Milwaukee with a capital of \$60,000, has purchased the plant of the Browning Mfg. Co., on Clinton and Madison streets, where it will continue the manufacture of motors, dynamos and small machinery.

The first machine of the Mahoning Motor Car Co., of Youngstown, O., has recently undergone a successful trying out. The car is an air-cooled 24-horse power tonneau. The company is also building cars of the runabout type, the first of which will be ready for trial in a few weeks.

Charles J. Glidden, accompanied by his wife and chauffeur and an official of the Canadian Pacific Railway Co., arrived at Vancouver, B. C., last Sunday, having completed the trip from Minneapolis—a distance of about 2,000 miles—in his Napier car entirely on the rails of the steam road.

The Warner Gear Company, of Muncie, Ind., has completed a new factory and equipped it with the most modern machinery, driven by electric motors, capable of turning out 100 gears a day. Contracts have been made with a number of leading manufacturers to supply gears for 1905 cars.

The Auto Repair Company, Ltd., of Pittsburg, with a capital of \$5,000, was incorporated last week at Dover, Delaware. The company expects shortly to open a fine garage in Pittsburg, and in addition to buying and selling automobiles, will do a general repair business. The incorporators are Rex Rementon, of Pittsburg; Jefferson D. Thompson, of Crafton, Pa., and Truman W. Campbell, Wellington, Pa.

The National Motor Vehicle Co., Indianapolis, Ind., reports that the demand for National gasoline cars has been so great that only recently has it been found possible to send a sample car to the St. Louis Exhibition. Assistant Sales Manager George M. Dickson and Albert Fehling, the Buenos Ayres representative of the National company, will have charge of the exhibit of

National cars for a few weeks; Henry J. Hicks, who has hitherto been at St. Louis, will resume his road duties. The Eastern representative of the National company is now C. H. Tyler.

An automobile livery has been established in Greenfield, Ind., by C. E. Kinder and George Hacker.

The Laurel Line Railway Company, of Scranton, Pa., is now operating an electric passenger bus between its stations and other stations and hotels in the city, charging a small fee for the service.

Charles F. Weber and J. W. Wakem, of Chicago, who went abroad last May for a few months' automobiling in England, Scotland and France, have returned home. A 24-horsepower Pope-Toledo car was used on the trip, covering in all about 9,000 miles.

J. C. Clark, a prominent club and business man, of Atlanta, Ga., was recently fined \$1 and costs by the city recorder for having left his automobile out in the streets overnight in front of a building on Peachtree street. This is the second case recently tried under Atlanta's new automobile ordinance.

A new garage and machine shop has been opened by the Custer Electric Mfg. Co., 315 West Second street, Marion, Ind., where automobiles may be stored and repaired. The machine shop is two stories in height, 30 feet wide by 60 feet long, and so equipped that repair or renewal work of any character can be done.

The greatest moneymakers at the county fair at Independence, Mo., ten miles from Kansas City, are three automobiles that take visitors on a trip of several blocks for a fare of ten cents each. Attendance at the fair has been large and the farmers all want to take a ride. While the fare is low, the ride is short. Kansas City men have the concession.

The Cataract Machine & Automobile Co., recently incorporated at Niagara Falls, N. Y., with a capital of \$5,000, will immediately begin business in the plant formerly occupied by the Central Machine Co., under the management of the following officers: S. P. Fanchott, president; Fred V. Simpson, vice-president; H. W. Kellogg, secretary, and Max Amberg, treasurer.

Mr. and Mrs. C. E. Wilkins, B. C. Russell and Louis B. Bostwick, of Omaha, Neb., recently completed a three-months' automobile tour. They traveled more than 8,000 miles, visiting Kansas City, St. Louis, Chicago, Cincinnati, Cleveland, Buffalo, New York and Portland, Me. They met with no serious accidents, and at the end of the journey the machine is reported to be in excellent condition.

The Packard Motor Car Company, Detroit, Mich., has completed and issued its record of the 1,000 miles non-stop run made on a track by one of their cars recently, as already noted in these pages. In addition to the tabulated figures concerning the performance of the machine, the book contains a number of fine photographs of the car, a photograph of the racer *Gray Wolf*, which is entered for the Vanderbilt Cup race, and fac-similes of the declarations of the judges, timekeepers, scorers, drivers and mechanics who were connected with the run.

THE AUTOMOBILE

WEEKLY

NEW YORK—SATURDAY, OCTOBER 1, 1904—CHICAGO

10 CENTS

AUTO-BOAT CHALLENGE CUP RACES.

THE first auto-boat season in American waters ended last Saturday when the gold challenge cup of the American Power Boat Association was won by *Vingt-et-Un II.* after three days of hard racing. That it was won on merit goes without saying, as the conditions were such as to test seaworthiness and endurance as well as speed.

The first race for the cup, held last June, was won by the *Standard*, of the Columbia Yacht Club; and when a challenge was recently tendered by the Manhasset Bay Yacht Club in behalf of H. A. Lozier for the *Shooting Star*, it was promptly accepted by the Columbia Yacht Club, the requirement of six months' notice being waived. As soon as the match was announced other competitors appeared, ten starters finally crossing the line in the first race.

The match was managed by a special committee of three—F. A. Hill, of the Manhasset Bay Y. C.; F. J. Stone, Columbia Y. C., and H. de B. Parsons, American Y. C. The launches were measured by J. H. McIntosh, of the Columbia Y. C. The course was from off the Columbia Yacht Club station, 86th street and North river, up the Hudson sixteen nautical miles, and return—thirty-two nautical miles in all. It was decided to start the launches on their time allowance, so that the first boat in would be the winner. This plan answered admirably, and although it was somewhat tedious to wait

for nearly half an hour between the starts of the second and third boats, it was, on the whole, far more interesting than similar waits at the finish and the resulting uncertainty as to the winner.

The start was set for 2 o'clock, but a postponement was ordered until an hour later.

There was a light wind down the river, with the ebb tide, making the water quite smooth. The air was cool for September, but otherwise the weather was favorable

for competitors and spectators, there being many of the latter about the clubhouse. There was some delay in securing a markboat for the turn, this matter being left until the last minute, but finally the cruising launch *Melissa* was sent away with instructions to proceed up the river to a point sixteen miles distant and anchor.

derbilt's *Mercedes VI.* also crossed the line at good speed, and Mr. Tangeman made one of his usual good starts in the *Macaroni*. Bowden's *Mercedes U. S. A.* was slow in getting away, with a standing start, but she soon gathered way and went after the famous old veteran, *Mary Powell*, bound up river just ahead of her; in a very short time she had taken the lead of the old boat. The *Speedway* crossed with a running start, but *Vingt-et-Un II.* made practically a standing start. The *Challenger*, steered by Proctor Smith, went over the line, but it was understood that something was wrong with her and she would not attempt to cover the course.

There was a wait of nearly fifteen minutes after the last start before a dash of spray far up the river told that one of the boats was returning in phenomenal time if she had made the course. The Vanderbilt launch was finally recognized, and crossed the line at 4:54:35 p.m. Mr. Vanderbilt reported that he had actually run some distance past the markboat before discovering her, and returned and rounded her. His elapsed time was only 1:21:30, and very little figuring was necessary to show that this meant a speed of 23.5 knots. Nine minutes later came the *Macaroni*; then almost in a bunch the *Speedway*, the Bowden *Mercedes* and *Vingt-et-Un II.*

The wonderful speed of the boats was the one topic of discussion for a time until the word went round that the markboat had failed to reach the proper point in time, and had anchored about a mile short of it on seeing the launches near to her and ready to turn. The times were calculated anew on this basis and given out as official,



William K. Vanderbilt, Jr., in "Mercedes VI" with Robert Jacobs, its builder, at the A. P. B. A. Challenge Cup Races. Mr. Vanderbilt's generosity has made possible the first great American Automobile Road Race, to be held on Long Island, October 8.

The *Josephine*, an open launch of ordinary construction, crossed the line about seventeen seconds after her gun at 3:05 p.m., and two minutes later came *Marcirene II.*, a staunch and able launch with canopy top in place.

There was then a long wait for the speed boats, the first being the *Flip*, which went over the line slowly a little after the gun. The *Shooting Star* made a standing start, getting away promptly and quickly. Van-

and it was not until they had been published the next day that it was discovered that the *Melissa* had anchored at some indefinite point up the river, said to be between thirteen and fourteen miles from the start.

The starters were as follows:—

	Power.	Length on Water Line.		Rating.
		Ft.	In.	
<i>Speedway</i> , C. L. Seabury	64.45	39	03	72.84
<i>Mercedes</i> , H. L. Bowden	42.20	31	11	72.30
<i>Challenger</i> , Smith & Mabley	10.44	30	07	88.35
<i>Vingt-et-Un II</i> , W. S. Kilmer	59.72	38	10	79.35
<i>Macaroni</i> , C. H. Tangeman	40.38	31	11	68.10
<i>Josephine</i> , A. J. Buschmann	19.08	29	11	53.40
<i>Mercedes VI</i> , W. K. Vanderbilt, Jr.	39.52	30	00	65.70
<i>Shooting Star</i> , H. A. Lozier, Jr.	24.07	37	80	65.55
<i>Flip</i> , C. D. Holmes	38.09	34	20	65.01
<i>Marcirene II</i> , J. W. Allison	34.40	34	50	54.25

Following is the result of the day's race:

RESULTS FIRST DAY.

	Start.	Finish.	Elapsed Time	Points.
<i>Josephine</i>	3:05	5:25:25	2:20:25	3
<i>Marcirene II</i>	3:07	5:31:27	2:24:27	2
<i>Flip</i>	3:32	5:10:20	1:47:20	4
<i>Shooting Star</i>	3:32:48	5:13:07	1:40:10	5
<i>Mercedes VI</i>	3:33:05	4:54:35	1:21:30	10
<i>Macaroni</i>	3:37:22	5:05:43	1:28:21	9
<i>Mercedes U. S. A.</i>	3:44:12	5:08:54	1:24:42	7
<i>Speedway</i>	3:44:57	5:07:10	1:22:13	8
<i>Vingt-et-Un II</i>	3:54:00	5:00:54	1:15:54	6
<i>Challenger</i>	4:04:17	withdrew

"VINGT-ET-UN" WINS ON FRIDAY.

There was a stiff southeast wind up the river Friday, with the ebb running strong against it throughout the race. The water was rough at all points, and in the more exposed portions it was unfit for the average auto-boat with low freeboard and open cockpit with flimsy hatches. The *Challenger* was not present and the *Josephine* fouled a mooring just before the start and lost her screw. The others were sent away in the same order of time as on the preceding day. This time the course was stated to be the full thirty-two miles. The up-run was made with no serious difficulty, *Mercedes VI*, holding the lead to the turn, but on the way home she came to grief, being compelled to withdraw after stopping several times to bail out. *Shooting Star* and *Speedway* were also well filled with water, and were compelled to stop and bail. *Vingt-et-Un II* came through in good shape, winning easily and making a speed of 22.05 knots, if the course is correct. The official times were:—

RESULTS SECOND DAY.

	Start.	Finish.	Elapsed Time	Points.
<i>Marcirene II</i>	2:07:22	4:50:20	2:51:58	6
<i>Flip</i>	2:12:00	4:47:50	2:35:50	7
<i>Shooting Star</i>	2:32:48	Did not finish.
<i>Mercedes VI</i>	2:33:03	Did not finish.
<i>Macaroni</i>	2:37:22	Did not finish.
<i>Mercedes U. S. A.</i>	2:44:12	4:50:20	2:15:17	5
<i>Speedway</i>	2:44:57	5:14:38	2:29:41	4
<i>Vingt-et-Un II</i>	2:54:00	4:21:03	1:27:03	8

"VINGT-ET-UN" WINS AGAIN.

On Saturday, although the weather was clear and warm, the sea and wind were still worse, combing up the ebb tide in a way that was hardly reassuring to the crews, even off the club float; with the certainty of something much worse in the stormy waters of the Tappan Zee. The start was made at 3 o'clock, in the regular order, the entire ten starting. The *Josephine* went off promptly from a standing start, and *Marcirene II* made a very good start. The *Flip* went off on time, but the

Shooting Star, after a smart start, lay down just beyond the line; after some minutes she was started, ran a short distance, then gave up. The *Vanderbilt Mercedes U. S. A.* and the *Speedway* were both late over the line. The *Challenger* started and ran up the river until lost to view.

The *Vingt-et-Un II* was the first to return, coming down the river at speed in a smother of white water, running smoothly and easily with her stem cutting the waves, in excellent trim. Her time was 1:30:24, which for a course of thirty-two miles would be 21.24 knots. The *Speedway* came next, moving fast and riding the rough water well, but showing about five feet of bow clear of the water. She brought the alarming news that the *Macaroni* was afire near Dobbs Ferry. This was confirmed by *Mercedes U. S. A.*, Mr. Bowden having run back to give assistance, but other launches and boats were near at hand. The *Macaroni* was badly burned, but her crew were taken off safely. The other auto-boats to finish were the *Flip*, *Marcirene II*, and *Josephine*, the latter not timed. The *Mercedes VI* broke down off 151st street and was towed in; *Challenger* did not return to the clubhouse.

The official times were:—

RESULTS THIRD DAY.

	Start.	Finish.	Elapsed Time	Points.
<i>Josephine</i>	2:35:00	Withdrew.
<i>Marcirene II</i>	2:37:22	5:34:17	2:56:55	6
<i>Flip</i>	3:02:00	5:14:26	2:12:26	7
<i>Shooting Star</i>	3:02:45	Withdrew.
<i>Mercedes VI</i>	3:03:05	Withdrew.
<i>Macaroni</i>	3:07:22	Burned.
<i>Mercedes U. S. A.</i>	3:14:12	5:00:15	1:55:03	8
<i>Speedway</i>	3:14:57	5:00:34	1:45:37	9
<i>Vingt-et-Un II</i>	3:24:00	4:54:24	1:30:24	10
<i>Challenger</i>	3:34:17	Withdrew.

Report of Small Car Trials.

Special Correspondence.

LIVERPOOL, Sept. 16.—The judges issued on September 15 a comprehensive report of the Hereford small car trials. The provisional awards mentioned in my report of the trials last week were confirmed and further awards of medals were made.

Gold medals were awarded to the Wolseley Motor Car Co. for excellence of design, construction and workmanship of its cars, Nos. 10 and 20; also to the Siddeley Auto-car Co. for the general merit of its 6-horse-

power car. The Siddeley car is, as a matter of fact, made by the Wolseley company. Another gold medal was awarded to the Swift Motor Co. Awards of three silver and six bronze medals were also made.

The following information, gathered from the judges' report, may be of interest:

Out of thirty-eight entries, thirty-five competitors started, and twenty-six of these completed the 600 miles. One of the most frequent causes of stoppage was defective junctions in pipe work; the use of short rubber connections for water pipes and of brass flanges on exhaust piping caused much trouble.

Great improvement was noted in the design and construction of steering gear, although in most cases sufficient protection from dust and mud was not afforded.

The number of stoppages caused by defects in inlet valves showed the need of attention to the proper design of the cotters and fittings at the end of the stem.

The construction of clutches as regards adjustment and end thrust showed considerable improvement, as also did the electric wiring and terminals on the majority of the cars.

The consumption of petrol (gasoline) throughout the trials was carefully noted, and the amount used varied considerably. The 7-horsepower Clyde averaged more than 47 miles to the gallon—a remarkable performance working out to .033 gallons per ton-mile. The Swift, Siddeley and 6 1-2-horsepower Humber all averaged 38 miles to the gallon. The average consumption of all the cars was 25 to 28 miles to the gallon.

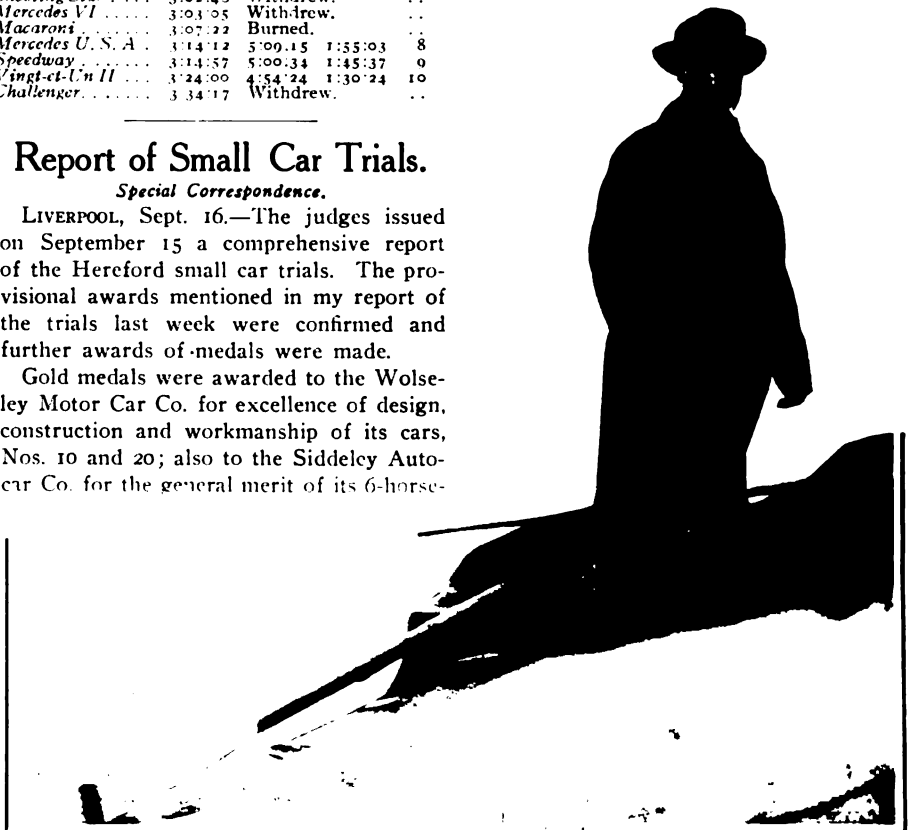

H. L. BOWDEN IN A CHARACTERISTIC ATTITUDE IN HIS AUTO-BOAT MERCEDES, U. S. A.

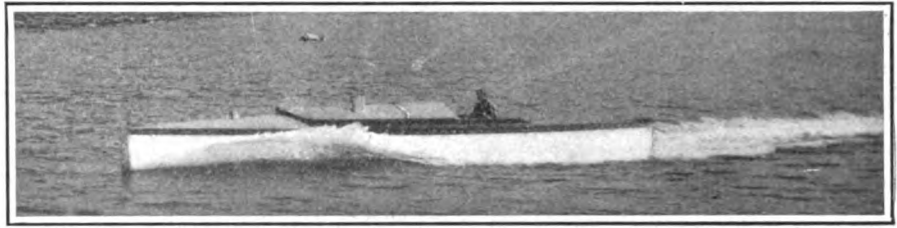

AUTO-BOAT VINGT-ET-UN, WINNER IN THE A. P. B. A. RACES ON THE HUDSON.

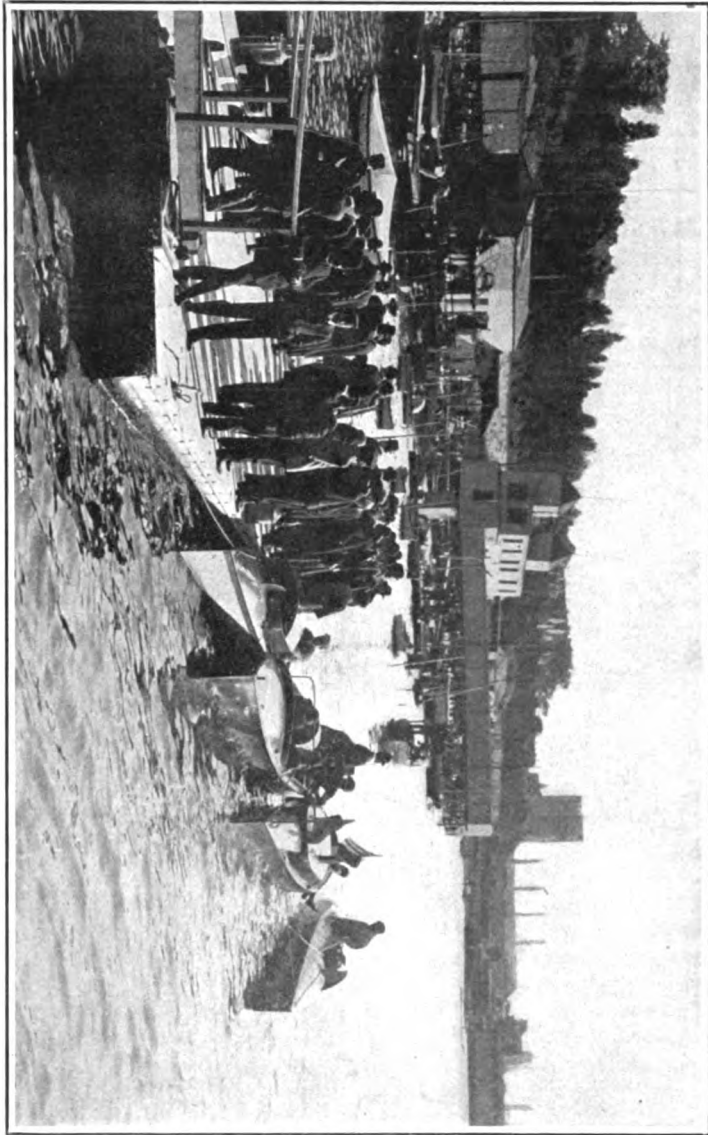

AUTO-BOATS ALONGSIDE THE FLOAT OF THE COLUMBIA YACHT CLUB DURING THE RACES LAST WEEK



H. L. BOWDEN'S AUTO-BOAT MERCEDES, U. S. A., GOING AT SPEED.

WILLIAM K. VANDERBILT, JR., STANDING ABOARD THE MOTOR IN HIS NEW AUTO-BOAT MERCEDES VI, IN THE RACE FOR THE A. P. B. A. CHALLENGE CUP ON THE HUDSON RIVER.

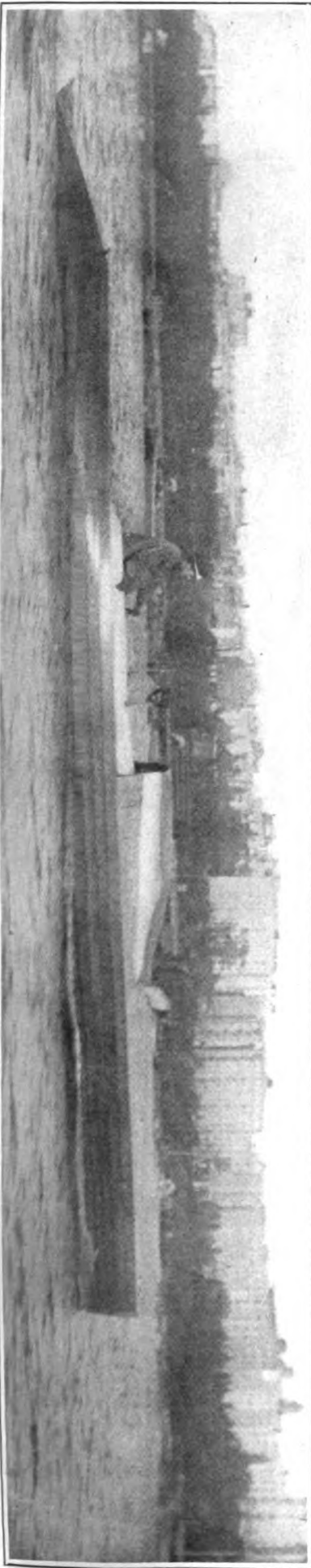

Tables were also given showing the order of merit as regards noise, ease of manipulation, comfort of passengers and vibration.

An interesting calculation was made of the horsepower developed by the various cars on the three test hills. The horsepowers at the driving wheels, as shown by the best performance on the three hills, averaged 4.75 horsepower for the cars rated at 6 horsepower.

The judges concluded by stating that they considered a distance of 600 miles insufficient to bring out the qualities of the minor details of the cars, and recommended that future trials should take place over a longer course.

Wants Gordon Bennett Changes

The Marquis De Dion is said to have suggested several changes in the conditions for the French Gordon Bennett eliminating trials and, if possible, for the race itself. He would have the distance increased to 1,000 kilometres (621 miles), make the race a two-days event and permit changing drivers when necessary.

The Automobile Club of France has repudiated the statement, which emanated from Berlin, that it applied to the Prussian government for permission to run next year's race on the Homburg course. The French Ardennes, where They won his preliminary victory, is likely to be again selected for both the trials and the race itself. If any German trials are held they will take place over the Schleswig-Holstein route which was chosen for the May trials, but was not used owing to the nomination of the Mercedes cars without competitive trial and the withdrawal of all the other German cars except the Opel-Darracq.

A good story is told by our Irish contemporary, *Motor News*, of the troubles of a French chauffeur in Ireland. It seems that the chauffeur was hired by a Cork automobilist, who gave his new man to understand that if he was once fined for illegal speeding he would be discharged. Much perturbed, the chauffeur hied him to the police barracks, where he explained the situation to the chief of police, and propounded the conundrum, "How fast can I drive?" And the chief, being a soft-hearted Irishman, thought the matter over and replied, "Faith, then, ye may dhrive as fast as ye like." Beaming with delight, the Frenchman thanked the chief profusely, and was about to depart, when the latter added, "Sure, now, but ye must be careful not to drive *too* fast." And now the poor chauffeur doesn't know where he's at.

General Booth, who recently concluded an automobile tour of England from Land's End to Aberdeen, in a farewell address to his "comrades and friends," concludes with "Yours, at motor speed for the Kingdom."

Physician's Experience With a Runabout.—II*

By HARRY W. FREEBERG, M.D.

BY this time I had fallen quite in love with my light runabout, both for its convenience in my profession and because of the pleasure that was derived from it. Having become familiar with its operation, I determined to take a short tour through northern Indiana, southern Michigan, across Lake Michigan to Chicago and north to Evanston, Ill., my old college town.

EXTRA WATER TANK FITTED:

Before starting, I had a tinsmith make a long, cylindrical water tank seven inches in diameter and having a capacity of six and a fraction gallons. This tank was placed just back of the seat and above the regular tank, to the top of which it was connected by a rubber hose. It acted simply as an extra supply tank, as it did not absorb any of the heat from the tank below because the water did not circulate through it. With this valuable aid to the cooling apparatus, I ran the first 200 miles of the jour-

wrong one, but when the mistake was discovered we drove on to where a road turned to the right and crossed over to the road we should have taken. The cross road was six miles long and it was an "awful" road—dirt and sand and full of stumps and hills. A farmer whom we stopped to ask about the road looked bewildered and a little frightened, the reason for which we could not understand until he told us that he had never seen one of "these yer things" before. The directions he gave only put us more in the dark.

After many trials and tribulations, we reached the right fork and were not long thereafter in arriving at Rochester, Ind., where we ate dinner, rested for half an hour, oiled up the engine and poured two gallons of gasoline into the tank. Leaving Rochester at 2.45 p. m., we took a north-easterly direction, passing through Mentone and Palestine, Ind.; but between these two places we again lost the road and had to go back. The road from Rochester to Mentone was sandy and very difficult to traverse with an automobile.

We arrived at Warsaw about 5 o'clock. The day being Sunday, the gates of Winona were not opened until 6 p. m., so we cleaned up and had supper and then went out to the lake, which is only two miles from town. After engaging a room at the hotel, we proceeded to look up friends, with whom we spent the next three days playing golf, tennis and boating.

PUNCTURE REPAIRED WITH RUBBER BANDS.

A tire was found nearly flat when the runabout was inspected on the day before we resumed our journey. This seemed a rather serious matter, as I had taken along no extra tire nor even a repair outfit, having merely filled each tire with a half-pound of anti-leak compound. So I had arrived at a time when I had to rely upon my own resources, and accordingly decided to try the expedient of inserting some small rubber bands in the puncture and giving the anti-leak a better chance to do its work. A darning needle and some rubber bands were purchased at a small notion store. The head of the needle was then cut off at about the center of the eye, and with the forked portion of the needle several bands were pushed through the puncture, which had been made by a long tack. The tire was then wrapped with some tape which an electric line man gave us, and with these repairs I had a tire that ran the rest of the tour without giving the least trouble.

HELD UP BY A CLOUDBURST.

We left Warsaw the following morning at 5.25 o'clock and ran north to Goshen and westward through Elkhart, South Bend and to Buchanan, Mich., a distance of eighty-one miles, over which we made a fast run of four hours and fifteen minutes. From



MAP OF DR. FREEBERG'S ROUTE.

ney with the initial filling of water. As steam and air accumulated in the lower tank, it was necessary to run a quarter-inch exhaust pipe from the top of the lower tank to the top of the upper one.

It was not hard to find company for this trip. A young acquaintance was enthusiastically eager to go. Preparations to start were made on the second day of August. The start was delayed two hours, however, by an early morning shower; but at 7 a. m. we were off, with fair roads and a bright day in prospect. We had written to some friends at Logansport that we would arrive there at 10.30 a. m., and, remembering this, we tried to make up time, and arrived at Logansport, fifty-five miles, at 10.25 o'clock.

TOOK THE WRONG ROAD TWICE.

After stopping for three-quarters of an hour, we resumed the journey northward. There were two roads leading out at different angles and of course we took the

*Continued from page 285, issue of September 10.

Warsaw to Goshen, a distance of twenty-seven miles, which we covered in one hour and thirty-five minutes, the roads were fine. A terrific storm of wind, hail and rain obliged us to pull into a barn before reaching Elkhart, and upon resuming the trip about half an hour later we found the road full of water; but this was not all: trees were blown across the road, and in one place a barn had been overturned and was lying on its roof almost in the middle of the highway. Entering Elkhart, we were obliged to run in the car track, as the mud was next to impassable. But after passing through the city we were nearly out of the path of the tornado and the roads began to be good again, and upon reaching South Bend we had very fine traveling.

We stopped at that beautiful little city long enough to clean our commutator brush and chain and to have a little talk with some of the automobile dealers. One with whom we fell into conversation had come from New York in a steam carriage and he claimed to be well satisfied to make from eight to twelve miles an hour.

After refilling the tank with gasoline and taking explicit instructions from half a dozen willing tutors, we started for St. Joseph, Mich., on the east shore of Lake Michigan. At Buchanan, where we arrived at 1 p. m., the cyclometer registered 209 miles, while at Warsaw it had stood at 128, making a distance of 81 miles covered in four hours fifteen minutes of actual running time. At Buchanan, where we had dinner, we refilled the water tanks for the first time since leaving home, making approximately 200 miles on one filling.

HARD TRAVELING OVER SAND HILLS.

The proposition now ahead of us, from Buchanan to St. Joseph, was a hard one, the roads being fearfully hilly and deep with loose sand nearly all of the way. It was 2 o'clock when we started on the twenty-seven-mile run over a road concerning which no one could give us much encouragement. Three hours were consumed in traversing the distance, but we were glad to get to St. Jo at all. On two occasions my friend had to get out and walk up a sand hill, but never did he push. Another time we lost our way but did not go far on the wrong road that time. At the top of every hill I threw in the high speed but had to release it at the bottom for a mud hole, and then run on the low speed all the way up the next sand hill. The motor came to an abrupt stop at the bottom of one of the hills and several attempts to start it were unsuccessful. Raising the cover over the back of the body, we found the wire disconnected from the spark plug, which was not a serious difficulty to remedy.

Just as we were pulling into Benton Harbor we ascended a tremendous hill with only one track to follow, and that of sand. The motor must have made less than 100 explosions per minute and I felt that I would have to give it up and be pulled the rest of the way up by natural horse power,

but to my delight the engine did not fail. Few motorists were seen in Benton Harbor, and there was no difficulty in understanding the reason why. From this place we ran directly to St. Joseph, two miles, where we put up for the night and took in the carnival which was being held there at the time.

Friday morning at 7 o'clock we left by boat for Chicago. Our tickets were 75 cents each, while the charge for the automobile was \$5. The rates of \$8 for touring cars and \$5 for runabouts impressed us as being disproportionately high.

(To be continued.)

Lake Lucerne Auto-Boat Race.

Special Correspondence.

PARIS, Sept. 14.—Auto-boat racing was never held in such a magnificent setting as the first annual regatta at Lucerne, Switzerland, on the Lake of the Four Cantons, last Saturday and Monday. The scenery was magnificent beyond comparison, and as the

(Daimler), 6:26:55; *Wilhelmine* (Daimler), 6:40:23.

The racing auto-boats competed on Monday over a course measuring 71.82 miles. In the class from eight to twelve meters *Hotchkiss* won from *Trèfle-à-Quatre* and *Mercedes IV.* in 2:43:40 2-5. The time of the Richard-Brasier boat was 57 1-5 seconds more, and of the famous *Mercedes IV.* 11 minutes 9 seconds longer. In the class for boats less than eight meters long *Rapee III.* won from *Berleit IV.* in 2:54:07. *Berleit* was more than an hour slower.

There was also on Monday, September 12, a supplementary race for cruisers of not more than 10-horsepower that had been in use on Lake Lucerne before July 1, 1904. This was won by *Habsbourg* in 4:32:36.

An alcohol motor pump, of German manufacture, is used at Matanzas, Cuba, to supply the city with water. The price of alcohol in Cuba, about ten cents a gallon, makes it a cheap fuel, and the cost of

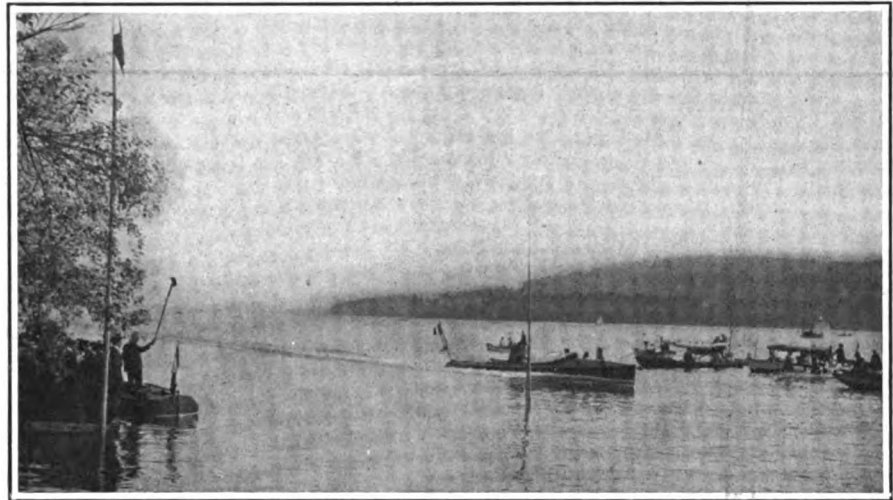

A SNAP SHOT TAKEN ON LAKE LUCERNE DURING THE AUTO-BOAT RACES.

slender craft raced over the placid bosom of the blue waters, leaving gracefully spreading angles of white behind, they formed a charming picture.

Although heavy rain fell during the start of the race on the first day, obscuring the fine scenery and making it uncomfortable for the spectators, the rain did not last long and the finish was watched without discomfort. Only cruising launches competed on this day. Four boats started in the class for boats up to eight meters in length and rated at not more than 30-horsepower. The course was a zigzag one, the start and finish being at Lucerne and the boats required to skirt the shores of the lake all the way around, covering a distance of 57.65 miles. The results were: *Per-tuisane* (Panhard motor), 3:25:28; *Titan IV.* (Delahaye), 3:55:21 2-5; *Excelsior V.* (Aster), 4:23:36; *Nina* (Volpi), 4:30:57.

Three cruisers, from eight to twelve meters long and of not more than 50-horsepower, covered the course as follows: *Marie Madelaine* (Panhard), 3:11:28; *Habsbourg*

operating the pump, which is of 75-horsepower, is about \$4 a day of ten hours, during which time the quantity of water pumped amounts to 1,000,000 gallons. The total cost of the machine, including installation, was \$6,000. German concerns are selling a considerable number of alcohol motors in Cuba for pumping and electric lighting plants. One firm, according to a report made by United States Minister Squiers, has contracted to install an alcohol motor pump at Vento, for use in connection with the Havana water supply system, to develop 180-horsepower and pump 1,000,000 gallons an hour at a fuel cost of \$1.60 an hour, the total cost of machinery and installation to be \$25,000.

Godfrey—I am sorry to hear that Squalop is in a bad way financially. What is the cause of it?

Scorjel—As nearly as I can learn, he has been trying to maintain an automobile position in society on a bicycle income.—*Chicago Tribune.*

HOW TO REACH THE VANDERBILT CUP COURSE.

HOW to get to the Vanderbilt Cup race course is a question that is of live interest to the thousands of persons who, weather permitting, will undoubtedly attend the great road race on Long Island. Present indications are that the attendance will be very large, and will include not only residents of New York and Brooklyn, but many from neighboring states and from more distant parts of the country. In our last issue a complete account of the hotel accommodations along the route, as ascertained by members of THE AUTOMOBILE staff, was published, and this is now supplemented by directions as to the best ways of reaching the course by automobile and by rail.

For those who will spend the night on the course the question of route and means of transportation is simplified. A choice of conveyance by automobile, train, or trolley can be made, and the route selected followed at leisure. Aside from the residents of Long Island who live at a convenient distance from the race route, however, those who expect to go from New York in time to see the start of the race on October 8 will have to be astir at a very early hour on Saturday morning, no matter what means of conveyance may be used.

It should be borne in mind that a great "tactical" advantage will be gained by being inside the triangle formed by the course. Only at the controls at Hicksville and

Hempstead will it be possible to cross the course in a car and get inside the triangle after 5 o'clock on the morning of the race. Those who go by rail will of course be able to get inside the triangle at intervals throughout the entire day.

For the sake of clearness, the routes to the course and the means of conveyance will be considered separately.

Routes by Automobile.

Automobilists who start for the race early enough on Saturday morning can travel over the course until some point that strikes their fancy is reached, and a location secured. There are miles of unfenced prairie and grazing lands along the route where the cars can be parked alongside the road, and the race watched from the owner's vehicle. This will be a great convenience for those who do not expect to rely upon roadhouses or hotels for food sup-

plies. In our last issue the various points of advantage were described. Bridges and ferries on the East river give the automobilist access to Long Island from Manhattan. There are only two ferries that are really practicable, the approaches to the others being through the poorly paved and often narrow streets which line both shores of the East river. The more popular of these is the Thirty-fourth Street Ferry of the Long Island Railroad, from the foot of East Thirty-fourth Street, New York, to Hunter's Point. This is the route usually travelled by automobiles to and from Long Island, the approaches being good on both sides. About three miles further north, at East Ninety-second Street, is the Astoria Ferry, easily reached from the upper part of the city, and convenient to the roads on the north shore of the island.

The two bridges are the old "Brooklyn

ing demands of the traffic. Thus far the ferry company has taken no action in relation to the race, but at very short notice extra boats can be put into service.

Driving from the boat on the Long Island side, a turn is made past the station of the Long Island Railroad into Borden Avenue, leading straight away from the river.

Half a mile from the ferry Borden Avenue passes under a railway viaduct; when clear of the viaduct, turn sharply to the left for a short distance and then to the right into Jackson Avenue.

Jackson Avenue is followed for half a mile, leaving a small triangular park and then a large brick school house, both on the left hand, until the Queens County Court House is met on the right hand, with St. John's Hospital on the left.

At the Court House take the right fork into Thompson Avenue, the center of the

roadway being of macadam with dirt dressing, with asphalt bicycle paths to right and left.

About one-eighth mile from the Court House there is a dangerous railway crossing, with six tracks, the view being obstructed by freight cars on some of the tracks.

The road, which is good, now leads by the New Calvary Cemetery, on the right, distance two miles, then through the village of Woodside, over a railway crossing with four tracks, and then through the village of

Winfield, where the Shell Road, or the Newtown and Bushwick Turnpike, leading to Flushing, crosses. Thompson Avenue is here lined on each side with a row of weeping willow trees, so that there is little danger, even in the dark, of leaving it for the Shell Road. The names of both roads are on sign boards on a frame house on the far corner, left hand side.

Beyond the willow trees are two lines of railway tracks, then Maurice Avenue crosses at an acute angle, leading away to the left, Thompson Avenue in a straight line being the right-hand fork.

Just beyond this crossing is Broadway, crossing at right angles in the center of the village of Newtown, a large frame store with an iron drinking fountain in front marking the left-hand far corner.

Continuing straight on, leaving the store on the left, a church is passed on the left hand and almost opposite another on the



View when Approaching Wulforst's Hotel, which Marks the Turn to the Left from the Hoffman Boulevard into Hillside Avenue on the Route from Thirty-fourth Street Ferry in New York to Hempstead or Queens.

Bridge," entered at Park Row, New York, and leading to the heart of the business section of Brooklyn, and the new "Williamsburg Bridge," recently opened, with an approach at Delancey Street, near the foot of East Grand Street, New York, and leading into Broadway, Williamsburg; and then into Bushwick Avenue and the Jamaica Road, both of good macadam or brick.

The great majority of vehicles attending the race will cross the Thirty-fourth Street Ferry, and for their benefit the route is given in detail. See maps on pages 380 and 381.

From Broadway, New York, or any of the north-and-south avenues the ferry may be reached by a run of half a mile or so east through Thirty-third or Thirty-fourth streets. There is a heavy traffic of all sorts of vehicles across the ferry, but the trip is a short one, about six minutes, and every effort is made to meet the vary-



A Well-Known Landmark in Jamaica—Peace Statue on Hillside Avenue which marks the Intersection of the Cross Road that, Taken to the Right, Leads into Merrick Road on the Route to Hempstead.

right hand; beyond this second church is a small automobile supply and repair shop, the sign showing plainly. The distance from the ferry is four miles.

Just beyond the two churches the road divides in a Y, the left fork being followed in almost a straight line. The road is now known as Hoffman Boulevard, and it is plainly marked by a row of telegraph poles to both left and right. A pile of broken stone, beams and building material is passed on the left hand. The roadway is somewhat narrower, but in good condition, though repairs are going on in places about here. After passing the ruins of a burned house on the left the road passes by the Maple Grove Cemetery, plainly marked by the trees and shrubbery.

When clear of the cemetery, the road winds to the right and shortly crosses at right angles Hillside Avenue, Wulforst's Hotel, a large frame building, being visible on the left-hand side far corner, as Hillside Avenue is neared. A view of the hotel as it appears on approaching the turn is shown in the reproduction of the photograph on the opposite page.

Turn left at right angle into Hillside Avenue, leaving the hotel on the right hand, and passing between rows of weeping willow trees. The seven-mile point, from the ferry, is about 1-4 mile beyond the turn into Hillside Avenue.

The road is wide and good here, with rising ground on the left hand, and lined on each side by snug cottages.

Just before reaching the normal school, a large brick building on the hill on the left hand, there is a dangerous trolley crossing,

there being no street, but only a private right of way which is easily passed unnoticed.

After crossing the trolley tracks, Flushing Avenue is crossed, with the normal school to the left, and another large brick building, the public school, a little further on to the right. Still further on the roadway divides on each side of an oval mound surmounted by a monument with a handsome bronze figure of Peace with arms extended. See photograph on this page which shows the front of the statue, which is at right angles to the direction of travel here described.

A gasometer is visible up on the hillside to the left, and a short distance beyond it is the tower of the Hollis waterworks, also on the left and up the hillside, while lower down on the same line is a small square building, apparently a pump house.

Continuing along Hillside Avenue, at a little more than half a mile from the waterworks, a road crosses at right angles, extending up the hill in a curve on the left, while on the right it runs down between turnip fields.

This is Queens Road, leading from Flushing to Queens; it is marked by sign boards on the far right-hand side (see photograph on this page) and by a small yellow sign of land for sale on the far left-hand corner. The distance from the ferry is about 9 3-4 miles.

Turn to the right into the Queens Road (also known locally as Vogel Street) and continue for about half a mile, when a right-angle turn to the left leads into the Jericho Turnpike, less than one mile from the crossing of Creed Avenue, a local name for the Springfield road which is the western boundary of the cup course.

ROUTE TO HEMPSTEAD.

Hempstead will be the objective point for most of the automobilists who intend to reach the course after the roads outside of the controls are closed to traffic. At this point entrance to the triangle can be had at any time during the day, as the racing cars will pass through the town at a speed not greater than eight miles an hour.

To reach Hempstead, follow the route from the East Thirty-fourth Street Ferry in New York exactly as laid down in the foregoing instructions as far as the monument on Hillside Avenue in Jamaica—see photograph on this page. Here, instead of continuing on straight to Queens, turn sharply to the right into the cross road that leads directly to the beginning of the Merrick Road in the town of Jamaica. Follow the Merrick Road in a southeasterly direction until the town of Rockville Centre is reached. Here a turn to the left is made into the main road (Village Avenue), leading north to Hempstead.

In case of congestion of traffic there are other good roads further along on the Merrick Road, near Baldwin and at Freeport, leading north directly into Hempstead.

Those who drive to the course from New York by way of the Williamsburg or Brooklyn bridges, the routes for which are described later in this article, and who do not expect to reach it before it is closed to traffic, will take care to turn off Hillside avenue in Jamaica and follow the Merrick Road the same as described in the foregoing "Route to Hempstead."

ROUTE THROUGH FLUSHING.

The route from New York City by the Ninety-second Street ferry, previously referred to, is indicated on the map on page 380. The landing is at Astoria on the Long Island side. From here a practically straight road nearly five miles long leads to the town of Flushing. On leaving the ferry follow Flushing Avenue through Long Island City until Flushing Bay is reached on the left-hand side; here the avenue branches into Jackson Causeway, which is followed across the bridge over Flushing creek and straight on to Main Street, Flushing, where the route turns sharply to the right. Main Street is followed for five blocks, when at the intersection of Madison Street take the left fork into Jamaica Avenue, and continue on straight until the old railroad route is reached on the outskirts of the town; here a turn to the right at an obtuse angle is made into Jamaica Road, which is followed in its windings until Hillside Avenue (at right angles) is reached. This turn is distant a little more than three miles from

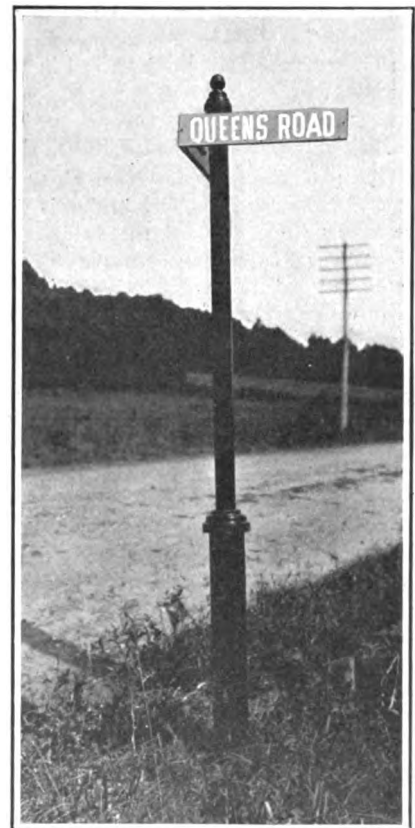

Sign Post on Hillside Avenue, beyond Holliswood, which Marks the Turn to the Right into Queens Road (also known as Vogel Street), leading direct into the Village of Queens. On the Main route from New York to the Cup Course.

Flushing. The normal school on the left, as one descends the hill, with the public school also to the left but on the opposite side of Hillside Avenue, mark the turning point. The route on to Queens follows exactly that taken by the automobilists from the Thirty-fourth Street ferry in New York.

BROOKLYN BRIDGE ROUTE.

Many of those who come over from New Jersey by the ferries across the North river will likely go out to the race by way of the old Brooklyn bridge. On reaching the Brooklyn end of the bridge follow along Fulton Street to Clinton Street, turn to the right and continue along Clinton to Schermerhorn, then turn left on Schermerhorn to Nevins Street, which is paved with red brick. Turn to the right into Nevins Street and continue straight on to the intersection of Dean Street. Turn left into Dean Street and continue on for three blocks to Flatbush Avenue. Turn right into Flatbush Avenue and continue straight on to the Plaza at the entrance to Prospect Park. Bear to left across the Plaza, striking the Eastern Parkway. Institute Park, containing the reservoir and Museum of Arts and Sciences, is passed on the right immediately after leaving the Plaza. At Ralph Avenue, the Eastern Parkway swings to the left; continue along this broad parkway until it forms a junction with Bushwick Avenue, into which turn to the right.

The route now followed is the same as the Williamsburg bridge route from Evergreen Cemetery to Queens, described in the following.

WILLIAMSBURG BRIDGE ROUTE.

Of the two bridge routes from Manhattan that by the Williamsburg bridge is the more direct. On leaving the bridge, in Williamsburg, Broadway, on which the elevated railroad is located, leads in the desired direction and for any one not familiar with the neighborhood is the best street to follow. The surface of the street is not in as good condition as that of neighboring streets which can be taken, but the route is direct and easily followed even in the dark. About three-quarters of a mile from the bridge Flushing Avenue crosses Broadway, and here turn left into the avenue for a distance of one block, and then to the right into Beaver Street, which is simply a continuation of Bushwick Avenue.

Follow Bushwick Avenue, a broad straight street, for about 2 1-4 miles, until just beyond the Evergreen Cemetery, on the left hand. Coming down a hill as the cemetery is passed, on the near left-hand corner is seen a large yellow frame building surmounted by a tower and flagstaff, Breitkopf's saloon. Facing it, and on the opposite side of the cross street, is the saloon of Frank A. Muntz, a two-story frame building. Turn to the left at Breitkopf's saloon into the Jamaica Road, which has a brick pavement with two lines of trolley tracks.

Follow this road, which is nearly straight, for just three miles, to the center of Richmond Hill village.

The turn to the left at Richmond Hill into Hillside Avenue is marked by a frame building on the near left-hand corner with a large blue and white sign, "Richmond Hill Cash Market"; on the far left-hand corner is a drug store, with a small blue and white name-board, "Hillside Avenue," plainly visible, and on the far right-hand corner is a large yellow frame building with a dentist's sign displayed.

Turn to the left between the market and the drug store, and continue around a curve to the right leading over another trolley track and then over the steam railway track close to Richmond Hill Station, on the

Hotel, already mentioned, will be seen on the far right-hand corner of Hillside Avenue where Hoffman Boulevard crosses it.

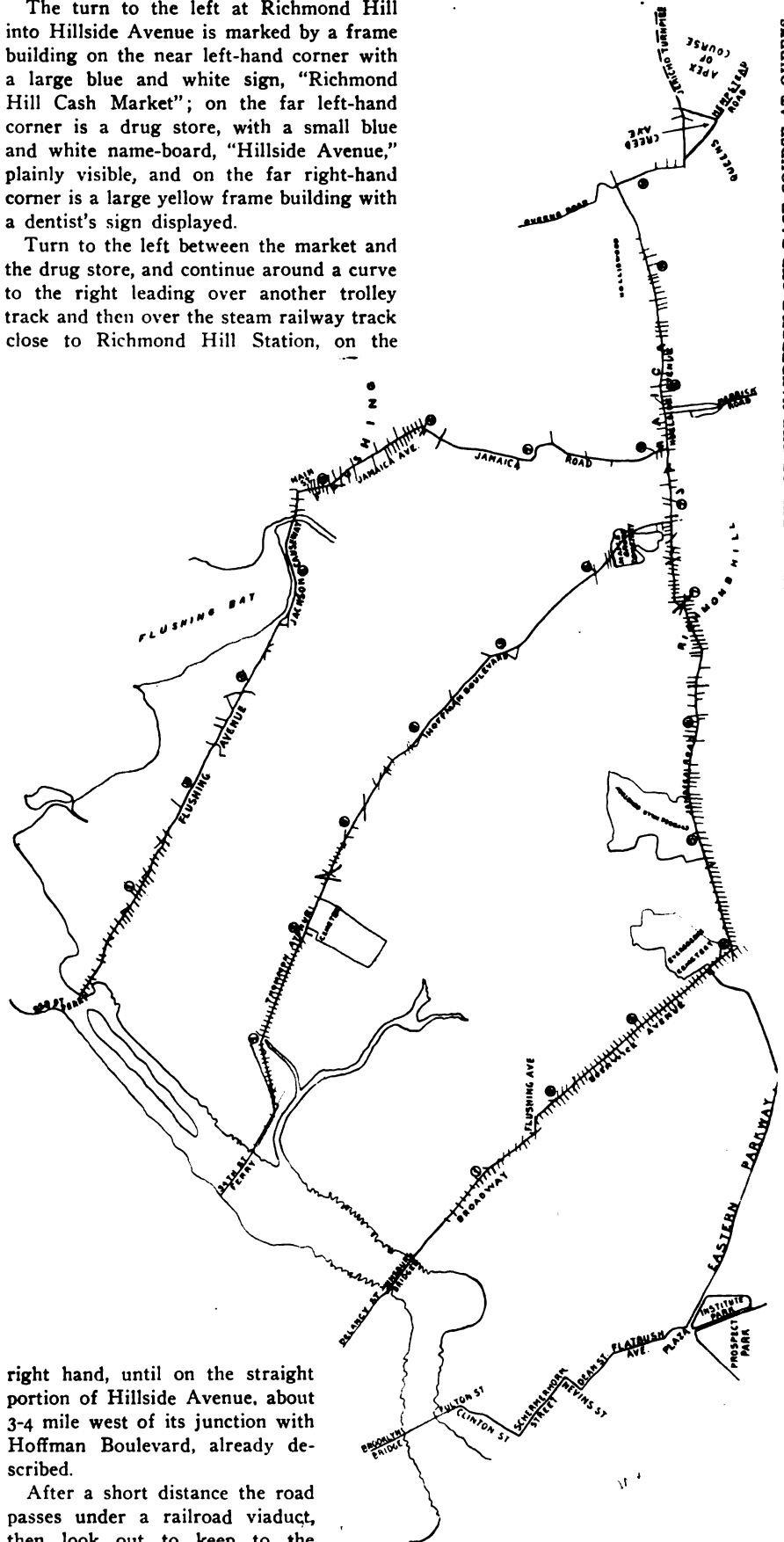

SKETCH MAP OF THE SEVERAL ROUTES FOR AUTOMOBILES FROM MANHATTAN AND BROOKLYN TO THE WESTERN END OF THE VANDERBILT CUP RACE COURSE AT QUEENS, AND ALSO INDICATING THE TURN IN JAMAICA INTO THE MERRICK ROAD ON THE ROUTE TO HEMPSTEAD.

right hand, until on the straight portion of Hillside Avenue, about 3-4 mile west of its junction with Hoffman Boulevard, already described.

After a short distance the road passes under a railroad viaduct, then look out to keep to the straight road, avoiding two streets which cross with acute angles branching off to the right; then, a short distance on, Wulforst's

Continue on Hillside Avenue, according to previous directions for the route from Thirty-fourth Street ferry.

Railroad Routes to Course.

Those who intend to go to the Vanderbilt Cup race by train or trolley have a choice of routes from New York and Brooklyn all focussing at or in the triangle formed by the course.

The rail routes are from the termini of the Long Island Railroad in Long Island City and Brooklyn. The former is reached direct from the ferry at the foot of East Thirty-fourth street, Manhattan. The Brooklyn terminal is situated at the junction of Flatbush and Atlantic avenues, and can be most conveniently reached from the Manhattan end of the Brooklyn Bridge by taking the elevated train or surface cars crossing the bridge.

The main line of the Long Island Railroad runs in a straight line eastward through

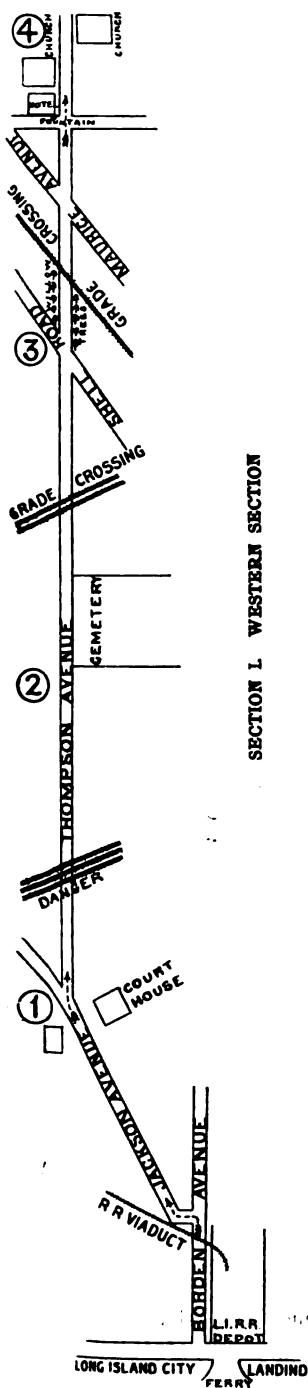

SECTION I. WESTERN SECTION

Diagrammatic Map showing in Plan the Main Automobile Route from Manhattan to the Western end of the Vanderbilt Cup Race Course in Long Island. (East Thirty-fourth Street Ferry to Queens.)
 NOTE - Direction is not Given by Compass but by Landmarks, the Separate Sections of the Map Overlapping so that it Can Be the more easily read. Figures to the Left within the Circles give the Approximate Mileage.

the triangle formed by the course, cutting the course at Creed avenue, in Queens, and at the Massapequa road, in Hicksville. The location of the tracks will be perfectly clear upon inspection of the map published in our issue of September 24. The northern leg of the course as far east as Westbury is within easy walking distance of the railroad at every station. At the present time the summer schedule is in force, and we are informed by the railroad management that it will not be cut down until the traf-

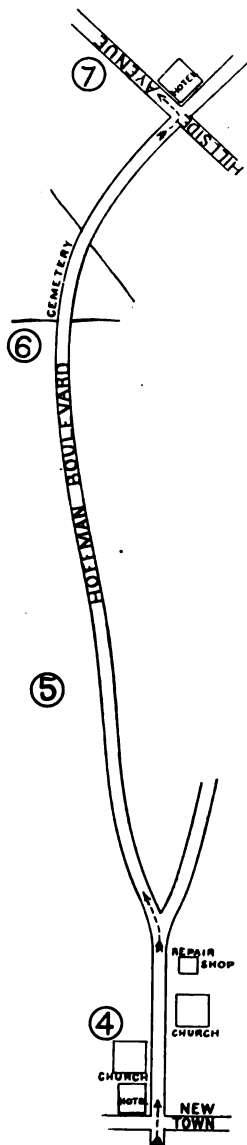

SECTION II. MIDDLE SECTION

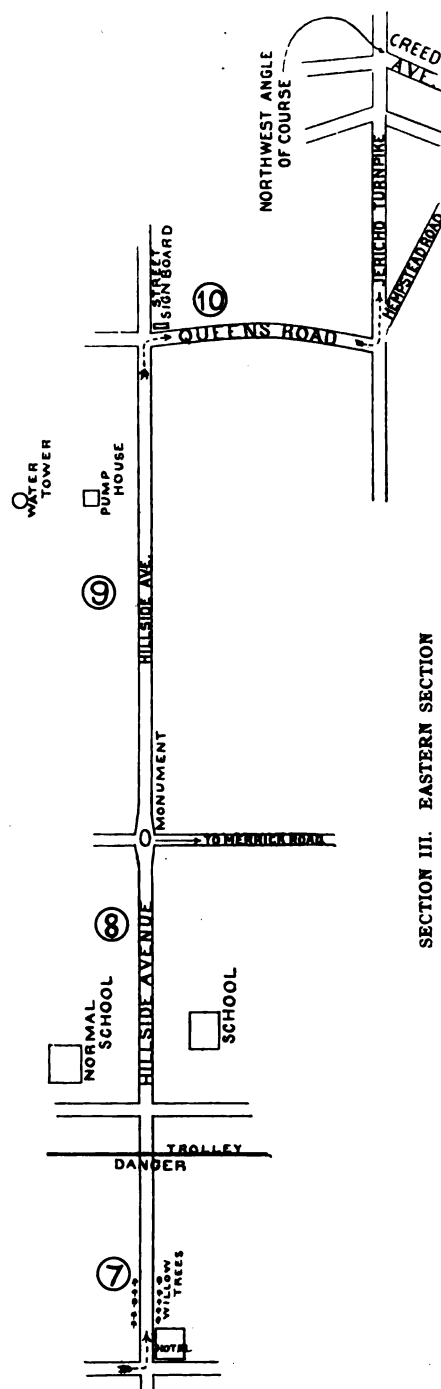

SECTION III. EASTERN SECTION

there are local trains operated between Mineola, Garden City and Hempstead.

ELEVATED AND SURFACE ROUTES.

fic becomes lighter, which is not expected before the date of the race. On the contrary, negotiations are now pending between the race management and the railroad for the running of special trains on October 8.

In the accompanying time table the schedule of morning and forenoon trains stopping at Queens, Floral Park, Hyde Park, Mineola, Westbury and Hicksville, is printed. The supplementary table gives a list of the trains on the branch line by which Garden City and Hempstead may be reached direct. In addition to these through trains,

For those who do not care to be tied down to the limited schedule of the steam railroad, there is a choice of routes by elevated and surface lines. The Brooklyn Elevated Railroad, starting from the Manhattan end of the Brooklyn bridge can be taken to Ridgewood, the end of the line, where a change is made to surface electric cars for Richmond Hill. At the latter point a change of surface cars is made for Jamaica. Persons resident uptown in New York will find it more convenient to take the ferry at the foot of East Twenty-third street, Manhattan, which lands them at the foot of Broadway, Brooklyn. Here the Brooklyn Ele-

Putting on the Finishing Touches.

vated Railroad can be taken to the end of the line at East New York, where connection is made with through electric surface cars for Jamaica.

At Washington street, Jamaica, the suburban surface line can be taken for Queens, where connection is made with the shuttle electric cars for Hempstead. From Queens to Hempstead the car track is laid along the Hempstead-Jamaica plank road, over which the cup cars will race. The cars from Jamaica to Queens are operated every 20 minutes, and from Queens to Hempstead every 40 minutes on ordinary days. On the day of the race it is probable that the service will be increased. The running time by this route from Manhattan to Hempstead is about two hours.

Residents of Brooklyn can, of course, take various trolley lines connecting with the surface and elevated roads, as there is a perfect network of trolley lines spread over the western end of Long Island.

Those who live in Jersey and who do not want to cross Manhattan can take the "Annex" ferry of the Pennsylvania Railroad to the foot of Fulton street, Brooklyn, and there get the Brooklyn elevated cars for the route via Ridgewood previously described; or take surface cars stopping at the Flatbush avenue terminus of the Long Island Railroad in Brooklyn.

"Which," asked the knowing one's companion, "which is the tonneau? I've heard that word lots of times, and I'd like to know just what the thing is."

For a moment the Knowing Man looked stumped, but only for a moment.

"Why," said he, "that's easy if you know French. Tonneau is derived from two French words, *ton*, meaning tone or sound, and *eau*, meaning water. It's the apparatus for lessening the noise of the machine by means of tubes of water. Sometimes it's called a muffler."

And the questioner, overcome by his companion's wealth of knowledge, sat silent for the rest of the trip.—*New York Sun*.



Heath Panhard Crack.

In the early days of the coming week the arrangements for the Vanderbilt Cup race, now only eight days off, will be completed. The work of oiling the course is well under way; the grand stand is practically finished; guards, deputy sheriffs and signalmen, to the number of about 175, have been engaged, and their duties assigned to them. The work of the race commission from now on will consist in putting on the finishing touches.

Among the most interesting of the details recently decided upon is the manner of checking the cars at the various checking points, and keeping the records.

The method adopted was used in the Paris-Madrid road race and found to answer the purpose well. Each car will carry, attached to the side of the driver's seat, a polished copper box. The checker at the start will drop into this box a card bearing a record of the time of starting; the checker at each control will drop in a record card every time the car passes his control; and the man at the finish will drop in a card bearing a record of the time of finishing. At the conclusion of the contest the boxes, which will be sealed, will be handed over to the race officials, who will use the cards in making up the official figures. This method obviates the possibility of loss of records and makes the work of the checkers comparatively easy and free from liability of error. Instead of checkers carrying around an armful of papers, the records will be carried by the cars themselves. The boxes, which were made in New York City, were patterned after one used in the Paris-Madrid race,

which was in the possession of E. T. Bird-sall, one of the official weighers-in.

The headquarters of the Racing Board of the American Automobile Association will be established on Wednesday, October 5, at the Garden City Hotel, where meetings of the board will be held on Wednesday, Thursday and Friday preceding the day of the race, for the purpose of taking final action on any matters that may still remain open. This evening (Saturday, October 1,) the drawing for numbers takes place at the rooms of the Automobile Club of America. Owners and drivers of cars and others interested in the proceedings will be freely admitted. The actual drawing will take place in a private room, of course, but the results will be announced without delay.

The judges and checkers at each of the four turns in the course and in the controls will be provided with special portable telephones, by means of which they can get into instant communication with the officials at the starting-point, who will thus be kept accurately informed of the progress of events with almost no delay, and can, if required, give decisions covering points that may arise miles away. The information sent in will be announced by megaphone for the benefit of the spectators in the grand stand, who will thus be enabled to follow the race intelligently. The New York and New Jersey Telephone Company, which has the telephone work in hand, will run something like 500 miles of wire. Four or more expert telephone inspectors and repair men will be located at the turns and other important points, and will be provided with motor bicycles to enable them to make quick runs to breaks, should any occur.

The great expense incurred in preparing for the race, and particularly in oiling the course, the latter item alone amounting to about \$5,000, has made it practically certain that there will be a deficit to be met when the business end of the race is wound up. A subscription list was therefore started. William K. Vanderbilt, Jr., headed the list with \$200; Mrs. William K. Vanderbilt, Jr., subscribed \$100; Mrs. O. H. P. Belmont, \$50; George Arents, \$50; Long Island Automobile Club, \$50; THE AUTOMOBILE, \$50;

Present Schedule of Branch Line Morning Trains on Long Island Railroad.

THIRTY-FOURTH ST. FERRY, NEW YORK.	FLATBUSH AVE. STATION, BROOKLYN.	GARDEN CITY.	HEMPSTEAD.
6.20	6.31	7.23	7.28
7.50	7.55	8.52	8.58
9.20	9.27	10.12	10.17
10.50	10.51	11.41	11.46

Present Schedule of Main Line Early Morning and Forenoon Trains to Vanderbilt Cup Course on Long Island Railroad.

THIRTY-FOURTH ST. FERRY, NEW YORK.	FLATBUSH AVE. STATION, BROOKLYN.	QUEENS.	FLORAL PARK.	HYDE PARK.	MINEOLA.	WESTBURY.	HICKSVILLE.
3.35	...	4.22	4.25	4.27	4.33	4.39	4.45
5.40	5.41	6.22	6.33	6.39	6.48
5.40	5.41	6.25	6.20	6.31	6.37
6.20	6.31	7.12	7.16
7.00	7.03	7.40	7.44	7.46	7.51
7.50	7.55	8.36	8.40	8.43	8.48
8.30	8.31	9.16	9.22	9.29
8.50	8.51	9.34	9.30
9.00	8.51	9.48	9.54	10.00
9.20	9.27	10.02	10.06
10.20	10.23	11.00	...	11.05	11.10	11.16	11.22
10.50	10.51	...	11.32	...	11.39
11.00	11.02	11.44	11.50	11.56

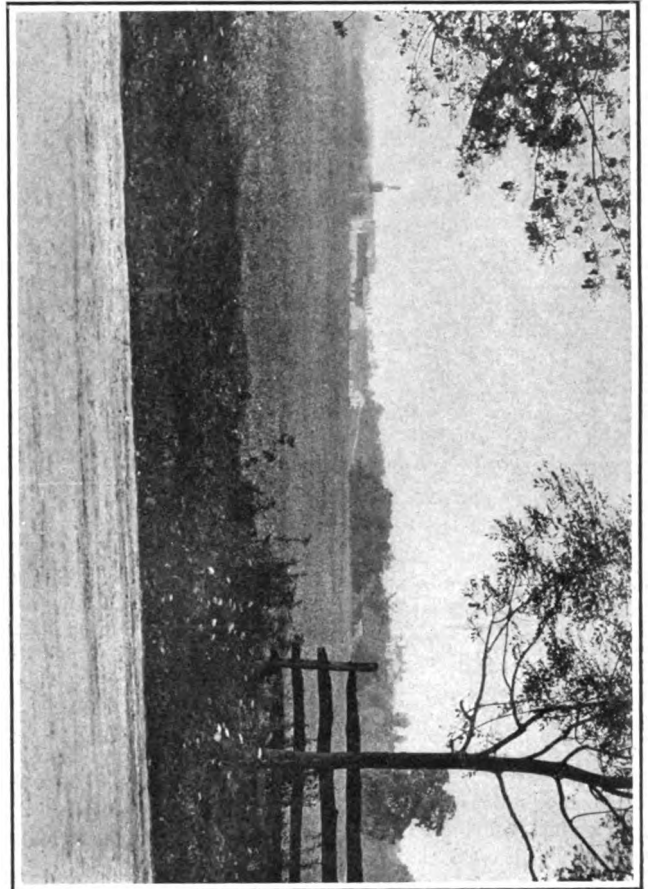

Looking North Across the Meadows from the Vicinity of the Grand Stand.

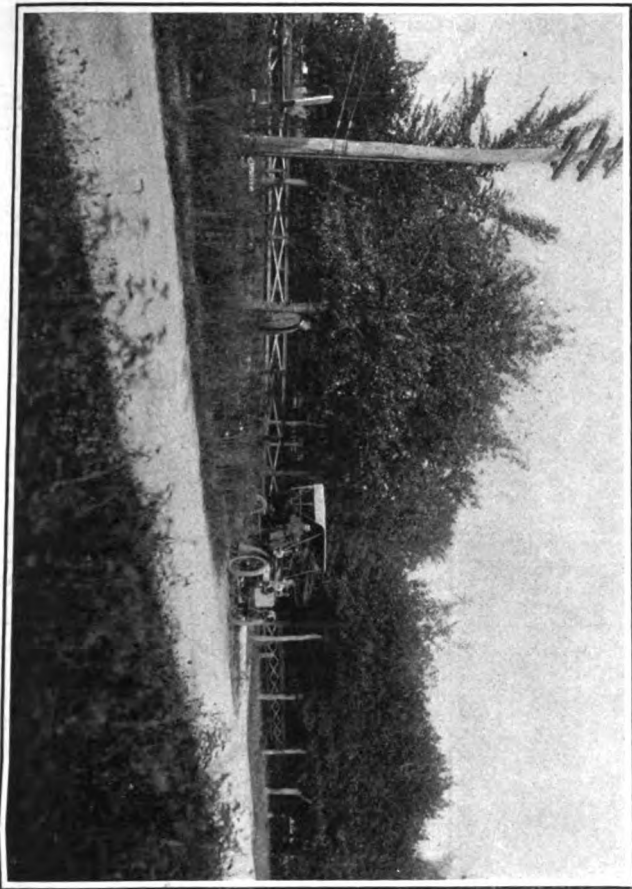

Bethpage Road. Looking Back at the Bad Turn from the Massapequa Road.
BITS OF SCENERY AND IMPORTANT POINTS ON THE VANDERBILT CUP RACE COURSE ON LONG ISLAND COLLECTED BY THE AUTOMOBILE CAMERA FIEND.

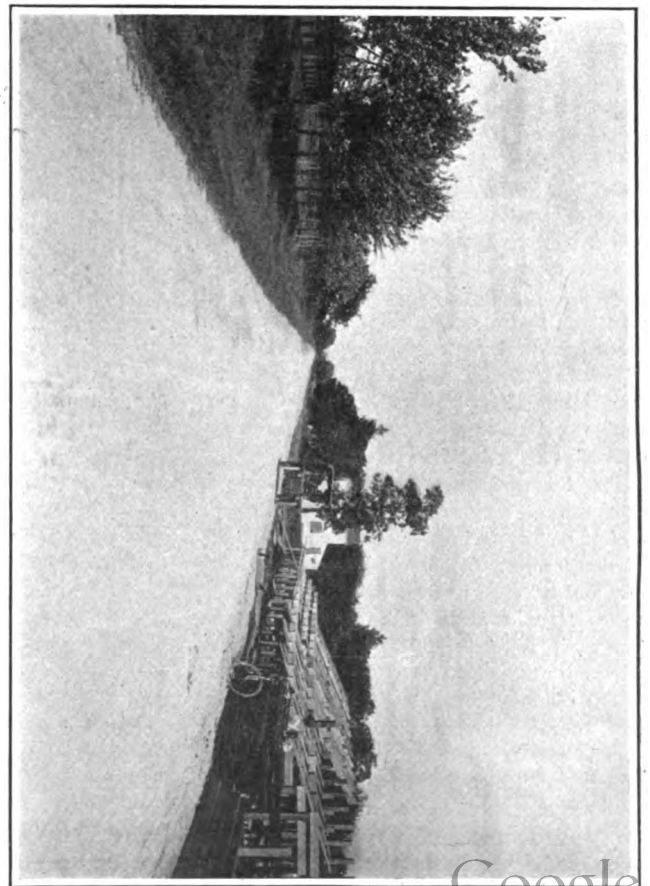

On the Jericho Turnpike—Grand Stand to Right, Private Race Track to Left.

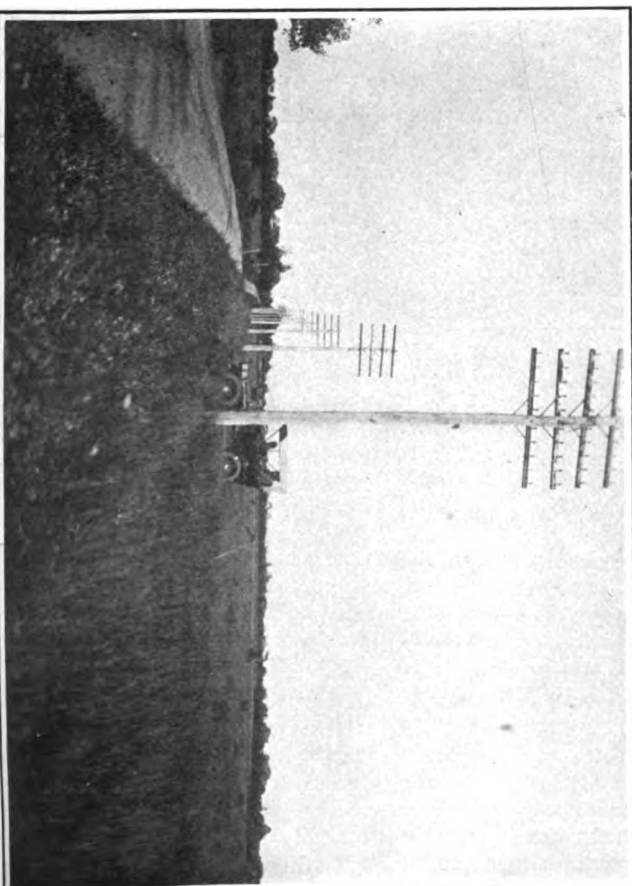

Typical Stretch of Prairie on the Course where Spectators' Cars can be Parked.

In addition to the actual subscriptions, letters have been received by Chairman Pardon from a number of automobilists in various parts of the country, who express their willingness to "chip in" if necessary. There is little doubt that the limited resources of revenue will yield their full earning capacity.

Early this week so many of the eighty boxes and of the 360 single seats had been reserved that the race officials felt confident that the demand would considerably exceed the supply before the day of the race. Great care has been exercised to prevent any speculation in seats. Only one box or two single seats will be sold to any individual, unless he is a member of a club affiliated with the A.A.A., and, in addition, is endorsed by a member of the Race Commission. The list of box holders, when complete, will read like a list of prominent American automobilists.

Among those already booked are: Albert C. Bostwick, Commodore F. G. Bourne, W. Gould Brokaw, Howard Gould, O. H. P. Belmont, Mayor George B. McClellan, George B. Pope, Harlan W. Whipple, president of the A.A.A.; W. C. Temple, Pittsburg, Pa.; Windsor T. White, Cleveland, O.; James L. Breese, George Arents, Jr., Frank H. Croker, George Farrington, treasurer of the A.A.A.; Mortimer L. Schiff, S. B. Bowman, Hollander & Tangeman, H. C. Frick, and the entire Executive Committee of the National Association of Automobile Manufacturers, the members of which will occupy three boxes secured by General Manager S. A. Miles.

Not even the race officials will be permitted to cross the track in front of the grand stand. The road will be perfectly clear at all times from the starting line to a point several hundred feet along the road. All who want to cross will have to do so outside of these boundaries. Further, no one, no matter what his official capacity, will be allowed to approach a car on the line excepting the driver and mechanic. Thus there will be no chance of delay by men getting in each others' way, and the spectators will have an unobstructed view of what is going on at the line. As the start takes place at sunrise, it is doubtful if there will be light enough for instantaneous photographs of the starters.

The brassards worn by the various officials will be colored as follows: Referee (Wm. K. Vanderbilt, Jr.), and the members of the commission, blue; judges, red; timers and starter, green; press, white, with name of publication in black letters. The brassards will be sent out by the Chairman of the racing board.

The pilots who will be on duty at the controls to guide the cars through at the proper speed, will be mounted on motor bicycles, which may be equipped with speedometers. One of the rules of the contest is that a car must pass out of a control exactly as it entered—that is, no work must be done on it until it has passed the neutral stretch.

Even supplies must be taken on outside of the controls. If a car breaks down within the limits of a control, it must be moved out by the crew by pushing on in any way they can, and work commenced after passing the control limit. Tire troubles will also have to be doctored outside, and just beyond each control will be located a lively camp of tire men, with piles of shoes, inner tubes and everything that could possibly be required in this line.

The Continental Caoutchouc Company is importing the entire outfit used in the Gordon Bennett and other great foreign races. This includes, besides the usual repair tools and materials, tanks filled with compressed air, so that filling a tire means simply coupling on a hose from the tank to the



Albert Clement, Jr., who Will Drive the Clement-Bayard Car in the Vanderbilt Cup Race.

tire valve and turning a cock. The tanks may be filled if they become exhausted by means of special pumps. Large signs will indicate the locations of the Continental tire camps, which will be three in number—one at each control and one somewhere between—or possibly four. M. Printehorn, one of the leading directors of the Continental Caoutchouc Company, is coming from France expressly to witness the race and see that the tire arrangements are as perfect as possible.

A new scheme, at least in this country, will be used by the United States agency for the Michelin Tire Company at its four track camps. Instead of tanks, heavy rubber bags, each containing sufficient air to inflate one tire, will be employed. These

are used in the same general manner as the steel reservoirs, but are so arranged that they automatically cut off when the correct pressure has been reached in the tire. This air bag is said to be the invention of an American, and is much used at races abroad. All the tire camps will be in charge of the most expert tire men obtainable, and no pains are being spared to make the arrangements complete.

William Wallace's 90-horsepower Gordon Bennett Fiat racer, which was damaged during a run over Boston roads last week, was brought to the Hollander & Tangeman garage in New York, where it was put in perfect order. The damage was found even less extensive than was anticipated, and the car is now as good as ever. Wallace, as well as other drivers, has been closely studying the course.

The French steamer *La Bretagne*, which arrived in New York on Sunday last, carried a notable collection of automobiles, consisting of the three Panhards entered in the race, and, in addition, a fourth, to be substituted in case of damage to either of the others, and two Clement-Bayard cars, one the cup racer and the other an ordinary touring car, to be used for ordinary travelling.

A house near the course has been secured for Albert Clement, Jr., and a barn for his automobiles, and he will establish himself there until the day of the race, spending practically all his time in going over the triangle. Up to the middle of the week he had not been over the course, owing to delay in getting his cars through the United States Customs, and was therefore unable to express an opinion as to its suitability for racing. He expressed his approval of the arrangements made for the race, as far as he was acquainted with them. "Just like the French way," he said, through his cousin, who acted as interpreter, the young driver's knowledge of spoken English being very slight.

M. Clement had practically no idea what the course was like, and seemed much interested when shown the map published in the last issue of *THE AUTOMOBILE*. The turns caught his eye instantly and caused him to shake his head. He was quite anxious to know about the width of the road, and when told of the narrow stretches, immediately asked what would happen if a driver slowed down his car and held the middle of the road, illustrating his query by folding his arms and sitting back, as if letting the machine run itself. A typical Frenchman, his gesture made his meaning perfectly apparent without the assistance of the interpreter.

When it was explained that the rules of the road would govern the race, and that a competitor could, if he chose, hold back a faster car than his own by refusing to give way, he stuck his hands deep down into his trousers pockets and grinned a broad, infectious grin, but made no remark. Clement is but a boy in appearance,



JOSEPH TRACY AT THE WHEEL OF THE "ROYAL" VANDERBILT CUP CAR.

but is solidly built and robust, with a round, sunburned face. His enforced inaction galled him, and he was full of anxiety to get away and commence preparing himself for the contest.

Teste and Tarte, who, with Heath, make up the Panhard team, are expected to arrive in New York to-day (Saturday), and will at once be hurried off to their track-side quarters. Heath is already in New York, and goes over the course nearly every day. Gabriel, the De Dietrich driver, will probably be a shipmate of Teste and Tarte.

Frank Croker, who will drive the Smith & Mabley 75-horsepower Simplex, is tuning up his car by means of road runs, but has not had it on the course. "I am perfectly satisfied with the machine," said Mr. Croker, "but have not, of course, had an opportunity to see how fast it would go. It was at first somewhat over weight, but this has been remedied and there is now a little to spare.

"The arrangements for the race? Why, it seems to me that they are about as complete as they can be. The only difference I can see between the precautions taken for the Vanderbilt Cup race and those

taken for road races abroad is that the foreigners make use of a great many more men in policing the course.

the route selected from a racing point of view. My experience in fast work consists of about 5,000 miles in a 60-horsepower Mercedes, which I drive abroad. You know, they let you go as fast as you like in the open country over there; but that is a very different thing from racing in competition with other fast machines. I know that I am the most inexperienced driver in the whole lot, and if I didn't own the car I would not be a competitor in the race; but there is only one way to gain experience in racing, and that is in races.

"I sincerely hope an American machine will win. It does not seem likely; but in any case it is to be hoped the American manufacturers will make a showing that will give them a standing among foreign racing men and manufacturers for the next Gordon Bennett race."

Frank Croker, William Wallace and S.

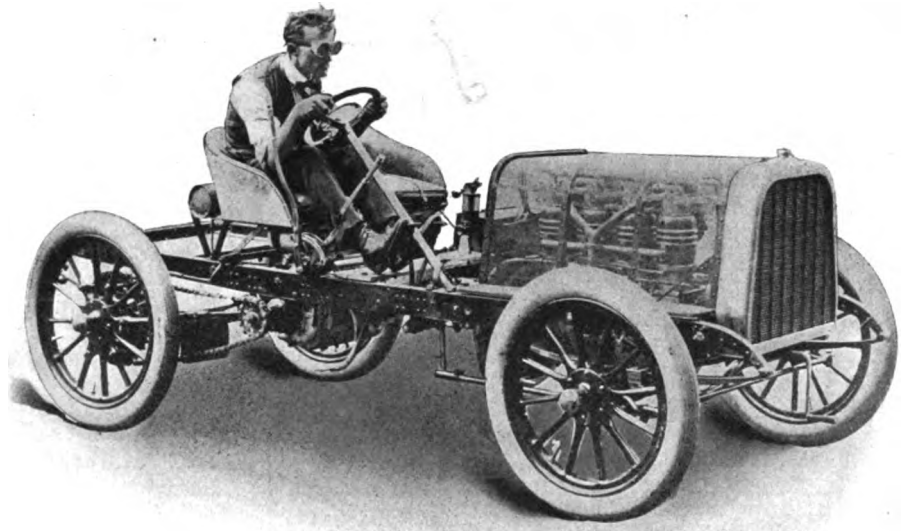

H. H. LYTTLE IN ONE OF THE POPE-TOLEDO CARS ENTERED IN THE RACE.

"Not being an experienced racing man, I am not in a position to say anything about

B. Stevens will be the three amateur drivers in the race; but there is a possibility that the Mercedes of Mr. Stevens may not be in a condition to start. Last week a bad crack developed in the crank-case, and it was necessary to wire to Germany for a new one, as it could not be obtained in this country. It is a question whether there will be time to send it over, fit it to the motor and tune up the car before the day of the race.

Those who wish to reach the grand stand after the race has been started, must, if travelling in vehicles, go from Jamaica to Rockville Centre or Freeport via the Merrick road; thence to Hempstead, through the 6-minute control, and on to Garden City and Mineola, past the Fair Grounds, to Westbury. From Westbury a road runs directly to the starting point, and the entrance to the grand stand opens from this road. The stand is about one mile from the Westbury Railway station. Arrangements are being made to park a number of automobiles in a vacant lot near the stand.



EDWARD HAWLEY AND MECHANICIAN IN E. R. THOMAS'S MERCEDES CUP RACER

and there are numerous fields along the route where other cars can be left.

Intending spectators will do well to make

a study of the course, by personal inspection, if possible, as this will add much to the interest of the race.

and the weight indicated was 2,300 pounds. As the car weighed 2,202.4 pounds just previous to its shipment from Europe, with the same equipment as when weighed at Garden City, Mr. Dinsmore was surprised, and took the machine to Hempstead, where the weight was tested on another scale. This time the figures obtained gave the weight of the car as 2,237 pounds. Knowing that a little mud and a fresh coat of paint could not explain the difference between the European figures and those shown on the Garden City scales, Mr. Dinsmore wrote to Chairman Pardington asking that the scales be calibrated.

The Race Commission has not as yet had anything to do with the scales, further than selecting them for the official weighing-in. Previous to the weighing-in they will be accurately calibrated by Messrs. Birdsall and Riker, so that the weights indicated will be correct.

Gathered on the Cup Course.

Special Correspondence.

GARDEN CITY, Long Island, Sept. 27.—Several of the racing machines entered in the Vanderbilt Cup race are now near the scene of the contest. Clarence Gray Dinsmore's 90-horsepower Mercedes, George Arendts' 60-horsepower car of the same make, the 90-horsepower Fiat of William Wallace, Frank A. Croker's Simplex and the Packard 30-horsepower machine are quartered in the neighborhood of Garden City and Mineola.

In each case, except that of the Dinsmore Mercedes, the cars were accompanied in their arrival by other cars of the same make, which will be used as tenders. These extra cars will not only be of service on the day of the race in carrying gasoline and other supplies for the participating machines, but they will be used in similar ways in all the trial spins which are being taken by the race drivers.

There is much activity on the line of the race course and in the surrounding towns and villages. The work of oiling the roads on the contract of the Racing Board was begun on Tuesday morning. Andrews Bros., of Mineola, have the work in hand, which is to cost \$4,600. The first of the nineteen cars of crude petroleum to be purchased was delivered at Queens to-day. Here the oil was pumped from the tanks into the sprinkling carts, which are equipped with a special device for distributing the oil. Three of these wagons are in use.

About four miles a day is being oiled by the contractors, 115,000 gallons being the total amount to be distributed on the course. In the case of the loose sand roads, there will be more than one application, but on most of the course only one sprinkling will be necessary. The contractors assert that the work is far from an experiment. Many miles of private roads in estates on Long Island have been oiled this summer, and a considerable stretch in Mineola was put under oil for the recent fair. Besides these, three miles in the neighborhood of New Hyde Park were oiled last week through the enterprise of private owners. This road-bed wears well, there being practically no dust discernible as machines pass over it. It is said that the first saturation results in immunity from dust for about two months. The second and succeeding sprinklings lay the dust for fully five months ensuing. The general benefit of the race for the users of these roads will be apparent, therefore, until the snow begins to fall.

Work on the road improvements is coming along rapidly on the Bethpage pike and on the Hicksville road. A considerable

number of laborers are steadily engaged and the road begins to show a condition which augurs well for speed on October 8. The linemen are busy installing the special telephone wires which are to be used on the day of the race. Even the trolley lines are noting the necessity of taking care of the crowds expected and are busy improving their road-beds and replacing poor rails. All these improvements, with the work on the grand stand and the erection of several new sheds where racers are to be housed, have given employment to hundreds of mechanics.



TWO OF THE RACE OFFICIALS.
C. H. Gillette, Starter, on the Left; and A. R. Pardington, Chairman 1904 Race Commission, on the Right.

This fact alone has tended to overcome any local prejudice against holding the race on this course. The native population is beginning to feel the prosperity which comes with an international race of this character. Many are erecting booths along the roads for the sale of luncheons and coffee. The tendency is toward enthusiasm, and with the coming of more people to the region will come added opportunities for gain.

Many machines are making a tour of the course each day. At a road-house on the Jericho road where a count is being kept by the proprietor, it was reported that ninety-two had gone by on Sunday and fifty-five on Monday. This will give a pretty good idea of the interest shown by New York enthusiasts, for the count did not include those owned locally.

Clarence Gray Dinsmore's Mercedes was placed on the scales at Garden City, which are to be used in the official weighing of the racing machines on Friday, October 7,

NEWS NOTES OF THE CLUBS.

BALTIMORE.—The Automobile Club of Maryland is planning a run to the Delaware Water Gap some time in October. A large number of the members have signified their desire to make the trip.

BUFFALO.—T. J. Wagner has resigned the secretaryship of the A. C. of Buffalo, which he has held since the club was organized, and has transferred his business headquarters to New York City. A meeting of the board of governors of the club is to be held this week to appoint his successor to hold office until the election next January.

DAVENPORT, IA.—At a recent meeting of the Davenport A. C. the following new members were admitted: A. M. Price, J. L. Hebert, W. A. Fuller, John Eagal, James Bayliss, John Dow, Harry Ryan, Bert Dow, Charles F. Mason, Emil Buck, J. W. Buck, Henry Lage, Horace Roberts, Henry Stoltenberg and J. B. Hostetler.

TROY, N. Y.—The Troy A. C., which was organized nearly three years ago, now numbers among its members some of the leading citizens of the city and its vicinity, and has well appointed club rooms in the Hall Building. Aside from its social features, the club is interesting itself in the promotion of laws for the benefit of automobiling, as well as the enforcement of existing laws regulating the use of motor vehicles. Alonzo McConihe is its president and Dr. Archibald Buchanan, secretary.

HOUSTON, Tex.—The Houston A. C., recently organized with temporary officers, has held its second meeting, which was largely attended, and at which the organization was made permanent and the following officers elected for the ensuing year: G. J. Palmer, president; Spencer Hutchins, vice-president; Miss Jennie Bering, secretary, and M. J. Lossing, treasurer. The following board of directors was also chosen: Theo. Bering, Jr., W. A. Burkett, Harry Dooley, W. R. Eckert, Charles Meyer, D. Peacock and William Brumby.

Rebuilding an Early Winton.

By A. WILSON DODS, M. D.

THE following is an account of how I rebuilt Winton No. 61. I bought this car, which was of date of 1899 or 1900, for \$100, and ran it last year some 1,500 miles. It had a leather dash, tiller steer, reach running gear, full elliptic front and rear springs, and the familiar Winton individual clutch transmission, single cylinder motor, and pneumatic control. The transmission gears were not encased, and the spark time was fixed.

Though old, the car was in very fair condition mechanically. Most of the bearings required nothing but cleaning; but new piston rings and new bronze transmission gears were necessary. It was seen that, so far as the life of the machine was concerned, it would well repay rebuilding to incorporate such items as longer wheel base, wheel steer, variable spark lead, and box front, whereby the ease of riding and the appearance would greatly benefit.

Accordingly, to begin with, a new frame was built. The old frame was of 1 1-2 by 3-inch ash, with the side members reinforced by steel strips beneath. The new frame had side members 1 3-8 in. wide, and tapered for the front 20 inches from 3 inches in depth to 2 in. Each side member was armored on the outside with 1-8 in. steel. For the old elliptic springs, 30 in. by 1 1-2 inch., with five leaves in rear and four in front, were substituted a pair of semi-elliptic springs in front, 40 in. by 1 1-2 in., and in the rear a pair of scroll elliptics 36 in. by 1 1-2 in. All the new springs had five leaves, graded. The old reaches were taken out, and the two outside ones shortened and connected as dis-

the ball-adjusting cone and take the lock nut on top of all. One arm of this bell crank extends inward in line with the axle, when the wheels are straight, just clearing the spring and spring clips, and has a ball on the end which takes the key of the fore and aft drag link to the steering gear; the other arm of the bell crank is bent down-

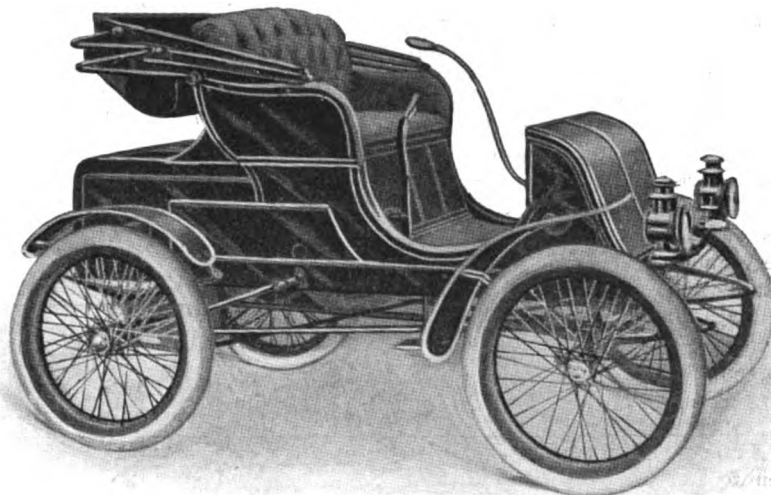

WINTON STANHOPE OF 1899 OR 1900, BEFORE ALTERATION BY AN AMATEUR.

ward and backward, and is bolted to the old hole in the horizontal arm of the steering knuckle where the old cross drag link was secured. This arrangement places the steering strains just where they were under the old plan of lever steering.

The front wheel ball bearings were cleaned and readjusted, no replacement being required. The differential had a case with wood ends and sheet iron body. It

speed, was put in the line from bottom of radiator to bottom of engine jacket.

A wooden hood was fitted to cover the gasoline tank and the space between the dash and back of radiator and water tank, and contains a good, roomy tool box. With the tanks thus disposed, it was easy to cut 2 1-2 inches off from the top of the body, back of the seat. I also cut off an inch and a half from the bottom edge where it projected below the frame, making it look lighter and in better proportion. The screening in the cover board was replaced by solid panels, and the foot boards, which were screwed in from below, carriage maker's fashion, were taken out, raised an inch, and laid in from above so as to be easily removable. New sheet iron mud guards replace the old leather ones. The original seat was retained.

The engine had a new set of piston rings scraped to fit by hand, and the copper of the old water tank and brass of old gasoline tank were drawn upon to make a pan for the bottom and cover for top of crank space. New bronze gears were put into the transmission and a sheet iron pan fitted below it so as to stop oil drip as much as possible. The transmission was not otherwise changed, save as to the lubrication. The old cylinder oil cup has been replaced by a new pressure cup, and two multiple oilers replace the old oiling boxes, the one for the transmission being fitted on the frame over the gears and under the seat. The oiler for the engine is placed on the left side of the dash, and the pipes to the bearings are carried under the foot board.



RECONSTRUCTED WINTON. WITH NEW FRAME, SQUARE BONNET AND WHEEL STEER.

tance rods to the frame. The wheel base was lengthened from 70 inches to 88 inches, all of the increase being put in front.

For the old tiller, a bevel pinion and gear wheel steer was substituted. The vertical pivot of the left knuckle was lengthened to let the nut of a bell crank fit on it above

let in dust, and would not hold grease or oil. I had a new sheet iron case, grease tight, made for it, and put in a new second shaft, bronze bearings, pinion, and new sprocket wheel.

The leather dash was replaced by one of wood fastened by angle iron to the frame.

A new carbureter of the float feed type replaces the old one, and as this has a throttle and auxiliary air valve which are controlled from the steering post, the air pump and fittings of the Winton control have been taken out.

A spark advance was fitted by placing a wedge—controlled from the side of the seat—between the spark rod and the engine frame which, by forcing the spark rod away from the engine, makes it drop off the snap cam earlier in the revolution. A new sprocket on the engine shaft and new chain were also supplied. The ignition apparatus was not otherwise changed, except to add a spare battery and rearrange the items. A battery box with twelve medium-sized Columbia cells was fitted in the space formerly occupied by the water tank, and an Edison primary coil in a box with two-throw switch was placed on the dash. The battery and other connections are all of Packard cable with Herz terminals.

A six-inch Rushmore searchlight with Solar side lights and tail lamp, and the usual horn, form the lighting and signal equipment.

The whole car was repainted, the running gear automobile red, and the body Brewster green for the panels, with black mouldings.

The cost of the whole work, not including the time I spent myself, was \$254.89. No serious difficulties were encountered, the only troublesome thing about the new car being that the longer rear spring is in the way of the starting crank, which can only travel two-thirds of the circle; but as the obstruction is at the back of the circle of throw the difficulty is not serious. The original weight was 1,610 pounds, and the present weight is 1,840 pounds. In spite of the added weight, the change is all for the better. The car is quieter and has more power, due to the spark advance, and it rides and steers a great deal better and easier. It is not a modern car, of course, but it is a lot better than the cheaper class of machines.

In reply to the Editor's suggestion that my experience may be of use to others, I would say that the safest lesson to draw from it would be: Do not try to alter a car unless you know that the engine, transmission, and axle bearings are all right and in good condition. Make the alterations as few as possible to secure the result desired, and make drawings of all changes, also of car as changed, before you begin work on the car.

A French engineer has invented a power system which is certainly unique in many respects, and has applied it to a touring car. There is no change speed gearing, the gasoline motor being direct connected to the rear axle. Changes of speed are effected by a special system of throttling, and the reversing is effected by bringing into operation an extra set of cams on the motor, which cause it to run backward.

M. Charley's Auto-Boat Prize Already Won.

The subject of the proposed power boat race across the Atlantic from Havre to New York is still actively discussed on both sides of the water, although it is treated with levity by many American launch owners. The French, however, with the probable exception of the astute M. Charley, who is doubtless laughing in his sleeve as he repeats Puck's famous soliloquy, have taken the matter with all seriousness and are gravely discussing ways and means. In a recent interview Chevalier Rene de Knyff, of the Panhard company, and the well-known driver of the Panhard cars, expresses the opinion that it is impossible to utilize "heavy petrol" as a fuel for such a race.

In view of the lively interest in launches in France and the prominence of French



M. CHARLEY, OF PARIS, AT WHEEL OF "MERCEDES IV."

constructors of both hulls and motors, it is rather remarkable that neither M. Charley nor Chevalier de Knyff is informed as to an event of recent occurrence which far outdoes all that France has yet accomplished in motor-boating. Ignoring for the time the loose and indefinite terminology which fathers but does not define such new terms as "auto-boat," "canot-automobile," "auto-launch" and "motor-boat," the plain fact is that the Atlantic voyage has already been made by a launch of small size propelled by an explosion motor and using a "heavy petrol" (kerosene) as fuel, as was told in THE AUTOMOBILE of September 17.

The launch was 38 feet over all, 33 feet on the load waterline, 9 feet in breadth and 3 feet 8 inches draft, with a freeboard amidship of 2 feet 3 inches. She had an almost plumb and straight stem and a small after overhang of the whaleboat type, and in model she was designed for the special

task in view. She carried a trunk cabin with side lights, and a fairly large cockpit. A small standing lug mainsail and leg-o'-mutton jigger were carried to steady her, but they were too small to drive her without the power.

The motor was built by the New York Kerosene Engine Company, and was of heavy construction, the fuel being kerosene and ignition by means of a cast-iron globe on the cylinder head; it was rated at 10-horsepower. The fuel tanks held 800 gallons of kerosene and there were also water tanks of 250 gallons capacity, in addition to oil, food and other supplies.

The *Abiel Abbott Low*, as she was named, sailed from College Point, Long Island, on July 9, 1902, manned by a crew of two—Captain William C. Newman and his sixteen-year old son, C. E. Newman. After an exciting passage, some bad weather being encountered, while a leak in the after oil tank gave serious trouble, she reached the West India Docks, London, on September 20 in good condition and all well, and, strange to say, with nearly half her oil supply still in the tanks.

It may be claimed that the *Low* was not strictly an "auto-boat;" she was built of ordinary white cedar and oak instead of mahogany veneer, she cost far less than the high-powered still-water racing boats of 1904, and she had no caned armchairs in her cockpit for her owner and his guests to recline in while running 23.647 knots; at the same time it must be admitted that she has achieved an original venture that is likely to overshadow any ocean performances of the more speedy and fragile craft for some time to come.

She proved that it is possible to cross the Atlantic safely, if slowly, in a very small craft propelled by an explosion motor, and she has shown the way to the construction, if it be necessary or desirable, of similar launches of much higher speed.

Thus far, after various additions and explanations of the original vague offer of 50,000 francs to the first "motor-boat" or "auto-boat" to cross the Atlantic, the whole project, if intended as a bona fide offer and not a mere advertising scheme, is still in a nebulous, not to say gaseous, state. It is now in order for M. Charley to inform himself as to the facts of the *Low's* voyage, and then, if he does not at once decide that she is entitled to his prize, to lay down exact, definite and practicable conditions as to dimensions and type of hull, speed, power and fuel.

The English auto-boat *Napier Minor* was used, during a recent attempt to swim the English Channel, to carry reports from the swimmers to the shore.

"What is that quotation about beggars? Something about 'wishes' and 'horses,' don't you know?"

"Oh, yes. 'If wishes were horses beggars would want automobiles.'"—*Catholic Standard-Times*.

Correspondence

Balancing a Single Cylinder Engine.

Editor THE AUTOMOBILE.

Sir:—What is the right way to balance a single-cylinder, horizontal gasoline engine for automobile use—to put a balance on the crank, to balance the piston and rod, or to balance the shaft with the flywheels on?

N. B.

Allentown, Pa.

The balance weights should be on the cranks, opposite, of course, to the crankpins, and should balance the cranks and crankpin plus the crank end of the connecting rod. Some builders made the balance weights heavier than this, but they should not do more than balance the connecting rod in addition to the cranks and crankpin.

Proper Grade of Gasoline.

Editor THE AUTOMOBILE.

Sir:—Please advise what the effect would be on a gasoline engine to use 76 gasoline in same.

C. H. T.

Henderson, N. C.

As 76 degree gasoline is commonly considered the most desirable grade for use in explosion motors, and is not used universally only because it costs more than the lower grades and is less readily obtained, it is highly probable that if your spark is right and the carbureter is adjusted properly your engine will develop plenty of power.

Valve Dimensions and Lift.

Editor THE AUTOMOBILE.

Sir:—Will you please give me a little information on the design of a four-cylinder auto engine? The one I have in view is of 3 3/4-inch bore by 4 1/2-inch stroke, and I would like to have it develop 16 horsepower at 1,200 revolutions per minute. What size should I make the valves, the intake being mechanical? State, too, the required lift of each. In this case, what proportion should I make the compression chamber?

R. P. H.

Indianapolis, Ind.

The valves may be 1 1/2 inches diameter in the clear and lift 1/4 inch for the inlet and 5/16 inch for the exhaust. The volume of the compression chamber should be about 3/10 of the volume swept by the piston, or say 15 cubic inches.

Passing Horses on the Road.

Editor THE AUTOMOBILE.

Sir:—I have read the letter in your issue of September 3 by "Dejected Despondent" in regard to meeting frightened horses on a country road, and I am positive that there is no occasion for others to feel as nervous as he does, provided they know what to do under such circumstances. It is true that one out of ten country drivers are much

more frightened than their horses when an automobile appears, and their actions work the horses up to a nervous pitch about as much as does the machine, but occasionally a horse will be met that shows with absolutely no doubt that he is thoroughly afraid, and this type is nearly always encountered where the road is narrow.

Trouble is sure to follow an attempt to pass such a horse unless the proper diplomacy, or "horse sense" is used. After having turned out as far as possible and stopped the engine, the next thing to do is to remove your goggles and pick a large handful of grass, giving the horse a nibble or two and then begin to lead him toward the machine, at the same time talking to him in a reassuring manner. As he gets nearer feed the grass oftener, and talk and feed continuously while passing the auto, and do not let go of the bridle. It is important to take a bunch of grass which will be large enough to last through the feeding process. In fact, the larger the bunch the better.

This method may be an old one to many of your readers, but, like many other simple things, it is well worth trying by any one who does not know a better plan. I have led past my car horses that were just getting ready to climb trees before the grass idea was applied. In fact, I have yet to find a case where it has not worked beautifully.

It is not a bad scheme to have covers made for the lamps, to be kept on during the day time. A friend of mine claims to have proved conclusively that the shining brass on the lamps has more to do in scaring a horse than anything else about the automobile. At night, fortunately, the danger is much less, and it is not necessary to cover the lights. A horse is not an absolute fool, and consequently is not apt to run away after dark, because he cannot see very well where he is running.

Observation will soon teach an auto driver how near he can approach a horse before it is necessary to stop the engine, but do not wait too long before doing so. A little consideration of this sort will do wonders towards producing a better feeling among farmers towards the automobile.

G. G. C.

Pittsfield, Mass.

Engine for 1,200 Pound Touring Car.

Editor THE AUTOMOBILE.

Sir:—I have under construction a touring car to weight complete, without engine or transmission, about 1,200 pounds. Would a three-cylinder, four-cycle engine of the following specifications be heavy enough for the car; and, also, would a motor of these dimensions be likely to give good service—in other words, is it correctly designed?

Weight, 250 pounds; bore, 4 inches; stroke, 4 inches; size of inlet and exhaust valves, 1 5/8 inches, both mechanically operated; diameter of crankshaft, 1 7/16 inches; of wristpin, 1 5/16 inches; of camshaft, 3-4

inch; of flywheel, 16 inches (weight 70 pounds); face of flywheel, 2 1/2 inches. Normal speed, 900 revolutions per minute. Cylinders cast together. Crankshaft has three bearings about 3 inches diameter. Diameter of clutch flange, 8 1/2 inches; face, 1 1/2 inches. Shall use a three-speed sliding gear transmission with cross shaft drive.

Please tell me if having the three cylinders cast in one is likely to give good results. Is the clutch flange large enough to prove efficient, and what power will the motor develop, approximately?

R. H. B.

Middletown, Conn.

In the main, the above proportions are good. If by wristpin you mean crankpin, it would better be at least as large as the shaft. Your clutch, if of the conical, leather-faced type, should be as large as the flywheel rim will accommodate. It would not be a bad plan to make the rim 3 or 3 1/2 inches wide and correspondingly thinner, to give room for a good-sized clutch. The motor should develop 11 or 12 horsepower at normal speed of 900 revolutions per minute.

Car for Physician's Use.

Editor THE AUTOMOBILE.

Sir:—Which do you think the cheaper to operate and keep in repair, the gasoline or the electric machine, to be used in the city by a physician?

A. A. R.

Philadelphia.

The question you ask is practically unanswerable, as so much depends upon the owner. Under the most favorable circumstances the upkeep of one car would perhaps not be very different from the other. Many physicians favor the gasoline car, one reason in favor of it that appeals to them being its availability for use at any time, day or night, for if the machine is in running order all that is necessary is to put fuel in the tank and oil in the lubricator, and it is ready to start; whereas in the case of an electric vehicle, a physician having used the machine all day, and so run down the battery, might have a hurry call at a time when the car was being charged and not in condition to use.

Again, a gasoline car can be used for pleasure purposes as distinct from professional work in making trips or tours about the surrounding country, while the electric vehicle is not very well suited for such work. Its radius of action is comparatively small, its hill-climbing powers not very great, and the uncertainty of finding charging stations has also to be considered. The modern gasoline runabouts are very reliable, and with any sort of fair treatment would give you very great satisfaction. The electric vehicle is ideal for purely pleasure purposes in which one can select one's own time for a trip, but as an emergency vehicle it is subject to the disadvantages stated.

New Middleweight World's Records.

Joseph Tracy Establishes Figures from Two to Ten Miles at Empire City Track with W. G. Brokaw's Renault.

SATURDAY'S race meet at the Empire City track, near Yonkers, was remarkable in a number of ways. The reputation for well-conducted racing by the best talent and fastest cars in America that has been earned by the management of this track, drew out what is believed to be the largest crowd of spectators that has ever gathered at this or any other track in the metropolitan district to see automobile races. A count of the admission tickets showed more than 10,000 paid admissions. A thorough sprinkling of the track at 11 a.m. and subsequent rolling so effectually laid the dust, without making the surface of the track

of it, to the number of 450. Touring cars vastly predominated, and the majority of these had canopy tops, Cape cart hoods or enclosed bodies.

TRACY BREAKS WORLD'S RECORDS.

Despite the fact that two of the star attractions—Carl Fisher's Premier *Comet* racer and H. L. Bowden's 90-horsepower Mercedes—were unable to compete owing to serious injuries sustained in practicing on the track the day before the races, the competition had remarkable features of its own. Foremost among these was the breaking of world's track records from two miles

which were taken close and without any lessening of speed, the wheels skidding all the way around the big curves.

Much interest centered in the International Cup race, as the novel idea of running the heats off by countries had been adopted. The nations represented were Italy, Germany, United States and France. Only two of the heats could be run off, as there was but one American and one German car to compete. The breaking of the crankshaft of the eight-cylinder air-cooled *Comet* on Friday left the Ford racer to defend the stars and stripes, and the breaking of two cylinders in H. L. Bowden's 90-horsepower Mercedes left E. R. Thomas's 60-horsepower Mercedes as the only German representative. An attempt to improve upon the Cannstatt Daimler construction by boring out the cylinders to increase the power to 100 horsepower had so weakened the cylinders that in a speed trial on the day be-

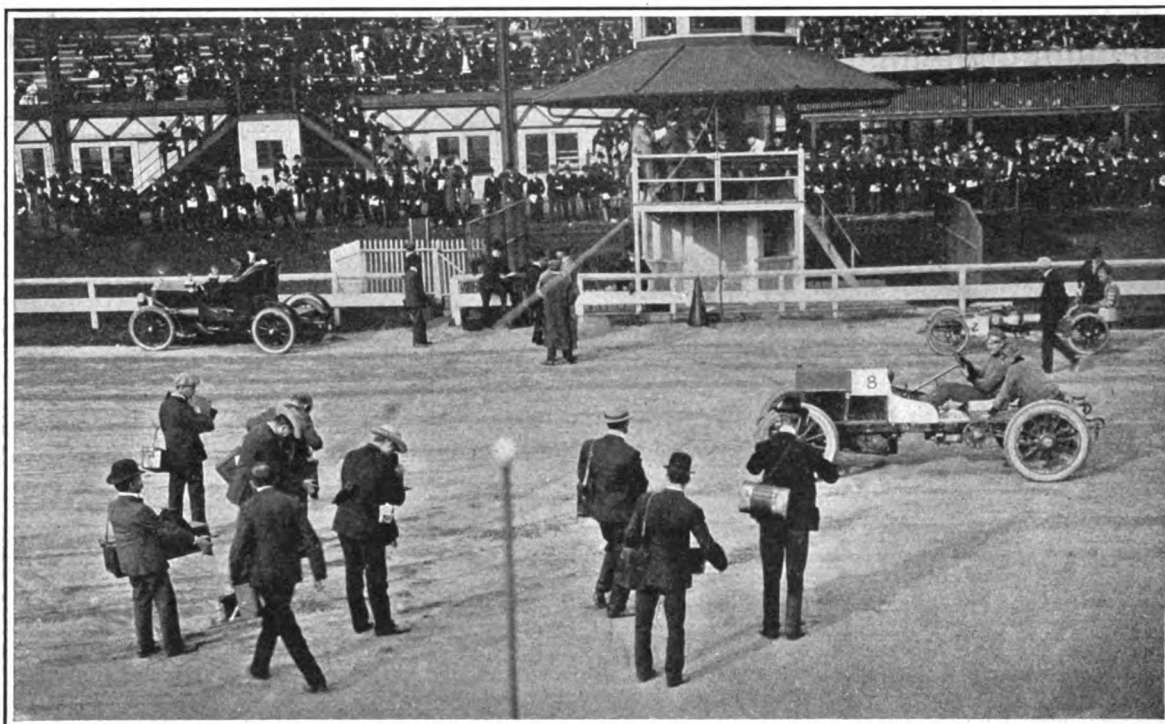

EMPIRE CITY TRACK FROM THE INNER FENCE—Newspaper Photographers "Shooting" E. E. Hawley in E. R. Thomas's Mercedes.

slippery, that at no time during the races did the dust become objectionable to the contestants or dangerous.

The weather was deliciously cool with a moderate wind blowing, the lawn between the grand stand and the track was kept entirely free of spectators and their cars, there were no tedious delays between races and the events were run off in the order of the program. No one was allowed upon the track but the starter, announcer and the newspaper photographers, of which there were on hand the largest number that has ever attended such racing probably anywhere in America, no less than fifteen at a time being seen on the track.

Never before were so many spectators' automobiles gathered at a race meet in America. They were all parked under the grand stand and on the spacious lawn back

to ten miles inclusive by Joseph Tracy with W. Gould Brokaw's Renault in the middle weight class, lowering the records made by M. G. Bernin with the same car on the same track July 18 last. The power of this machine is variously estimated at 30 and 40 horsepower.

Tracy's records were made in the fourth heat of the International Cup race, which he won in a walkover, and in the final of the same race, in which he promptly took the lead from E. E. Hawley in E. R. Thomas's 60-horsepower Mercedes at the start, and steadily increased it during the first four or five miles to an eighth of a mile, at which distance Hawley hung with determination to the end of the ten miles. Tracy's record time was 10:01 2-5, exactly twelve seconds lower than the former record. The time was all saved on the turns,

in which it was said a mile had been done in 54 and a fraction, the two forward cylinders cracked circumferentially clear through the walls immediately above the flange by which they were bolted to the crankcase. Herr Jellineck's design does not leave any superfluous metal at this point. These two accidents caused no little disappointment, as the cars were among the fastest in America, and had in addition to other races been entered in a special pursuit match race at ten miles.

SARTORI WINS THE HANDICAP.

The Great Empire Handicap five-mile race proved a farce owing to excessive handicaps being given the small cars. The first heat was carried off by Paul Sartori, driving a 24-horsepower Fiat, with a handicap of 1 minute 20 seconds; Charles

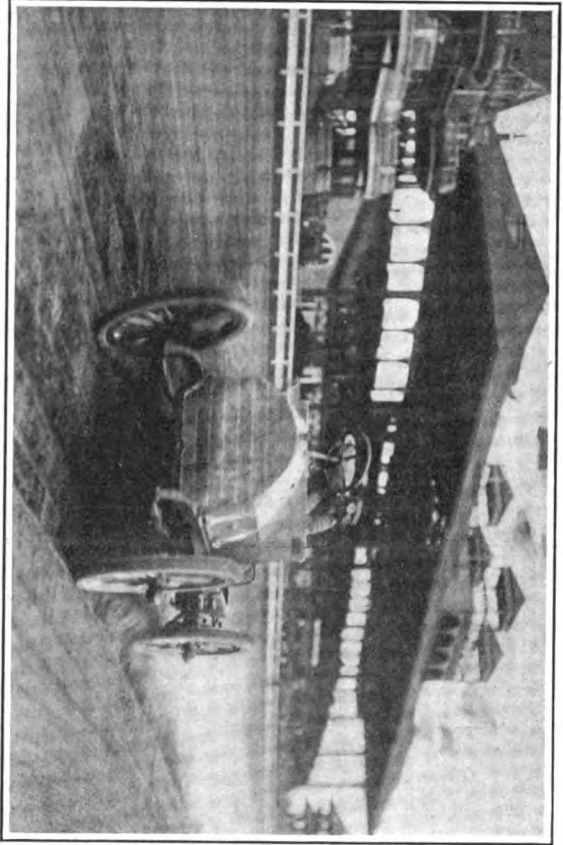

Paul Sartori, Winner Empire City Handicap Slidding on the Turn.

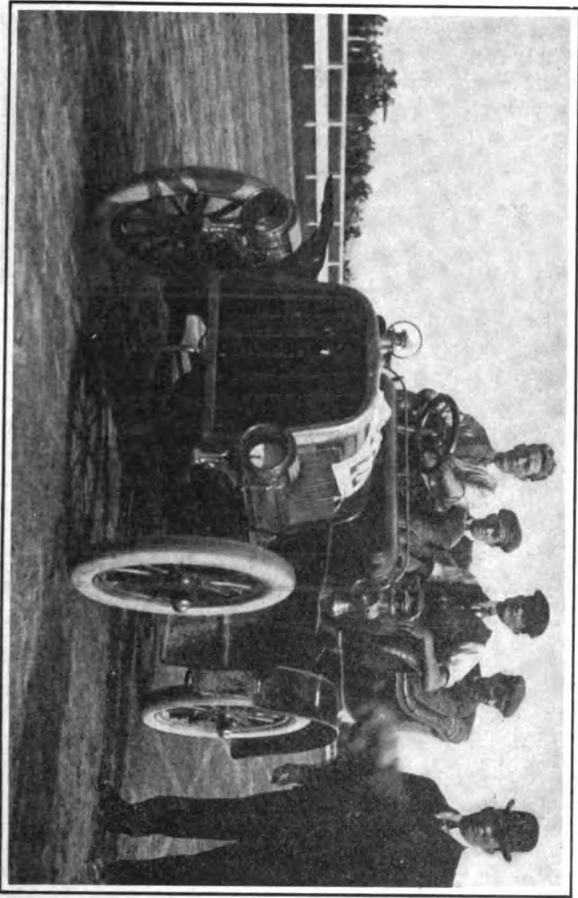

Charles Soules in Pope-Toledo, Winner Five-Mile Touring Car Race.

SNAP SHOTS OF WINNERS AND NOTABLE CARS AT THE RACE MEET AT EMPIRE CITY TRACK YONKERS, SATURDAY, SEPTEMBER 24,

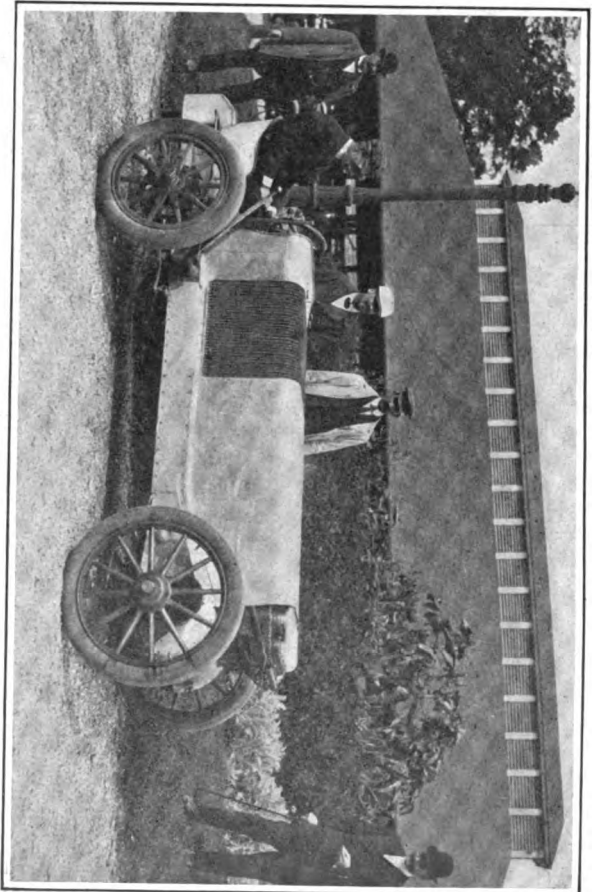

Walter Christie in His New Front-Drive, Front-Steer Racer.

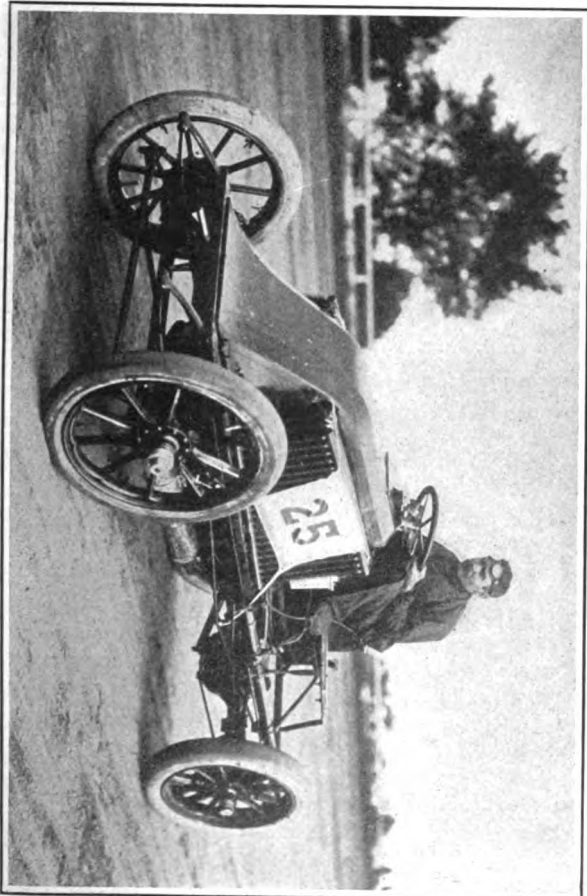

Joseph Tracy, in Brokaw's Renault, Winner International Cup in Record Time.

Soules; Pope-Toledo 24 horsepower, ran second with a handicap of 1:15 and A. E. Morrison, Peerless 24 horsepower, was third with a handicap of 1:15. Joseph Tracy drove the 36-horsepower Royal, which he is to drive in the Vanderbilt Cup race, and although it had not yet been properly tuned up, it showed good speed—insufficient, however, to overcome the big handicaps of the other cars. His handicap was 25 seconds. The second heat was won by A. J. Seaton in a 15-horsepower Buckmobile, with the advantage of a handicap of 4 minutes 16 seconds, which allowed it to make more than a complete circuit of the mile oval before any of the other contestants was sent away from the tape, the starts in all cases being from a standstill at the tape. Tracy, who started in the Renault with a handicap of 8 seconds over

started, by the unexpected way in which it humped up in the middle several times as the result of the sudden pull on the driving chain and the great flexibility of the springs, the action simultaneously striking the on-lookers as most appropriate to the name of the car.

In the final the Renault finished last, in fifth place, while the first prize went to Sartori in the 24-horsepower Fiat in 8:02 1-5. Lee took second with the Pope-Toledo and the Buckmobile third.

TOURING CAR RACE INTERESTING.

The Old Glory Cup race for touring cars developed considerable interest. There were four starters, and each car was required to carry three passengers in addition to the driver, who had to crank his engine, start the car and drive five miles. The interest-



TRACY SKIDDING INTO HOME STRAIGHT.

Among the spectators at the meet were Clarence Gray Dinsmore, representative in Europe for the Automobile Club of America, and G. Heath, winner of the Circuit des Ardennes this year and driver of one of the

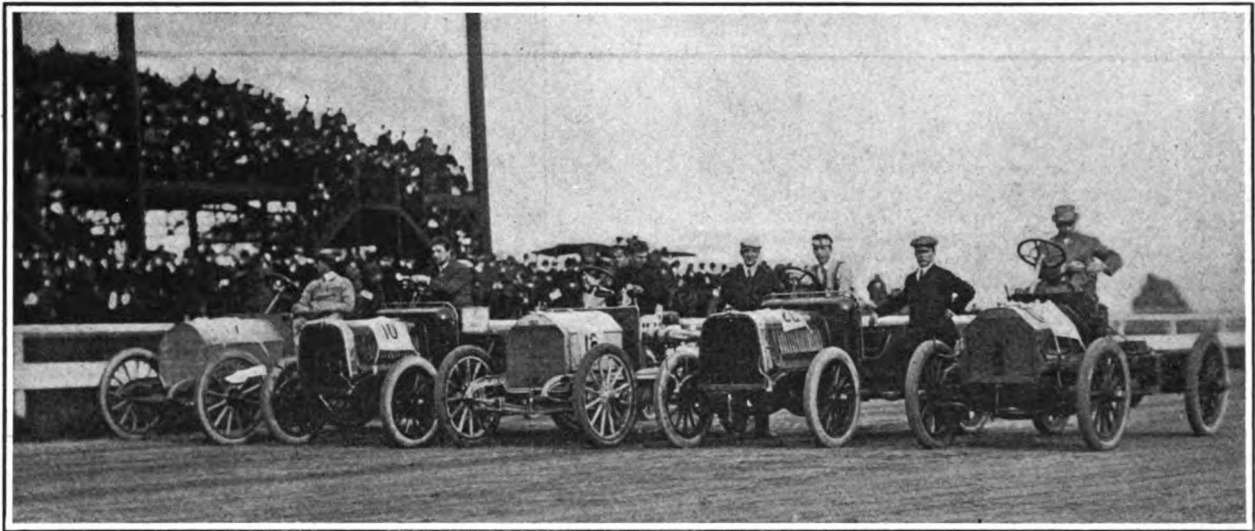

LINE-UP OF BIG CARS FOR THE FIVE-MILE HANDICAP.

Left to Right: Sartori (Fiat 24-hp.), Lee (Pope-Toledo 24-hp.), Wallace (Fiat 24-hp.), Soules (Pope-Toledo 24-hp.), Morrison (Peerless 24-hp.);

Thomas's Mercedes, drove fast enough to put up a new world's record of 5:04 in his class, yet he finished only in third place, A. S. Lee in the Pope-Toledo running second and the Mercedes fourth. The Buckmobile elicited a good-natured laugh, when it

ing feature was the close contest between Charles Soules in the Pope-Toledo and A. E. Morrison in the Peerless. Morrison trailed Soules for several miles only a length back, but Soules won with a lead of forty feet in 7:12 3-5.

Panhards in the forthcoming Vanderbilt Cup.

Following are the summaries of the afternoon's events:

"Yonkers Cup," five miles for regular stock cars selling for \$1,000 or less—Rodney Peeler (Autocar 10-hp.), 1st; R. M. Alexander (Pope-Hartford 10-hp.), 2d; A. J. Seaton (Buckmobile 15-hp.), 3d. Time, 8:15 3-5.

"Old Glory Cup," five miles for American touring cars carrying three adult passengers in addition to operator, driver to crank motor, start car and drive entire distance—Charles Soules (Pope-Toledo 24-hp.), 1st; A. E. Morrison (Peerless 24-hp.), 2d; A. S. Lee (Pope-Toledo 24-hp.), 3d. Time, 7:12 3-5.

"Knickerbocker Cup," ten miles for cars weighing 881 to 1,432 pounds—Joseph Tracy (W. Gould Brokaw's 30-hp. Renault) 1st; Frank Kulick (Ford 20hp.), dropped out end of third mile; H. R. Lounsbury, Jr. (Meteor 30-hp.) dropped out at end of first mile. Time, 10:15.

"International Cup," ten-mile free-for-all, heats run by countries at five-mile distances—First heat, Italy—Paul Sartori (Fiat 24-hp.), 1st; E. K. Wallace (Fiat 24-hp.), 2d. Time, 6:21 4-5. Second heat, Germany—Not run, owing to broken cylinders on H. L. Bowden's 90-hp. Mercedes, given by default to Edward Hawley (E. R. Thomas's 60-hp. Mercedes). Third heat, America—Not run, owing to broken crankshaft on



H. L. BOWDEN'S 90-HP. MERCEDES "FLYING DUTCHMAN," THAT CRACKED TWO CYLINDERS IN PRACTICE ON FRIDAY

Headlights and Night Driving.

By JOSEPH TRACY.

Carl Fisher's 32-hp. Premier racer, given by default to Frank Kulick (Ford 20-hp. racer). Fourth heat, France—Joseph Tracy (Renault 30-hp.), 1st; Felix Troger (M. C. Herrmann's 70-hp. Panhard) quit at three-quarters mile. Time, 5:08 3-5. Times by miles, 1:04, 2:03 2-5, 3:03 2-5, 4:08 4-5, 5:08 3-5.

Final heat, ten miles—Joseph Tracy (Brokaw's 30-hp. Renault), 1st; E. E. Hawley (Thomas's 60-hp. Mercedes), 2d; Paul Sartori (Fiat 24-hp.), 3d. Tracy's time, 10:01 2-5. Times by miles, 1:02 3-5, 2:02 3-5, 3:02, 4:01 3-5, 5:01, 6:01 2-5, 7:01 3-5, 8:02 1-5, 9:02 1-5, 10:01 2-5, all world's records for middle weight cars from two miles up, inclusive, breaking records made by M. G. Bernin with the same car on the same track July 18, 1904. Hawley's time, 10:07 4-5.

"Great Empire Handicap," five-miles—First heat—Paul Sartori (Fiat 24-hp.), handicap 1:20, 1st; Charles Soules (Pope-Toledo 24-hp.), handicap 1:15, 2d; A. E. Morrison (Peerless 24-hp.), handicap 1:15, 3d. Time, 6:10 1-5. Second heat—A. J. Seaton (Buckmobile 15-hp.), handicap 4:16, 1st; A. S. Lee (Pope-Toledo 24-hp.), handicap 1:15, 2d; Joseph Tracy (Renault 30-hp.), handicap :08, 3d. Time, 8:22 3-5.

Final—Paul Sartori (Fiat 24-hp.), 1:20, 1st; A. S. Lee (Pope-Toledo 24-hp.), 1:15, 2d; A. J. Seaton (Buckmobile 15-hp.), 4:16, 3d; Charles Soules (Pope-Toledo 24-hp.), 1:15, 4th; Joseph Tracy (Renault 30-hp.), :08, 5th. Time, 8:02 1-5.

Photos of Dust Clouds.

Special Correspondence.

LIVERPOOL, Sept. 16.—After being postponed several times owing to the weather, the trials of the Dust Committee of the A. C. of Great Britain were held Saturday, September 10, on a private road near Guildford, Surrey. There was not much dust on the road, but flour proved a good substitute. A 24-horsepower Dennis chassis was used and this was fitted in turn with numerous removable bodies. The car was run at a speed of thirty miles an hour over a twenty-yard stretch of flour-strewn road with each body fitted, and photographs were taken of the dust clouds raised. A "standard" cloud was provided by a 10-horsepower Decauville, which patrolled the course at a uniform speed at intervals. More than fifty sets of photographs were obtained, and results of considerable value may be expected from them. The official report will be issued shortly.

DEMONSTRATION FOR COUNCILMEN.

Special Correspondence.

WILMINGTON, Sept. 26.—In order that they might act intelligently upon the proposed automobile ordinance, the members of the City Council were given a ride around the city in automobiles Saturday afternoon, as guests of the Delaware Automobile Association, whose machines were placed at their disposal. The trip included scorching and slow running. The ordinance is in the hands of one of the members of the council and will probably be presented at the meeting next Thursday.

Eighteen automobiles are owned and operated by the residents of Mobile, Ala.

HEADLIGHTS do not make fast night driving safe—they simply make it possible. The exercise of common sense is still necessary in these days of powerful gas lamps for automobiles. On these statements most automobilists are agreed—theoretically. When it comes to their practical application, however, many automobilists forget. Given a combination of skill in driving, presence of mind in emergencies and acetylene lamps, good time can be made on the road at night, but the risk caused by the unexpected remains. This produces far more mental strain and bodily fatigue in driving a given distance at night than would result in covering the same ground in daylight.

Under any circumstances fast driving at night should not be attempted unless the car is equipped with powerful acetylene lights, which are in perfect working order, and, even with such an equipment of lights fast driving should not be attempted unless one is very familiar with the route to be gone over. Many drivers do not fit their lamps properly to the car. To be really effective the lamps should be fixed on the brackets in such a position that when lit the beams of light from them will be practically horizontal when the car is on level ground.

As is very generally known the light from acetylene lamps casts very dark shadows, a characteristic which this light shares with the ordinary electric arc lamp. For this reason a road which is only slightly rough in its surface will appear to be very much more so when viewed by the light from the acetylene lamps. When a driver gets accustomed to this illusion he is likely to become careless and take it for granted that when a road appears very rough, under the beams from the lamps, it is in reality only slightly so. Thus when a stretch of bad road is encountered the driver is likely to make an error of judgment and to attribute the apparent roughness of the road to the peculiar effects of the light and, under the assumption that the road is good, high speed may be maintained until the wheels strike a ridge or hole so forcibly as to bend an axle or break a spring.

In driving at night particular care should be taken in going around turns. A rear end collision with a preceding car is easily possible on a sharp turn, especially if the car ahead does not carry a rear light. A moment's reflection shows that when the car is rounding a curve the headlights will show on the road only for a very short distance ahead, depending entirely on the radius of the curve. It follows as a consequence that if a car or other vehicle is rounding a curve just in front it will not be seen until the following car is very close, so close indeed that it may be practically impossible to stop soon enough to prevent a bad smash up. On dry roads it is usually very easy to tell

when catching up with another car, or horse drawn vehicle, as the dust raised by the vehicle ahead is easily discerned when the beams of the gas lamps fall upon it. It should be an invariable rule to slow down a car when running into dust, and at the same time keep a sharp lookout. It is necessary also when passing a number of teams or wagons going in the same direction to exercise great care, especially when the roads are dusty. Teams and wagons often raise a cloud of dust and when the automobilist is passing through this a horse or unlighted vehicle coming in the opposite direction may be met and a collision result.

In the night time objects do not come into view progressively, as it were, as in the day time. When approaching an object in daylight it first appears small and indistinct, and gradually increases in size as one gets closer. When driving at night, however, with the aid of gas lamps, objects appear to flash into sight suddenly—appearing to leap out of the darkness. The suddenness of this appearance is intensified as the speed of the car is increased.

When driving at night it is "up to" the automobilist to exercise great consideration for other road users. Horses are easily frightened by the dazzling rays from the acetylene lamps. Frequently a horse that is met refuses to go by, and the best thing to do under such circumstances is to stop the car and get out and station a person in front of each lamp, with the body close against the glass so as to cut off all the light rays.

When driving at night it is well to avoid looking at the gas lights on an approaching car, or electric or other brilliant lights on the roadside. The powerful rays of such lights dazzle the eyes and prevent the driver from seeing the road in front. So-called "search lights" are coming into use very extensively. These can be moved by hand so as to throw a beam of light to either side of the road, or above or below the horizontal plane. It seems hardly necessary to say that the driver should not attempt to manipulate a search light, but that it should be handled by another person who will give his entire attention to the lighting of the road. Courteous treatment of other road users, and of residents along the route traversed will confine the use of the search light to its intended purpose of road illumination, and it will not be used to scare inoffensive persons.

Care should also be taken when a car is stopped on a road that it is moved as far to the right as possible so that the glare from the lamps will not annoy drivers of automobiles or horsedrawn vehicles.

Forty automobilists of Racine, Wis., have complied with the city ordinance and have registered their machines with the city clerk.



VOL. XI.

No. 14

Published every Saturday by

THE CLASS JOURNAL CO.,Flatiron Building, Madison Square,
NEW YORK CITY.Cable Address - - - Autoland, New York
Long Distance Telephone - 300 Gramercy, New York**SUBSCRIPTION RATES:**United States, Canada and Mexico, - One Year, \$2.00
Other Countries in Postal Union, - One Year, \$3.00To Subscribers—Do not send money by ordinary mail.
Remit by Draft, Post-Office or Express Money Order,
or Register your letter.**FOREIGN SUBSCRIPTION AGENTS:**ENGLAND:—Iliffe & Sons, Limited, 3 St. Beide Street,
Ludgate Circus, London, E. C.FRANCE:—Boyveau & Chevillet, 22 Rue de la Banque,
Paris.

GERMANY:—A. Seydel, Mohrenstrasse 9, Berlin.

To Advertisers—Copy or changes in orders for advertisements should reach us not later than 5 o'clock p. m. Monday for the issue of Saturday following.

Copyright, 1904, by The Class Journal Company.
Entered at New York, N. Y., as second-class matter.

The Automobile is a consolidation of The Automobile (monthly) and the Motor Review (weekly).

Copies Printed This Issue, - - 12,000

“ “ Since Jan. 1, - 482,000

The American Entries.

One week from to-day the great International road race on Long Island for the William K. Vanderbilt, Jr., Cup will be lost and won. Against great odds, both in the experience of building road-racing cars and in driving them at high speeds on the roads in competition, the American entries will start and endeavor to keep the cup on this side of the Atlantic. Four American owners, in a spirit of pure sportsmanship, have entered five cars in the race. With the possible exception of one machine, none of the cars was constructed with a view of taking part in this or any other long-distance event. The American team includes two Pope-Toledos, entered by Col. Albert A. Pope; the famous *Gray Wolf*, entered by the Packard Motor Car Co.; a Smith & Mabley Simplex, entered by the owner, Frank Croker, of New York, and the Royal Tourist, entered by C. A. Duerr, New York agent of the builders. With the exception of the new and untried Simplex, all of the cars entered have been tried out in track competition, and have made a splendid showing. The strong belief, therefore, of their owners in the merits of these cars, which is shown by their entry in the Cup race, is warranted by excellent past performances, and, barring accidents before or during the race, each ought to do credit

not only to the builders, but to America as a whole, for it is as national champions that the cars enter the race.

The dark horse of the American team is the Smith & Mabley Simplex, the first large car turned out by the builders, who have only recently undertaken the actual construction of automobiles in their own plant. A careful examination of this car, however, shows that in construction it is in the highest class, and the performance of the type of motor with which it is fitted is familiar to those who have followed the season's auto-boat racing.

It is a pleasure to be able to note that while the entrants display confidence in their machines to make a creditable showing, they have not indulged in boastings, and the only gas that each will carry into the race is that which the carbureters can produce. Indeed, both the home and foreign teams display a fine reticence in this particular that is suggestive of good sportsmanship and tremendous effort on the day of the race.

In calling attention to the want of experience of our own representatives in road racing we do not wish to be understood as offering excuses for probable defeat. Each car in the American team will start to do two things: first, to win, and second, to finish. A cold-blooded, unbiased comparison of what each car of the four competing nations brings to the race cannot give to America even a possibility of winning. The chances of the race may upset all calculations, but we seriously doubt if any of our team really wants to win the race by chance. To finish "strong" will be glory enough, and will properly carry with it a tremendous prestige.

In considering the character and number of the American entries the brief history of this cup contest must be taken into account. It was only last spring that the first announcement of the intention to donate such a cup was made. In April it was announced that the race would be held in July, and not until the meeting of the committee on June 7 last was the date finally advanced to October 8. Even then there was no practical certainty that the race would be held, for permission to use the roads in Nassau county was not obtained until August 23, and the consent of the New York municipal authorities to use the portion of the course that lies within their jurisdiction did not come until the middle of September.



There are two points in the Vanderbilt Cup race course which it would seem to be the imperative duty of the A.A.A. racing board to have put in better shape before the day of the race. One is the sharp turn—considerably sharper than a right-angle—from the Massapequa road

into the Bethpage turnpike, near Plain Edge. We have referred to this turn several times in describing the course, and it is without question the most dangerous spot, for the competitors at least, in the entire thirty miles. This is not simply on account of the sharpness of the angle, but because of the narrowness of the road surface and the impossibility of leaving it even for a foot or two, without inviting disaster. Inside the angle is a rough ditch several inches in depth, which comes close to the road and is hidden by grass and weeds. Further inside the angle is a tree. It is impossible to cut the corner, and one must slow down to ten or fifteen miles to make the turn at all. The tree should be cut down, if possible, and, at any rate, the angle should be filled in and leveled close to the tree.

The other danger point is the culvert near the church, in Hyde Park. This culvert, which rises considerably above the road surface, is encountered at the bottom of a little descent, which would almost compel high speed unless anticipated considerably in advance. If any car takes it at racing speed it is hard to foresee any better result than broken springs. It would be perfectly easy, with a load or two of crushed stone, to make this point safe.

**Auto-Boat Season's Lessons.**

On three days last week races for the gold challenge cup of the American Power Boat Association were held on the Hudson River in New York, and practically closed the auto-boat season in home waters. An extensive report of the races will be found elsewhere in our news pages.

In the races the auto-boat *Vingt-et-Un II* was a winner, and by her consistent performances in varying and unfavorable conditions of wind and water added to the reputation she had acquired earlier in the season.

The results of the season just closed, if there be any, are to demonstrate the fact that an auto-boat race cannot be won by motors alone. This seems an obvious fact. It was not sufficiently obvious, however, to prevent the construction of boats in which all considerations of seaworthiness were subordinated to the mere flotation of a powerful motor, with the expectation that somehow, in some mysterious way, the power of the engine would produce forward motion in excess of anything hitherto known, and that in every variation of weather. These boats had their origin in the emotions. Cold reason and scientific fact contributed little to their construction, and the inevitable result was disappointment. It takes more technical training than one would casually suppose to teach the unlearned that in marine con-

struction eccentricity of design, plus ego-tistical disregard of available knowledge, does not total superiority of results.

The perfection of modern design in sailing yachts and steam vessels is the result of a slow and laborious process of evolution. The defender of the *America's Cup* of to-day is a wide departure from the earlier models, and yet an examination of the plans of all the international race contestants will show a gradual progress of design, rather than any sensational change from the old to the new.

A sound motor in a sensible hull is the combination that will give a consistent performance, and will in the long run bring credit to all concerned. No fancies of inventors, nor whittled-out-rule-of-thumb models can hope to outclass the thoroughly considered plans from the board of the trained designer.

There are tremendous difficulties in the problem, to reconcile all the varying and conflicting components. Every successful boat is a compromise, and the secret of its success is the nicety of balance of the various elements of design.

Some of the chief faults of the season of 1904 include: Boats without flare at the bows that are speedy in smooth water, but are compelled to slow down in rough weather. Hulls with long overhang at the bow, which represents so much dead weight and adds nothing to the effective water-line length. Boats with little freeboard and open cockpits fore and aft, or with the most flimsy and unseamanlike covers that do not keep out the spray, not to speak of green water. Boats overpowered and lacking in stiffness of hull. These and other minor defects are almost the rule, rather than the exception.

It is some consolation, perhaps, that faults such as referred to are not confined to boats of domestic build, but that many such have been turned out abroad. Owners and builders have been too ambitious. For the sake of the future of this most interesting sport it is to be hoped that owners will begin to appreciate that the automobile engineer must collaborate with the naval architect to produce the results they desire.



Reports of the races at Providence, R. I., held September 10, gave the distance of the exhibition ride by Tom Fetch in the Packard 1,000-mile non-stop car as three miles, whereas it should have been five miles. The time was 6:43 2-5, which figures out at 1:23 2-5 to the mile for a regular 24-horse-power touring car.

Ethan Sly and wife went through on the crossroad east of Blue Fly Sunday with their automobile, after a call on Charlés Stacey, the first to pass through with an auto.—*Norwalk (O.) Chronicle*.

KANSAS CITY LICENSES.

Examiners Will Not Grant Them to Inexperienced Drivers After October 4.

Special Correspondence.

KANSAS CITY, Sept. 26.—Kansas City motorists may scorch until October 4. On that day the board of examiners provided for in the ordinance passed September 3 will hold its first formal meeting, and devise methods to torture the driver who would secure a license.

The motorist must have four qualifications before he can drive his car on Kansas City streets. These are "skill," "experience," "capacity" and "sobriety." Members of the board do not explain how they are to reconcile a man's capacity with sobriety, but they think they can. Also they do not know how a man is to get experience without driving his car, yet they will not let him drive unless he has experience.

"The whole thing looks something like the story of the girl who wanted to go swimming," said Mayor Neff, after a conference with Louis Curtiss, a member of the board. "She did not want to go into the water until she had learned to swim."

After October 4, the board is to meet the first Wednesday of each month. Arrests are to begin after the first meeting, unless some motorist enjoins the city from enforcing the ordinance until a test case brought by Fred. Patee is decided. An injunction is spoken of in some quarters.

The fight between Kansas City authorities and the local motorists over the enforcement of the automobile ordinance began last Wednesday, when Fred Patee, manager of the local Cadillac Automobile Company, was fined \$10 in Central Police Court on charges of violating the ordinance. It was alleged that Patee had driven his car in excess of twelve miles an hour; that he had carried no lights at night; that he failed to heed the signal of a driver whose horse he is said to have frightened, and refused to give his name after the accident; that he carried no license number; that he ran abreast of another automobile for five blocks and that he had not appeared before the board of automobile examiners to establish his fitness to operate a car.

As the board of examiners has had no regular meeting since the passage of the ordinance, September 3, and has examined no motorists, it seems that the city has overreached itself in this last particular.

Patee has given notice of an appeal and declares that he will fight the case in order to determine whether or not the city has the right to make onerous restrictions on motorists. The license feature, especially, will be attacked.

CROSS COUNTRY RUN.

Conditions Governing Unique Contest of Philadelphia Club Members.

Special Correspondence.

PHILADELPHIA, Sept. 26.—The conditions which will govern next Saturday's second annual "Cross-Country Run" of the A. C. of Philadelphia are as follows:

1.—The contest is open for members of the Automobile Club of Philadelphia only. 2.—Competing machines must be run by members, except that a member engaged in the automobile trade and not personally owning a machine may operate the machine that he is in the custom of running. 3.—The run is open to all classes of motor vehicles. 4.—Cars must be in full touring trim, and carry the maximum number of passengers that it is designed to carry. 5.—

The winner to be the member making the trip from this city to Ambler, to Phœnixville, to Westchester, to City Hall (Philadelphia) in the shortest time. 6.—The route to be selected by the member. 7.—The event is not to be a race, and members must obey the requirements of the city and the State laws in every way, and for this reason any competitor violating the law will forfeit his right to win the cup.

The course is about seventy-six miles in length, and the start will be made from the new Bellevue-Stratford Hotel about 9:30 a.m. Rule No. 6 allows the contestant to select any of the several routes between controls, but he must report and be timed at Hotel Ambler, Ambler; Hotel Columbia, Phœnixville; Mansion House, West Chester, and at the finish at City Hall. An hour will be allowed for luncheon at Phœnixville, but contestants must have time of departure therefrom marked on their cards.

O. H. Chadbourne, who won the cup last year and now holds it, announces his intention of defending his title to the mug.

The event, being open to cars of all types and powers, is of course a handicap, but allowance will not be known by contestants until after the run is finished.

ENGINEER'S RUN TO ARDSLEY.

Novel Plan of A. L. A. M. for Acquiring Intimate Knowledge of Cars.

The engineers and mechanical superintendents of the automobile manufacturing concerns who are members of the Association of Licensed Automobile Manufacturers will hold a meeting in New York on October 7, the main object of which will be the formation of a society for the free interchange of ideas on the automobile manufacturing matters, and a rather novel arrangement will be carried out. Each company sending representatives will send one or two gasoline cars for the transportation of the members of the party, which will probably number about seventy-five. Thirty cars have been booked for the occasion.

The party will rendezvous at the Locomobile garage, Broadway and Seventy-sixth street, at 9 o'clock in the morning, and a run will be made up Riverside Drive to Van Cortlandt Park, Yonkers, Irvington and Ardsley, where luncheon will be served at the Ardsley Club, the party being the guests of some of the members. Afterwards the trip will be continued through White Plains to Travers Island, where the New York Athletic Club will entertain the members of the party. The return trip to New York will then be continued, and an informal dinner will be partaken of at the Casino, Central Park, at 6 o'clock. During the run the visitors will change about, and each man will ride in as many different cars as possible, so as to become more thoroughly acquainted with the results of his fellow-manufacturers' efforts. At the dinner in the evening the matter of forming a mechanical branch of the association will be discussed, the object of which will be mutual benefit and the general improvement of automobile manufacturing methods. If the proposed organization should be successfully launched, it is expected that its efforts will be concentrated mainly on decreasing the cost of operation and maintenance of motor vehicles, endeavoring to improve the tire situation and, as far as possible, standardizing automobile parts. The members of the association are said to have taken kindly to the idea and to be anxious to help it along as much as possible.

Attorney S. H. Watson is the first citizen of Lodi, Wis., to own an automobile.

CURRENT NEWS FROM NEW YORK.

The 24-horsepower Fiat car driven by Paul Sartori at last Saturday's race meet at the Empire track, Yonkers, was a brand new car, just imported. It was taken from the customs house by Hollander & Tange-man at 12 o'clock Saturday, two hours before the hour scheduled for the races to start, the tonneau and touring equipment were removed, the tanks filled and the motor started. The car was then driven directly to the track. William Wallace, who will drive a 90-horsepower Fiat in the Vanderbilt Cup race, drove the machine around the track after the conclusion of the races.

* * *

The fall tour of the Automobile Club of America is an assured fact, says Emerson Brooks, chairman of the A. C. A. Touring Committee. The replies received from members to whom notices were sent have been most encouraging, and if only half of those who have declared their intention of making the trip actually start and carry it through the tour will be a success.

* * *

Automobile speeding on Broadway between Twenty-fourth street and Central Park is being held in check by special work on the part of the police. Besides the regular bicycle squad, a policeman mounted on a motorcycle has been placed on night duty on that stretch of asphalt, but the warning sounded by Commissioner McAdoo, to the effect that all scorchers would be taken in at sight, seems to have been so effective that the "auto-catchers" have had a rather tame time of it.

* * *

The non-appearance of Jockey Tod Sloan as a racing chauffeur at the race meet at Yonkers last Saturday was caused by the arrest of that young man for speeding on Fifty-ninth street, New York. He was on his way to the races in his 40-horsepower Decauville, when the police got him. He arrived at the track later, having left his machine as bail for his appearance.

* * *

An automobile was put to good use recently when R. H. Stearn, manager of the Hotel Navarre, New York, while driving his car, saw a young man drink from a bottle of poison and fall to the ground in the Bronx. Mr. Stearn immediately took the would-be suicide into his car and made a fast run to the nearest police station, 2 1-2 miles away, where doctors were telephoned for. The young man was taken to a hospital. At last reports he was in a serious condition.

* * *

The Automobile Club of New Jersey met on the evening of September 22 and plans were made for holding its annual Eagle Rock hill-climbing contest on Thanksgiving Day. The classification of cars will be the same as last year—by prices—and special events for racing cars will be added to the programme. The growth of the club has made it necessary to secure regular quarters, and accordingly rooms have been secured on the corner of Railroad and Harrison streets, Brick Church, N. J., close to a large garage. The courtesies and privileges of the club will be extended to all visiting automobilists.

* * *

Among the recent purchasers of Fiat cars, through Hollander & Tange-man, New York agents, is A. Hartuppe McKee, of Pittsburg, Pa., who has placed an order for one to cost \$16,500 delivered in New York. The car is of the Berline de Voyage type, the body of which is ten feet in length and entirely enclosed, and has a seating capacity for nine persons. The seats on either side are so arranged that they can be made into

sleeping berths for long-distance travelling. Mr. McKee expects to use the car for European touring.

* * *

As an offset to the many remarks made regarding the unseaworthiness, unreliability, frailty and intricacy of the modern auto-boat, Smith & Mabley have issued a list of the events in which their boat, *Vingt-et-Un II.*, has taken part since June 11 of this year. It shows a total of eight victories for the season.

* * *

E. J. Willis has established an automobile exchange at 17 Park Place, New York, where Orient buckboards and tonneaus will be carried in stock and automobiles of all kinds be bought, sold and exchanged. The premises extend through the block from Park Place to Murray Street. Below the street floor are two other floors, which will be used for storage, and, later on, for a garage in which cars will be taken for "live" or "dead" storage. Work is now in progress to adapt the place to its new use, and a large freight elevator is being installed to connect the three floors.

* * *

Homan & Schultz, Broadway and Thirty-eighth street, Manhattan, have added to their automobile line the Marion car, built by the Marion Motor Car Co., of Marion, Ind. A machine for demonstration purposes is now being shown at their establishment.

NEWS AND TRADE MISCELLANY.

The Consolidated Supply Company, of Denver, announces that it will remove from the present location to 1562 Broadway, Denver, on October 1. This move will place the concern right in the automobile district.

A. L. Dyke, formerly of the A. L. Dyke Auto Supply Company, St. Louis, Mo., has sold his interest in that concern and entered the automobile supply business on his own account, being temporarily located at 311 Pines street.

Henry Merrill, of the Kansas City Automobile Company, has leased a building one block south of his present quarters in McGee street for a term of five years. He will handle the White and the Rambler exclusively next season. He has already sold three 1905 Whites.

The License and Orders Committee of the Board of Supervisors at San Francisco decided on September 22 to recommend that the fares for public livery automobiles carrying not more than four persons be fixed at \$3 for the first hour, or fraction of an hour, and \$1 for each subsequent half-hour or fraction thereof.

The Peerless Motor Car Company will probably carry out its long-talked-of plan of erecting a large factory in Cleveland. Plans for this factory were prepared last year, but at the last moment it was decided to delay the matter another year. The company has a site at the corner of the Nickel Plate Railway and Quincy street, a short distance from the present plant, and it is stated that contracts for the buildings are to be let at once.

In all probability the Baker Motor Vehicle Company will have a new plant for next season. At the time the factory of the American Ball Bearing Company was built on the outskirts of the West End of the city the Baker company bought property adjoining that of the other company, which is owned by the same interests. It is probable that both factories will be pushed to early completion.

Postmaster Hibbard, of Boston, has invited bids of automobile owners for the contracts for transporting the mails between the central post office and the different railway stations, all bids to be in the hands of the Assistant Postmaster General, Washington, D. C., by December 1. Heretofore this service has been performed only by horse-drawn vehicles. The contracts are for a period of four years, dating from July 1, 1905.

The Bretton Woods, N. H., "Perfection" automobile tour is scheduled to come to a conclusion Saturday, October 1, with a banquet at the Mount Pleasant Hotel. Touring parties from New York, Boston, Providence, Springfield and Hartford were organized. A number of speakers, prominent in automobile affairs, are expected to be at the banquet. Among these are Winthrop E. Scarritt, Col. Albert A. Pope, and Samuel A. Miles.

With numerous accessions to the entry list from among the contestants at the Empire City Track races last Saturday, Secretary H. D. Le Cato, of the Motor Power Association of Philadelphia, announces well-filled events for next Saturday's meet at Point Breeze. The track will be scraped and sprinkled sufficiently to abate the dust nuisance without rendering it slippery. A number of local owners of fast cars will enter the amateur events.

The Michigan Automobile Company, Ltd., of Kalamazoo, reports that overtime work is necessary to keep up with orders. Its Model D light touring car is reported to be selling well. Agencies for this machine have been established with W. H. Whitesell & Co., 604 S. Broadway, Los Angeles, Cal.; Electric Supply Co., 309 Bull St., Savannah, Ga.; H. D. Clark, Jr., & Co., 217 E. 15th St., Kansas City, Mo.; and the Newark Automobile Co., cor. Wright and Brunswick Streets, Newark, N. J.

A 90-horsepower racing automobile is to be built by the Locomobile Company of America for Dr. Harold E. Thomas, of Chicago, at a cost of \$18,000. A four-cylinder 16-horsepower gasoline Locomobile, which Dr. Thomas has been using this season, impressed him so favorably that he ordered a 30-35-horsepower limousine car and a racing machine. The latter, which will resemble in its general features the regular Locomobile touring car, is to be built from designs by A. L. Riker, and is the first purely racing gasoline car built by this company. The Locomobile Company states that it will not enter the racing field, and that anything done in this line will be by customers on their own account.

Instead of handling all sales through the main office, as heretofore, the Winton Motor Carriage Company has decided to divide the country into districts to be handled from the branch houses. All sales will go through the branches, and the branch managers will appoint agents in their territory. The company now has branch stores in New York, Boston, Philadelphia, Cleveland, Chicago and London, and it is the intention to establish several other branch houses whose locations have not yet been decided upon. It is understood that two, and perhaps three, Winton models will be built for the season of 1905, one of them to be a four-cylinder car to sell at a less price than the Winton cars of the past two or three years.

THE AUTOMOBILE

WEEKLY

NEW YORK—SATURDAY, OCTOBER 8, 1904—CHICAGO

10 CENTS

VANDERBILT CUP RACERS READY TO START.

THE order of starting the contestants in the Vanderbilt Cup race was decided by drawing lots last Saturday evening, October 1, at the rooms of the Automobile Club of America. In order to make the drawing as fair as possible, a somewhat peculiar method was adopted.

established, and folded slips were drawn from a hat in the good old-fashioned way, most of the entrants showing a good deal more indifference than they probably felt. It was noticeable that no matter what number a man drew, he managed to find something in its favor—either he was placed be-

parent predominance of foreigners. A casual visitor might easily have taken it for a French affair, with a scattering of English-speaking men. Among the foreigners were Teste and Tarte, the Panhard drivers; Clement, the "baby driver"; Bernin, W. Gould Brokaw's chauffeur; Ga-

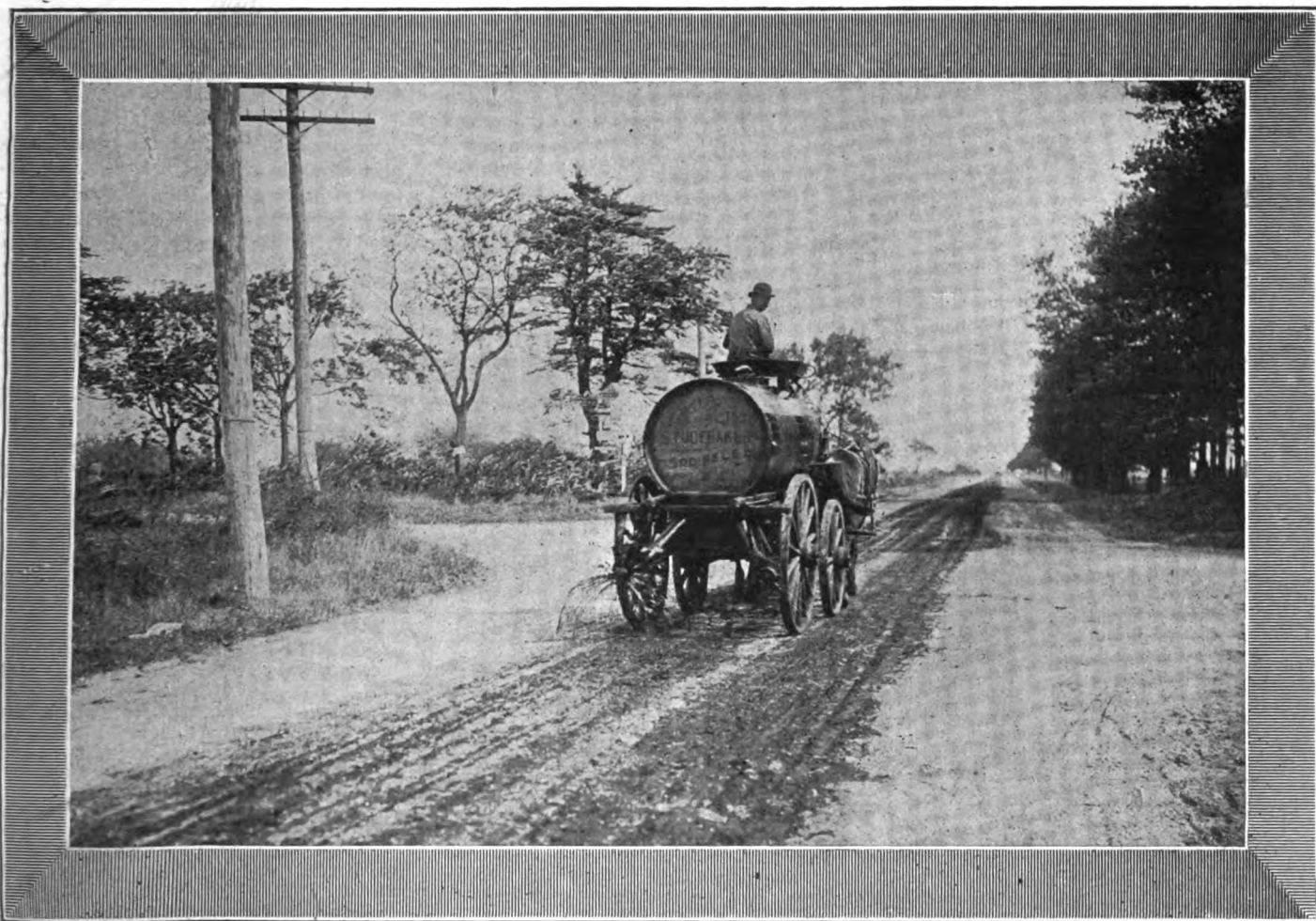

ONE OF THE SPRINKLING CARTS OILING THE VANDERBILT CUP COURSE ON LONG ISLAND WITH CRUDE PETROLEUM.

which gave general satisfaction. The first man to draw is usually supposed to stand the best chance of getting the best number—though he might also be said to have the best chance of getting the worst—and a preliminary drawing was therefore held to determine the order of the final drawing. The men were called up in the order thus

hind a fast car that would keep him busy, or behind a slow one that he expected to overtake, or near a friend. No one drew No. 13, because there was no No. 13 to draw, the "hoodoo" number having been omitted. The list on the following page gives the order of starting.

A feature of the gathering was the ap-

briel, who comes across the ocean to drive a De Dietrich; M. Voigt, of the firm of Charron, Girardot & Voigt; Baron de Turckheim and Paul Sartori. The English-speaking automobilists were apparently more at home speaking French and Italian than were the foreigners in speaking English, and comparatively little of the

ORDER AND STARTING TIMES OF THE CONTESTANTS.

No.	Nationality.	Car.	H.P.	Driver.	Starting time, a.m.
1.	German	Mercedes	60	Campbell	6:00
2.	French	De Dietrich	80	Gabriel	6:02
3.	American	Royal Tourist	35	Tracy	6:04
4.	American	Pope-Toledo	60	Webb	6:06
5.	German	Mercedes	60	Arents	6:08
6.	American	Pope-Toledo	24	Lyttle	6:10
7.	French	Panhard	90	Heath	6:12
8.	German	Mercedes	60	Hawley	6:14
9.	German	Mercedes	90	Werner	6:16
10.	Italian	F.I.A.T.	90	Sartori	6:18
11.	French	Renault	60	Bernin	6:20
12.	French	Clement-Bayard	80	Clement	6:22
14.	French	Panhard	90	Tarte	6:24
15.	French	Panhard	90	Teste	6:26
16.	American	Packard	30	Schmidt	6:28
17.	American	S. & M. Simplex	75	Croker	6:30
18.	German	Mercedes	60	Wormser	6:32
19.	Italian	F.I.A.T.	90	Wallace	6:34

Note.—There is no Number 13 in the race.

latter language was near. One of the most conspicuous figures was Heath, very tall, slender, and, though an American, decidedly English in appearance, with nothing to suggest the daring driver. Up to Saturday evening Mr. Heath had not succeeded in getting his Panhard racing car out of the hands of the customs officials. "I have been extremely busy trying to get my car out," he said, "but so far have not yet got it. I have been over the course in a touring car many times, making myself familiar with the conditions of the road."

Mr. Heath thinks the course fairly good, though far from ideal. Replying to a question as to how far it favored his car, he said: "It would be much better for me if there were a few comparatively stiff grades. The power of my machine is so great that an ordinary hill makes little or no difference in speed, and gives me an opportunity to pull away from others, who have, perhaps, less power to spare. I do not expect to have an opportunity to let out my car to its utmost."

When asked what average speed the winning car would, in his opinion, attain, Mr. Heath was slow to reply, taking a long time to consider the possibilities. "It is very hard to say," he replied finally; "but I suppose 60 miles an hour will be about the highest speed that can be expected. I should not be surprised if it was considerably less than that. I have heard that some estimates have placed the winner's average speed at not over 45 miles an hour; but I don't think any such speed could win the race. It's altogether too slow, and, it seems to me, the course will allow of better work. When it comes to comparing the Long Island course with the European courses, however, the American one must suffer greatly. The Race Commission is to be congratulated on having found a course at all; and, after all, it is not so very bad;

but it is very different indeed from the courses on the other side. I do not look for any serious accidents, though of course it is impossible to guess what may happen. I, for one, am not looking for any trouble. However, by the time we have made ten rounds of the course we will all know a great deal more about it than we do now." And Mr. Heath smiled down from his six feet several inches and said good-night.

Ten times around the course will make the total distance, exclusive of the neutral ground in the controls, 284.41 miles which the racers must cover.

The last obstruction to the holding of the Vanderbilt Cup Race disappeared when the antagonistic faction, which had circulated an anti-race petition and threatened an injunction, failed to make out a semblance of a case at the public hearing held at the Mineola County Court-house, on Tuesday, October 4. Vague rumors of an

injunction continued to float around for some days after the hearing, but soon died a natural death. In the meantime the final preparations for the great event were carried on without interruption, and though there was a good deal to be done at the last moment, the officials on the ground, who forsook business for the time and devoted all their energies to race work, disposed of each case as it came up. One determination arrived at only after much serious consideration was that the Truffault suspension, a device for absorbing shocks caused by inequalities of the road, could not be used unless made in the same country as the car to which it was applied. Absolutely every part of a car must be made in the same country as the car itself, and an American machine may not even carry a tool of French manufacture.

An important decision arrived at by the Race Commission, and one that is without

Official Instructions Issued to Drivers and Judges in the Vanderbilt Cup Race by the "Commission for 1904."

INSTRUCTIONS TO OPERATORS.

1. Keep to the right when being overtaken.
2. Keep to the left when overtaking.
3. Give due warning of your approach, by horn or trumpet.
4. Motor exhausts *must not* be directed toward the ground.
5. Stop on the tape when entering a control.
6. Start, standing, from tape when leaving a control.
7. No supplies of oil, water, fuel, or batteries can be taken on board while in control.
8. No repairs to tires, cars, or equipment can be made while in control.
9. Start from standstill.
10. Finish at speed.
11. Numbers will be drawn Saturday, October 1, 1904, at 8 p.m., at the rooms of the A. A. A., 753 Fifth avenue, N. Y.
12. At the time numbers are drawn, the assignments of instant of start will be made. Your time will be taken from that instant whether you start or not (see Condition 21).

COMMISSION FOR 1904.

INSTRUCTIONS TO MOUNTED JUDGES AND CHECKERS.

1. Cover your patrol station in both directions.
2. Watch carefully that the barricaded highways are not used.
3. Check on your card each car as it passes each time.
4. Keep well out of the way of the contestants.
5. At the conclusion of the race, go to the nearest turn, telephone the Judges, and when instructed collect from the Judges at turns their reports, seeing that they are signed, and the location given.
6. Go to the nearest control station, telephone the Judges, and when instructed, collect from the Timers and Judges at control stations their reports, seeing that they are duly signed by the proper officials.
7. At the earliest moment, after collecting these reports, proceed with expedition to the Garden City Hotel, and deliver all reports (your own Judges, at turn, and Timers' and Judges') to the Chairman of the Racing Board at the Board's headquarters.

COMMISSION FOR 1904.

INSTRUCTION FOR JUDGES AT CONTROLS.

1. Keep in close touch with the official timers, one at the entrance, and one at the exit.
2. Allow no supplies to be put on board while in control. No repairs to tires, cars or equipment allowed.
3. See that a pilot accompanies (precedes) each car.
4. See that competitors follow the pilots from entrance to exit.
5. See that timer's card is deposited in time check box before the car leaves the control.
6. See that the card is signed by both timers before it is deposited.
7. Make sure that no equipment is discarded while in control.
8. Report promptly to the Referee, by telephone, any irregularity, or accident to car or operator.
9. Have time of arrival and departure immediately reported, by telephone, to the scorers at the starting line.
10. Cars must come to dead stop at entrance (take time then).
11. Cars must start (standing—from tape) from exit. COMMISSION FOR 1904.

precedent in the annals of road racing of this class, is that contestants will be permitted to have all the assistance they want in making repairs, either to tires or the mechanism of their cars, as long as the work is done outside of controls. If a car breaks down within the limits of a control the driver and his mechanic may push it out of the control, have it towed out or get it out any way they can, and if the car cannot be moved without making repairs, the necessary work may be done inside the control, and the time so occupied will be included in the running time

ing the control entrance and poured into the tanks while passing through the neutralized sections.

Another decision of the Commission, and one that has given much satisfaction to the contestants, is that there will be two tapes at each control entrance, 25 feet apart, between which the cars must come to a stop. It was originally intended to require the cars to stop with the front wheels on the single tape that was to have marked the control entrance. The evident difficulty of making anything like such an accurate stop under the circumstances led the Commis-

the word "Go." If the car fails to start through any derangement of the motive power, it will be pushed across the line and to one side of the road, out of the way, and its time taken as if it had started promptly. As soon as the first car is out of the way the second will be brought to the line, and about the same time the third will be notified to be in readiness; and so on through the list. A car, if unable to start at its time, may, after going to the line, delay starting until after the last machine has gone, but will, of course, be timed as having started according to sched-



Werner at the Wheel of C. G. Dinsmore's 90-H.P. Mercedes.

Bernin at the Wheel of W. G. Brokaw's 60-H.P. Renault Cup Racer

Clarence Gray Dinsmore, well known on Both Sides of the Atlantic.

William Wallace in the Driver's Seat of his 90-H.P. F.I.A.T.

Isidor Wormser Steering his 60-H.P. Mercedes.

OWNERS AND DRIVERS OF FRENCH, GERMAN AND ITALIAN ENTRIES IN THE 1904 VANDERBILT CUP RACE.

of the car. In other words, the time of the car will be taken from the time it should leave the control, whether it actually does so or not. A smashed wheel, a broken cylinder, or other important part, cannot, however, be replaced either in or out of control limits; neither will it be permissible to change wheels in cases of tire trouble. While supplies may not actually be taken on board while passing through control, cans of gasoline and lubricating oil may be picked up before reach-

sion to make the new arrangement. The same thing was done at the controls in the Irish Gordon Bennett course, and worked well.

The first car, which will start at 6 o'clock, will be notified at 5 minutes before 6, as it stands at the head of the line near the starting point, that in five minutes it will receive the word. About two minutes before the time it will be called to the line, and when the timer's watch shows the right instant the starter, C. H. Gillette, will give

ule. Associated with C. H. Gillette, the starter, will be Emerson Brooks, George Farrington, R. E. Morrell and M. M. Belding, Jr., who will have the cars in charge just previous to their going into the hands of the starter. If necessary, a fifth official will be added. Messrs. Riker and Birdsall, the official weighers, who will have sealed the cars after weighing them, will be on hand to see that their seals are intact, and no car will be permitted to start if the seal is not perfect.

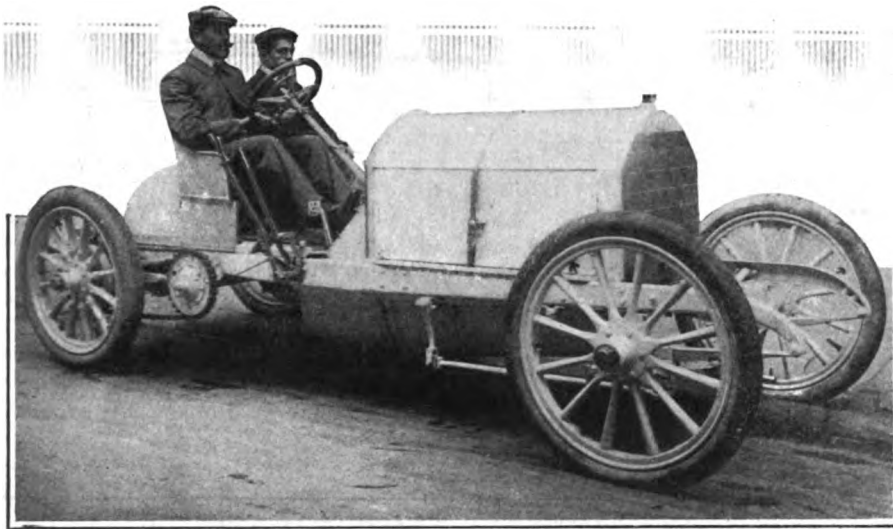

SARTORI AT THE TILLER OF ALFRED G. VANDERBILT'S 90-H.P. FIAT CUP RACER.

The small illustration herewith shows the construction of the record box each car will carry. The one on the right, with the cover raised, was used in the Paris-Madrid road race; the other is one of those made in New York for the Vanderbilt Cup Race. It will be seen by reference to the photograph that the boxes have two hinged portions. The smaller one is a tapered chute through which the cards are to be dropped, and the larger outer one is a cover held in position by a strong snap and protecting the contents of the box from rain and dust. The inner hinged portion may be sealed, when closed, by passing a cord or wire through the two little rings provided for the purpose and sealing the ends together. The strong, heavy leather strap which passes around the body of the box is to attach it to the car. The French box is of a dull slaty gray, while the American copies are of burnished copper. These boxes will be locked at the last moment, so that there will be no chance of the insertion of anything before the car comes to the starting line, and they will remain locked until opened by the judges after the contest.

The boxes and seats in the grand stand having all been taken up a week before the race, several private individuals of an enterprising turn of mind have erected stands at Mineola and on the Hempstead turnpike. A number of the racing cars went over the course on the Sunday preceding the race, and two slight mishaps occurred. Frank Croker, while driving his 75-horsepower Smith & Mabley Simplex, twisted a transmission shaft and had to be towed to his garage. A new shaft was inserted in place of the damaged one, however, and the car was very soon in running order again. A broken chain compelled Wallace's Fiat to take a tow, and led to a report that the machine had been badly smashed.

The Race Commission has not found it possible to make such arrangements with the Long Island Railroad officials as to ensure for the racers absolute immunity from delays by passing trains. Trains will en-

deavor to cross the road only when it is clear, being guided by the signal men placed at such crossings; but it may be that delays will occur, and if so nothing can be done except to grin and bear it. "It is the

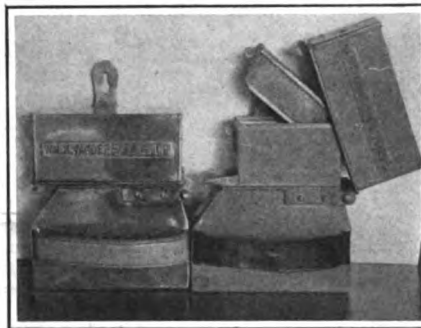

FRENCH AND AMERICAN RECORD BOXES.

fortune of war," as Chairman Pardington expressed it. It is quite possible, however, that no trouble whatever will be experienced from this source, and it is certain that the railroad employees will do all in

their power to avoid unnecessary loss of time.

The trains of the Long Island Railroad will run as usual on the day of the race; but in addition to the regular service there will be two special trains to take spectators and officials to and from Westbury. The regular schedule has already been published in THE AUTOMOBILE.

In response to an enquiry the Special Passenger Agent of the Long Island Railroad said: "The passenger train service on the day of the race will remain absolutely unchanged except for two special trains. One of these will leave the 34th street ferry at 4:30 a.m., and Long Island City at 4:45 a.m., while the other will leave Westbury 30 minutes after the finish of the race."

A regrettable and fatal accident occurred on the course on Monday, October 3. Lytle was driving the 24-horsepower Pope-Toledo entry over the Massapequa road at a moderate speed, as eye-witnesses testified, when a steering knuckle broke as he was turning out for a wagon, causing the car to swerve into the ditch and strike the fence. Lytle was uninjured. With him were C. A. Anderson and Harold Rigby, who were thrown out. Anderson was somewhat bruised and scratched, but escaped serious injury; but Rigby struck the dashboard and broke three ribs, one of them penetrating his left lung. He was removed in an unconscious condition to a hospital, where he died the next day without having regained consciousness. The coroner decided that no one was to blame, and that an inquest was unnecessary.

The car, which was at first reported to have been badly wrecked, was not seriously injured, and was put in running condition within a couple of days.

After the accident Chairman Pardington issued an order that every automobile entered for the race must, when running around the course, carry its official number for identification in case of speeding.

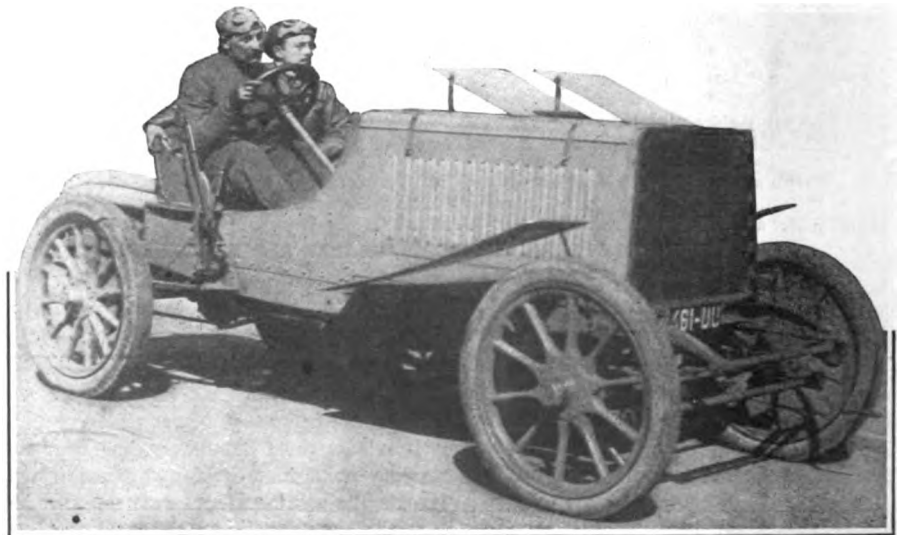

TESTE AT THE WHEEL OF ONE OF THE 90-H.P. PANHARD CUP RACERS.

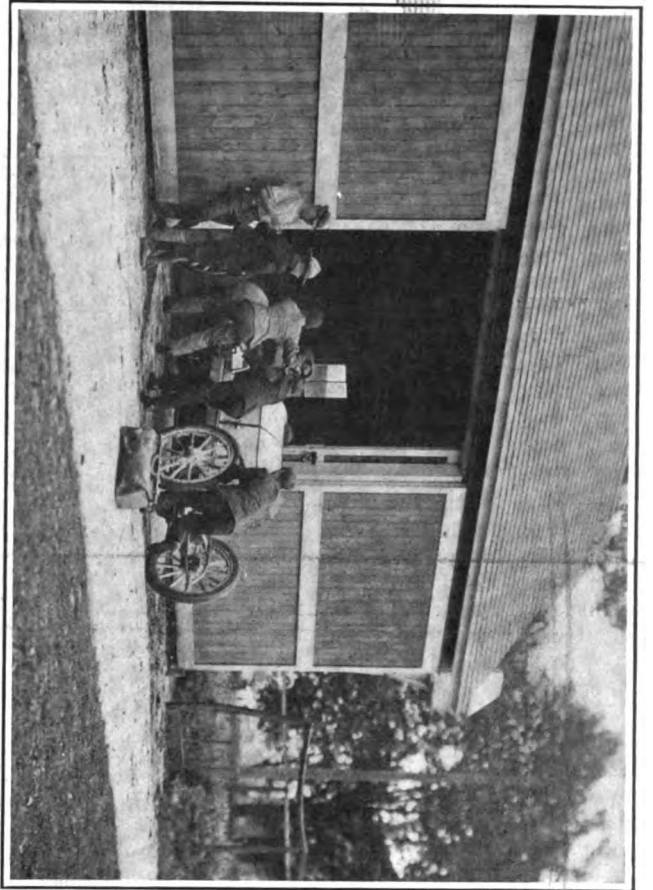

Housing One of the Big Racers at a Garden City Garage.

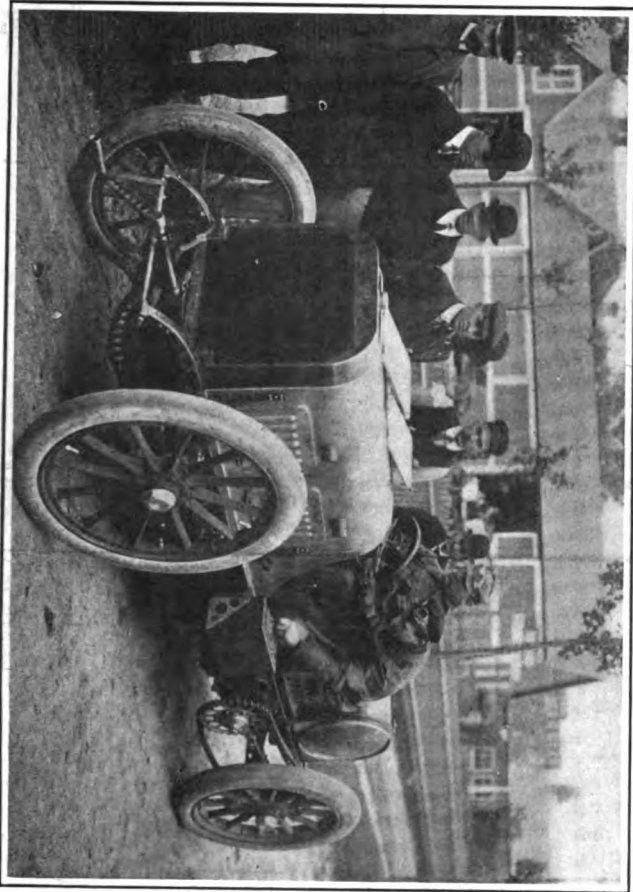

An American Entry—Frank Coker's 75-H.P. Smith & Mabbey Simplex.
SNAP SHOTS TAKEN DURING THE WEEK ALONG THE ROUTE OF THE WILLIAM K. VANDERBILT, JR., CUP COURSE IN MASSAU COUNTY, LONG ISLAND.

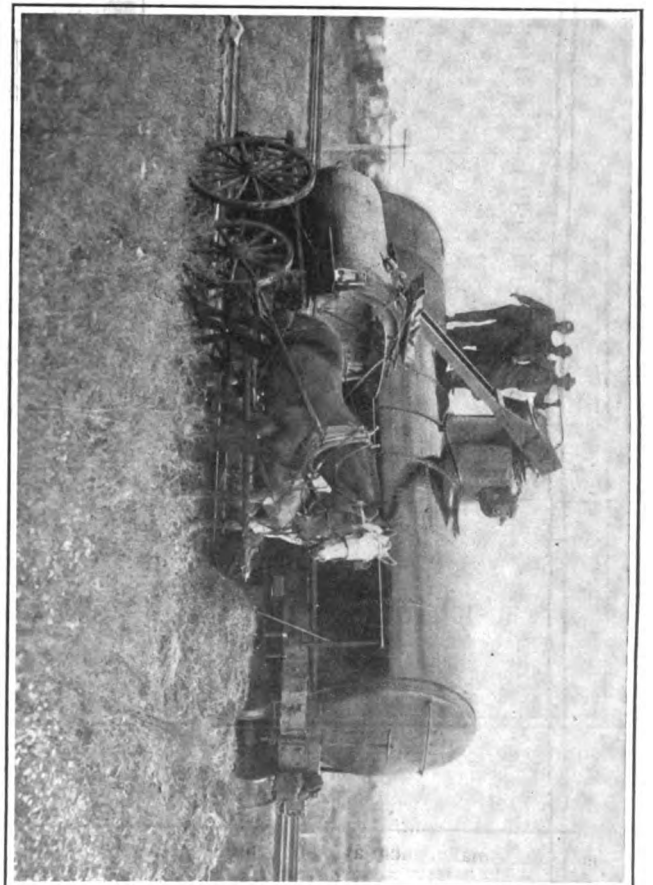

Pumping Crude Oil from a Tank Car into One of the Sprinkling Carts

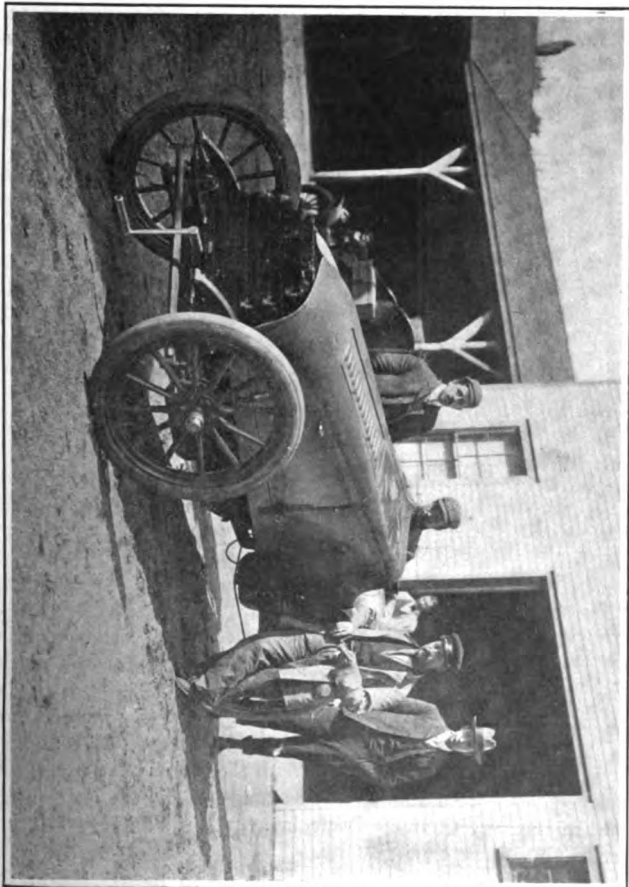

A French Entry—Albert Clement Jr.'s 80-H.P. Clement Bayard.
SNAP SHOTS TAKEN DURING THE WEEK ALONG THE ROUTE OF THE WILLIAM K. VANDERBILT, JR., CUP COURSE IN MASSAU COUNTY, LONG ISLAND.

Gathered on the Cup Course.

Special Correspondence.

GARDEN CITY, LONG ISLAND, Oct. 5.— Although the arrangements for the Vanderbilt Race leave much to be desired on the score of utility, they are the best which could be made by the Racing Commission with the funds at their command, and with the organization which exists. It is, however, unfortunate that so many details are left until the eleventh hour. Things which in Ireland and Germany were established months before the race are left unsettled three days before this race is to start. The starter and clerk of the course have not been heard from by the contestants, and no complete list of the officials has been forthcoming.

Road conditions are also an open question at practically the eve of the event. A hundred men are at work on the course, but there is much criticism of the methods pursued. In some instances, notably on the Bethpage road stretch, the sod and sand are thrown directly upon the top of small stones, which may be expected to work up and cause trouble later on. One reach of bad road near Queens and in the city limits of New York cannot be repaired, though there are some bad holes, and only a moderate speed can be attempted. This is due to the opposition of the city authorities who have refused to allow either the association or private individuals to carry out repairs. Mr. Dinsmore sent word that he would be willing to send men and carts to the spot at his own expense, but was notified that if he did so the workers would be arrested.

Until the arrival of the Chairman, the only member of the Racing Board on the

Mr. Wallace refused to take the statements of those who had the story at second hand, and sent for Lyttle, whom he questioned

The effect of this order, with the distribution of the numbers to the men, has been to put the drivers in the limelight of public opinion, and to make them fear that some of the opponents of the race will report them by number if they violate the rights of citizens along the course. The

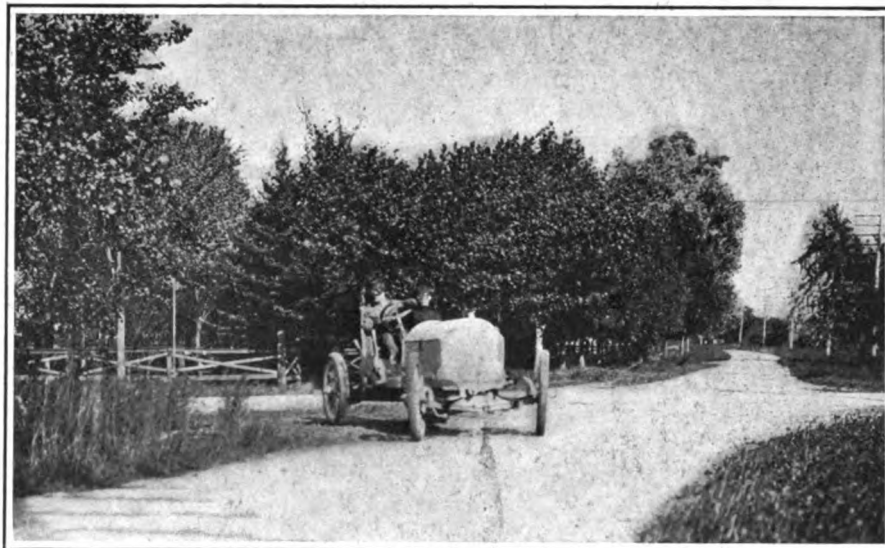

WALLACE'S F. I. A. T. PRACTISING ON THE COURSE—TURNING THE BETHPAGE CORNER.

closely, insisting on having the story from a man who was in the car.

The Racing Board removed its office to the Garden City Hotel on Wednesday, and Chairman Pardington will hold sway there until the close of the race. The Committee has taken a large room in the basement of the hotel. This is likely to be a scene of much activity for a day or two.

All the drivers are taking it easy during the last few days of the week, and are in training. Some of them are keeping up

Board has threatened disqualification for those who override the order.

In personality, there is a wide range of traits among the drivers. Some are nerveless, while others act as if they would get strongly excited on occasion. The tallest of the contingent is Heath, but Werner and Schmidt are also large men, Werner being the heaviest of the drivers in this race. Most of the men are short. Wallace, Clement, Gabriel, Webb, Lyttle, and Stevens are all little men, with more or less of the little man's ambition to overcome the obstacles Nature has placed in his way. All are young. The oldest is not over 38, and the youngest is Clement, who is but 22 years of age.

The only one of the racing machines which was not being put through active work to-day was the car of Isador Wormser. The last cars to arrive were the Brokaw Renault and the Thomas Mercedes. The Panhard cars went to a hotel known as Sammis's, at Hempstead, on Tuesday, and Heath, Tarte and Teste took up their quarters at the same spot. Clement's machine is at Mineola, while Gabriel has his De Dietrich at the Jericho Hotel. The Fiats are at Porrier's, on the border line of Hempstead and Garden City, and Croker's Simplex is at the same station. Dinsmore's and Werner's Mercedes are at the place of George L. Hubbell, in Garden City. Arents's and Stevens' Mercedes are at the Garden City Garage. The two Pope-Toledos and the Packard *Gray Wolf* are at Krug's road-house, at Jericho road and Mineola avenue. The Royal is at Garden City.

The race is to be started at 6 o'clock, and the last starter, Wallace, will have a

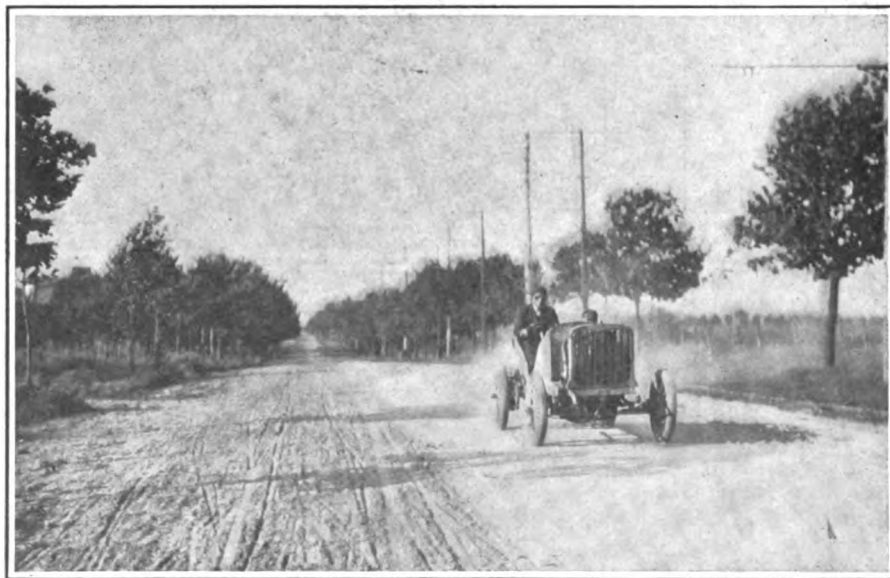

WEBB, TUNING UP THE 60-H. P. POPE-TOLEDO ON A LONG ISLAND ROAD.

ground was Mr. Wallace. His most important problem so far has been a consideration of the accident to Lyttle's car, by which Harold Rigby received fatal injuries and C. A. Anderson was badly shaken up.

their practice on the road, but the zeal for speed has been taken out of them by Chairman Pardington's order to place their numbers on the cars at once and to observe the speed laws scrupulously.

The provision for allowing as many helpers as desired to assist in replacing tires or making repairs will have a good effect in allowing manufacturers to make proper garage arrangements along the course. The racer, it goes without saying, has to make the repairs on his own running time.

As a result of this condition, the tire companies and manufacturers have established points along the course where they will erect tents and have their trained repair men. The Diamond Tire people will have five of these stands, and at each station a man will stand on guard with tires in his hands. Others will have pails of water ready to dash over the tires as the racers stop for a moment. This, it is hoped, will prevent much trouble from tire-heating. The Mercedes Company representatives, Allen and Halle, will have three stations, just at the finish of the controls and at the Jericho turn, and at each of these stations are to place six men. They have even gone so far as to have rehearsals of the mechanics, in order to have it perfectly understood by each man what he is expected to do.

Only a single "No," uttered in an undecided voice, was heard when a vote of confidence in the Board of Supervisors of Nassau County was proposed at the conclusion of the public hearing, held at the County court house in Mineola on October 4, when the residents who had for a week been circulating a petition protesting against the use of the roads for the race were given an opportunity to state their case. A vigorous protest was anticipated, but the explanations made and the good intentions voiced by the

vague and sweeping denunciations of the automobile; and the other composed of a more cool-headed class of citizens who had a grievance and who clearly stated it. Their complaint was due to two causes; one the

only concession made being the temporary suspension of the speed regulations for the space of nine hours on October 8. The public was not warned off the highway, but informed that the race would take place at the

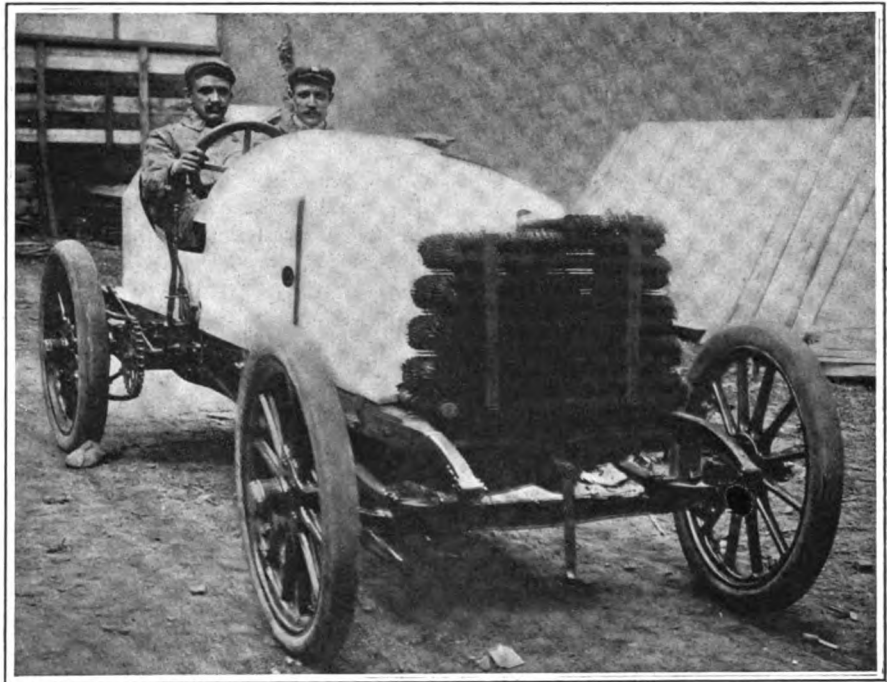

GABRIEL IN THE DRIVER'S SEAT OF THE 80-H. P. DE DIETRICH CUP RACER.

insufficiently clear wording of the A.A.A. placards concerning the use of the roads by the racing cars, which gave these residents the impression that the roads were, for the time being, given over wholly to the racers

time stated, and cautioned against getting into danger. The complaint that high speed was being indulged in caused Mr. Pardington to issue an order that the racing machines should carry their official numbers



CLEMENT'S RACER PARTLY SUNK IN A MUD HOLE ON HOFFMAN BOULEVARD ON THE WAY FROM NEW YORK TO THE VANDERBILT CUP COURSE ON LONG ISLAND.—THIS DANGEROUS SPOT IS ON THE RIGHT OF THE ROAD GOING OUT, AND IS NOW MARKED BY STAKES, AND RED LIGHTS AT NIGHT.

automobilists averted disastrous consequences.

There seemed to be two classes of anti-automobilists at the hearing; one, made up chiefly of members of the Citizens' Protective Association, who devoted themselves to

to the exclusion of all else, and the other the constant speeding of automobiles over the course previous to the day of the race. In reply to these complaints, it was explained that there had been no intention of giving the roads to the automobilists, the

when on the course, so that identification would be easy in case of excessive speeding, when disqualification would follow. The explanation of the debatable wording of the placards and the belated arrangement for the identification of Google rac-

ers had the effect of satisfying the protesters, most of whom joined in the vote of confidence in the Board of Supervisors proposed at the conclusion of the hearing, and carried with practical unanimity.

The Citizens' Protective Association allowed more than a month to pass after the Supervisors granted the A.A.A. permission to use the roads for the race, before its members raised their voices in protest, and permitted the A.A.A. to spend a considerable sum of money on improving the roads. The petition circulated by the opposition at the last moment was signed by some 230 persons; but it was openly charged at the hearing that many of the signatures were obtained by questionable methods. Inquiries made among a large number of residents in the vicinity of the course indicated that a large majority were strongly in favor of the race. Several long petitions, signed by residents along the route, were

Preparations for Timing the Race.

Special Correspondence.

Boston, Oct. 3.—Boston's famous Chronograph Club, which earned a reputation for skill and accuracy in the timing of bicycle and other sporting events, and which has often been called upon to time automobile races and hill-climbing contests, is making preparations to snap the watches upon the competitors in the Vanderbilt Cup international contest October 8. This being the first big automobile road race in this country, the club members have some novel work before them, but as they have taken time for almost every sort of competition they anticipate no trouble with the flying automobiles.

The experience which was gained by the Chronograph Club members in the timing of the Mt. Washington hill-climbing con-

what progress is being made and when and in what order the machines are to be expected. All the watches will, of course, be synchronized, and it is expected that better results can be obtained by means of watches and telephones than by any electrical apparatus yet devised.

The arrangements for timing have been made by correspondence, but on Thursday of this week the timers will leave this city for the scene of the race. Those who will go from Boston are Messrs. Harry and Arthur Knights, J. J. Fecitt, J. C. Kerrison, Charles E. Fay, George H. Lowe and Frank A. Ross. The other representative of the club has not been decided upon. It may be found desirable to have more than eight men on the course. If it is, others can be

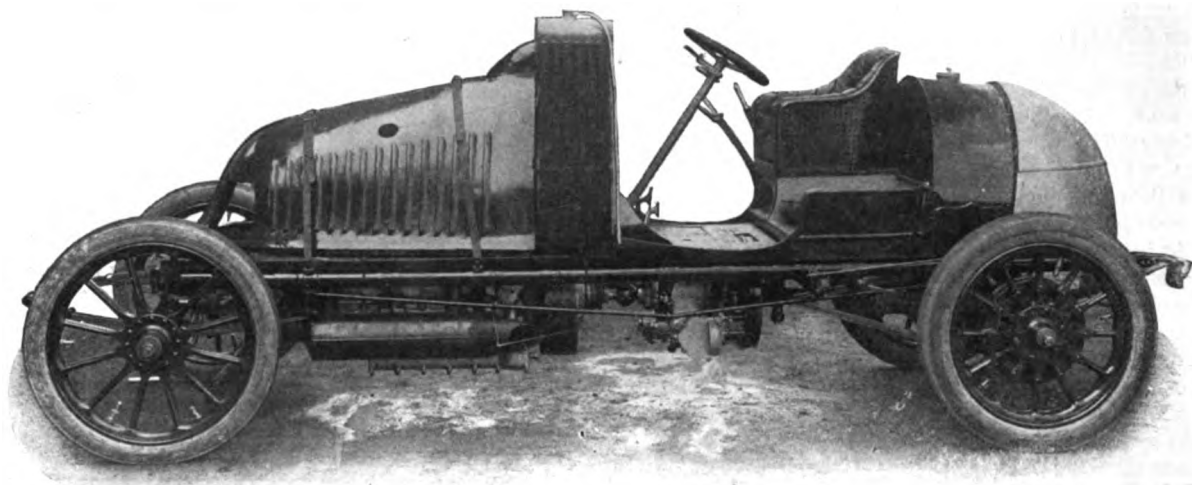

W. G. BROKAW'S 60-HP. RENAULT CUP RACER—FIRST "BIG" CAR TURNED OUT BY THE FAMOUS FRENCH HOUSE OF RENAULT FRERES.

presented to the board in favoring the holding of the race.

A. C. A. BANQUET TO FOREIGN DRIVERS.

The foreign drivers who will participate in the Vanderbilt Cup race will be entertained at a smoker at the rooms of the Automobile Club of America, 753 Fifth Avenue, New York, on Tuesday evening, October 11. Besides the drivers, all the prominent automobilists who are here to see the race will be asked to be present, and a jolly, informal evening will be spent—probably in a verbal re-running of the race.

Albert Clement had an unpleasant experience while making his first trip to the course in his Clement-Bayard racer. While running along the Hoffman Boulevard at moderate speed, he turned too far to one side of the road to pass a vehicle, and the outer wheels of his car sank in a soft spot, completely stalling the machine. Although no damage was done, it was found necessary to secure horses to haul the helpless racer out of the mud.

test last July stands them in good stead for the road race, for at the hill climbing the telephone played an important part in the work. At Long Island the telephone will also be important. Though the plans are not fully worked out, the club is of the opinion at the present time that eight men can do the work. Arrangements have been made with Chairman Pardington, of the Race Commission, for lines of telephone wire leading from the beginning and end of both the controls to the start and finish. Each of these lines will be separate so that there will be no chance of anybody breaking in upon the line while the observer at one control is sending a report to the starter.

There will be four timers at the starting and finishing line, to give the competitors the time for starting, and to record their times as they rush past the grand stand on each round of the course. The other four members of the club will be stationed, one at the entrance of each control and one at the exit of each. In this manner absolutely accurate time of the competitors while covering the course can be ascertained, and the reports to headquarters will show just

called in from New York, where some of the club members reside. Friday the club will try the telephones and see that everything is in perfect order to handle the race on Saturday. One thing the club has insisted upon, and that is entire independence. The timers desired to be free from interference in their work, and this immunity has been guaranteed them by the Commission. In the evening, after the race, the tabulations of each member of the club who has had a part in the timing will be compared, and the official results announced.

A luncheon was given Wednesday to Gabriel, the French crack, who will drive a De Dietrich car in the Vanderbilt cup race Saturday, by R. E. Jarridge. Among the speakers were Baron Turckheim, vice-president of the De Dietrich company, R. E. Jarridge, and Gabriel.

The first automobile ever owned in Golden City, Mo., arrived here last week, and our good-looking lumberman, Clyde Burch, is the possessor of the same.—*Golden City Herald.*

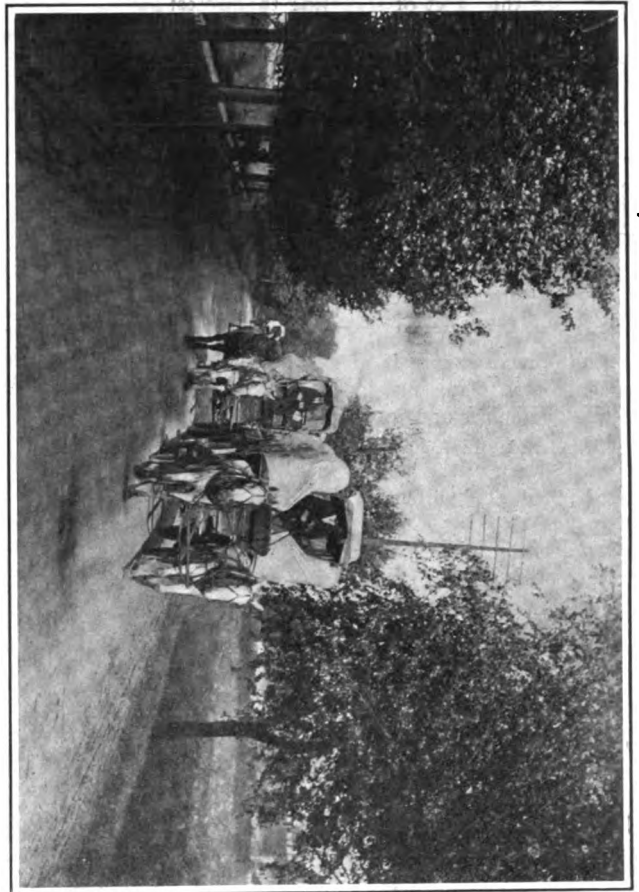

Heavily Laden Truck Farm Wagons on Their Way to the New York Market.

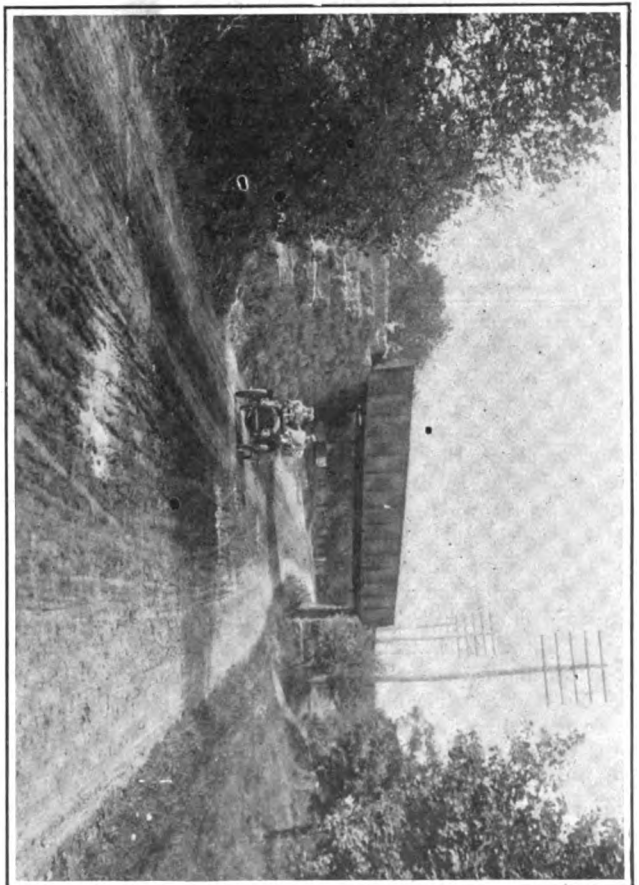

Looking East on the Jericho Turnpike at the Railway Viaduct in Floral Park.

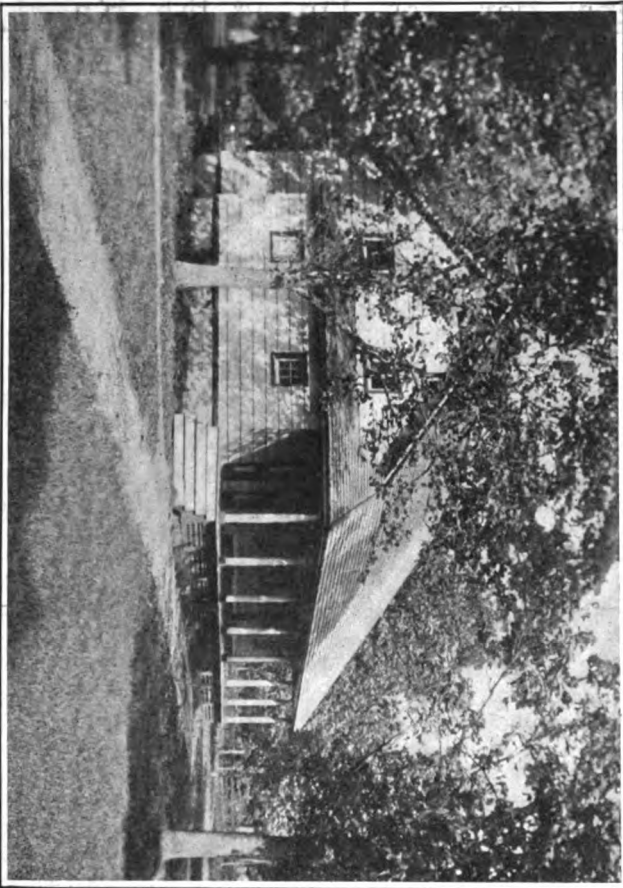

Westbury Quaker Meeting House at Original Location of Grandstand. STUDIES IN STILL LIFE AND MOTION PICTURES MADE BY THE CAMERA ON THE COURSE OF THE VANDERBILT CUP RACE AND IN ITS VICINITY.

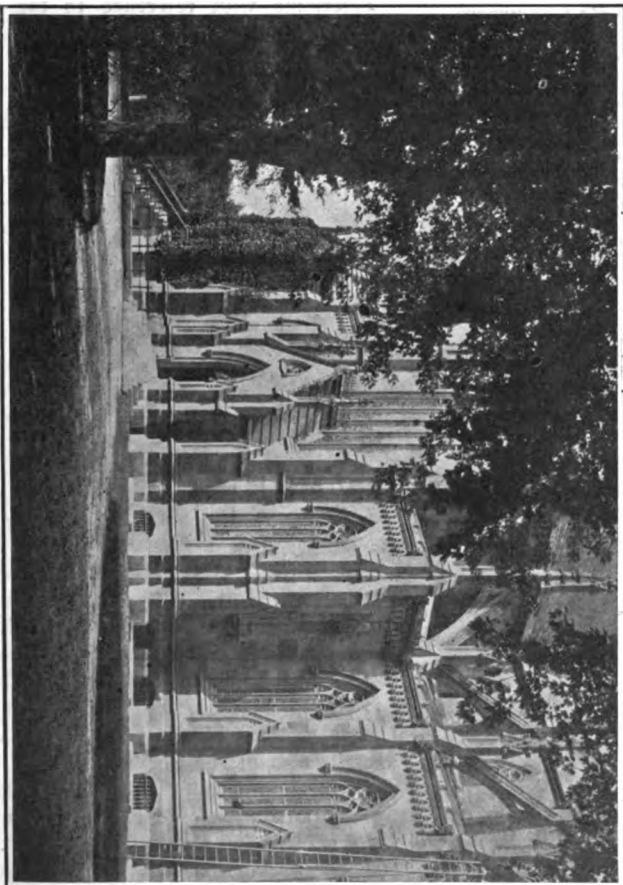

Gothic Architecture of the Episcopal Cathedral at Garden City—A. T. Stewart Memorial.

Problem of the ^{INDEX} Auto Boat.—III.*

Elements of Hull Design and Powering Discussed for the Benefit of Intending Purchasers and Users.

BY WILLIAM F. DURAND MEMBER OF COUNCIL S. N. A. & M. E.

ABOVE WATER FORM.

THE above water form of a high-speed boat should be determined by reference to three main considerations. (1) Air resistance; (2) General utility; (3) Appearance.

AIR RESISTANCE NOT NEGLIGIBLE.

While air resistance is of much less importance than water resistance, it is by no means negligible, and in a field of design, where everything must be subordinated to the attainment of the highest speed, no item can be neglected, attention to which may react favorably on the main purpose in view. In a general way forms favorable with respect to air resistance are as nearly as possible smooth and continuous, with the minimum amount of abrupt change or flat head surface. A standing awning as an unnecessary addition to the boat proper is not, of course, to be thought of for a moment in a boat intended for high speed. All standing constructions with any considerable amount of head surface, such, for example, as a pilot or deck house, should also be avoided. It should be remembered that the general type of form conducive to low water resistance will also be conducive to low air resistance; and while it is hardly practicable to give to the above water form the same character as that below water, nevertheless the fact should be borne in mind that the closer we may be able to approach to this condition the less will be the air resistance and the less the loss in attainable speed due to this cause. It may be of interest to note the ideal above water form which would thus comport best with the requirement of minimum air resistance in absolutely quiet water. This would show in general a turtle-back type of construction, covered completely over and sloping down to join the body of the boat as nearly as possible at the water plane surface. In side view it would therefore show a gently arched line rising gradually from the water at the bow to a maximum amidships, sloping down very easily and gradually to the water again at the stern. In transverse section likewise the general view would show a gently arched form rising from the water line at each side to a maximum at the center line and adjusting itself in general character to the fore and aft form. The steersman would needs be provided with optical means for making out his course, while means for light and air in general are further details which need not be considered in connection with such an ideal.

The chief purpose in noting such a form is to show the ideal entirely unmodified by considerations relating to utility, appearance or roughness of water. Habitability

and general utility with such boats require an open cockpit, and also some freeboard for safety. Nevertheless, the general turtle-back form has met with favor with some designers, and in skillful hands and as modified by other conditions, it may be made to yield a form not displeasing to the eye, and at the same time conducive to the minimum air resistance at high speeds.

REGARDING GENERAL UTILITY.

Regarding general utility and appearance, but little need be said in the present general connection. The flat stern with its broader water plane, as noted in the previous article,** gives a more roomy boat and is favorable to general utility and safety. Appearance is largely a matter of taste and convention, and it must be accepted as a fundamental principle that in a boat intended for the highest speed, considerations of utility and appearance must be made subordinate to those having relation to the attainment of the principal purpose in view. It by no means follows, however, that the fast boat need necessarily be ugly. The skillful designer will be able to combine forms which please the eye in such manner as to fulfill also the leading technical requirements for minimum resistance and maximum speed.

SEAWORTHINESS TO BE CONSIDERED.

A further point must also be kept in view in this connection. The form which may be the best under the ideal conditions of absolutely quiet water may fall far short of such realization under the average weather conditions with which such boats must contend. The form of the boat must therefore be determined with due reference to seaworthiness under such general conditions of weather and water as are liable to be encountered.

In connection with the turtle-back form referred to in the foregoing, one precaution may be here noted regarding the dip down at the bow. This, for ideally quiet water, should come practically to the water surface in the running condition, as already noted. Practically, however, this would result in running with the nose partially under water for a good part of the time, and when running into a wave of any size the tendency would be to pull the nose down and to dive deeper still. This would mean a very wet boat forward, and a very serious retardation in speed due to the added water resistance. While, therefore, the turtle-back form for the bow is favorable to reduced air resistance and to a quick shedding of water should a wave break aboard, yet its height should be such as to lift it above the reach of the ordinary small waves, and in any event to avoid the likelihood of nosing

into the water under the average weather conditions liable to be encountered.

INSTALLATION OF MACHINERY.

Our remarks on this point will have reference chiefly to matters relating to resistance and speed rather than to the machinery itself or its installation in technical detail.

The location of the engine may influence resistance and speed chiefly through its effect on trim and on the inclination of the propeller shaft. The subject of trim has been referred to in the preceding article, and it constitutes a point of serious importance. There is no doubt that many an otherwise good boat has been badly handicapped by a poor adjustment of trim in the running condition. With the relatively large amount of weight represented by the motor of the auto-boat, its location will have a most important influence on the resulting trim, and it should therefore receive special consideration from this point of view.

In most gasoline motor boats of the common pleasure type it has been customary to place the engine well aft, in order to give the maximum clear seating capacity forward of the machinery. All such boats as a rule trim by the stern when at rest, a condition still further aggravated when under way, by the operation of the hydraulic forces which are then brought into play. In the high-speed boat the location of the machinery should be determined without reference to matters of seating capacity, and it should be placed more nearly amidships and in such location as computation and judgment may determine with reference to the realization of the desired trim when running at top speed.

DIP OF PROPELLER SHAFT.

A further consequence of the location of the engine in the after part of the boat is the more or less pronounced dip which must be given to the propeller shaft in order to secure the necessary immersion of the propeller, and at the same time bring the engine fly-wheel clear of the boat structure. This obliquity of the shaft is in itself a direct source of loss of efficiency in the operation of the propeller, and it should therefore be reduced to a minimum. This consideration likewise points to a location of the machinery well toward amidships, thus bringing down the obliquity of the shaft, and placing the propeller in a position to operate without serious loss of efficiency.

STRICT ATTENTION TO DETAILS.

In regard to the general installation of the machinery it will be sufficient for present purposes to urge the importance of the most scrupulous attention to details, especially in connection with the gasoline tanks, piping, etc. The matter of free exhaust must also not be overlooked. An effective muffler is, of course, a desirable feature in an ordinary purpose boat, or in any boat when used for runabout purposes. It must not be forgotten, however, that the exhaust cannot be effectively muffled without some increase in back pressure, with a corre-

*Continued from page 332, issue of Sept. 17, 1904.

**See issue of September 17.

sponding loss in power; and when the utmost is to be realized, no boat can afford any loss of power which can be avoided by a free exhaust. Double exhaust connections may therefore be desirable, one direct and one through the muffler, the former being made as straight and direct as possible and of good size, so as to insure the least possible back-pressure and the maximum output from a given explosive charge.

QUESTIONS OF PROPULSION.

Small boats of the gasoline motor type have commonly suffered through their propellers. If the propeller is reversible and of two blades, it is often difficult to obtain sufficient diameter for the best efficiency, and it is therefore operated under conditions involving a considerable loss in power. Three-bladed reversible propellers have come into some use, and are likely to be more widely employed as the mechanical feasibility of this type become better known. In all such propellers, however, the form of blade as regards the distribution of thickness is such as to involve some loss in efficiency as compared with the standard type of wheel with fixed blades, and the latter is doubtless to be preferred in all cases where provision for reverse may be made independent of the propeller itself.

BEST FORM OF PROPELLER.

One of the recent problems in this connection has been the determination of the best form of propeller for the auto-boat, having in view the high speeds of rotation which are in vogue. With the ordinary type of gasoline engine making 400 to 500 revolutions per minute and fitted in a boat which it can drive at a speed of about 6 to 8 miles per hour, the resulting propeller is quite of the ordinary proportion and involves no departure from standard practice.

With engines making 1,000 or 1,200 revolutions per minute, however, and driving boats at speeds of 15 to 20 miles per hour, the propeller tends to run toward low pitch ratios. On the other hand, with higher speeds more common proportions are again required. The practical question relates, therefore, to the best form and proportion of propellers of pitch ratios below 1 or from 1 to about .75.

But little definite information regarding such propellers is as yet in hand, but general indications point toward the tendency of using too much area as the chief danger to be avoided. Excessive area in such propellers, lying, as it does, so nearly in the plane of rotation, tends to increase the power absorbed without corresponding increase of thrust developed, and thus to decrease the efficiency of operation. With proper form and adaptation to the circumstances of operation, however, there seems to be no reason why the propeller of small pitch ratio may not be freely employed when the relation between speed, diameter and revolutions is such as to indicate its use.

Any general discussion of the problem of propeller design would be quite foreign to

our present purpose, and we shall only refer further to the special importance which this problem holds in the general development of the completed design. No matter how excellent the form of the boat as regards resistance, or no matter how light her construction or how powerful the engine, these various features may all be rendered of no avail, and the power may be expended in vain unless the propeller is suitably adapted to its work. This is, of course, in no wise different from other branches of engineering work, in which the result depends upon a chain of conditions, failure in any one of which will render of no avail the labor spent on the others. In the present problem the chief elements are the form of the boat, the construction of the hull, the engine for the development of power, and the propeller for its application. Each of these in turn depends on many individual items, and all are tied together with complex and interacting relations in such manner that failure in some trivial item, either in design or construction, may spell failure for the whole and render fruitless the effort spent on all the other features, no matter how perfectly all such may be adapted each to its individual purpose.

DIFFICULTIES OF THE PROBLEM.

While these facts are but commonplace in the life of the engineer, they do, nevertheless, have special force in connection with such problems as that of the auto-boat where every item must be keyed up to its highest rate of output, and where the designer can not afford to neglect any feature or to omit any precaution which may in any way react favorably on the result.

Guided by these general principles, and with some reference to the special points considered in the present articles, the designer of auto-boats may feel assured that at least he is working along safe and progressive lines, and that as he is able to accumulate experience and to check his results by actual trial, further application of the same guiding principles will be sure to bring a just measure of progress in dealing with this most difficult problem of engineering work.

(Concluded.)

Hotchkiss Igniter and Cooler.

In the Hotchkiss four-cylinder car exhibited at St. Louis ignition is by primary contact spark. Both the insulated and the movable electrodes are contained in a plug located over the inlet valves. The timing of the spark in each cylinder is adjustable separately. The arrangement of the mechanism will be understood from the accompanying sketch.

Here a guide *A* is suitably fixed on the cylinder wall, in which moves a vertical slide *B*, connected with a push rod *C* from the ignition cam. At the top of *C* is pivoted a trigger *D*, which acts on a small bell crank tappet *E*, whose upper end strikes a horizontal finger extending from the vertical

stem of the movable electrode. As *C* moves up the beveled face of *D* is pushed back by the rubbing stem *F*, which is in reality the end of a screw whose outer end is connected to the arm *G*. All the four arms *G* are connected together by a link, and are oscillated

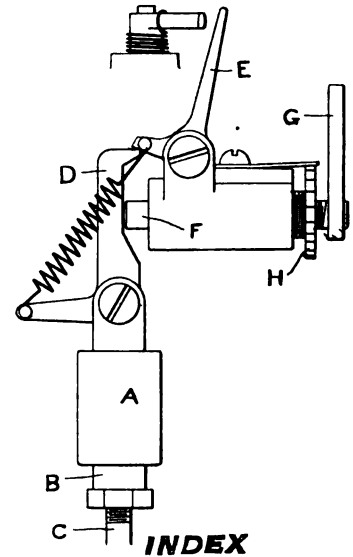

HOTCHKISS IGNITION MECHANISM.

at the will of the operator, thus screwing the stems *F* slightly into and out of the threaded bushings *H*. The triggers *D* are thus made to trip the short arms of *E* sooner or later as desired. Timing or adjusting separately is done by screwing the bushings *H* in or out, thus carrying stems *F* bodily with them.

The radiator is built up as shown in the sketch, and its exterior is circular with the

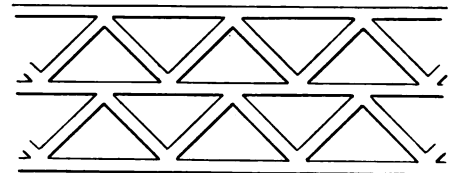

HOTCHKISS TRIANGULAR TUBE RADIATOR.

bottom flattened off. A gear circulating pump is used.

DETROIT AUTO-SCHOOL REOPENS.

Special Correspondence.

DETROIT, Oct. 3.—The Detroit Y. M. C. A. automobile school was opened last Monday night for registration, and nearly 100 members registered the first night. Educational Director William B. Van Akin thinks that the class will be much larger than last winter, and he sees every encouragement ahead.

Thursday night the instructors of the class—H. M. Coffin, of the Olds Motor Works, and E. J. Stoddard, the gas engine expert—talked to the members, giving a general outline of the work to be studied, and to-night the first real work of the course will be begun. After that every Monday and Thursday night the beginners will have instruction, and Tuesday and Friday evenings the advance class will meet. A series of twenty-two lectures will be given.

Harlem Track Races at Chicago.

Fisher Breaks Two-Mile Record with the Comet.—Women's Races Introduced. Want Oldfield Suspended.

Special Correspondence.

CHICAGO, Oct. 3.—Chicago has at last come into the list of successful automobile race-meet promoting cities with a two-day program of interesting events run off last Friday and Saturday at the Harlem mile-trotting track in the presence of 3,000 spectators the first day, and 4,000 the second afternoon. The sport was rather tame, there being a total absence of big high-powered foreign cars or special track racers in the heavyweight class. The best competition was offered by the eight-cylinder air-cooler 40-horsepower Premier *Comet*, and the double-cylinder 20-horsepower Ford spidery racer, the former driven by Carl Fisher and the latter by Frank Kulick, who holds the world's track records in the light-weight class from one to five miles.

Negotiations had been carried on with Barney Oldfield's manager, and his terms for exhibition rides and competition had been accepted by telegraph, but before the date of the meet Manross telegraphed that he had signed a contract for Oldfield to ride at the Pittsburg meet, October 1. As a consequence of this action the Chicago Automobile Club, which promoted and managed the races, has taken steps to have both Oldfield and Manross permanently disqualified from future appearance at any meets sanctioned by the American Automobile Association. A meeting of the racing board of the A. A. A. has been called for to-morrow in New York to consider the matter.

With Herbert Lyttle driving a 24-horse-

power Pope-Toledo, the only eastern driver of note, Fisher and Kulick were the stars of the meet, and their fast driving aroused



MRS. L. T. ROENITZ, IN PIERCE ARROW WINNER WOMAN'S TWO-MILE RACE SATURDAY.

the spectators to frequent bursts of enthusiasm equalled only at the American Derby.

Friday Mrs. Reginald Smith (née Miss Neva Scott, a popular heiress, whose secret wedding to Dr. Smith, of Detroit, was announced Friday night) drove a 24-horsepower Locomobile in a five-mile race against Mrs. L. T. Roenitz, who operated a 24-horsepower Pierce Arrow. Mrs. Smith got a bad start, and Mrs. Roenitz led her by 100 yards through the first mile, but in the second mile Mrs. Roenitz's car came to a standstill and was passed by Mrs. Smith, who was declared the winner, her time for two miles being caught at 4:24. She declined to consider the event a race and said she would run it over the following day.

The ten-mile handicap on Friday was a lively affair, thirteen competitors being on the track at the same time. They were sent away from the tape with a standing start, the time handicap allowance of each being permitted to elapse before the next one started. The limit men had made more than two laps of the mile oval with their generous handicaps before the scratch man, Kulick, with his Ford racer, was sent away. And although Kulick drove at a tremendous gait through a heavy cloud of dust and passed car after car, the best he could do was to finish fourth. First place was captured by F. O. Tallman in a 14-horsepower Renault, the only foreign car to show

Digitized by Google

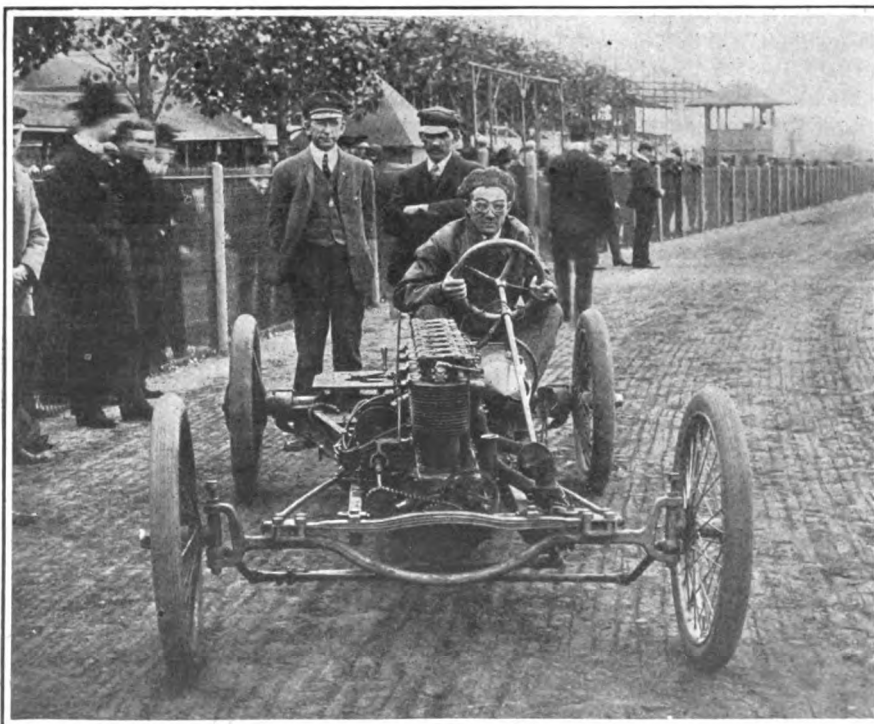

CARL FISHER, IN EIGHT-CYLINDER "COMET" WHO BROKE WORLD'S TWO-MILE RECORD.

SPECTATORS IN GRANDSTAND AT HARLEM RACE TRACK, CHICAGO, STANDING UP TO SEE CONTESTANTS ROUND INTO HOMESTRETCH AT THE BIG CHICAGO AUTOMOBILE CLUB MEET, OCTOBER 1.

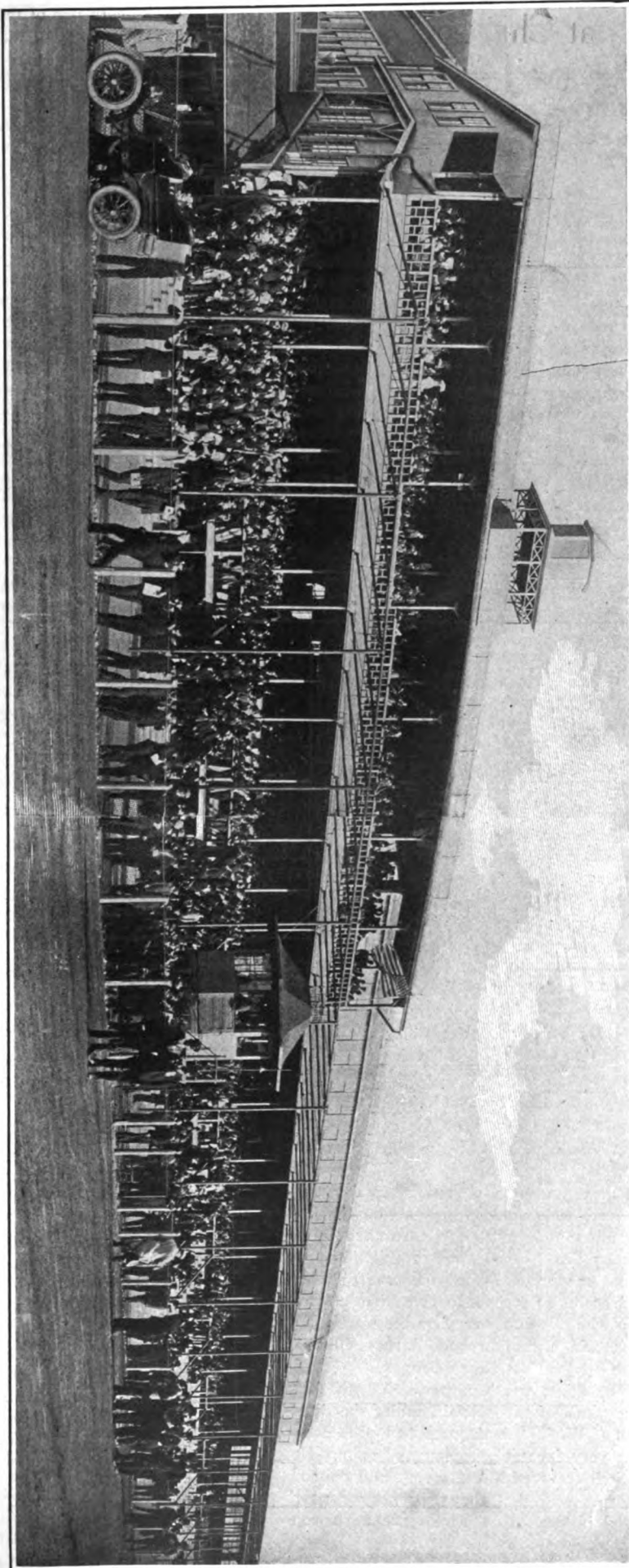

in the summaries. Tallman had a handicap of 16 minutes 30 seconds. Second place went to E. Apperson in a 24-horsepower Apperson (handicap 2:30), and third place to O. E. Schell in a 12-horsepower Michigan (handicap 8:30). The winner's time for the ten miles was 16:38.

Friday's summaries follow:

Three miles, for cars of all classes, each to line up with dead engine and passengers dismount at end of each mile—W. Knipper (24-hp. Pope-Toledo), 1st; A. G. Schmitt (40-hp. Apperson), 2d; J. A. Ellis (40-hp. Apperson), 3d. Time, 6:49 1-5.

Five miles, for cars costing less than \$1,000—O. E. Schell (12-hp. Michigan), 1st; G. E. Holmes (12-hp. Michigan), 2d. Time, 10:28.

Five miles, for cars weighing 881 to 1,432 pounds—Frank Kulick (20-hp. Ford), 1st; Carl Fisher (40-hp. Premier *Comet*), 2d. Time, 5:27.

Five miles, open to cars of any motive power or weight—Frank Kulick (20-hp. Ford), 1st; Carl Fisher (*Comet*), 2d; Herbert Lyttle (24-hp. Pope-Toledo), 3d. Time, 5:29.

Five miles, for woman's championship of Chicago—Mrs. Reginald Smith, née Miss Neva Scott (24-hp. Pope-Toledo), 1st; Mrs. L. P. Roenitz (24-hp. Pierce Arrow), 2d. Race called off at end of two miles. Time, 4:24.

Ten-mile handicap—F. O. Tallman (14-hp. Renault), handicap 6:30, 1st; E. Apperson (24-hp. Apperson), handicap 2:30, 2d; O. E. Schell (12-hp. Michigan), 8:30, 3d. Time, 16:38.

Pursuit match race—Carl Fisher (*Comet*), 1st; E. Apperson (24-hp. Apperson), one mile handicap, 2d. Won in 33-8 miles.

FISHER BREAKS WORLD'S RECORD.

The world's record for two miles in the middleweight class was lowered to 2:02 flat by Fisher with the *Comet* in his special five-mile match race with Kulick on Saturday. The former record was 2:02 3-5, made by Joseph Tracy with the Renault at Empire City track only the week before. Fisher won the second and third heats of the race in 5:29 2-5 and 5:10 2-5, respectively. It was in the third and fastest heat that the record was broken, but the second heat brought out the most exciting contest of the meet, first one and then the other of the contestants going to the front, and scarcely twenty feet separating them at any time during the last two miles. Through the last mile the cars were almost side by side most of the time. One mile in the third heat was made in :59 4-5.

Fisher also captured the Diamond Cup, defeating Kulick in the Ford, Knipper in the Pope-Toledo, and a Tincher car. His time in this was 5:15 3-5.

There were three starters in the two-mile race for women contestants, Miss Pearl Lavery in a 24-horsepower Packard competing with Mrs. Smith and Mrs. Roenitz. Mrs. Roenitz squared accounts with Mrs. Smith this time, winning in 6:12.

Edgar Apperson captured the cup offered for Chicago A. C. members with his Apperson car in 6:23, defeating O. F. Weber with a Pope-Toledo and W. S. Austin with a 35-horsepower Austin car.

Charles and Orlando Weber ran first and second in the ten-mile handicap, each driving a 24-horsepower Pope-Toledo and winning from Herbert Lyttle, who started from scratch in a 24-horsepower car of the same make, and finished third.

The summaries for the second day follow:

Diamond Cup race, five miles—Carl G. Fisher (*Comet*), 1st; Frank Kulick (Ford racer), 2nd; W. Knipper (24-hp. Pope-Toledo), 3rd. Time, 5:15 3-5.

Special match race, five miles—First heat: F. Kulick (Ford), 1st; Carl Fisher (*Comet*), 2nd. Time, 5:27 4-5. Second heat—Carl Fisher, 1st; F. Kulick, 2nd. Time, 5:29 2-5. Final—Fisher, 1st; Kulick, 2nd. Time, 5:10 2-5.

Five miles, for Chicago A. C. members only—Edgar Apperson (24-hp. Apperson), 1st; O. F. Weber (24-hp. Pope-Toledo), 2nd; W. S. Austin (35-hp. Austin), 3rd. Time, 6:23.

Women's race, three miles—Mrs. L. T. Roenitz (24-hp. Pierce Arrow), 1st; Mrs.

Pittsburgers Stirred by Good Sport.

Oldfield, the Only Professional Present, Wins Every Race He Enters—Spectators Wildly Enthusiastic Over Fast Times.

Special Correspondence.

PITTSBURG, Oct. 3.—More than 5,000 enthusiastic spectators attended the big automobile race meet held at Brunots Island last Friday and Saturday under the auspices of the Automobile Club of Pittsburg, and gave abundant proof that automobile racing has been fairly inaugurated in Pittsburg. No sporting event ever held in this city drew a more loyal or more representative crowd. Society was out in force, business men were there with their families, and hundreds of automobile owners from Pittsburg and Allegheny and the surrounding towns were in attendance with their cars.

feature of the afternoon was Oldfield's driving. He made a mile in one minute flat in a five-mile exhibition, for which the total time was 5:09 1-5, and was an easy winner in a five-mile open race, in which he drove a 24-horsepower Peerless touring car in competition with O. E. Vestal in a White steamer and W. N. Murray in a 24-horsepower Pope-Toledo. Oldfield's time was 6:37 1-4. Oldfield also captured the five-mile handicap, which was run in two heats and a final, with eight starters in each heat. He drove a 24-horsepower Peerless, and won in 5:47, one of the intermediate miles being made in 1:02 3-5. Just before the handicap, which was the last event on Friday's program, the Ohio driver rode an exhibition three miles in 3:05, doing the last mile in one minute flat. The spectacular performance aroused great enthusiasm in the grandstand.

Another feature of the afternoon was the presence in several races of George E. Turner, a local owner who was badly injured in an automobile accident a few days before the meet and came onto the track with his head and face almost covered with adhesive plasters. Turner won the first event, a five-mile race for cars up to 24-horsepower with road equipment, in a Peerless, in 6:45 1-2. He had as competitors E. Kneeland in a Pope-Toledo, William Soules in W. N. Murray's Pope-Toledo, George Ferrier in W. C. Temple's Pierce, O. E. Vestal in a Richard-Brasier, and Webb Jay in a White steamer.

A second victory fell to Turner in the third event, a ten-mile race for stock touring cars up to 35 horsepower with road equipment. With a Peerless he covered the ten miles in 13:14, defeating William Soules in Murray's Pope-Toledo, Webb Jay in O. E. Vestal's White, Ferrier in Temple's Pierce and Kneeland in his Pope-Toledo.

Webb Jay defeated a field of seven starters in the five-mile for cars up to 16 horsepower with road equipment in 8:35. Pitted against him were E. Haas in A. L. Banker's Pierce, W. N. Murray in a Franklin, J. A. Pietsch in a Stevens-Duryea, H. A. Marlin in a Pope-Toledo, E. Kent in a Pierce, D. S. Gamble in J. Hawkins's Autocar and W. C. Cook in a Stevens-Duryea.

A foreign car carried off first honors in the two-mile race for cars up to 9 horsepower with road equipment, George H. Flinn winning in a Peugeot in 3:51 3-4. Other starters were D. P. Collins in A. L. Banker's Cadillac, and M. F. Leslie in O. E. Vestal's Stevens-Duryea.

FASTER TIME ON SATURDAY.

Interest centered on Oldfield again Saturday afternoon, when, in two successive

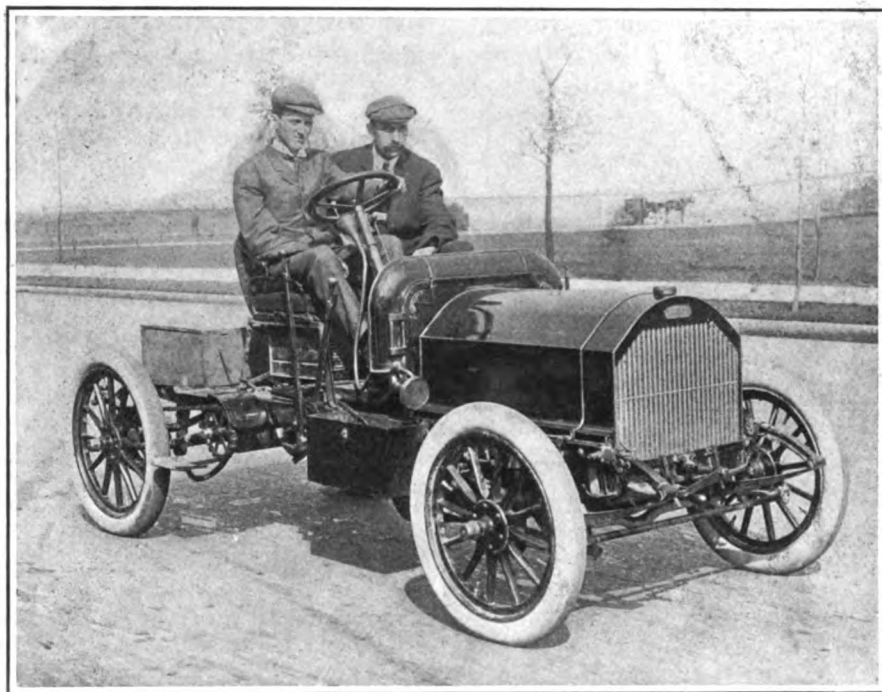

JOHN E. FRY AND EDGAR APPERSON, IN 24-H. P. APPERSON, AT CHICAGO RACE MEET.

R. Smith (24-hp. Locomobile), 2nd; Miss Pearl Laverty (24-hp. Packard), 3rd. Time, 6:12.

Five miles, for cars weighing 1,432 to 2,204 pounds—Herbert Lyttle (24-hp. Pope-Toledo), 1st; W. Knipper (24-hp. Pope-Toledo), 2nd; L. D. Sheppard (18-hp. Sheppard), 3rd. Time, 6:22.

Special, three-mile race, for Franklin cars—E. F. Kirchberger, 1st; C. H. Harbert, 2nd.

Half-mile slow race—F. X. Mudd (6-hp. Cadillac), 1st; W. S. Austin (35-hp. Austin), 2nd.

Ten-mile handicap—Charles Weber (24-hp. Pope-Toledo), 7 minutes handicap, 1st; O. F. Weber (24-hp. Pope-Toledo), 6:30 handicap, 2nd; Herbert Lyttle (24-hp. Pope-Toledo), scratch, 3rd. Time, 15:44.

An automobile hearse has made its appearance. What more appropriate—"White Wings" for good people and "Red Devils" for sinners.—*New York Globe.*

Every available boat on the Ohio River was crowded, from before noon until long after the races started, at 2 o'clock each day, with pleasure-seekers bent upon seeing the first big automobile races ever attempted in the Smoky City. Local pride ran high, and the dozen or more well-known Pittsburg drivers had scores of freinds to give them an ovation when they appeared on the track. But the main attraction was Barney Oldfield, with his Peerless *Green Dragon*.

The finest weather prevailed both days. The work of the officials, under the direction of W. C. Temple, president of the club, was very favorably commented upon. Not a hitch occurred in the events, and the contestants said that they had never participated in races that were more fairly conducted.

Six events were run the first day. The

Successful Meet at Point Breeze.

Special Correspondence.

exhibition mile rides with the 80-horsepower *Green Dragon*, he did 59 2-5 seconds and 58 1-5 seconds, and then went for a three-mile exhibition, which he finished in 2:55 3-5. In addition, he took the ten-mile race for cars up to 35 horsepower with the 24-horsepower *Peerless* in 10:40 1-5, George Turner in a *Peerless* finishing second and F. H. Beldin in a 24-horsepower *Pope-Toledo* third.

The five-mile handicap, whose thirteen starters were divided into three heats, also went to Oldfield. The first heat was won by Murray in the *Franklin* in 8:46, with a handicap of 20 seconds; T. S. Gamble in an *Autocar* with 30 seconds finishing second. The second heat went to Lester Wilson in a 24-horsepower *Pierce* with a handicap of 1:10 in 7:34 3-5, Kneeland taking second place with a *Pope-Toledo* from scratch. The third heat was won by Oldfield from scratch in the 24-horsepower *Peerless* in 5:26 3-4, O. E. Vestal running second with a *White* with 25 seconds handicap. The final heat was won in the homestretch, Oldfield taking the lead away from Lester Wilson (*Pierce*) with a rush that gave him the race by four lengths in 5:25 3-5. Wilson ran second, and Vestal third in the *White*.

A very laughable feature of the program was "Cupid's" two-mile race, in which each contestant had to stop his car and pick up a woman passenger at the end of the first mile. The crowd howled and cheered over the efforts of the passengers to scramble into the cars in the shortest possible time. Vestal won the contest with a *White* in 2:14. Turner finished second with a *Peerless*.

O. E. Vestal also won a two-mile event for cars up to 16 horsepower with road equipment. He drove a *White* and finished in 3:35, with George Stranahan second in a *Franklin* and A. L. Banker third in a 15-horsepower *Pierce*.

The same victorious steamer, driven by Webb Jay, captured the two-mile race for cars up to 24 horsepower in 2:46, Turner, in a *Peerless*, ran second, Kneeland in a *Pope-Toledo* third and W. Soules in a *Pope-Toledo* fourth.

D. P. Collins in a *Cadillac* took the mile race for cars up to 9 horsepower away from George Flinn in a *Stevens-Duryea*, second, and J. A. Pietsch in a *Peugeot* third. The winner's time was 2:12 3-4.

The 1905 Sportsman's Show, which will be held in Madison Square Garden, New York City, February 21 to March 9, in conjunction with the exhibit of the National Association of Engine and Boat Manufacturers, will present very much the same arrangement as last year's Sportsman's Show, except that there will be an island in the lake where the marine motors will be exhibited. Launches will sail around the island, passing under the two bridges connecting it with the "mainland," which will be devoted to exhibitions of launches and camps. A particularly fine exhibit of auto-boats is anticipated.

PHILADELPHIA, Oct. 3.—In character of sport furnished, in attendance, and in the number of motor vehicles present, last Saturday's race meet at the Point Breeze mile track excelled any similar function ever held in this city—and this despite a 25-mile-an-hour gale that raised such clouds of dust that contestants and spectators alike suffered much discomfort.

The official programme announced that the meet was held "under the auspices of the Automobile Club of Philadelphia," although the sanction had been granted to the new Motor Power Association of Philadelphia. When Secretary Gillette, of the A. A. A., arrived in town, several days before the meet, the feelings of the two organizations were harmonized and a compromise arrangement entered into whereby the right of the A. C. of P. in the premises was acknowledged by the M. P. A. people, and a percentage of the profits of the meet, if any, was to go to the A. C. of P. treasury.

By actual count there were 125 spectators' cars parked on the grounds, the occupants of which, added to the crowds in the grand stand and the "rail birds," brought the total attendance close to 2,000.

It was a *Pope-Toledo* day, cars of that make carrying off the honors in the amateur and professional events. While the *Pope-Toledos'* victory in the final of the Point Breeze Handicap was due to their rather liberal treatment by the handicapper, the distance made up by the scratch car—E. R. Thomas's 60-horsepower *Mercedes*, with Edward E. Hawley driving—was inconsiderable, and the two "P-Ts" finished fully half a mile ahead of their big opponent.

In the race for touring cars, with full stock equipment and carrying four passengers, Charles Potter's *Pope-Toledo*, Yeager driving, had the race won at the end of the second mile, its two opponents withdrawing, the Winton on the first lap and the *Peerless* during the second mile. Yeager never let up, but drove his car ahead at a good clip, finishing the five miles in 6:45 3-5.

The ten-mile event, for machines of any motor power, weighing from 881 to 1,450 pounds, brought four cars to the scratch—Wanamaker's 10-horsepower *Ford*, Pennsylvania Electric Vehicle Co.'s 8 1-4-horsepower *Cadillac*, the Black Diamond Automobile Co.'s 15-horsepower *Buckmobile*, and Ed. Wilkie's 8 1-4-horsepower *Cadillac*. The start was a good one, the *Ford* immediately taking the lead and drawing farther ahead with each mile. The *Buckmobile* was lapped at six and one-half miles, and a minute later withdrew. The Pennsylvania Electric Co.'s *Cadillac* had withdrawn half a minute earlier. Wilkie kept luckily on in his *Cadillac*, but was lapped by the *Ford* at nine and one-half miles, and at the finish was one mile and one hundred yards to the bad. He finished the distance, however, and captured the silver cup hung up for the

place winner. The *Ford* did the ten miles in 16 minutes flat.

The event of the afternoon, the Point Breeze Handicap, free-for-all, brought ten starters to the tape. It was run off in two heats and a final. In the first heat, Thomas's 60-horsepower *Mercedes* was on scratch, a *Locomobile* had one minute start, Potter's *Pope-Toledo* 1:15, Wanamaker's *Ford* 1:45, and the *Buckmobile* 2:15. Hawley in the *Mercedes* seemed to be unable to pull up on Yeager in the *Pope-Toledo*, who gradually wore down the lead of the others and almost maintained his distance on the big machine, winning in 6:08, actual time.

The second heat saw Leon Goodman's *Pope-Toledo*, with one minute start, the virtual scratch machine. Banker Bros.' *Peerless* had 1:15, Dr. Bryce's Stanley steamer 1:45, and Wilkie's and the Pennsylvania Electric Co.'s *Cadillacs* 2:15 each. Again the *Pope-Toledo* showed its superiority, rapidly cutting down the lead of the other cars and winning handily in 6:11, actual time.

In the final the handicap of the two *Pope-Toledos* was reduced by 15 seconds each, the *Banker Peerless* had a start of 1:15, and the *Thomas Mercedes* was on scratch. Interest in the race when it became apparent that the powerful *Mercedes* could not overtake its two smaller opponents was centered in the efforts of the drivers of the latter to get their cars into the lead. It was a seesaw, the two cars racing almost side by side, first one and then the other taking the lead. Goodman's car, driven by Charles Soules, finally passed under the wire about ten yards ahead of the other *Pope-Toledo*, driven by Yeager, the times being 6:34 4-5 and 6:35, respectively. The *Mercedes'* actual time was 5:58 2-5.

An exhibition ten miles by the *Thomas Mercedes* showed some of the fastest going of the afternoon, five miles being covered in 5:45 flat, and ten miles in 11:35.

A *Pope-Toledo* was again to the fore in the five-mile race for machines weighing from 1,432 to 2,204 pounds. Goodman's car, with Soules driving, again beat its factory mate, with Yeager up, by a few yards in 5:55.

The special five-mile race for motorcycles brought six contestants to the tape, and when the results were announced the Indian tribe was found to have appropriated all three prizes, whereat the winner was carried off on the shoulders of his exultant fellows with a \$20 gold piece tucked away in his pocket.

Driving the Packard 1,000-mile non-stop car, Wayne Davis covered five miles in 8:19 in the midst of a miniature tornado that often hid him from view.

Following are the summaries:

Five miles, for touring cars, 24-horsepower or under, full touring equipment, four passengers—Frank Yeager (*Pope-Toledo*),

1st; other contestants withdrew. Time, 6:45 3-5.

Ten miles, any motor power, 881 to 1,450 pounds—William Mullin (Wanamaker's Ford), 1st; Edward Wilkie (Cadillac), 2nd. Time, 16:00.

"Point Breeze Handicap," five miles, free-for-all, no restrictions—First heat, Frank Yeager (Pope-Toledo), 1:15, 1st; E. E. Hawley (Thomas's Mercedes), scratch, 2nd. Time, 6:08. Second heat—Charles Soules (Leon Goodman's Pope-Toledo), 1 minute, 1st; E. S. Morton (Peerless), 1:15, 2nd; Edward Wilkie (Cadillac), 2:15, 3rd. Time, 6:11. Final heat—Charles Soules (Pope-Toledo), 45 seconds, 1st; Yeager (Pope-Toledo), 1 minute, 2nd; Hawley (Mercedes), scratch, 3rd. Time, 6:34 4-5. Mercedes' time from scratch, 5:58 2-5.

Five miles, any motor power, 1,432 to 2,204 pounds—Charles Soules (Pope-Toledo), 1st; Frank Yeager (Pope-Toledo), 2nd. Time, 5:55.

Ten-mile exhibition—E. E. Hawley (60-horsepower Mercedes). Time, 11:35.

Five-mile exhibition—Wayne Davis, Packard 1,000-mile non-stop car. Time, 8:19.

Five miles, special motorcycle race—Adolph Wicknick (1 3-4-horsepower Indian), 1st; J. Broomfield (1 3-4-horsepower Indian), 2nd; Joseph E. Barranger (1 3-4-horsepower Indian), 3rd. Time, 8:12 2-5.

PROGRAM OF KANSAS CITY RACES.

Special Correspondence.

KANSAS CITY, Oct. 3.—All the local dealers and a number of private owners have entered cars in the first real automobile race meet ever held in this city, which will be pulled off next Wednesday, October 5, on the half-mile driving club track under the auspices of the Automobile Club of Kansas City and with the sanction of the A. A. A. In addition, Webb Jay will be on hand with a White steamer, the Packard company has telegraphed that it has a car on the way, and the Pope Motor Car Co. has sent one of its drivers from Toledo.

Following is the program of events:

Interstate Association Cup, five miles, for vehicles weighing 881 to 1,432 pounds; five miles, for cars weighing 1,432 to 2,204 pounds; A. C. of Kansas City trophy, ten-mile, free-for-all; five miles, for stock motorcycles; World's Fair trophy, five miles for cars weighing 881 to 1,432 pounds.

The officials of the meet are: Referee, Dr. W. W. Gardner; judges, H. N. Strait, Bertrand Clarke, E. V. Parrish, of St. Louis; clerk of the course, D. E. Gudgell; assistant clerk, E. J. Leland; starter, Roy Sanborn; racing committee, A. Watson Armour, William Huttig, president of the automobile club, and R. Baumel, secretary; timers, W. A. Williams, John M. Grant and A. D. Cottingham. The two last named are horsemen.

Directions usually given for putting patches on inner tubes are not always the best possible. For instance, the directions almost invariably advise that the cement placed on the patch and tube be allowed to become half dry, or tacky, before the patch is applied. As a matter of fact, a much better job can be done if the cement is allowed to become so nearly dry that it is just perceptibly sticky to the finger. When this stage has been reached, the tube should be placed on a flat surface and the patch laid on its place and rolled on with some round object, such as a tire pump. Patches put on in this way will hold like grim death.

A fellow who drove a Darracq
Went into a race on the track.

When he ran out of juice

He exclaimed, "Oh, the duice;
My chances look horribly black!"

500-MILE ENDURANCE RUN.

Final Arrangements for San Francisco-Los Angeles Tour, October 12-17.

Special Correspondence.

SAN FRANCISCO, Sept. 28.—Chairman L. P. Lowe, of the Executive Committee of the Automobile Club of California, issued a circular last Saturday definitely announcing the revised date and plans for the endurance run to Los Angeles, and asking for entries. The date has been advanced from October 21, the last announcement, to October 12, and the plans have been changed somewhat.

The circular states that the run will be started from San Francisco on Wednesday, October 12, and will be for one way only, the finish of the endurance contest being at Los Angeles. The original plan was to make a round trip run of 1,000 miles, approximately, but so much time has intervened and so many events have taken the time of the local automobilists that few find they can now spare the ten days necessary for a full trip. On this account those who compete will be permitted to return by rail if they choose.

Four days will be occupied in the run, and convenient running hours, with stops affording good hotel accommodations, have been planned. A map has also been prepared.

Competing cars will be divided into two classes, with valuable trophies for each class, although, as Mr. Lowe's circular points out, the greatest benefit to those competing will come from the work done for the benefit of good roads and coast automobile interests generally, together with the pleasure of the trip. The route is a very beautiful one, and as it will be made within reasonable speed limits, it will certainly afford opportunity for a very pleasurable outing. The season of the year is particularly fortunate, for, although the days are shorter than when the trip was first planned, the weather conditions are more uniform and more desirable.

The course will offer the best possible test of the quality of the cars making the run. The grades and general road conditions are such as are frequently met with in California touring, and those who participate will have the best possible opportunity for discovering the practicable utility of their machines. It is safe to say that no route in America offers better conditions for an endurance test.

The daily time schedule will be as follows:

San Francisco to Salinas—Leave San Francisco, 7:30 a.m.; due Salinas (110¾ miles), 4:45 p.m.; control officially closes, 9:30 p.m.

Salinas to San Luis Obispo—Leave Salinas, 5:30 a.m.; due San Luis Obispo (148¾ miles), 6 p.m.; control officially closes, 11:30 p.m.

San Luis Obispo to Santa Barbara—Leave San Luis Obispo, 6 a.m.; due Santa Barbara (130¾ miles), 5 p.m.; control officially closes, 10:15 p.m.

Santa Barbara to Los Angeles—Leave Santa Barbara, 7 a.m.; due Los Angeles (117¾ miles), 4:30 p.m.; control officially closes, 9:30 p.m.

The cars will be divided into touring cars, regularly made to carry at least four passengers, and runabouts, regularly made to carry at least two passengers. There will be three prizes in the touring-car class and two in the runabout class. Each car must be regularly equipped in customary touring condition and must carry at least two persons—the driver and an official observer. The regular load of touring cars

must total at least 660 pounds and of runabouts 330 pounds, exclusive of water, gasoline and lubricating oil. The load may consist of passengers, baggage, extra parts and tools.

Cars may carry and be operated by an alternate operator if a contestant so elects.

Three regular non-penalized stops may be made daily, as follows: About fifteen minutes during the forenoon, about one hour during noon, about fifteen minutes during the afternoon. Regular non-penalized stops, if made, must be continuous. During forenoon and afternoon stops no attention is to be paid to machine other than such as is covered by non-penalized stops.

Stops made for the purpose of taking photographs are named among the non-penalized stops.

Fuel, water and lubricating oil may be carried, but if placed in tanks at times other than during regular controls or noon stops, machine must be brought to a full stop and supplies must be introduced in a regular and customary manner.

During regular night controls machine may be regularly cared for, outwardly cleaned, supplies introduced and non-penalized adjustments made.

The contest will be decided upon points. Each contestant will be credited, upon starting, with 2,500 points, and one point will be deducted for each one minute penalized stop, or major fractional part thereof.

An average running speed of practically twelve miles an hour, including non-penalized stops, must not be exceeded. The average running speed may be as low as about eight miles an hour, including non-penalized stops, but must not be less than practically eight miles.

COMPELLED TO REMAKE ROADS.

Special Correspondence.

HARRISBURG, PA., Oct. 3.—Were it not for the actions of several automobilists the "good road law" of this State would amount to nothing. Between Harrisburg and Hummelstown, nine miles, is a part of the pike which extends from the capitol city to Philadelphia, and which is in a wretched condition. A petition was circulated some time ago by motorists and numerously signed by taxpayers, praying that the road be repaired under the new law. The Supervisors refused, and suit was brought. In defense the Supervisors also circulated a petition, and secured signers by stating the taxes would be raised if the improvements were made.

The case was set down for this week, but the Supervisors have weakened, it is said, and the matter was amicably settled out of court. The road will be improved, and with it one other piece leading out of Harrisburg.

This will be good news to automobile tourists, for with the road repaired between Harrisburg and Hummelstown there will be a continuous good road between Philadelphia and Harrisburg by way of Reading.

A correspondent in an English newspaper has thought up a brand new charge against the automobile. He says that the oil dropped onto the roads near his residence by automobiles was carried by a heavy rain into an ornamental pond, where it killed all the goldfish. This is certainly going Yankee ingenuity one better.

American manufacturers of automobiles and motor cycles are not securing so large a share as they might of the British trade, according to a report made by Jos. G. Stephens, United States Consul at Plymouth, England, who believes that with more energetic and systematic pushing a much more profitable business could be worked up.

The Sturtevant.—A Car with Automatic Change-Speed.

A gasoline automobile operated with no change speed levers or clutch pedal, with spark and throttle simultaneously controlled by one movement of a foot pedal, and with an equipment of air-brakes with pressure supplied from the motor combustion chamber, has just been produced by the Sturtevant Mill Company, of Boston. These remarkable departures are effected by the use of a centrifugal clutch whose operation depends on the motor speed, and acts automatically as the speed goes up or down under the influence of road resistance and throttle opening.

The car as constructed has standard tread, a wheelbase of 108 inches, 32-inch wheels, and 4 1-2-inch tires. The frame is of pressed steel, and is supported by 48-inch semi-elliptic springs, supplemented by helical spring bumpers. The body has 22-

carried out to a full circle between the cranks to form a solid spiral gear for driving the time shaft, which runs in oil underneath the cylinders.

The cylinder castings are held together transversely by four bolts passing through lugs on the cylinder castings, the removal of which bolts disconnects the cylinders from the crank case. The rear end of the crank shaft is flanged, and to it is bolted the flywheel which encloses the clutches, and the forward end is also flanged, and to this is an extension carrying the fan pulley and starting crank. This extension also drives by a spiral gear the centrifugal water circulating pump mounted horizontally. This vertical pump shaft extends upward into the hollow dash and operates the governor, electric time pulley, and mechanical oiler. A cellular radiator is used, and cooling is assisted by a 12-inch fan.

The centrifugal governor mounted in the hollow dash, at the top of the vertical shaft mentioned, has for its function to

tion of the car, since it prevents the motor from speeding up enough, when the car is standing, to engage the automatic clutches.

A hollow dash board is an important feature of this car, in which accessibility seems to have reached its limits. Here are located all small parts; the carbureter, electric mechanisms, force oiling device, water and oil glass gauges and governor. A glass door opens to give easy access to this closet, and all parts are in view of the chauffeur. From this a square bonnet extends forward to the radiator and contains the 12-gallon gasoline tank, cooling fan and batteries.

The transmission and speed-changing mechanism is entirely automatic, and in the car shown provides three forward speeds. It consists of a series of disc clutches operated by centrifugal force for the forward speeds, and a sliding gear operated by the left foot pedal in connection with the centrifugal clutch for the reverse.

The principle of the clutch is shown on

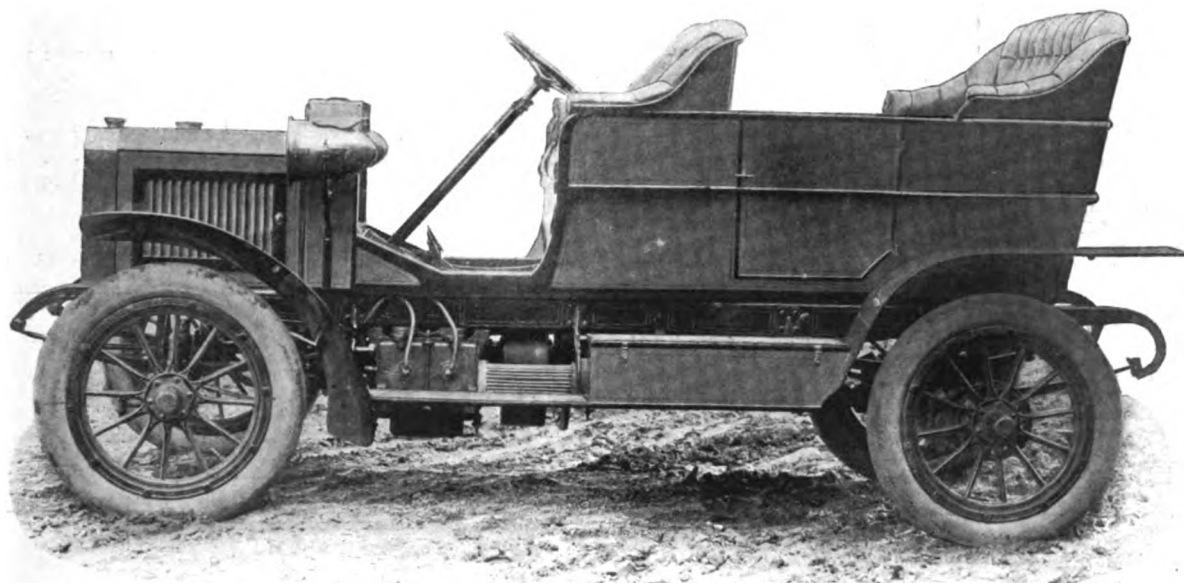

SIDE VIEW OF THE NEW SIDE ENTRANCE STURTEVANT CAR FITTED WITH AUTOMATIC CHANGE SPEED GEAR.

inch side entrances, a roomy tonneau, and an open floor space from dash to rear.

The motor is of the four-cylinder horizontal opposed type, with 5-inch bore and 4-inch stroke. It is placed transversely just back of the front wheels, and has its cylinders bolted to the lower side of the chassis side beams. The motor and gear box are stiff enough to lend great rigidity to the frame. The horizontal motor permits a low center of gravity, while still there is a road clearance of 12 inches. The cylinder ends project outside the frame, giving unobstructed access to the spark plugs and valves at the sides of the car. The opposite pistons work in pairs on common crank pins, the rods being held on the pins by central split rings, as shown on page 414. The rods are of phosphor bronze, and very light and stiff.

The crank shaft is 2 inches in diameter at the bearings, which are 3 inches long, and is

keep the motor speed down to about 220 r. p. m. when running light. It acts, not on the throttle, but on the primary spark circuit, which it interrupts, until the above noted speed is reached. When it is desired to accelerate the motor, the first movement of the throttle foot-button short circuits the governor, and the single vibrator, by means of a connection to the automatic switch, shown diagrammatically on page 415. The current is then taken from the battery through the contact timer, then directly to a heavy coil and to the spark plug. The motor then runs at working speed without the vibrator, the idea being that one good spark is better than many poor ones. This arrangement also makes a great saving in dry cells. Two sets of cells are carried in the battery box, either set being thrown in by a small switch lever on the steering post. As will presently be seen, the governor plays an important part in the opera-

page 415, from which it will be seen that the flywheel drum is bolted to the crank shaft, and carries with it three sets of friction discs—shown in solid black—and the centrifugal weights. These discs grip respectively three sets of driven discs, connected with the first and second speed gears by hollow shafts and with the direct drive by a central solid shaft. The springs tending to release the discs are of graduated stiffness, so that low-speed discs, when the weights begin to press against them, grip together first. As the motor speed increases the intermediate discs take hold, and finally the high-speed direct drive discs. The various gears are constantly in mesh, and the obvious necessity of permitting the low-speed gears to run ahead of the high-speed gears, when the latter are working, is provided for by roller ratchets in the first and second-speed gears. Thus, while all the clutch discs may be turning together, as when the direct

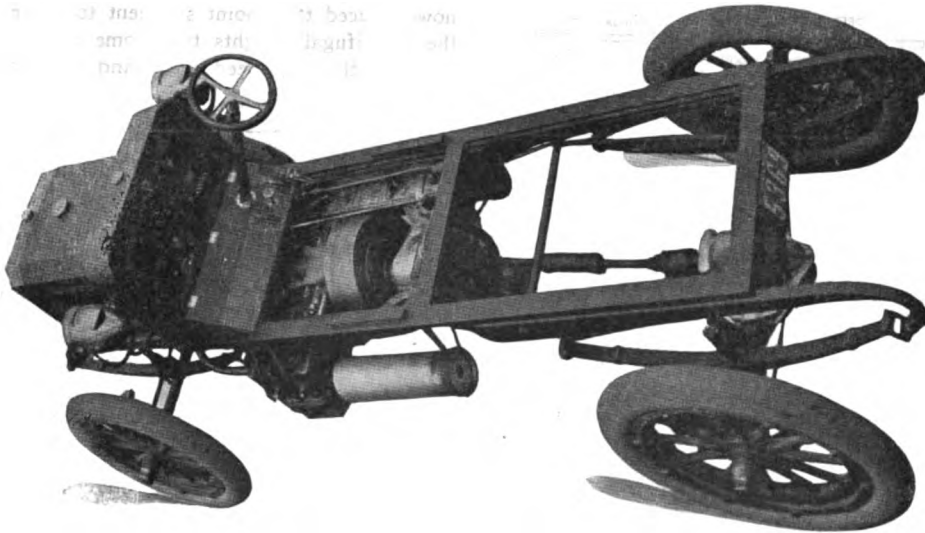

CHASSIS OF THE STURTEVANT CAR—NOTE THE HOLLOW DASH WITH GLASS FRONT.

drive high speed is engaged, no gears are driving, but turning free by reason of their ratchets.

When it becomes necessary to reduce the motor from its driving to its normal unclutched speed, the operation is performed by releasing the pressure on the foot-button and allowing it to return to its position of rest. This throttles the motor, retards the spark and throws in the governor, which, by cutting out explosions, holds the motor speed to about 220 revolutions.

Supposing the motor to be running on the governor as just described, there will be some unfired cylinder charges passing through the motor which would be liable on reaching the muffler to ignite and cause explosions therein. To avoid this a system of cooling pipes has been introduced between the exhaust pipe and the muffler. The system, having a larger area than the area of the exhaust pipe, relieves the motor of any back pressure, and, at the same time, affords sufficient radiation to cool the gases far below the ignition point. The result is no muffler explosions and an absolutely silent exhaust.

SYSTEM OF LUBRICATION.

One of the most important features of any automobile is its method of lubrication. The lubricating system of this car consists of a force system, the mechanism being situated in the hollow dash and constantly in view of the operator so that any interruption of it is readily noticeable. The lubricator referred to consists of a 6-plunger ram pump, forcing oil to each cylinder and the cranks. Instead of having the ordinary forward and backward movement, the six plungers are drawn back against springs to fill the pump. After the pump cylinders are filled with oil and the spring is compressed, the plungers are suddenly released and the action of the spring jumps the plungers forward, thus violently forcing the oil through the piping. This method tends to keep the oil connections clean, and as the cylinder plungers only fill slowly, there is no opportunity for the lubri-

cator to fail to do its work, as is sometimes the case with a rapidly moving mechanical lubricator working on heavy oil.

This system is supplemented by a hand pump operating through the same system, so that, on or before starting, the oil tubes may be flushed by hand. As the crankcase is entirely enclosed, all interior parts of the motor are lubricated by a spatter of oil. The oil is not permitted to accumulate in

the crankcase but is drawn off by an overflow pipe. The main bearings have large oil pockets, which are supplied with felt wick oilers, and like a shaft bearing carry a supply that lasts for many weeks. From the crankcase the oil overflows through a hollow shaft to the enclosed flywheel and clutch discs. The oil is fed in sufficient quantities to keep the discs and interior parts of this drum running in an oil bath. The flywheel drum is also fed from an overflow from the gear case, as the gear box carries oil which can overflow through the hollow shaft to the flywheel. The universals and differential are packed in grease, and the entire valve mechanism, being situated underneath the cylinders, runs in an oil bath, which is also fed from the crankcase.

INDEX AIR BRAKES.

The car is equipped with a system of air brakes, and with a positive mechanical brake. A double-acting brake band on each rear wheel is tightened by the movement of pistons acting one on each end of the brake band. The pressure is taken from a tank situated at the rear of the car, which is directly connected with one of the combustion chambers of the motor. At each explosion in that cylinder a small portion of the charge goes past a pressure regulating check valve to the gas tank until the pres-

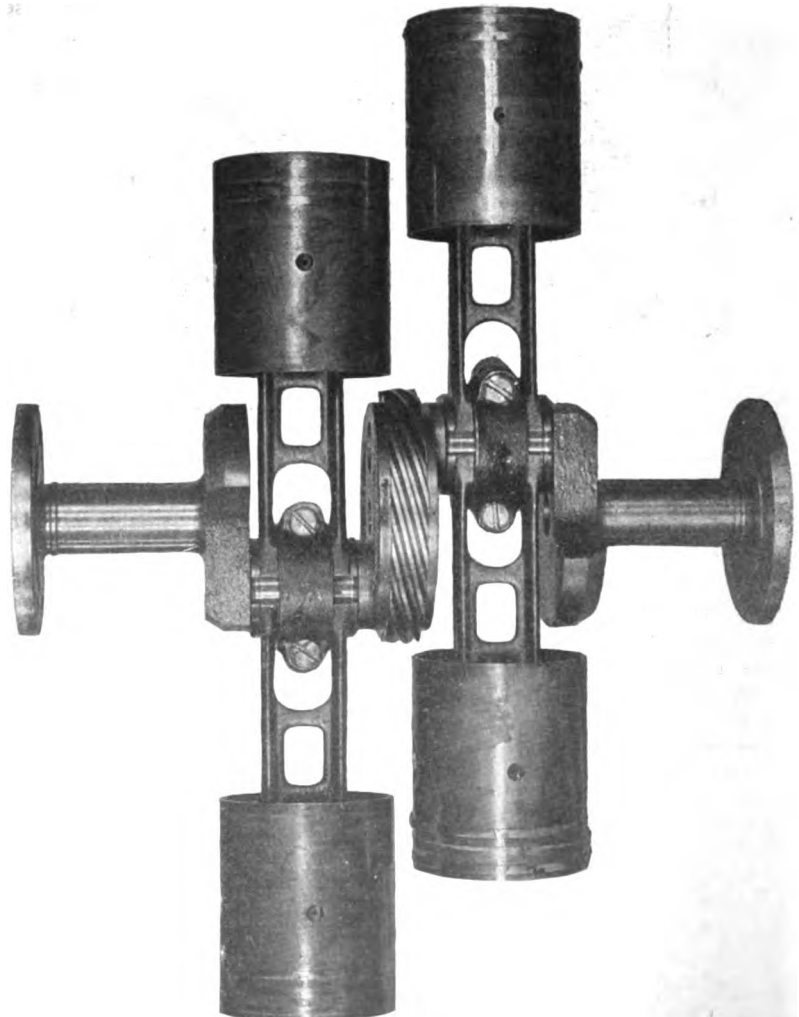

TRUNK PISTONS, CONNECTING RODS AND CRANK SHAFT OF STURTEVANT CAR.

sure in the latter corresponds with that in the cylinder. The gas is admitted to the double cylinders of the air brakes by a forward movement of the right pedal, which, when allowed to return by the force of the spring to its normal position, opens a vent from the brake cylinders, allowing the release of the brakes. Both wheels by this system are braked with equal force, and the brakes are very powerful, being sufficient to stop the car, with full motor power on, in case of an emergency requiring a quick release of the automatic clutch. These brakes are also assisted in emergency by a

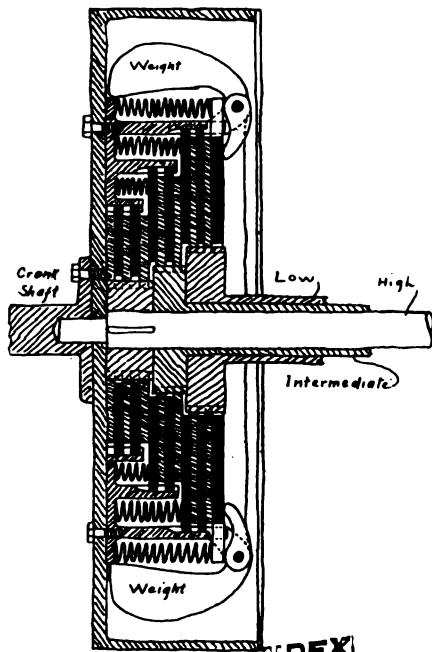

ROUGH SKETCH OF CLUTCH SYSTEM.

regular mechanical brake on the transmission, which is operated by a still farther movement of the same brake pedal.

METHOD OF OPERATION.

The operation of the car is very simple, and must appeal to the amateur as well as the professional driver. The absence of all hand levers for changing speed or operating brakes, leaving the hands entirely free for steering, avoids confusion and tends to easy driving. In starting the car, the accelerating or throttle pedal is left in its idle position, and the motor is cranked and started under governor speed, at which speed the clutches are inoperative and the car remains stationary awaiting the acceleration of the motor by the operator.

After starting the motor, the operator presses the accelerating pedal, which, by the automatic switch, cuts out the governor, opens the throttle gradually and advances the spark, all of these operations being performed by a single movement of the pedal. When the motor speed reaches approximately 300 revolutions, the centrifugal weights in the clutch are thrown out against the spring sufficiently to gradually force into contact the discs of the low gear, and as these discs run in an oil bath, and are brought gradually together by the force of

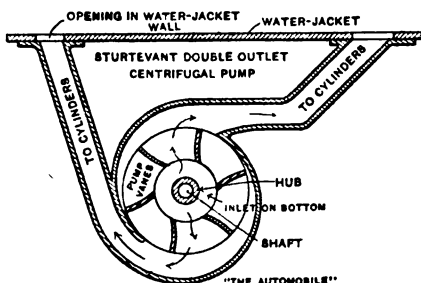

STURTEVANT CIRCULATING PUMP.

the weights, the starting of the car is steady and gradual, the speed of the car increasing until it reaches the speed of the low gear clutch, which is then firmly engaged. If the operator desires more speed, he simply depresses farther the accelerating pedal, giving a wider opening of the throttle and a farther advance of the spark. The motor then accelerates and forces the centrifugal clutch weights out until the springs of the second or third clutch discs are compressed and the corresponding drive is at work.

The movement of the clutch is entirely automatic, and the occupants of the car cannot distinguish the instant when the low-gear clutch ceases to do its work and the car is driven from the higher speed. This easy movement is due again to the slipping of the clutch discs until the motor speed is brought up to a point where the weights have been forced out far enough to securely grip and hold the clutch discs together.

The car is now running on the high speed direct drive. If it is desired to reduce speed the operator allows the accelerating button to rise, reducing the throttle and spark, and thus reducing the speed of the car. Still further reduction to the next lower gear is brought about by closing the throttle until the speed of the motor is not sufficient to cause the centrifugal clutch to operate on the high gear. In this way the slip of the high gear clutch allows the car to drop gradually into the lower speed without any perceptible shock or movement in the transmission.

Still further reduction in the speed of the car is brought about in the same manner; the accelerating pedal is allowed to rise still further, closing the throttle and retarding the spark, and the motor speed is

now reduced to a point sufficient to cause the centrifugal weights to become inoperative on the low-speed discs, and the car is allowed to coast without connection with the motor. In this latter operation the operator usually allows the accelerating pedal to drop back into its normal position by removing his foot entirely from the pedal, and the speed of the motor is at once reduced to that permitted by the governor.

If it becomes necessary to make an emergency stop when the car is running at high speed, the use of the air brakes, in connection with the compression in the cylinders, reduces the speed very rapidly and enables a very quick stop to be made. Independent of these operations, the car can be brought to a standstill very quickly by throwing in the reverse clutch, in which case the low-speed transmission discs, being operated by the centrifugal clutch, would act as a brake for stopping the car.

MOTOR CANNOT BE STALLED.

The motor cannot be stalled, for any resistance that reduces motor speed below 300 revolutions throws out the clutches and the motor runs free. It is the claim of the designers that the operation of the car is as simple as that of an electric vehicle. The hands are entirely free to control the steering device. The car is started, accelerated, stopped, and reversed by a movement of the left foot. The brakes are applied by the right foot. The various working parts of the car are well constructed, the motor being practically of the same design as the one used for some time by this firm in motor boats.

The French Post Office Department is substituting automobiles for the horse-drawn vehicles for the conveyance of mails by road in different parts of the country. Twenty lines are now being equipped with these vehicles, and bids have been asked covering like machines for use in the departments of the Loiret and Cher.

"Private Road, No Automobiling Here," read the signs that have been placed by Mrs. James P. Kernochan, of Newport, at each end of her private road in the Ochre Point district.

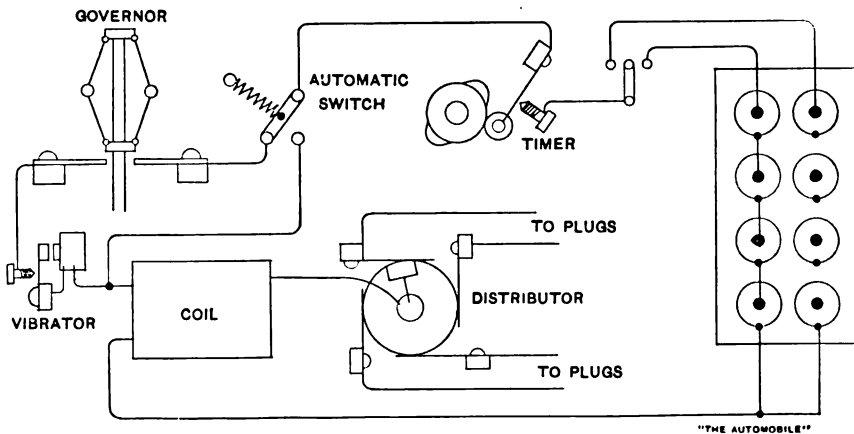

DIAGRAMMATIC SKETCH OF THE WIRING SYSTEM OF STURTEVANT CAR.

Correspondence

Suggestions for Clubs.

Editor THE AUTOMOBILE.

Sir:—We recently organized an automobile club in this city, and the writer was elected secretary and treasurer. We are a little at a loss to know just what is necessary to include in our constitution and by-laws, and I should be glad of any assistance which you might be able to render in the way of sending us a copy of these articles from some club already organized.

W. W.

We suggest that you write to the Automobile Club of America for a copy of its year book, in which you will find the constitution and by-laws in full. You will be able by inspection of these to frame such as will meet your own local needs.

A great deal could be written upon the subject of an automobile club. Most clubs do not do enough to stimulate the interest of individual members, and so after a while the club becomes merely formal headquarters, at which a few men do whatever work is done, the other members taking little or no interest in the organization.

A good deal depends upon the location of club headquarters. This ought to be at some convenient central point, easy of access to the majority of the members and preferably in the vicinity of the automobile district in the city. The quarters need not be extensive; some clubs have been very successfully started in one or two spacious rooms. The quarters should be made attractive with appropriate pictures and the usual club furniture. They should be accessible early and late, so that members who desire to do so can drop in at any time and make use of the telephone, writing table and other conveniences.

The club should be well supplied with county and State maps; an endeavor should be made to accumulate all data possible upon roads, hotel and garage accommodations in its section. A good feature with which to start a club off well and to get the local public acquainted with it is a members' parade which traverses the main streets of the town, thus demonstrating the strength of the automobile interests in the city. This parade could wind up with a house warming, or, if the quarters are not suitable for this, it could be preliminary to a short run to some nearby resort, where a little spread would bring the new members together and get them acquainted with one another.

In smaller cities, where the secretaryship is honorary and where the membership is not sufficiently large to have a salaried club official in constant attendance, a capable steward can be employed who will receive messages, keep the place in order and attend to inquiries of members who drop in.

One of the best features in a newly started club to bring members together is to hold a weekly or fortnightly "experience

night," at which perhaps a short paper of a practical character might be read by some member, raising certain questions of interest to drivers; this to be followed up by a discussion in which each member would have a certain specified time in which to express his opinions. It is generally better to have either a short paper read or a subject assigned, so as to focus attention on some particular program, and the time limit gives every one a chance to be heard. If such discussions are held in conjunction with a smoker, or light refreshments are served, it will help out greatly.

Another feature that frequently is slighted in a club is the library. Many members might not care individually to purchase works on automobile subjects, and a shelf with reference books often helps to bring members to the club. There is also an opportunity before the cold weather sets in to organize short club runs.

Interest can be stimulated sometimes by inviting the members of a club of a neighboring city to drive over and be guests of the club, whose members will go out to meet them and escort them in, their arrival to be made the occasion of some sort of informal social function.

A point that is often overlooked is the establishment of cordial relations with the local press, so that the newspapers from time to time will publish interesting news about the club, so bringing it to the attention of the public that when some important question arises upon which the club desires to express itself the public will be familiar with the organization and its purposes, and will be the more willing to give it an attentive hearing.

Club activities can also be directed to the education of horses with the co-operation of their owners. This was tried very successfully by the Kansas City Club, and by its efforts many spirited trotters were made familiar with the appearance and motion of cars on the road. A club can also do much to remove any incorrect opinions or prejudice of city officials by arranging speed and braking demonstrations, as has been done successfully in a number of cities.

Some Explanatory Letters.

Editor THE AUTOMOBILE:

Sir:—We are not at all pleased at the article which appeared in your paper under date of August 13 relative to the charges made by us to the tourists taking part in the St. Louis run.

We wish to say for your information that we handled about half the cars in the run and received only kind words and praise of the treatment given them by all but one of the party that stopped with us.

We gave them the biggest part of our store, and had our men do all they could to make the stay in Toledo as easy as possible for the travelers, and the only one who complained at all of our treatment was the party with the Oldsmobile, and he was a newspaper man. The writer did not learn his name nor that of his paper, so

cannot give these items, but he was No. 53, and had an Oldsmobile tonneau car. Some miles out of Toledo this car met with a serious accident, and had to be repaired in our store, and for that purpose we detailed one of our men, a good mechanic, who worked most of the night on the machine. The machine was also washed when the work of repair was completed, and he was charged nothing for this.

We enclose bill for this particular machine, and submit it to you as to whether this man was overcharged or not. We do not think he was, nor does any one of a number to whom we have also submitted the items.

Please let us hear from you about this matter. We think you should be more careful in publishing such libellous articles, and might at least communicate with the parties libelled before publication.

THE KIRK-HALL CO.,
E. A. HALL.

Toledo, O.

Following is a copy of the bill referred to in the foregoing as sent us by the Kirk-Hall Company:

"Toledo, August 4.

"Sold to No. 53 Oldsmobile:

Storage	\$1.00
Seven hours, man, at 50c....	3.50
Five and Half Gal. Gasoline	
at 15c.....	.83

\$5.33

"In addition to above he also had a helper a good deal of the time, for which he was charged nothing. If there is anything about this bill that is unreasonable we will be only too glad to make it right."

The charges set forth in this bill are entirely reasonable in our judgment. The original statement concerning the Kirk-Hall Company, and to which they object, was contained in the report of a properly accredited correspondent of this paper, and was published in good faith over his signature. We have caused an investigation to be made, and now voluntarily publish a letter of explanation from our correspondent which we believe will clear up the situation.—EDITOR.

Editor THE AUTOMOBILE:

Sir:—In my correspondence regarding the St. Louis automobile tour I took occasion to remark that the Kirk-Hall Company, of Toledo, had overcharged tourists patronizing it, and had done so in such a way as left them no option but to settle under protest. This information I obtained from the tour officials, and it was given so circumstantially that I accepted it without taking pains properly to authenticate it. Since then the Kirk-Hall Company has offered good evidence that it did not overcharge the tourists, and I have confirmed this, so far as I was able, by writing individually to the tourists who put up there. Although a few of them have not responded, the replies I have received seem to make

it clear that the original report arose mainly, or perhaps wholly, from confusion with certain other incidents with which the Kirk-Hall Company had nothing to do. I append some extracts from letters received from the tourists, which are fairly representative of the rest.

I sincerely regret that I should have been unwittingly instrumental in giving currency to the misleading report above mentioned, and hope that you will give as much publicity as possible to this correction.

H. L. TOWLE.

New York.

The extracts are as follows:

"The bill rendered me at the Toledo garage was correct and very reasonable, I think. Gasoline was only 15 cents per gallon, storage \$1, and washing \$1, etc.

"E. B. G.,
"for J. M. WATERS."

"We had no difficulty, and found no trouble whatever relative to overcharges, and the bill of \$4.35 is correct."

"ROYAL MOTOR CAR Co.,
"by A. D. McL."

"The bill you sent me from Kirk & Hall proved to be correct. I washed my own machine there, as I was afraid they would get water around my batteries. In most places along the road I paid 20 cents for gasoline.

D. B. H."

(Operator Oldsmobile No. 53.)

Clubs Should Prepare Route Maps.

Editor THE AUTOMOBILE.

Sir:—I beg to inquire why no automobile paper takes up the subject of trips through New England, say from Boston to various points, as Portland, White Mountains, Buzard's Bay, Providence, Fitchburg, and the like? I wished very much to go from Boston to Providence, thence to Hartford or Worcester, this summer, but could find nobody and no maps that could furnish reliable information as to a route. I afterward learned there was a fine road from Providence to Worcester, and the road from Boston to Providence I knew well. The road from Providence across country to Putnam or Danielson I could find out nothing about. Detailed trips, with sketch maps of such routes, would be appreciated.

G. A. F.

Meriden, Conn.

We agree with you that information concerning roads is of great value and interest, but also beg to remind you that accurate information on this subject is difficult to procure. Our publication is always glad to publish interesting information concerning trips and tours that may be sent to it by correspondents up to the limit of space which it is possible to devote to the subject. The country, however, is so very large and the use of the automobile is so widespread that no matter how great an amount of this sort of information a paper might publish it would fall far short of the needs. Per-

sons living in one section are, as a rule, not particularly interested in reading about roads in another far distant section. For this reason it is difficult for any one publication to satisfy the general demand from all quarters for this sort of information.

Our own belief is that this work is essentially the work to be undertaken by the automobile clubs. They must, of course, engage in some useful work, and not content themselves with being merely social organizations, for, as a rule, every city of any consequence is already supplied with a sufficient number of social organizations. Clubs are in a position to procure accurate information from their own members, and by an exchange of such information with neighboring clubs can greatly enlarge the

American Car's Clean Sweep.

American cars scored heavily at the hill-climbing contest of the Hertfordshire Automobile Club in England on September 10, the five White steamers entered capturing first, second, third, fourth and seventh places in competition with twelve gasoline cars of English, French and Belgian make, ranging from 6 to 24 horsepower. The following cars were entered:

A 20-horsepower Napier, a 24-horsepower Bollée, five White steam cars, two 12-horsepower Wolseleys, an 11-horsepower Pipe, a 6-horsepower Speedwell, an 8-horsepower Motor Mfg. Co.'s car, an 8-horsepower Crypto, two 7-horsepower Alldays & Onion cars, a 16-horsepower Martini, and a 7-

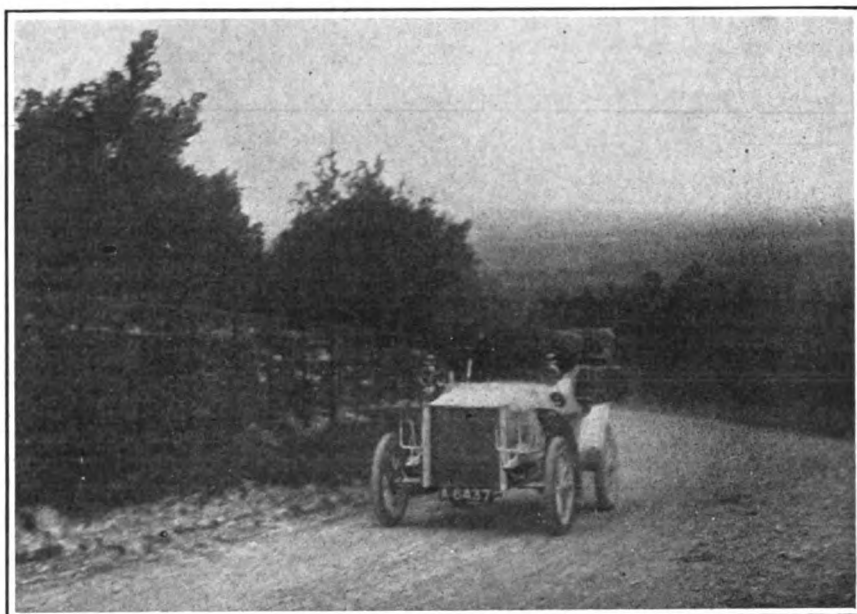

WHITE STEAM CAR WINNING ASTON HILL CLIMBING CONTEST IN ENGLAND.

scope of their road and touring information.

Information derived from a single trip as to road conditions is often misleading, for the reason that an automobilist may pass over a certain road in good weather when it is in fine condition, and the same road may be practically impassable in bad weather; consequently an article written by a tourist who has made a trip in good weather may be misleading to those who desire to take a trip at another season. The clubs are, however, in a position to get a consensus of opinion upon roads in their respective territories under varying weather conditions.

The authorities of English railroads seem to have awakened suddenly to the value of motor cars for local traffic, as cars propelled by steam or electric motors are being placed in service on the Lancashire and Yorkshire, the Great Central, the Midland, the Metropolitan District, the Taff, the Great Northern, the London and South-western, and the Great Western railways. Some roads have already had such favorable experience with motor cars that more of them have been ordered.

horsepower Swift. Only cars fully equipped for touring were eligible, and horsepower was limited to twenty-five.

The fastest time up the grade was made by the Napier, which made the ascent in 1 minute 27 3-5 seconds, and the second best by the Bollée. Under a new system of handicapping that was tried, however, the victory went to the White car entered by Frederick Coleman, which climbed the hill in 2:31 1-5, and the second, third, fourth and seventh places were awarded also to White cars. The Bollée was placed fifth and the Napier sixth.

The handicapping was neither by time nor distance, but was based upon the following formula:

$$\frac{\text{(Average speed)}}{\text{actual h.p.}} \times 1.33 \sqrt{\frac{\text{mean dia. of wheels}}{x}} \frac{\text{wt. loaded}}{\text{wt. empty}}$$

In the discretion of the marshal the steam cars were allowed to leave the starting place for a preliminary run to get up steam, but this privilege could not be claimed as a right.

Ten automobiles are now owned in Canastota, N. Y.



VOL. XI.

No. 15

Published every Saturday by
THE CLASS JOURNAL CO.,
 Flatiron Building, Madison Square,
 NEW YORK CITY.

Cable Address - - - - Autoland, New York
 Long Distance Telephone - 300 Gramercy, New York

SUBSCRIPTION RATES:

United States, Canada and Mexico, - One Year, \$2.00
 Other Countries in Postal Union, - One Year, \$3.00

To Subscribers—Do not send money by ordinary mail.
 Remit by Draft, Post-Office or Express Money Order,
 or Register your letter.

FOREIGN SUBSCRIPTION AGENTS:

ENGLAND:—Iliffe & Sons, Limited, 3 St. Beide Street,
 Ludgate Circus, London, E. C.

FRANCE:—Boyveau & Chevillet, 22 Rue de la Banque,
 Paris.

GERMANY:—A. Seydel, Mohrenstrasse 9, Berlin.

To Advertisers—Copy or changes in orders for advertisements should reach us not later than 5 o'clock p. m. Monday for the issue of Saturday following.

Copyright, 1904, by The Class Journal Company.
 Entered at New York, N. Y., as second-class matter.

The Automobile is a consolidation of The Automobile (monthly) and the Motor Review (weekly).

Copies Printed This Issue, - - 12,000

“ “ Since Jan. 1, - 494,000

Illegal Racing on the Course.

It is difficult to believe in the good faith of the organized opposition to the Vanderbilt Cup race which, under the title of the People's Protective Association, raised an eleventh hour protest against the holding of the race in Nassau county, Long Island. Permission to use certain highways in the county was granted by the Board of Supervisors about one month ago, and not until the week of the race was the association heard from. At a public meeting, held in the court house in Mineola last Tuesday, the Board of Supervisors heard denunciations from one G. M. Bennett, acting as mouthpiece for the association, and arguments from representatives of the 1904 Race Commission, and from residents and taxpayers of the county, in favor of holding the race on October 8.

The People's Protective Association, we are informed, was organized about ten years ago by the farmers of the county to prevent horse stealing, and it has ever since maintained its organization. Therefore, it was not an association hastily organized to oppose the race, which might reasonably have encountered delays in getting together a united protest. It deferred open opposition until the last moment, apparently hoping thereby to embarrass the race management, which had completed all preparations for holding the race, and could not call it off without outrageously breaking faith

with the entrants, many, if not all of whom, had expended thousands of dollars and much unrecoverable time, in getting ready. At the public hearing, this organized opposition narrowed down to a pusillanimous effort to spoil good sport that evidently disgusted the sturdy farmer audience, so that when a vote of confidence in the supervisors was proposed, only a solitary "No" voiced the opposition.

In the earlier stages of the meeting, however, a number of speakers who might be classed with the opposition were heard from. They represented the substantial farming and horse breeding element of the county, and in a manly, straightforward way expressed themselves in favor of the race on October 8, but absolutely and unequivocally opposed to the reckless speeding over the course by certain of the contestants on all other days of the week. This form of opposition was most commendable and it is to be hoped brought home to the race management a realizing sense of the obligations imposed on them by good sportsmanship and good taste, not to abuse the courtesy and hospitality of the majority of the residents of Nassau county, who have permitted the use of the roads for the race on Saturday. In response to this protest, Chairman Pardington publicly pledged the race commission to an enforcement of the rule that all of the racing machines should thereafter carry their official number conspicuously, and that any entrant against whom a charge of illegal speeding was proven would be promptly disqualified.

It is regrettable that such action should have been forced from the racing commission, and that it had not previously taken cognizance of the notorious fact that many of the competing cars were being driven over the course at illegal speeds, including one owned by a member of the commission.

A contest of this sort needs to be handled man-fashion, and an exhibition of self-restraint is to be looked for, at least among the race officials.

Automobile Race Handicapping.

Handicapping automobile track races is not an especially grateful task, nor is it apt to be conspicuously lucky. If in a five-mile race the handicapper gets the field under the wire with no more than half a mile separating the winner from the "also rans," the public is learning to think that he has done pretty well. And so he has, considering the prodigious difficulties in the way of calculating or estimating the speed of an unknown car with no track record. When we consider the manifold and complex factors to be considered even in calculating the speed on a straightaway and then add the retarding influences of a soft track, of unbanked or insufficiently banked turns, and of numerous other cars competing in the same event, for most of

which the faster cars must frequently turn out, it is not easy to define the limits of complexity which the problem may reach. Add the fact that to miss one's guess by a bare second per mile means, for a 60-second car, an error of nearly 150 yards at the finish of a five-mile race, and we see that the handicapper's job is as exacting as it is difficult, if a finish at all close is demanded.

Now, here is just a suggestion for the worried handicappers who find the intricate calculations needed for approximate accuracy too complex, or for the busy handicappers who can't spare the time. It is not scientific, and it proves absolutely nothing as to the merits of the cars, but it ought to give at least passably close finishes. It is to handicap every machine on the basis of a previous performance on the same day, either in another event or in a special run against time. Then, to guard against drivers "pulling" their cars, require that every car shall make the same average speed in the handicap as in the preliminary within a margin of, say, a second faster and two seconds slower to the mile; any car exceeding its margin to be disqualified.

Such a race might make the technician yawn, but it would entertain the public, and the public is much in need of entertainment at the average track races. Who can suggest a better plan?



Premeditated Law Breaking.

Within the past few days one of the leading and supposedly one of the most honorable manufacturers of automobiles in the country, has sent out to the press advance notice, with photographs, of an intended defiance of speed laws in an attempt to lower the Chicago-New York record. Since the illegal trip started, the publicity department of this company has kept up a rapid fire of telegrams announcing the progress of the car, the last an invitation to meet the president of the company at the New York garage on the completion of the trip, which, the company wires, will "break record ten hours."

Without exception this is the most amazing performance which has come under our notice for a very long time. That the president of a large automobile manufactory, who has held high office in the National Association of Automobile Manufacturers, should invite the press to a celebration of successful defiance of the law is, we believe, without precedent, and certainly could find no parallel in the kindred mechanical industries of the country. Happily this is an isolated case and in no way representative of the spirit and intent of those in control of the industry as a whole.

If there is any comparative degree in excuses, the present occasion is the more inexcusable on the eve of the Vanderbilt Cup race. In this race, the company re-

ferred to could have entered a car and been on an equal footing with other of the American entries—two of the latter are touring cars. Under the sanction of the law and in the range of eager interest of thousands of persons who are following the cup race, the company could have taken its chance of a successful performance. So it has not even the excuse of desired publicity to offer.

What would be thought of a manufacturer of shotguns who would send out announcements of an intention to give an exhibition of excellence of construction by shooting birds out of season?

There is some excuse for the automobilist who fails to resist the temptation to let out his machine on an unfrequented stretch of road; there is absolutely none for premeditated assault on the speed laws of several States. As we have frequently pointed out, aside from all questions of law and morals, this conduct shows very poor business judgment—it is suicidal. Temperate use of the automobile will gain for it a place in the esteem of non-users and hasten the day when, as in the case of horse-drawn vehicles, speed will not be specifically curtailed, but will be left to the decency and good judgment of the driver. Inconsiderate and illegal use of machines will, on the contrary, keep alive prejudice and create a public opinion that will demand the enactment of more oppressive laws.



An important precedent has been established by Chairman McClintock, of the Massachusetts Highway Commission. At the recent hearing in Boston of the cases of a number of automobilists arrested at Shrewsbury for alleged fast driving, he held that identification of an automobile by the number on the license tag was insufficient unless supplemented by some description as to color or shape. Evidently the commissioner recognized the likelihood of misreading the number on a car, especially when it comprises four or five figures, and perhaps is covered with dust. Of equal importance is his ruling that the owner of an automobile is responsible for the car, even if it is taken out on the highway without his knowledge or consent. But it is hardly conceivable that this applies to the use of the car without the knowledge of the owner by any other than a member of his household or by his employed operator; otherwise the owner could be held responsible for damage caused by the car in the hands of a thief who had broken into his stable and stolen the car.

Smith—"Why is Brown carrying his arm in a sling?"

Jones—"O, his horse kicked him and broke it. He went out horseback riding the other day instead of taking his automobile, and when the horse balked he got off and twisted its tail, from force of habit, you know."

Importers' Salon.

The difference existing between the National Association of Automobile Manufacturers and the importers of foreign cars on the show question seems to be irreconcilable. The importers are firm in their determination to hold a show with or without a sanction from the Association, and the officers of that organization declare that if the importers hold a show without a sanction, they cannot display at the Chicago, or Boston, or any other sanctioned show. Moreover, it is intimated that the proposed Importers' Salon in New York will not be sanctioned. Curiously enough, representatives of both the importers' association and the N.A.A.M. state that whatever soreness exists is on the other side.

Some of the importers assert that they do not believe it advisable to hold separate shows outside of New York, with the possible exception of Boston; but they are prepared to hold an opposition show wherever an exhibition under the auspices of the National Association is held. Officials of the N.A.A.M. state that in the event of receipt of an application from the importers for a sanction, the application would be given due consideration, just as would any other application; but nothing, it is declared, could be farther from the minds of the importers than to apply for one. Their plan of action will be adhered to strictly, and they are abundantly able to support their own exhibition; they even claim that some of the manufacturers of high-grade American cars, as well as of parts and supplies, would be glad to show at the importers' exhibition in New York, and probably elsewhere.

The N.A.A.M. officials counterbalance this statement by the declaration that they will have an excellent exhibit of foreign cars at the Madison Square show, which will not suffer in the least from the segregation of the importers who have decided to act independently.

INDEX

NEW YORK AUTOMOBILE SCHOOL.

The New York Y. M. C. A. has decided to take up the work of training chauffeurs, and with this end in view three courses of study will be established. Dr. Charles E. Lucke, of the Engineering Department of Columbia University, will give a lecture a week for six months, dealing with the automobile in a general way. A designing and draughting class will be under the instruction of Professor Trowbridge, also of Columbia University, while Clarence B. Brokaw will instruct the students in the practical part of the business, including the actual operation of cars, their adjustment and repair and the numerous items that go to make up the education of a practical chauffeur. The two latter will be 3-month courses. Winthrop E. Scarritt, president of the Automobile Club of America; A. R. Shattuck, S. A. Miles, of the N. A. A. M.; E. T. Birdsall, Windsor T. White, Percy Owen and Professor F. R. Hutton, of Columbia University, will have the direction of the chauffeur's department of the Y. M. C. A., as an advisory board. Owners of automobiles who wish to take advantage of these courses will be allowed to do so.

ACETYLENE BURNER PATENT.

The acetylene burner question, which has occupied the Courts for the past three years, appears to be in a fair way of being definitely adjusted. The suit of M. Kirchberger & Co., of New York, against the Acetylene Burner Co., which was decided in 1903, has been carried up to the Court of

Appeals, which has rendered a strong decision sustaining the claims 1, 2 and 3 of the patent, and a subsequent application for re-opening the case has been denied by the Court, with a strong opinion re-affirming the former decision. As a result of the decisions, Kirchberger & Co., the general licensees, have brought injunction suits against dealers and users of acetylene burners, several of which have been decided in their favor.

The first three claims of the patents held by the plaintiffs cover the method of burning the gas in such a manner that the gas jet as it leaves the channel of the burner is surrounded by an envelope of air. As there is said to be no other way in which acetylene gas can be burned, it appears that practically every burner comes under the scope of this patent. Judge Ray, of the United States Circuit Court of New York, said in his decision sustaining the patent: "The defendant infringes on the patent because it appears it is necessary to infringe in order to burn acetylene gas successfully."

OLDFIELD IN TROUBLE.

Chicago A. C. Asks His Disqualification for Contract Jumping.

Barney Oldfield is in danger of being permanently debarred from taking part in races under the sanction of the American Automobile Association, his disqualification having been requested by the Chicago Automobile Club. Oldfield apparently made contracts to race in Chicago and in Pittsburg on the same date, September 30, and when he favored the Pittsburg meet with his presence the Chicago automobilists were much stirred up and at once demanded that he be disciplined in the severest possible manner. The matter was discussed at some length at a meeting of the A. A. A. directors, held on Tuesday, October 4, but as Oldfield had not yet replied to a request for a statement of his side of the case, no definite action was taken, and the matter is held in abeyance pending the receipt of Oldfield's story.

Robert W. Spangler, assistant secretary of the Chicago Automobile Club, was present at the meeting in the interests of his organization. He stated that the members of the Chicago Club were very much incensed at Oldfield's action and were determined to push the matter to the limit.

The A. A. A. directors decided to hold a banquet in New York City on the Friday preceding the Madison Square Garden automobile show, which is scheduled for January 14 to 21. Those present at the meeting were Harlan W. Whipple, in the chair; A. R. Pardington, Dr. W. E. Milbank, Dr. Julian A. Chase, George E. Farrington, Elliott C. Lee, Augustus Post and C. H. Gillette.

A writer in a daily paper not a thousand miles from New York city calmly asserts that a motor bicycle capable of running thirty miles an hour can be stopped when going at its highest speed within its own length. Perhaps it can; a solid stone wall would do the trick, but it is disagreeable to think of the muss the rider would be in after the dust settled.

Harry—"Why in the world did Maud engage herself to a man so much shorter than she is?"

Mary—"Oh, you never notice the difference when they are in an auto.—*Chicago News.*"

CROSS COUNTRY CLUB RUN.

C. H. Gillette the Apparent Winner of Philadelphia Club's Contest.

Special Correspondence.

PHILADELPHIA, Oct. 3.—The second annual run of the Automobile Club of Philadelphia for the H. Bartol Brazier Cross-Country Challenge Cup was run off last Saturday over a 76-mile rectangular course, with Ambler, Phoenixville, West Chester and Philadelphia at the four corners. Although the contesting cars numbered only seven, the run was voted a great success, and, owing to the handicaps, the finish was so close between several of the cars that an official decision will be necessary before the winner can be announced. According to the figures turned in by the judges, C. H. Gillette, secretary of the A.A.A. (10-horsepower Pope-Hartford), secures first place, although W. C. Griffith has lodged a claim for delay, which may make the contest a tie.

There was no limit on the power of the contesting cars, and the officials allowed handicaps ranging all the way up to an hour and a quarter, Gillette and Griffith being given the limit. The cars that finished fourth and fifth are tied, Hooper and Beale having made the same corrected time.

Calculating the times was a hard task for the mathematically rusty local reporters, as is evidenced by the fact that every Sunday paper had the order of finish and the time figures different from all the others.

The fastest actual time was made by Horace A. Beale, Jr., in the same 40-horsepower Locomobile in which he won the Atlantic City run last June. Starting from scratch, he finished third in 4 hours 6 minutes, including all stops. The next best actual time was that of S. E. Hutchinson, whose 18-horsepower Panhard covered the course in 4:14, seven minutes faster than McMillan Hooper in his 30-horsepower Jones-Corbin.

The cars were sent away from the starting point, in front of the new Bellevue-Stratford, Philadelphia, in full touring trim, at five-minute intervals in the following order: McMillan Hooper, 30-horsepower Jones-Corbin, accompanied by George H. Jones; Horace A. Beale, Jr., 40-horsepower Locomobile, and W. H. Coleman; W. O. Griffith, 10-horsepower Cadillac, and Mrs. Griffith; C. H. Gillette, 10-horsepower Pope-Hartford, and W. H. Ro-cap; L. Knowles Perot, 10-horsepower Franklin, and Mrs. Perot; S. E. Hutchinson, 18-horsepower Panhard, and Miss Centra Hutchinson, W. G. Cochran and J. A. Forkin; Kern Dodge, 10-horsepower Oldsmobile, and Miss Helen Greene.

Apart from the necessity of reporting to the judges in the four towns named, the contestants were not restricted as to the routes they should take. Gillette, who drove the same car in which he made the St. Louis run, knew little or nothing of the roads, and took along a local newspaper man to keep him posted. But it happened that the guide was almost as ignorant of the best routes as Mr. Gillette, and the A.A.A. secretary covered a total of about 90 miles as a result of his efforts to locate the judges at the several stops. Had it not been for that, he would have won with a large margin to spare.

The going as far as Phoenixville was good, the only delays being caused by punctures, but after leaving the half-way point the travelers' troubles began, the roads for miles being made apparently of caked mud with a liberal sprinkling of large, loose stones. Lamps were jolted off, spark plugs loosened, wires broken, and the cars' occupants generally shaken up.

Another bad ten-mile stretch was en-

countered after leaving West Chester, but some of the contestants avoided this by a detour to Paoli and thence home by way of the Lancaster pike, where, however, great caution had to be observed in the matter of speed. No trouble with constables was reported, however—possibly for the reason that if any contestant had to be cautioned by an officer he was, according to the rules of the run, to be disqualified. With a view of allowing time for protests of this character to reach them, the officials of the run will postpone the announcement of the result for a week or ten days.

A. H. Chadbourne, the present holder of the cup, was expected to start, and, indeed, had announced his intention of making an effort to retain the cup, but failed to report at the starting point.

In the evening the Automobile Club of Philadelphia held a smoker at the Manufacturers' Club, at which the feature was an address by Secretary Gillette on "Touring and Racing," in the course of which he gave his hearers an interesting account of his experiences during the recent New York-St. Louis run.

SUSPENSION OF LICENSE.

Massachusetts Highway Commission Establishes a Precedent in Punishment.

Special Correspondence.

BOSTON, Oct. 3.—The Massachusetts Highway Commission has announced its findings in the Shrewsbury automobile speeding cases, and in six counts out of seven has upheld the automobilists against the town authorities.

Shrewsbury is a town in the central part of the State, on the road to New York. A State road passes through it, and many automobilists use the road every day. The town selectmen boasted that they would put a stop to speeding, and one Sunday, in August, placed the town constable with a stop watch on the road. He gathered evidence (the time taken by certain automobiles to pass over a given distance and their numbers) against seven automobilists, and the selectmen then petitioned the highway commission to revoke the licenses of these men. In the preliminary hearings one man proved that he had sold the automobile bearing his number before the day on which he was accused of speeding, and another proved an alibi.

Of the five cases taken under consideration, that of Asa Goddard, president of the Worcester Automobile Club, was the only one in which the commission decided that punishment was necessary. The commission found that he had been convicted twice of operating his automobile at an unlawful rate of speed, and his licenses was, therefore, suspended for a period of two weeks, beginning October 8. In the cases of C. L. N. Cushman, of Newton, E. F. Bell, of Beverly, and Frederick L. Ames, of North Easton, the commission decided that as none of them had previously been found guilty of unlawful speeding the cases should be placed on file.

This position on the part of the commission indicates that it considers itself a court of last resort and has provided a way of punishing automobilists who repeatedly exceed the speed limit. In the other case, that of L. P. Sims, of Worcester, the complaint was dismissed, as Mr. Sims brought witnesses to testify that his machine was not out of the garage on the day he was accused of driving it in Shrewsbury. The town constable testified that a machine bearing Mr. Sims' number passed through the town, but could give no better description of it than the number. This evidence was not considered sufficient.

CANADIAN ROAD INSPECTION.

Officials of Ontario Counties See Improved Roads from Automobiles.

Special Correspondence.

TORONTO, Oct. 3.—A demonstration automobile drive in the interest of good roads is the latest innovation of the automobile world in Canada.

The drive was over the roads of Wentworth County, of which a prominent bicyclist said ten years ago, after a similar tour: "It is rumored that hell is paved with good intentions. If that is the case, the Wentworth roads beat hell, for even the intentions are absent."

Since then the county and the government of Ontario province have spent large sums annually upon improvements to these roads, and the purpose of the drive was to inspect the progress that had been made. Upwards of fifty miles of up-to-date highway were ridden over during the day.

County Warden Kenrick hit on the plan, and extended invitations to the members of the county and township councils of five adjacent counties. He enlisted also the co-operation of the Hamilton and the Toronto Automobile clubs. Both clubs responded readily, and at the appointed hour President Greening, of the Hamilton Automobile Club, had six automobiles in line, while President Doolittle, of Toronto, had fifteen.

A. W. Campbell, deputy commissioner of public works and commissioner of good roads for Ontario, was a guest of the party.

The start was made from the court house square, Hamilton, at 9:30 a.m., Dr. Doolittle leading, with Warden Kenrick and Deputy Commissioner Campbell in his car. He was followed by President Greening, of Hamilton. Altogether, nearly thirty automobiles were in line.

The part of the county traversed is the most beautiful in Ontario province. The return to Hamilton at noon was made by way of Ancaster, on a strip of road as fine as any on the continent. After a luncheon and some speeches the drive was resumed at 2:30 p.m., the course being over the Valley road, east as far as Stony Creek, where Hamilton Mountain was climbed. Some of the smaller cars found it necessary to discharge their passengers in order to accomplish the ascent. For some distance on the return journey the road wound along the brow of the mountain, affording a magnificent view of Lake Ontario and the surrounding country. Road-making is in progress along this road, and quantities of broken stone was spread on the surface, but no punctures occurred.

The trip was brought to a conclusion at Mountain View Park, where tea was served. The tour showed the automobilists what was being accomplished in the way of road improvement, and proved to the authorities that the automobile is not the menace to public safety that has been commonly supposed. The score and a half of automobiles covered a distance of fifty miles, and on only one occasion was it found necessary to hold a horse, and in this instance the animal had been left unattended and untied.

ST. LOUIS RACES ON A NEW TRACK.

Special Correspondence.

ST. LOUIS, Oct. 3.—Arrangements have been made to hold a second race meet in St. Louis on October 22 and 23. It will be much larger than the one of August 20 and will be held on the new Union track, near the National Bridge. Union track is one of the best in the country; its curves have an elevation of 47 inches on the outside and are admirably adapted to motor racing.

In an interview with Judge George B. Sidener, secretary of the racing committee, he said: "We shall watch the results of the Vanderbilt race, and if oiling lays the dust there we shall use the same methods here. We intend to take no chances whatever of any accidents. The Union track is built higher on the outside and is as perfect as a track can possibly be. We expect such men as Oldfield, Ford, Kiser and A. C. Webb. Webb Jay will be here with a new White racer that is the first of its kind yet built. Every arrangement is being made for a big event."

NOTES OF THE CLUBS.

NEWARK, N. J.—The New Jersey Automobile and Motor Club membership now numbers 290, making this club one of the largest organizations of the kind in the country. Mayor McClellan, of New York City, is a member of the club.

BUFFALO.—At its regular monthly meeting the Buffalo A. C. elected Dal H. Lewis secretary, to fill the vacancy caused by the resignation of Fred J. Wagner, who has removed to New York City. It was also decided to change the date of the annual election from October 12 to January 1.

KANSAS CITY.—The A. C. of Kansas City has decided to hold a run to Leavenworth, Kan., thirty miles, October 15, returning the following day. This run has not been attempted since two years ago, when the rough and stony roads put a number of cars out of business.

PITTSBURG.—The matter of making the A. C. of Pittsburg an affiliated branch of the A. A. A. is being discussed by the members. The large city clubs are anxious that the Pittsburg club should join, but considerable care will be taken by local officials before allying themselves with the national organization.

DALLAS, Tex.—The first of a series of runs of the Dallas A. C. was held the last week in September, to Lancaster and return. The cars assembled at Garrett's garage, and, besides many women, a string band and refreshments were included. At Lancaster a spread was enjoyed, and the return trip made without mishap of consequence.

BURLINGTON, Vt.—An automobile club with a membership of twenty-five persons was formed in Burlington on September 21. Officers for the ensuing year were elected as follows: President, Dr. D. C. Hawley; vice-president, O. S. Presbrey; secretary, E. A. Brodie; treasurer, G. A. Churchill. Owing to the cold weather the run of automobilists from different parts of the State to Burlington did not materialize. Only a few stray cars went to the city, and the banquet, which it had been planned to hold at the Van Ness House, was abandoned. In the evening those who were in Burlington met with the local automobilists, and matters of interest, including good roads, were discussed.

PITTSBURG.—At a meeting of the A. C. of Pittsburg, held September 28, it was reported that many signatures had been secured to a petition for the macadamizing of the Greensburg pike from the intersection of the street railway line to the Allegheny county line, and a committee was appointed to confer with the county commissioners with regard to the improvement requested. This road is one of the favorite routes for motorists going out of the city and leads through a fine section of country. A committee has also been appointed by the club to request Director E. J. McIlvain, of the automobile department of Public Works, to annul the order forbidding auto-

mobiles in Riverview Park. Recently the director decided that in the interest of public safety, as he deemed it, autos should be kept out of the park altogether.

TACOMA, Wash.—Automobile owners of Tacoma are actively at work in an effort to organize an automobile club. A meeting of owners has been held and a committee appointed to secure signatures to a charter list. Another meeting will be called for at an early date, when a permanent organization will be effected.

MANCHESTER-BY-THE-SEA, Mass.—At a recent meeting of the North Shore A. C., held at the home of President Walter D. Denege, of St. Louis, "Villacrest," a circular was framed, and has since been distributed among the members, calling attention to the abuse of existing automobile laws and urging all to use their influence in having the speed regulations properly observed. The following officers were also elected at this meeting: President, Walter D. Denege, of St. Louis; vice-president, Dr. C. Thorndike Parker, of Boston; treasurer, Quincy A. Shaw, Jr., of Boston; secretary, Charles C. Walker, of Chicago. An executive committee was elected, composed of the officers named, together with Henry P. McKean, of Philadelphia; Arthur Silsbee, of Boston, and Frank Seabury, of Boston.

AMERICAN SHOW IN TORONTO.

Canadians Plan to Invite Builders in the States to Exhibit There.

Special Correspondence.

TORONTO, Oct. 3.—A movement is on foot here to hold an automobile show here next winter and to invite the licensed automobile manufacturers of the United States to exhibit at Toronto, as one of the points on the winter show itinerary.

A special meeting of the Toronto Automobile Club was held last evening when the scheme was discussed, and it was decided to spare no effort to carry it out. An application has been made to the Dominion authorities for permission to use the local armories, which afford an ideal building for the purpose as they are very extensive and are well lighted.

The main difficulty is to fix a date that would be suitable. About the only practicable time is that between the New York and Chicago shows, in the last of January and early part of February. It was thought desirable to have the show in the interval between the Detroit and Buffalo shows, but as the Cleveland show comes then the only possible plan would be to split the exhibit, which is not considered satisfactory.

Arrangements will be made with the Customs Department to have the exhibits brought into Canada in bond, without the payment of duty. Negotiations have already been entered into with a number of the manufacturers on the subject and they have expressed their desire to come to Toronto, particularly those whose machines are sold in this country. Local automobilists are enthusiastic about the project as they believe it will help immensely to popularize the sport in Canada, a result much to be desired in order to secure certain privileges which they do not at present enjoy.

MANUFACTORY FOR KANSAS CITY.

Special Correspondence.

KANSAS CITY, Oct. 1.—D. L. McClintock, of Fort Wayne, Ind., has applied for a United States charter for the McClintock Automobile and Engine Company, of Kansas City. The capital stock named in the charter is \$375,000. The directors are all

Kansas City men with the exception of Mr. McClintock. They are Hiram Landrus, Edwin Bond and Fred J. Close. Work on the plant is to begin within thirty days.

The company proposes to construct steam and gasoline vehicles upon designs by Mr. McClintock. The cars, it is asserted, will be so constructed that the power can be applied to either the front or the rear wheels. The steam cars are to be fitted with condensers.

WASHINGTON TRADE ASSOCIATION.

Special Correspondence.

WASHINGTON, D. C., Oct. 3.—Preliminary steps have been taken toward forming a trade association among the automobile dealers of this city. At a meeting called by John C. Wood, manager of the National Automobile Co., all the dealers responded and gave their support to the movement. Various committees were named to take the necessary steps toward perfecting the organization, and it is expected that the new association will be launched within the next ten days.

There is urgent need for a trade association here, if for no other reason than to establish uniform prices for storage and repair work. All sorts of prices are now in vogue, and as a result there is little profit in the business and much dissatisfaction. With the dealers banded together for mutual protection much good to the trade and to the sport can be anticipated.

RECENT INCORPORATIONS.

Milwaukee Motor Co., Milwaukee, Wis.; capital \$25,000. Incorporators, F. L. Ford, Edgar E. Warner and A. W. Warner.

Mason-Harvey Co., Chicago, Ill.; capital \$2,500; to manufacture and repair automobiles. Incorporators, W. W. Harvey, W. R. Mason and A. A. Hodges.

Eleanor Automobile Co., Washington, D. C.; capital \$300,000. Incorporators, A. Von McAllister, B. A. Horst, Robert McElroy, L. T. Everitt, and Messrs. Frere, McLaughlin and Ochsenreiter.

Kelley-Bridgett Co., Danville, Ill.; capital \$5,000; to manufacture automobiles. Incorporators, E. J. Kelley, W. M. Bridgett and G. T. Buckingham.

Amos-Pierce Automobile Co., Syracuse, N. Y.; capital \$1,000. Directors, C. L. Amos, H. C. Pierce and G. H. Denison, all of Syracuse.

The Hayne Motor Co., Plainfield, N. J.; capital, \$25,000; to manufacture and deal in motor vehicles. Incorporators, Harrison Coddington, Charles F. Fulmer, Charles F. Hyne and William B. Harsel.

McClintock Automobile & Engine Co., Kansas City, Mo.; capital, \$375,000; to manufacture automobiles. Incorporators, D. L. McClintock, Hiram Landrus, Edwin Bond, Fred J. Close.

Michigan Motor & Machine Co., Washington, D. C.; capital, \$200,000; incorporators, William F. Koeller, Peter Ziebrigg, E. W. McCormick, E. M. Freeman and B. E. T. Kretschmann.

Minneapolis Automobile Co., St. Paul, Minn.; capital, \$10,000; incorporators, A. E. Paegel, Ernst G. Timme and Lucius S. French.

Oregon Auto Despatch Co., Portland, Ore.; capital, \$30,000; to run freight and passenger busses; incorporators, H. W. Goddard, C. A. Bell and A. C. McIntosh.



The Boston agency for the Cadillac cars for 1905 has been secured by A. T. Fuller.

Thirty-five automobiles are owned and operated in Zanesville, O., but a club is not yet in sight.

An automobile mail route has been established between Mahatsara and Tananavico, Madagascar.

Redwood Falls, Minn., now boasts of the fact that it numbers among its citizens four owners of automobiles.

E. W. Oatley & Company have opened a garage and salesroom at 188 Worthington street, Springfield, Mass.

An automobile repair station has been established on North Vermillion street, Danville, Ill., by Kelly & Bridgett.

George W. Eason, a rural free delivery mail carrier of Ravenna, Mich., has adopted the automobile for use on his route.

Several automobile railroad inspection cars have been ordered by the Colorado & Southern Railroad for use by the division officers.

Since the recent passage of an automobile ordinance in Birmingham, Ala., the city clerk has issued twenty-five permits to owners.

The Illinois State Commission at the World's Fair has purchased an automobile for the use of its members in making their tours of the grounds.

The Western Motor Works, of Logansport, Ind., is preparing to install a lot of new machinery to greatly increase the capacity of its plant.

An automobile garage and repair station is now being constructed at Thirteenth street and Missouri avenue, East St. Louis, for V. Shruggs.

Alexander Brothers have established an automobile station at 406 North Third street, Philadelphia, in the premises recently acquired by them.

A model L Packard has been taken abroad by Hamilton Carhart, of Detroit, who will use the car in making extensive tours in England and Europe.

Tom Cooper has been appointed general agent of the Matheson Motor Car Company, Limited, of Holyoke, Mass., in place of F. H. Fowler, resigned.

The King of Italy has accepted the position of honorary president of the Turin International Automobile Salon, which has been scheduled to open on February 15 next.

"Mayor Bill" Smith, the well-known motorist of Plainfield, N. J., is now actively engaged in the automobile business, having become senior partner of the Plainfield Automobile Garage Co.

The Palace Automobile Station was recently opened at 671-673 Main street, Worcester, Mass., by L. Bean and T. Hanson, who will handle the Packard, Yale, Elmore and Northern cars.

Thomas Hay, sales manager of the National Motor Vehicle Co., of Indianapolis, has taken personal charge of the exhibition of the above company at St. Louis, and will probably remain there for the next two or three weeks, during which time a

number of important agencies for the National line will be placed with prominent Western dealers, who have appointments to meet Mr. Hay at the World's Fair during his stay.

The Board of Public Safety of Cincinnati, O., is considering the question of furnishing the fire department with steam-driven fire engines and the police department with automobile patrol wagons.

The Berwin Auto Company has opened a garage and repair shop at 140 North Seventh street and 139 North Hall street, Allentown, Pa., and would be pleased to receive copies of trade catalogues and price lists.

The Hopson & Chapin Mfg. Co., of New Haven, Conn., has installed a special machine for boring cylinders, so that the concern, which makes a specialty of foundry work, can turn out completely finished cylinders for explosive motors.

"Bob" Garden, for many years a power in cycling trade circles in Chicago and Philadelphia, has resigned the managership of the local branch of the Pope Mfg. Co. in the latter city, and is now general manager of the Quaker City Automobile Company, of Philadelphia.

The R. E. Olds Company, Lansing, Mich., announce that the name of the concern has been changed to the Reo Car Company, and the car manufactured will be called the Reo car. This change is made in order to avoid the possibility of confusing the new company with the Olds Motor Works.

The Maryland Automobile Co., of Baltimore, composed of D. A. Clark, M. W. Higgins and J. J. Mason, has filed notice of dissolution. The business will be continued under the same name by Messrs. Higgins and Mason. The agency for Knox cars will also be continued by the new firm.

William E. Chandler, of Warner, N. H., former United States Senator and Secretary of the Navy, was struck by the crank of his automobile recently, while endeavoring to start the motor, and sustained a fracture of both bones of his left forearm. The Senator is now chairman of the Court of Spanish War Claims.

The traffic manager of the Florida East Coast Railroad has made arrangements with the Clyde Line officials for the transportation of automobiles on the Clyde Line steamers from Boston and New York to Daytona, Florida, at the rate of \$1.93 per 100 pounds. This rate will be effective between November 1 and April 30.

Signor Marconi, of wireless telegraph fame, was stopped recently while automobiling on the Boulevard Lafayette, New York, by a motorcycle policeman, and charged with running at illegal speed. The party, which included a young lady, was haled to the police station, where the chauffeur was held in \$500 bail, which Marconi furnished.

At the Brighton Beach automobile races, in the vicinity of New York City, on October 22, the race for the Sea Breeze Cup will be held under novel conditions. Instead of adopting the conventional method of handicapping, the cars will be handicapped according to price. The event being for cars costing \$1,000 and under, the \$1,000 cars will be on the scratch, while the lower priced cars will receive handicaps, which

increase in proportion as the prices decrease. A dollar a yard is the price of a handicap. There will also be a race for the Coney Island Cup, for cars to carry three passengers, and an International Cup race, in three-mile heats, and a five-mile final. Entries will be received until Monday, October 17, by Alfred Reeves, 150 Nassau street, New York City.

An automobile mail and passenger service went into effect between the towns of Albany and Newton, Ga., on October 1. There is no railroad communication between these places, which are about twenty-one miles apart, and much inconvenience has been caused by the lack of transportation facilities.

Townsend & Company, Houston, Tex., write that they desire to obtain unmounted photographs, about 8 by 10 inches, of the principal makes of gasoline automobiles, to frame and display in their garage. Also photographs, of the same size, or larger, of racing automobiles, including those taking part in the Vanderbilt Cup Race. Townsend & Company will open their garage within a short time, and will act as agents for several makes of automobiles.

Robert F. and Roy F. Britton and associates have purchased A. L. Dyke's interest in the A. L. Dyke Auto Supply Company, Walton avenue and Olive street, St. Louis, Mo., and will conduct the business under the same corporate name. The company occupies its own building, measuring 125 feet wide and 148 feet long. As an evidence of the enterprise of the concern, it is said that orders for air-ship supplies from aeronauts at the St. Louis Exposition are being filled.

The National factory, at Indianapolis, has been closed for ten days for the taking of the annual inventory, and in this time a number of changes were made in the machinery and buildings. The company resumed operations October 3, and within a short time will announce its 1905 line of Nationals. No change in agencies in the larger cities of the East is contemplated, the system of agencies being complete and the representatives well pleased with the line for the season of 1905.

The Bretton Woods, N. H., "Perfection Tour" brought out about twenty starters out of the fifty entries, but owing to the unfavorable weather only six succeeded in reaching the objective point of the run. The arrival at Bretton Woods was celebrated by a banquet at the Mount Pleasant Hotel, given by the proprietors, Messrs. Anderson and Price, which was partaken of by some 40 guests. The return trip was abandoned owing to the terrible condition of the roads and the inclemency of the weather, the tourists returning by train.

The firm of Charles Jarrott & Letts, Limited, London, England, the English representative of the Oldsmobile car, started two Oldsmobiles, a 7-horsepower runabout and a light tonneau, on a 3,000 mile endurance run through England, Ireland and Wales, on Wednesday, September 21. The plan laid out calls for a run of 50 miles each morning and another 50 miles each afternoon, until the total distance is completed. Thirty days will be required to make the run, if the arrangements made are not interfered with by unforeseen delays.

THE AUTOMOBILE

WEEKLY

NEW YORK—SATURDAY, OCTOBER 15, 1904—CHICAGO

10 CENTS

HOW THE VANDERBILT CUP RACE WAS WON.

FRANCE won the William K. Vanderbilt, Jr., Cup when Heath drove the great Panhard racer across the finish line at 1:08:45 o'clock last Saturday afternoon. Eleven minutes and twenty-eight seconds later Clement in the Clement-Bayard rushed into second place, though

elimination of favorites from one cause or another during the first few of the ten rounds. At the completion of the ninth round Clement led Heath by one minute and forty-eight seconds, but in the final and decisive lap Heath drove just 9.9 feet a second faster than his most dangerous

and after, it was America's day. When the race was called off, after the two leading cars had finished, America had a greater proportion of entered cars in the running than any of the other competing nations—France, Germany, or Italy. The percentages were: United States 60 per cent., France 50

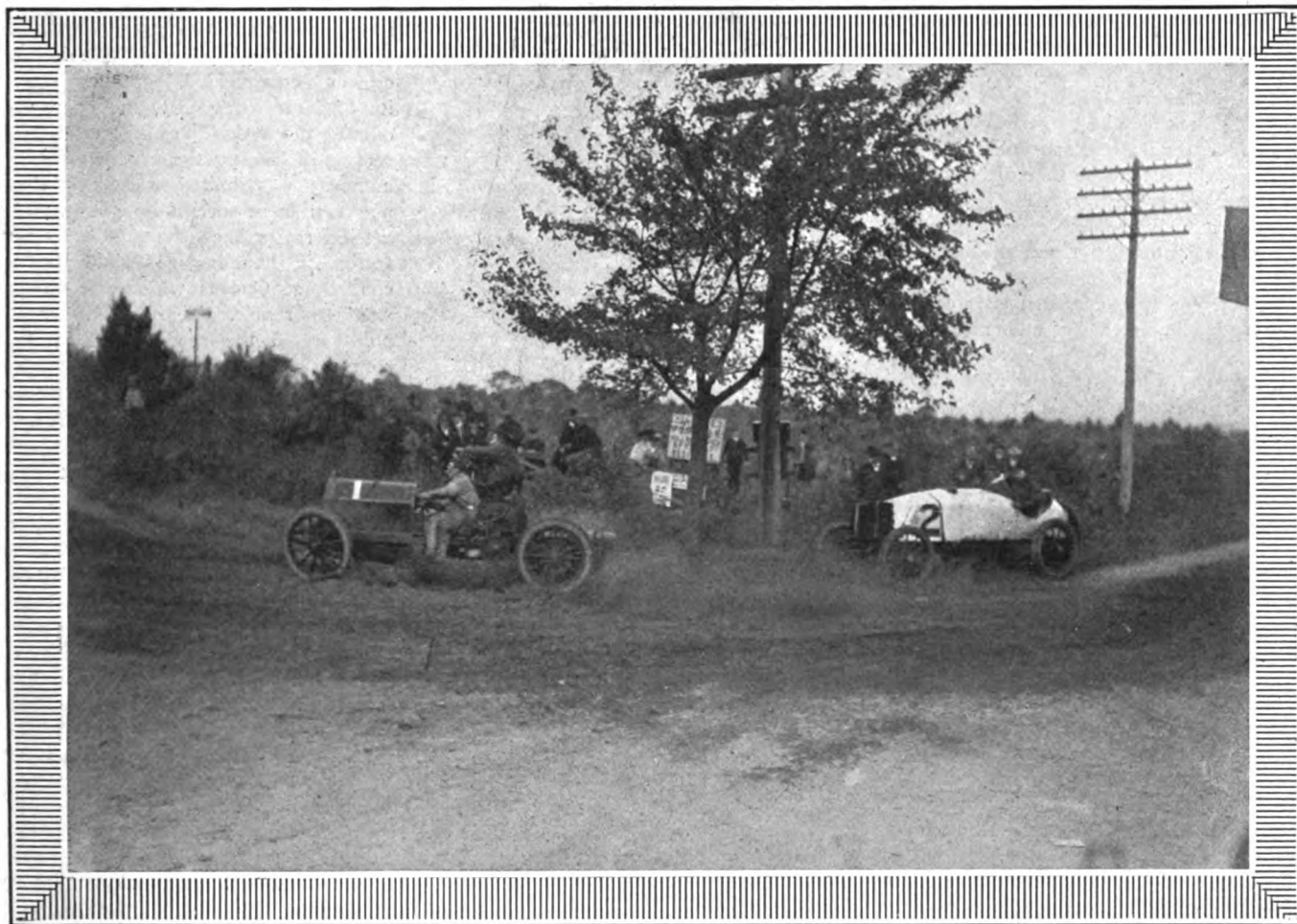

THE MOST SENSATIONAL INCIDENT OF THE RACE—GABRIEL IN THE DE DIETRICH OVERTAKING CAMPBELL IN THE MERCEDES AT THE DANGEROUS ACUTE-ANGLED BETHPAGE CORNER. Note—The angle at which the photograph was taken gives the corner the appearance of an obtuse angle.

actually only one minute and twenty-eight seconds behind the winner, corrected time.

For the greater part of the day, from the start at 6 o'clock in the morning on the quiet country road near Westbury, it was anybody's race, so great was the

rival and gave Panhard the premier place. Had he failed and Clement won France would still have lifted the cup.

AMERICA WON NOTABLE VICTORY.

America won a notable victory; indeed, looking broadly at the race, before, during

per cent., Germany 40 per cent., and Italy no per cent. at all.

Of the five American entries three were going at speed when the race officially ended. Lyttle, in an ordinary Pope-Toledo touring car, stripped down, had about

completed his ninth round; Schmidt, in the light-racing Packard, was running in his ninth round, and Croker, in the Simplex, was east of Queens on his seventh round. He finished this round unofficially.

Of the three French cars that were in the running, Heath and Clement had finished. Tart was compelled to stop near the grandstand for tire repairs before he had completed his eighth round.

The two remaining German cars, driven by Campbell and Luttgen, were running in their ninth and eighth rounds respectively when the race was officially ended.

All other cars had abandoned the race.

Heath's average speed for the entire ten rounds of the race was 52.2 miles an hour, actual running time. This was eight-tenths of a mile an hour less than the German Gordon Bennett last summer, and 2.7 miles an hour greater than the winner of the Irish Gordon Bennett in 1903.

FASTEST CAR IN RACE.

Teste in the Panhard was known to have the fastest car in the race, and he made the fastest round, at a mean speed of 70.8 miles an hour. His average for the three rounds through which he lasted was 66 miles an hour.

Lyttle furnished the surprise of the day by driving the little Pope-Toledo with a greater regularity in the time of his rounds than any other driver. The maximum variation in his speed for seven rounds was only two minutes and three seconds.

It was not a Mercedes day. Of the seven Mercedes type cars that were entered five were eliminated by other than tire troubles and the two that were in to the end, though of 60 horsepower, were defeated by an ordinary American touring car of 24 horsepower.

LUCK WAS A FACTOR.

Luck was a more important factor, however, in the winning and losing of the Vanderbilt cup race than in probably any other international race ever held. Cut glass and nails were strewn thickly along portions of the road, and especially at the bad corners. Whether or not this was done maliciously will probably never be known. As hundreds of cars passed over the course on the days preceding the race and did not meet with more than ordinary tire troubles, the inference is that the course was planted. Veiled threats made by the organized opposition to the race are still fresh in the memory.

Barring this disagreeable, if intentional dastardly, feature, the race was a remarkable success. When one considers the slight experience that most of those in charge at the start or along the course had had in such events, the results are very agreeable.

ONE FATAL ACCIDENT.

But one unfortunate accident occurred, and in justice to all it can be set down that this was due entirely to the foolhardiness of the driver in entering his car. While

driving on the Jamaica-Hempstead road in the second round Arents's car lost a tire and he lost control of the machine, so that it overturned on the road. Arents was thrown out and stunned and Carl Mensel, his mechanic, received fatal injuries. Arents was speedily removed to the hospital and has since lain for several days uncon-



Photo by Levick.
SNAPSHOT OF WILLIAM K. VANDERBILT, JR.,
WATCHING THE RACES.

scious from a blood clot in his brain, from which the physicians hope he will recover. Previous to that he had made a wild entry into the Hempstead control, showing inability to handle a car at high speed, and on that occasion missing by a foot a probably fatal collision with a tree.

FORTUNE FAVORED SPECTATORS.

Good fortune seems to have favored the spectators who at many points crowded on the course throughout the day and risked their lives on every occasion that a breakdown happened by surrounding the stopped car, regardless of the railroad speeds of those in the running. Curiously enough, it was not usually the rural population that acted so foolishly, but city folk and automobilists. It was solely due to the want of consideration shown by automobilists in the vicinity of the grandstand that the race was called off long before the legal hour for opening the road to general traffic had come around and before the remaining cars had a chance to fight out the battle to a finish.

No sooner had Clement arrived in second place than scores of drivers, whose cars were parked on the turf along the road, swung out into the oiled stretch directly in the path of the racers, those afoot following the example. A fearful congestion in the vicinity of the grandstand caused Mr. Vanderbilt to quickly decide to stop the race.

Throughout the race at the points where crowds congregated, outside the limits of New York City, the county peace officers and special deputies were of little service in keeping the course clear. Their authority was limited or at least they did not seem to be sure of its extent, and suggestion rather than command was not effective in handling the sightseers. The contrast at Queens within the city limits was remarkable. There the metropolitan police ruled the road and kept a clear course, and that without unnecessary friction or excitement.

OILING THE ROAD EFFECTIVE.

Oiling of the course was well worth the price paid for it. On the straight stretches and bends there was no sign of dust. At the bad corners which had not been rolled down hard the loose dirt was thrown up in showers on the passage of cars, but it was mingled with oil and heavy and it soon settled again.

Transportation facilities for the crowds were good and few of those who had not left the matter of over-night accommodations to the last moment had to remain up or sleep in chairs. Prices along the route were high in some instances, but, on the whole, not unreasonable.

It was remarkable that while there were hundreds of automobiles at many stretches along the course, and not less than 100,000 persons viewing it, no accidents to those going or coming were recorded. A better demonstration of the safety of the automobile to other road users could not have been made.

SPORTSMAN'S POINT OF VIEW.

From the sportsman's point of view the race was an inspiration. None will soon forget the kaleidoscopic scenes of early morning when darkness was changing into dawn. The fresh, clear air, the flashing

How Each Contestant Fared.

lights, the buzz of cars and the little roadside scenes at the watch fires along the route made a lasting picture. And then, later, at the start, when car after car was sent away, every crew eager to grasp victory from the unknown though not unconsidered risks, there was a delicious tingling of expectancy and a wish each for his favorite driver. As the hours slipped by, the cry of "car coming" set the blood moving like on a day with the hounds, and made each ready for the climax—the distant rattle of the exhaust, the nearer roar of the motor and then the fierce demoniacal rush as the car blurred past the eyes.

Responsibility for the carrying out of the strenuous program fell on the shoulders of the following gentlemen:

The Commission for 1904—*Blue Brassard*:
A. R. Pardington, Chairman; William K. Vanderbilt, Jr., William Wallace, George L. Weiss, F. C. Donald, James L. Breese, A. L. Riker, E. T. Birdsall, M. E., S. F. Lynch, Assistant Secretary.

Referee—*Blue Brassard*:

William K. Vanderbilt, Jr., L. I. A. C., A. A. A. and A. C. A.

Judges of Start and Finish—*Red Brassard*:
Harlan W. Whipple, Pres. A. A. A.; Frank G. Webb, L. I. A. C.; Winthrop E. Scarritt, Pres. A. C. A.

Judges of Controls—*Red Brassard*:

Hicksville—Samuel Van Wagner, Jr., Peter Grupe; Hempstead—H. C. Hackstaff, L. I. A. C., John D. Hackstaff, L. I. A. C.

Judges of Turns—*Red Brassard*:

Jericho—William Milne; Plain Edge—Theo. Heilbron, L. I. A. C.; Queens-Hempstead—R. Healy, L. I. A. C.; Queens-Jericho—Frank L. Evans, L. I. A. C.

Judges of Weighing—*Red Brassard*:

E. T. Birdsall, M. E., Racing Board, A. A. A.; A. L. Riker, Racing Board A. A. A.

Timers—*Green Brassard*:

S. M. Butler, Sec. A. C. A., and The Chronograph Club of Boston.

Starter—*Green Brassard*:

C. H. Gillette, Secretary American Automobile Association.

Assistants to Starter—*Green Brassard*:

Geo. E. Farrington, A. C. of New Jersey; Emerson Brooks, A. C. A., M. M. Belding, Jr., A. C. A., Robert Lee Morrell, A. C. A.

Announcer—*Green Brassard*:

Peter Prunty, of New York.

Engineer of Course—*Green Brassard*:

Lieut.-Com. W. G. Ford, C. E.

Superintendent of Telephone System—*Green Brassard*:

Albert H. Grant, Brooklyn, N. Y.

Patrol Checkers—*Yellow Sash*:

Twenty members of the Federation of Motor-Cyclists, R. G. Betts, President.

Press Bureau—*White Brassard*:

Lawrence Abrams, Louis R. Smith, Alfred Reeves.

No. 1, CAMPBELL.—At 5:50 car No. 1, S. B. Stevens's Mercedes, was driven up by A. L. Campbell and stopped with its front wheels on the tape. While everybody waited expectantly for the ten minutes to tick away, the engine throbbed and Campbell played with his levers and throttle and spark control, and looked around at the well filled stands. As his starting time drew nearer he watched closely the face of the starter, and at the word "Go" let in his clutch smoothly and got away quickly at exactly 6 o'clock. He gathered speed rather slowly as he passed the length of the grandstand, and swung off down the long, declining stretch toward Jerico.

He had trouble in the second, fourth and eighth rounds, but was still in the race when it was called off. Passed the grandstand fifth at end of the eighth round.

No. 2, GABRIEL.—Gabriel was cheered as he moved up to the tape in Jarridge's de Dietrich, No. 2. At the word Gabriel got away much like Campbell, accelerating rather slowly after letting in the clutch until after shifting his gears.

Gabriel took the lead in the first round and held it to end of the third, when he was passed by Heath. Finished fourth, fifth and sixth rounds in second place, but had to quit in the seventh at Hicksville with a broken pump connection.

No. 3, TRACY.—Tracy's popularity was attested by a cheer and applause as he came up in the 35-horsepower Royal. He appeared very calm—more composed than the officials—and looked around at the grandstand and judges' and timers' stand and adjusted his goggles easily. Vanderbilt stood directly at his right front wheel to see the first American entrant get away. The start was well made, without any balks, and the car accelerated rapidly.

When near the apex of the triangle Tracy sheared the pins in his propeller shaft joint and made a repair in a wagon shop at Queens, getting away again in about two hours. Completed one round in 2:23:25, but cracked a cylinder and crank case in the second round and had to quit on the Bethpage road.

No. 4, A. C. WEBB.—Pope-Toledo 60-horsepower racer was pushed to the line by four or five young men, who stood behind while the time was counted off. At the word to go, Webb did not set his clutch tight, but let it slip while the helpers ran down the road for 100 feet pushing the car until it gained sufficient speed to start on high gear without stalling the motor. This raised a laugh, but when the clutch took hold the car started away quickly.

Webb completed two rounds at fair speed, had trouble in third, fourth and fifth rounds, broke a steering knuckle connection in the fourth and finally ran into a tree near Queens.

No. 5, ARENTS.—Arents in his Mercedes No. 5 looked pale as he toyed with his spark and throttle levers on top of the steering wheel. When given the word he dropped his clutch in suddenly, the car jumped, hesitated, jumped again; the driver cut the engine out for a few revolutions, then started again and was off.

Arents completed one round in 52:06. In the second a tire came off the left rear wheel, rim caught in the street car rail on Jamaica road and car overturned at Elmont. Both men were removed to the hospital, where the mechanic, Carl Mensel, died soon afterward. Arents is believed to be out of danger.

No. 6, LYTLE.—Lyttle, in the 24-horsepower Pope-Toledo, also threw in his

clutch too quickly. The wheels spun around one or two revolutions on the oily road and a helper pushed on the back of the car till the wheels took hold; then the engine overcame the sudden load and Lyttle was away at good speed.

He ran the most uniform race of the day and was third when the race was officially called off. Was the only one to complete nine laps except Heath and Clement. Had trouble that delayed him half an hour in the seventh round. The greatest variation in his times for any two rounds except the seventh was 2 minutes 3 seconds.

No. 7, HEATH.—Huge Panhard No. 7 came to the tape with the engine thundering ominously, Heath's commanding figure at the wheel and a very slight mechanician in the seat by his side. Heath made a good start, the car picking up speed rapidly for the first 100 feet; then the loud noise of the exhaust stopped momentarily, while the gears were passed through, and Heath and his car disappeared from sight beyond the group of photographers at the left of the press box.

Heath ran a beautiful race and won in magnificent style. Went from seventh to first position in the first four rounds. Had tire trouble in the sixth and eighth rounds, delaying him about twenty and thirty minutes respectively. His total running time, exclusive of controls, was 5:26:45.

No. 8, HAWLEY.—When Hawley came up to the tape in E. R. Thomas's Mercedes and stopped, his mechanician busied himself with the hand pump supplying compressed air to the gasoline tank. Hawley watched intently the face of E. T. Birdsall, who stood at his right side with watch in hand, for the word to go. He got off with a good start, much like Campbell's and Gabriel's.

Hawley ran as good a race as Heath to the end of the third round, which he finished in third, having gone from eighth to third position in two rounds. Completed fourth round and stopped just beyond grandstand with both front springs broken immediately above the axle.

No. 9, WERNER.—Werner made a comparatively poor start in C. G. Dinsmore's 90-horsepower Mercedes. The clutch jammed in too quickly and the huge car made a big jump, while clouds of black smoke poured out of the upwardly curved exhaust pipes under the left frame member. The engine was running well, however, and after the first jump the machine got away quickly.

Werner completed one round in 39:41, but near the end of the second was blocked by a train at the Oyster Bay crossing; he set his brakes too suddenly and disabled the car.

No. 10, SARTORI.—Sartori had not appeared when his starting time came at 6:18 a.m., and there was a wait of four minutes for the next starter. The driver of A. G. Vanderbilt's 90-horsepower Fiat had met with some trouble on the road between Garden City and Westbury, which delayed him an hour and three-quarters. After most of the contestants had completed two, and some of them three, rounds, Sartori passed the stand going between sixty and seventy miles an hour and did not stop for an official start. His passing time was 8:02:14 o'clock.

He was flagged as he passed the stand, finishing his first round. Starter Gillette ran after him, deposited his official starting time card in the box on his car and told him to go on. Was stopped at the Hicksville control by order of Chairman of Racing Board and held for about an hour, then

COMPLETE TABLE OF STARTERS AND OFFICIAL CLOCK AND NET RUNNING TIMES* AT THE END OF EACH ROUND IN THE WM. K. VANDERBILT, Jr., CUP RACE, LONG ISLAND, OCTOBER 8, 1904.

No.	Country.	Car.	H.P.	Owner.	Driver.	Mechanician.	Tires.	No.	Start. A.M.	Rounds.										No.
										1.	2.	3.	4.	5.	6.	7.	8.	9.	Finish.	
1	Germany	Mercedes	60	S. B. Stevens	A. L. Campbell		Continental	1	6:00:00	6:40:00	8:44:31	9:24:41	10:36:43	11:20:43	12:01:40	12:41:16	Running when race was called off.	1		
2	France	De Dietrich	80	R. E. Jarrige	Fernand Gabriel	Dominique Miollans	Michelin	2	6:02:00	6:37:57	7:14:09	8:00:35	8:43:05	9:37:57	10:32:30	Retired at Hicksville with broken connection.	2			
3	America	Royal	35	C. A. Duerr	Joseph Tracy	Al. Poole	Diamond	3	6:04:00	8:38:25	Retired	on Bethpage road with cracked cylinders	3							
4	America	Pope-Toledo	60	Pope Mfg. Co.	A. C. Webb	Andrew Anderson	G. & J.	4	6:06:00	6:45:47	7:30:01	8:27:41	9:49:19	Ran into tree near Jamaica	Queens on Jericho turnpike.	4				
5	Germany	Mercedes	60	George Arents, Jr.	Owner	Carl Mensel	Continental	5	6:08:00	7:00:06	Overtaken at Bethpage	on Jamaica Hempstead road.	5							
16	America	Pope-Toledo	24	Pope Mfg. Co.	Herbert H. Lyttle	Charles Soules	G. & J.	6	6:10:00	6:56:26	7:43:56	8:31:44	9:18:34	10:05:46	10:52:15	12:09:08	Running when race was called off.	6		
7	France	Panhard	90	Panhard-Levassor	George Heath	Eugene Lajunie	Michelin	7	6:12:00	6:40:32	7:27:10	8:02:20	8:38:52	9:13:05	10:09:16	10:48:21	11:54:48	12:35:40	1:08:45	
8	Germany	Mercedes	60	E. R. Thomas, Jr.	E. E. Hawley	Jordan	Continental	8	6:14:00	6:51:30	7:28:27	8:05:47	8:45:47	Retired at grandstand with both front springs broken.	8					
9	Germany	Mercedes	90	C. G. Dinsmore	Wilhelm Werner	Otto Gehry	Continental	9	6:16:00	7:04:41	Retired with broken cylinder	9								
10	Italy	F.I.A.T.	90	A. G. Vanderbilt	Paul Sartori	Emanuel Cedrions	Italian Michelin	10	6:18:00	Official starting time given out, retired at Hempstead with defective clutch.	6:18:00	Official starting time given out, retired at Hempstead with defective clutch.	8:02:14	Completed one round, time not given out.	10					
11	France	Renault	60	W. G. Brokaw	Maurice Bernin	Helix Prossen	Michelin	11	6:20:00	7:03:08	Twisted propeller shaft on Bethpage road and retired.	11								
12	France	Clement	90	A. Clement	A. Clement, Jr.	Alezi	Michelin	12	6:22:00	6:58:51	7:42:43	8:21:40	9:21:50	10:00:23	10:40:43	11:10:35	12:01:40	12:40:52	1:20:13	
14	France	Panhard	90	Panhard-Levassor	Henri Tart	Jarlet	Michelin	14	6:24:00	7:57:47	8:32:57	9:16:07	10:10:32	10:45:12	11:20:01	12:11:45	Fixing tires near grandstand when race ended.	14		
15	France	Panhard	90	Panhard-Levassor	George Teste	E. Artent	Michelin	15	6:26:00	6:59:04	7:35:31	Retired with ignition trouble on Bethpage Road.	15							
16	America	Packard	30	Packard Motor Car Co.	Charles Schmidt	Wm. McIldrid	Goodrich	16	6:28:00	7:23:26	8:08:45	8:57:58	10:08:37	11:02:59	11:54:36	12:43:08	Running when race was called off.	16		
17	America	S. & M. Simplex	75	Frank H. Croker	Owner	Harry Hill	Diamond	17	6:30:00	7:06:35	7:42:42	8:50:02	10:06:49	11:04:57	11:53:23	Running when race was called off.	17			
18	Germany	Mercedes	60	Isidor Wormser	William Lutigen		Continental	18	6:32:00	7:33:42	8:38:36	9:15:50	10:29:36	11:10:08	12:37:15	Running when race was called off.	18			
19	Italy	F. I. A. T.	90	William Wallace	Owner	Antonio Dondri	Italian Michelin	19	6:33:00	Retired with defective clutch at Hicksville	19									

NOTE.—There was no No. 13. Lower figures in each round show the total running time minus 9 minutes (net running time) required to pass through Hicksville and Hempstead controls.

*The net running times in this table were computed by THE AUTOMOBILE, and agree with the differences between the official clock times. They are, however, not all in agreement with the net running times as given out by the official announcer at the press stand.

GRAPHIC RECORD OF THE POSITION OF EVERY CAR AT THE END OF EACH COMPLETED ROUND IN THE VANDERBILT CUP RACE.

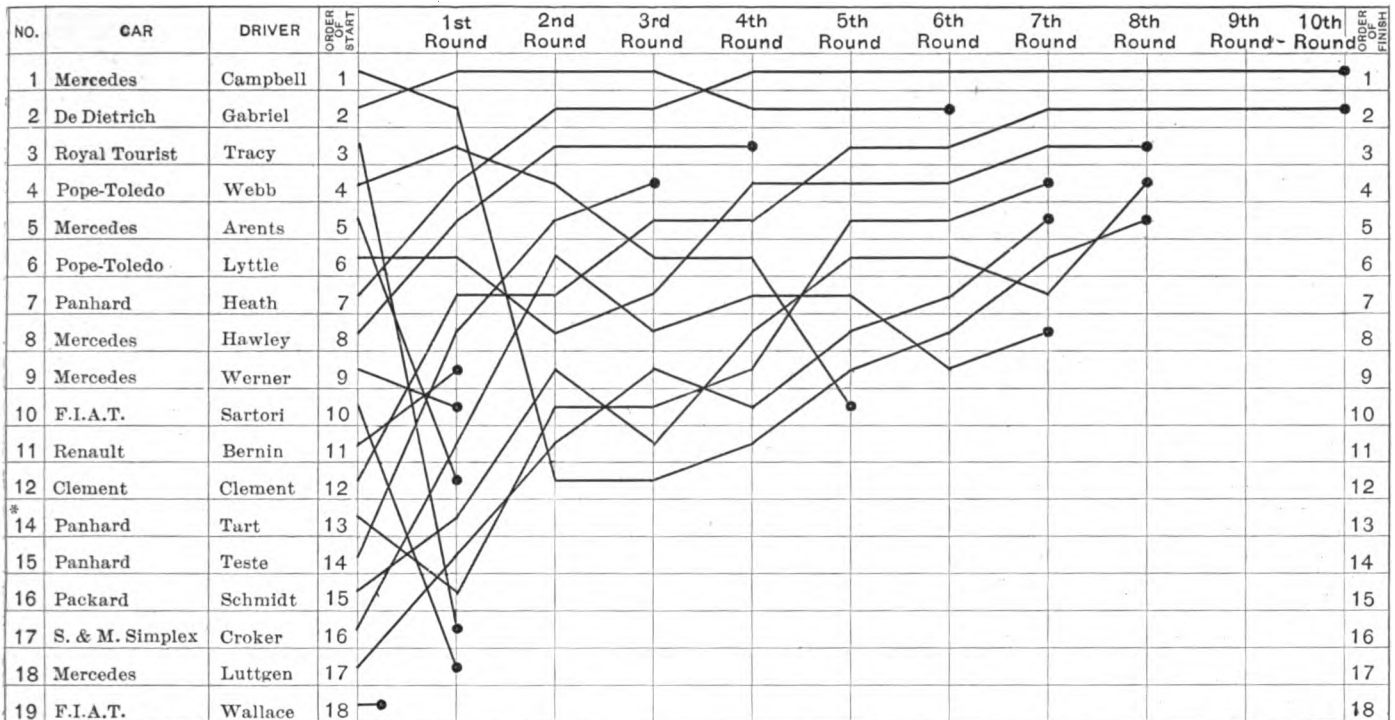

*Note there was no number thirteen in the race

In the diagram above the contestants' names appear in the order in which they started, at two minute intervals. The heavy black lines show how they changed relative positions in each round. The irregular lines cross the verticals midway of the left-to-right spaces, successively from 1 to 18, down the columns in the order in which the drivers actually passed the grandstand at the end of each round. Where the lines cross one another diagonally indicates in which round the men changed positions but not where they passed one another on the road. The lines do not, however, show the relative places of the men in the race according to corrected running times, as the diagram relates solely to position and not to time. The black dots at the ends of the lines indicate the last recorded passage at the tape of the cars competing in the race.

ANALYTIC SUMMARY OF THE RACE, SHOWING, COMPARATIVELY, SPEEDS OF THE LEADING DRIVERS, MOST UNIFORM PERFORMANCE, AND STATUS OF CARS AND NATIONS REPRESENTED WHEN THE RACE OFFICIALLY ENDED.

Total distance covered from start to finish, including controls, 302.4 miles.

Total distance covered from start to finish, excluding controls, 284.4 miles.

Heath's total elapsed time (including controls)..... 6:56:45

Heath's net running time (excluding controls)..... 5:26:45

Average speed of Heath in net running time (miles per hour)..... 52.2

Average speed of Heath (miles per min.)..... .87

Average speed of Heath (feet per second)..... 76.59

Heath's fastest round (net distance 28.44 miles) . 25m. 13s.

Average speed in Heath's fastest round (miles per hour)..... 67.2

Clement's total elapsed time (including controls) . 6:58:13

Clement's net running time (excluding controls) . . . 5:28:13

Average speed of Clement in net running time (miles per hour)..... 51:6

Lyttle's net running time for eight rounds (227.52 miles)..... 5:17:37

Average speed of Lyttle in net running time (miles per hour)..... 42.6

Greatest variation in time of rounds made by Lyttle, excluding round in which he had tire trouble... 2m. 3s.

Mean speed of Croker in his fastest round (miles per hour)..... 62.4

Fastest round in race, made by Teste..... 24m. 4s

Mean speed of Teste in fastest round (miles per hour) .70.8

Mean speed of Teste in fastest round (feet per second) 103.9

Teste was actually leading in the race by 6m. 10s. when he finished his third and last round.

Most uniform performance in the race, made by Lyttle on 24-h. p. Pope-Toledo.

Clement was 3m. 8s. in the lead of Heath in the eighth round.

Cars that had finished, or were still running, when race was called off: Panhard (Heath), Clement (Clement), Pope-Toledo (Lyttle), Packard (Schmidt), Mercedes (Campbell), Panhard (Tart), Mercedes (Luttgen), Simplex (Croker).

Cars representing various nations that had finished, or were still running, when race was called off: America, 3; France, 3; Germany, 2; Italy, 0; total, 8.

Cars that were out of the race when it was officially called off: DeDietrich (Gabriel), Royal Tourist (Tracy), Pope-Toledo (Webb), Mercedes (Arents), Mercedes (Hawley), Mercedes (Werner), F.I.A.T. (Sartori), Renault (Bernin), Panhard (Teste), F.I.A.T. (Wallace).

Cars representing various nations that were out of the race when it was officially called off: America, 2; France, 3; Germany, 3; Italy, 2; total, 10.

told he could go on; but he was only able to reach Hempstead, owing to a defective clutch.

No. 11, BERNIN.—One of the poorest starts was made by Bernin in W. G. Brokaw's 90-horsepower Renault. When the starter gave the word at 6:20 a.m. the car made a leap, stopped and jumped again. Clouds of yellow-brown smoke poured out of the side, and smoke rings were puffed straight out from the left side. The car slowed down, then started up and disappeared from the view of the press stand.

Bernin completed one round in 34:08 net time, but twisted his propeller shaft on the Bethpage road in the second round and had to retire.

No. 12, CLEMENT.—Bluish smoke rolled out from beneath Clement's rakish blue 50-horsepower Clement car as it came to the tape. The youngest driver in the race made a careful start, letting his clutch in cautiously and looking at his levers as he changed the gears. It was a slow start, but he picked up steadily and was soon under high speed.

Clement finished second, 1 minute 28 seconds behind Heath. He ran a determined and careful race, and in the eighth round was 3 minutes 8 seconds ahead of Heath, corrected time. Until Clement crossed the tape at end of his tenth round victory hung in the balance. He rode a consistent race, but had trouble in fourth round. Entered a protest for delay in Hicksville control, but it was not allowed.

No. 14, TART.—The best start of all was probably made by Tart in the 90-horsepower Panhard No. 14. The heavy thunder of the huge engine betokened great power and speed. The car left the tape easily and quickened its pace evenly but rapidly for the first seventy-five feet; the explosions ceased as the machine passed the end of the stand and group of photographers, then were heard again receding in the distance.

Tart had tire trouble in the first round that delayed him almost an hour, and also had trouble in the fourth and seventh rounds, but was still running when the race was called off. Stopped in eighth round within 200 yards of grandstand with right rear tire off. Was fourth to finish seventh round.

No. 15, TESTE.—Teste's Panhard No. 15 was the first one that had to be cranked at the tape; but when the engine started it sounded marvelously powerful and fast. Teste got away well and accelerated very fast.

He made the fastest round in the race, in the first lap, his net running time minus controls being 24:04. Went from fourteenth to eighth position in first round, from eighth to fifth in second, and from fifth to fourth in third, but had to abandon the race at Panhard headquarters on the Bethpage road in the fourth round owing to ignition troubles.

No. 16, SCHMIDT.—Schmidt and his mechanic pushed the *Gray Wolf* to the starting line, where the mechanic cranked the engine. As Schmidt took his seat he got three cheers from the stand. Vanderbilt walked up close on the left side and looked the machine over interestedly. Schmidt waved his hand to a friend in front of the press box, but when the word was given he did not appear to hear, and it was repeated. Then the little, low racer started very slowly and did not pick up speed well; the motor sounded as if it were not running regularly and might be missing explosions.

Schmidt had trouble in the fourth round that delayed him twenty minutes, but was still going when the race was called off. He completed the eighth round in fourth place.

No. 17, CROKER.—Frank Croker came to

the line in his 75-horsepower Simplex with red fire spurting out a foot or two from the two exhaust ports protruding from the left side of the bonnet. Vanderbilt, who was standing alongside, jumped back hastily, as there was a particularly sharp explosion in the tube. The car got away well and made a very quick start.

Croker made his first and second rounds in fast time, but had trouble in all the rest. Was just finishing his seventh round when the race was stopped.

No. 18, LUTTGEN.—When Isidor Wormser's 60-horsepower Mercedes came up for the start William Luttgen was in the driver's seat instead of the owner, who was expected to drive. Luttgen looked calmly around at the stands just before receiving the word, then as he let his clutch in rather quickly, the wheels spun around a few times in the oily sand, then took hold and the car went away with a good start.

Luttgen completed his seventh round

fifth and was stopped by the owner of the car within 100 yards of the grandstand as he was finishing the eighth, after the race had been called off.

No. 19, WALLACE.—William Wallace and his 90-horsepower Fiat No. 19 were almost totally concealed in a big cloud of black smoke as they got away at 6:33 a.m. Wallace was sent away one minute early in order to more quickly clear the road for the arrival of the first car completing the first round. Wallace did not go immediately upon getting the word, but he made a fast start.

He stopped at Jericho on the first round with a bad tire and a defective clutch. After his mechanic, Antonio Donderi, had fixed it, Wallace started before Donderi had securely resealed himself, and ran over him. Mechanician was not injured, but Wallace picked up another and went on. At Hicksville the clutch stuck and Wallace had to abandon the race.

The Race as Seen from the Grand Stand.

NEVER has America known such a scene as that presented near Westbury on the morning of the first international automobile road race held on the soil of the Western Hemisphere. As the first pale pink of breaking day flushed the eastern sky above a bank of gray clouds and the morning star blazed brightly above the western horizon, long lines of pedestrians wended their way northward from the village to the course along streets still lighted by the oil street lamps. Bus, carryall and surrey, loaded heavily with men, rolled along, the drivers urging them with voice and whip to move faster than a walk.

Westward on the Jericho Turnpike, where the Westbury road joined the course, as far as the eye could see, curved a stream of bright lights moving close to the ground, in pairs, in triples, and in fours—headlights and sidelights on hundreds of hurrying automobiles, all bent on reaching the grandstand before the course was closed to traffic and the starting of the racing cars began. The rattling musketry of the motors and the hoarse honking of the horns as the cars rushed past tingled the blood and the heart beat faster. Liverymen and stage drivers beat their horses into a lope, fearful of being caught in an inextricable tangle of cars near the stands. There were calls from out the dark to "Keep to the right," "Look out behind, there!"

AHEAD THE TERRACED STAND.

Ahead, taking shape whitely in the gray of the dawn, appeared the terraced grandstand, and opposite it, across the road, the smaller stand for the judges and timers and press representatives. On either side blazed cheerfully in the chill of the morning little bonfires, made from the waste bits of board from the stands.

A distant roar, far back in the blackness of the road to the west, rising louder than the hum of the touring cars, heralded the coming of a racing car, and a few moments later a Mercedes car with a big 5 painted on the radiator dashed past at a seeming

speed of thirty miles an hour through the crowded road, with flames shooting out from the exhaust pipes. Only dimly could the outline of the car and its occupants be seen.

A MICHELIN TIRE DEPOT.

Close to the side of the road stood a ghostly little tent of the Michelin tire depot, with a fire crackling before it and figures of men moving silently about or warming themselves by the ruddy flames. Just back of it, nestling in a sheltering grove of trees, could be seen the little old Quaker meeting house, with its back to the road as if in dignified pretended ignorance of this astounding invasion of its peaceful vicinity. Eastward, about half a mile, was the focal point—the grandstand.

It was 5:25 a.m. Spectators were just beginning to occupy the boxes and camp stools of the grandstand. George Arents, Jr.'s Mercedes No. 5 was waiting near the tape, first of the contestants to appear at the start. While the officials were busily pinning their blue and red and green brassards around their arms, and the telephone corps were arranging the instruments in the judges' box, and the spectators, who were arriving in their big touring cars, were parking them hastily back of the fence, east of the grandstand and beneath the trees along the sides of the road, William K. Vanderbilt, Jr., donor of the great cup to be won and lost in the next six or seven hours, rushed up in his immaculately white 90-horsepower Mercedes and came to a quick stop. Vanderbilt was driving the car himself. His slight figure was warmly cloaked in a huge fur overcoat, reversed, with the brown cloth side outward, and by his side sat the larger figure of the surgeon, whom he had brought with him for any emergency that might arise during the day to need his services.

W. K. VANDERBILT, JR., ARRIVES.

Vanderbilt backed his great white beauty through the turf-covered ditch on the north side of the road, about 100 yards to the

west of the stands, and walked down to the scene of official activity, at the tape. There he was seen during nearly all of the forenoon, taking a keen interest and lending a helping hand in the starting and directing of the race of which he was sponsor. Wearing a jaunty cap and, as the clouds dispersed and the sun shone out more warmly as the day wore on, habited in a black silk coat with the blue brassard of the referee pinned around his arm, he chatted in the most sociable way with the other officials, while his keen eye took note of all that went on.

Half an hour passed all too soon. The racing cars had been coming up in quick succession, while the touring cars poured in over the road like flocks of honking

Gabriel's ghostly de Dietrich, with a startlingly bold, black figure 2 painted on the nose, came promptly up to the tape next, but just as it did so a maroon-colored White steamer with canopy top rolled in alongside close to the grandstand. There were cries of "Put him off!" "Make him get out!" from the press and timers' stand, and from both sides of the road. The officials at the tape made a rush, laid hands on the car, and stopped it amid a hubbub of commands and remonstrances. The driver refused to turn back and insisted upon going on. He opened the throttle, and as the car started forward it nearly crushed one or two men between the grandstand and the corner of the condenser and right wheel. Then Mr. Vanderbilt stepped up and quietly requested

clutch could be let home without stalling the engine.

POPULAR FAVORITES AT THE TAPE.

Popular favorites in the contest, as indicated by the applause that greeted them as they came to the tape, were Gabriel, Tracy, Heath, Clement and Schmidt.

All of the cars got away in their proper order, with the exception of No. 10, A. G. Vanderbilt's 90-horsepower Fiat, driven by Paul Sartori. It was reported that this machine was broken down somewhere on the road from Garden City to the grandstand. No. 11 was started on its own time, however, and the only car that was started officially at a different time than that which its driver got in the drawing of lots for starting position just one week before was Wil-



SCENE AT GRANDSTAND, OPPOSITE START AND FINISH LINE, DURING THE PROGRESS OF THE RACE.

geese to their feeding ground in the early morning. At 5:50 o'clock S. B. Stevens's maroon-colored 60-horsepower Mercedes was driven up to the tape by A. L. Campbell, and stood there with throbbing engine while the next ten minutes ticked off slowly. All eyes were centered on the little knot of officials standing around the car, Vanderbilt among them to personally see the start of the first car in the first race that was to place America on a footing with the European countries in the sport of automobile racing.

A few minutes' hush pervaded the momentous scene, the starter gave the word "Go!" the car darted away and a cheer broke forth as the suspense ended.

that the man back out, which he finally did, just as Gabriel was sent away.

A similar incident occurred when a delivery wagon with supplies was driven across the tape, but the excitement quickly subsided, as the wagon was hustled past the stand and out of the way on the other side.

The starters were lined up on both sides of the road, those with even numbers in order on one side and those with odd numbers in order on the other.

Relief for the keyed-up nerves came when the Pope-Toledo No. 4 was sent away, pushed over the tape and for twenty yards on its way by four or five young men, evidently to get its gears in motion before the

liam Wallace's 90-horsepower Fiat, No. 19. This car started last and was sent away one minute ahead of its time in order to clear the road for the first car that would complete the first round.

It was exactly 6:33 a.m. when Wallace left the tape. The day had dawned fully, but the sun was still hidden behind clouds, and the dew had not dried from the seats in the stand.

Even before the last car got away anxious faces were turned to the west, looking for the first glimpse of the first arrival. Immediately after Wallace started the officials cleared the road and warned the spectators to stand back from it. The expectant ones did not have long to wait. During the in-

terval telephone messages from the turns and controls began coming in. The first to arrive was from Jericho, which reported the passage of the first three cars. Only five minutes after the departure of the last car Announcer Peter Prunty told the spectators, through a megaphone that was almost as big as himself, that "a telephone message says that Gabriel has just passed Queens in the lead."

This was followed by a burst of applause, which was succeeded by a period of suspense, while everybody strained eyes and ears to catch the earliest evidence of his approach.

Meanwhile other messages were being received and megaphoned to the stand. "Car No. 1 is reported second at Queens;"

of the occupants being women, many of them richly cloaked in garments that hinted of the opera rather than dewy camp chairs in an unpainted and undecorated temporary stand, a mile or more from anywhere, at 6:30 o'clock on a chilly October morning.

"No 5 punctured a tire in the first round," called the announcer. Then, "No. 7 passed Queens in fourth place." Thus were the spectators constantly apprised of the progress of the race at various points around the course. The special telephone arrangements worked admirably, and the announcer very patiently and effectually repeated to every one within range of his megaphone the reports that came over the wires.

Less than two minutes after Gabriel had passed there was a shout from among the

another, "What has happened to Tracy?"

Just after Webb passed Mr. Vanderbilt, who went down to where his car was parked, jumped in with Dr. L. M. Lanehart, wearing a Red Cross insignia on his arm, and dashed off up the course after the Pope-Toledo, evidently at quite as high speed. In ten minutes he was back, and it was announced that William Wallace, while repairing a tire in Jericho, had accidentally run over his mechanic, who was not seriously hurt, and had started again with another man, whom he had picked up.

While Vanderbilt was gone Heath passed the stand, at 6:49:52, having moved up into fourth position. His net running time was announced as 28:52—practically a mile a minute for the whole circuit, minus controls.

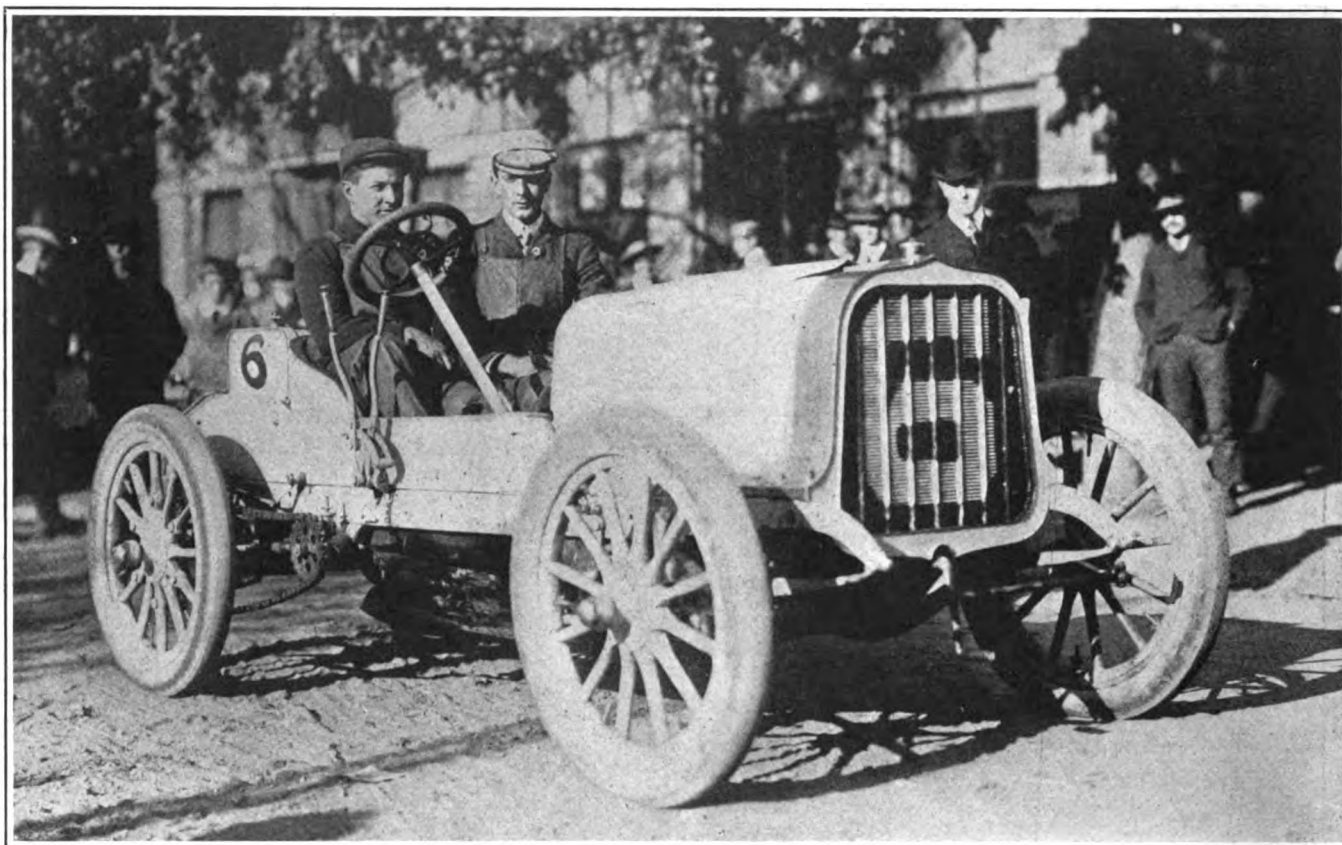

HERBERT H. LYTTLE AT THE WHEEL OF THE 24-HORSEPOWER POPE-TOLEDO TOURING CAR NO. 6.

"Queens reports No. 4 passed in third place." Next a distant murmur was heard far up the course, which quickly grew into a hum, then into a roar, and Gabriel's long white car flashed down the line between the stands and fringe of humanity, crossing the tape at 6:37:57 a.m., only 4 minutes 57 seconds after Wallace left the same spot. It was useless to applaud; Gabriel couldn't hear it, and, besides, the spectators were gasping in amazement at the terrific speed. He went by at more than sixty miles an hour. But not an atom of dust trailed after him, to eclipse him as a comet might be hidden from view by its own tail, and to irritate the eyes and settle over the clothing.

The grandstand was well filled, fully half

group of half a dozen photographers standing with their boxes and tripods on the tarpapered roof of the official stand of "Another car coming," and this was repeated by the announcer, whereat everybody craned forward again. This time it was Campbell that went past. Gabriel had made up the difference of two minutes in their starting times and had gained a lead of more than two minutes on him in the first round of 28.44 miles, exclusive of controls. It looked bad for Campbell.

Five minutes later the "Car coming" call was heard again, then the rapidly growing pattering of an approaching car, and in another minute Webb, in the large Pope-Toledo, had passed, having moved up one place in the race. People began to ask one

Less than two minutes afterward Hawley went by in E. R. Thomas's Mercedes, making as good time as Heath, and his announced net time for the round was 22 seconds less than Heath's.

LYTTLE IN POPE-TOLEDO No. 6.

Lyttle, in the 24-horsepower Pope-Toledo No. 6, that had run through a fence in Hicksville only a few days before the race while being driven by him, passed the stand about five minutes later, going slowly as compared with the previous ones. As the sound of his engine died away in the distance it was announced that Tracy had broken his propeller shaft at Queens, which set at rest all inquiries as to where he was, and brought out numerous expressions of regret, as it was assumed, of course, that

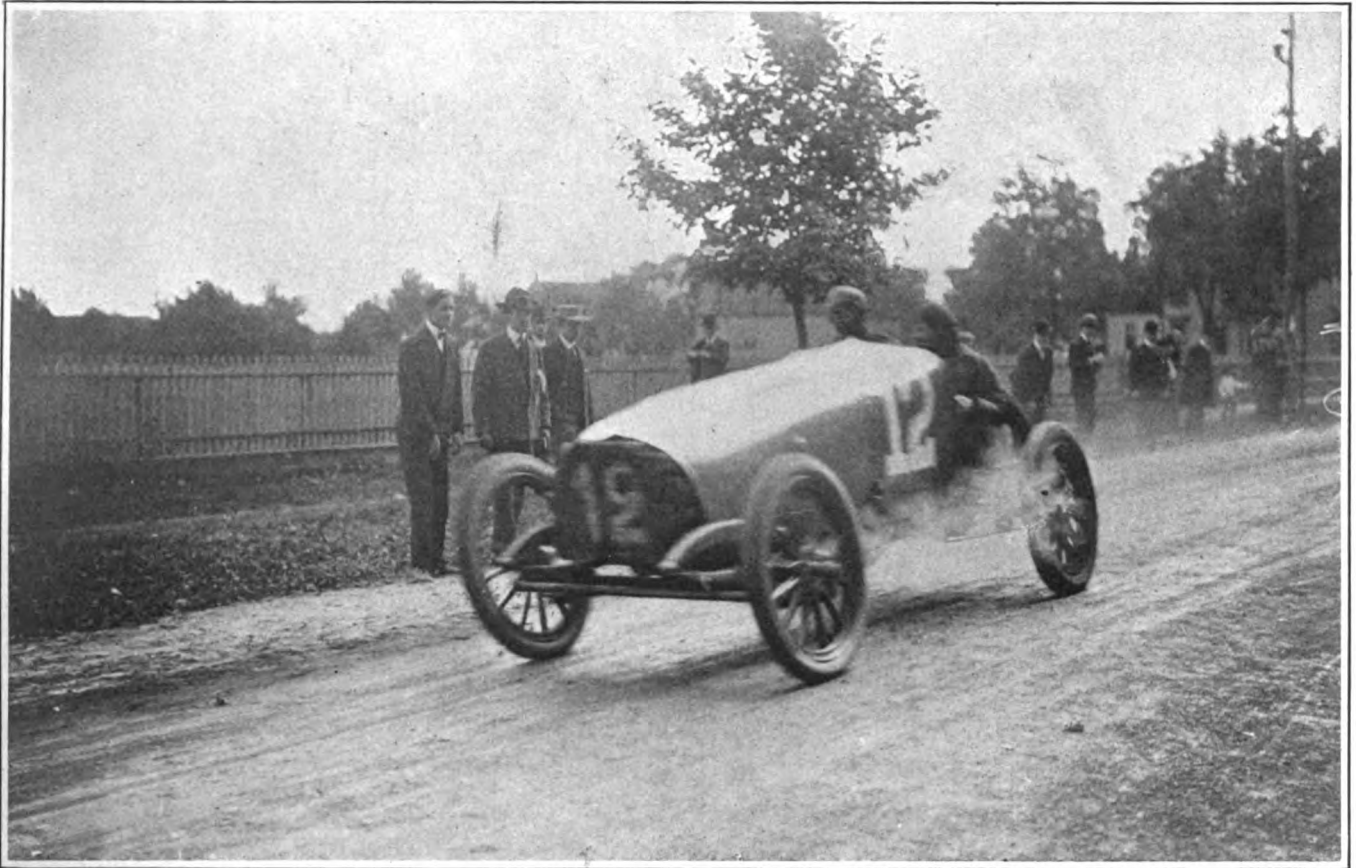

ALBERT CLEMENT, JR., IN THE CLEMENT-BAYARD APPROACHING THE GRAND STAND AT A HIGH RATE OF SPEED.



Photographed for THE AUTOMOBILE by Edwin Levick, New York.

INSTANTANEOUS PHOTOGRAPH OF HEATH IN THE WINNING PANHARD GOING EIGHTY MILES AN HOUR. THIS PLATE IS AN EXACT REPRODUCTION IN SIZE OF THE ORIGINAL, AND IS NOT AN ENLARGEMENT. NOTE THE FORWARD TILT OF THE MACHINE DUE TO THE TREMENDOUS SPEED, ALTHOUGH THE FASTEST INSTANTANEOUS SHUTTER WAS USED.

such an accident would put him out of the race.

The first incident that looked like a brush occurred at 7 o'clock, when Clement went by like a whirlwind, followed thirteen seconds later by Teste, making fully as good time. It was seen that Teste had all but made up his four minutes' handicap over Clement, and when his net time was announced as 24:04 it was manifest that he had made tremendous speed, since at a mile a minute it would take more than twenty-eight seconds to cover the course, minus controls.

Arents passed twelfth, tire trouble having delayed him in his first round.

GABRIEL LEADS IN SECOND ROUND.

At 7:14:09 o'clock Gabriel passed again, leading at the end of the second round, having passed not only Campbell in the first round, but also in the second round, Tracy, Tart, Schmidt, Luttgen and Wallace. Thirteen minutes later Heath flew by, finishing his second lap in second place, and waving his right hand to the stand. He was sitting almost bolt upright, in a touring attitude that with uplifted arm would have made a beautiful model for a statue. Every time he passed thereafter he saluted the spectators and officials in the same way, apparently confident of final victory.

The Renault, with the ruffle radiator around the inner edge of its bonnet, which had passed in ninth position at the end of the first round, was announced to have twisted its drive shaft on the Bethpage road and to have been taken out of the contest. Tart was reported to be between stations and not heard from. Luttgen, with Wormser's Mercedes, was reported to have had tire trouble at Jericho, on the first round.

There was a flurry of excitement at 7:45 a.m., when Croker in his 75-horsepower shot past, followed at two lengths by Clement, who was edging over to the left to pass him. But Croker had gained eight minutes on the Frenchman and gone ahead of him in two rounds, a fact that was much appreciated



GEORGE HEATH AND MECHANICIAN IN THE SEATS OF THE WINNING PANHARD.



ALBERT CLEMENT, JR., AS HE APPEARED ON REMOVING HIS MASK IMMEDIATELY AFTER THE RACE—FINISHED SECOND.

as showing the possibilities of the American car and the nerve and ability of Croker as a driver.

WILD RUMORS FLY FAST.

As Hawley, Webb, Teste, Croker, Clement, Lytle and Schmidt completed their second rounds successively, in the order named, all by a few minutes after 8 o'clock, it became evident that the first and second rounds had worked a big elimination in the field of starters, and this was confirmed by the reports announced. Werner and Wallace had not been heard from since the first round. Arents's car was reported to have overturned near Queens and been wrecked. Upon receipt of the news, Vanderbilt rushed his car out again and flew off with the doctor to the scene of the accident. While he was gone rumors began flying thick and fast, seeming to come out of the air from no apparent source.

"Did you hear that Arents and his man were killed at Queens?" "Bernin is reported to have run into a train and been killed," and others equally distressing were passed from mouth to mouth. Owners of cars in the race hung closely about the door of the telephone and judges' box to get at the earliest moment true reports from along the course. Among them were Isidor Wormser, W. G. Brokaw, S. B. Stevens and R. E. Jarrige. In the grandstand, across the road, could be seen the picturesque figure of C. G. Dinsmore, who now and again put his hands to his mouth and called for "Whipple" and "Scarritt" in the official stand as if he had been meeting them daily for a year, instead of having been in America only a week. In a small private stand, just west of the grandstand, could be seen A. G. Vanderbilt, whose big Fiat had not yet appeared for its start.

CITY EDITORS MAKE INQUIRIES.

Meanwhile wild rumors and inquiries for verification were pouring into the press



A CHARACTERISTIC POSE OF H. H. LYTTLE, WINNER (UNOFFICIAL) OF THIRD PLACE.

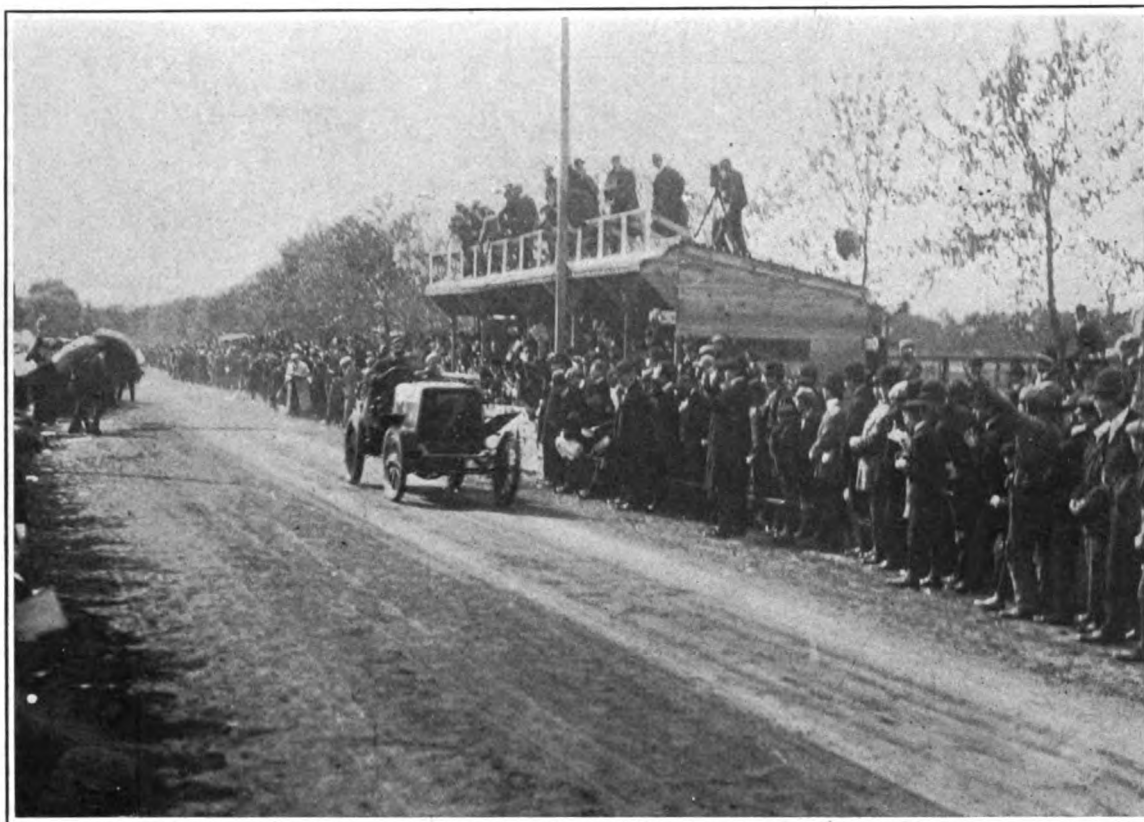

HEATH IN WINNING PANHARD AN INSTANT AFTER HE HAD CROSSED THE TAPE AT THE FINISH.

Photographed from the Grand Stand.



CROWD APPLAUDING CLEMENT AS HE APPROACHED THE FINISH LINE IN SECOND PLACE ON THE LAST ROUND.

Photographed from the Press Stand.

stand from the city editors of the big metropolitan dailies. One reporter got a telegram saying it was reported that seven men had been killed in Queens, and asking if it were true. Another newspaper representative received a message that Mr. Wallace had had both legs cut off, and he turned to a member of the press committee to inquire if he had heard anything about it, whereupon the committeeman replied: "I don't believe it can be so, for there is Mr. Wallace sitting in the grandstand," and he pointed him out.

SARTORI MAKES A FLYING START.

While these rumors were hurtling about, Sartori, in A. G. Vanderbilt's big Fiat, went past at a tremendous clip, holding up his right arm as a signal to catch his time. It was 8:22 o'clock when he crossed the tape. The chairman of the racing board held that he should have stopped to get his official time card, and ordered that he be flagged when he finished the first round and required to start properly. Less than 37 minutes later Sartori came around again and stopped about 100 yards beyond the grandstand. He did not come back to the tape, and Starter Gillette ran after him and deposited his starting time card in the copper pocket on the side of the car and told him to go on. He did so, but Chairman Pardington ruled that he should have started from the tape, and ordered that he be withdrawn from the race at Hicksville. The

message was sent over the wire, and Vanderbilt's car was held up there. This action greatly exercised Mr. Hollander, agent for the Fiat machines, who implored the chairman to let Sartori go on, arguing that it was a great hardship on the man to rule him out.

The matter was not finally settled until the return of the referee, W. K. Vanderbilt, Jr., from his trip to Queens to look after Mr. Arents. When he got back and had told the sad news of the accident that an hour later resulted in the death of Carl Mensel, Arents's mechanic, Mr. Pardington took the referee to one side, where,

leaning with elbows on the fence, they discussed the matter. Messrs. Scarritt, Whipple, Riker, Birdsall, Breese and Gillette quickly gathered around them, and a meeting of the race commission was held in the open, while newspaper reporters and photographers stood near, taking mental notes and snapping their shutters on the group. Vanderbilt, as referee, upon getting a full statement, quickly ruled that Sartori must be allowed to go on, since his official

half in which these incidents were occurring, the announcer reported the progress of the race at other points and the troubles to various cars on the road, while at intervals of from one to five minutes the competing cars tore furiously down the long lane of spectators that had been constantly growing and closing in as the people grew more accustomed to the passage of the cars. All of the racers steered a perfectly straight course and passed so directly in the center of the oiled strip of roadway that when the race ended there were two distinct tracks, each about eighteen inches wide, rolled hard and smooth and black, where the wheels had run, like a narrow country road with its two worn wheel tracks.

Tart was reported to have had tire trouble, Dinsmore's car No. 9 to have broken a cylinder, Campbell to have had difficulty with his left front wheel in the second round, and Tracy—who had surprised everybody by passing the stand at good speed at 8:38:25—to have broken a cylinder at the Bethpage turn. As Tracy passed the stand finishing his first round, his mechanic threw out a note saying that the propeller shaft joints had broken.

HEATH TAKES THE LEAD.

Heath, meanwhile, had worked up into first position in his fourth round and was leading right along. Hawley had passed the stand at the end of his fourth round

and stopped beyond the press stand with both front springs broken.

When the race was half over, at the end of the fifth lap, Heath was in first place, Gabriel second and Clement third. By this time, too, a number of newsboys were circulating through the crowds and in the stand shouting the New York papers with accounts of the accidents to Arents, Wallace, Tracy and others.

Just after Heath finished his seventh round at 10:48 a.m., attention of the spectators was attracted by a flock of seven wild geese flying southwestward over the stand, presaging the early coming of cold weather.



WILLIAM K. VANDERBILT, JR. (IN CENTER OF PICTURE) HELPING TO ROPE OFF A STRETCH OF THE ROAD WEST OF THE GRANDSTAND.

starting time was known to be 6:18 a.m. and that the time he was held in Hicksville must be deducted from his running time. However, although the onlookers watched for the second passage of Sartori, he never came around again.

Mr. Lillibridge, who had promptly driven Mrs. Arents, from the grandstand, in his touring car to the hospital whence her husband had been removed, returned and told that Arents's car had been overturned by running on the rim until the wheel broke.

SPECTATORS CROWD THE COURSE.

At short intervals during the hour and a

SCENES IN THE VICINITY OF THE GRAND STAND AT WESTBURY DURING THE VANDERBILT CUP RACE.

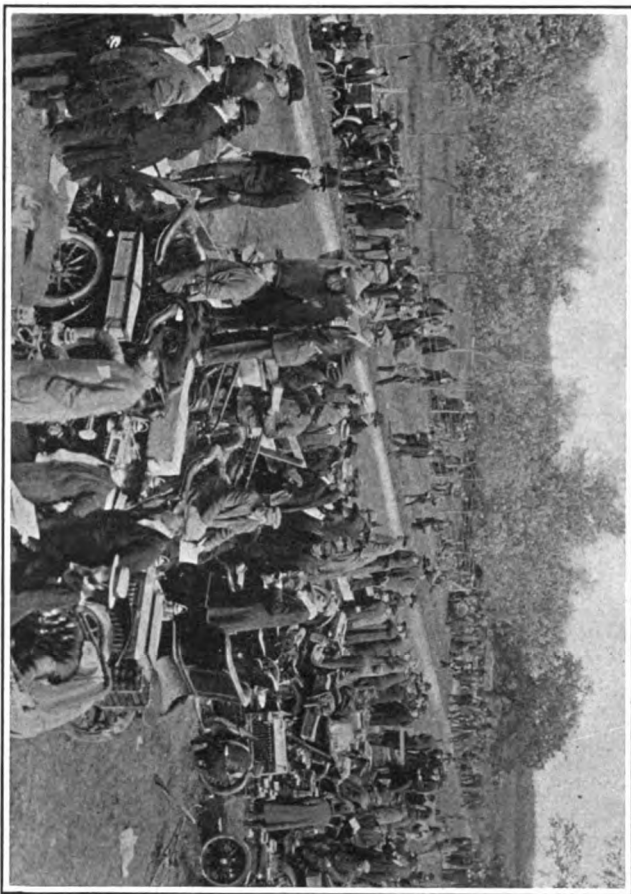

Spectators' Cars Parked on the Roadside West of the Grand Stand.

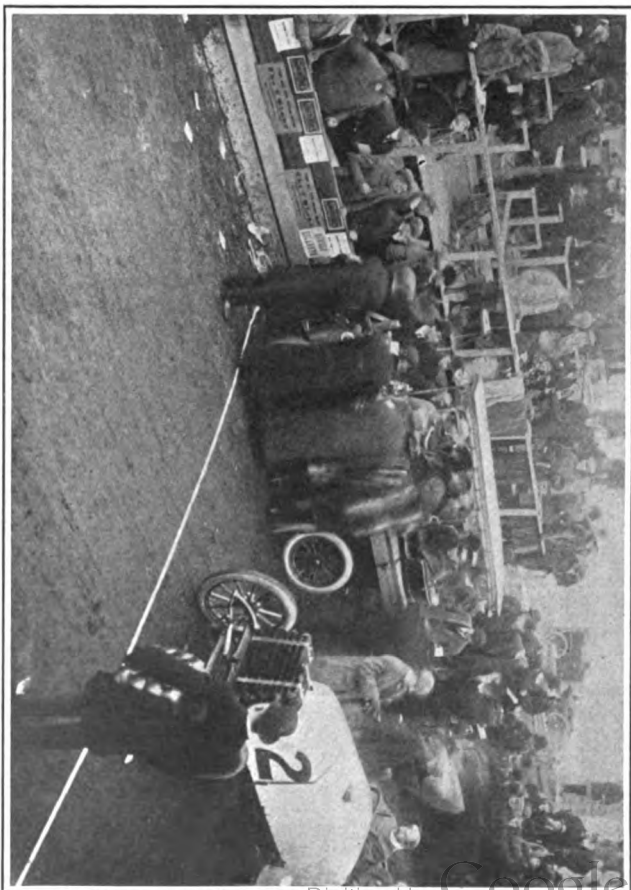

Scene When Spectator's Car Attempted to Drive Over the Tape at the Start.

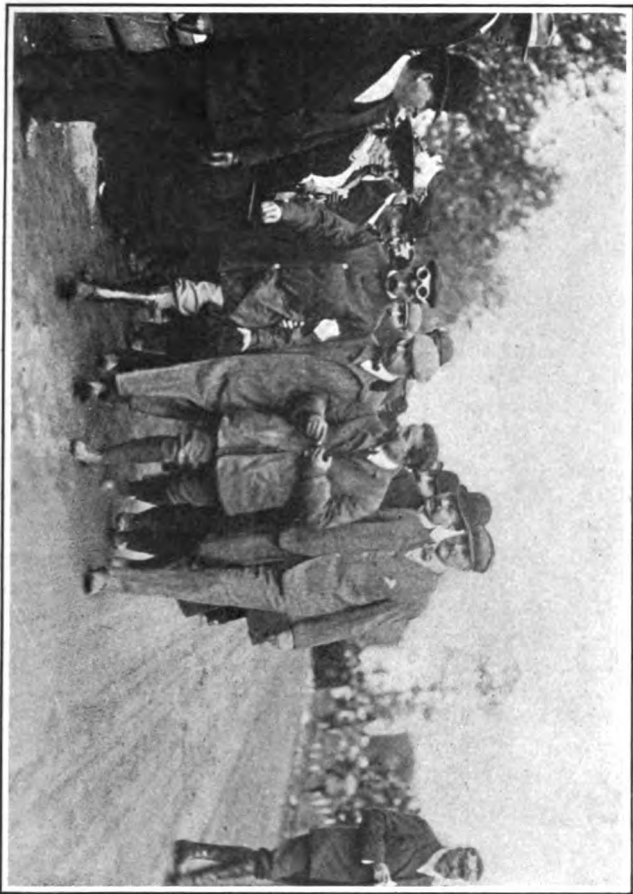

Albert Clement Presenting to Mr. Vanderbilt After He Had Come in Second.
W. K. Vanderbilt, Jr., Albert Clement, Jr
James L. Bress.

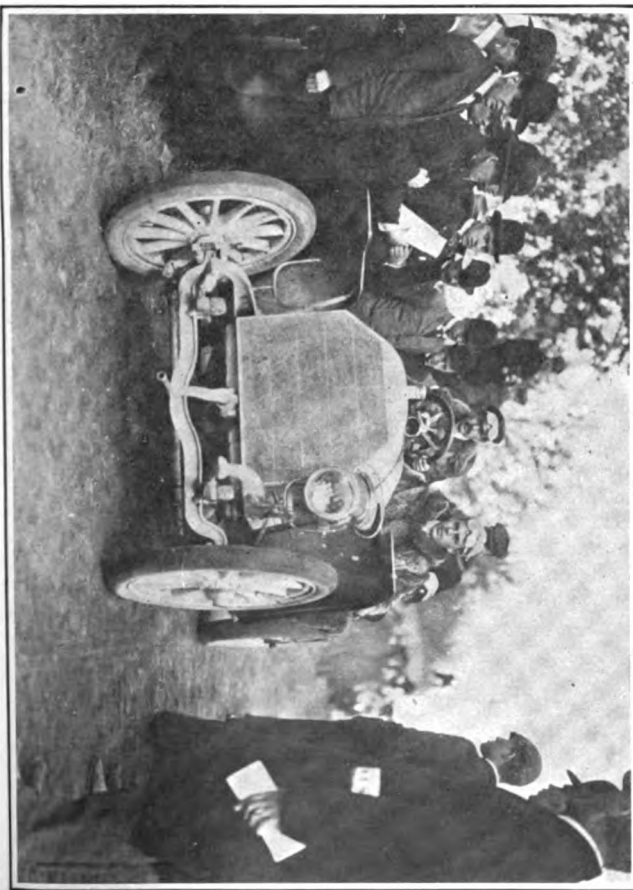

William K. Vanderbilt, Jr., in His Mercedes, Starting for Jericho with the Red Cross Surgeon.

APPREHENSION CAUSES DEPRESSION.

Interest in the contest and the depressing influence of the rumors and reports of accidents caused a strange quiet to pervade the crowd after the first four or five rounds, and despite the long interval that had elapsed since most of the people had eaten their hasty breakfasts between 4 and 6 a.m., few appeared to think of eating until after the race. A few sandwich men were on hand with their wares, but even they did very little business, while the bottled goods usually so much in evidence on similar occasions were hardly seen. A majority of the men in the grandstand had left it to mingle with the crowd around the official stand and to stand along the edges of the road, leaving the grandstand and boxes mainly occupied by women. President Farson, of the Chicago Automobile Club, and Chairman Frank Mudd, of the club road committee, were seated on the top of the fence.

The latter half of the race grew monotonous, except for the interest in the close contest between Heath and Clement, Gabriel having punctured a tire in Queens and later been reported out altogether. Heath and Clement were running nearly two laps ahead of all the others, with Clement ahead of Heath by 3 minutes 8 seconds in the eighth round, corrected time, and by 1 minute 48 seconds at the end of the ninth round. It was seen that the American was making up the time lost in his eighth round on account of tire trouble, and interest in the outcome developed rapidly. It was increased greatly by an announcement through the megaphone that Heath had just passed Queens. About seven minutes later he roared past the stand, going faster than at any time previously, the lane of humanity parting about 100 yards ahead of him and falling back as he came on, hats and handkerchiefs waving and cheers that he could not hear saluting him.

INTENSE SUSPENSE AT THE FINISH.

Then the suspense grew intense as every one waited for Clement, whose arrival must determine the victor. He was reported, only a few minutes after Heath passed, as having gone through Queens. If he reached the tape within eleven minutes after Heath's passage the race was his, since he had ten minutes credit for the difference in their starting times. To those who had backed their faith in Heath and the Panhard the minutes went all too quickly; to the bettors on Clement and the Clement car they seemed interminable. Slight attention was paid to other machines that passed, all eyes being strained for a glimpse of the blue streak and ears held alert for the sound of the Clement motor, that had already begun to be distinguished by many from those of the other cars. Watches were held in the hand and the going of the minutes counted.

Inexorably they ticked off, each as it went without sight or sound of his car, reducing

young Clement's chances of snatching victory from apparent defeat. The boyish chauffeur must have driven those last seven miles at a terrific pace; he had fought a determined contest from the start. But it availed him nothing, and when the eleven minutes had passed and still he had not been sighted, it was known that, barring errors in timing or allowances for other reasons, Heath was the winner. There was a sigh of relief that the suspense was ended, but hardly had it died away when a cry from the stand gave warning of a car coming, and less than a minute later Clement flashed by, loser of first place by 1 minute 28 seconds—the closest international race that had ever been run.

CLEMENT PROTESTS VIGOROUSLY.

There was a burst of applause, a running down the road after Clement, who was seen to have put on his brakes, and a few moments later the French boy came up in front of the stand, unsteadily gesticulating and expostulating, and supported on either side, Vanderbilt on his right carrying a red sweater on his arm. Clement had removed his helmet and goggles, and around his mouth and cheeks and chin, that had been unprotected in the race, was a great black blotch of oily dirt. He was trying in broken English to make a protest for alleged delays by the judges in the Hicksville control. He was told to enter a formal protest in writing and it would be acted upon that night at the official headquarters in Garden City. And this was done.

DISASTER IMPENDS AT THE END.

Nervously constituted and impatient, Americans will not wait for the ante-climax. The winner of the William K. Vanderbilt, Jr., Cup was known, and the spectators suddenly awoke to a realizing sense that they had appetites, and engagements in town. There was a rush for touring cars ranged along the road, and in five minutes the course was a jam of cars and people. Every second the arrival of another racing machine was expected, but the people took

heedless risk of a fatal collision, seeming to think it was time to go, notwithstanding all had been warned several times before Clement finished that his arrival would not end the race. But it did, nevertheless, for Mr. Vanderbilt, who was standing near his car, seemed instantly to realize the possibilities of a terrible disaster and hurried down to the official stand, calling to each official as he went, "Stop the race." Telephone messages were hastily sent to the controls and about 1:45 p.m. the contest officially came to an end. Schmidt and Campbell had already slipped through, finishing their eighth laps, and Lyttle, Tart, Croker and Luttgen were on the way from Queens to the stand and could not be stopped.

At about 1:56 Tart and Lyttle came up and stopped at the side of the road about 200 yards from the stand, the first with a right and the second with a left rear tire off. While a crowd gathered around them, Croker dashed past in the Simplex and finished his eighth round, narrowly missing a number of persons as he went through the crowd. Shortly after him came Luttgen, but Isidor Wormser, owner of the car, saw him coming and stopped him just as he came opposite the crippled cars. Luttgen jammed the brakes and slid the car twenty feet. He did not know why he was stopped, and looked almost ready to weep because he could not go on. Then Lyttle, having removed the loose shoe, drove his little Pope-Toledo over the tape, so completing his ninth round and placing his car actually third in the race. But there were no timers to catch him officially, as the officials had all started for Garden City. Vanderbilt, with commendable forethought, had waited a considerable time before driving away in his car with the doctor.

The 100 or more handsome cars parked east of the grandstand and the long row of them lined up in the lane leading diagonally back to Westbury had taken flight, and shortly after 2 o'clock the site of the start and finish of the great race looked deserted and desolate.

A Moving Scene at Queens.

TO the visitor at Queens, late Friday afternoon, the general air seemed one of subdued expectancy. Few knew how the plea for an injunction had fared, but the belief seemed to be general that it would not be granted. The representative of THE AUTOMOBILE had settled that important point by telephone before going out to Queens, and was able to assure questioners that the race would be held. No one expressed regret over this decision, the natives seemingly regarding the collision between the race promoters and the People's Protective Association as rather in the nature of an appetizer before the real thing appeared. One of them, when asked whether the people wanted the race or the injunction, replied, "Well, I don't know how it

may be further out, but around here they all want the race. They think these notices are a little too autocratic, though," indicating as he did to the profusion of placards: "DANGEROUS! KEEP OFF THE TURNS!" and the announcement placards which adorned half the trees and telegraph poles on the Creed avenue section of the course.

ON THE EVE OF THE RACE.

A few delivery and market wagons jogged along the road leading to Mineola and Jericho, and quite a sprinkling of automobiles were going to and fro, many of them evidently in the service of contestants or officials, or of the Continental and Goodrich tire depots established under tents near the second turn in Queens. All the vehicles

showed a preference for the narrow oiled strip in the center of the road—too narrow, it almost seemed, to be followed closely at a mile-a-minute speed on rather lumpy macadam, such as was encountered for the first couple of miles on the Jericho turnpike. The strip was but ten or a dozen feet wide, and had it not been laid straight as a string it would have been of little use. As it later turned out, the cars followed it closer than might have been expected. It gave a very good surface, not hard like a crust, but compact and firm like damp sand, only more so. At the first turn in Queens a hollow in the road had been filled with silt washed down by rain. It was of the character of sand, and was but slightly improved by the oil. The turn there is very sharp, and it was

RAILROAD CROSSING WARNINGS.

To avoid delay or collision at the railway crossing in Queens, a system of flag signals was arranged, covering Creed avenue from the first turn, a quarter of a mile from the crossing. Men were stationed at short intervals, each with two flags, one the customary white flag used by the deputies at all the crossings, the other divided into four squares, alternately white and red. When a racer was seen approaching the first turn, the white flags were waved. When a train was on or about to go over the crossing, the checkered flags were displayed. The flags, therefore, signalled the racers only, not the trains, which were directed by railroad employees at the crossing. If the flags showed a racer to be approach-

ing morning of the race; but before daybreak many visitors' cars went through, improving the last hour before the course was "closed" to gain vantage points further east. At the Madison Hotel, where the representatives of this paper stopped, a company of militia on their way to Creedmoor were at the breakfast table at 5 a.m. or earlier.

PATROLLED BY THE "FINEST."

By daybreak a few police officers were in place, patrolling the apex of the triangle and warning the stragglers off. For the most part the roads were absolutely deserted, save for a few early risers, waiting at their front gates for the first car to appear. It was calculated that it should arrive about 6:30, perhaps a couple of minutes earlier. Almost to the dot, at 6:32, the watcher strolling toward Floral Park heard the stillness broken by a cry of "Here he comes!" and a low rattle of exhausts. The rattle grew louder each instant, and around a slight bend in the road, a quarter of a mile away, appeared a low, white thing which, bounding on its springs over the rough macadam, devoured the black oiled strip with incredible velocity, and, flashing by, for a brief instant disclosed two forms, helmeted and goggled, and clad in long khaki-colored coats, crouching in the middle of a strangely-fashioned body, having an enormous bonnet and a tapering stern. On the side of the bonnet was the numeral "2." It was Gabriel and his mechanic in the De Dietrich. No. 1 had already been passed.

ASTONISHED THE NATIVES.

"Whe-ew!" gasped a native, who had just been trying to persuade THE AUTOMOBILE man that no contestant could be expected for a quarter of an hour yet, "wasn't he going, though! Like a streak of lightning!" And he shook his head in wordless amazement over his first glimpse of a seventy-mile speed on the highway. "Gosh, but that was fast!"

Up the road a horse, hitched to a light buggy carrying two feather-brained young men, had danced wildly for an instant as the appalling apparition shot by, and then, concluding perhaps that it had seen only a ghost, it quieted down, and suffered itself to be driven to the nearest crossroad, where it turned off.

A lapse of three or four minutes, and No. 1 came by. It was going fast, but seemingly not quite so fast as Gabriel's car, which was natural, its power being less. Its wheel base also was shorter, and it bounded quite noticeably more than the big De Dietrich. After the Mercedes had passed, an interval of some length ensued, broken by the appearance of the 60-horsepower Pope-Toledo. Close behind it was Heath's Panhard, going at a pace equal to Gabriel's. Then the rest came in the following order: Hawley, Lyttle, Clement, Teste, Bernin, Werner, Croker, Arents, and Schmidt. The speed of the smaller Pope-Toledo and the *Gray Wolf* seemed slow compared with that of the others, but it was quite as fast as



AN INTERESTING INCIDENT AT QUEENS — JOSEPH TRACY (NO. 3) TURNING UP A NEW PIN FOR PROPELLER SHAFT JOINT IN A WAGON SHOP.

From a Sketch Made at the Spot by Bernhard Gutmann.

evident that the racers would have to take it very slowly to avoid upsetting. The second turn was wider and had a better surface.

WARNINGS CLOSE IN.

A hundred yards, the distance of the warning flags from the turns and railway crossing, seemed very short when one considered that at full speed that distance might be covered by the fastest cars in three seconds or less; but every man in the race knew the course thoroughly, and, even had there been no flags, the crowds at the turns would have conveyed by their presence the needed information.

The trolley management proposed no change in schedule for the day of the race, but had instructed its motormen to stop when a racer was seen approaching in the opposite direction, and also to stop before the Creed avenue corner to give the racers all the room they needed to make the turn. These precautions proved sufficient, though naturally the passengers took the risk of such a mishap as that which happened to Arents' car.

ing, the train was held till the racer got by, and then was got over the crossing as quickly as possible. Should another racer come along at that instant, it would, of course, slow down in accordance with the checkered flags waved while the train was on the crossing; but, as it proved, the plan worked perfectly, no racer being delayed even an instant. On one occasion a train had already blocked the crossing when the flags began to wave, and the train was hastily reversed and backed off, just in time to let the car go by.

MANY SLEPT IN CHAIRS.

Those who had engaged accommodations early in Queens had reason to congratulate themselves on their foresight, for the less lucky visitor—and they were many—slept in chairs, on the floor, or in their automobiles when they had them. Among them were a group of *Fiat* retainers, who the next morning established a repair station under a tree at the roadside, where, as it happened, their services were not required.

Queens at large, having given itself a holiday, did not arise earlier than usual on the

PHOTOGRAPHS OF THE START OF THE CARS IN THE VANDERBILT CUP RACE.

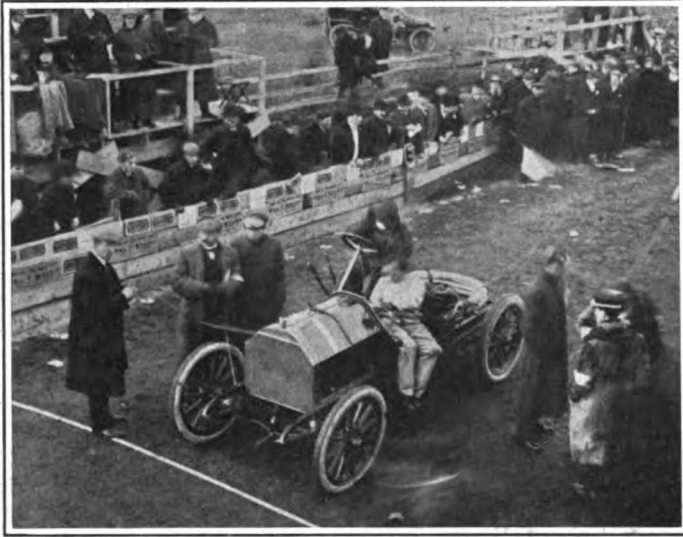

Germany—Campbell in 60-H. P. Mercedes, No. 1.

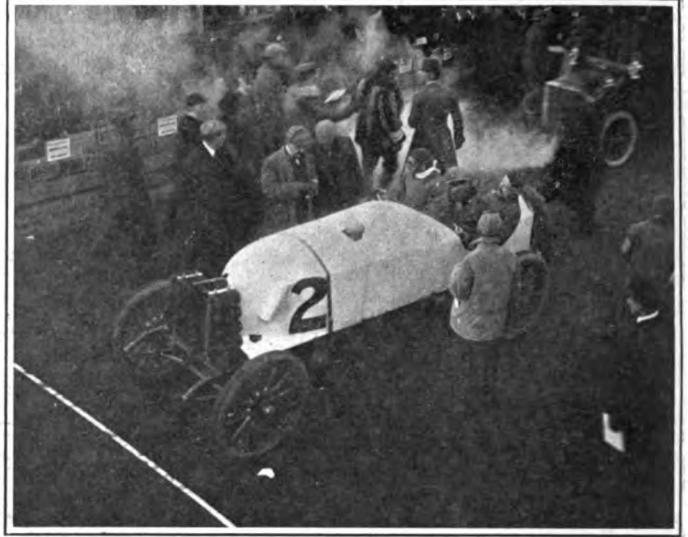

France—Gabriel in 80-H. P. De Dietrich, No. 2.

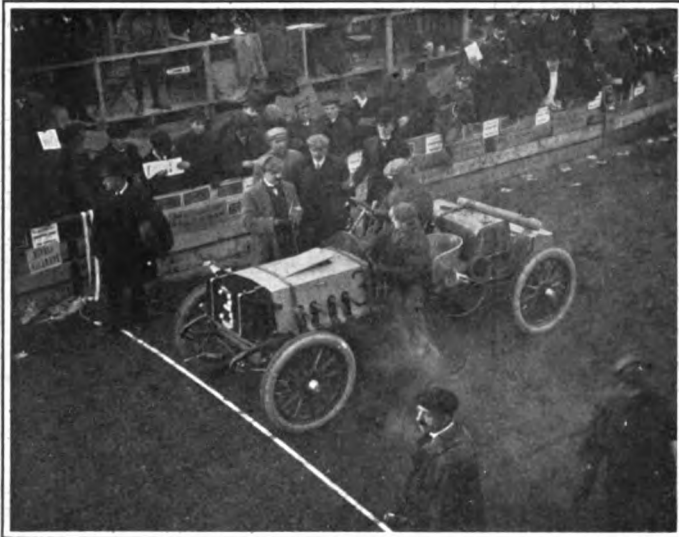

America—Tracy in 35-H. P. Royal Tourist, No. 3.

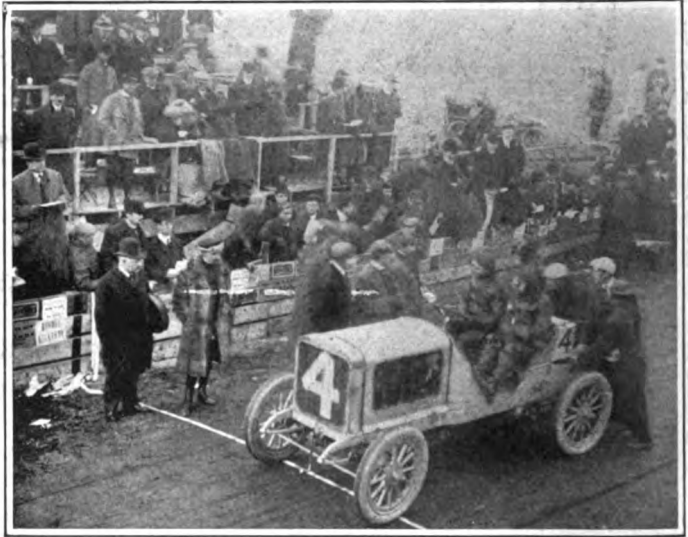

America—Webb in 60-H. P. Pope-Toledo, No. 4.

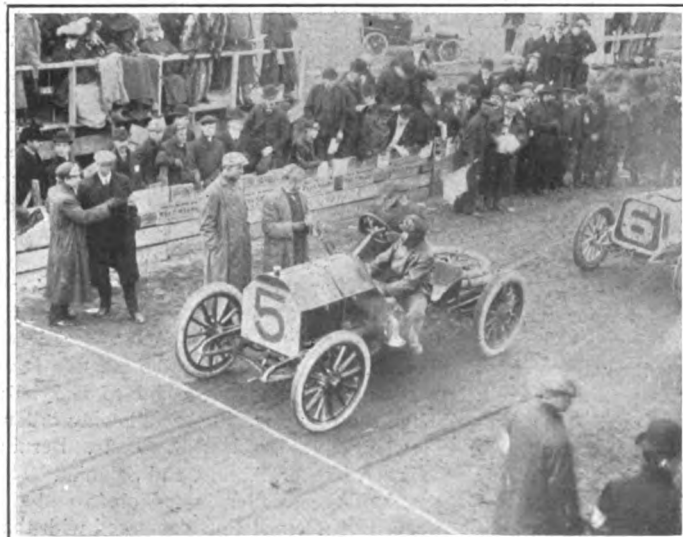

Germany—Arents in 60-H. P. Mercedes, No. 5.

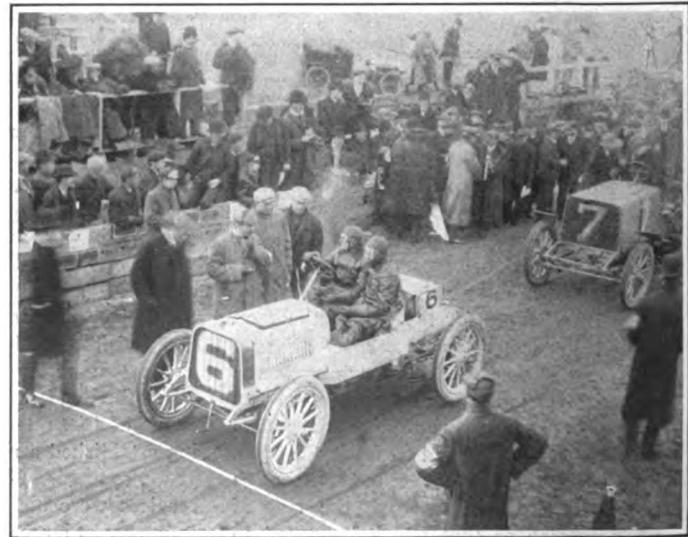

America—Lyttle in 24-H. P. Pope-Toledo, No. 6.

PHOTOGRAPHS OF THE START OF THE CARS IN THE VANDERBILT CUP RACE.

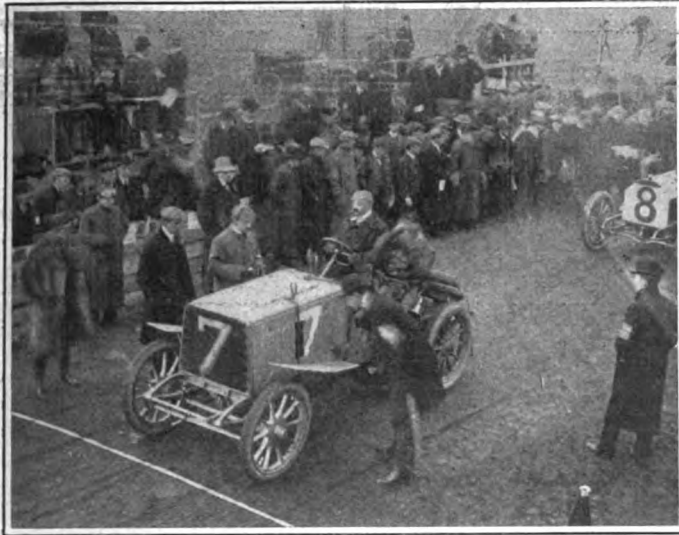

France—Heath in 90-H. P. Panhard, No. 7.

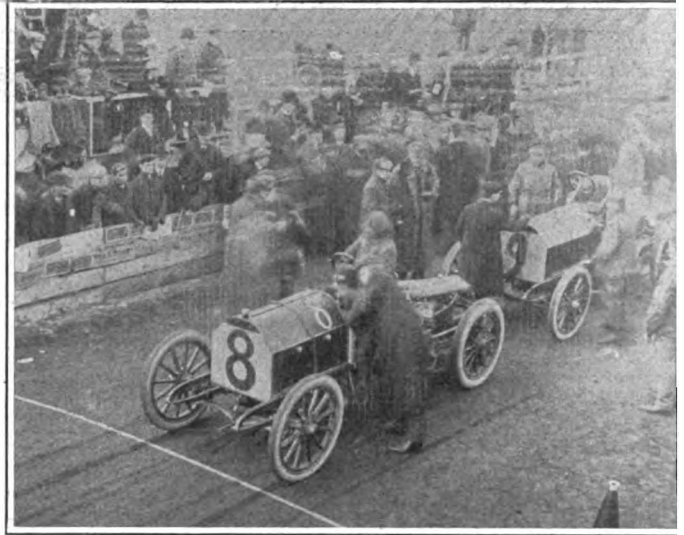

Germany—Hawley in 60-H. P. Mercedes, No. 8.



Germany—(Before Start) Werner in 90-H. P. Mercedes, No. 9.

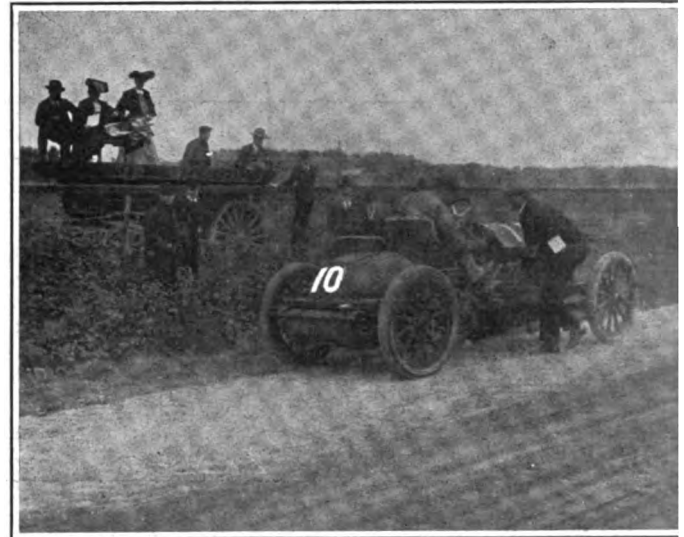

Italy—(Irregular Start) Sartori in 90-H. P. F.I.A.T., No. 10.

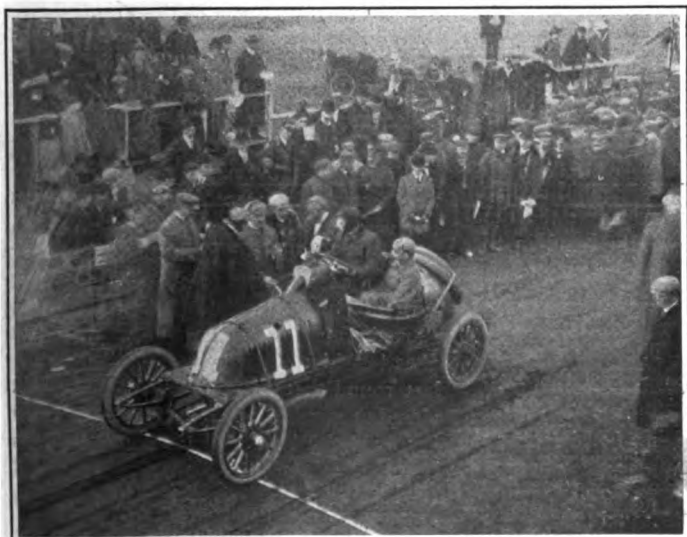

France—Bernin in 60-H. P. Renault, No. 11.

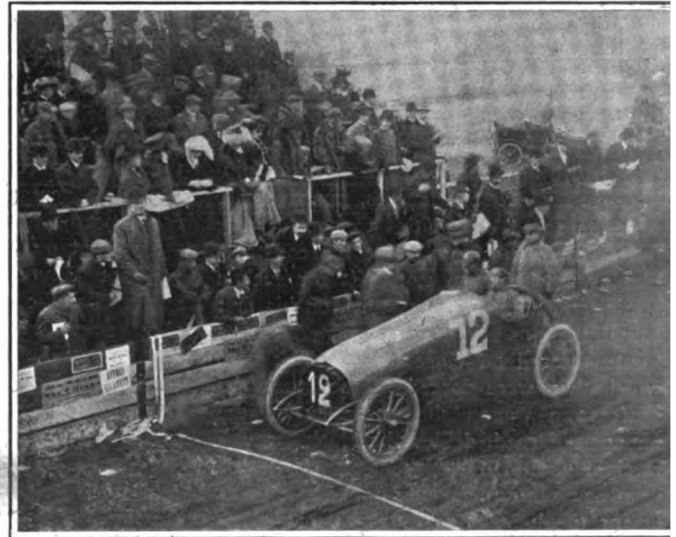

France—Clement, Jr., in 80-H. P. Clement-Bayard, No. 12.

most men would care to go. Schmidt, indeed, did not seem to be letting his car out to its limit, seemingly on account of the rather poor surface, for which the little track-racer was badly suited. The much-talked-of Renault of Bernin was certainly fast, but it jumped about a good deal and did not act as if it had staying qualities. Croker's car, on the other hand, rode better and seemed equally fast.

SOME DID NOT SLOW UP.

A little later, Wormser went by, but Tracy, Tarte, and the two Fiats were nowhere to be seen. It seemed too early to think of disabling accidents, and a stroll was taken beyond the railroad bridge of the Creedmore branch, to Floral Park. The cars were now doing their second rounds, with Gabriel first on the scene, and Heath second. The road dips and swerves to the left under the bridge, and there had been some impression that an accident might occur here; but every driver showed that he was familiar with the spot by slowing a trifle as he approached it, then dashing through and up the little hill beyond with a rush.

Just beyond was Floral Park, with many deputies waving white flags, and the local population gathered in little knots, watching the event with quiet interest, which quickened to subdued excitement as the distant rattle heralded the approach of a contestant.

Parked in nooks and intersections along the course were groups of automobiles, many with women passengers, some of them munching sandwiches, others warming their hands over little roadside fires, for the air was cool, almost frosty. For the most part the spectators seemed to realize that it was prudent to give the racers more than just room enough, for they got well back to the edges of the road with but little urging from the not very impressive "deputies."

SOMETHING DOING AT QUEENS.

Meanwhile things had been happening at Queens. The sandy first turn there had nearly justified the early apprehensions of an accident there, for on the first round nearly every driver took it at a speed which threw the dirt in showers, Gabriel, in fact, just missing a tree as he slewed around. After the first round or two, the corner was taken slowly.

Tracy, in tuning up his car before the race, had by ingenious modifications of piping, carbureter, and valves, managed to raise its speed capabilities to considerably over a mile a minute. But the construction as a whole was not built for such a strain, and at the Queens turn, on his first round, the pins of one of the propeller shaft joints sheared off close to the block with which they were forged. Tracy took the shaft to a wagon shop near by on the Hempstead road, drilled the block through at right angles to the old pins, and turned up a new pin out of an iron bar to a press fit for the hole. Luckily there was a hydraulic press, used for putting on wagon hubs, in this shop, and this was used to

force the new pin in place. After the breakdown and when Tracy and his mechanic were running toward the wagon shop with parts of the machine in their hands, a trolley load of passengers from New York was dropped at Queens. "Look at the fellows with half a machine on their backs," was the cry that caused a general laugh, as the visitors caught their first glimpse of any of the contestants in the race. While the new pin was being fitted, Tracy made a spare one out of tool steel in case of further breakage. The whole job took just two hours from stop to start of his car. Then he set off at a great pace, but was not seen again at Queens. The same could be said of Bernin and of Sartori, the latter of whom opened everyone's eyes by coming through Queens when most of the other cars were making their fifth round.

SPLENDID POLICE ARRANGEMENTS.

The policing at Queens was admirable. The course being there in New York City, officers were detailed there for special duty, mounted and on foot, and they kept the turns very fairly clear, especially on the far side, which was naturally the most dangerous.

Of the racers, Gabriel and Heath commanded the most respect and got the widest road, though Clement, after it became known that he was running close to Heath, was nearly an equal favorite. When the dashing Gabriel failed to appear, after his sixth round, universal disappointment was expressed.

NEWS OF ARENTS'S MISHAP.

About half-past eight a bicycle policeman, tearing madly down the road from the direction of Hempstead, brought the news of the one fatal accident of the day. One police patrol wagon and two ambulance wagons belonging to the St. John's Hospital were stationed at Queens, and one of the latter at once responded. Car No. 5, belonging to George Arents, Jr., had lost its left rear tire at Elmont, a mile and a half from Queens, and, escaping the control of its driver, had turned on its side, throwing out and fatally injuring Arents's mechanic, Carl Mensel.

The catastrophe was seen by but four men, from one of whom, C. N. Benjamin, of New York, the particulars were learned by THE AUTOMOBILE man, who was soon on the spot. It appeared that the driver, presumably Arents himself, though this point could not be positively learned at the time—had shut off power for the bend in the road at Elmont, and had just put on again, when the left rear tire came off, probably having burst, and rolled along beside and ahead of the car. The driver applied his brakes, but failed to control the direction of his machine, which swerved sharply to the left, striking the trolley rails at the left side of the road, then, recovering, made a long swing to the right, losing speed all the time, and at length whirled sharply to the left, and in some manner turned over on its left side. Before this juncture Arents

had dropped off, but his mechanic, staying with the car, was pitched violently to the ground, and his coat sleeve pinned under one of the splintered spokes of the left rear wheel. This wheel, probably owing to the wrench given it by the trolley rail, had lost its rim and broken its spokes close to the brake drum.

Help was quickly at hand. The injured men were picked up and laid by the roadside, the ambulance was sent for, and with the help of the crowd that speedily gathered the wrecked machine was pushed and rolled off the road to the edge of the neighboring field. Arents's injuries consisted of a cut cheek and a contusion over one eye so severe that it was twenty-four hours before the question of a fracture of the skull could be settled in the negative. He was brought to by the ambulance surgeon in about half an hour. Mensel had his skull fractured and dented in, and his left ear was torn off. He was bleeding freely from the mouth and ears. He recovered consciousness only for a few moments at a time, and died soon after being taken, with Arents, to the Nassau Hospital at Mineola.

It seems certain that the accident was due primarily to the insufficient racing experience of the man driving the car. A seasoned racing man will not mind losing one tire or all four tires on a straight road, which was what Arents was driving on at the time. But neither Arents nor Mensel had had racing experience, and apparently, when the tire came off, instead of the clutch or switch being opened and the car allowed to coast to a standstill, the brakes were applied and the steering partly neglected, with the result that the car slewed from side to side, probably whirled clear around, and overturned when the wheel was wrecked. The bungling manner in which the same driver made his first stop for the Hempstead control leads to the belief that it would have been wisest to rule him off the course then and there.

WILD RUMORS ABOUND.

An odd illustration of what Dame Rumor can do was afforded by the fact that, an hour after the accident, most of the crowd at Queens had but just heard of it, and were locating the reported accident at Elmont, Hempstead, Plain Edge, Hicksville, and Jericho. The identity of the car was correctly reported, but nearly everyone believed that both men were killed, which, after all, was not strange.

On the second round, Lytle and Werner came racing neck and neck for the first turn in Queens, and the former, who had started after Lytle, by clever work squeezed ahead of him at the turn. It was Werner's last round that day, however, while Lytle, slow but sure, in his 24-horsepower touring car, held third place at the end of the contest.

CROKER'S CLUTCH STUCK.

Frank Croker's clutch was sticking when he approached Queens on his fifth round,

PHOTOGRAPHS OF THE START OF THE CARS IN THE VANDERBILT CUP RACE.

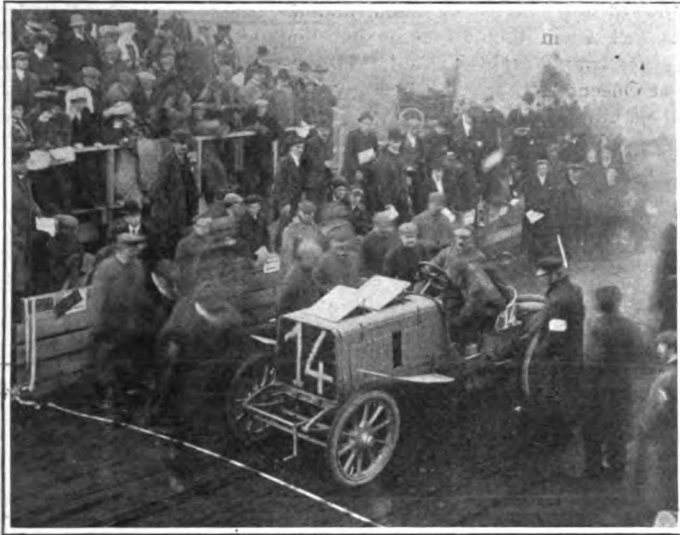

France—Tart in the 90-h.p. Panhard, No. 14.

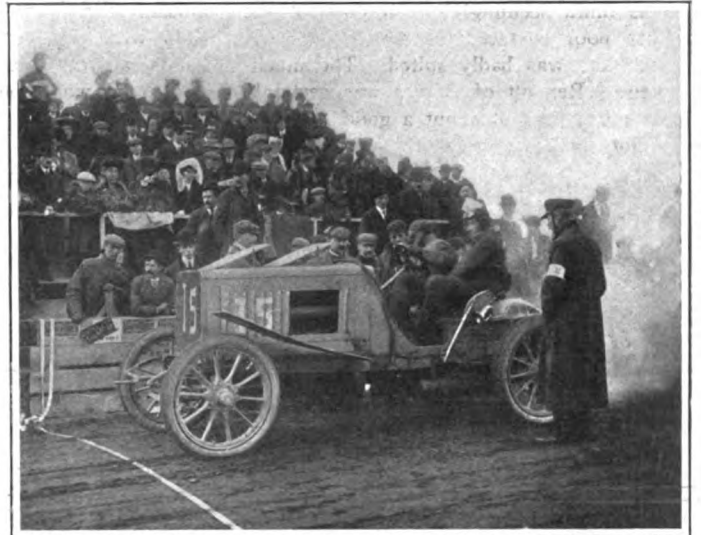

France—Teste in the 90-h.p. Panhard, No. 15.

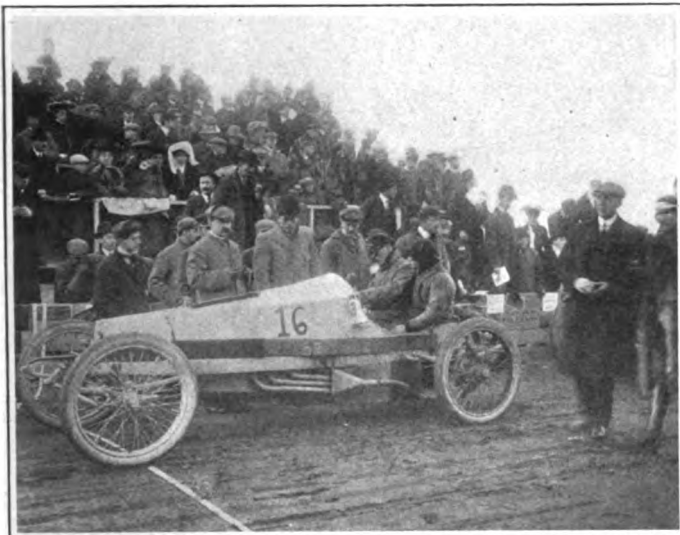

America—Schmidt in the Packard "Gray Wolf," No. 16.

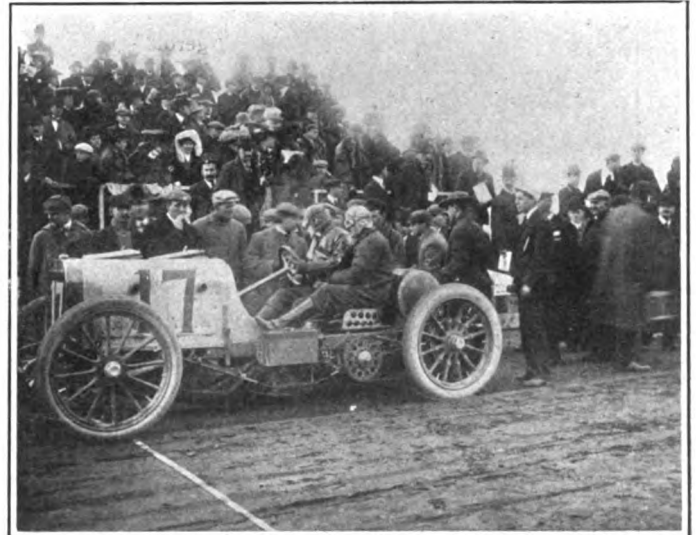

America—Croker in the 75-h.p. S. & M. Simplex, No. 17.

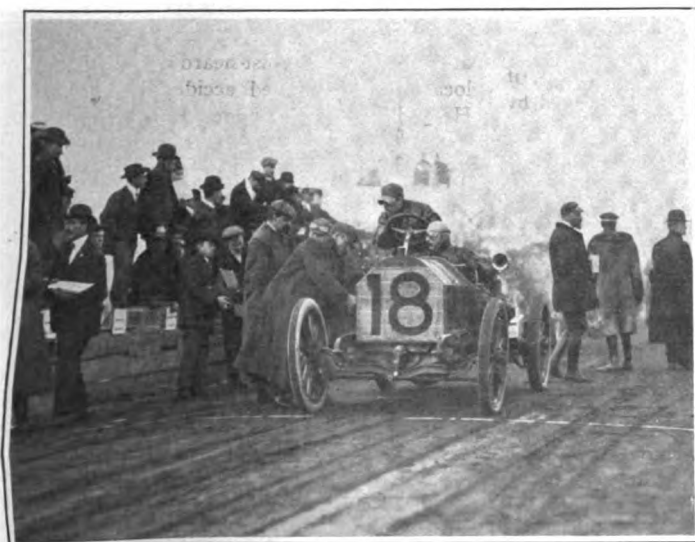

Germany—Luttgen in the 60-h.p. Mercedes, No. 18.

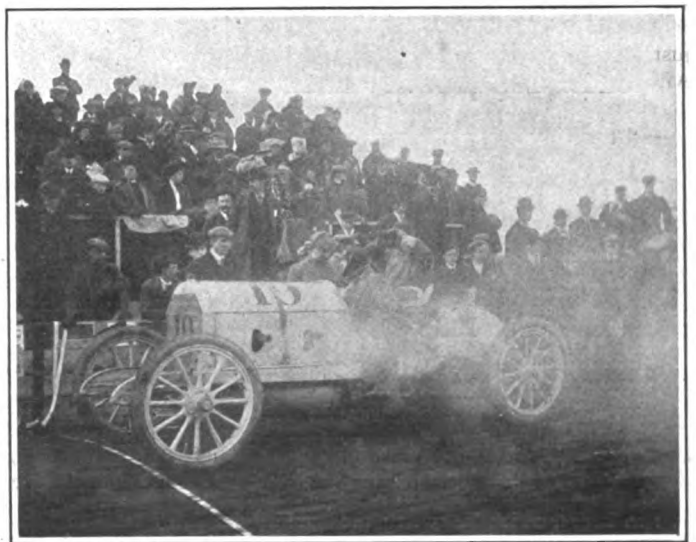

Italy—Wallace in the 90-h.p. F.I.A.T., No. 19.

and he barely managed to get around the turn. He stopped at once, just out of the way of Gabriel, who was only a few hundred yards behind. The frame of No. 17 had sagged and thrown the shafts out of line, and it was half an hour before Croker, aided by his mechanic and another man, who seemed to spring out of the ground from somewhere, managed to get going again. The whole construction of the car had been so perforated with holes, frame, levers, pedals, and minor parts, to make up for the weight of the bulky engine, that it did not seem possible that it could hang together long enough to finish the race. Evidently, if it did hang together, that would be all that

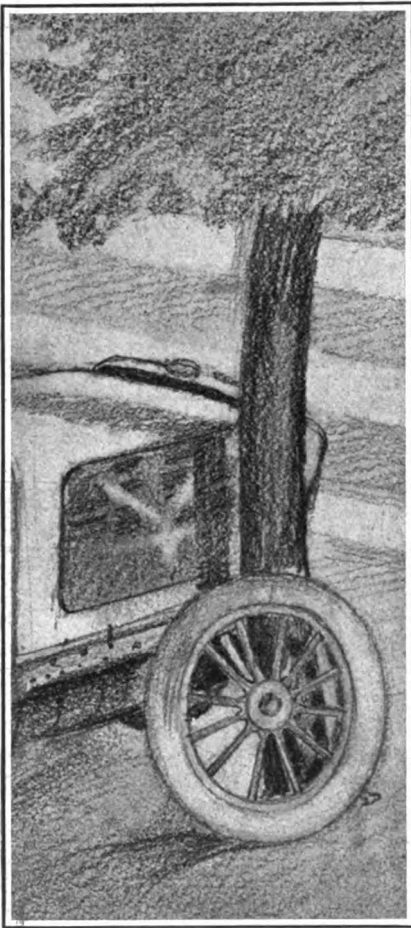

Sketch of Webb's Car After Collision.—Note position of tree between right front wheel and front end of frame.

Croker wanted, and he seemed quite indifferent to the palpable risk he was taking.

On the same round, Webb's Pope-Toledo had tire troubles—he reported six punctures in five laps, a surprising number, certainly, —and, having used up all his spares, he had to telegraph for more tires, because his tires, being 32 by 4 inches, were an odd size, and he could get no Continental or Goodrich tires to fit. There was no G. & J. tire depot on the course, and the delay cost him two hours, which he spent philosophically at Queens.

Heath, who, barring accidents, was by

this time pretty evidently the winner, had tire trouble nearly in the same place on his ninth lap, and lost forty minutes repairing. As those with watches figured out, the incident cost him all his lead over Clement, and a little more. He had to put in two inner tubes before he found one that would hold air, and when he started again it was at a tremendous pace. He passed through Queens on his last round like a whirlwind, opening the eyes even of those who had seen the race from its beginning, and reviving the hopes of his friends.

TWAS TIME FOR LUNCHEON.

By this time it was past noon, and sundry lunch wagons at the first Queens turn were doing a good business with those of the trolley visitors who had not had the forethought to engage luncheon at the hotels. With the growth in the crowds and the thinning out of the contestants—now seemingly numbering only Heath, Clement, Fart, Lytle, Webb, Campbell, Schmidt and Luttgen—the policing became less strict and the course more crowded. Although everybody was taking chances, every one got out of the way of the infrequent cars coming around.

WEBB HAD STARTED AGAIN.

Webb, who had started again after his two hours' wait for a tire, gladdened the hearts of his countrymen by coming through at a good pace, showing that, although he had lost the chance even of a place, it was not the fault of his car. Not many minutes afterward, one of the ambulances stationed at the first turn came by in a hurry, going with clangor of gong in the direction of Floral Park. From the attendants of the other ambulance it was learned that Webb had run into a tree less than a mile up the road.

WEBB'S REMARKABLE ESCAPE.

A knuckle connection in his steering gear had broken short off, and the car, now unsteerable, swerved abruptly to the left. Webb stuck to his seat and with great presence of mind jammed on his brakes so as to cause the car to slew around and avoid ramming a tree direct. This also served to reduce the velocity of the car, and, with the aid of good fortune, the car shot across the shallow ditch at the roadside and struck the tree so that it stood between the right fore wheel and the side of the frame. The impact of collision was, therefore, expended in pushing back the yielding axle, which, acting through the springs, bent down and inwards the front horns of the pressed steel frame where the spring ends were attached. The engine was practically undamaged. Had the car struck the tree squarely, probably one or both of the men would have been killed. As it was, however, both Webb and his mechanic, Andrew Anderson, were only thrown hard to the sod-covered ground and picked themselves up with only a few scratches and bruises. Anderson was one of the occupants of the smaller Pope-Toledo car a few days before, when it ran into a fence near Hicksville and a companion named Rigby was killed.

KNOWN THAT HEATH WON.

It was now known that Heath had won, with Clement, as expected, a close second; but the closeness of the race astonished every one. Almost at the same time word came by telephone to the checkers at Queens that the race had been declared over. No reason was given, but the spectators seemed satisfied, and within ten minutes the word had reached every one and the journey homeward had begun.

With the Crowd at Hempstead Control.

THE only places where it was possible to come into close touch with both men and machines, and to appreciate the inner spirit of the great contest, were the two controls, where every car stopped twice, if only for a moment, and where the needs of both drivers and cars were supplied.

The Hempstead control was not only the longer by a mile, but it was almost at the middle of the course, the west or outgoing end being nearly 15 miles from the starting line. The entrance to the control was at the east end of the town of Hempstead, where the open road is first lined with houses on each side. The road, which is the main street of the little town, winds along with several turns and changes of grade, the street being wide with a good macadam surface for the full width. Half a mile from the entering station the trolley road to Mineola crosses the street, and just beyond the departing station the same trolley road strikes into the main highway

and continues to Queens, the racing cars thus running side by side with the trolleys for about seven miles. Though repairs and supplies were rigidly prohibited by the rules within the limits of a control, the neighborhood of Hempstead was selected by most of the makers for their principal repair stations.

ENDS OF THE CONTROL.

The entering and departing stations were each marked by large white banners suspended across the road, with the word "CONTROL" in large letters and the announcement that not less than six minutes must be occupied in passing through the town, the total distance being 1.40 miles. The stands for the checkers were built just inside the fence line, and in front of each were two heavy white tapes pinned across the road at a distance of twenty-five feet apart. In the fields near by were pitched the tents of the repair men.

The largest outfit at the entering station was that of the Pope Motor Car Com-

SNAP SHOTS OF CARS TEMPORARILY AND PERMANENTLY DISABLED IN THE VANDERBILT CUP RACE.

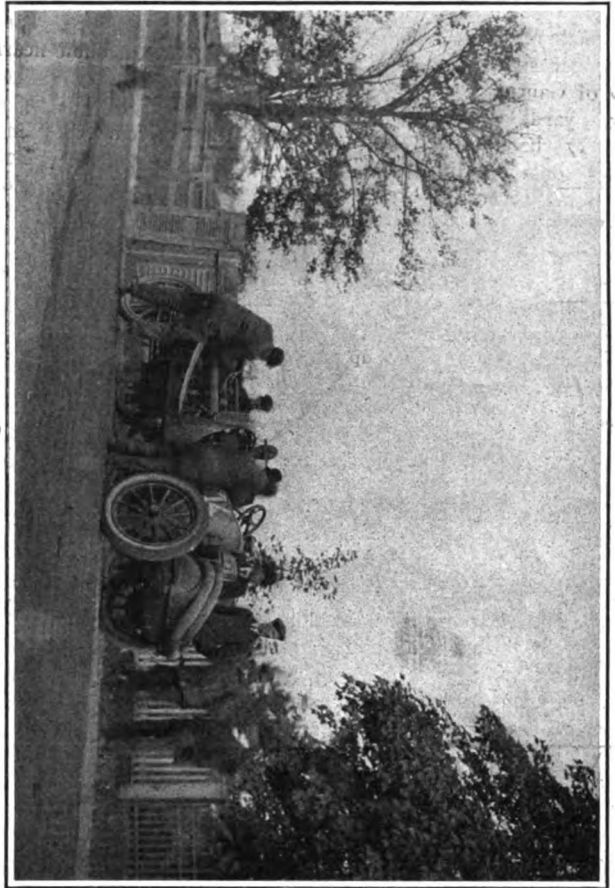

Tart Making Motor Adjustments on His Panhard Car by the Roadside.

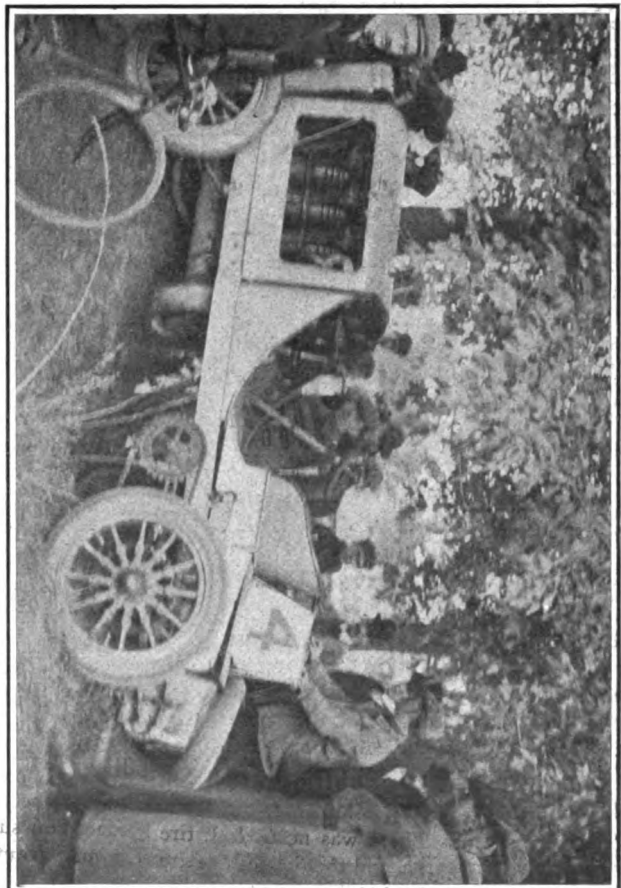

Webb's Pope-Toledo After it Collided with a Tree on the Jericho Turnpike.

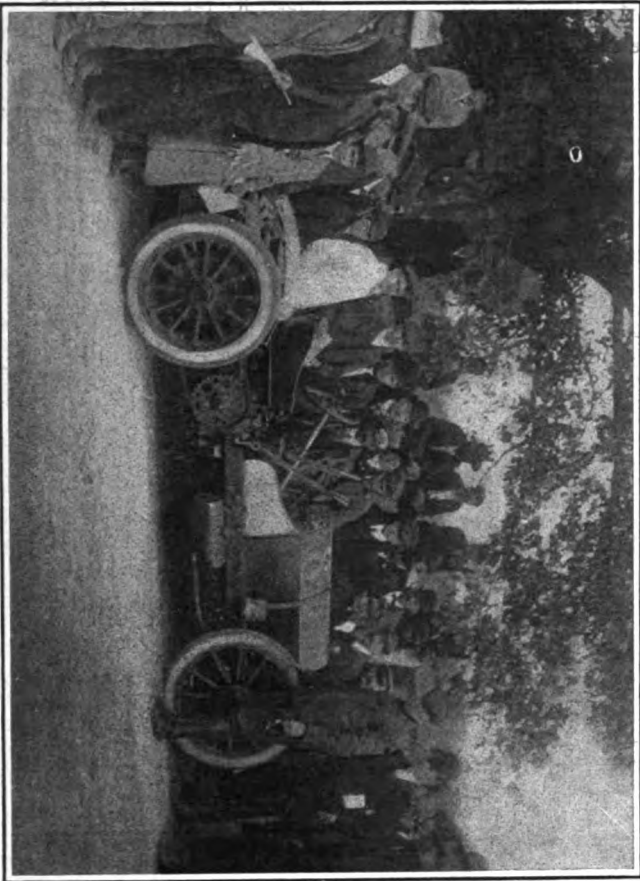

Hawley's 60-H.P. Mercedes with Front Springs Broken Near Grandstand.

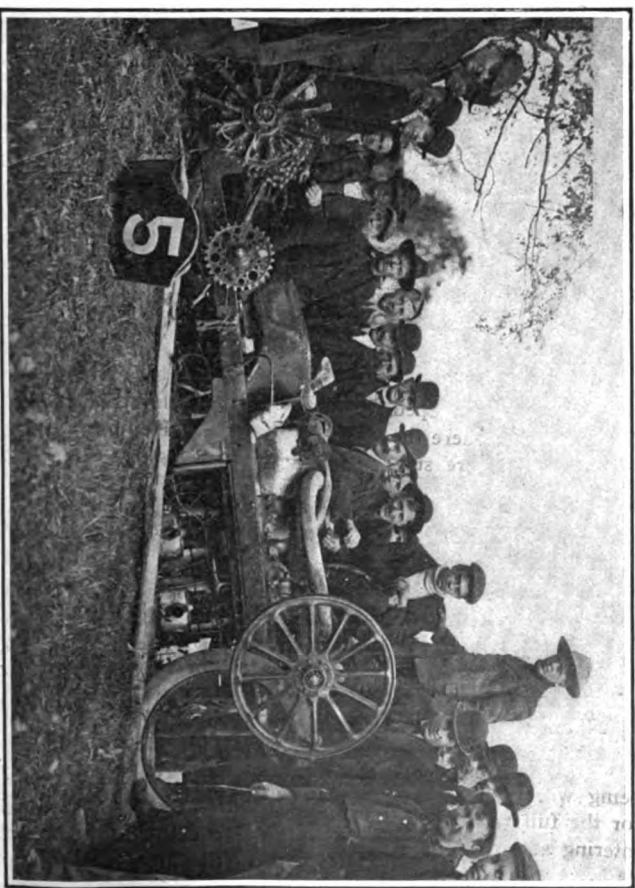

Wreck of Arentz's Mercedes Car at Elmont on the Hempstead-Jamaica Road.

pany, charged with the care of the two cars driven by Webb and Lytle. The force, under the direction of Mr. Goodwin, numbered several expert tire men and machinists, reinforced by a black bucket-brigade for cooling the tires. A generous outfit included tires, inner tubes, spark plugs, oil, gasoline and cylinders of compressed air. In addition to the lunch for the workers and some bottled beer, cups of milk with a little brandy were prepared for the drivers and their helpers. This party was encamped in the front yard of a country house whose dwellers had prepared food for sale, as a sign on a tree testified. The checkers' stand was in the same yard.

In the roadway beside the fence was a pile of supplies of all kinds, oil, tools and tires, in charge of two mechanics, for Mr. Brokaw's Renault; next to them, flanked by three F. I. A. T. standards, was a gasoline barrel mounted on posts some eight feet above the ground, with a hose attached and running out over the sidewalk. Along the fence were piled cans of lubricating oil by the dozen, tires, tools, and half a dozen long stout straps. A few yards down the road a Panhard car stood in by the fence with a party of mechanics ready. For the needs of the racers there was provided a basket of fresh eggs, uncooked, bottles of Poland water, and bottles of cold bouillon.

THE PANHARD PREPARATIONS.

At the outset this group was alert with expectation and hope for their respective charges; later on the Pope-Toledo party was in a rush of wild excitement over the good performance of their two cars and the crippled condition of one of them. The Panhard men had much to encourage them, though they had their troubles, too, over the delay of Tart on the first round and the disappearance of Teste after his third passing. Later on they were all excitement over the close racing of Heath and Clement.

There was something pathetic about the long weary day of the Renault and F. I. A. T. men. At first the former were encouraged by the prompt arrival of Bernin, then they waited patiently to hear his number called again; at last, discouraged, they sat down beside their tools and showed little interest in the triumphal turns of more fortunate drivers. The F. I. A. T. stand was equally desolate, all day long, in the midst of rush and bustle and confusion, the barrel of gasoline stood untapped and the bundles lay unopened. The late appearance of Sartori woke the attendants to a little interest, but after a second turn he never came back. Tracy's headquarters had been at a farm house just outside this control, and his friends had supplies for him. Two lunches of broiled chicken had been ordered for him in the town, to be ready at 8 o'clock and again at noon, but no one called for them.

THE OUTGOING STATION.

At the outgoing station the Continental

tire tent was in charge of Mr. Bäcker, with three expert German workmen, and the Diamond party were also camped near by. Late Friday night Barney Oldfield and a party came up in a car and finding several of the Continental men sleeping in the tent to guard their supplies, stopped with them until shortly before the start.

The late trains on Friday evening brought a number of strangers to Hempstead, and there was a vain hunt for rooms or even beds, but all accommodations had been taken in advance, some at very high prices regardless of quality. The town was quiet at 4 a.m. on Saturday except for touring cars rushing in all directions toward different points of the course, some north to Garden City, Westbury and Mineola, some East to points on the Bethpage road, and some West to Queens.

About 5 o'clock the town woke up, the deputies and their aids, appeared with badges and flags, and the passing of cars became more frequent. Shortly before 6 o'clock the three checkers appeared and took their places at the incoming station, with the timer and the judge, and a few spectators gathered about the tapes. One by one the pilots, country boys on bicycles, appeared, to the number of three, seven out of the ten engaged in advance failing to come to time. Some newspaper men and photographers also appeared and the battalion of repairmen, all busy unpacking and arranging their supplies.

WAITING THE FIRST ARRIVAL.

Everything was in order in good season, and for a few minutes there was a discussion of the probable time of the first arrival. It was broad daylight, with a clear sky, and the road was plainly visible except that, about a quarter of a mile from the tape, it swung a little to the South, all beyond being hidden.

A tall yachtsman with a marine glass over his shoulder, who accompanied THE AUTOMOBILE representative, chose a safe point of vantage on a big telegraph pole, climbing up until he found an uneasy and precarious seat on the bight of a guy line. Here he remained through the greater part of the day, like the lookout on the jumper strut of a Cup defender. He was adopted as a useful auxiliary by the checkers on the opposite side of the road, who, without the formality of an introduction, christened him "Bill" and relied on him to call out the number of each car as it rounded the bend. After a time a thoughtful man passed him up a box lid for a seat, which made his perch less painful.

It seemed to be accepted that No. 1 would be the first at the control, and there was some surprise when a big white hull came into view with the figure "2" on her serpentine coils. Swinging round the bend at a high speed, Gabriel slowed down as he neared the tape and brought her to a full stop within the limit at 6.17 a.m. The timer stepped up on the left of the car, marked the time on a small yellow card

and handed it to the pilot; a word, and the car started again in the wake of the pilot bicycle. They ran through the town at a little more than the nominated speed. The car stopped again between the tapes, the timer, F. A. Ross, stepped forward and took the card from the pilot, marked and signed it as the six minutes expired, and deposited it in the copper box on the right-hand side of the car. A touch and she sprang away, gathering speed each instant until she was out of sight.

CAMPBELL COMES INTO SIGHT.

Before Gabriel had more than started from the incoming control, Campbell on his big Mercedes swung into sight, coming up at 6:18 a.m. with a poor stop, having misjudged his distance. His card was made out, a pilot allotted, and he started on, reaching the out station and leaving just after Gabriel.

The next to arrive was Tracy, warmly greeted by his friends, though he ran about thirty feet over the second tape and had to back down, losing a little time; he took the last pilot and ran through the town. At the outgoing tape he was the victim of an intended pleasantry on the part of the Cleveland contingent. Watches in hand they stood beside his car and gave him the word to go. As he had not been round before he did not know the official by sight and so he started away. Poole, his mechanic, suspected that all was not right and warned Tracy who returned and was officially checked out, thereby losing time.

ARENTS RUNS AMUCK.

The Pope-Toledo people were now on the *qui vive* for their first car, Webb being No. 4, but a red car flashed around the bend, running fast and swerving as she neared the control, the brakes were thrown on and she slewed to the left, then to the right into the sand, ran on at good speed across both tapes, skidded badly and turned round, finally running up on the sidewalk about 50 feet beyond the inner tape. As she struck the low bank, barely missing a big tree, her mechanic was thrown out just alongside the left wheels, where he would have been crushed had she turned over outward, as might easily have happened. Her right wheels lifting from the ground as she stopped. He jumped up, apparently unhurt, and started to push the car as she backed over the gutter and back between the tapes. The car was No. 5, driven by Arents, and the man who thus escaped was the unfortunate Mensel, who lost his life only a couple of hours later. The accident, which would have proved fatal to some of the spectators later in the day, was due solely to the speed at which the car approached the tape and the manner in which she was stopped. After she was in place between the tapes her time was taken, and she started on without a pilot, none being at hand. She was timed as leaving at 6:30, but when clear of the tape she lost twenty minutes in replacing a tire.

The next car was No. 4, Webb making a good stop and going right on without a pilot; then came Heath in his Panhard.

The effects of long practice in racing were shown in the work of all the foreign drivers, Tart, Teste, Werner, Gabriel and Clement. They carried their speed around the bend, checked down quickly and easily, and berthed their cars midway between the tapes. At this work Heath was particularly good, the car stopped abreast of the timer, the ticket was taken, and she was away again without any sliding.

Hawley, in the Thomas Mercedes, followed about five minutes after Heath, making a good stop and starting quickly, then came Lyttle in the second Pope-Toledo and Bernin in the Renault, both making good stops. Before this the three lone pilots had returned and gone out again, but they were partly done up by the quick runs up hill, and as none of the others appeared to relieve them the cars were sent on for the rest of the day without pilots.

INQUIRIES FOR SARTORI.

There were many inquiries for Sartori throughout the growing crowd of townsmen, farmers and out-of-town strangers, as he was considered a probable winner, but nothing could be heard as to the cause of his non-arrival. Clement came in on time, stopping promptly, taking his card, and starting at once: he was timed out at 6:44, but when clear of the far tape he stopped for about five minutes and then got under way with his motor working hard. His was the most peculiar of all the varied headgear, the new football helmet of heavy leather, designed after the model of an old-fashioned nightcap, fastened under the chin, and with an extra leather band around the forehead and head just over the eyes.

Tart made the first half lap in good time and stopped promptly, taking his card and continuing into the town, but when near the out station he came to grief, his batteries failing. He was stalled for nearly an hour, having entered the control at 6:38 and leaving at 7:39. Teste came up next, followed by Werner, who had started ten minutes ahead of him.

The drivers most talked of by the gathering crowd were Gabriel, Sartori and Croker, the latter being the object of much curiosity and sympathy. He came in at 6:48, his car apparently in good condition except that a pin had been lost from the starting handle and could not be replaced. The car came to the line slowly, and the motor stopped, being cranked with some difficulty. After receiving the card she started very quickly and ran into the town at a high speed and with loud blasts from the motor. Following her came Schmidt, in the Packard racer, stopping promptly, but his helper being obliged to ship the long handle and crank the motor twice before starting off.

ANOTHER RUMOR CENTER.

Vague rumors were now afloat, coming from nowhere in particular, that Sartori

had failed to start, but everyone was looking for Wallace in the other F. I. A. T. car. The time went by until at length the man on the telegraph pole shouted out "Car coming—Number '2,'" and soon Gabriel stopped for the second time at 6:52. He had made the round in 35 minutes, including the nine minutes of the controls, or about 27 1-2 miles in 26 minutes. Following him by a couple of minutes came Luttgen, driving Mr. Wormser's Mercedes, on his first round.

When Campbell came up on the second round in No. 1 his left front tire was entirely gone and he was running on the rim, he continued into the town and on out of the control in this condition. The third man on the second round was Webb, running over the tapes and being obliged to back before being timed. Following him came Heath, with one of his good stops and lively starts, going ahead while Webb was still backing up. When Hawley stopped his mechanic jumped forward for a look into the water tank, and on passing the out station the tank was refilled. Teste, Lyttle, Werner and Clement now passed in succession, all stopping promptly and running right on. The bicycle pilotage had proved a failure before this, and word now came to abandon it and send each car through alone.

When Croker came through at 7:22 he asked for a pin for the starting handle, but none could be had. The back of his seat, sheet aluminum perforated with many small and large holes, had broken completely across, the small bridges of metal between the holes giving way, but the car seemed in good condition otherwise.

GABRIEL MAKES A POOR STOP.

On his third turn Gabriel made a poor stop, running several feet over the inner tape. Heath came up in his usual form, and immediately after him came Schmidt, his motor stopping just short of the first tape, so that it was necessary to use the crank. Hawley made a good stop on entering the control at 7:43, and after passing out at 7:51 took on oil.

WEBB MAKES HASTY REPAIR.

When Webb came up at 7:46 it was evident that something was wrong with the car, as he drew in to the right of the road and stopped short of the tape. The repair brigade rushed out instantly and surrounded the car, a darky pouring water over each tire, though they were not overheated. Webb himself, the coolest one of the party, pointed out that his gasoline tank was falling off and also leaking, while his mechanic was calling for chewing-gum. A special tank had been fitted back of the seat, supported by straps of band iron passing around it, while below an improvised toolbox had been hung to the same straps. The weight of the box, added to that of the tank, had proved too much, and the straps were loose, the tank partly falling off and jumping up and down until a leak was started in the left lower corner by one of

the bolts. The case looked hopeless, as the leak was quite a large one, but under Webb's direction repairs were attempted. The tops and sides of boxes were placed under the tank to give it a good bearing, the leak was plugged as well as possible with chewing-gum or something similar, and a couple of big straps borrowed from the F. I. A. T. outfit were tightened around the tank and seat. In addition, rope lashings were put on. The tank was filled, a special funnel with two pipes attached being used on both of the filling holes at the same time. The repairs completed, the car crossed the tape and was timed at 8:01; she ran through the town and was timed at the out station, but here again she was in trouble.

Meanwhile Teste had come up, making a poor stop and being compelled to back a few feet, then Arents came along in No. 5 with a tire gone; stopping at 7:53 for water. She ran through the control and made repairs after being timed out, not leaving until 8:27, on what proved to be the last and fatal run.

CLEMENT DELAYED BY LEAK.

Clement passed for the third time at 7:58; there was no dust on the road in the ordinary sense, the oil coating being thoroughly effective, but with neither beard nor mustache, and with no protection for the lower part of his face, he had a broad circle of yellow dirt from his eyes to his chin, with only his red lips in the center, making a most grotesque appearance. At the out station he was delayed for some time by a leaking gasoline pipe.

When Lyttle came up at 8:30 someone certainly blundered, for there was a charge of the dark brigade, each of the four tires being soused with water until the whole space between the tapes and in the middle of the road was a sodden puddle. A little later when Heath came up his car slipped over the tape and for the first and only time he made a poor stop; he complained of the water, and efforts were made to cover the road with dry gravel.

The next car to arrive after Webb was No. 14, Tarte, at 8:11, stopping quickly, but waiting a little time while the lubricator was filled. Croker came in on his third round two minutes later, taking the tape at speed and running over about 100 feet beyond owing to a failure of his brakes. Wormser came in immediately after him, stopping for a moment and then running on while the Croker car was pushed back between the tapes. The cry of "Car coming" partly scattered the crowd about the Croker car as Gabriel rushed up and stopped on the right of it. After hard work at the crank the Croker car was started, and as Gabriel left it speeded up to catch him in the town. When it came at speed to the out station it failed to stop and again ran on for about 100 feet, being compelled to back. An effort was made to repair the brakes, and about eleven minutes were lost in this work. Among the

SCENES OUTSIDE AND WITHIN THE CONTROL IN HEMPSTEAD DURING THE VANDERBILT CUP RACE.

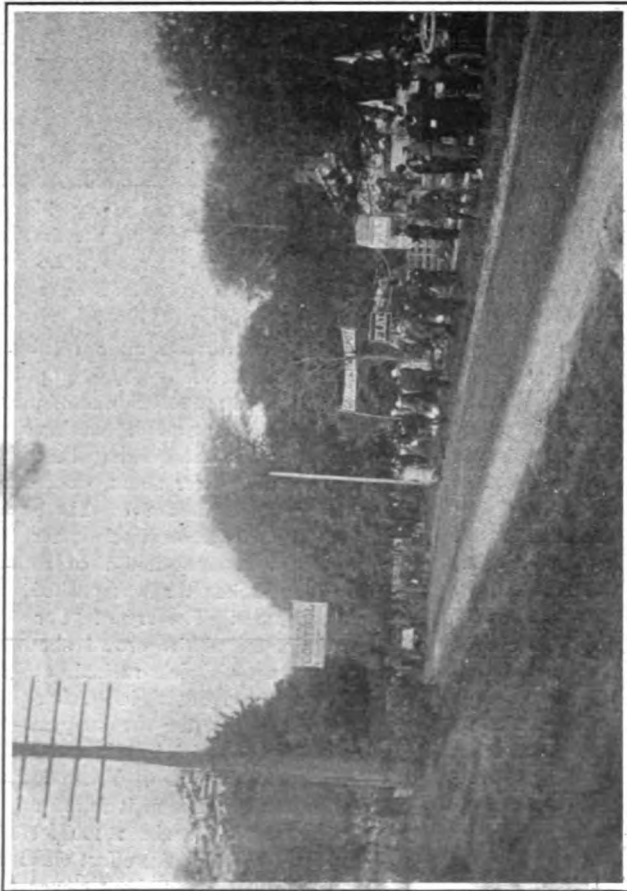

Looking West at the Entrance to the Control.—Note Tire and Supply Depots to the Right.

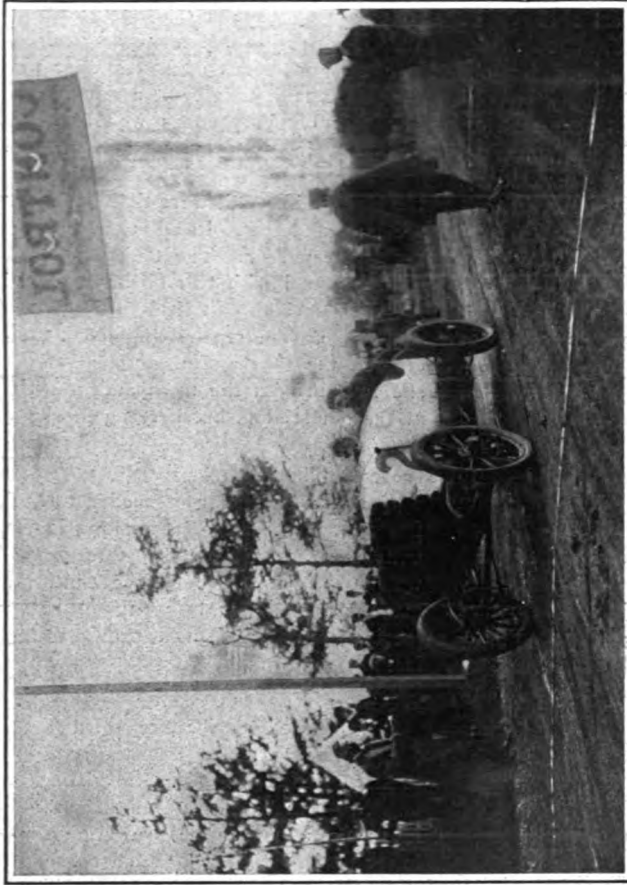

Gabriel in the De Dietrich About to Leave the Incoming Station.

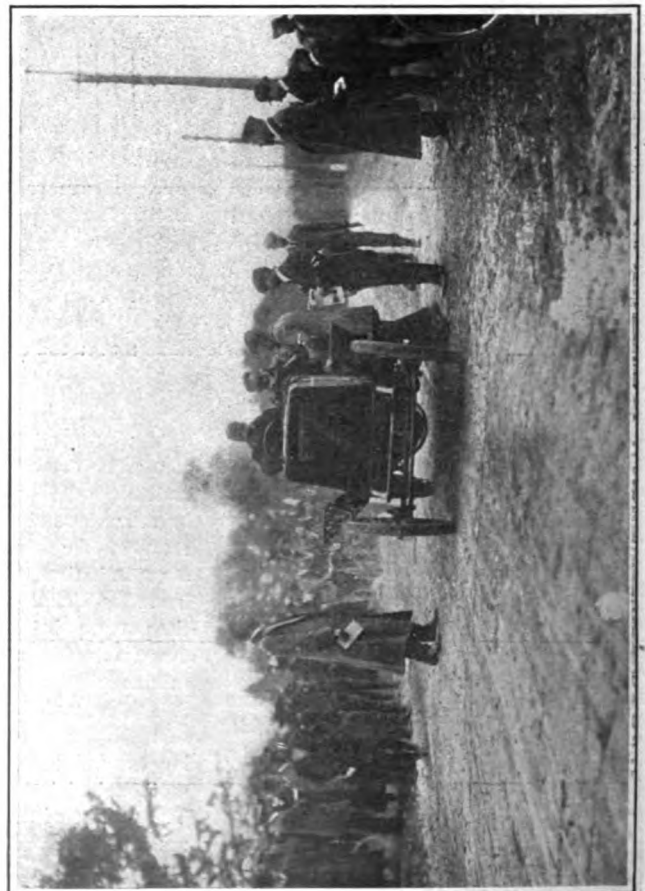

Health Between the Incoming Tapes. Mechanician with Time Check Between His Teeth.

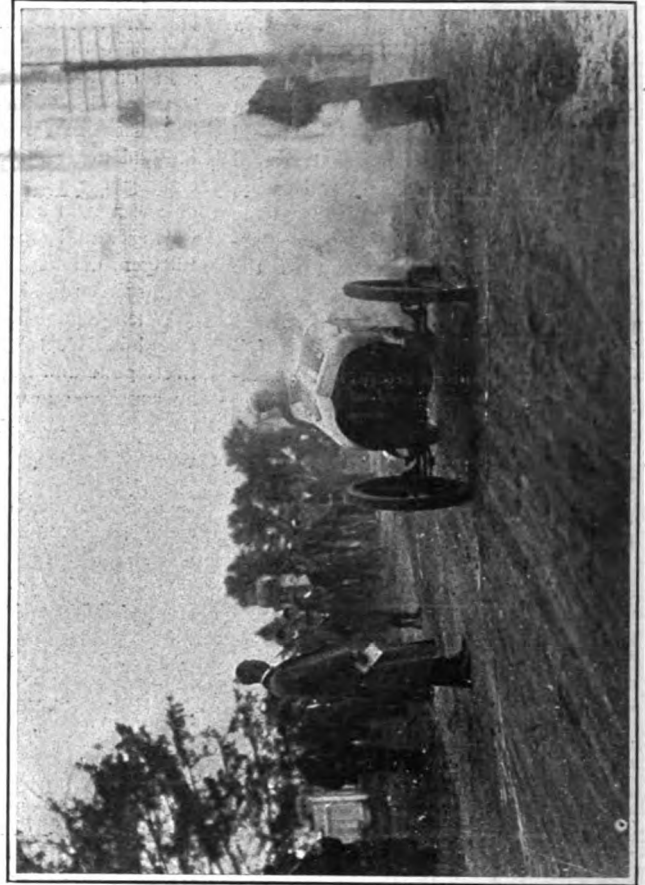

Clement-Bayard Smoking Like a Car on Fire on Arrival in Sixth Round.

SWAP SHOTS OF INTERESTING INCIDENTS IN AND NEAR THE HEMPSTEAD CONTROL.

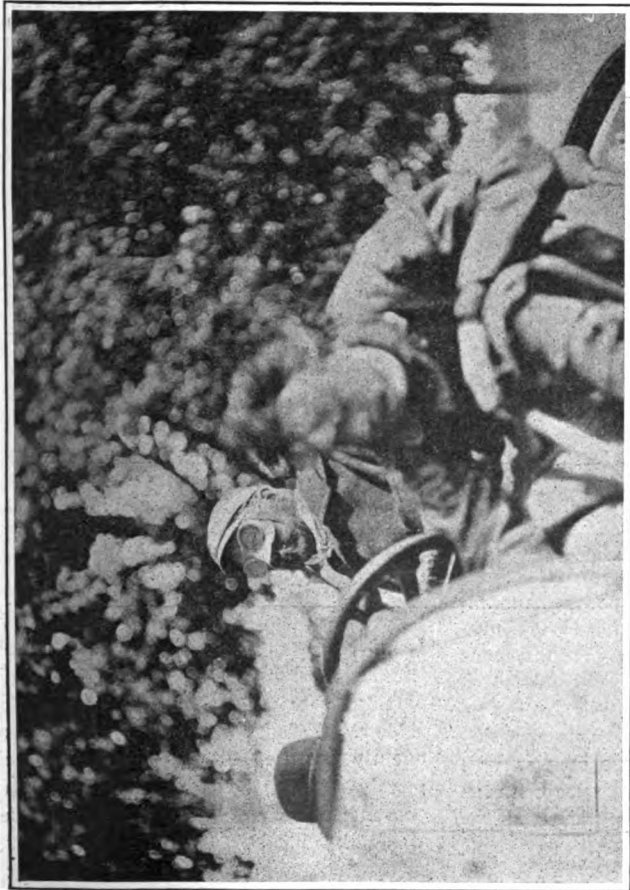

Heath and His Mechanician Lejunie Ready to Start Away While on the Seventh Round.

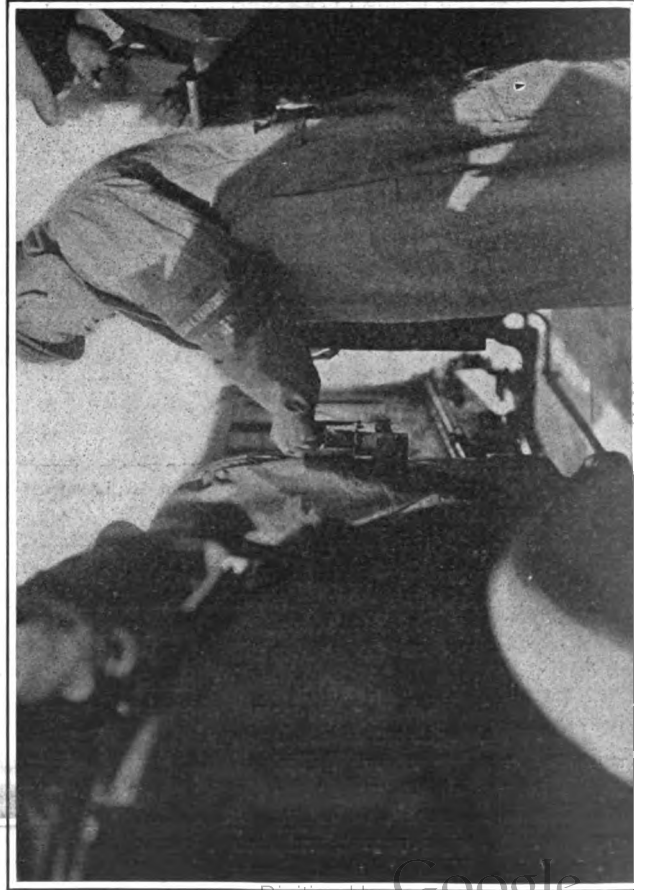

Timer at the Outgoing Station Counting off the Seconds an Instant Before the Start.



visitors to the outer station at this time was Baron Frederic de Turckheim, of the de Dietrich company.

HAWLEY SLIPS ON WET ROAD.

When Hawley came up closely following Heath at 8:21 he, too, slipped in the wet road, and the front wheels of the car stopped on the far tape; he backed a little, took his card, and was off.

By this time there were about a couple of hundred people at the incoming station, with a dozen cars drawn up in the fork of the intersecting road. Many of the spectators were residents of the locality, while others were evidently from New York or other outside points. As they became more familiar with the spectacle of the rushing cars, and as the intervals between each became longer, they crowded closely into the road until there was barely room for a car to pass between two crowds of men, women, children and even small children in arms. What made the matter still worse was the presence of several boys with bicycles in each group; in the event of a sudden stampede the bicycles would inevitably have tripped many persons. Such skidding as that of Arents at any time between 10 and 1 o'clock would almost inevitably have resulted in the injury of many persons. Throughout the day there was no one at either entering or departing station to keep the people back for their own safety, nor could this have been done except by a file of soldiers along each side of the road with guns touching. The people were as reckless and careless as at a circus parade or political procession. The passage of a horse and sulky along the road to the east called attention to the fact that there had been practically no outside traffic since the start of the race.

SARTORI TURNS UP.

To the amazement of all, shortly after Schmidt had made his third passage at 8:30, Sartori was seen approaching at high speed in the missing F. I. A. T. He ran by the tapes a distance of some fifty yards and was compelled to back. When released he rushed on into the town and passed out at the end of his six minutes. When Clement came in for the fourth time at 8:37 his mechanic stepped down and examined the brake for a moment before they started up quickly; they ran through and after being timed out stopped until 9:05 in making repairs. Tarte, Lyttle and Heath came in within about six minutes, all stopping quickly and getting promptly away except that Heath's mechanic took advantage of the stop to fill the lubricator.

The cry of "No. 4 with one tire gone," from the lookout, brought out all the Pope-Toledo forces in a hurry, and Webb was seen at the bend with Luttgren just passing him. The big Mercedes whirled up to the tapes, paused for an instant, and then rushed on, while Webb followed slowly and drew his car out on the right side of

the road short of the tape. As he stopped he told his friends that he had passed Arents car upside down in the road east of Queens with both men killed. He had little to say, having passed very quickly, and he was in no humor to discuss the matter, so the report went round in vague form. His tank had held fairly well, though still leaking, and efforts were made to lash and strap it more securely; at the same time men set to work on the right rear wheel, whose tire was gone. A number of extra tires were at hand, but none of the right weight, and men were sent to find a key to the storage barn and get others. Meanwhile the best of those at hand was put into place and inflated. By the time the work was completed the men returned with the right tires, but after a little discussion it was decided to make no further change. Both men were offered milk and brandy when they first stopped, but they barely took a sip, being too wrought up and interested to eat. After nearly 27 minutes' delay the car was timed and started anew.

By an odd coincidence Campbell, in No. 1, arrived at the control just ten seconds ahead of Gabriel in No. 2, but while the latter was on his fifth lap the former was on his third, or sixty miles behind.

CROKER ARRIVES IN BAD SHAPE.

At a little after 9 o'clock Croker came limping into view, stopping when past the bend for about twenty seconds, resuming, and then stopping some 60 yards short of the entering tape, starting up once more and stopping between the tapes. The car was in bad shape, the frame being bent and distorted, bolts broken off, and the machinery nearly touching the ground. The pressed steel frame had originally been perforated at close intervals with holes about four inches in diameter, but as it proved to be considerably over weight the same process was continued by drilling smaller holes, of about one inch in diameter, wherever space could be found for them. The result was that when the car first started all parts of the frame looked like a honeycomb, or more properly like a slice of Swiss cheese, the holes being of various sizes. The webs of metal between adjoining holes in the side members of the main frame were from 1-4 to 3-16 inch wide. Each side member was braced by a tie rod passing over two struts depending from the member, so that the central portion was well supported. This truss, however, ended at a point about under the after edge of the seat. The gasoline tank, holding thirty gallons, was placed on top of the frame and just abaft the seat, at the same time being well forward of the rear axle. By this arrangement the weights of the two men as well as that of the tank and fuel were centered neither over the rear axle nor over the center of the truss, but just at the after end of the latter. Here the frame was all cut away by the many perforations, and

the result on each successive round was very interesting. By this time, on the fourth round, the skeleton web of each side member was bulging outward just over the point of attachment of the rear end of the tie-rod, the frame was showing distortion at other points, the seat back was nearly gone, and some bolts were sheared. The brakes had ceased to work properly, and the car was unfit for further running. Mr. Croker sat at the wheel during the short interval of stopping, stern and imperturbable as a statue, apparently unconscious alike of the condition of his car and the cheers of some of his friends by the roadside. He ran through the control, and after the outbound timing stopped for about five minutes for repairs.

HEATH'S ARTISTIC WORK.

Heath made his sixth entry at 9:31; an artistic slow-down, a quick stop, a moment's relaxation of the limbs, and then away instantly, the whole maneuver being machine-like in its repetition in each round. His face was serious and sober, and never lighted by a smile. Only four minutes later, but sixty miles astern, came Tarte, jovial and smiling, pulling up well, touching his rear right tire with his hand to feel its temperature, and then dashing on. He was the exception in the list of the older riders, being the most animated of them.

By this time the strain of the long work was beginning to tell, and the shadow of the accident to No. 5, though vague and mistlike, had begun to settle on the faces. While some at the start wore an everyday expression, the majority even then were tense and hard as though engaged in a very serious task. Even when lightened by the temporary relaxation of the stop and the slow run through the controls, they were severe, solemn, stolid, saturnine, serious, statue-like. All through the morning they had refused food and drink, and their conversation had been restricted to the fewest possible words.

There were a few exceptions, Tarte already mentioned; Webb, who was busy and bustling under his troubles, and his mate Lyttle, but most of them seemed to be moving in a world apart from that of the idle spectators around them. In almost every case the mental attitude of the mechanic was different from that of his driver; while the latter seldom stepped from the car or even moved in his seat, there was often something to cause the former to alight, or if not he took advantage of the chance to stand up or move his position. As a class, the mechanics took life less seriously than their drivers, displaying more animation of feature. They seldom asked for food or drink, but frequently accepted either where the driver merely declined by a gesture. To all appearances every mechanic in the race was animated by the same spirit as his driver, doing his utmost to help his car without waiting for orders or instructions.

SCALE MAP OF THE WILLIAM K. VANDERBILT, JR., CUP RACE COURSE IN NEW YORK CITY AND NASSAU COUNTY, LONG ISLAND.



Red banner right hand side of road 100 yards from turn to the right.

White banner straight ahead intersection.

Red banner for right turn near corner.

Beginning and end of controls.

Green banner 100 yards from R.R. crossing.

All the turns are right turns.

Complete Distance of Course, 30.24 Miles.

Length of Hicksville Control, .40 miles. Length of Hempstead Control, 1.40 miles.

Distance from New York City Hall to Village of Queens, 14 Miles.

Contours are Fine Curved Lines with Figures Showing Elevation Above Mean Sea Level.

Flag and Control Signs are Those Used on the A. A. A. Official Map.

Arrows Along Course Show Direction of Race.

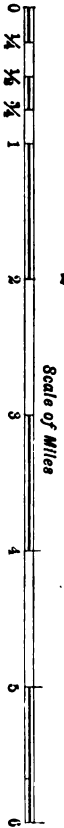

LITTLE TALK DURING STOPS.

While there was very little conversation during the brief stops, even with those cars which made little noise, the terrible roar from under the great square bonnets of the Panhard's made it difficult to catch the few words that were said by Heath and Tarte.

According to the original plan, the ticket timed and signed at the in-station of a control was to be carried by the pilot to the timer at the out-station, who would mark time and sign it and then deposit it in the copper box on the side of the car. Owing to the failure of the pilot system in Hempstead, it was necessary to give the ticket to one of the crew, the mechanic usually taking it. This created some misunderstanding, and in some cases the mechanic took the ticket from the timer, passed it to the driver, and the latter impatiently labored to slip it into the box on his right hand before starting from the entering station.

Clement came up at 9:39 on his fifth round, stopping and starting without loss of time; a minute later Lyttle pulled in, asking for gasoline on his next stop and accepting a drink of milk and brandy. Next came Schmidt, approaching the tapes very slowly, then Gabriel, dashing up, stopping for an instant and starting away. Luttgen was obliged to stop a half mile east of the control to repair a leaky gasoline pipe, losing a few minutes; after him came Webb, running through to the far end and there losing nearly half an hour with tire repairs. Campbell came next, then Clement whirled in, making up time lost on the last part of the fifth round. Sartori made his second and last appearance a few minutes later, rushing through the town only to stop midway of the control with a disabled clutch, the car lying there dead for some hours.

Though about sixty miles astern of Heath and half that distance astern of Clement, Tarte passed along steadily at 10:24, having lost time on this round by fixing a tire after previously leaving the control. Lyttle came next, making a short stop and taking a light drink of milk and brandy when it was offered.

PANHARD MEN EAT.

The Panhard men were constantly on the lookout for their cars, and stood between the tapes with a bag containing four or five raw eggs, a bottle of Poland water and a bottle of bouillon. There was little demand for refreshment, however, until on Heath's arrival at 10:28 he took a drink of water and his mechanic accepted the bag of eggs. When half a mile east of the control Heath had overtaken Croker, the latter looking around and in doing so drawing to the wrong side of the road. This gave Heath very little room, but he got by safely with a few inches to spare.

When Croker came in at 10:29 the frame was still more bent than on the previous

round, one of the iron straps holding the tank was broken at the fore end, and the tank was loose and leaking. The car ran over the tape and was pushed back for repairs, wooden plugs being driven in the holes in the tank and wooden wedges under the loose straps. The starting crank was still without a pin, so that starting was a difficult matter, the sleeve being hammered into place and then slipping back. Eight minutes were lost in repairs before the car was timed, and then she lost a minute and one half by stopping again when fairly inside the inner tape.

Schmidt, Luttgen, Campbell and Clement passed between 10:30 and 11, all apparently running well. Just at 11 o'clock Tarte came up, both he and his helper taking a drink of bouillon and carrying with them a bag of eggs. Four minutes later Heath came up, declining the proffered bouillon and Poland water, though his mechanic accepted the eggs.

REPORTS OF KILLED AND WOUNDED.

Whatever doubt remained of the truth of the report first brought by Webb was dispelled by the brief words of following drivers, though the details were as yet unknown. Wild rumors now began to float through the crowds at each end of the control. It was said that Arents was dead, while his mechanic had been thrown against a wire and decapitated, Sartori had both legs taken off near Hicksville, Wallace had nearly killed his mechanic, a boy and two men had been killed by a passing car, and Bernin had run into a telegraph pole and was badly injured while Tracy was also among the wounded. While all of these reports lacked confirmation they served to excite the crowd.

When Lyttle came in on his seventh turn there was a wild rush of his friends. He stopped short of the tape at the side of the road and took in gasoline and water at the same time, while his tires were wet down and his mechanic had a drink of milk. Stopping for thirty seconds between the tapes, at 11:13 he hurried on.

When Schmidt came up a little later his brakes were working badly and he ran by, backing and stopping to fix them. While his mechanic was busy Schmidt stepped out of the car and lit a cigar, though he was under way again before it was fairly drawing. Luttgen and Clement followed, the latter's mechanic lifting the side of the hood and setting up a plug as the car stopped. Then came Campbell and Tarte. As the latter ran out of the other end of the control he stopped to fix a split pin and to look over the brake.

CROKER MINUS A TIRE.

At 11:58 Croker came in on his sixth round with his car a wreck; the tire was gone from the rear left wheel, the frame had dropped a couple of inches further during the round; and the webs between the holes, that had been merely bent before, were now in many cases broken short off.

Hardly waiting for the timer, he asked impatiently for his card, and rushed on through the town.

When Heath pulled in on his ninth round at 12:12 his face wore the same serious look; he declined all food, though his mechanic took a drink of water, and after a very brief stop he hurried on.

Luttgen came next, then Schmidt, and then Clement on his ninth round just ahead of Campbell on his seventh. Clement's face betrayed no more emotion than in the first round, though he had good hopes now of winning the cup, it was as grave and solemn as an old man's charged with years of care and responsibility.

Heath entered Hempstead at 12:47 for the last time, after leaving the control he stopped for about thirty seconds, then started again and a turn of the road hid him from view. Clement followed through the town almost 11 minutes later, driving solemnly and steadily as ever. When Tarte went through on his ninth round he looked up and waved his hand cheerily in answer to a salute from a stranger.

LYTTLE'S GOOD LITTLE CAR.

The passing of Campbell was hardly a matter of interest now, but Lyttle, who followed him, had fairly won third place by his clever handling of a good little car. Though only on his sixth lap, his mate, Webb, held on pluckily after him. The last trip of the Croker car was painful to see, as it was literally a moving wreck. Luttgen on his seventh round and Schmidt on his eighth passed for the last time a little before 2 o'clock.

It was a certainty that the race was over, but no one in Hempstead knew whether Heath or Clement had won. The Panhard car that had laid at the in-station all day had started east some time before, and at 2 o'clock it came back at a good speed with the French flag and the Panhard banner flying. A little later the Panhard repair car followed, the three mechanics waving their hands in glee, and it was taken for granted that Heath had won.

TRAFFIC CROWDS THE COURSE.

All through the morning the course was practically free from traffic; a few cars and horse vehicles passed, but the racers had the road to themselves. About noon the passing became more frequent, and by 1 o'clock there were a number of cars and carriages out. By 2 o'clock vehicles of all kinds began to crowd the road and all chances of speeding were over. Through the town the streets were not crowded, there being nothing to compare with the public turnout on the occasion of a big endurance run. There was no trouble with the crossings, even with the important one where the trolley runs; nor, to all appearances, were the citizens seriously inconvenienced in their daily life.

At the outgoing station there did not seem to be always strict adherence to the rules. Some of the cars passed the length

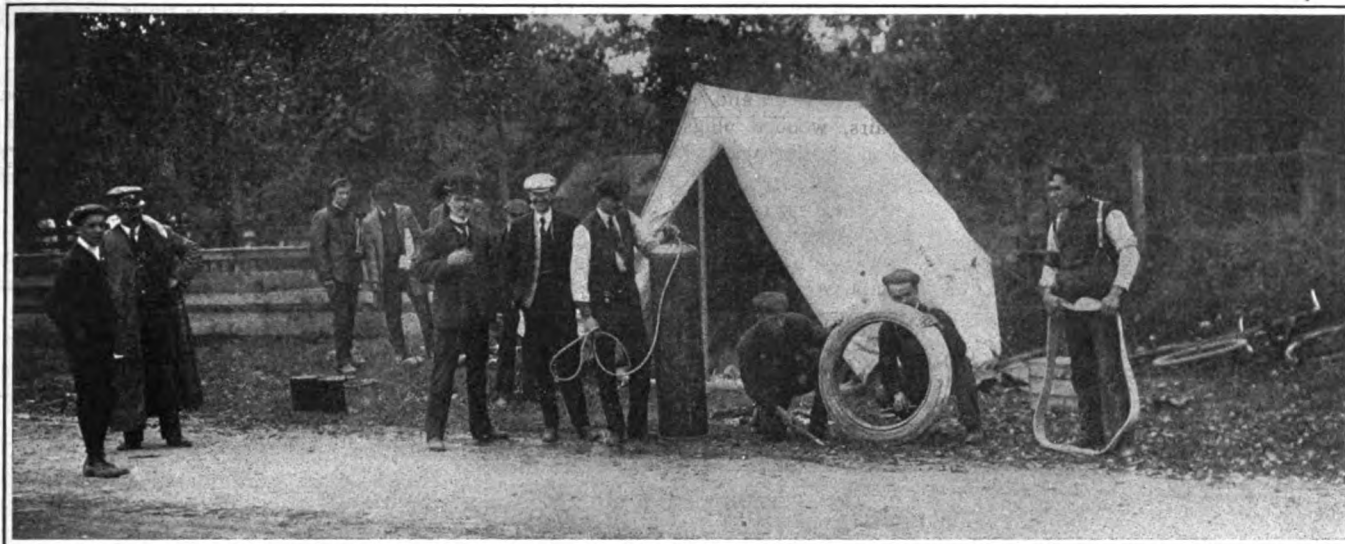

AT ONE OF THE MICHELIN TIRE CAMPS—EXPERTS READY WITH INNER TUBE, SHOE AND COMPRESSED AIR TANK.



GASOLINE PUMP, AIR FLASK AND WATER FILLING FUNNEL AT THE CONTINENTAL TIRE DEPOT IN HEMPSTEAD.



LUTTGEN CHANGING GOGGLES AT THE HEMPSTEAD CONTROL WHILE HIS MECHANICIAN TAKES A CUP OF COFFEE.



POURING WATER ON THE TIRES OF WEBB'S 60-H.P. POPE-TOLEDO TO COOL OFF OUTSIDE HEMPSTEAD CONTROL.

of a wheel beyond the tape, and some as much as three-quarters of their entire length and were allowed to remain in that position before being started.

The enthusiasm of the spectators carried them away, and in the earlier hours when the cars were about to get away some of the bystanders helped to push them off. This was vigorously protested by two or three men at the control. Warning was given to the crowd, and thereafter only newcomers attempted to handle the cars. None of the fastest machines, especially those handled by the foreign drivers, went beyond the tape. It was quite noticeable that car No. 7, with Heath at the wheel, always remained from one to two feet within the tape. Clement in No. 12 invariably made a neat stop within about four inches of the line. In several instances mechanics were permitted to cross the tape before the car was officially started and procure lubricating oil and return with it to the car to replenish the oil tanks.

Gasoline and water were invariably taken on the machines outside of the control. At the Continental tire depot a very simple and ingenious arrangement for supplying water was used. A large funnel with a big opening, in which was fitted a

wooden plug with a wire attached extending out over the top of the funnel, was filled with water and raised by three men over the tank opening. The plug was withdrawn, and the water speedily rushed out and filled the radiator.

It was quite noticeable after about the sixth round that the drivers were under great tension, as they did not seem to know how many times they had gone around, and almost always asked the starter how many laps they had yet to make. In the first two rounds it was observed that the drivers were very anxious to locate the starter, as his badge did not seem to make him so conspicuous that they could easily distinguish him from the other persons who crowded around the car. After the third round or so the drivers appeared to get accustomed to the situation and evidently know the appearance of the man who deposited the time card in the boxes they carried. In the earlier hours of the race the timer had entirely too much to do, as he not only had to note the passage of the cars, but had to attend to the telephone, and he finally pressed into service one of the pilots, who thereafter attended to the telephone calls. This left the timer to do his own work and there was no hitch.

did their work well, but the red danger flags were almost never required. The white flags were large and very distinct, and the men who used them were alert and attending to business right along. Almost as soon as a car came in sight there would be a responsive flutter of white specks along the road, denoting a clear passage, which must have been of great assistance to the racers in making speed.

The telephones connecting the timers with the judges' stand were two in number, one being at each end of the control, and were placed in white boxes secured to telegraph poles. Neither of the Hicksville instruments was very close to the control boundaries, and it was necessary to keep a man on duty near the telephone to listen for the bell. The telephone at the control entrance was but little used, but the other was kept hot, though it was notable that very little information as to the progress of the race outside of Hicksville came over the wires, the people receiving the news, for the most part, as it came from the racers themselves—generally misinformation.

IN THE VILLAGE STREET.

The control south of the railroad crossing ran through a typical village street, overshadowed by fine trees and lined with the curious aggregation of residences and village stores usually seen in small places, some of which showed visible evidence of the influence of the neighboring big city in their plate glass and smart paint. A church faced the road just at the exit, seeming strangely out of place when the racers commenced to thunder past. The last of the village shade trees marked the spot where the cars started away, and at a little distance it was quite a sight to watch the machines emerge from the gloom, and, gathering speed with every turn of the wheels, dash into the sunlight and whiz down the chocolate-colored turnpike.

Just beyond the control the Continental tire repair station was located, and the arrival of one of the Mercedes cars was invariably the signal for a regular football rush of yellow-jerseyed men, who would run alongside the cars as they covered the last few yards in control, ascertain the wants of the drivers, rush back to the station and get whatever was wanted and then tear back, only to stand, with toes on the line, leaning forward like a lot of hackmen, not daring to cross the "dead-line" with supplies in their hands. The drivers rarely cut down their leaving speed to take supplies, and there were many missed sandwiches, oil cans and other supplies for men and machines. It recalled a Gymkhana event to see these same yellow fellows try to make speed through the crowds with glasses of milk in their hands; but it was surprising to see the amount of milk left when the rush was over.

NIGHT BEFORE THE RACE.

Most of the night before the race the

At Hicksville on the Base of the Triangle.

THE Hicksville control is somewhat peculiarly situated, inasmuch as it commences and ends, not in the open country, but right in the main street of the village. The entrance, at the north end, is almost clear of the built-up portion of the place, only a few hundred yards separating the control line from open country; but the end of the control is almost in the heart of the village, and the more powerful cars were able to attain a speed of 50 or 60 miles an hour before they were clear of the houses. Had any of them swerved from the road there would surely have been someone run down, for the sidewalks and paths were filled with a continuous procession of spectators going out to see the cars at speed, coming in to see them at the control or standing to watch them pass by.

The control was cut in two almost equal parts by the main line of the Long Island Railroad, which crosses the street at right angles. The crossing, which is at grade, is guarded by gates, and it was expected that more or less trouble would be experienced by the racers from delays while waiting for trains to pass. Nothing of the sort occurred, however; for, though the gates were closed two or three times while machines were passing through, the delay was so slight that it simply curtailed somewhat the wait at the control exit. There is a fork leading off to the right just before entering the control at the north, but the sharp definition of the course secured by oiling, together with the signs and banners along the way, made it impossible, even for a casual observer, to mistake the route.

SPECTATORS AT HICKSVILLE.

The number of spectators at Hicksville, though considerable, was not as great as was expected, and but few came in automobiles. Perhaps there were ten or a dozen machines in the control altogether—not more—and these stood lined up in the side roads at the control entrance and exit, the majority being at the north end, or entrance. Quite a number of spectators came on every train, but they soon spread over the course, the majority seeming to be bent on reaching the Jericho turn, so that Hicksville was comparatively quiet most of the time. The merchants whose business it was to look to the refreshment of the inner man were kept busy, the bakeries in particular being practically cleaned out and the saloons dispensing quantities of refreshments to the thirsty people; but it was an impossibility to get a cup of coffee at any of the hotels, except at meal time—a great mistake, as many would have been glad of a chance for a hot drink after a long period of inaction in the sharp air.

AMBULANCE IN ATTENDANCE.

On a little road leading off to the right of the control, just at the entrance, was a black-covered vehicle with a red cross painted on it. It was an ambulance, and the doctor who was in charge stood at the tape, near the timer, with a white brassard on his arm, bearing the same red emblem. He was a cheerful young man, and seemed to forget the gruesome errand on which he had been sent in watching the races.

The flagmen stationed at the cross roads

pitchy darkness was pierced by the lights from the lanterns and camp-fires of the tire men, who sat up all night and watched their precious heaps of rubber and bottles of wind. Long before the first streak of daylight they were hammering and sawing, getting their stations ready for the first arrival, and were ready even before the first small boy appeared on the scene. The next arrivals were the judges, who laid out the tapes, pegging them down to the roadway at the spots already marked out by stakes. This done, and a preliminary call over the telephone from the judges' stand, asking if all was ready, answered in the affirmative, and there was nothing to do but await the coming of the machines.

THE SMALL BOY APPEARS.

Almost before it was light the small boys, who invariably turn up before anyone else, began to gather at the beginning of the control, chilly but cheerful. It was still dusky when the bicycle pilots commenced to arrive, and the sun had not risen when the Chronograph Club timer, a tall man with an up-early expression of countenance, came at the tapes, which, 25 feet apart, marked the first stopping place of the racers. Then more small boys, more bicyclists, a few automobile enthusiasts and an occasional contemptuous but good-humored farmer appeared. Altogether there were probably 100 persons about the spot when the timer took out his watch, a few minutes before 6 o'clock, and began to look expectant.

At 6:05 all eyes were fixed on a turn in the road, less than half a mile distant, where the cars would first appear. Suddenly a dozen voices cried: "There she comes," and with a hum that almost instantly developed into a rattle Mercedes No. 1, Campbell driving, approached and made an easy stop between the tapes, the driver looking straight ahead; the timer made an entry on a card, handed it to a bicycle pilot, and signalled the driver to go ahead. The Mercedes moved off with a jerk, but seemed to have no difficulty in keeping well behind the pacemaker, who, on arriving at the other end of the control, handed the card to the timer there. That official noted the time indicated and held the car until the three minutes in the control had elapsed, slipping the card into the record box just before giving the signal to go. This was the method adopted in every case, and it worked well, as far as the Hicksville control was concerned. There was no lack of pilots, even when two or three cars entered at the same time.

DE DIETRICH RUSHES IN.

Before the Mercedes was well clear of the control entrance another roar announced the approach of the second car, and No. 2, the big De Dietrich, came down the road, going faster than the first car, but taking considerable time in making the stop. The big 80-horsepower motor seemed to make a good deal more fuss in keeping down to control speed than did the Mercedes. Then

there was a wait of about three minutes before the Royal Tourist, its 30-horsepower exhausting like a big motor, came in, Tracy looking cool and comfortable.

The first bit of excitement was furnished by the next arrival, the 60-horsepower Pope-Toledo driven by Webb. Just over the line the motor stopped, and the mechanic got out and "tickled" the carbureter. He was just starting for the crank when gasoline running from the carbureter became ignited, and in a second there was a merry blaze under the hood. For a moment things looked serious; but fortunately little gasoline had escaped, and the mechanic beat out the flames with his gloved hands. Webb sat all this time quite unmoved, only speaking once to caution the mechanic not to burn himself. The whole affair was over in less than two minutes, and the machine proceeded through the control uninjured. Arent's Mercedes and the 24-horsepower Pope-Toledo came next, seemingly in about the same relative positions as when they started, the little American car going at a surprising pace and making a sharp stop.

HEATH MAKES A GOOD ENTRY.

Hardly had the spectators time to remember that the great Heath was next on the list when the thunderous roar of the 90-horsepower Panhard was heard, and the car came tearing around the curve and down the road, evidently traveling faster than any of the preceding machines. Heath made a careful stop, however, and was very cool. His motor made a tremendous racket, and the car was with difficulty kept behind the bicycle pilot. As Heath stopped, a young woman in brown wearing on her arm a brassard marked "Panhard" rushed up to him, seized his hand and expressed in warm terms her hope that he would win. She remained at the control throughout the day, chatting for a few seconds with the great driver every time he came through. A few other ladies who had come in automobiles occupied chairs placed by the roadside, and were faithful to the end.

Hawley, in E. R. Thomas's 60-horsepower Mercedes, came next, going very fast, though not at Heath's pace. Werner, who came next in the 90-horsepower Mercedes, seemed somewhat excited. He slowed up considerably at quite a distance from the control and then speeded up again so that, though he made a violent stop, he overran the inner tape by a couple of yards and had to reverse.

The first of the Fiats, with Sartori up, was due next, and when two minutes passed without its appearing the spectators began to express surprise, as great speed had been expected from the Italians. But the Fiat did not come, and four minutes later No. 11 went through with a very brief stop. The Renault ran well, but slowed up a good deal on approaching the control. The next arrival was the Clement-Bayard, driven by the "Baby Driver," and going like a whirlwind. The big blue car made a decided sensation as it drew up.

Clement wore a tan-colored coat and a heavy leather football helmet, looking very business-like and clean—the latter feature, however, entirely disappearing later. Clement seemed rather excited and nervous, and the stop seemed to worry him. Tart, in Panhard No. 14, came up fast, and stopped with the rear wheels locked. Teste, in Panhard No. 15, came up faster and braked more violently, sliding almost the entire 25 feet between the tapes.

THE "GRAY WOLF" APPEARS.

There was rather a long wait—about four minutes—before the Packard *Gray Wolf*, driven by Schmidt, came around the curve and stopped short of the first tape, losing several seconds in getting over. Schmidt brought in the first news of Sartori, reporting that the Fiat had broken a shaft somewhere. The little Packard looked ridiculously small, coming as it did just after the enormous Panhards.

The S. & M. Simplex, owned and driven by Frank Croker, dashed up just as Schmidt was pulling away. Croker was fairly flying, and overran the inner tape a good 100 yards, but lost no time in reversing, handling his car with evident skill. He was one of the coolest of the drivers. The last Mercedes, No. 18, was some time in making its appearance, and when it did round the curve began slowing up a long way from the line, Luttgen, the driver, seeming slightly flustered.

WALLACE HAS A MISHAP.

The last car on the list of starters was No. 19, Wallace's 90-horsepower Fiat, and when, after some delay, it came tearing down the road, it was seen to swerve to the right. The crowd scattered in a twinkling, and barely in time, for Wallace shot over the line and ripped into the control at 60 miles an hour. In the brief instant occupied in passing the line it was seen that something was wrong, and that the driver was trying to do something—no one could make out what. The car kept to the right, scraped the curb for a hundred yards, and disappeared in the direction of the control exit. As it went out of sight, however, the motor was heard to stop. A bicycle rider came back in a few minutes with the report that Wallace had been unable to stop his car owing to something being stuck. If afterwards proved that this was the case, the clutch having become jammed so that it could not be thrown out, and, apparently, he did not cut off the ignition.

Gabriel came in with the big De Dietrich before the excitement over Wallace's spectacular flight had subsided, his car running smoothly and at great speed. He had passed No. 1, Mercedes, which came in a couple of minutes later, reporting that a man had been run over by a car at Jericho.

This report was later followed by a story that Wallace had run over his mechanic at that point and killed him, which seemed strange, as he certainly had a mechanician when he flew through the control.

WEBB AND THE POPE-TOLEDO.

The 60-horsepower Pope-Toledo followed the Mercedes after several minutes, Webb a little excited. His motor stopped just as he was pulling away from the tape, but was started again almost instantly. Another interval, during which the spectators began to forget that they were cold in the excitement of speculating as to who should be next around the turn. It was Heath, who came up, apparently faster than any previous car, and made a magnificent stop. His good judgment was shown in the fact that though the braking was of the most strenuous sort, there was but little sliding of the wheels, the great car coming to a standstill midway between the two tapes with every portion of its anatomy quivering with the shock of suddenly arrested motion. This was the best stop made, even by Heath himself, at the Hicksville control.

When Hawley came in two minutes later with the Thomas Mercedes, No. 8, his mechanic made a grandstand play by standing on the ground while the car was stopped, and, after it started and gained some speed, making a flying leap into his seat. This made the spectators hold their breath for a second. It was a risky thing to do. The 24-horsepower Pope-Toledo, No. 6, came in, running finely, and reported three cars broken down, but could not say where or what cars.

This apparent lack of knowledge of location was curiously apparent in many cases. A driver would come in and report a car broken down somewhere, but would be utterly unable to say where.

THREE CARS ARRIVE TOGETHER.

Clement, No. 12, and Teste, No. 15, with the 90-horsepower Mercedes, came in almost together, the blue Clement-Bayard leading slightly, and for the first time there were three cars standing at the entrance together. What with the deafening exhausts, the necessity for quick action and the difficulty of getting around among the people, those whose work commenced upon the arrival of a car were for a moment badly confused, but things were soon straightened out, and the three machines went noisily up the street in single file, headed by their pilots, who kept diligently "rubbering" at their gigantic charges. Clement's motor stopped for an instant as he was leaving the control entrance, but the first turn of the crank set it thundering again.

RED RENAULT IN TROUBLE.

The red Renault came in looking very white around the gills, for steam was escaping, with a hiss that could be heard even through the roar of the exhaust, from a dozen places in the circular radiator. The whole machine seemed sizzling hot. It was a positive relief to look at the next car to arrive, Mercedes No. 9, Werner so cool as to seem almost apathetic. Then Croker came around again in his Simplex, making great speed, and, as he shoved up his gog-

gles, showing a jolly face that wore an expression of real enjoyment.

In reply to the query: "How is it going, Mr. Croker?" he laughed and said: "Fine! Fine! Having an elegant time." And away he went. Arents's Mercedes, No. 5, came in after Croker, running rather slowly, it seemed. Arents reported that he had lost a tire at Hempstead, and when a new one was put on it promptly blew out. Fortunately the next one held up. The radiator of this car was leaking pretty badly, and while still in the control the mechanic commenced plugging the leaks with sharpened matches. Upon being informed that this was contrary to the rules he waited until the word was given, and, pushing the car out of the control, finished the plugging in haste. As the car got under way an object was seen to drop out, and a spectator picked up a pair of goggles thought to belong to Mr. Arents. This was the last time the unfortunate machine was seen in Hicksville.

GABRIEL IN A PLEASANT MOOD.

Gabriel came through with a broad grin, evidently feeling good, and went away with a wave of his arm as his white car dwindled into a speck down the road. Schmidt brought in the *Gray Wolf* running like a clock. Trouble had been experienced at Mineola, where four minutes was lost from battery defects. The 60-horsepower Pope-Toledo came in with a front tire gone, the Jericho turn having been too much for it. The run to Hicksville had been made on the rim, which was in bad shape, causing a loss of 28 minutes in getting a new tire in place.

Teste went through with his Panhard without incident, soon followed by Clement, whose face, where not covered by his mask, was exactly the same color as the oiled road. He explained this by relating the struggle it had cost him to pass the 60-horsepower Pope-Toledo. It had been a long pull, and Clement had taken showers of road material thrown up by Webb's wheels. The oily stuff stuck to everything it could reach, and Clement's face was fairly plastered. Mercedes No. 18 reported a tire lost at Jericho.

Lyttle and Tart passed through, and Croker followed, his face now wearing a more sober look. His frame was bending, the most evident distortion being just forward of the rear axle. The cross members in the rear were also bending. Croker reported losing a spare chain on the road. He shot away after Tart, who just preceded him through the control, and seemed to be overhauling the Frenchman when they disappeared. No. 2, the De Dietrich, came through and got away almost on even terms with Mercedes No. 18, which had been delayed at Hicksville having a tire put on, and the two raced away almost together.

HEATH MAKES SPLENDID START.

Heath, the next arrival, gave a fine exhibition of picking up speed on leaving the

control, going through his gears like a flash and jumping into speed with less delay, apparently, than any other competitor. Hawley's Mercedes stopped 14 seconds just beyond Hicksville for oil. Teste came next. His motor stopped just after leaving the control, and his mechanic got out and started it. Before he could get into the car it stopped again, but after starting a second time the car got away without further trouble.

Schmidt went by in his usual clockwork manner, and shortly after the belated Sartori, with A. G. Vanderbilt's Fiat, appeared on the scene, looking much worried, though his car seemed to be running well. It was impossible to make out from what he said where he had been all the time, but he made it clear that something had been wrong with his car.

Campbell, Gabriel and Lyttle followed each other through the control, and then Croker came around again, more worried and his frame more bent than before. The left side of the frame was bent worse than the right, and the whole car seemed to have sagged greatly.

CLEMENT PROTESTS VIGOROUSLY.

Clement came to the end of the control and caused a little excitement. As his car approached there was a hissing noise, and the mechanic, jumping out as the car stopped, found a relief cock had jarred open. He proceeded, while the car was standing in the control waiting for the expiration of the three minutes, to wire it up, and had just finished and closed the hood when the judge objected, saying that any work on the car done in controls would lay the driver open to disqualification. Clement protested vigorously that he was within his rights in doing this, and he, his mechanic, the judge and the timer engaged in a warm argument. As the work had been finished, however, and Clement's time had elapsed while the dispute was in progress, the car was sent off, the officials not knowing what else to do. Clement slammed in his clutch and tore off in an angry mood, leaving the judge and timer in doubt as to whether they were right or wrong. There seemed to be no certainty as to just what the rules were in this respect, and Clement's positive statements that he had a right to make repairs in controls—that Mr. Vanderbilt had told him he could do so—made them waver in giving their decision.

REPAIRS TO WALLACE'S FIAT.

Just at this time Wallace's Fiat was pushed out of the control, and, men having arrived with tools, an attempt was made to repair the damage, Wallace declaring that though he knew he had no chance, he would get into the race again if it could be managed. The spring of his clutch had broken and after getting the clutch in it could not be disengaged. Referring to the report that his car had run over the mechanic, Wallace said it was true. They had stopped at Jericho, having had clutch trouble there,

INTERESTING INCIDENTS AT THE GRAND STAND, IN QUEENS, AT HEMPSTEAD, AND ON BETHPAGE ROAD.

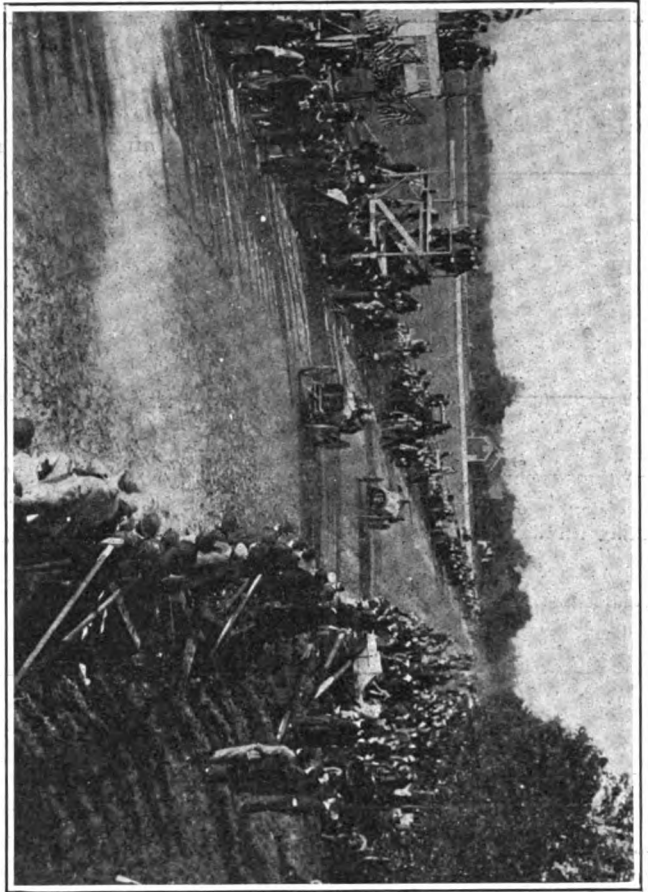

Albert Clement Overhauling Frank Croker as the Cars Approached the Grand Stand.

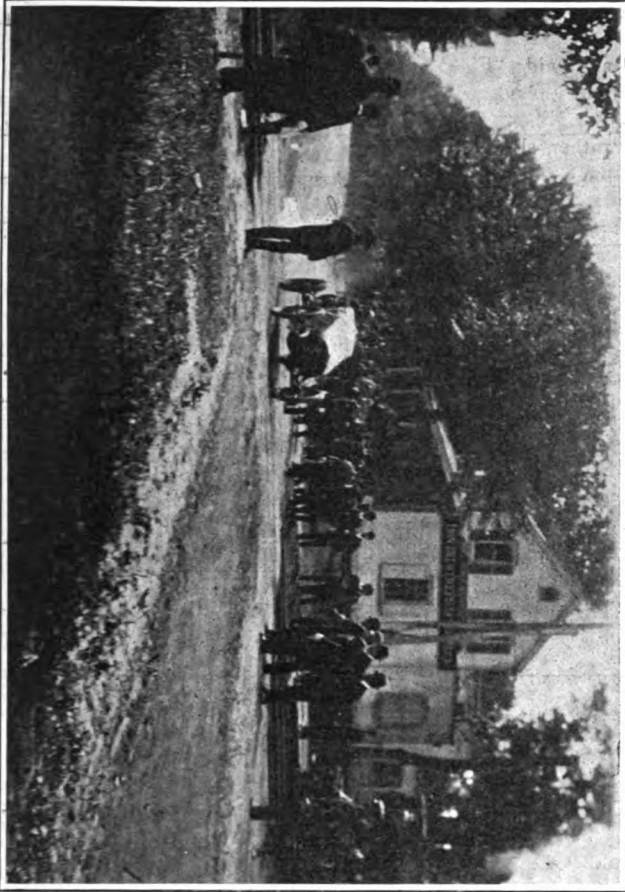

Albert Clement Crossing the Railroad Tracks at Queens.—Note Train Waiting on Right.

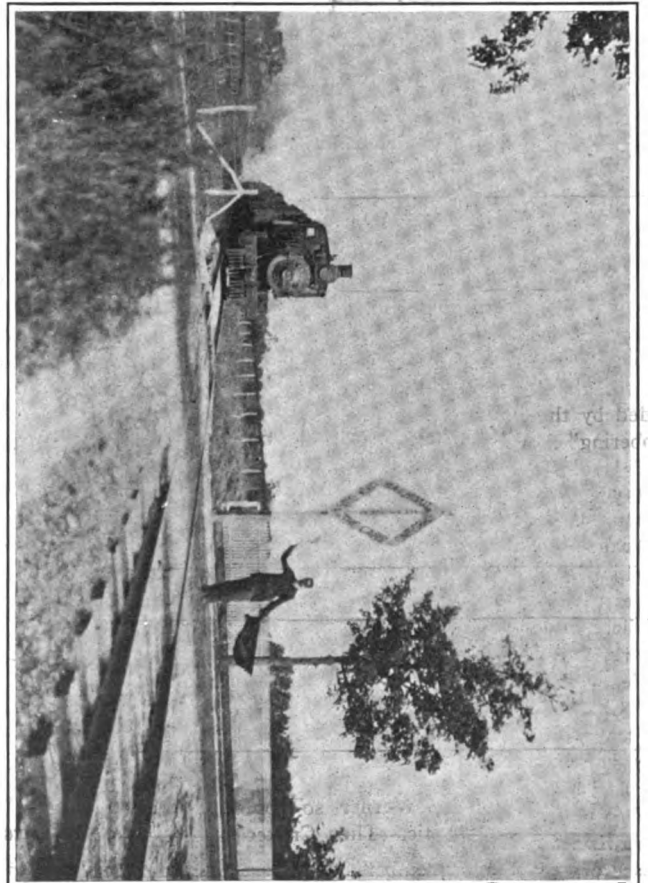

Plagman Signaling Train at the Grade Crossing Near Outgoing Station in Hempstead Control.

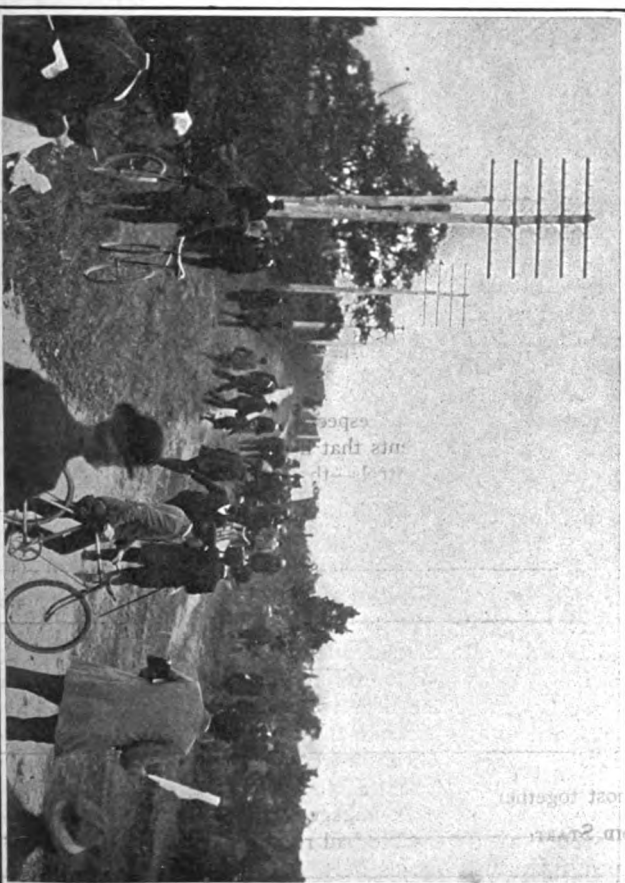

Spectators Rushing Out On Bethpage Road When No. 18 Stopped to Fix a Tire.

and in making a jump for the car when starting the man, Antonio Donderi, missed his hold and fell, the rear wheel passing over him. "I felt the jolt," said Wallace, "but I knew I could do nothing for him, and that those at the tire tent, who had seen him fall, would care for him; so I called another man who jumped on, and we came right through. When I tried to throw out the clutch on approaching the Hicksville control all my strength failed to budge it, and I could only stop by throwing my switch." All sorts of rumors came in concerning the man, but all were set at rest when he walked in with a bag of tools, the only apparent damage done being the tearing off of the heel of one of his shoes. After an hour's work on the car it was found that nothing could be done. "Worse than I thought," said Wallace. "Can't do anything till we get into a machine shop."

TRACY'S LAST APPEARANCE.

Webb came in with his gasoline tank leaking badly. Then Tart, Lyttle, Luttgen and Heath, the latter going like the wind and seeming as good as when he first started. Tracy at last appeared. "Where have you been, Joe?" "Broke a shaft," replied Tracy, grinning. "Found a blacksmith shop and turned another and came on." He looked so pleased at his job that the crowd grinned with him, though few had any idea of the feat he had accomplished and told of in a few off-hand words. Tracy's gasoline tank was damaged, but he pushed on, closely followed by Campbell and Gabriel, who soon overtook him. Croker re-appeared, his worried look somewhat deepened, his frame all out of shape and the transmission box dangerously near the ground. He reported that No. 5, Arents's Mercedes, had run into a telegraph pole, and that Arents and his mechanic had been taken away in an ambulance. A few minutes later a report came in from the grandstand, it was said, that both were instantly killed.

SARTORI IS DISQUALIFIED.

While this disquieting news was being discussed by the crowd Sartori again came into the control. He was promptly met by the judge, who told him he was disqualified. Sartori's knowledge of English was not sufficient to enable him to understand any such statement, and it was not until an interpreter had been hunted up that he could be induced to understand. When the full significance of the sentence had dawned upon him he was the most miserable, woe-begone man in Hicksville.

Wallace came up while the interpreter was at work, and on being informed what the trouble was, went to the telephone and asked Chairman Pardington for details. It then transpired that Sartori had made a flying start instead of a standing one, as prescribed by the rules, and that the officials had been unable to catch him sooner. After a somewhat heated argument, during which Wallace protested, as a member of the race commission, against Sartori's disqualifica-

tion without a chance to defend himself, Sartori finally had to give in, a sad, sad man. The car was found out of business, however, from clutch trouble, and though Mr. Vanderbilt later telephoned authority for Sartori to continue, he was unable to do so, and started working on the crippled car, just across the road from the other Fiat.

While the excitement over Sartori was at its height Heath came in, running as usual, but losing a good deal of water. He went on without paying any attention to it. Tart and Luttgen came in, one right after the other, and when they disappeared Luttgen was maintaining his slight lead. The little Pope-Toledo went through, behaving well, and Clement followed shortly after, his car swerving around a good deal, and the exhaust throwing out a good deal of smoke.

GABRIEL DOWN AND OUT.

Campbell passed, and then the De Dietrich came in, almost red hot. The car was pushed over the tape, and the front of the bonnet, which was very loose and blistering hot, was removed. A pump connection was found broken. On hearing this Gabriel took off his rubber coat, disclosing the fact that his upper garments, aside from the outer coat, consisted of an undershirt and a folded newspaper tied across his chest, went forward and examined the damaged part, had some water put in and then, very quietly and methodically, began to put things in order, saying that it was of no use—they were out of it. The big white car was laid up just ahead of Wallace's Fiat.

The big Pope-Toledo passed again. Clement came around, going fast, complaining of a sore back from the constant jolting. His exhaust was now very smoky. Just after he got away Sartori managed to get off, having made a temporary repair, but he was not seen again at Hicksville. Badly crippled, Croker was the next arrival. His frame was now so buckled that the gear-box scraped the ground and his gasoline tank, pounded loose, was leaking freely. It looked hopeless, but Croker was game to the end, and said he would not stop until he had to. He sped off, his motor working beautifully, but his car leaving a triple track in the dust. Tart came in with the report that Heath had just passed the *Gray Wolf*.

WISHED HEATH GOOD LUCK.

The Panhard came in shortly, the leak in the water system having stopped. Some admirer wished Heath, now on his ninth round, good luck. To the surprise of everyone the usually cool driver appeared much annoyed. "No, no!" he exclaimed testily. "Don't wish me good luck. Don't wish me anything; it will be bad luck for me if you do." The admirer faded away with a meek "All right, I won't."

The *Gray Wolf* came in a little later, running as well as ever, Schmidt and his auburn-haired mechanic looking as if they liked the game. Clement's exhaust was sending out thick, choking clouds the

next time around, and the lad looked as if he was near his limit, but sent his car on with the same old dash and vigor. Campbell, Lyttle, with streaming gasoline tank, Tart, Heath on his last round, Luttgen, Schmidt, Webb and Croker all came and went, the latter in a hopeless plight, but game even with his car falling apart under him.

Then word came from the grand stand that, owing to the crowds there, the cars were to finish at Hicksville. Soon Heath came around after his last round; but it was not then known whether he or Clement had the best of it. Heath drove up a side road and stopped, and was at once surrounded by the crowd. He was quite indignant when it was suggested that he had met with fairly good luck in the matter of tires. "Not a bit of it," he said. "I had very bad luck. If I had not had tire trouble I would have been half an hour in the lead. As it is, I don't know where I am. In the eighth round they told me I was half an hour ahead and in the ninth that I was behind; and as I had eased up when I thought I was safe, I had to push my car to make up time, though I never let it out fully on account of the roads. The roads are horrible, horrible! Lucky I didn't get smashed up. I didn't mind the curves. They were nothing at all. But the controls are a nuisance. No more controls for me." Heath did not see any honor in taking second place. "If I thought I could not take first place I would rather stay at home," he said. "If I have won this race I have won a lot of money—for others."

After Heath stopped, Schmidt and Campbell went through in the usual way, and Lyttle passed without stopping. No more racing cars passed, and it was learned that they had all been called in on account of the crowds on the course.

WALLACE IS HELD UP.

While Wallace was sitting on his disabled car at Hicksville, a German woman came to him with a story to the effect that her son's bicycle had been damaged by the Fiat. Wallace went with her and examined the wheel, and gave the woman money enough to cover the repair expense twice over.

The crowds on the road at Hicksville were very much in the way, and it is little short of miraculous that some of the spectators were not injured. More than once the tires of the out-going cars actually scraped the shoes of the onlookers, as they grudgingly made a narrow lane for the passage of the racers. There were no police, regular or deputy, to handle them, and the race officials had their time fully occupied with their own troubles. The only deputy seen about Hicksville, as far as could be learned, was in a saloon, pretty well corned and soaking diligently. The flagmen at cross roads were much in evidence and did their work well.

A LIVELY NIGHT OF IT.

Sleep was almost out of the question at Hicksville the night before the race, for the road was constantly traveled by cars, mostly of high power, with open exhausts, which, combined with the tooting of horns that accompanied their progress through the village, made it impossible to get more than a few cat-naps. Early in the morning the same condition held, and the pedestrian had of necessity to keep his neck twisted to avoid being run down by one of the flying cars. Every one went as fast as he cared or dared. It was absolutely impossible to get a man to drive one over part of the course at any price, and the reason was very apparent after a short walk, with cars flying past every few minutes. Bicycles and motor bicycles were numerous, and

had many narrow escapes. The hotel men and merchants of Hicksville reported an unprecedented business, the former getting fancy prices for beds on billiard tables and the latter turning over large quantities of comestibles to the hungry sportsmen. Even a barber said he had never shaved so many men in one day as on that memorable Saturday.

It was very noticeable that no one seemed to consider the race in any way objectionable. The kickers, if any were in Hicksville, kept themselves out of sight. Even the farmers, who are supposed to consider automobiles the devil's special pets, seemed to enjoy the contest immensely, and in more than one instance were heard discussing the probability of the event being held again over the same course.

Seen at the Jericho Corner.

THE Jericho turn, up-grade and less than a right angle, was one that caused many to predict trouble, owing to its comparative nearness to the long level in front of the grand stand and the fact that the road was sandy at the curve. It was with the expectation of seeing several accidents here that many of the spectators assembled at Jericho early in the day and stuck to the spot throughout the race.

Just five minutes after 6 o'clock the first car came into sight, the big red Mercedes driven by Campbell. It rounded the turn beautifully, hugging the inside, the two inner wheels cutting into the sod on the edge of the gutter and securing so firm a hold that there was no skidding, although the big racing machine was going at nearly 20 miles an hour. One minute later the explosions of another car were heard in the distance, and in a few seconds the big white cigar-shaped craft of Gabriel, the favorite at this point, rounded the turn traveling faster and hugging the corner even closer than did the Mercedes, on which Gabriel had already gained nearly half a minute in the four miles separating the Jericho turn from the starting line at Westbury.

AN OVATION GIVEN GABRIEL.

From the ovation given the dare-devil Frenchman it was very plain that he was a hot favorite among the inhabitants of the neighborhood. The reason for this was that Gabriel and his big De Dietrich had been quartered at the Campbell road house in Jericho during the week he had been training for the contest, and in that time had so impressed the ruralites that they could not see how it would be possible for anyone else to win—an opinion that was strengthened greatly when the first car to pass the Jericho turn on the second lap was the De Dietrich with Gabriel at the wheel, he having passed Campbell and gained a minute and three-quarters start on him in the first thirty miles.

HAWLEY CAUSES EXCITEMENT.

Considerable excitement was caused when E. E. Hawley, driving E. R. Thomas's big Mercedes, made the turn—his number was eight. Hawley approached the turn at fully forty-five miles an hour and endeavored to keep his machine at a thirty-mile clip around the sharp bend. It could not be done, and he just saved his outfit from crashing into the telegraph pole at the further side by throwing on his brake and dragging both rear wheels. By the time he had got back into the road again he was just barely crawling and had to get up speed all over again for the two-mile stretch separating Jericho from the Hicksville control.

The failure of Vanderbilt's car, Fiat No. 10, to make its appearance on schedule time, and the fact that the next car, the French Renault, driven by Bernin, No. 11, came past the corner in tenth place, caused more than one score sheet to become so hopelessly muddled that it could not be straightened out all day.

FRANK CROKER DRIVING THE SIMPLEX.

When Frank Croker, driving the American Simplex, the dark horse in the race, rounded the turn at 6:35 o'clock, having gained nearly a minute on the car ahead, the crowd, which now numbered fully 150 persons, many of whom were women, cheered loudly, Croker and his mechanic answering with a wave of the hand. "If that machine does not go to pieces from being cut down to weight, Croker's chances to win are excellent," was the word that passed along the line.

Four minutes later No. 19, the F.I.A.T. driven by Wallace, came into sight and stopped just after rounding the turn, huge columns of smoke issuing from the exhaust. "The car is on fire," somebody shouted, and four-fifths of the spectators rushed down to where the racer had stopped. It was a case of too much oil in the cylinders, which caused such a smoke

that breathing in the car cockpit was difficult. A hasty adjustment of the oiling device was made, and Wallace, shouting: "All right; jump in!" let in his clutch. Antonio Donderi, the machinist, attempted to jump in, but went down and in under the car, the rear wheel of which passed over his left leg. The car was stopped, and Wallace hastily dismounted and hurried to the side of the injured man, while the crowd, now that a real accident had happened, crowded around thicker than ever. Donderi, though suffering considerable pain, was thoroughly game, and shouted to Wallace to go on without him.

GABRIEL'S SECOND LAP.

Just at this time Gabriel, having passed Campbell, rounded the turn a second time, and bore down on the crowd gathered around the F.I.A.T. and its injured mechanic at a speed of a mile a minute. There was a mad scampering to get out of the way, and in the meantime Wallace, leaving his mechanic, started his motor, and pulled out just in front of the De Dietrich, which passed him while still within sight of the Jericho spectators.

About this time attention was attracted to a tall, well-dressed spectator who sat on the rail fence inside the turn, and upon whom all eyes were turned. It was John Jacob Astor, who had quietly walked out to the Jericho corner to witness the race, incidentally mixing with the crowd and for a time remaining unrecognized in the excitement of watching the first round of machines pass by. Mr. Astor, noting the attention he was attracting, quietly continued his stroll down the road toward Westbury.

VANDERBILT BRINGS A PHYSICIAN.

Mr. Astor had hardly got out of sight when an unknown racing car was seen dashing up the road at a tremendous rate of speed, and carrying three persons. The car bore no number, and when it reached the turn, instead of rounding it as had the others, it turned to the left and ran up among the spectators and automobiles gathered there, causing a lively retreat on all sides. The strange car was admirably handled, and stopped within a few feet of the turn, where it was recognized as William K. Vanderbilt, Jr.'s, big Mercedes with Mr. Vanderbilt at the wheel. One of the other occupants, Dr. L. M. Lanehart, had the red cross of a physician on his sleeve, and was at once conducted to the wounded Italian who had been injured by being run over by the Wallace machine. A careful examination showed that beyond a few bruises the man was uninjured, after which the Vanderbilt car and its party sped back down the road toward Westbury.

Upon rounding the corner the third time, or just after completing his second lap, Frank Croker, hotly pursued by Albert Clement in the Clement-Bayard racer, took the corner at a frightful speed, the crafty Frenchman, after worrying Croker to make

the turn at an unreasonable speed, slowing down himself and taking it easy around the sharp bend. So fast did the less experienced American drive his Simplex that the skidding ripped off a rear tire, causing it to explode with a loud report. Clement went sailing past, while Croker pulled up in front of the Diamond tire camp, and spent seventeen precious minutes in putting on another tire.

CAMPBELL BURSTS A TIRE.

Campbell drove his Mercedes around the corner a few minutes later in a like manner and burst one of his tires. The Continental tire depot, however, was some miles down the road, and he had to proceed on a flat tire for a considerable distance. On the fifth lap Croker exploded another tire, and on this occasion it cost him fifteen minutes to make good.

About this time the most terrible reports reached Jericho, coming from all directions at the same time. One had it that both Arents and his mechanic were killed through running into a trolley car at the Jamaica plank road and that half a dozen people in the car had been fatally injured. Another report said that Gabriel, while traveling at ninety miles an hour, had struck a man at Hempstead and killed him instantly. The telephone operator frantically called up the grand stand, but no one there seemed to know, and the Frenchmen present, some of Gabriel's friends who were stationed at Jericho, were in a frenzy of excitement.

The crowd which had assembled at Jericho at daylight had been added to until by noon there were fully 400 at the turn, and then all commenced to realize that they were hungry about the same time. The hotel had sold out earlier in the day, nothing to eat being left in the house, and very little to drink. The grocery store was then appealed to, and for a while crackers and cheese were being devoured by over a hundred at a time; farm hands, millionaires, mechanics from the tire depots, newspapermen, and every-day on-lookers outbidding each other for the few remaining boxes of Unedas.

CRACKERS AND WORMS FOR LUNCHEON.

One laughable incident was brought to the attention of the writer. A country youth had invested in a box of graham crackers, and had cut off one end of the pasteboard box, out of which he was absent-mindedly drawing out cracker after cracker and devouring them while his eyes were glued alternately on the battered score card and the road leading from Westbury. The cracker box, in the meantime, stood up on end in his overcoat pocket. Two ragged urchins, who had probably been fishing, came on the scene, and in less time than it takes to tell it several big angle worms had been deftly dropped into the open end of the cracker box. The next time the hand went down in search of a graham there were lively doings, and the remainder of

the crackers were sent flying across the road, where the urchins quickly gathered them in, unmindful of the fact that only a minute before some of their choicest bait had occupied the box.

All this time machine after machine kept passing the turn, some on their second or third lap, and others on their sixth and seventh. "Who is ahead?" was the question everyone asked, and many were the disputes as to who really was in the lead. Clement about this time was pushing Heath hard for first place in each lap, Gabriel having failed to show up for several rounds, but the fact that the Clement car was sent over the line ten minutes later than the big Panhard was overlooked by many.

NEWS OF THE FINISH.

When the news that Heath had finally won the race was telephoned up to Jericho, the deputies who had been sworn in to guard the course at "\$3 per," ran out and said: "The race is over," and farmers and auto owners, unmindful of the fact that there were cars still speeding over the course, all turned out into the oil-soaked road and made toward the railroad stations or home. It was mere luck that Lyttle, as he tore around the course for the last time, did not run down some one.

NEGOTIATING THE TURN.

A comparison of the manner the cars were driven around the Jericho turn will undoubtedly prove interesting.

Campbell, who rounded the turn nine times, took the turn well at first, when the ground was hard, but on his third turn, after the earth had been loosened up some, he skidded so badly that a tire burst.

Gabriel probably held the turn closer than any other man in the race, sending his two inner wheels clear over the bank into the grass, where they could get such a grip that high speed could be maintained throughout the turn.

Tracy, who drove the Royal Tourist, only negotiated the turn twice, and the second time his machine was running so poorly that his turning could not be gauged. On the first round, however, he held the turn beautifully.

Webb, with his big Pope-Toledo, rounded the corner six times, and seemed to have little difficulty in holding the turn at high speed.

ARENTS SKIDDED BADLY.

Arents, who only went around twice, tore around the turn at high speed, skidding badly, but always keeping well in the road.

Lyttle, in the smaller Pope-Toledo, took the corner slowly, and without skidding; he never seemed to get excited in making the turn, even when pressed by more powerful machines.

Heath, the winner of the race, who drove a large Panhard, slowed up to about twelve miles an hour every time he circled the Jericho turn, keeping his racer well out in the middle of the road, and gathering head-

way the instant the front axle pointed toward the straight. He did little or no skidding; using his brake hard each time he approached the turn, but not applying it until he was within a comparatively short distance from the turn.

Hawley, after his first experience with the turn, when he came near to colliding with the dangerous telegraph pole, slowed up, although his big Mercedes skidded frightfully each time he circled the corner.

Werner used his brake until the rear wheels locked on both times he circled the Jericho turn.

SARTORI TURNED SHORT.

Sartori turned very short, his method being similar to that used by Gabriel, keeping the inner wheels on the grass instead of in the sandy road.

The Renault car, driven by Bernin, negotiated the turn at a high speed without appearing to skid at all. This was undoubtedly due somewhat to the low construction of the car and the small wheels used.

Clement, the first time around, attempted to turn too fast, and had to apply the brake until his car almost came to a standstill, losing nearly all headway and shaking up the occupants of his car pretty badly. After the first time around, however, he seemed to improve, taking the corners at a fifteen-mile clip.

Tart, who drove a ninety-horsepower Panhard, and who at one stage of the game looked as though he might be a winner, took the turn at a frightful pace each time, his big, high racing car swerving and skidding from one side of the road to the other.

TESTE TORE AROUND.

Teste, who covered the course in the fastest time of any of the contestants, followed Tart's style of negotiating the turns, tearing around without regard for consequences. Both of these men, however, kept the road, although their machines skidded several feet at each turn.

Schmidt, in the Packard *Gray Wolf*, had a style all his own. He seemed to make the turn and do all the skidding before he had reached the corner in the broad roadway coming in from Westbury. He started to roll his steering wheel over when the front wheels were fully 20 feet from the turn, skidded, recovered, and made the turn itself where the others did their skidding at almost full speed.

Croker, with the exception of the time he was crowded by Clement into taking the turn foolishly, made the turn at almost as high a speed and almost as regardless of consequences as Tart and Teste. This was probably at a twenty-five mile clip.

Luttgen, driving the German Mercedes No. 18, used his brake hard, but still skidded badly, sending up showers of sand and pebbles.

Wallace, with his F.I.A.T., only passed the Jericho turn once, and that time his

INSTANTANEOUS PHOTOGRAPHS OF CARS TURNING THE FOUR SEPARATE CORNERS OF THE COURSE.

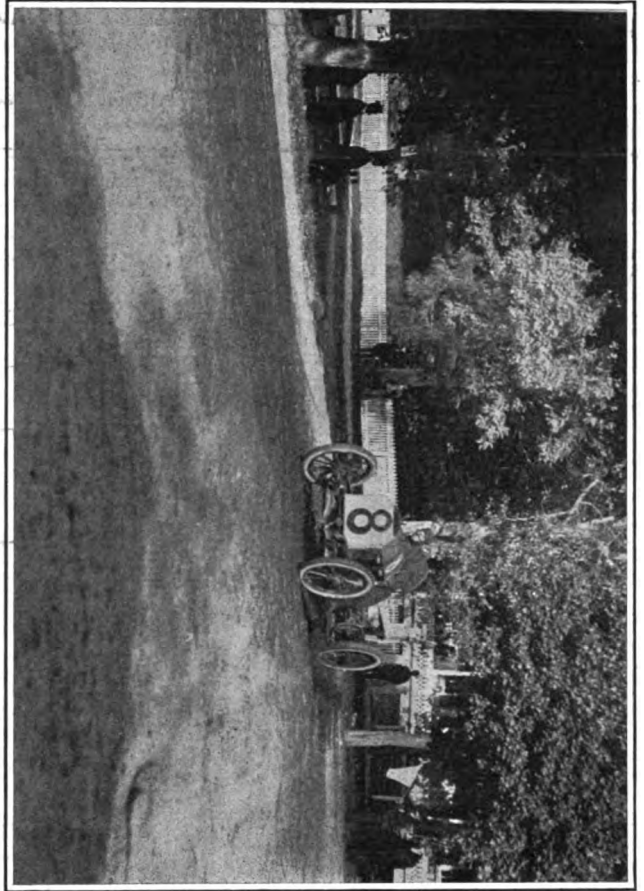

Northeast—Hawley in Thomas's Mercedes After Making the Sharp Turn at Jericho.

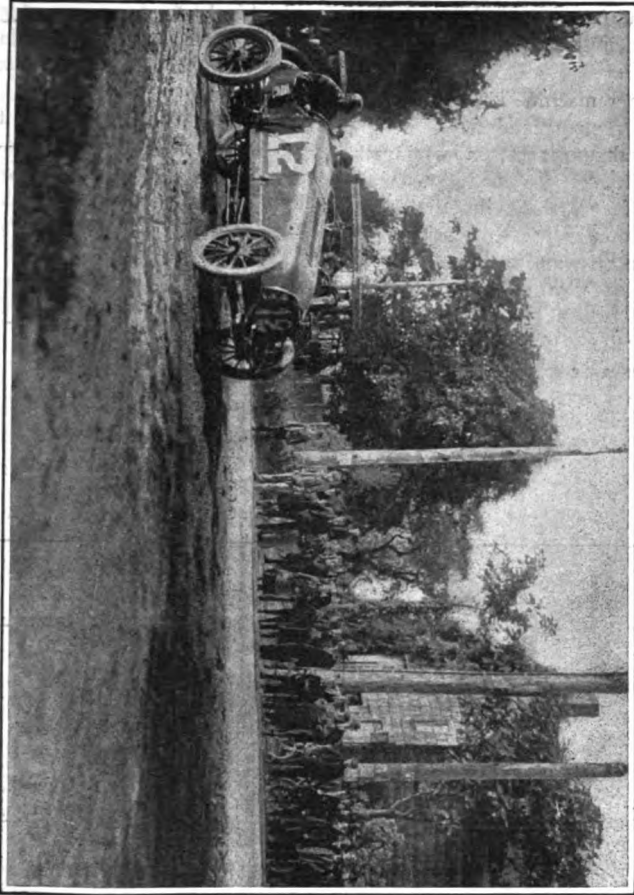

South west—Clement in the Clement-Bayard Swinging into Creed Avenue from Hempstead Road.

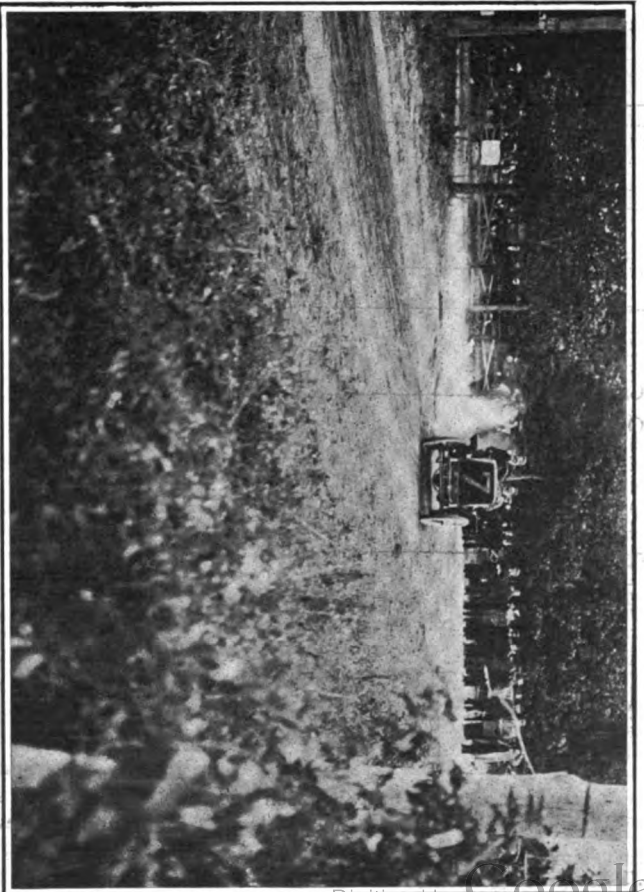

Southeast—Heath in the Winning Panhard Rounding the Dangerous Turn into the Bethpage Road.

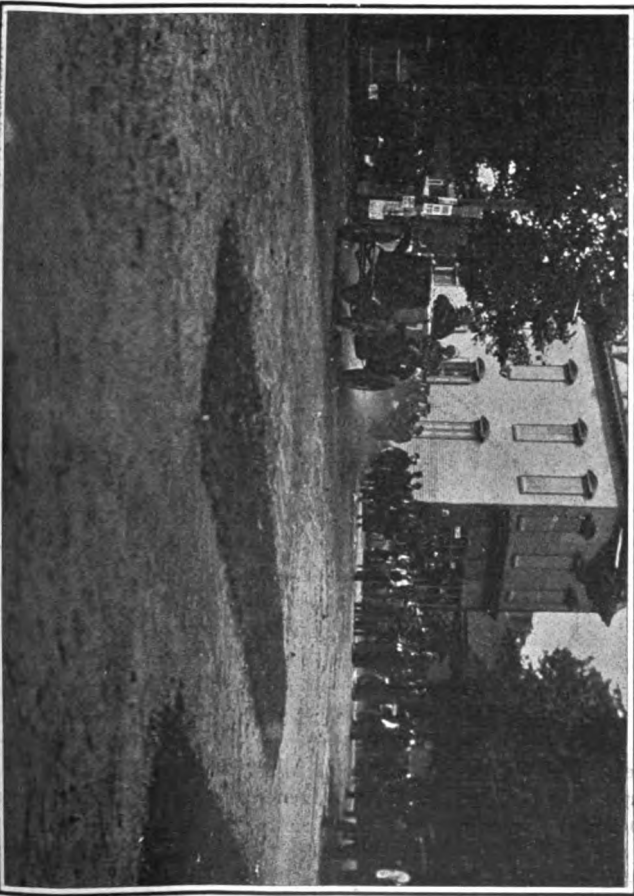

Northwest—Heath on the Turn from Creed Avenue into the Jericho Turnpike.

At the Risky Bethpage Corner.

CAR No.	TIME CONTROL No. 1					
	Entrance			Exit		
	H	M	S	H	M	S

..... Timers.

A CONTROL TIME CARD.

car was in such condition that he stopped at once after rounding into the Hicksville road, not giving the spectators an opportunity to note his style.

NO OPPOSITION VOICED.

A few inquiries among the inhabitants of the country in this locality showed conclusively that the published press reports of the violent opposition to the holding of the race was not the work of the leading farmers in the district, but only the usual soreheads who kick at everything.

"Why, what possible kick can they have?" said one of the leading farmers whose property lies along the oiled roadbed. "There is little or no carting of market truck to the stores on Saturday, as the stores are not open on Sunday, and it would only spoil. Our children do not attend school on Saturday, and therefore will not be on the road. The farming is all done with the exception of picking up a few pumpkins, and that does not necessitate traveling on the roads used by the racers. I wouldn't miss seeing this race for anything myself, although I would not care to occupy a seat in any of the cars. My two sons would not miss it either, and they have a dozen of their friends at our house watching the cars go by. Incidentally both Bill and Jim are getting \$3 apiece for being policemen to-day and keeping folks off the course. The oil sprinkled on the road has so settled the dust that when a carriage or automobile goes past now there is no need of running in the house, and, last, I want to see the Americans improve a little in making these machines. I tell you we have the best mechanics and the best drivers in this country, and if people would only encourage such an event as this occasionally and give the manufacturers an opportunity to test their cars and discover their weak points, I can't see why the big money that goes into European machines will not be spent right here in America."

The interest in the race taken by the Diamond Rubber Company was shown by its energy in gathering twenty-one of its best workmen from its largest branch houses and distributing them in depots around the course with seventy-five new tires ready for instant use.

GABRIEL furnished the only real hair-raising thrill for the watchers at the acute-angle turn on the Bethpage turnpike, at the southeast corner of the triangle. It was on the Frenchman's fifth lap, and he overhauled and attempted to pass Campbell, who was on his third lap, when within 150 yards of the turn. But the German car swung to the edge of the grass on the left of the narrow road, and the reckless Gaul was forced to drop back and content himself with cutting in close as Campbell swung wide, when he jumped away to the fore, leaving the wide-eyed spectators awestricken by his daring.

GABRIEL THE CHAMPION.

In negotiating this corner, Gabriel showed himself by far the most skillful operator.



Hamment Making Exposure at Bethpage Corner for the Remarkable Picture Reproduced on the Front Page of this Issue.

He did not cut off his power so soon as Heath, Clement or Lyttle, held his car steadier, braked it quicker and skidded less. He would come flying down to within 150 yards of the turn before cutting off, jam on the brakes and scoot into the turn with rear wheels sliding but not skidding, so cleverly did he gauge his speed and so true did he hold his course. Once his front wheels found the soft gravel of the turn, he slipped

in his clutch and jumped away over the little rise between the corn fields in five seconds' time.

Heath, also, was quick to get away once he was fairly into the turn, but he was more cautious in taking it, and never jeopardized his chances. Like Clement, he seemed to rely upon the speed and reliability of his car rather than on his daring.

CLEMENT WAS VERY CAREFUL.

Of the foreigners Clement was much the most careful; he handled his odd-looking blue racer with as much consideration as a horseman might a valuable thoroughbred. He lost easily a total of two minutes on this turn. He did not throw in his clutch until well straightened into the Bethpage road, while Heath, Gabriel and Lyttle each did so, even before starting to turn. Lyttle invariably swerved badly when approaching the turn.

Those who were the least skillful were Arents, Campbell, Hawley and Croker. Campbell once threatened to miss the turn entirely, while Hawley's two exhibitions scared the crowd over the fences. He would come pounding down as though he had no intention of turning; then, as if just seeing the cross-road, and getting a sudden notion to turn, he would wrench his front wheels into the angle and trust to the rear ones to follow. The second time he tried it he turned almost completely around, and scared his mechanic thoroughly. Had another car been following close, as sometimes happened, there would surely have been a smash-up.

A NOISE FROM AFAR.

From far up the road there would come the beat of the engine of an approaching car, and in a trice the racer would shoot into view. The guard would wave his flag, there were excited shouts of "Look out!" "Get back!" and then the roar of the exhaust as the flying car swept down to the turn.

Spectators stood in odd, tense attitudes, with strained faces and craning necks, while the racers took the perilous turn, and sighed with relief as the car roared away resolutely on its altered course.

EARLY MORNING TOURS.

Six o'clock saw some twenty reporters, photographers and knowing ones gathered at this far corner, where they confidently expected accidents would occur. Luckily the bursting of a tire on four different cars summed up the mishaps for the day when the judge and his assistants were notified at 1:45 p.m. that the race was over.

Early in the race the sport was very fast, and the shivering few who were at the turn and vicinity probably saw the best racing of the day.

On the first flight all of the drivers fumbled the turn, save Tracy and Gabriel

Arents, who arrived two minutes behind Tracy, gave the onlookers their first thrill. He did not cut off until within 100 yards of the corner, and his momentum was almost too great for him to round the turn. However, it later developed that he had his own particular way of taking that turn, for so often as he returned he did not please to change his spectacular method.

HEATH SETS THE PACE.

Heath, the ultimate winner, had already begun to cut out the pace, for he was the first to alter the order of the running by reaching the Bethpage corner twenty seconds in advance of Lyttle, who had preceded him at the start by two minutes.

The first eight cars passed within thirteen minutes, but the remaining eight strung the time out to twenty-four minutes, and Gabriel on his second lap preceded Wormser, the last, by more than a minute. Campbell, the first starter, followed hard in the Frenchman's wake, and skidded dangerously on the corner, the big Mercedes threatening to turn turtle.

Then came Webb, eight minutes behind, and two minutes later Heath. Hawley, the next in order, came down like a whirlwind, ran dangerously wide, and by a remarkable recovery was off for Hempstead. Teste came next in a Panhard, and then Lyttle in the smaller Pope-Toledo. Bernin, in the Renault, punctured a tire on the turn, and shortly after went into the ditch on the Bethpage road with a broken propeller shaft.

CROWD BEGINS TO GATHER.

A crowd now began to gather; there were those who stood afar in the wide corn-field, and those who strutted arrogantly in the middle of the course. Of the latter, every mother's son knew everything there was to know about "automobeel" racing.

A lone yellow-leg snipe flew inquisitively over the corner, whistling plaintively. The crowd took up the call, and mimicked the long-billed whistler so that he returned again and again. Then someone in a nearby garden fired a shotgun at him and he flew indignantly away. Meanwhile, twelve cars had passed on the second lap, and the flying Gabriel was back on his third, with Arents, the erratic, chasing him ten seconds behind, though of course the latter was only on his second lap.

The third flight passed, and Gabriel, with Heath now chasing him only a minute behind, passed on his fourth lap. Third-lap stragglers followed on.

GABRIEL'S NON-APPEARANCE.

Gabriel's non-appearance on his fifth lap caused no little anxiety; it was easy to believe that he had met with some accident through his recklessness. Heath hove in sight, flashed around the turn, smiling under his wind-blown blonde mustache and looking nonchalantly back for his followers as he sped away to the roar of his 90-horse-power engine. Gabriel came eight minutes

later, and then there was a thirty-five minutes' wait for the next car in that flight, though a few third and fourth-lap stragglers came through. Lyttle, in the 24-horse-power Pope-Toledo, was fourth in the fifth lap.

Heath maintained his lead in the sixth lap. Gabriel followed six minutes later, and then came Clement and Lyttle in the order named, the first twenty minutes behind Gabriel and the American seven minutes later.

POST THREATENED WITH ARREST.

About 10 o'clock in the morning, Augustus Post, of the A.A.A., accompanied by a dapper young man, came down from the direction of Hicksville in a steamer and drove his car to the side of the road, when both got out and mingled with the crowd at the turn. The judge stationed at the corner immediately remonstrated with Mr. Post for having come down over the course, which on this leg was quite narrow. To this remonstrance Mr. Post did not seem to pay serious attention. After some argument, in which the judge informed Mr. Post that he could not be kept off the course if he insisted on going on it, Mr. Post evidently got somewhat indignant, and made some remark that apparently riled the judge. The latter official meanwhile had discovered that the automobile did not carry a license number, and he called the attention of a sheriff of the county, who was among the crowd, to this violation of the law. After some conversation with the sheriff Mr. Post and his companion got back into the car and returned along the course in the direction of Hicksville. He reappeared some time afterward, and seemed to find enjoyment in making short trips up and down the narrow oiled road between the abandoned Long Island Railroad tracks and the dangerous Bethpage corner.

Gabriel came no more to charm by his expert driving, and the order of the three leading cars was the same throughout the seventh lap. In the eighth Tart, in his Panhard, had crept up ahead of Lyttle, beating him to the turn by thirty seconds. The Frenchman came no more, however, and Lyttle held third place hard and fast in the ninth round, though he was an hour and four minutes behind Heath.

CLEMENT IS AHEAD.

Meanwhile, in the ninth lap Clement maintained his position so close to Heath that he was actually in the lead as to elapsed time, and excitement ran high. From a vantage half way up a telephone pole, where he had climbed to make pictures in safety, a celebrated photographer assured everyone that the boy (Clement) would win.

The two remaining racers passed on their tenth and last lap, and the crowd flocked around the "field" telephone, and impatiently awaited the result of the race. When it was announced that Heath had won folks said: "I was afraid he would," whereby

it might be inferred that the general sentiment at this point was disappointment that young Clement had failed to win the race, which for nearly seven hours had been nobody's race.

Grade Crossing at Mineola.

Aside from the turns at Jericho, Bethpage and Queens, it is probable that the Mineola crossing of the Oyster Bay branch of the Long Island Railroad was the spot where the most daring driving was done. This is a three track grade crossing on the Jericho turnpike and is dangerous. The spot is one where a number of touring cars have come to grief during the last three weeks. It is situated about midway on a straight stretch of road and the temptation to the drivers was to take this straightaway at tremendous speed. There are no trees and a view can be had of the turnpike for a long distance ahead.

The contestants Saturday, for the most part, treated the crossing as if it was not. Although the regulation green flag with perforations was hung at the regulation distance above the tracks, nearly all the drivers acted as if they had not seen it.

The road is down grade for a considerable distance from the road-house known as Krug's, which is to the westward, and the contestants could not resist the temptation to attempt to gain at this point. As they struck the tracks the machines made great jumps. One of the watchmen at the crossing noticed the place where Croker's Simplex alighted after one of these flights and measured the length of the leap. He was amazed to find that the machine had gone approximately 37 1-2 feet. In the light of this record, it is not strange that the Simplex weakened and sagged.

There is little doubt that Hawley's Mercedes was damaged by the jolt it received at this crossing, for it was just afterward, and while running a mile and a half beyond on a perfectly level piece of road that the springs snapped one after the other.

The race commission, the railroad and the supervisors all had men at this crossing. There was also a watchman at the corner of Mineola avenue nearby with a flag. Seven men in all looked after the safety of the racers. The engineers had orders to slow down to four miles an hour as they approached the road, and this order was strictly observed. The trains came to a full stop when they were flagged. Trains stopped four times in the course of the race. At 7:54 a.m. a regular northbound train was stopped to allow Webb to go past, and at 10:53 a southbound train was compelled to slow up as two of the machines were in sight. A special which went north at 7:30 and returned at about 11 o'clock stopped without signal. It is probable that this was to give a chance to spectators to disembark, for a considerable number left the train.

Croker and Luttgren had a fight for posi-

tion at about 9:40 just as the crossing was reached. Croker passed the Wormser machine shortly after passing the tracks, in full sight of the watchers.

Krug's road-house was the headquarters of the Pope and Packard concerns, and the Royal car was also stabled in the barn of this hotel. Across the road was a stand of considerable size which was comfortably filled during the morning. A tire station was erected at the side of this stand, but the spectators did not have the satisfaction of seeing any of the cars stop there for repairs.

It was estimated that about 2,000 people were congregated at this point. It was a spot of little danger for sightseers, as the racers could be plainly seen as they came over the brow of a hill to the westward, about three-quarters of a mile distant.

In the Press Stand.

The Press stand was on the side of the road opposite and facing the grand stand. It was built with the evident idea of protecting the occupants from the elements, but on the Saturday it protected them from too good a view of the cars, lest their minds be distracted from their serious business. Both ends were closed in, that toward which the cars approached by the timekeepers' booth, so it was impossible to see the approaching car to distinguish the number on the front, so after the familiar call of "car coming" there was a flash of gray and a rear view rapidly disappearing in the distance, with a guess at the identity of the racer. As the forenoon wore on and the cars dropped out with the universal "tire troubles at Jericho," the announcer called out the numbers of the cars as they left Queens, so the newspaper men knew what ones to expect.

As the cars started the well known driv-

ers got much applause from the press stand, the grandstand having gotten up too early to be more than coldly interested in spite of a politely worded request that it wake up as the press stand was tired of doing all the applause. When Tracy appeared, after it had been reported that he was out of the race, there was a surprised exclamation of "there's Joe Tracy" and the first sound of genuine applause.

In the middle of the race interest lagged, the cars coming at long intervals, but it was aroused when two cars flashed by together and kept up by the close running of Heath and Clement and the remarkably even running of Lyttle.

Judging from the impatient calls for messengers and the complaints of the representatives of the dailies the wire service was swamped early in the day, even though all news of casualties was carefully kept from the stand.

The designer of the stand evidently thought the occupants would remain in their places during the entire time, for no provision had been made for passageways except the tops of the tables, which were generally ~~used~~.

At first there was some confusion in the announcing of the time, but it was soon systematized, the announcer calling out the net elapsed time of each lap, and Mr. Gillette, reporting to the press stand the time each car passed the tape.

An interesting incident was the coming of Clement to make his protest after he had finished. He walked up in front of the stand apparently very much tired. He had taken off his mask showing the upper part of his face, a white V in marked contrast to the jet black color of the lower part. He received a vigorous applause.

The chief criticism to be made of the accommodations of the press representatives was the enclosing of the stand to such an

extent as though the racers were to stop in front and let one look at them. In other respects their comfort was considered, even to the serving of food and drink.

At the Weighing-In.

Weighing in of the racing machines took place at Frank Bray's small grocery store and wood yard just outside of the hotel grounds at Garden City the day before the contest. The platform of the scales was in the yard while the weight beam was in a dark corner behind a partition in the store. Messrs. E. T. Birdsall and A. L. Riker, judges of the weighing in and members of the Vanderbilt race commission and of the technical committee of the Automobile Club of America, declined to give out the weights of any of the cars, which were weighed with tanks empty and the men out. An allowance of fifteen pounds was made for magneto igniters.

The weight of a car having been ascertained to be within the limit of 2,204 pounds required by the conditions governing the contest, the frame and each wheel was stamped with a special official punch whose face bore the combined initials of Messrs. Riker and Birdsall, the R reversed so that its back formed the vertical line of the B. Substitution of other wheels and parts before the race was thus warded against.

The French cars arrived at the scales first, about 10 o'clock in the forenoon. The springs of all of them were tightly wrapped with strong cord to guard against breakage of the leaves on the rebound of the car when going over bumps in the road. The same precaution was later seen to have been taken with several of the German, Italian and American cars. Clement had coated the cord on his springs with tallow to make it waterproof. Tart's Panhard and several of the other cars, instead of having the springs wrapped with cord, were equipped with the Truffault suspension device.

In order that everything on his Mercedes should be German and so not in the least item violate the requirement that every part of and equipment on each car should be made in the country which the machine represented, C. G. Dinsmore had sent down to the pier of the Hamburg-American Steamship line to secure the cord for his springs.

Clement's car had fitted to it a large copper gasoline tank with capacity for sufficient fuel to last six rounds, and Gabriel had a 75-gallon tank that was expected to make it unnecessary for him to take on any oil during the entire race.

The rules of the commission required that after the weighing the cars should be placed in the official garage and locked up until the morning of the race under the care of the commission. Heath raised strenuous objection to this, as he wished to tune up his car during the remainder of the day, and

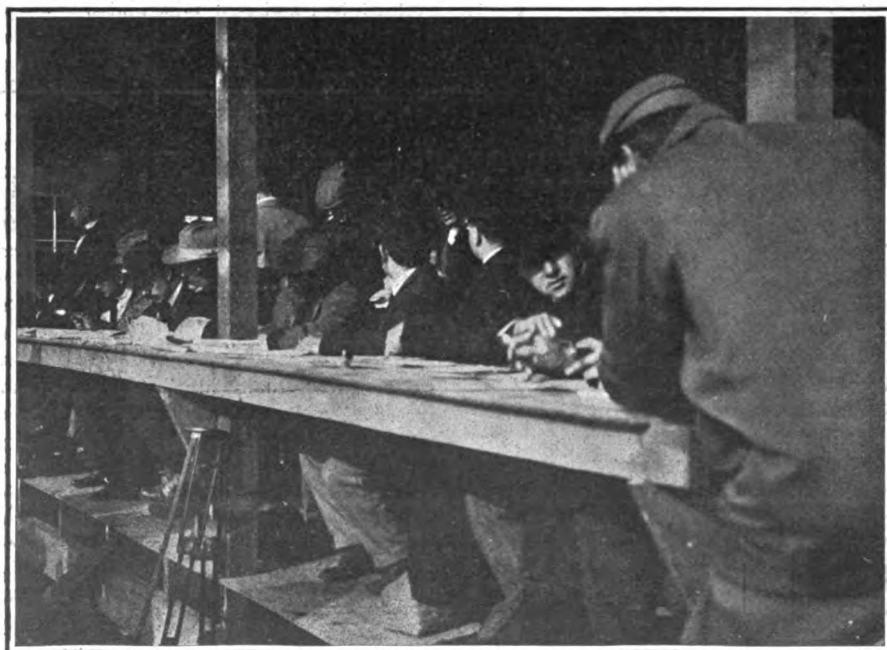

INTERIOR OF THE PRESS BOX OPPOSITE GRAND STAND AT WESTBURY.

PHOTOGRAPHS MADE AT THE WEIGHING-IN AT GARDEN CITY THE DAY BEFORE THE RACE.

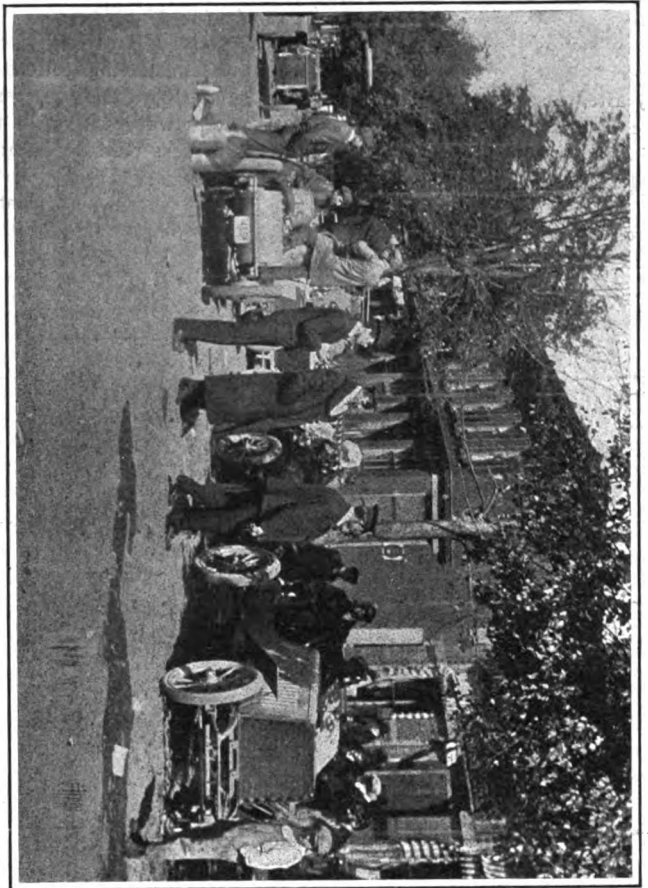

Cars in the Road Near the Scales—Heath in Panhard in Front.

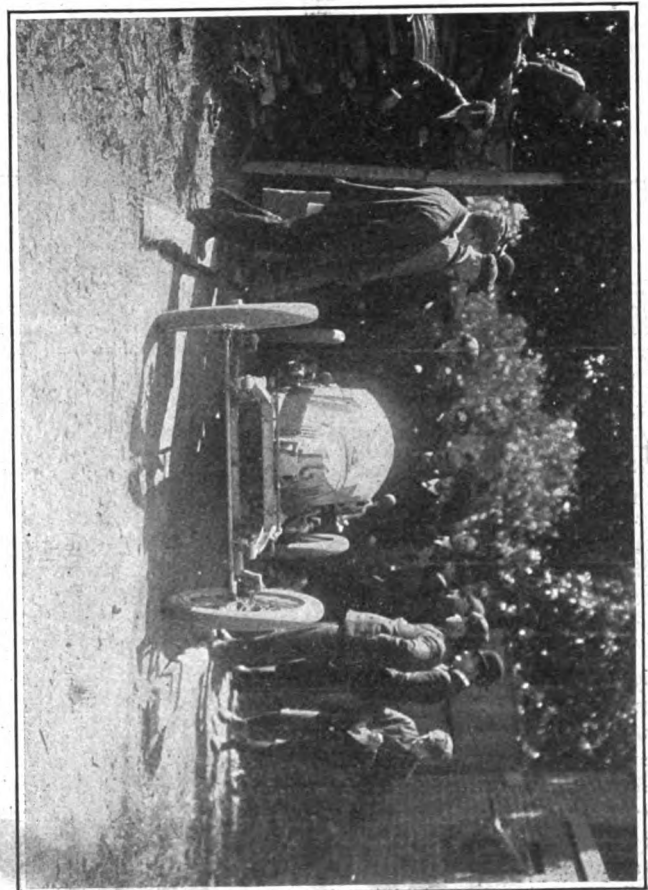

Packard "Gray Wolf" on the Scales—Schmidt Standing Second on the Left.

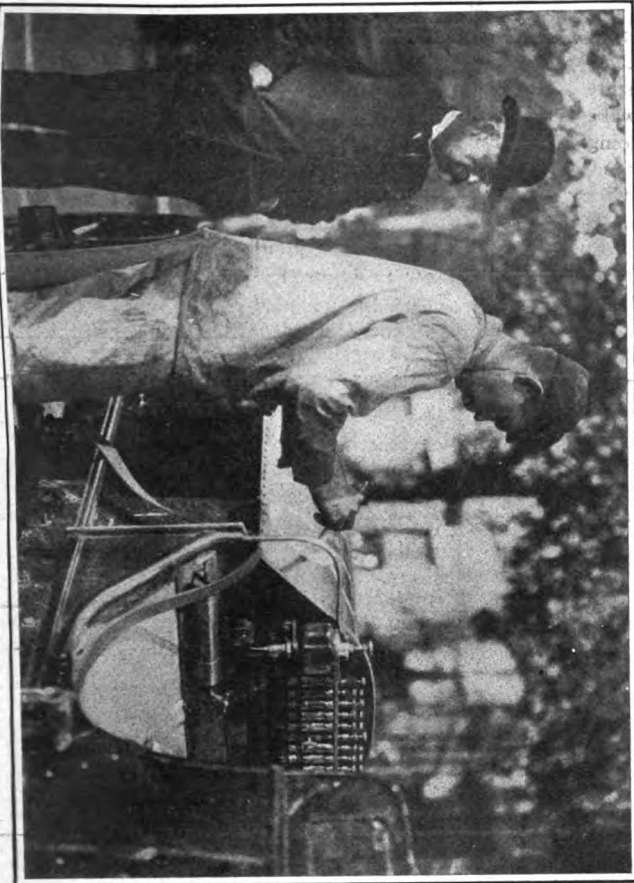

Palading the Figures "18" on Worman's 60-h.p. Mercedes.

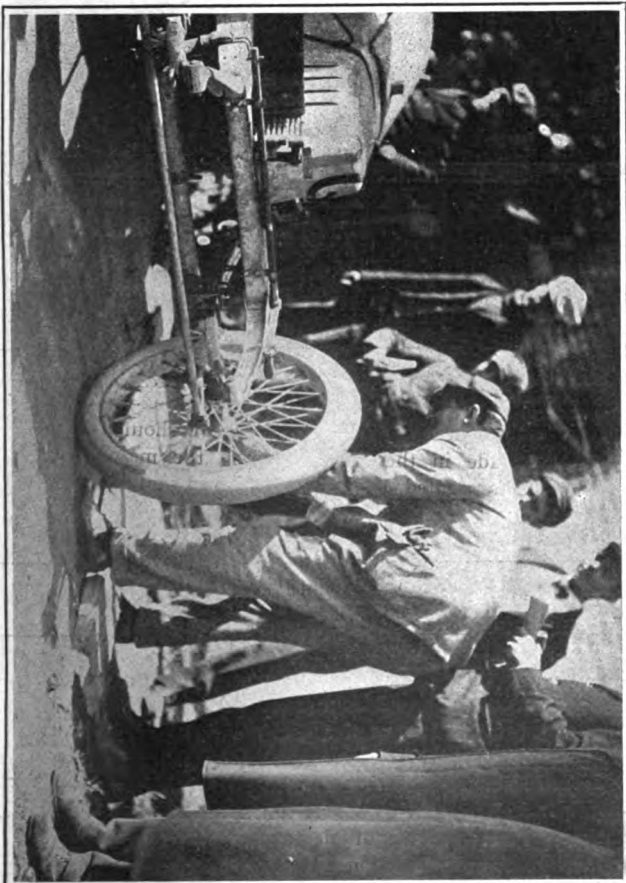

A. L. Riker Stamping the Hubs of the Packard Entry to Seal It After Weighing In.

THE AUTOMOBILE

VOL. XI.

No. 16

Published every Saturday by

THE CLASS JOURNAL CO.,

Flatiron Building, Madison Square,

NEW YORK CITY.

Cable Address - - - Autoland, New York
Long Distance Telephone - 300 Gramercy, New York**SUBSCRIPTION RATES:**United States, Canada and Mexico, - One Year, \$2.00
Other Countries in Postal Union, - One Year, \$3.00To Subscribers—Do not send money by ordinary mail.
Remit by Draft, Post-Office or Express Money Order,
or Register your letter.**FOREIGN SUBSCRIPTION AGENTS:**ENGLAND:—Iliffe & Sons, Limited, 3 St. Bride Street,
Ludgate Circus, London, E. C.FRANCE:—Boyveau & Chevillet, 22 Rue de la Banque,
Paris.

GERMANY:—A. Seydel, Mohrenstrasse 9, Berlin.

To Advertisers—Copy or changes in orders for advertisements should reach us not later than 5 o'clock p. m. Monday for the issue of Saturday following.

Copyright, 1904, by The Class Journal Company.
Entered at New York, N. Y., as second-class matter.

The Automobile is a consolidation of The Automobile (monthly) and the Motor Review (weekly).

Copies Printed This Issue, - - 13,000

" " Since Jan. 1, - 507,000

A Retrospective Glance. Now that the race is over a word is due to the men whose time and labor, both freely given in the interest of sport, have made it the success which it certainly was. The task which they attempted was a difficult one, as the details of such a road race necessarily have little in common with those of track races, endurance runs and the earlier American competitions. The successful management of the great road races abroad, in each of which the courses have been longer and the cars larger and faster, is the outgrowth of years of experience. Here there was no such experience as a guide, and the managers of the race were called on to create, with no governmental aid and in the face of some unreasoning opposition, the complicated machinery essential to success, the financing, the securing of legal permission to use the course, the oiling of the roadway, the policing of the course, the timing of the cars, and innumerable minor details. That some things have been overlooked, that some mistakes have been made, and that the committee, collectively and individually, have been open at times to criticism, in no way detracts from the credit due its members for boldly attempting and ably completing such an undertaking.

Much stress has been laid by the daily papers, presumably voicing a popular opin-

ion, upon the injustice of depriving the residents of Nassau County of the use of their roads. Without dwelling on the fact that these roads have been improving to the amount of many thousand dollars by the preparations for the race, it may be noted that the hardship, if any, was confined to those residing directly on these roads, who for some eight or nine hours were compelled to use special caution in driving to or from their homes. They were not barred from the roads, though they were, for this short time, put to some inconvenience in using them. If there were any bone fide complaints on this ground, they were not aduible in the good-humored gossiping crowds of farmers and citizens along the roads and in the streets of the towns on the course. To all appearances, the occasion was welcomed as a public holiday. Every one was out to see the great free show. Every one was interested in the cars and the personalities of their drivers; and, quite aside from the many who profited in pocket by the race and the visitors, every one seemed pleased with the result. The organized opposition to the race was largely a sort deserving of little consideration, as it gave no evidence of representing the true public opinion of the community, and its efforts were delayed until the arrangements had progressed so far that the prohibition of the race would have involved the serious disappointment of many and the waste of thousands of dollars. It not only failed of good result, but it worked positive harm in diverting the energies of the management from attention to important details. The effort culminated in an application for an injunction on the day preceding the race. The denial of this application reinforced the legal position of the race management, and the race was therefore run under the consent of the county authorities, backed by a decision in open court.

So far as the interests of the contestants are concerned, there was no ground of complaint over the conduct of the farmers and other local residents. The roads were left clear for the racers from the early morning until the race was practically over, the few horse vehicles giving the speeding cars a wide berth. In marked contrast to this is the conduct of the great body of spectators, especially of many of the automobilists who had congregated in their cars in the vicinity of the grandstand. Regardless of their obligations to the race management, of the rights of the competitors, and of all principles of fair play, they made a mad rush, pell-mell, for the road before the intended close of the race, endangering the spectators on foot and robbing of their well-earned honors of third, fourth and fifth place several contestants who had fought bravely all day under adverse conditions. It would be difficult to find a parallel to this gross selfishness and lack of sportsmanship on the part of those who, from their positions in society and in automobile life, might be looked to as models.

It would be foolish to deny and useless to discuss the question of danger to the competitors. A greater or less amount of risk attends the participants in all the most popular sports, and a close study of records would be required to show whether the fatalities are greater in polo, horse-racing, or even on the gridiron, than in automobile road racing. As long as human nature is as it has always been, a very large proportion of athletes and the great majority of spectators will desert the tennis court and rowing course for something where the element of personal risk is a controlling factor. Thus far the fatalities in automobile racing have been confined largely to two classes of drivers—those, like the late Count Zborowski, who deliberately recognize and court dangerous risks, and those who imagine that a greater or less amount of road driving and touring fully qualifies them for the final achievement of road racing in company with the great drivers of the world. One element of risk will never be entirely eliminated, the sudden failure of the steering gear or other vital component of a car; apart from this, the risk to a thoroughly experienced driver is no greater than many sportsmen seek as giving the desired zest to their efforts.

The policing of the course went no further than the flagging of all intersecting roads, and consequently affected vehicles only. Those on foot were free to wander at will, both in and out of the controls, and many actually stood in the roadway rather than by the roadside, even where the cars were passing at full speed. At the entrance to each control, which the cars approached at very high speeds, men, women and small children stood in the middle of the road, merely making way as a car slowed down, and being moved with difficulty when a second car came up to a stop abreast of one already between the tapes. In the town of Queens, the only part of the course within the limits of Greater New York, the municipal police did good service in guarding the corners where the crowds were assembled, and showed what might be accomplished were the services of a disciplined force employed to guard the entire course.

Mechanical Lessons of the Race.

It is easier, after a race like that of last Saturday, to generalize about the mechanical troubles not reported than about those that occurred. Nothing is so difficult as to get an exact account of breakdowns occurring anywhere around a course thirty miles or more in length. It is wholly possible that of the numerous "troubles" reported as such without particulars, some if known would quite change the apparent complexion of the results as known.

However, if we take the facts known—and most of the important ones seem to be known—one above all others stands out in striking relief. Barring tire punctures, some of which at least may possibly have

BUSINESS AND FUN FOR THE A. L. A. M.

Fifty-three Representatives of Licensed Concerns Enjoy 70-Mile Run, and Discuss Formation of Technical Branch Over Casino Dinner.

The meeting planned by the Association of Licensed Automobile Manufacturers for the heads of mechanical and technical departments of members' factories was held in New York on Friday, October 7, and was entirely successful. "We accomplished everything we wanted to," said George H. Day, general manager of the association, "and even more than we expected. All our plans worked well, and the members left feeling that a step had been taken in the right direction."

The party, consisting of fifty-three representatives of automobile manufacturing concerns and a few invited guests, assembled at the Locomobile garage at 9 o'clock in the morning and entered the eighteen gasoline cars that had been provided for the occasion. The machines were of American manufacture, without exception. Each man was given a badge with a number on it, and a printed list of all the members, every man's number being placed opposite his name. The object of this was to enable each to know who the others were without the necessity of introductions, and the plan was found to work admirably.

At ten points along the route all the cars stopped and the passengers got out and transferred to other machines, lists showing the order of transfer having been provided. This proved to be a popular arrangement, and there was a rush for front seats every time a transfer point was reached. Thus each man rode in ten machines besides his own. The total distance traveled was about seventy miles, the most distant point reached being Elmsford, N. Y. A lunch was partaken of on the way out at the Ardsley Club at Ardsley-on-the-Hudson, and on the return trip by way of White Plains, Mamaroneck, Larchmont, New Rochelle and Travers Island, the party was entertained by the Larchmont Yacht Club, and by the New York Athletic Club on Travers Island, both of these organizations opening their clubhouses for the occasion.

The Casino, Central Park, New York, was reached at 6:30 p.m., and dinner was attacked without delay. As had been planned, the discussion during the dinner dealt with the idea of forming a technical branch of the A. L. A. M., and "Colonel" Clifton, of the Geo. W. Pierce Company, was asked to appoint a committee to decide upon the best way of handling the matter and arrange for organization and details.

It is proposed to hold a similar meeting, on a larger scale, next spring, when foreign cars will be included. Every manufacturer in the A. L. A. M. was represented, some sending three delegates. Several cars of the 1905 models were in line and attracted much interest. These were the Pierce, Thomas, Columbia and Locomobile machines.

PARTS MAKERS' MEETING.

A meeting of the directors of the Motor and Accessories Manufacturers Association was held at the Hotel Astor, New York city, Thursday, October 6, and an allotment committee was appointed to allot the space assigned to the association for exhibiting motors and accessories at the Madison Square Garden and other automobile shows. The committee consists of D. J. Post, chairman, F. E. Castle, S. D. Chapin, H. Dunn and Mr. Smith. It was decided to send out

diagrams and application blanks at once, and to give former exhibitors the preference in allotting space.

The directors recommended that members exhibit only at sanctioned shows. Eleven new members were elected, as follows: Federal Mfg. Co., Parish & Bingham, Cleveland, O.; Dow Portable Electric Co., Braintree, Mass.; Wray Pump and Register Co., Rochester; Auto Coil Co., Jersey City; Warner Instrument Co., Beloit, Wis.; Continental Rubber-Works Co., Erie, Pa.; F. E. Walworth, Detroit; Manufacturers' Foundry Co., Waterbury, Conn.; Carlyle & Johnson Machine Co., Hartford, Conn., and the Webb Company, New York. A number of applications for membership were held over and will be voted on by mail. The association now has about sixty-seven members. The matter of opening a New York office was held over for a time.

It was decided to send to members a letter recommending that prices quoted to automobile manufacturers be as low as, if not lower than, those made to jobbers.

SHOW DATES ARE FIXED.

National Association Committee Prepares a Schedule.—Other Business.

Sanctions for automobile shows to be held at Philadelphia and Toronto were issued at a meeting of the Show Committee of the National Association of Automobile Manufacturers, held on Friday, October 7, at the association's rooms, in New York. The complete list of show sanctions issued to date is as follows:

New York—January 12 to 21.

Chicago—February 4 to 11.

Philadelphia—January 23 to 28.

Detroit—February 13 to 18.

Toronto, Ont.—February 27 to March 4.

Boston—March 4 to 18.

Washington—March 27 to April 5.

A meeting of the executive committee of the association was held also, when a report was received from the Freight Rates Committee to the effect that a hearing had been obtained with the Official Classification Committee, and that there was reason to hope for a reduction in freight rates on automobiles in the near future. The resignations of the Hyatt Roller Bearing Company and of the National Cement and Rubber Company as associate members were accepted. The representatives of the Reliance Automobile Manufacturing Company, Detroit; the Corbin Motor Vehicle Corporation, of New Britain, Conn., and the Phele Motor Vehicle Company, Stoneham, Mass., were admitted to membership. The Daimler Company was reinstated, and the name of the Berg Company changed to the Worthington Automobile Company. General Manager S. A. Miles was re-elected N.A.A.M. representative on the committee of allotment for the Madison Square Show.

The Association has under consideration the advisability of instituting a test case to ascertain the legality or otherwise of requiring automobilists to take out licenses, and the matter will be referred to counsel. This decision was brought about by the necessity which now exists for automobilists taking out licenses for a number of States when undertaking a tour of any length. The association wishes to ascertain whether, if a license is necessary at all, a license taken out in any one State will not suffice for all other States.

Gasoline automobiles are now so quiet in operation that the cry is being raised in some quarters that they are dangerously quiet, lacking the automatic warning of approach given by the older vehicles.

been due to malicious mischief, in Saturday's race, there was no one class of mechanical trouble especially common. Troubles of many kinds there were, some due to faults in construction, and others—the one fatal accident among them—due to bad driving. But most of them were of so diversified a nature as to suggest that the builders of racing machines are approaching that stage of perfection in which, as in the *One-Hoss Shay*, the "weakest part" is "as strong as the rest;" the result being, however, not instantaneous dissolution of the entire fabric at the end of its life, as befel the Deacon's vehicular triumph, but equal likelihood of any part to give way.

That sort of perfection is obviously not wanted in the running gear, and especially in the steering gear—a fact which our European friends seem to have grasped just a little bit better than we; but, for the rest, it is interesting to note how small a part in the day's *pannes* was played by ignition, carbureter, lubrication and pump troubles, or by stripped gears. One car smoked badly, and two were put out of the running by pump and ignition troubles respectively. But in general it might be said that these once troublesome details have been, if not finally, at least satisfactorily solved.

The troubles that overtook several clutches of similar make or type certainly suggest the possibility of improvement; and the twisting of Bernin's propeller shaft is an example of the difficulty experienced by any maker in jumping at once from one to another type of car, or from one size to another of double the power. The greatly increased inertia of the flywheel of Tracy's car, speeded up as the engine was to nearly 1,800 turns per minute at racing gait, and the resultant greater severity of the road shocks in their twisting effect on the transmission mechanism, were doubtless to blame for the breakage of the propeller shaft joints of that car. Unless the compression had been increased in the tuning up, it is hard to see why the cylinder and crankcase of the same car should have cracked later on.

One car—Croker's—nearly succeeded in emulating the fate of the Deacon's rig, owing to having been pared down everywhere to take a rather heavy engine. It is the first public instance we recall of the pressed steel frame being tested to destruction on the road, and it illustrates very well the value of that frame for ordinary service, in that it bends, and thereby warns, before it breaks. Possibly the incident suggests also the desirability of a very flexible joint between the clutch and the first gear shaft, of some mode of suspension that will retain the clutch alignment despite distortion of the frame.

As to the question whether a light car with a fast motor, a medium weight car moderately powered and relying on regularity rather than speed, or a big and high-powered car, is the likeliest winner—is that question settled by Saturday's race? We hardly think it is.

(Continued from page 462.)

after some argument Messrs. Riker and Birdsall waived the rule and agreed to leave all the cars in the hands of their drivers until after the race, when they were to be weighed again.

Besides ascertaining the weight, the judges required each car to demonstrate its reverse, to show brakes on the wheels as well as on the transmission, to show that the exhaust was not directed toward the ground, and to show the ratio of engine speed to road wheel on the highest gear.

The German and Italian cars weighed after the French, and the American machines last.

Prominent personages in automobile affairs both at home and abroad, in addition to the drivers of the cars, and the officials who were present at the weighing in, were C. G. Dinsmore, George Ducros, Foxhall P. Keene (on horseback), Albert C. Bostwick, W. Gould Brokaw, Henry B. Joy.

The Winners After the Race.

When Heath brought his car to the scales at Garden City after the race he was in a very nervous condition. THE AUTOMOBILE representative congratulated him on his victory and he asked, "Am I to be congratulated? I thought I had won, but now they tell me I must wait until 9 o'clock to-night before I will know."

While his men were washing the dirt from his machine preparatory to the weighing, he walked nervously up and down the road while a crowd watched and commented on his movements, and a couple of photographers tried to catch him still for an instant for a snapshot. His mental state was apparent, and he had the unexpressed sympathy of all when a reporter for one of the "yellow" papers began asking him idiotic questions.

"Mr. Heath, what were your feelings when you made the corners? Did you think you were going to be killed? Do you ride automobiles for a living?" were fired at him rapidly. He tried to answer all the questions politely, but it was evident that he was anxious to get away from it all. He said that at one time he had one of the narrowest escapes he had ever had. He was passing one of the cars at top speed when the operator of the other car turned to look at his side levers, and in an instant the machine swerved until the racers almost touched. With characteristic sportsmanship Heath declined to give the number of the car.

When his Panhard was placed on the scales, a representative of Clement, who had at this time brought his car to the scales to be weighed in, demanded to know the exact weight of Heath's car. A. L. Riker, who was attending to the weighing, refused the information, stating that the weights had been placed at 2,204 pounds and the scale beam was not lifted, this being the process followed for all the cars. The beam

of the scales was in a grocery store behind a partition. Mr. Riker appeared to resent the demand as an imputation and stated that he was willing to have any member of the committee come and examine the weight.

An argument followed between Clement and Heath in French and in a minute the little store was filled with a gaping crowd trying to make out what it was all about. Clement seemed to feel that his lack of knowledge of English had lost him the race, as he said to one of his associates: "He understands English and I don't, and he gets the better of me." Subsequently the party adjourned to the Garden City Hotel and there awaited the decision of the Race Commission.

After dinner the Race Commission met in the committee room in the Garden City Hotel to consider the protest which M. Clement had filed immediately after the finish of the race. A prolonged discussion was held, and about 1:30 o'clock Sunday morning, Mr. Vanderbilt, the referee, announced that the protest had been disallowed. In the meanwhile, many of the interested persons had scattered, some returning by late trains to New York City, others retiring to their rooms in the hotel, Heath, the winner, being among the latter.

Panhard and Clement Cars.

Of the cars finishing first and second in the cup race, the winning Panhard had many features in common with the speedy but unsuccessful team entered in the Gordon Bennett elimination trials last spring. The four-cylinder motor, rated at 90-horsepower, is said to brake 110-horsepower at its normal speed. It has forged steel cylinders of 6.8 inches bore and stroke, copper jackets, mechanically opened inlet valves, and Eise-mann ignition by magneto, single coil and distributor. The flywheel has fan spokes to assist the draught, and the clutch has metal to metal surfaces, an innovation for Panhard cars. The gear box is unusually small, and the gear shafts are large and bored hollow, and run in ball bearings. Three levers are used, two to shift the gears and reverse, and one for the brake. Four gear changes are used. The now familiar Panhard arrangement for controlling the spark and throttle by movable spokes in the steering wheel is used. The bonnet is enormous, and the driver sits very low, as in nearly all of the recent racers, so that only his head is above the bonnet. Propeller shaft drive is used, as in the Gordon Bennett trio. The car weighs 2,204 lbs, and its wheel base is 100 inches.

The Clement car which so nearly beat the winning Panhard has a 90-horsepower motor and shaft drive, three forward speeds and reverse, and a wheel base of 106 inches. It weighs 1,870 lbs.

The number of automobiles in St. Louis has increased from 200 in April to a total of nearly 800.

Luncheon to the Drivers.

The smoker held at the rooms of the Automobile Club of America on Tuesday evening, October 11, in honor of the drivers who participated in the Vanderbilt Cup race, was thoroughly enjoyed by nearly eighty automobilists—club members, visiting automobilists and racing men—though some of the bright particular stars were absent. Heath, who had sailed on the *Kaiser Wilhelm der Grosse* that day, sent a letter regretting his inability to attend; Teste, Tart and Gabriel were "doing" as much of the country as they could—especially Niagara Falls—before leaving for France on Wednesday; Tracy had left for Cleveland, where he had arranged to race. Clement was present, however, and his entrance was the signal for a round of hearty cheers, which caused the "Baby Driver" more embarrassment than even the loss of a race.

Frank-Crocker, A. C. Webb, Herbert Lytle and E. E. Hawley, all American drivers, were cheered to the echo as they came in, looking very strange in their evening clothes after the impression gained by seeing them clad in racing costume and covered with dust and grease.

Winthrop E. Scarritt, president of the A. C. A., expressed the hope, in the course of a characteristic speech, that at next year's Vanderbilt Cup race the crowding of spectators on the course would be avoided by building the grandstand over the course, like a bridge, as was done at the Gordon Bennett race in Ireland in 1903. He also spoke strongly in favor of a country clubhouse for the A. C. A. on Long Island, somewhere in the vicinity of the course, which, he said, would be an advantage if the next contest is held over the same or neighboring roads.

Clarence Gray Dinsmore spoke highly of the steady running of the American cars, and thought the manufacturers should feel encouraged to build faster machines. He predicted great things for the Mercedes special racing cars in course of construction.

Charles J. Glidden's talk about his automobile tour by rail was listened to with close attention. Punctures were naturally unknown, he said, and there was no need of anxiety as to the condition of the road. His "special" frequently ran faster than the express trains, having to cut down speed in order to keep at a respectful distance.

Almost everyone smoked and smoked vigorously, the combustibles supplied being of every variety, from cigarette to the solemn churchwarden, while the musical programme was well rendered. Refreshments were served later at tables placed in the grill room.

Many of the best known men in the automobile world were to be seen through the fog of smoke, including Harlan W. Whipple, A. R. Shattuck, D. H. Morris, George du Cros, Dr. J. Grant Lyman, F. G. Bourne, A. R. Pardington, S. B. Stevens, E. S. Partridge, Emerson Brooks, E. B. Gallagher, Secretary Butler, A. L. Riker, E. T. Birdsall, Dr. H. Baruch, B. M. Shanley, Jr., L. T. Gibbs, B. M. Belding, Jr., S. T. Davis, Jr., R. E. Jarrige, H. R. Worthington, A. D. Proctor Smith, Clovis Bertrand, S. B. Bowman, C. R. Mabley, A. H. Chadbourne, H. M. Swetland, Paul La Croix, William Hawley, L. Lamberjack, R. A. Greene, C. A. Postley, S. D. Ripley.

A remarkable thing noticed by almost all automobilists is that horses are not, as a rule, nearly as much afraid of automobiles as their drivers.

THE AUTOMOBILE

WEEKLY

NEW YORK—SATURDAY, OCTOBER 22, 1904—CHICAGO

10 CENTS

PROPOSED MISSION ROAD IN CALIFORNIA.

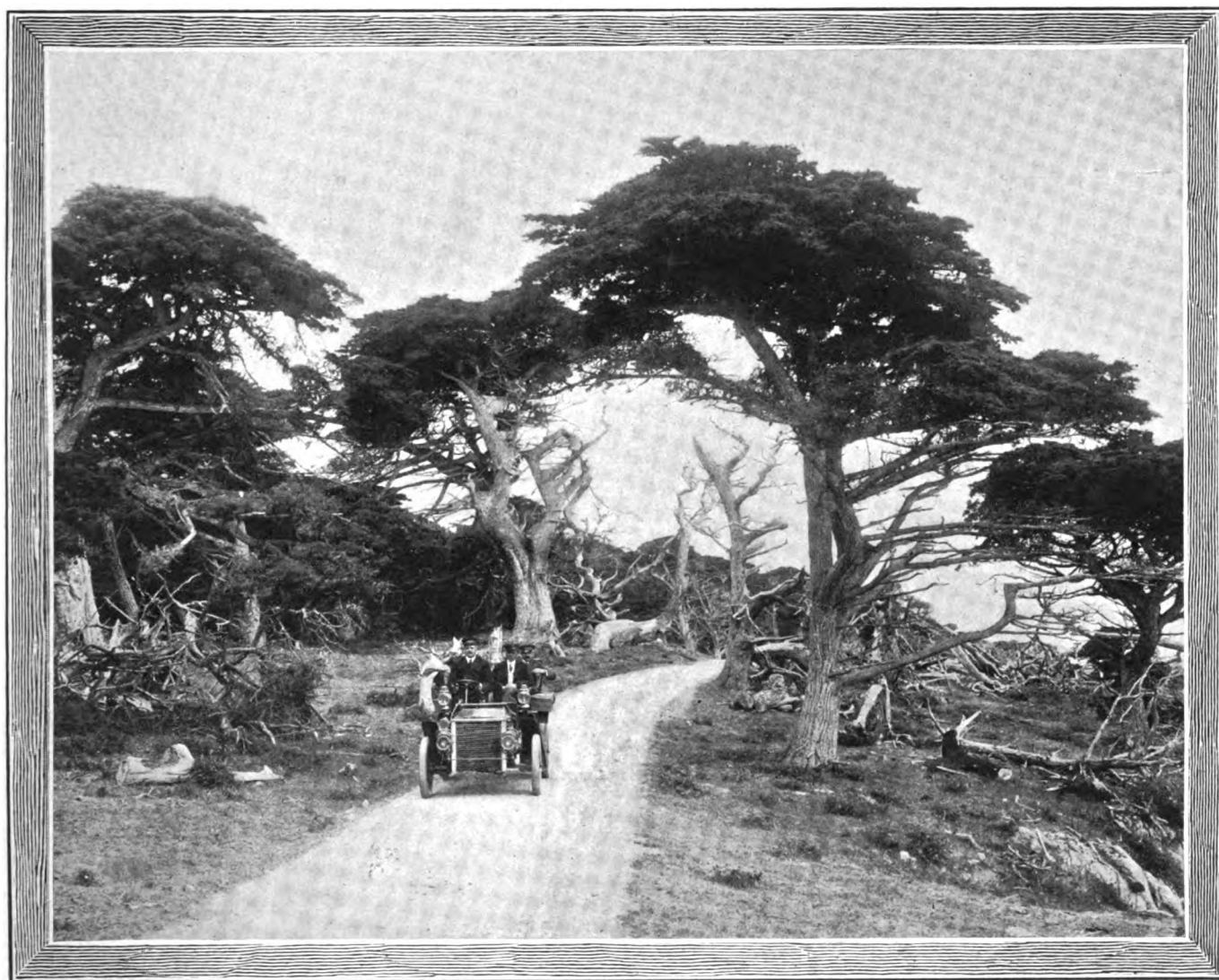

ELLIS H. PARRISH, W. J. WAGNER AND A. C. AIKEN ON THE FAMOUS "SEVENTEEN-MILE DRIVE" AT MONTEREY, CALIF.

Note the weather-worn cedar trees, which are said to be identical in species with the historic cedars of Lebanon, and are of great age. The road leads down to the rock-strewn shore of the Pacific. Monterey is one of the most beautiful of the world's watering places, far surpassing in this respect the better-known Newport on the Atlantic coast. The combination of brilliantly blue water, white sands, and dark green foliage makes a color picture that it is worth taking a very long automobile ride to enjoy.

NO other feature appealed more strongly to visitors to California from the East in the '50s and '60s than the imprint left by the San Franciscan and Jesuit fathers in their quaint and beautiful missions and the history of them. Not even the *natural wonders* of the

State and its beautiful scenery and delightful climate were more interesting and attractive. Soon after the completion of the first transcontinental railroad these century old missions, presidios and pueblos were extensively illustrated and described in the Eastern periodicals and many were the au-

thentic narratives and interesting bits of history written about them. The first of the missions was built in San Diego in 1769, and from there the religious fathers pushed on up the coast, building other large missions one day's journey apart as they went, until they arrived at and passed San Fran-

cisco. There were originally twenty-one of the missions, of which nineteen still stand, and they were connected by a trail nearly 700 miles long that wound in and out of the hills to avoid grades that were too steep for the fathers' horses and cattle. This old trail or road is just now the subject of a great deal of interest, as the advent of the automobile has given renewed life and impetus to a movement started nearly a score of years ago to reconstruct this old road and preserve the missions from further deterioration, even if not to repair them.

The rehabilitation of this old road, called by the Spanish fathers "El Camino Real," the royal road, or less literally, the King's highway—was proposed as long ago as 1887 or 1888 by Miss Anna B. Pitcher, who suggested that it be made a boulevard, and much attention has been given the project both in California and in the East. After many years of agitation and foundation laying by Charles F. Lummis, B. W. Hahn of Pasadena, the Landmarks Club, Mrs. A. S. C. Forbes, chairman of the history and landmarks section of the Women's Federated Clubs, the Chamber of Commerce of Los Angeles, the Pasadena Exhibition Association, and many others, sentiment is crystallizing on the boulevard idea. The movement has been gathering force year after year until now, with the greatly enhanced resources of the State, and with the county boards of supervisors, the State and government officials, the automobile clubs of San Francisco and Los Angeles and many influential individuals interested, the early culmination of the project in tangible form may be confidently expected. Committees appointed by these organizations are getting into working order and the first appropriations for starting the work will be forthcoming soon.

There is a division of opinion as to the course that the reconstructed road should follow: The more sentimental of those interested wish to have it adhere as closely to the old government road of Spanish California from San Diego to San Francisco as is consistent with the building of a good drive, touching all of the nineteen remaining missions, restoring them as in the days of the padres, preserving the Spanish name "El Camino Real," and placing monuments at historic spots to record its history. The more practical ones advocate building a more direct highway connecting the northern and southern parts of the State, utilizing the route of the old road where it can be done with advantage and touching at as many of the missions as the elimination of undesirable detours and severe grades will permit. The consensus of opinion and sentiment seems to favor the former plan, however.

The entire cordon of missions extends for a distance of about 700 miles, and in the old days the traveler could hear matins in one mission and vespers in the next. Of the twenty-one missions in upper California, founded by the College of San Fernando in the City of Mexico, Santa Cruz and San

Rafael, are now missing. Three of the existing nineteen lie to the south of Los Angeles, these being San Juan Capistrano, founded in 1776; San Luis Rey de Francia, 1798, and San Diego de Alcalca, 1769. The remaining sixteen are all north of Los Angeles and may be reached by a county road which in many places is the old "Camino Real" and which could be made to conform to the projected boulevard

The first of the old pueblos was established at Los Angeles, there being two missions in what is now Los Angeles

Much of the original road from San Fernando to Ventura across the range is obliterated, mining men and oil prospectors having made new branches and surveyors and supervisors having laid out new cut-offs, so that it would be somewhat difficult to strike out the exact highway there, but no doubt some of the old Spanish settlers could give reliable information. The mission at Ventura—San Buenaventura Doctor Serafico—was founded in 1782. There are many mementos of former greatness well worth seeing there.

Next on the route is Santa Barbara County, which has three missions within its boundaries. And one of them, Santa Barbara Virgen y Martir, founded in 1786, is perhaps the most noted of all the Franciscan missions. About thirty miles in a westerly direction following the original highway through a strip of plain brings the traveler to Santa Ynez and the mission Santa Innes, Virgen y Martir, founded in 1804. North from there thirty miles is La Purissima Concepcion (The Immaculate Conception), founded in 1787. These two are off the main lines of travel and are reached only through very mountainous country, but both are interesting examples of their builders' art and differ greatly from those farther south.

The route of El Camino Real through the Santa Maria Valley and over the mountains to San Luis Obispo is still used as the most direct highway, and here is found San Luis Obispo de Tolosa, founded in 1772, which has been somewhat modernized, although a portion of it still remains as of old. Thirty-one miles farther north on the road is San Miguel and mission San Miguel Arcangel, founded in 1797, which was the half-way house between San Diego and San Francisco.

Monterey county has three missions distant some thirty miles apart, and at the first of them, San Antonio de Padua (1771), Father Junipero Serra is buried. The other two are Nuestra Señora de la Soledad (1791), and San Carlos Borromeo de Monterey (1770). All are in their old state and the original road connects them.

Northwest from the present city of Monterey the road passed through what is now the main business street of Salinas to the mission San Juan Bautista (1797), whence it wound northeasterly through the hills in the vicinity of Pajaro and Watsonville to Santa Cruz (The Holy Cross), founded in 1791. Crossing the Santa Cruz mountains toward San José, the old road is not opened all the way, but it can possibly be made passable from Mission San José de Guadalupe (1797), and on to Santa Clara. The route here winds through some of the most magnificent of California's marvelous scenery to the mission Santa Clara Madre Serafica (1777). In the old journey from San José no suitable site was found until San Francisco was reached, and there was founded in 1776 San Francisco Padre Serafico. The royal road is still open and used all the way to this mission from San José,

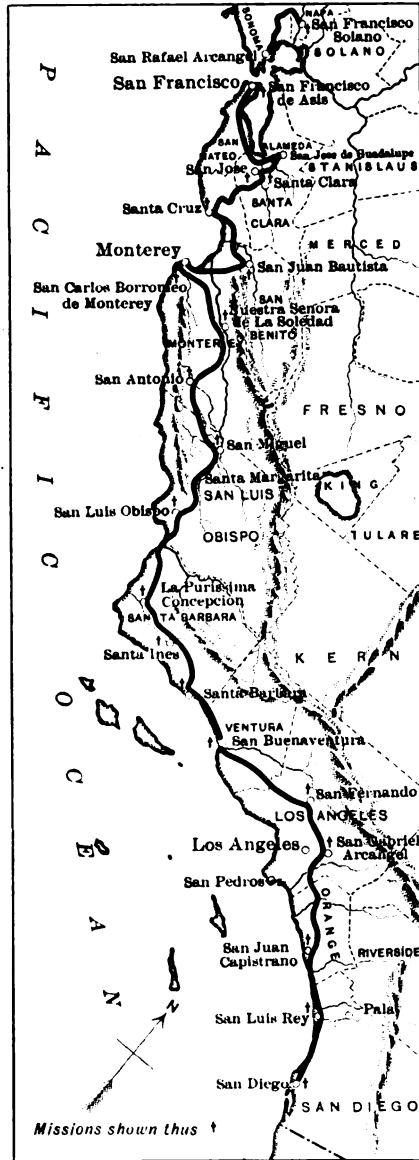

MAP OF ROAD TO CONNECT CALIFORNIA MISSIONS.

county, the first, San Gabriel Arcangel founded in 1771, at San Gabriel, about about eighteen miles northward and reached by what is now a fairly good road; and the second, San Fernando Rey de España, at San Fernando, founded in 1782 and about twenty-five miles from Los Angeles, west of north from San Gabriel. Coming in from the south to this mission the tourist will note for several miles of the distance beautiful groves of live oak trees fantastically draped with Spanish moss.

San Miguel Mission, Half-way between San Diego and San Francisco.

Santa Barbara, One of the Most Noted of the Franciscan Missions.

San Gabriel Arcangel, Founded in 1771, First of the Old Pueblos.

SOME OF THE MOST FAMOUS AND BEST PRESERVED OF THE CALIFORNIA MISSIONS TO BE CONNECTED BY THE PROPOSED STATE "ROYAL" ROAD.

San Fernando Mission, Near Los Angeles, Established in 1797.

San Diego de Alcalá, Founded in 1769, at which Proposed Road Will Start.

Dolores, San Francisco, at the North End of "El Camino Real."

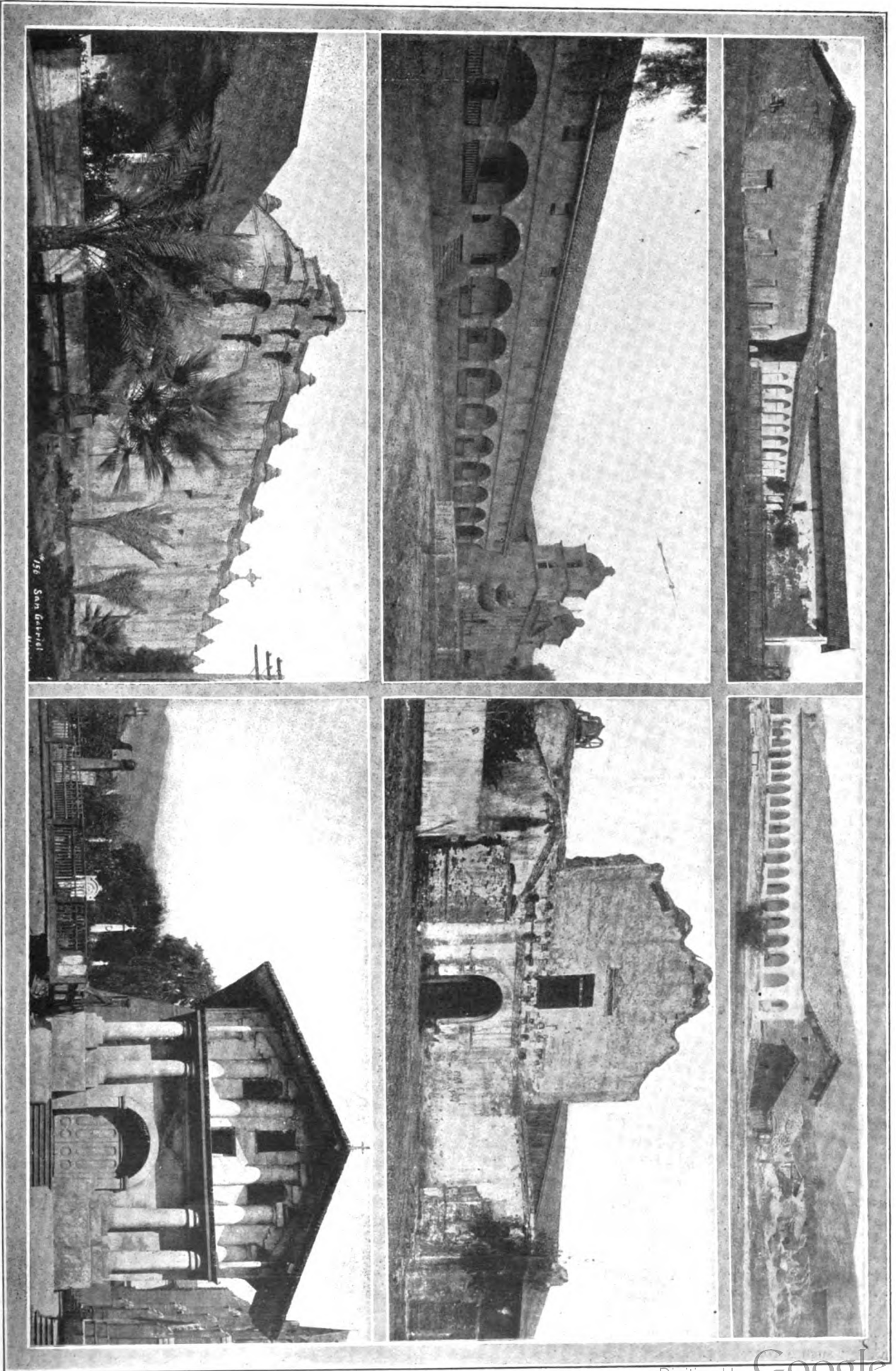

passing through Palo Alto, San Mateo, Milbrae, and almost all of the present towns on the Southern Pacific Railroad. From the present mission site to the present presidio the road has been converted into city streets, but old maps show it plainly. Thence it is open to San Rafael, Mission San Rafael Arcangel (1817), and passes in front of this structure. There it takes the last turn toward the mission San Francisco Solano (1823), where ends the Royal Highway of the padres of early California, which some day will be the famous highway.

Timed by an Expert.

An interested spectator of the Vanderbilt Cup race was Professor Willy G. H. Pfitzner, a German technical scholar, who is making a study of American automobiles and automobile manufacturing methods. Professor Pfitzner came from St. Louis to see the race, and spent most of the time while the contest was in progress at the Hicksville control. Wishing to get an idea of the comparative speed of the machines, Professor Pfitzner and a companion measured off a test piece of road, about a mile and a half out of Hicksville, where there was a slight down grade, and on which the cars were likely to make good running. The timing was done carefully with stop watches, and while it may not be absolutely accurate with regard to the actual speed of the cars, owing to the shortness of the measured distance, a pretty close comparison can be made. The road was in the open country and was straight and clear—in fact, an almost ideal stretch for high speed. The figures obtained are as follows:

	Miles per hour.
Mercedes, 60-horsepower, driven by Campbell	73
Pope-Toledo, 24-horsepower, driven by Lytle	55
Clement-Bayard 80-horsepower, driven by Clement.....	65
Panhard, 90-horsepower, driven by Heath	83
Panhard, 90-horsepower, driven by Tart	63
Pope-Toledo, 60-horsepower, driven by Webb	63

The 24-horsepower Pope-Toledo was timed again later, and found to be running at 52 miles an hour. Heath made the round beginning and ending at the spot where this timing was done in 36 minutes 30 seconds; or 27 minutes 30 seconds after deducting the neutralized time in controls. A noticeable feature of Heath's driving was that he almost never swerved from a straight line except, of course, where the road curved.

Professor Pfitzner, who has been connected with the Cannstadt Daimler establishment, expressed surprise at the sustained speed of the small American cars in the race, stating that he had not expected to find American cars able to stand up so well in such a contest.

Physician's Experience with a Runabout.—III.*

By HARRY W. FREEBERG, M.D.

THE steamer docked in the Chicago River at noon, and we managed to get to the City Hall without being stopped by a policeman for having no license number. There we sought a certificate, and after finding the proper authority, I passed the examination he gave me. Then he extended without charge a temporary permit to pass through the city until August 10. This I was told was a courtesy the city extended to visitors; but, as no number was given with the permit, I was stopped on several occasions by policemen, all of whom tried to convince me that such a permit was good any place in town except on the particular street on which we were driving at the time. This was the argument given in Lincoln Park, on Sheridan Road and on Michigan Avenue, but as the permit mentioned no exceptions, I proceeded to ride where I chose.†

Three days were spent with relatives and friends in the charming little city of Evanston. We had several outings and took a number of long rides north along the lake shore on the beautiful Sheridan Road.

ACCIDENT NARROWLY AVERTED.

The cyclometer registered 363 miles when we decided, on Sunday, August 9, to begin the homeward journey. The running we did in Evanston amounted to 113 miles. We dined in Chicago and roved about a bit in the parks, taking a last long look when we should have been on the road homeward. So it was 1.30 p. m. when we pulled out of the Windy City, making our way south through Blue Island and Harvey. One can appreciate the miserable state of these roads only by riding over them in an automobile—or on a bicycle. Some places our only resort was to keep all four wheels on the street car rails. Beyond Mattison the road had two beaten tracks: one of dirt fully twenty-five feet from the other, which was of gravel. We were sailing along down this pike at a fast clip when we met a horse and buggy, but as they were on the dirt track and we were on the gravel, we did not slacken the speed of the auto, which must have been going thirty miles an hour. Upon coming within about sixty feet of the horse, he suddenly started over toward our track. I was badly frightened, for it seemed impossible to prevent a collision with the animal, as the bank on the other side of the highway was a steep declivity. Seeing no alternative, but to run down this bank or into the horse, I chose the bank as the lesser evil. The car ran on two wheels for a time when it hit the bottom of the bank; then I turned and ran it up into the road

again as quickly as we had gone down, and everything and everybody got through safely; but I never want to risk running down such a steep bank again. We never even stopped the machine, and in half a minute it was all over and we had avoided what at first seemed to be an inevitable and disastrous accident.

LUDICROUS HORSE AND BUGGY ACCIDENT.

We had just been congratulating ourselves upon the narrow escape some time later, when, as we were about to enter the village of Momence, Ill., we had our first real horse and buggy accident, for which we felt that we were slightly responsible. The road was fairly wide at that particular place but there was a rather steep grade, and upon meeting a horse and buggy we slowed down but did not stop. The horse shied and turned the Dutchman, who was driving, and his wife over in the ditch. Then we saw that there was another rig coming directly behind them. This one contained a man and woman and seven children. The driver excitedly dropped his reins, sprang from the vehicle and ran to the assistance of the Dutchman and his wife, who were lying quietly enough in the top of the upset buggy studying a way to get out. Their horse was lying peacefully on his side as if asleep. But the woman with the seven hopefuls and the badly frightened horse in front of her with the lines lying on the ground was not at ease, nor had she reason to be. We could not stop the runabout until we were right by the side of her horse. Fortunately, my companion jumped out and seized the horse's bit before he did any harm, and I went back to the aid of the people in the ditch.

Then the ludicrous side of the catastrophe began to develop. The Dutchman and his wife had managed to get upon their feet and were standing one at each end of the horse, trying to get him up without having first unharnessed him. The animal did not attempt to rise, so we relieved him of harness and shafts and he promptly arose. After an intensely interesting conversation treating of cause and effect and responsibility, we harnessed the horse again and discovered no damages of consequence beyond some slightly injured feelings. After taking their seats in the buggy the Dutchman asked me if I was going to pay damages. In vain I tried to convince him that there were none to pay for and that I was not liable anyway. Then he propounded the following ultimatum:

"You pace me damachom or I suse you."

At first I could not understand whether he meant that he would sue me or shoot me, but I took a chance and told him to crack away. He must have misunderstood, for he jerked out his whip and hit the horse a crack that sent him flying down the road at a vicious gait.

* Continued from Page 377, issue of October 1, 1904.
† These drives are all in the park system, over which the city has a control, the South Park Board of Commissioners making the speed and police rules for the parks and boulevards on the South Side and the Lincoln Park Board, appointed by the Governor of Illinois, those for the North Shore Drive, Lincoln Park and Sheridan Road.—Ed.

A brief stop was made in Peotone to visit an old classmate and at 5 o'clock we pulled out for Kankakee, Ill. In Peotone the rod connected with the needle valve controlling the flow of gasoline entering the carbureter broke off in the stay holding it over the flywheel. Securing a piece of heavy wire from a local hardware man, I managed with his help to improvise a substitute for the broken piece that answered the purpose very well.

AN AWKWARD SITUATION.

It was a little after dusk when we arrived safely and without further incident in Kankakee, where we registered under the assumed names of F. Jackson and J. Blake, fearing that the Dutchman might follow us or telephone to have us arrested. He did not know our names, but could get them in the town we had passed through just before the accident. After supper we went out to see a carnival which was in progress, and returned to the hotel about 9.30. The proprietor started upstairs to show us to our rooms, but when near the top stopped to ask us what numbers we had been assigned to. We told him none had been given us. Saying that he had confused us with two other guests, he started down again to refer to the register. Then he turned hastily and asked our names. We had forgotten all about our aliases until thus suddenly reminded, and then for the first time in my life I could not tell my name. My companion was in the same fix, for he looked at me and turned as red as a beet. No doubt his color was reflected in my own physiognomy. I attempted to look carelessly at the proprietor while I asked him what he had said in an endeavor to gain more time to recall the assumed name. Fortunately, by the time he had repeated the query my lame memory had got into good working order and I was able to give him the names. The awkward hesitancy did not appear to arouse any suspicions and the proprietor then proceeded to locate us for the night.

A FINE RUN ON THE LAST DAY.

Although the road from Kankakee the following morning was dry, it was heavy with dirt and sand, so that the runabout could make only from twelve to fifteen miles an hour. It was noon when we reached Fowler, having traveled by way of Aroma, St. Mary, Donovan, Sheldon and Kentland. The roads were ideal thereafter all the way from Fowler to our homes in Lafayette. The little car seemed to run as never before, and we were only one hour forty minutes traversing the distance, registered as thirty-six miles by our cyclometer. The streets of Lafayette were crowded with people when we arrived at 3 o'clock, the occasion being a carnival—the third that we had encountered on the trip.

Following is a summary of the tour: Longest distance run in one day, 113 miles; Longest distance run on low speed almost continuously, 11 miles; Greatest distance

on one filling of water tanks, 200 miles; Greatest speed rate, from Lafayette to Monitton, 8 miles in 20 minutes, or 24 miles an hour; Total amount gasoline used, 21 gallons; Total number miles run, 535; Average number of miles on one gallon, 25 1-2.

REQUISITES FOR COMFORTABLE TOURING.

Although we had very little trouble with the machine on the trip, I would not undertake such a tour again without carrying an extra tire, a tire repair outfit, a good apron for the engine and a storm apron covering the entire vehicle and protecting the occupants. I would not carry a top. Notwithstanding I used a chain boot, there was no apron under the engine and the sand worked into the chain and caused it to wear considerably, so that it became necessary later in the summer to get a new chain and front sprocket.

The runabout has been of much service to me in my practice as a physician. I use it for nine or ten months in the year. When called out in the night I have merely to go to the barn, light the lamps, seat myself in the machine, turn the starting crank, and away I go in five minutes. Upon returning, the rig is run into the stable, the lights turned out, and I can go into the house. There is no horse to unharness and perhaps rub down, if it has been a bad night. As a practicing physician, I can conceive of nothing more convenient as a means of transportation. Certainly the automobile is a specialist on hurry-up calls and long runs into the country.

SEASON'S EXPERIENCE DELIGHTFUL.

My season's experience with a light runabout has been a delightful one. Tires have

been the cause of four-fifths of my troubles, and I hope it will not be long before our tire makers solve this problem. No doubt much of my success with the machine is due to the fact that I have a natural bent toward mechanics and give prompt attention to any part that seems to be in need of cleaning or adjustment.

For both convenience and pleasure nothing that I know of would be more acceptable to me than my little runabout, unless, indeed, it were a four-passenger automobile,—for the pleasure to be derived from the use of a car would be enhanced in proportion to the number of persons who could share in its delights.

(Concluded.)

AN AUTO BOAT ROMANCE.

A story of how an auto-boat overhauled an ocean steamship comes from Southampton, England. It seems that a woman passenger who embarked on the steamer *Orinoco*, for the West Indies, recollected just as the ship was about to depart, that she had left some valuable jewels at the hotel. Her friends drove in haste to the hotel and secured the valuables, but on their return to the pier the vessel was growing dim in the distance, the officers having declined to delay departure. Just at this moment, like the orthodox stage hero, *Napier Minor* appeared on the scene, skippered by Mr. Evans, who was hailed, and the situation explained to him. The custodian of the jewels was immediately taken aboard, and after a hot chase the *Orinoco* was overhauled and the precious bag hoisted aboard by a rope, amid the cheers of the passengers.

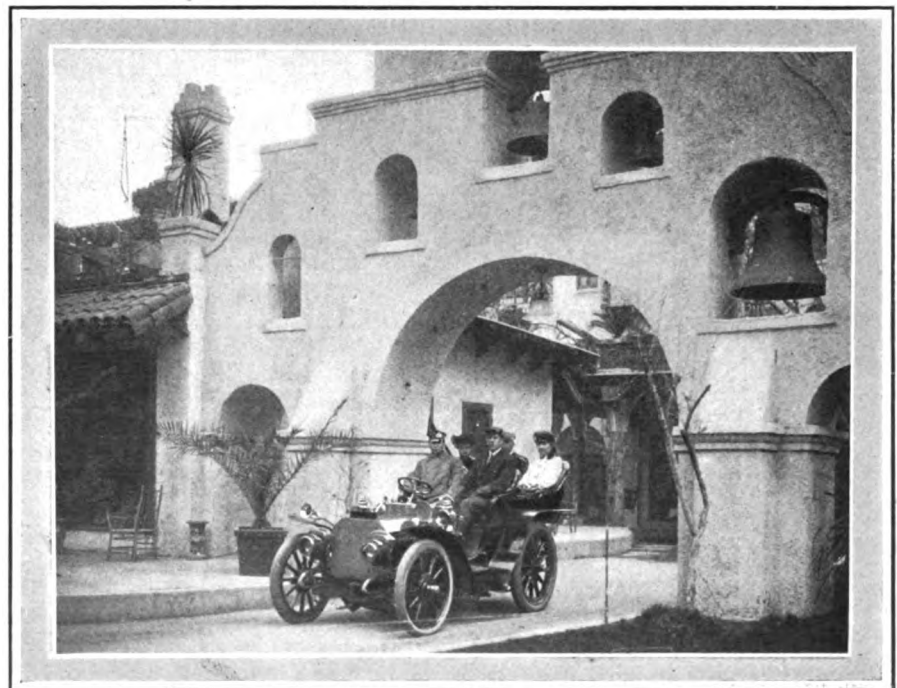

The photograph reproduced above shows H. C. Merritt, of Pasadena, Cal., with a touring party in his 40-horsepower Mercedes, leaving the Glenwood Hotel, in Riverside. There are some splendid roads around Riverside, which make it a veritable paradise for automobilists. More than half a hundred motor cars are now owned by Riverside business men.

Suggestions for the Inexperienced.*

Individual Clutch and Planetary Change-Speed Systems Explained in Simple Terms for Benefit of the Novice.

By A. D. RIVER.

THE seeming barbarity of the sliding gear system of forcibly bringing into engagement two gears moving at different peripheral velocities led to the development, in many of the earlier American vehicles, of the "individual clutch" system, in which the gears for all of the speeds are constantly in mesh, but those on one shaft are normally free to rotate on it until rigidly connected thereto by friction clutches, of which one is provided for each gear on that shaft.

Because the sliding gear system has proved in practice less destructive of the gears than was at first anticipated, and because it wastes less power in friction than a system having (including the gears for reversing) three or four pairs of gears and as many friction clutches constantly running, there are now but few machines in which individual clutches are used. These, however, are the survivors out of many less fit, and it is but fair to say that most of the machines using them are popular and in good sale. One that is perhaps the most representative of these systems has been selected for illustration—Fig. 1.

Connected with the flywheel hub by a slightly loose coupling is the driving shaft *A*, on one end of which turns loosely a bushed sleeve *B*, connected at one end to a gear *C* and at the other to a web *D*, to which is bolted part of a universal joint *E*, from which power is delivered to a "propeller shaft," not shown. Keyed fast to the end of *A* is a disc *F*, and at *G* is a disc with conical rim, held from rotating on *A* by a key, but free to move slightly lengthwise. An adjustable threaded collar *H* carries three dogs *I*, which may be acted upon by a sliding thimble *J* in such wise as to force disc *K* to the right against three loose pins *L*, forcing them against *G* and pushing *G* into an internal cone in *C*. Further movement of the thimble to the right draws *F* up hard against *D*, and the "tails" of the dogs ride up on the cylindrical portion of the thimble, which will now stay in position. The sleeve *B* and universal joint *E* now turn with *A*, giving the high speed.

For the slow speed the upper clutch is released and the similar clutch *M* on the jack-shaft *N* is engaged. The drive is now through gears *O*, *P*, *Q*, and *C*, with a reduction of speed in each pair. The reverse is obtained by an intermediate pinion between gears *R* and *S*, both of the forward motion clutches being released and clutch *T* engaged.

On account of the necessarily small size of the friction clutches where there is one

clutch to each gear change, metal to metal rubbing surfaces are always used, as they will bear high pressure and are not so easily injured by heat as surfaces of organic substances such as leather or fiber. They are always oiled to minimize the unavoidable slight friction when disengaged, but the amount of oil used must be small to avoid slipping at the wrong time.

Another individual clutch system which, although it is not typical of a class, can hardly be passed unnoticed, is that used in the Haynes-Apperson cars. It is remarkably ingenious, very durable, and very eas-

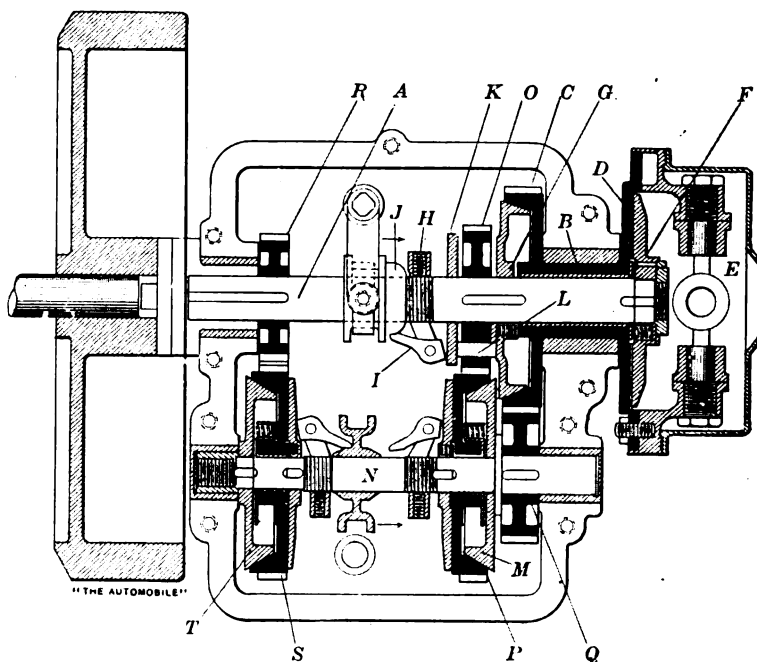

FIG. 1.—SECTIONAL DRAWING OF WINTON INDIVIDUAL CLUTCH SYSTEM.

ily kept in order. It has been used for several years with slight changes. It gives three forward speeds by gearing and a reverse by a Renold "silent" chain instead of by the usual intermediate pinion.

On the driving shaft are keyed three spur pinions of suitable sizes, meshing with gears loose on the driven shaft, and one sprocket pinion and wheel are suitably connected for the reverse. The character of the clutches connecting the gears and sprocket wheel with the driven shaft is essentially that of an external band, secured at one end to an arm turning with the shaft and tightened on the drum by the action of a lever and pawl on the free end of the band.

In Fig. 2, which shows the form of the clutch used in older models, *a* is a hollow drum fixed by a key to the shaft and having an arm *b*, to which one end of the band *d* is riveted. This band surrounds a drum

i, with a large hub which turns loosely on the drum *a*, and with a web to which is bolted the gear *j*. The end of a second drum *a'* comes against *a*, and a third and fourth drum, each carrying a loose hub and drum similar to *i*, with the appropriate gears, complete the provision for the several speeds.

Each of the bands *d* has riveted to its free end a narrow extension *e*, whose end is turned up radially and has in it a set-screw *f* and lock-nut. The end of the set-screw bears against a tappet *h* slipped over a squared portion of a short shaft, integral with arm *g*. By swinging this arm away from the observer, the tappet is pressed against set-screw *f* and *d* is tightened on *i*. This movement of *g* is accomplished as follows: The left end of each hollow drum *a* is closed by a plate *k*, having four slots as shown. The several arms *b* are disposed

90 degrees apart around the circle, so that the several slots register properly; and through each set of slots runs a long finger, shown in detail in Fig. 3, having a cam enlargement at its end. These fingers are connected at their left ends and operated by a shifter connected with a hand lever. They are of different lengths, and each finger, by its enlarged end, deflects one of the arms *g*, the lengths being so proportioned that only one arm is acted upon at a time.

The part sectional view, Fig. 4, shows the 1904 clutch, the same reference letters being used. It will be seen that parts *a*, *b*, *d*, and *e* are now united in a one-piece steel casting, and *i* and *j* are in a single bronze casting. The steadying arm *c* is omitted, and lubrication is provided for efficiently by the self-closing oiler *l*. Two of the long tightening fingers are shown, *m* being the enlarged end of one.

*Continued from page 283, issue of September 10, 1904.

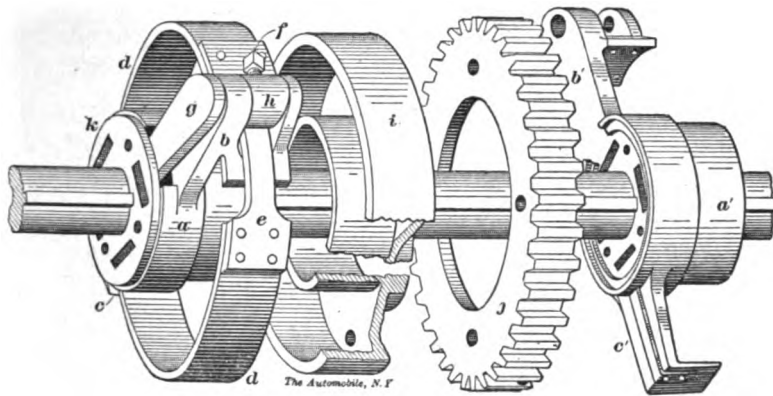

FIG. 2.—EARLY FORM OF HAYNES-APPERSON BRAKE BAND INDIVIDUAL CLUTCH SYSTEM.

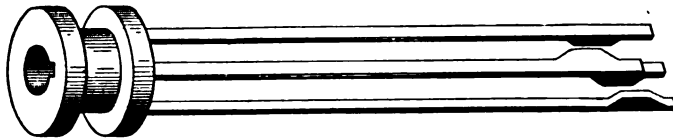

FIG. 3.—CAM FINGERS FOR TIGHTENING THE SEVERAL BANDS

PLANETARY CLUTCH SYSTEM.

A system allied to the individual clutch system but considerably less easy for the novice to understand, is that known as the "planetary." It is used in many of the most popular light vehicles and in many forms, of which that shown in Fig. 5 is fairly representative. It gives, like the mechanism just described, two speeds and one reverse, and the high speed is that of the engine shaft, which, as in the preceding, extends right through the gear.

Turning loosely on the shaft is a casting A of peculiar form. It has a long central hub, its periphery is turned off smooth, and in it are four hollow bosses B, each cut away on the side toward the shaft. A disc C, having its periphery shaped into a frustum of a cone and faced with leather, is rigidly secured to A at a little distance

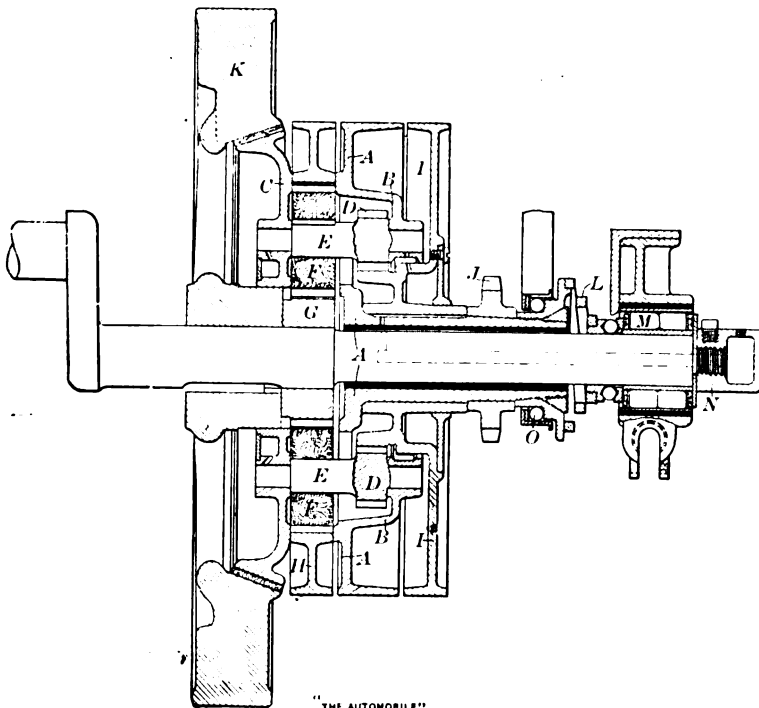

FIG. 5.—RAMBLER PLANETARY CHANGE-SPEED GEARING, GIVING TWO FORWARD SPEEDS.

therefrom by means of bosses and bolts, not shown, between the bosses B. Pinions DD are cut on short shafts EE which turn in bearings in B and C, and on EE are keyed fiber pinions FF, larger than DD. Pinions F mesh with a central pinion G, keyed on the shaft, and with an internal gear cut in ring H, which turns loosely on the pinions and has no central bearing. Pinions DD mesh with a spur gear cut on a flange or disc I, whose hub turns freely on the hub of A. Secured on the hub of A by a taper fit and key is the sprocket pinion J, which therefore turns with disc C. This disc constitutes one member of a conical clutch, as its leather-faced rim fits an internal cone in the rim K of the flywheel. This is the high-speed or direct-driving clutch, which imparts to the sprocket pinion the speed of the engine. It is normally engaged by the conical spring L, the thrust of whose small end is sustained by the inner sleeve of roller bearing M, which sleeve is

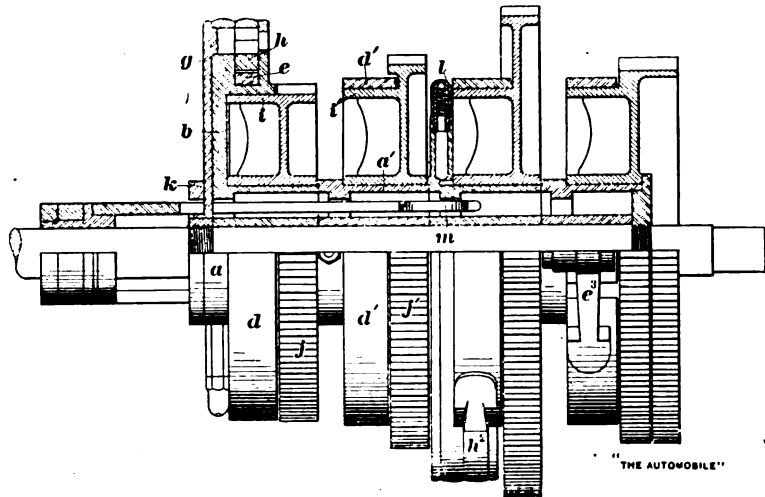

FIG. 4.—PART-SECTIONAL DRAWING OF LATEST FORM OF ABOVE SYSTEM.

supported against the spring thrust by collar and nut N. As these latter are fast to the shaft, which in turn is fast to the flywheel, it is evident that the end thrust of the spring is "self-contained" when the clutch is engaged, and the ball-thrust bearing turns as one piece.

The clutch is released by pressure to the right on ball-thrust bearing O, which carries the whole mechanism from O to C bodily a fraction of an inch to the right, leaving the flywheel as it was.

When the clutch is engaged the whole mechanism turns as one piece, there being no relative motion in the gears and pinions. To actuate the slow forward speed, the clutch is released and a friction band, not shown, similar to a brake band, is tightened on the outer rim of H, compelling the latter to remain stationary. The effect of this is to cause pinions FF to roll around in the internal gear of H, carrying with them the shafts EE and parts C and A, to which J is attached. The linear velocity of the center lines of FF will be one-half that of the teeth of pinion G, and as the circle in which the former travel is much larger

than the diameter of *G*, the speed of *C* and *A* in revolutions per minute will be correspondingly less than half that of *G*. By scaling it is found that the speed of *A C* will be about 0.27 that of *G*.

To reverse, the friction band on *H* is released, also the clutch—if engaged—and another band is tightened on the rim of disc *I*, rendering stationary the spur teeth with which pinions *DD* engage. The action now is a little more complicated but may be understood by considering pinions *F* and *D* collectively as a lever whose fulcrum is at the meshing teeth of *D*—nearest the main shaft—and one end of which is the innermost teeth of *F*, to which power is applied by *G*. The other end of the lever is the center of the shaft *E*, whose motion is therefore opposite to that of *G*, and whose linear velocity—since the "pitch line" diameter of *D* is one-half that of *F*—is exactly the same as *F* at the pitch line of the teeth. The reversing speed in revolutions per minute, therefore, is to the speed of *G* inversely as the ratio of the diameter between centers of *EE* to the pitch diameter of *G*.

The third band on the rim of *A* is used as a brake, and in case of its failing, the reverse friction band may be employed. The regular emergency brakes are provided on the rear hubs.

Lubrication is provided for by introducing oil through a plug into the hollow nut *N*, from which it finds its way by the drilled hole (dotted) in the shaft, first to an oil groove in the sleeve hub of *A*, thence out to a similar groove in the hub of *I*, and finally by the drilled holes shown to the right-hand bearings of *E* and to pinions *D*. The left-hand bearings of *E* are separately oiled. Pinion *F*, being of fiber, needs no oil.

There are many varieties of planetary gear devices, some simpler than the one just described and others more complicated. Nearly all give, besides direct drive through the clutch, one slow and one reverse speed only. An intermediate speed has been found undesirable because in any but the high speed all the gears are in relative motion and the friction, even of the gears through which no power is being transmitted, becomes a serious item when the necessary gears for an intermediate speed are added. There are in addition numerous rubbing surfaces at a considerable radius from the shaft, and therefore working frequently at considerable velocities, which still further reduce the useful power. For these reasons the use of the planetary gear is restricted to runabouts, in which, if the engine speed is moderate, they are very satisfactory, and to the lower-priced road and light touring cars.

(To be continued.)

Madam Du Gast, the daring French chauffeuse, has passed a successful examination in the handling of a motor-boat on the River Seine, and expects to participate in auto-boat racing next season.

Dourdan Speed Trials.

Special Correspondence.

PARIS, Oct. 4.—The races at Dourdan, on October 3, organized by *Le V'elo*, proved a great success. Although the previous day had been wet and the roads in the forest were not all that could be desired, several records were broken. The event of the day was the performance of Lanfranchi, in the kilometer motorcycle race, flying start. On a Peugeot of less than 50 kilos, the kilometer was covered in 29 1-5 seconds, thus creating the world's record. Cissac, also on a Peugeot, covered the kilometer in 30 1-5 seconds. A speed of 123 kilometers (76 1-4 miles) an hour is remarkable when it is remembered that the cycle complete, with motor, frame and transmission, weighs only four kilos (8.8 pounds) per horsepower.

KILOMETER, STANDING START.

In the kilometer with standing start La-

Voiturettes—De La Touloubre (Darracq), 1:15 3-5; D'Hespel (Corre), 1:38 3-5.
Light Automobiles.—Hémery (Darracq), :59 4-5.
Automobiles.—Barras (Darracq), :52 1-5; Duffaux (Duffaux), 1:03 2-5.

PROPOSED OCEAN SPEEDWAY.

Special Correspondence.

SAN FRANCISCO, Oct. 12.—A proposition made by Reuben H. Lloyd, a member of the Park Commission, offers to local automobilists an opportunity for a speedway which seems likely to be received with enthusiasm. Mr. Lloyd proposes that, if the automobilists, either individually or through the Automobile Club of California, will raise \$6,000 the commissioners will undertake to widen the Ocean Boulevard, along the ocean front, to 200 feet for its entire length of two miles, and set apart one-half the width for automobiles.

The location, along the edge of the Pa-

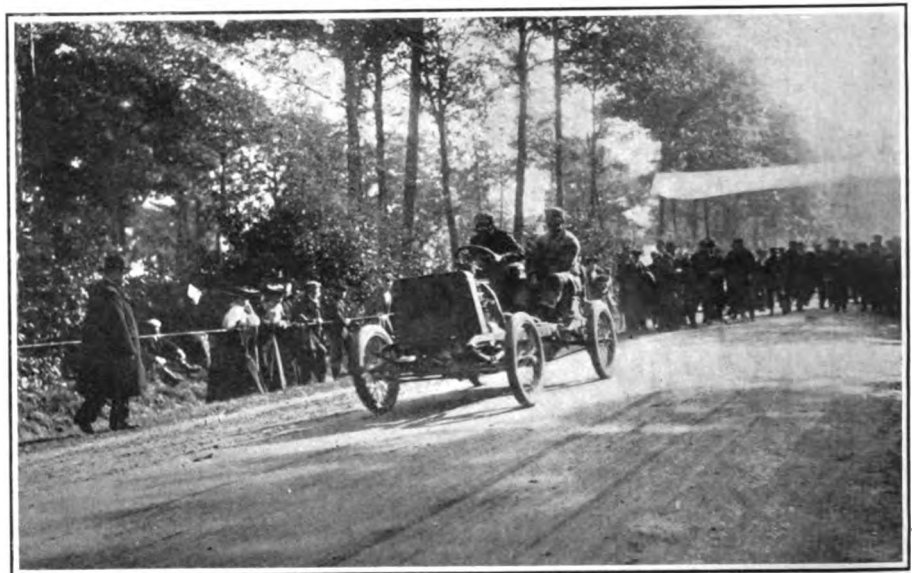

HEMERY WINNING LIGHT CAR SPEED TRIAL ON DOURDAN COURSE.

franchi (Peugeot) was again first, time 57 4-5 seconds.

All the other events, including kilometer and mile trials for voiturettes, light cars and heavy cars, were won by Darracq cars.

Following are the best times:

KILOMETER, FLYING START.

Racers, motorcycles of less than 50 kilos (110 pounds), Lafranchi (Peugeot), :29 1-5 world's record; Cissac (Peugeot), :30 4-5; Lamberjack (Griffon), :35 2-5.

Voiturettes (250 to 400 kilos, 550 to 881 pounds)—De La Touloubre (Darracq), :36 1-5; D'Hespel, :47 1-5.

Light automobiles (400 to 650 kilos, 881 to 1,432 pounds).—Hémery (Darracq), :29 2-5; Coquard (Corre), :39 4-5.

Automobiles (650 to 1,000 kilos, 1,432 to 2,204 pounds).—Barras (Darracq), :25 1-5; Duffaux, :30 2-5.

MILE RACE, STANDING START.

Motorcycles.—Lafranchi (Peugeot), :57 4-5; Olieslagers (Minerva), :02 3-5.

cific Ocean, with Golden Gate Park on one side, is superb. Car owners who like to test the speed of their machines would have an opportunity to do so over a fine piece of straightaway road without danger to other vehicles and without being called to account by the authorities.

The present surface of the boulevard is excellent, but the drive is too narrow. Mr. Lloyd believes that the speedway would have a tendency to do away with fast driving on the park roadways, and that the sight of cars being speeded along the edge of the ocean would prove an attraction to the thousands who visit the beach.

A proposition has already been made to a number of automobile owners for the construction of a toll road for automobiles between San Francisco and Redwood City. While the Ocean Boulevard speedway would be much shorter, it would be far more easy of access and seems a more feasible proposition at the present time. The cost would be very much less.

Juvenile Automobile Racing.

The influence of the automobile on the younger generation is occasionally evident in the streets of American cities, where the typical vehicle of the street urchin, the home-made combination of four old wheels, two axles and a board, is fitted with a wheel for steering and perhaps an old bicycle lamp or two. The accompanying picture shows that France still leads the world, even in this humble class of motor car. The vehicles shown were assembled to take part recently in a contest on the hill of Champigny, in the suburbs of Paris, there being prizes for speed, elegance, mechanical construction, and the skill of the operator, as in any well ordered automobile meeting.

The competing cars, which are evidently home-made, have no motors, and in the speed test they were started at the top of the hill, coasting down. The little mechanics are sufficiently skilful to imitate in proportions of chassis and pattern of motor bonnet the cars of their favorite makers, such as the Richard-Brasier, Mors, Panhard, Renault and Mercedes.



ASSEMBLING FOR BOYS' RACE OF WAGONS BUILT TO RESEMBLE FRENCH RACING CARS.

Another Grade Crossing Mess.

An automobile was struck by the engine of a passenger train on the Rome, Watertown and Ogdensburg Railroad at the Evergreen Street grade crossing in Rochester, N. Y., recently, and Edward B. Cornwall, the owner, and his mother were badly hurt. Mrs. Cornwall sustained a broken rib and severe bruises, while Mr. Cornwall had a broken collar-bone and contusions. The engine hit the automobile squarely and car-

ried it along for several hundred feet before it dropped off the pilot, just before the train stopped. It is thought that the impact threw Mrs. Cornwall on top of the locomotive, her purse having been found there. It is considered little short of miraculous that both occupants of the automobile were not killed instantly.

Mr. Cornwall, who was unconscious when picked up, is reported to have said that the flagman at the crossing motioned them to

cross the tracks, with results to the car as shown in the accompanying engraving.

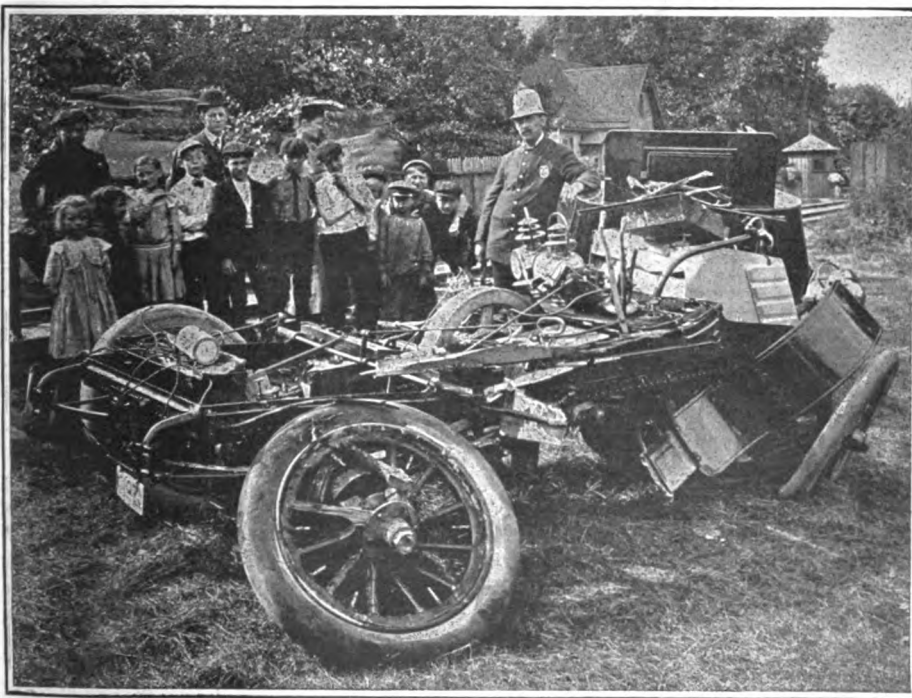

WRECK OF WINTON TOURING CAR STRUCK BY R. F. W. & O. LOCOMOTIVE IN ROCHESTER.

Semmering Hill Climb.

The Austrian Automobile Club held its sixth annual Semmering Hill Climb on the mountain roads outside of Vienna on September 25, when the cup was won from Clarence Gray Dinsmore, who has held it for the last two years, by Herr Dreher, the latter's driver being Braun, who won the cup for Mr. Dinsmore last year.

Willy Poege drove for Dinsmore this year, but was not thoroughly familiar with the course, and in addition suffered considerably from ignition troubles. The fastest time of the day was made by Braun, who was in the heavy division, and it was the fastest time ever made in this competition. Braun drove an 80-horsepower Vienna Mercedes and Poege an 80-horsepower Mercedes.

Professor Hubert von Herkomer, the noted artist, who is an honorary member of the Bavarian Automobile Club, has offered a cup which he himself will make of silver and enamel, for an international touring car competition, and has promised to paint the portrait of the winner of the cup, so that he will have a tangible evidence of his victory if he fails to repeat it in the next race. The first contest will not be held until next season.

The Sultan of Lahore, who has recently been visiting London, is an enthusiastic automobilist. His car is gorgeous with crests and coats of arms.

Echoes of the Vanderbilt Cup Race.

The departure of Heath for France early in the week, following his winning of the Vanderbilt Cup, followed by the sailing of Clement, Gabriel, Teste and Baron Turckheim, of the de Dietrich company, caused local interest in the event to quickly subside, after the smoker at the Automobile Club of America on October 11, in honor of the remaining foreign drivers.

Tart made a flying trip to the exposition at St. Louis, and as he intended to remain in America for some time, efforts were made by Manager Reeves to induce him to compete in the Brighton Beach race meet on Saturday, October 22, against Oldfield and others, but without success.

The arrival in New York last Friday of Louis Théry, winner of the Circuit des Ardennes this summer, aroused some interest, which was further stimulated by the reception to him by the Automobile Club of America on Tuesday evening. He was accompanied by G. Callois, another French driver of prominence. Their reception and Théry's remarks anent racing are reported in another column.

Clement's protest against alleged delays in controls by the officials at Hicksville and Hempstead in the race were looked upon good-naturedly, more in the light of boyish disappointment at losing the race than as meriting serious consideration, as it was apparent that by his own statement in his written protest he admitted giving to his car within the limits of the controls attention that was forbidden by the rules of the race. Clement, however, recovered his good humor before the evening of the club smoker Tuesday night.

Clarence Gray Dinsmore is still in the United States, at present visiting James L. Breese, and has fixed no date for his departure for Europe. He expects to be at the Brighton Beach races on October 22.

Frank Croker is reported to have been so well pleased with the performance of his engine and transmission in the race that he has placed an order for Simplex cars with Smith & Mabley.

The cars that broke down in the race were promptly towed into the city the night of the race or the following day.

Of the two winners, the Panhard only showed any effects of the race. The upper leaf of both front springs was broken by the bumps on the road at Queens. The Clement-Bayard was apparently in as good a condition as when it started.

The three 90-horsepower Panhard racing cars, which were sent here from France to take part in the Vanderbilt Cup Race, were shipped to France last week. They, as well as the other foreign racing machines imported for the event, were admitted free of duty with the provision that they must be shipped home within a specified time limit. It is said that one or more of the foreign machines may be sold to

wealthy Americans, in which case the full amount of customs charges would have to be paid.

Performance of the American cars was so pleasing that thought is already being given to entries for next year's contest, and to the possibilities of securing permission to use the same course, or of finding another and perhaps a better one—one, in fact, that includes some hills. It is said that the Nassau County supervisors have signified their willingness to allow the use of the Queens-Jericho-Bethpage course again.

One of the farmers viewing the cup race said: "I signed the petition of the Protective Association to the Nassau County Commissioners to prohibit the race because they told me all the cross roads would be roped off and that if I wanted to leave my house I would be prevented from doing so. I can see now what fakirs they were. Why, when that association was formed they told us they were going especially after the automobilists, and that the collection of fines would reduce our taxes. Just look at that road. It was never in such good condition, and you fellows have packed it down so that we will have a fine surface for months to come."

The big silver cup for which the great race was run, and which was on exhibition at the Garden City Hotel at the time, will remain in America for several months, Heath's hasty departure, owing to business engagements abroad having prevented its presentation to him with fitting ceremony. Mr. Heath expects to return to America during the winter, however, and it is now planned to make the presentation on the occasion of the annual banquet of the club, which will be held during the week of the Madison Square Garden automobile exhibition, January 14 to 21.

Reports from the Mineola hospital have shown a steady improvement in the condition of George Arents, Jr., whose father is reported to have expressed his gratitude at the excellent attention given his son by sending a check for \$1,000 to the hospital.

Carl Mensel, the mechanic who was in George Arents' Mercedes when it was wrecked in the Vanderbilt Cup race, and who died in the hospital before the contest was over, leaves a widow, in poor health, and three children. As they are left in destitute circumstances, a benefit subscription list was started at the smoking concert at the A.C.A. rooms Tuesday evening, October 11.

Reception to Théry.

"Novices should not be permitted to drive in the Vanderbilt Cup Race." This was the opinion expressed by Louis Théry, winner of the 1904 Gordon Bennett race, in reply to a direct question put at a members' gathering in the Automobile Club of Amer-

ice last Tuesday night. M. Théry and his racing companion, George Callois, a French driver of high reputation, were guests of the club at an entertainment held in their honor.

Foreign builders appreciated the need of experience in driving cars at high speed in those who competed in the big events, he said, and therefore did not sell their racing cars to outsiders, but entered such machines themselves and selected the most expert drivers. Another point that he made, as if he meant it, was the impossibility of holding another race on the same course with a greater number of contestants in the running. Two minutes apart was the minimum time that should be allowed between the departure of cars.

It will be recalled that the last car sent away in the Vanderbilt race was started one minute ahead of time, so that all the cars would be running before the first car completed one round.

The obvious fact that too many cars on a short course would cause most dangerous congestion was thus brought out. Many of the members present, after listening to the discussion and comparing notes as to intentions for next year's race, came to the conclusion that elimination, or rather, qualifying trials would be needed to reduce the number of entrants in the Vanderbilt Cup race of 1905.

As a subject for the club meeting, "Automobile Road Racing in Europe" had been selected. M. Théry understands English imperfectly, and so his views were expressed by his comrade, M. Callois, who not only knows English, but knows the subject of automobile racing.

M. Théry looks very like his pictures, now familiar to automobilists everywhere, and he does not look like the winner of such a strenuous affair as the Gordon Bennett. He is heavily built, phlegmatic in appearance, but he has a knack of thinking rapidly and expressing himself clearly with the conviction of a man who has opinions and the accuracy of one who knows his subject intimately.

Both stood an hour's cross-questioning, after an introductory address by President Winthrop E. Scarritt, with great, good humor, though some of the queries put might have warranted a show of impatience.

Comparing the German cup course and Vanderbilt Long Island course, M. Callois said the former was much more difficult. While the road surface in Germany was better, there were more than sixty corners, few alike, and each one requiring different treatment from the others. At one of the controls also the cars had to start away from a standstill up a 15 per cent. grade nearly a mile long. Cars for the German course required four speeds, while the Vanderbilt race could have been run with cars using only two gears.

After the formal discussion, when speaking to a little group of enthusiasts, M. Callois remarked: "To win a big race you have

SNAP SHOTS IN THE VANDERBILT CUP RACE AT THE STARTING POINT, ALONG THE ROAD AND NEAR HEMPSTEAD CONTROL.

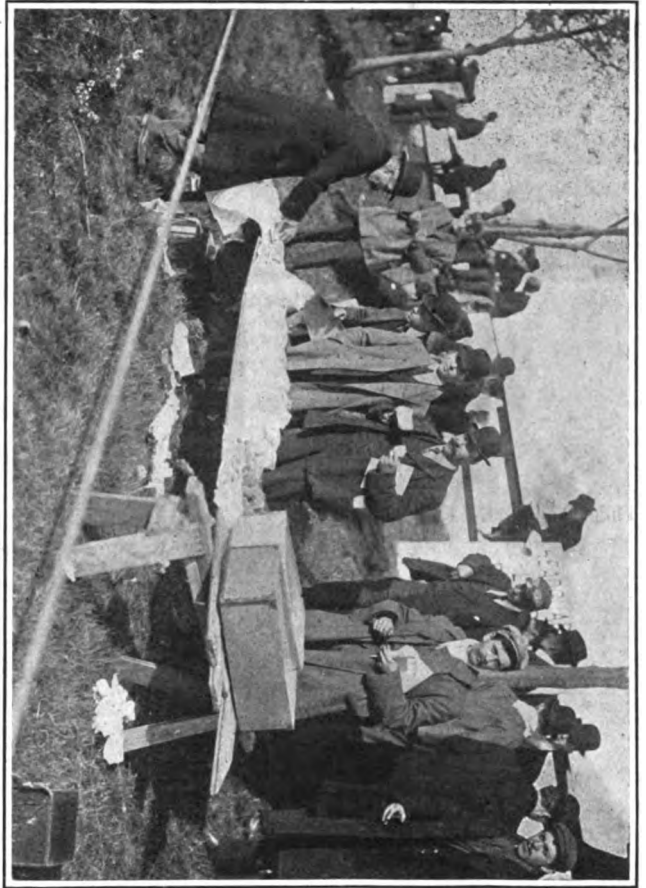

An Improvised Lunch Counter in the Vicinity of the Grand Stand.

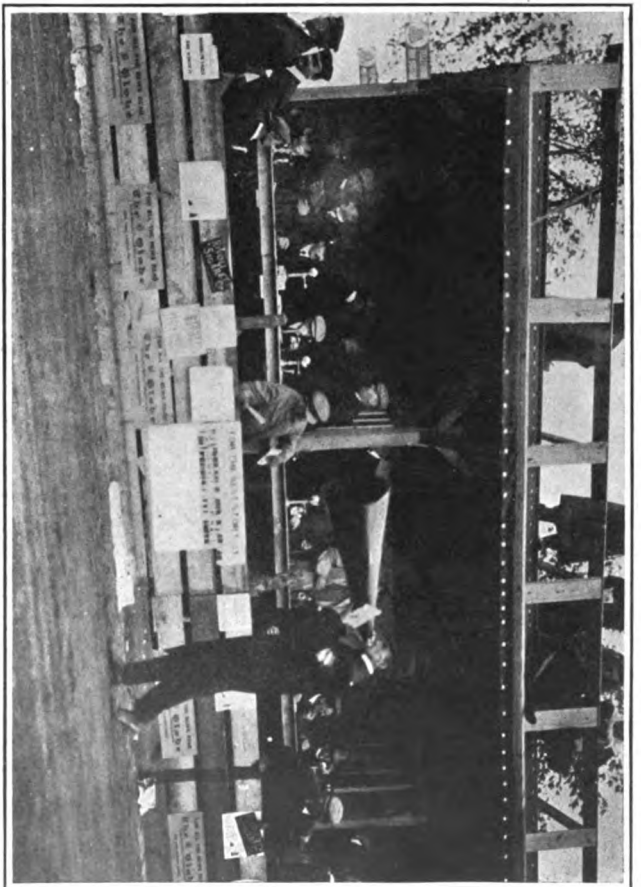

Announcer Peter Prunty at Work in Front of Judges' and Timers' Stands.

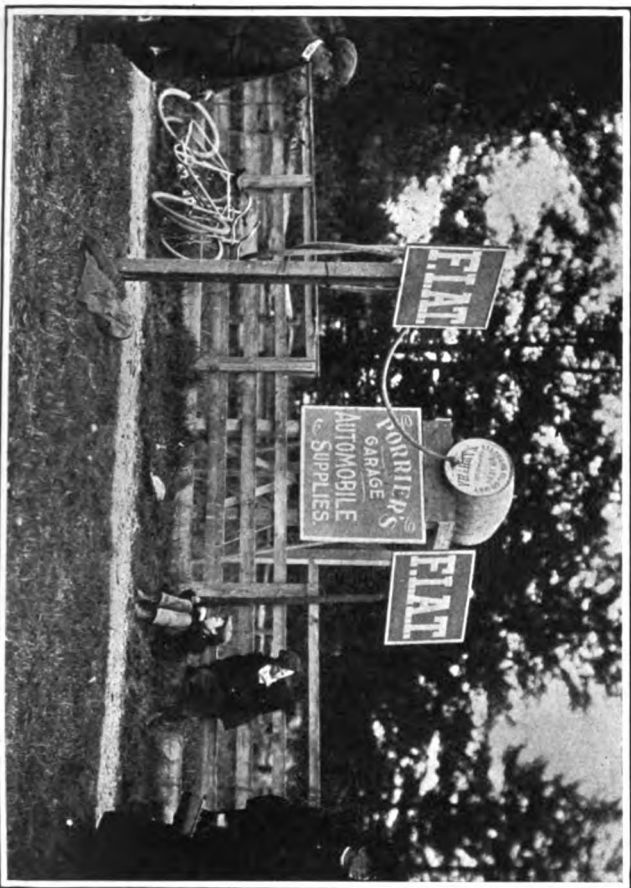

F. I. A. T. Outfit Outside Hempstead Control for Quickly Filling Gasoline Fuel Tanks.

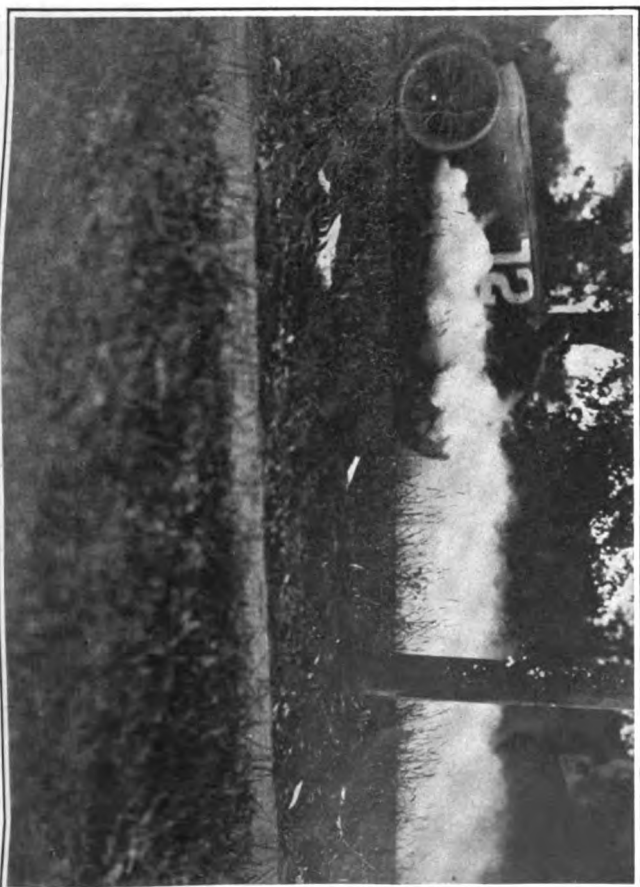

Clement-Bayard Car Smoking Furiously While Running at High Speed on Creed Avenue.

to work for it. I expect soon to go back to the factory to watch the construction of my new Richard-Brasier racing car. Every little bit of material that goes into it must be inspected and considered, and when the car is completed the most scrupulous care taken in tuning up. Little modifications and replacements are necessary, so that when the day of the big race comes the car is ready, perfectly ready. It means work, much work."

MM. Théry and Callois expected to give exhibitions of driving at the Brighton Beach races to-day, but will be unable to do so, as their Richard-Brasier cars will not be landed in New York in time. They also expressed doubt as to their participation in the races at Ormond Beach in January, as work on the new cars would probably keep them at the factory in France.

HARKNESS IS SUSPENDED.

Automobile Club of America Disciplines a Member for Disregard of Laws.

That men having at heart the best interests of automobilists in general cannot look upon the flagrant violation of the speed laws of the different states with anything but disapprobation is the meaning intended to be conveyed by the action of the board of governors of the Automobile Club of America, at its meeting last Monday night, at which a resolution was passed suspending from the club indefinitely Harry Harkness, a wealthy member, who had some ambition to enter the Gordon Bennett race of 1903, and has since made some fast performances on the track and at the Mt. Washington Climb to the Clouds.

The charge upon which the action was taken was that Mr. Harkness, on June 19 last, drove the 245 miles from Boston to New York in 6 hours 55 minutes, in an attempt to lower the record between the two cities, thereby breaking the speed laws of the states through which he passed. Although there have been other cases of excessive driving by members of the club, the disciplinary action was taken against Mr. Harkness because he had set out deliberately to break the law, going even to the extent of having his run timed by expert chronographers—which resulted in his undoing, since their evidence was most conclusive of the rate of speed made by him.

A hint that Mr. Harkness intended to make another record-breaking attempt between Boston and New York in the near future is said to have stimulated the board of governors to their action at this time, although the great publicity given to the run, and the effects on the public mind of such disregard of the laws, necessitated action by the club under its by-law, which provides that "a member may be admonished or suspended for conduct injurious to the welfare or character of the club by a two-thirds vote of the governors at a meeting at which a quorum shall be present."

The suspension of Mr. Harkness by the A.C.A. will prevent him taking part in any racing events sanctioned by the clubs of foreign countries with which the A.C.A. has reciprocal arrangements, as the A.C.A. is recognized abroad as the race-control-

ling body in America. It will not, however, keep him from racing at home at meets sanctioned by the American Automobile Association, unless the club requests the A.A.A. to take action suspending him.

SPECIAL BRIGHTON BEACH RACES.

Interesting racing is promised by the entries for the meet to be held Saturday, October 22, at the Brighton Beach track, Long Island. The most important event of the afternoon will be the five-mile international race, in which the cars entered will be tried out in heats for machines of the different nations, as in the similar event at the last Empire City track meet. The following cars have been entered for this contest:

W. G. Brokaw's 60-h.p. Renault, A. G. Vanderbilt's 90-h.p. Fiat, Guy Vaughn's 40-h.p. Decauville, R. H. Lounsbury's 24-h.p. Bollee, H. S. Harkness's 100-h.p. special car, the new 60-h.p. Peerless *Green Dragon*, driven by Oldfield; 20-h.p. Ford, driven by Frank Kulick; a 24-h.p. Peerless, driven by C. G. Wridgway, and E. R. Thomas's new 90-h.p. Mercedes, which arrived a little too late for the Vanderbilt Cup race, and which will be driven by E. E. Hawley.

The program has been extended by the addition of a five-mile race for the Diamond Cup, which has been won twice by Ford cars and twice by Peerless cars. Should it be won again Saturday by either Oldfield, on the *Green Dragon*, or Kulick, on the Ford, the cup will belong to the company that built the winning car. It has also been won once each by F. A. La Roche, H. H. Lyttle and Carl Fisher. The race is open to foreign as well as American entrants.

The proposed speed trials to be run on the Ormond-Daytona beach the week of November 14 have been abandoned, and there will be no sanctioned trials there until the regular winter tournament next January.

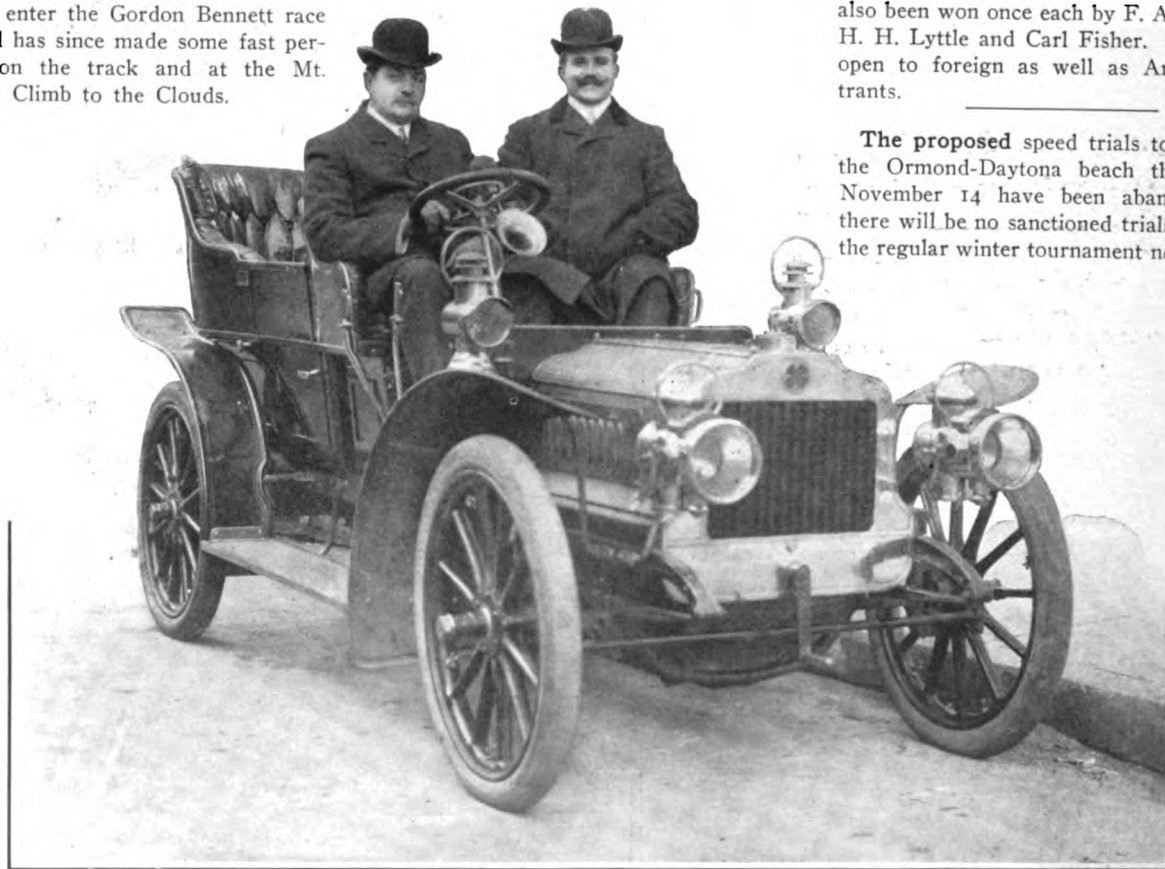

MM. THÉRY AND CALLOIS PHOTOGRAPHED UPON THEIR ARRIVAL IN NEW YORK—M. THÉRY IS AT THE WHEEL OF THE RICHARD-BRASIER TOURING CAR AND ON HIS LEFT M. CALLOIS IS SEATED.

Fall Race Meet in Cleveland.

Oldfield, in New "Green Dragon," Defeats Kiser, in "Bullet No 2," in Two Heats of Match Race.

Special Correspondence.

CLEVELAND, Oct. 17.—The match race between Barney Oldfield, with the Peerless *Green Dragon*, and Earl Kiser, with the *Winton Bullet No. 2*, for the track championship of America, held Saturday afternoon at Glenville, proved unsatisfactory to nearly every one. The *Dragon* beat the *Bullet* in two heats and in times which indicate that the latest Peerless production is a remarkable car, far outclassing the previous efforts of this company in the building of racers, but never in either race was there anything like a contest. The *Bullet* was clearly out of order, and not once during the day did it make a mile in better than 59 seconds. The real excitement of the day was furnished by the fine showing made in a stripped 10-horsepower White touring car by Webb Jay, who won two out of three events in which he started, defeating racing and semi-racer gasoline cars of much greater power.

WEBB JAY WINS IN A STEAM SPRINT.

The first race was a splendid one, although only three cars competed—Webb Jay, with the White steamer; George E. Turner, of Pittsburg, and E. S. George, of Detroit, with 24-horsepower Peerless touring cars. Turner got the start and held it for two and a half miles, with Jay trailing close behind. Jay passed the Peerless in the third mile, gaining quite a lead. In the fourth mile the steamer fell behind Turner's Peerless, but only for a few seconds. On the backstretch Jay again passed the Peerless. There was a pretty fight around the lower turns and down the stretch, when the steamer again showed its peculiar capacity for quick, short dashes, and won handily by fifty yards.

OLDFIELD WINS FIRST HEAT.

Although it was claimed that in Kiser's acceptance of Oldfield's challenge for the match it had been expressly stipulated that the races were to be from a flying start, Oldfield and his manager insisted that the heats be run from standing start. After much wrangling the matter was put before Mr. Winton, and he agreed that the first race should be from a standing start and the second from a flying start. The first heat was for ten miles. As was expected, the *Dragon* got off with a jump, while the *Bullet* picked up slowly. Oldfield turned in his seat and gave his rival a smile of derision and then settled down to his work. The difference in the starting qualities of the two cars can be seen from the fact that Oldfield's first mile was made in 1:07 2-5, while Kiser's mile was 1:20 2-5. The irregular discharge of the *Bullet's* exhaust indicated that the cylinders were not all working. On the other hand, the *Dragon* ran swiftly and smoothly. With each round it was seen that the *Dragon* was steadily increasing its lead. At five miles, which Oldfield made in 4:44 1-5, Kiser was half a mile to the bad. In Oldfield's ninth mile it looked as though he would lap his rival, but Kiser seemed to pick up on the stretch and crossed the tape a few lengths in front. Oldfield's time for ten miles, 9:17 1-5, was announced as world's record for the distance with a standing start. The average time of the *Dragon* throughout the race was 55.72 seconds to the mile. The third mile was made in 53 4-5, the most remarkable performance Oldfield has ever made on a circular track.

Three cars started in the five-mile open

for stripped stock cars up to 35 horsepower—Joseph Tracy, with the Royal, which he drove in the Vanderbilt Cup race; J. Burman, with a Peerless, and Webb Jay, with the White steamer. The White got off well and secured a lead which it maintained for nearly two miles, making a splendid race with the Peerless, with Tracy only a short distance behind. The Peerless passed the White on the lower turn, and as they came around to the tape Tracy also went by the steamer, which from that on lost steadily. The Royal made a tremendous sprint and cut down the lead of the Peerless by jumps. The finish was the exciting feature of the day, but the Peerless managed to retain some of its lead and won by a few feet.

Tracy broke his crankshaft in practice at 10 o'clock on the morning before the races, and going to the Royal factory here

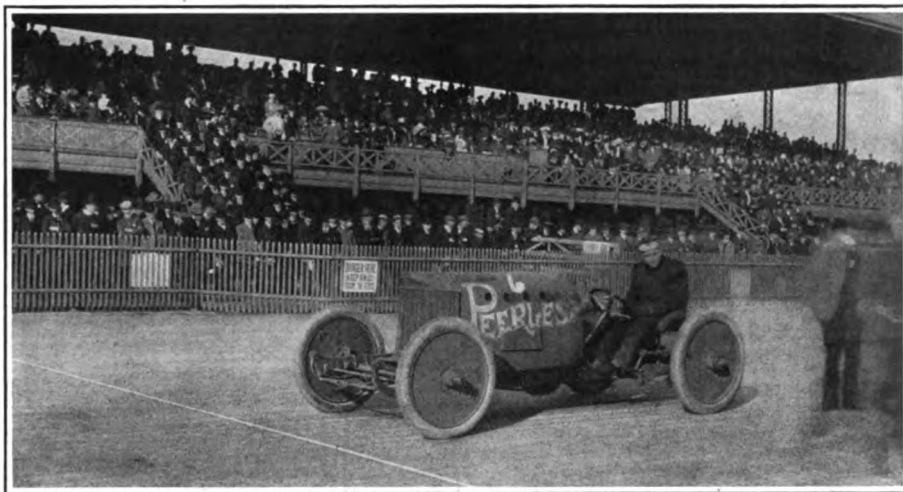

OLDFIELD IN NEW "GREEN DRAGON" AT CLEVELAND RACES, SATURDAY, OCTOBER 15.

had a new motor put in in time to start in the races, but it was not properly aligned and the clutch did not work properly.

JAY TAKES FIVE-MILE HANDICAP.

In the five-mile handicap, Charles Gorndt with the *Bullet No. 3* was placed on scratch, and Carl Fisher with the Premier *Comet* was placed on scratch at his own request. The other starters were Tracy (Royal), 5 seconds; Turner (Peerless), 20 seconds; Jay (White), 20 seconds; George (Peerless, with touring equipment), 35 seconds. The White caught George's Peerless in the first mile, and from that on was never headed. The little eight-cylinder *Comet* pulled away from the *Bullet* and rapidly cut down the lead of the limit cars. On the fourth mile the White passed Gorndt, and a little later Tracy went by the big Swede. On the last lap the *Comet* had gained a whole lap on the other scratch cars, but could not overhaul the leaders. Turner's Peerless came in a good second to Jay's White, while the Royal beat the *Comet* for third place. The *Comet's* time for the five miles was 5:20 2-5.

OLDFIELD TAKES THE SECOND HEAT.

The second heat of the Oldfield-Kiser match was very like the first, except that the cars went away with flying start. They came down the stretch and crossed the tape on even terms, but the *Dragon* quickly

pulled away from the *Bullet*, which was sputtering and missing fire as before, and finished a quarter of a mile to the bad.

The meet, which was held under the management of the Cleveland Driving Park Company, owners of the Glenville track, was promoted primarily to give Kiser an opportunity of answering the challenge made by Oldfield.

THE NEW "GREEN DRAGON."

The latest *Green Dragon* is the third of that name and is the sixth car which L. P. Mooers has built for racing purposes this year. It is lighter and smaller than any of the previous racers, weighing only 1,730 pounds. It has four cylinders, the size of which Mr. Mooers declines to discuss, because he claims the engine is a duplicate of the machine which will be placed in the Peerless 50-horsepower touring car for next season. The exhaust and inlet valves are both at the tops of the cylinders, which, he claims, reduces the amount of compression necessary for a given power. The frame is inverted and set very low beneath the axles, and the fly-wheel clears the ground by only about four inches. The radiator is V-shape, with vertical tubes.

Interest in the big match event brought

out a very good attendance. Nearly fifty members of the Canton Automobile Club, of Canton, O., attended the races, making the run to Cleveland in twelve cars, which were decorated with flags.

THE SUMMARIES.

The summaries of the day's racing follow:

Five miles, for 24-horsepower cars, road equipment—Webb Jay (White), 1st; George E. Turner (Peerless), 2nd; E. S. George (Peerless), 3rd. Time, 6:36 1-5.

Match race, ten miles, standing start—Oldfield (Peerless *Green Dragon*), 1st; Kiser (Winton *Bullet No. 2*), 2nd. Time, 9:17 1-5. Oldfield's time by miles: 1, 1:07 2-5; 2, 2:01 1-5; 3, 2:54 4-5; 4, 3:49 1-5; 5, 4:41 1-5; 6, 5:39 1-5; 7, 6:33 4-5; 8, 7:28 1-5; 9, 8:22 2-5; 10, 9:17 1-5.

Five-mile open, stock cars, stripped, 35-horsepower and under—C. Burman (Peerless), 1st; Joseph Tracy (Royal), 2nd; Webb Jay (White), 3rd. Time, 5:37 2-5.

Five-mile open handicap—Webb Jay (White), 20 seconds, 1st; George E. Turner (Peerless), 20 seconds, 2nd; Joseph Tracy (Royal), 5 seconds, 3rd; Carl Fisher (*Comet*), scratch. Time, 5:20 2-5.

Match race, second heat, five miles, flying start—Oldfield, 1st; Kiser, 2nd. Time, 4:43 3-5. Oldfield's time by miles: 1, :58 1-5; 2, 1:54 2-5; 3, 2:51; 4, 3:47; 5, 4:43 3-5.

Motor Union in United Kingdom.

Strong Organization of Clubs and Individual Motorists that Looks after Legislation—Advantages of Membership.

Special Correspondence.

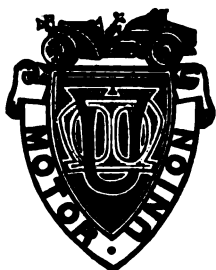

LONDON, Oct. 4. —The Motor Union of Great Britain and Ireland is not a club, nor is it simply an organization of clubs as such. Rather is it an alliance, for mutual benefit and protection, of practically all the automobile organizations of the United Kingdom and Ireland, and a large number of unattached individuals as well. Its primary object is the protection of its members from legal persecution, but it goes beyond this and endeavors to influence both the enactment of fresh legislation and the application of existing laws where these in any way affect automobiling. Further, it aims to secure useful information for its members *en tour*, at home or abroad. It is said to be the largest organization of its kind in the world, and it has already proved its value to its members in many ways.

INCLUDES CLUBS AND INDIVIDUALS.

In order to provide an organization which would embrace both clubs and individuals a scheme was adopted last February substantially as follows:

The members of the Automobile Club of Great Britain and Ireland are *ipso facto* members of the Motor Union without additional dues. Local clubs may become members of the Motor Union under any one of the following three plans: (a) Affiliation with the A. C. G. B. I. and membership in the Motor Union, including a free copy of the *Automobile Club Journal* to each member, for 10s. 6d. for each member; (b) association with the A. C. G. B. I. and membership in the Motor Union, without the club journal, for 5s. for each member; (c) association with the A. C. G. B. I., etc., with the right of representation and the privilege of legal support, but without the privilege of touring information, for 2s. 6d. per member. Besides these, certain special organizations are provided for.

Individual automobilists may join the union and receive the same benefits as club members under section (a) on payment of one guinea annually.

PRESENT MEMBERSHIP IS LARGE.

The present membership of the Motor Union includes forty-two clubs, and a total of over 5,000 members, as against about 3,000 at the same time last year. The A. C. G. B. I., of course, has the largest membership, numbering over 2,500. Its recently elected chairman, Lieut. Col. Holden, R.A. F. R. S., is also the chairman of the motor union.

There are at present no clubs associated under section (c), but the special class includes three clubs: The Ladies' Automobile Club, with 227 members; the Autocycle Club, with 147 members, and the Motor Van and Wagon Users' Association, with 108 members.

Every club joining the Motor Union is entitled to representation on the General Committee of the Motor Union at the rate of two delegates for the first fifty members, and one delegate for each succeeding fifty. The effect of this arrangement is to include in the committee a large number of such prominent men as Sir David Salomons, Sir John Thornycroft, Lord Russell, Henry Norman, Hon. J. Scott Montague, Dr. Boverton Redwood.

WORK OF THE MOTOR UNION.

Foremost in the work so far done by the Motor Union is its defense of members considered to be unjustly attacked under the

unnecessary. It is also agitating the passage of a universal lighting law, and will introduce a bill in its behalf into Parliament before long. At the same time it is working for stiffer local regulations regarding the lighting of all vehicles at night.

A BUREAU OF INFORMATION.

As a bureau of information the Motor Union is of great assistance to its members in supplying all details as to Continental customs, duties, driving regulations, hotel and garage accommodations, supplies of fuel, and the like. All members of the Motor Union, except those in class (c) of the clubs, are entitled to participate in any social or sporting events organized by the Automobile Club of Great Britain and Ireland.

Testing Packard Cars.

The testing and trying out of motors and complete automobiles is becoming much more general than was the case a few years ago, and the service tests given cars at the factory are now, in the case of the more important concerns, very complete. The method employed by the Packard Motor Car Company, Detroit, Mich., for

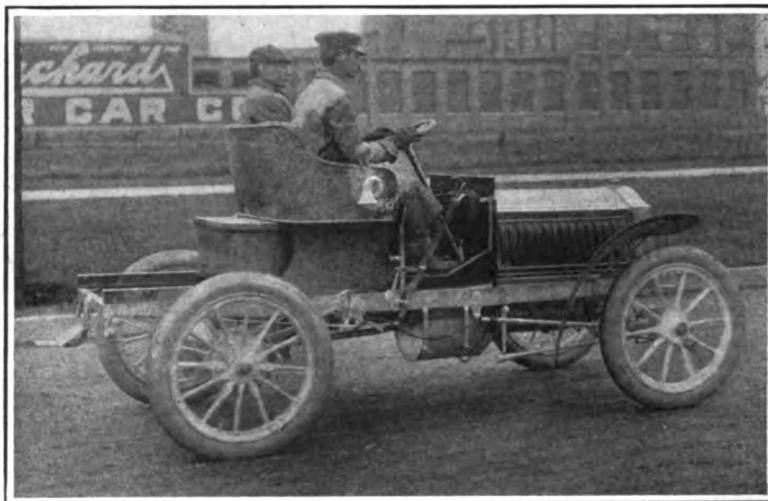

CAR UNDERGOING FINAL TEST ON ROAD BEFORE GOING TO SALESROOM.

law. In many cases the costs of the defense have been voted by the union. Its outlay last year in this way amounted to £275, the largest item of which, £124, was spent in defending a single case in which the defendant was not permitted by the magistrate to submit evidence in his own behalf.

As regards the administration of the new Motor Act which came into force at the beginning of the year, the Motor Union has kept a close watch on the applications of various districts to the Local Government Board for permission to enforce speed limits of ten miles. The union has endeavored where practicable to persuade the local authorities to widen and improve the roads in these districts, a thing which of itself renders the lower speed limit

testing the model L Voiture Légères is systematic and of interest.

A special body, built of light wood and furnished with a box for carrying batteries, tools and a gasoline tank under the seat is used. Every car is put on the road and run under ordinary conditions until the engine control, brake system and other details are in perfect adjustment and condition. Previous to this road test the motor is tested for horse-power and the transmission is also thoroughly tried out, the road-work of the assembled car being the final touch. One of the features with which the manufacturers are particularly pleased is the low consumption of gasoline, the Model L car doing twenty miles per gallon, while the older Model F has a record of 27 1-3 miles per gallon.

Folding Rear Seat.

Owners of light two-passenger runabouts often feel the need of some arrangement which will enable them to carry one or two extra passengers without the necessity for putting on a regular tonneau attachment or attaching a dos-a-dos seat, which is anything but comfortable for those who use it. To meet this need a folding seat has been invented by J. D. Artz, Dayton, O. The accompanying illustrations show it open and closed. The main advantage of this device is that when not required for carrying passengers it can be folded down out of the way, and when so closed protects the cushions from rain and dust, and is a hardly noticeable addition to the runabout. A few seconds will, it is stated, suffice to fold or open the seat, which is strong and stiff when open. It can be fitted to any car having the rear portion clear. Mr. Artz intends to commence manufacturing his device for the market within a short time.

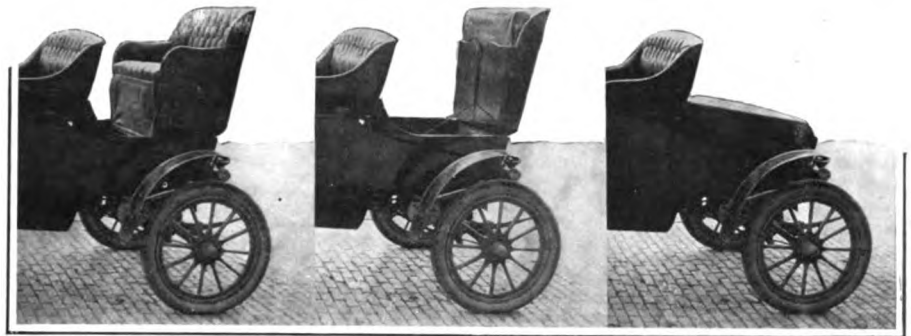

ARTZ FOLDING SEAT, OPEN, PARTIALLY FOLDED, AND ENTIRELY CLOSED.

clearly the arrangement of the parts and their forms. The shoes, which are of pressed steel, are pivoted through the

tween the shoe and the bottom of the rim is inserted a rubber block. Guides on the rim engage with similar guides on the shoes, these taking most of the strain of keeping the shoes in line and lightening the duty imposed on the pivots. Each shoe is provided with a bolt, extending inward through the rim. By tightening the nuts on these bolts the shoes are drawn into contact with the rubber, preventing looseness and rattle and providing means of adjustment if the rubber, through constant use, becomes compressed and does not fill the space between the shoe and the rim. The holes in the rubber blocks, through which the guides and bolts pass, are filled with dry graphite, which is retained by the closing of the holes by the rubber. The steel shoes are fitted with outside plates, which are perforated and the perforations filled with lead, which is designed to pick up gritty particles to give traction. As the rubber is subjected only to compression, it may be of cheap quality, and is expected to last for a long time. The wheel itself is of steel, with malleable iron hub, and is quite inexpensive to build, the inventor states. Preparations are being made to place it on the market.

Heavy Truck Wheel.

One of the most formidable obstacles remaining in the way of the general introduction of motor trucks for heavy work is the tire problem. Steel tires are too rigid and unyielding, and do not afford traction under unfavorable road conditions, while rubber is extremely expensive, wears out rapidly, is subject to tearing and cutting, and much difficulty is experienced in securing solid rubber tires to the rims of heavy truck wheels. A new wheel, which has been patented by E. S. Lea, of the De Laval Steam Turbine Company, New York, is designed to overcome these difficulties by a novel arrangement of rubber blocks protected by steel shoes, pivoted so as to obtain the advantage of the elasticity of the rubber.

The accompanying illustration shows



BROOKLYN FIRE DEPARTMENT AUTO.

channel-shaped rim of the wheel, arms being formed on the shoes for this purpose. Be-

Brooklyn Fire Auto.

The automobile illustrated herewith was purchased for the use of Deputy Chief Lally, of the Brooklyn Fire Department, to be used instead of a horsedrawn vehicle for going to fires. It is a Locomobile touring car with four-cylinder 24-horsepower motor capable of a maximum speed of about forty-five miles an hour. The car has an unmistakable "fire department" look about it, due to the brilliant shade of red which it is painted and to black striping. Fear-some paint is not relied upon, however, to warn people of its approach, as a regular fire department gong is attached. Police officers, who at first insisted on stopping this car and Chief Croker's Columbia when racing to fires, will therefore clear the streets hereafter. A tag, marked "F. D. N. Y." on the rear will assist in dissuading the auto-catchers from pursuing the machines.

The Akron, O., police have commenced a crusade against automobile speeding, and the entire force has been supplied with stop watches for timing automobiles.

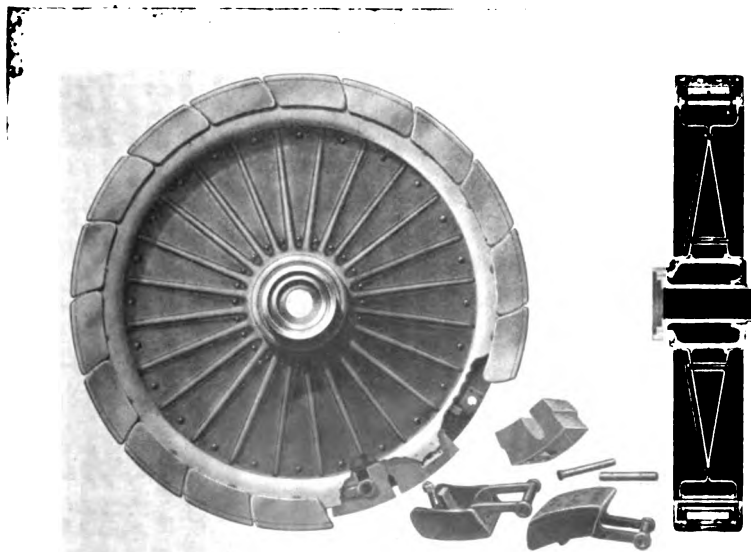

LEA TRUCK WHEEL, WITH PIVOTED STEEL SHOES OVER SOLID RUBBER BLOCKS.

"Model" Light Dash Cars.

The especial feature of the "Model" gas oline cars for 1905, which will soon be ready for the market, is the hinging of the body at the back, so that from the middle of the footboard aft it can be raised and propped up, as the accompanying photograph shows.

Two sizes will be made, one of 16-horsepower, to carry five passengers, and weighing 1,600 pounds; the other for four passengers, rated at 12-horsepower, and said to weigh but 1,200 pounds. Both cars have "double opposed" horizontal motors and three-speed sliding gear transmission.

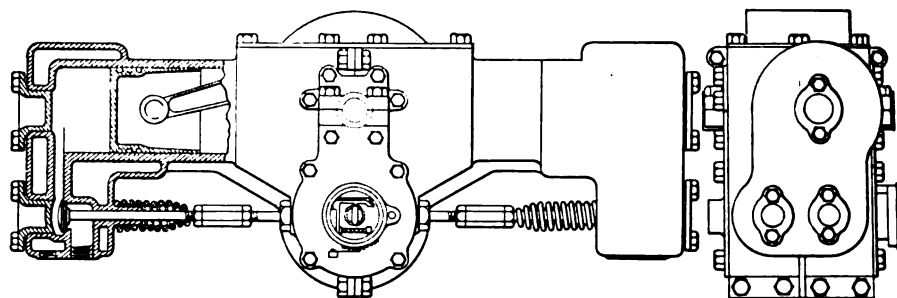

PART-SECTIONAL SIDE AND END DRAWINGS OF "MODEL" OPPOSED ENGINE.

The crank-case has an aluminum cover and is oil-tight. All the bearings are adjustable for wear and are oiled by a lubricator on top of the crank case, with check valve for force feed. Jump spark ignition

The engine drives the change gears through an enclosed flywheel clutch and loose coupling, as shown. The clutch thrust is self-contained when the clutch is engaged, as the drawing shows. A special feature of the speed-changing gears is that, in the high or direct drive not even the idle gears are in mesh. In the drawing the intermediate gears are engaged and the drive is through gears *A*, *B*, *C* and *D*, in order to sprocket pinion *E*, which is fast to the loose sleeve which carries *D*. When shifter *F* carries gear *A* to the left, the lever *G* and slotted link *H* draw gear *B* to the right, disengaging it from *A* before the pins *I* engage sockets in the face of *D*, giving the direct drive. Engagement of *J* and *K* gives the first speed, and of *J* with intermediate pinion *L* the reverse. All the gears are hardened steel except *M*, which is brass.

But one braking system is used, the hub brakes on the rear wheels being applied by the clutch pedal in the latter half of its motion. Steering is by worm and sector, and the gasoline and water tanks are contained under the front hood. The Warner differential gear is used, and the rear axle turns in Hyatt roller bearings. The front wheels have Timken roller bearings. The Model Gas Engine Works, Auburn, Ind., are the makers.

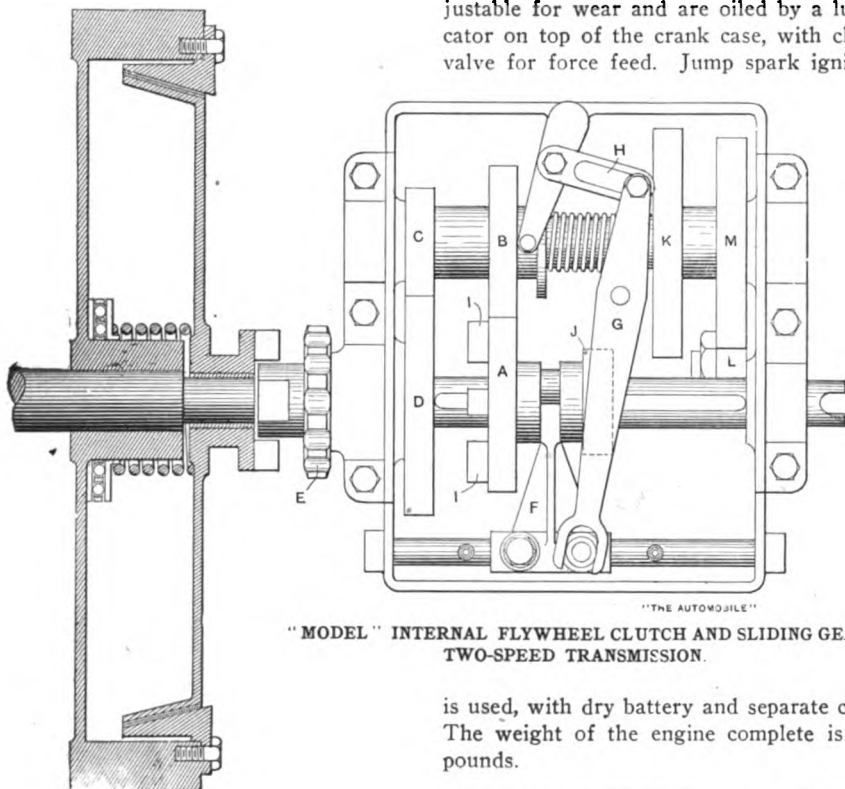

"MODEL" INTERNAL FLYWHEEL CLUTCH AND SLIDING GEAR TWO-SPEED TRANSMISSION.

is used, with dry battery and separate coils. The weight of the engine complete is 275 pounds.

The main frame of the 12-horsepower car is forged in one piece from angle steel and is hung on semi-elliptic springs. The wheel base is 72 inches, tread 56 inches and wheels from 28 to 32 inches, at option of purchaser. The motor has cylinders 4 1/4 by 5 inches bore and stroke, and is rated at 12-horsepower at 1,000 revolutions. The crank-case—except the cover and bearing heads—cylinders and cylinder heads are cast in one piece, the arrangement being such that the pistons and rods may be taken out through the crank-case top. The valve chambers also are integral with the cylinders, making a very simple and inexpensive piece of work. No packing is used about the engine.

All the valves are mechanically operated, the exhaust valves by one cam and the inlet valves by another, the valve chambers being offset from the cylinders slightly to permit this. All the valves have 1/4-inch openings, this being preferred to a smaller size on account of the smaller lift and consequently quicker opening it permits.

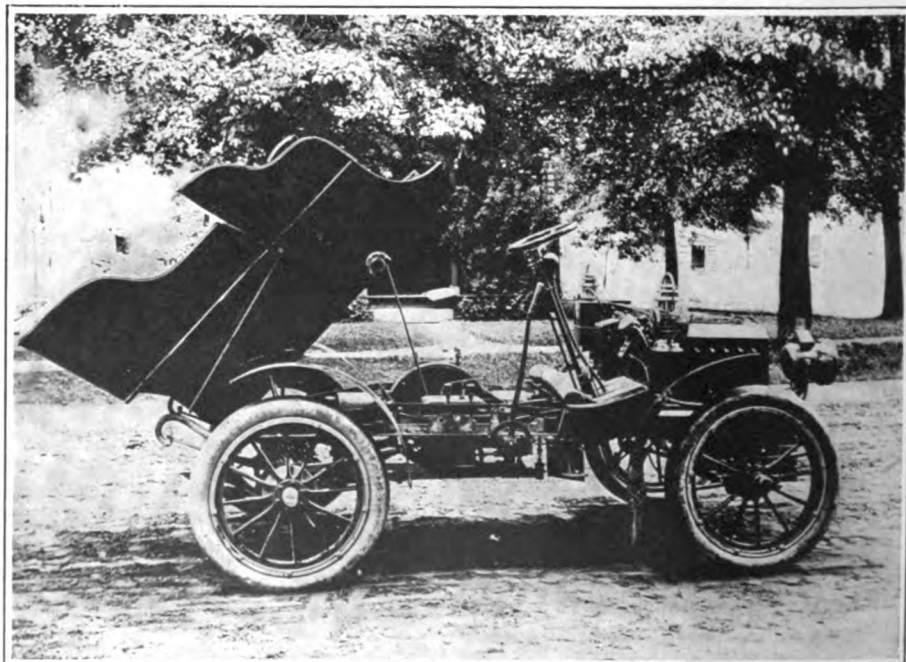

SHOWING BODY OF "MODEL" CAR RAISED FOR INSPECTION OF MACHINERY.

Patents

Internal Combustion Engine.

No. 769,589.—D. Clerk, of Emhurst, Eng.

This invention is the latest of a number recently made by various students of the internal combustion engine, all having for their object to facilitate the use of higher compression and higher mean effective pressures by diluting the charge with inert gas or vapor, so that it will not spontaneously ignite from the high compression used. Mr.

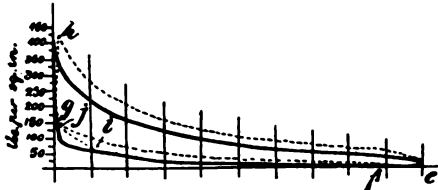

DIAGRAM FOR CLERK ENGINE.

Clerk and others have previously proposed to use pure air for this purpose; and large engines in which an excess of air is forced into the cylinder under pressure at the beginning of the compression stroke have been in successful use for the past two or three years, and have shown great economy. In the present case Mr. Clerk uses steam instead of air, and introduces it, not at the beginning of the compression, but as near the end as possible, in order to minimize the negative work required in compression, and also in order that the temperature of the charge, due to compression, may be high enough to keep the steam from condensing.

In the diagram the solid lines show the ordinary indicator card without diluting the charge. The dotted compression curve *efg* is that which would be obtained by forcing air (or steam, if it did not condense) into the cylinder early in the compression stroke. The short dotted curve *ij* is that obtained by forcing the steam in under pressure. Then *gh* is the explosion line, and *he* the expansion line with the diluted charge.

The inventor proposes to generate the steam for this purpose by utilizing the waste heat of the jacket water and exhaust, and there seems to be no intrinsic reason why the system should not eventually be applied to automobiles.

Making Spongy Lead.

No. 767,906.—J. H. Mercadier, of Louvres, France.

A powdered metal oxide, such as litharge, minium, or oxide of zinc, is stirred into molten lead in sufficient quantity to produce a paste which can be cast in a mold and has sufficient strength to need no supporting gird when used for storage batteries. The lead in this paste takes the form, not of granules, but of filaments closely welded together.

Pedestal Running Gear.

Nos. 770,725 to 770,728, inclusive.—A. F. Madden, of Newark, N. J.

These four patents cover improvements in the familiar pedestal running gear used by the Vehicle Equipment Co. The first is a device for swiveling the axle in the pedestal boxes, so that the latter will not tilt and bind on the pedestal guides when the axle oscillates. The boxes are made in halves *8 9*, on which are found bearing bosses or studs *10 11*, which enter a hole bored in an enlarged portion, *12*, of the axle.

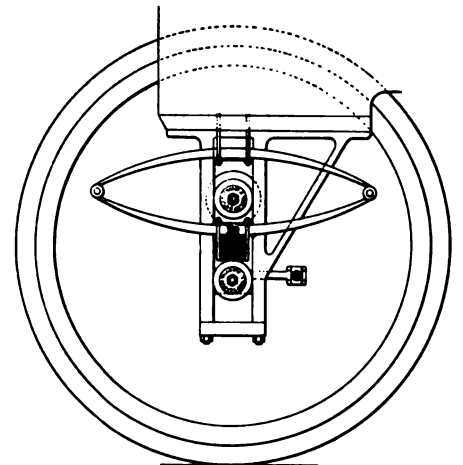

NO. 770,727—PEDESTAL WITH FLANGED ROLLERS.

neither boxes nor flanges to restrict its movement. Lateral movement is prevented by the flanges of the box in the central pedestal, which is of the pivoted type described above.

In No. 770,727, flanged rollers suitably pivoted to lugs on the axle take the place

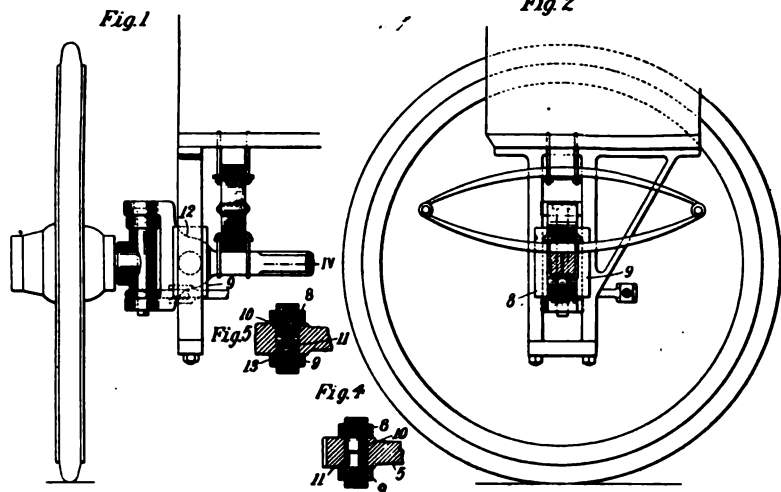

DETAILS OF MADDEN PEDESTAL AXLE GUIDES FOR RUNNING GEARS.

To take up wear, a spring *13* may be interposed, as shown in the small detail drawing, Fig. 5.

In the second patent three pedestals are used with each axle, but the end ones merely guide the axle up and down, there being

of a pedestal box, two pedestals only being used; and in the fourth patent three pedestals are used, the central one being formed of channel irons, *2*, with their flanges disposed so as to guide rollers *6* pivoted on the axle.

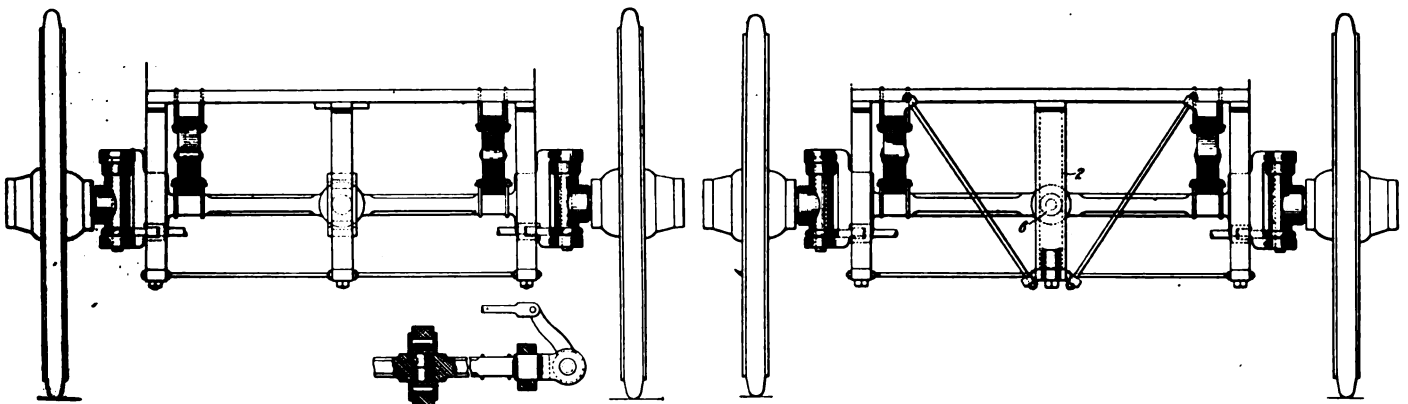

MODIFICATION OF MADDEN INVENTION. SHOWING A THIRD AND CENTRAL PEDESTAL TO PREVENT LATERAL MOTION OF AXLES.



VOL. XI.

No. 17

Published every Saturday by

THE CLASS JOURNAL CO.,
Flatiron Building, Madison Square,
NEW YORK CITY.

Cable Address - - - - - Autoland, New York
Long Distance Telephone - 300 Gramercy, New York

SUBSCRIPTION RATES:

United States, Canada and Mexico, - One Year, \$2.00
Other Countries in Postal Union, - One Year, \$3.00

To Subscribers—Do not send money by ordinary mail.
Remit by Draft, Post-Office or Express Money Order,
or Register your letter.

FOREIGN SUBSCRIPTION AGENTS:

ENGLAND:—Iliff & Sons, Limited, 3 St. Beide Street,
Ludgate Circus, London, E. C.

FRANCE:—Boyveau & Chevillet, 22 Rue de la Banque,
Paris.

GERMANY:—A. Seydel, Mohrenstrasse 9, Berlin.

To Advertisers—Copy or changes in orders for advertisements should reach us not later than 5 o'clock p. m. Monday for the issue of Saturday following.

Copyright, 1904, by The Class Journal Company.
Entered at New York, N. Y., as second-class matter.

The Automobile is a consolidation of The Automobile (monthly) and the Motor Review (weekly).

Copies Printed This Issue, - - 12,000

“ “ Since Jan. 1, - 519,000

**Honor
Where
It is Due.**

Reflection on the results of the Vanderbilt cup race, on the days that have intervened since that eventful Saturday on Long Island, must give rise to a feeling of great appreciation of the results accomplished in the minds of all well informed persons who have at heart the best interests of the American automobile industry. It is doubtful if the tremendous significance of this event and its bearing upon the future of automobile production on this side of the Atlantic have been fully grasped by those who are not close students of automobilism at home and abroad. It means nothing less than America has arrived, as the French say; that in the world's contest of automobile construction she has now taken an unassailable position.

Hitherto, in the supreme test of quality in design and construction imposed by racing at the highest speeds on the public highway, America has not "made good." All our attempts had resulted in failure, or worse, and, from a scientific standpoint, we were either unclassified or not considered as a factor. In discussions of the proper styles of construction for tests of engineering value, and in the consideration of the proper methods of carrying out such tests, America was compelled either to hold her peace or to be classed in scientific and sporting circles as an inconsequential bluffer.

Her representations might be politely received, but would get no more serious attention than the opinions of a rocking chair fleet in an international yacht race.

In a single day the conditions have been changed.

Thanks to William K. Vanderbilt, Jr., through whose generosity and public standing as an influential and responsible sportsman, the opportunity to give America a chance to win a reputation was made possible. We do not wish to give Mr. Vanderbilt one iota of credit that is not his just due, and yet we cannot do less than call attention to the immeasurable benefit to this great and growing industry in America which his unselfishness has contributed. His motives have been assailed, his actions purposely misconstrued by a large section of the daily press, which, in a campaign of false, *ex parte*, statement and blackguardly misrepresentation has attempted to bring him into public disrepute. The truth will, however, prevail and when all the petty slanders and malignant denunciations shall have been forgotten this day of victory and its captain will be remembered with gratitude.

**Preparation for
1905 Gordon
Bennett Race.**

The American builders who entered cars in the cup race naturally have a large share in the credit due Mr. Vanderbilt for the change this race has worked in the status of the American car. Up to almost the last moment, when entry of cars was possible, the holding of the race was a practical uncertainty, and under the circumstances no manufacturer was justified in building special machines for the event. Confidence in their own regular constructions and a most commendable public spirit led them to make entry of such vehicles as seemed at all suitable. Results show how well this confidence was deserved, and we have no doubt that the spirit they displayed will be rewarded substantially indeed by an appreciative public. When foreign car after foreign car, the output of the finest shops of Europe and built regardless of expense, went down and out three American machines kept steadily going, robbed, however, of official honors by an inconsiderate horde of spectators. The Pope-Toledo, the Packard and the Smith & Mabley cars did credit to the American industry, and gave promise of what their builders could do were they to enter this contest with such preparations as its character really necessitates.

In this connection we desire to call special attention to the date of closing entries for the Gordon Bennett cup race of 1905. The last day on which entries can be received at the Automobile Club of America in New York is December 15 next. The experience gained in the Vanderbilt race will enable those of our manufacturers who had cars in that event to gauge the conditions needed for success in the great international

race abroad. This experience must have greatly increased confidence in their ability to make a worthy showing in France next year, and should result in a full list of American entries.



**Daily Paper
Editorial
Ignorance.**

An interesting and yet alarming symptom of decay in editorial prestige in the daily press of New York is exhibited in the splendid egotism with which several of the once authoritative papers ignorantly discuss questions of a technical character. We are urged to this statement by reading certain recent editorials in the *New York Times*, which for bigotry, ignorance and senile garrulity are unsurpassed.

It is a commonplace among professional men in the metropolis that editorial expressions, in a large section of the daily press, on technical subjects, are invariably inaccurate and usually grotesque. This applies not only to the news pages, but to the more carefully considered editorial columns.

In older days, when science did not play so important a part in daily life, occasions for the popular discussion of highly technical subjects were comparatively infrequent and the encyclopedic knowledge of the editors was wide enough to cover the range of subjects discussed. In the past twenty years, however, conditions have changed immensely; the progress of invention has brought things mechanical to the front with a rapidity that has bewildered the dry old academicians of the daily press. They have had neither inclination nor opportunity to keep pace with the movement, and partial realization of this has soured the temper of many an otherwise good critic of things economical and political. Too egotistical or too parsimonious to employ the aid of outside experts, the publishers of the dailies have preferred to blunder along until only a pitiful remnant of their former authority in well informed circles is left.

In its issue the day after the Vanderbilt cup race the *New York Times* says with great editorial solemnity: "The race was utterly futile, proving nothing of interest and value to any one concerned in promoting 'sport' or the mechanical development of the practical and useful motor vehicle."

Thus it sums up the greatest mechanical speed contest ever held in this country; the trial, to the "elastic limit" of excellence of design and construction, of the products of the master minds in the most famous shops of two continents. In the name of all things mechanical, what sort of a contest would prove *something of interest*?

An assemblage of machines, built by the world's greatest automobile engineers and tried out at maximum speed under such conditions of observation as modern scientific thought can suggest, "proves nothing of interest and value" to the editor of the *Times*. He is one, and the automobile engineers and sportsmen are many; yet his

Concentrated Efforts for Good Roads.

Automobilists, Chamber of Commerce and Board of Supervisors Organize an Association in Rochester.

Special Correspondence.

knowledge of the subject is so great, so preponderating, that in reality these men are a parcel of fools filled only with a "morbid taste" for such an exhibition.

Is this a case of colossal nerve or just plain crass ignorance? Or, on second thought, is it written with the bookkeeper's pencil fresh from a zero mark in the automobile advertisers' column.

Absolving it from the charge of being the work of an intellectual bawd, and accepting it on its face value, it is a disgusting piece of impudence on the part of a self-convicted ignoramus.



A Reply to the New York World. In an editorial in its issue of Wednesday, October 19, the evening edition of *The World*, New York, discussing the issue of THE AUTOMOBILE containing the report of the Vanderbilt cup race, says: "Presumably it conveys the official voice of the promoters of the event." This is a gratuitous assumption, which is doubtless based upon the experience and natural expectations of the editor of *The World*.

Our respects to *The World*, but THE AUTOMOBILE is not built that way. The only voice which this paper conveys is the voice of the men who own and manage it, not one of whom has any official or unofficial connection with the Vanderbilt race commission or any other outside automobile interest.

Further along in this editorial *The World* says "the editor of AUTOMOBILE * * * advances neither fact nor argument to establish for the event a practical, world-benefiting utility of any degree." Our reply to this is that all those persons who are interested in automobiling, in its scientific or sporting aspects, are familiar with the reasons why road racing is an absolute necessity for America to keep pace with the mechanical progress of the other automobile building nations. For such persons THE AUTOMOBILE is published, and not for an uninformed public.

We suggest to the editor of *The World* that, although a single copy of THE AUTOMOBILE contains much information, it cannot reasonably fill all the educational requirements of the man who writes *The World* automobile editorials. Should the latter desire, however, to get an insight into what automobiling really is, which would enable him to write on the subject, at least intelligently, we shall be very glad to send him a copy of the paper regularly, and charge it to Suspense Account. Should the editorial writer later exhibit symptoms of having a rational and well-informed mind on the subject, we shall gladly transfer the account to the profit side of our ledger.

Permits to the number of 712 have been issued by the Golden Gate Park Commissioners to automobilists, allowing them to drive in Golden Gate Park, San Francisco.

ROCHESTER, Oct. 15.—With practically the same people back of the movement as pushed the bicycle sidepath movement to success in years past, Monroe County, New York, has taken up the work of building good roads and has organized an association known as the Monroe County Good Roads Association, with William C. Barry, automobilist, banker and nursery man, as president. A convention of good roads advocates was held last Monday in the Board of Supervisors' room in the county courthouse. Morning and afternoon sessions were held there, followed by an evening session in the Chamber of Commerce rooms. Tuesday morning the convention finished its work, and in the afternoon, as guests of the Rochester Automobile Club, the "good roaders" were taken for a fifty-mile spin over the fine macadam roads of this county in thirty of the members' automobiles.

TAXES NOT INCREASED, SAYS SENATOR ARMSTRONG.

Senator W. W. Armstrong, who drew up and secured the passage of the Higbie-Armstrong good roads law by which the state assists the towns and counties in building macadam roads, and who put through the Monroe County sidepath law, under which 240 miles of bicycle paths were constructed in this county, was elected chairman of the convention. The Senator spoke in part as follows:

"Sixty-three miles of state roads have been constructed in Monroe County since the Higbie-Armstrong law was passed in 1898 and twenty-four miles more are now being built. Although we have spent approximately half a million dollars for good roads in that time, there has been no visible increase in the tax rate. In the state it has fallen to almost nothing—nothing, indeed, for general purposes; in the county it has largely decreased and in this city it has not increased in any year on account of road improvements so as to occasion criticism."

Mr. Armstrong went on to tell how the highway in the state had been improved during the last six years and defined the purposes and explained the provisions of the Higbie-Armstrong law and Fuller-Plank law, the two New York state laws that are responsible for the many miles of good macadam roads that greet the touring automobilist, sometimes in the most unexpected places.

NATIONAL AID AND NEW YORK BOND PLAN.

Frank Z. Wilcox, of Syracuse, vice-president of the National Good Roads Association, was then introduced, and spoke in behalf of his organization and the splendid work it was doing. Both President Theodore Roosevelt and William Jennings Bryan are among the public men interested in the work of this organization, he said. Mr. Wilcox then went on to tell how the National Association had framed a bill whereby the national government would give money to aid in road building in several of the states on lines similar to those of the Fuller-Plank law of New York. He also told of a bill that has already passed the legislature of this state to issue bonds to the amount of \$50,000,000 for road improvements under the Higbie-Armstrong law. A proposition to amend the state

constitution, authorizing such a vast expenditure, has already passed one legislature, and will be brought up before the one to be elected next month and, if approved by it, is to be submitted to the people for approval or rejection. With \$50,000,000 spent by the state on road making there will be no more occasion for such letters of protest as the members of the American Automobile Association sent in from Syracuse on the recent New York-St. Louis tour—a protest that would have been more fitting in Illinois than in New York state, as the tourists learned a fortnight afterward when struggling through black mud up to the hubs of their machines.

STATE AID IN SEVEN STATES.

Mr. Wilcox advocated the elimination of grades of more than 7 or 8 per cent. He also spoke emphatically against the dykes built across the highways to turn the water off the road on hills. These "Thank-yema'ams," so long the chief cause of broken springs on automobiles and wagons alike, should be entirely done away with, he said, and roads should be crowned from an inch to an inch and a half per foot instead; then, by bringing the water through culverts under the road, washouts would be impossible.

Speaking further he said: "There are now seven states which have enacted statutes authorizing state aid and supervision of the highways within their limits and many other states are now preparing similar measures."

MANY QUESTIONS ASKED.

A question box was instituted early in the convention and it took the greater part of Tuesday morning for Senator Armstrong, County Engineer McClintock and Frank D. Lyon, special examiner of state highways, to answer the numerous inquiries as to cost of building, grading, cutting weeds, rights of telephone companies, and other practical points.

A resolution was put through requesting the state to build all bridges across the canal strong enough to allow a steam roller to cross. This is a resolution that automobilists will appreciate, as nothing causes more annoyance on a tour than a shaky bridge, the tourist realizing that it is liable to give way beneath his machine at any moment.

President Thomas B. Dunn, of the Rochester Chamber of Commerce, and a large stockholder in the Regas Automobile Company, made the address of welcome to the good roads workers in the evening when they attended a session of the Chamber in a body. Several of the delegates made addresses and a luncheon was served after the evening session.

Sunday School Teacher—"Tommy McGrath, can you tell me who threw the stone that struck Goliath?"

Tommy—"Ye kin search me. Our street's all tore up, an' dey ain't no autermobiles goes dat way."—*Brooklyn Life*.

The Cannstatt Daimler firm is building a three-cylinder car of 8-14-horsepower to take the place of the present 8-12-horsepower four-cylinder car. The car will not be on the market until August, 1905.

EUROPEAN INTEREST IN AUTO-BOAT RACES.

Regulations for Trans-Mediterranean Race
Next Spring—Entries from Four Nations—New English Boats—Winter Race on the Seine During Paris Salon.

Special Correspondence.

PARIS, Oct. 4.—The automobile boat has, during the past few months, occupied a foremost place in the motor world, and next spring seems likely to see interest in this branch of sport still further increased. Immediately after the Monaco races the cross-Mediterranean course, from Algeria to Toulon, which is already arousing considerable interest, will be run.

The preliminary regulations for this race, drawn up to guide competitors in building, state that the size of hulls and force of motors will not be limited; that the motors must be capable of being started in ten seconds; that the minimum speed shall be fifteen nautical miles an hour; that the boats shall not be allowed to take on gasoline en route, and that the crew of each boat shall consist of six men at least.

Already a large number of entries have been assured, French boats, of course, predominating, but Italy, Germany and England will also be represented. The last-named country appears to be making strong efforts to gain a good position in this contest. S. F. Edge has entered two boats, which have yet to be built and which will be named *Napier III.* and *Napier IV.* They will be forty feet long, have a speed of twenty-four knots, will develop 100 horsepower and will be driven by gasoline. Charles Jarrott is also building a motor boat, to be called *Jarrott I.*, and it is reported that his partner, Mr. Letts, has just left for the United States in order to superintend the construction of a motor boat to be called *Olds.*

The famous motor boat *Mercedes IV*, which was so successful in the Calais-Dover and Paris-to-the-Sea races, has just been sold to an English sportsman, Mr. Guinness, for \$7,000. The boat has left Calais for Southampton, where, under the British flag, its owner hopes to continue the series of victories gained under the French tricolor.

During the great automobile show, to be held in Paris at the Grand Palais during the month of December, the Journal *L'Auto* will organize auto-boat races on the Seine, from the Alexandre III. bridge to Suresnes and back.

Two new contests are announced for 1905—the Calais to London race, on July 15, and the International British Cup, which will probably be contested at Trouville about August 20.

CANADIAN CLUB'S FIRST MEET.

Special Correspondence.

MONTREAL, Oct. 17.—Delormier Park last Saturday afternoon was the scene of the first automobile races held here under the auspices of the newly formed Automobile Club of Canada. The weather was all that could be desired, and the attendance was very fair considering the number of counter attractions billed for that afternoon. The list of entries was encouraging, and the races on the whole fairly interesting.

The track is not banked, and is only a half mile in circumference. All of the cars entered were of the ordinary road variety and of limited power. The best time of the day was 8:18, for five miles, made by L. D. Robertson, in a 16-horsepower Rambler.

John Laliberte, of Quebec, was on the

track with his prize-winning imported Griffon motorcycle.

The summaries follow:

Two miles, for Stanley steam machines—L. D. Robertson, 1st; W. Caruthers, 2nd. Time, 4:12.

Two miles, for Queen gasoline machines—Husson, 1st; L. N. Patenaude, 2nd. Time, 4:54 1-2.

Two miles, for Rambler machines—Dr. Arthur Mignault, 16-hp. car, 1st; R. A. Ahern, 16-hp. car, 2nd. Time, 4:52.

Two miles, for French machines—D. Macdonald, 14-hp. Renault, 1st; D. Yuile, 15-hp. Panhard, 2nd. Time, 3:40 1-2.

Five miles, free-for-all—L. D. Robertson, 16-hp. Rambler, 1st; D. Macdonald, 14-hp. Renault, 2nd. Time, 8:18.

Two miles, single motorcycles—J. L. Laliberte, Griffon, 1st. Time, 3:58.

ENDURANCE RUN IS OFF.

Pacific Coast Contest Postponed to Next Year.—Run to Los Angeles Meet.

Special Correspondence.

SAN FRANCISCO, CAL., Oct. 7.—Announcement was made to-day by the management of the Automobile Club of California that the proposed endurance run to Los Angeles under the club's auspices is off so far as the present year is concerned. Chairman L. P. Lowe, of the executive committee of the club, states that a sufficient number of returns to the club's inquiries have been received to insure the success of the run if it should be decided to hold it at this time, but that with many of these replies has come an expression of opinion that a further postponement would be better for many reasons. In view of the expressed desire of the majority, Mr. Lowe states it is thought best to put the matter over until the coming spring.

As a consolation event for those who feel disappointment at their inability to engage in the endurance run this year, an informal run has been arranged to the race meet of the Automobile Club of Southern California, the Los Angeles organization, which will be held October 21 and 22 at the Los Angeles track. This run will be started from San Francisco October 17, the schedule providing for arrival at Los Angeles October 20. Chairman L. P. Lowe will be in charge of the party. Stops will be made at convenient points over night and a reasonable rate of speed will be maintained. It is felt by many that this will offer an excellent opportunity for those who intend taking part in the endurance run to familiarize themselves with the course.

SUNDAY PROGRAM FOR ST. LOUIS.

Special Correspondence.

St. Louis, Oct. 17.—Instead of a two-days' race meet, as originally planned, a one-day program of events has been decided upon, to be run off on the Fair Grounds Association track on Sunday, October 23.

The feature of the day will be a five-mile challenge race, with flying start, open to machines in the 1,432-2,204-pound class. This race will be a heat affair, best two-in-three, for a prize, valued at \$150. The seventh event will bring out a good field, as it is open to all machines listed at \$1,000, or less.

The following list of events is offered: Five miles, for owners, cars weighing 1,432 to 2,204 pounds, with road equipment and carrying four persons; one-mile record trials, for cars weighing 1,432 to 2,204 pounds; five-mile challenge race; motorcycle race at five miles, open to all; five

miles for machines weighing from 881 to 1,432 pounds; five miles, for machines costing \$1,000, or less, and weighing from 881 to 1,432 pounds.

BOSTONIANS BUNCOED.

State and City Officials Turn Out to See
Twenty-two Autos Pass.

Special Correspondence.

BOSTON, Oct. 17.—The so-called Automobile Parade of Commerce, which was held Saturday in connection with the exposition of the Commercial Travelers of America, was a fizzle from start to finish. It had been announced by the promoters that they expected to have 1,000 cars in line, representing all branches of the industry. The Governor had been asked to review the parade at the State House, and the Mayor at the City Hall. The Governor, accompanied by a half-dozen members of his staff, resplendent in gold-braided uniforms, was at his post on the State House steps. The Mayor, with other high city officials, stood in front of City Hall. The police department had kept up all its night men and had every available man in the department on the parade route. Traffic was stopped on the principal downtown thoroughfares for two hours, street-car lines were diverted, and business was generally tied up. All along the route thousands of citizens had gathered to see the great (?) display of motor vehicles. In fact, the preparations were as elaborate as for a parade the magnitude of the Hooker Day or the Grand Army parades. And all this to witness the passage of an even twenty-two vehicles in about two minutes—as many automobiles as can be seen in the same time any week day on Tremont street! To add to the gall and wormwood, most of the cars were advertising the Commercial Travelers' fair with banners, and the others were advertising other things.

In the parade were three big busses, loaded with commercial travelers, who advertised the exposition with a concerted yell; two heavy trucks with advertising features, half a dozen delivery wagons, as many more touring cars and a few runabouts. Some of those in the parade, who had entered in good faith, believing that there was to be a general display, were disgusted with the proceeding and would have pulled out had there been an opportunity.

It will be a long time before the city and state become interested in another parade of automobiles unless the officials are assured that they are not to be buncoed. And the local automobilists will be sure of the number of entries before they take part in another parade.

AN EXAMPLE FOR CHAUFFEURS.

A chauffeur who made unlicensed use of his employer's automobile has come up hard against the stone wall of the law, and is spending a term of thirty days in jail in lieu of a fine of \$75. The chauffeur is Edward Shotwell, and he was employed by Levi C. Weir, president of the Adams Express Company, 59 Broadway, New York.

Shotwell brought Mr. Weir to the city from his Long Island residence, and instead of putting up the car at the garage, proceeded, according to testimony, to take himself for an airing. He had lofty ideas regarding speed, and while reducing them to practice fell afoul of a policeman, who gathered him in. Before the Court of Special Sessions, on October 7, Shotwell was given his choice of a fine of \$75 or a month in jail, and, having more time than money, he chose the latter.

DISTRICT LOSING MONEY.

Capital City Learns that States and Cities Demand Registration Fees.

Special Correspondence.

WASHINGTON, D. C., Oct. 17.—In its first annual report to the District Commissioners, the automobile board states that the laws governing the use of automobiles are much more stringent in the different states than in the District of Columbia, and summarizes the laws of Connecticut, Massachusetts, New Jersey, New York, Pennsylvania, Rhode Island, Virginia and Maryland.

The board states that with the exception of Virginia every state whose laws have been quoted exacts a fee from the owner of a motor vehicle, and it recommends that a fee of \$1 be paid for the registration of and assigning a number to motor vehicles owned in the District of Columbia; also that a fee of \$1 be required for a permit to operate a motor vehicle in the District; these fees not to apply to motor vehicles or to operators that have complied with the similar law of any other state or territory.

The automobile board was created August 11 last year, and consists of six members, three of whom compose the board of examiners of steam engineers; two others are District employees, while the sixth member is Charles E. Foster, vice-president of the National Capital Automobile Club. The number of applicants examined to June 30, 1904, was 858, of whom 852 were recommended as competent to operate motor vehicles and were given permits; five were rejected as incompetent, and one, to whom a temporary permit had been issued, surrendered it before the regular permit was issued. Twelve permits were issued to tourists temporarily in the city. Many tourists must have failed to apply for these permits, for hundreds of them have been here since the new law went into effect.

On account of the similarity of numbers carried on automobiles owned in the District and those registered in Maryland, the board recommends that all automobiles registered in the District have added the letters "D. C." to the assigned numbers.

MULCTED UNDER NEW EXCUSE.

Special Correspondence.

PHILADELPHIA, Oct. 16.—One of the legal lights of Harrisburg, this state, opportunely discovering that the state law requires automobilists upon approaching road crossings or turn-outs to sound a signal, all hands compared notes, and agreed that this law was being almost universally ignored.

"We'll soak 'em!" was the decision. "These people must be taught to obey the law." And now the wily sheriff and his cohorts are abroad night and day, and the luckless wight who forgets or neglects to sound his horn on approaching a cross-road, even in the country sections, is apprehended, haled before the 'squire and relieved of sufficient pelf to assuage the outraged dignity of the township and the outrageous rapacity of its police. Upward of a dozen motorists were caught and fined last week, and the work goes merrily on.

The agricultural journals in the West are much interested in the automobile question, looking at it from the point of view of the horse driver, and, while some go to the most violent extremes in denouncing the horseless vehicle, others take a rational stand, recognizing the ear-marks of inevitable progress, and instead of raging against automobiles, instruct their readers how to train their horses not to fear them.



LETTERS TO RAILROADS.

Automobile Club of America Calls Attention to Grade Crossings.

Circular letters calling attention of the superintendents of railroads centering in New York and the metropolitan district to the negligence of engineers to sound the whistles or ring the bells of their locomotives when approaching grade crossings are being sent out this week by Secretary Butler, of the Automobile Club of America.

The letter calls attention to section 421 of the Penal Code of the State of New York, which makes it a misdemeanor to fail to give such warning before crossing wagon roads, refers to the too numerous recent grade crossing accidents that have resulted fatally to parties of automobilists, and states that the club has received many complaints that engineers fail to give proper warning of the approach of trains. It is assumed that the railroads need only to have their attention called to the omission, as they are desirous of avoiding suits for damages, but it is intimated that if it becomes necessary, the club will feel that it is incumbent upon it to take action looking to the enforcement of the law. Letters to the railroads that have terminals in Jersey City, Weehawken and Hoboken will cite the State law of New Jersey covering the same point.

Accidents resulting from the carelessness of hired chauffeurs and their unauthorized use of their employers' cars also were discussed at the last meeting of the board of governors of the club, and two resolutions were passed bearing on the subject. One recommended that the owners of cars hold their chauffeurs to strict accountability, and in case of their arrest and the imposition of a fine for fast or reckless driving, that the amount of the fines be deducted from the wages of the drivers. The other resolution requested the owners of garages in New York City to make a practice of keeping an accurate record of the cars in their charge and make weekly reports to the owners of the cars, stating the time of day when each car is taken from the garage and the time when it is returned.

Nominations for officers of the club for the ensuing year must be submitted by the nominating committee by November 1. The officers to be elected are: President, first and second vice-presidents, secretary, treasurer, and three governors to serve three years. The nominations are in the hands of George F. Chamberlin, F. G. Bourne and Paul Deming. President W. E. Scarritt is reported as having said that he would not be a candidate for re-election to the office of president.

The regular weekly meetings of the club will be resumed November 8 for the coming winter.

New members were admitted to the club at the meeting of the board on October 17 as follows: Active—John F. O'Rourke, of the O'Rourke Construction Co., New York City; John D. Adams, Bayshore, L. I.; P. Chauncey Anderson, New York City; C. H. Matthiesson, Irvington-on-Hudson; W. S. Fanshawe, New York City; Edward Dimon Bird, of Tiffany & Co., New York City; Loring Townsend Hildreth, New York City; John F. Talmage, New York City; Louis Sherry, restaurateur, New York City, and Walter Christie, New York

City. Non-resident members—John A. Dix, Albany; Joseph F. Flanagan, Newton, Mass.; E. N. Huggins, New York City; Baron F. Turckheim, Paris, and Mortimer B. Fuller, Scranton, Pa.

PRACTICAL CLUB WORK.

Springfield Club Plans Winter Lectures and Studies of Popular Cars.

Special Correspondence.

SPRINGFIELD, MASS., Oct. 16.—At its annual meeting last week the Automobile Club of Springfield made plans for a series of instruction meetings during the winter designed to give the members a better knowledge of the details of automobile construction and operation. This course will be divided into two parts, one consisting of about twelve lectures on varied subjects by authorities, and the other embracing actual study of the machines. Chairman W. E. McClintock, of the State Highway Commission, will give a lecture on State highway construction, and Mr. Jacobs, of the Pittsfield Coil Company, will speak on the construction of spark coils, with illustrative experiments. Other lectures remain to be planned.

The Knox Automobile Company has offered the use of its factory for one evening, with competent men to explain general construction and details. The Springfield Automobile Company will entertain the club one evening for inspection of Locomobile cars. One evening will be spent with A. A. Geisel, who will explain the Winton and Cadillac, and Whitten & Clark will show their Autocars and Oldsmobiles. These meetings will be informal.

An entirely new board of officers was elected, as follows: President, L. J. Powers, Jr.; vice-presidents, Mark Aitken, Dr. George H. Finch, Dr. J. W. Hannum, Willis F. Anderson; secretary, Dr. George Fenn; treasurer, W. L. Bunker; directors, Dr. V. J. Irwin, A. B. Case, Harry Daniel, Dr. F. E. Hopkins, A. A. Geisel, William Baush and Frank Bocorselski.

The reports showed the club to be in flourishing condition, with a large balance in the treasury. The retiring officers were given a vote of thanks for their services and responded.

NOTES OF THE CLUBS

PITTSBURG.—More than fifty applications for membership have been received by the A. C. of Pittsburg since its new clubhouse in the East End was opened September 5. Although the initiation fee has been raised from \$5 to \$25 the membership limit of 300 has almost been reached.

ST. LOUIS.—The local club has solved the chauffeur problem, to its own satisfaction at least. It has decided to grant licenses of approval to the chauffeurs driving the machines of members of the club and to others who merit them. These licenses will be based on the physical qualifications of the driver, his knowledge of the machine and his moral qualifications. They will carry no value except as showing the confidence of the members of the local club. The licenses will be revoked for cause.

The club has passed a resolution that it should be the duty of every member to report to the headquarters of the club any

case of excessive speeding that comes to his notice. The case will then be transferred to the proper authorities. The club is strong in the stand taken against violations of the city ordinances and is doing all in its power for their enforcement.

EXETER, N. H.—The annual meeting of the New Hampshire A. C. was held at Hampton beach October 6, when the following officers were elected: Reginald C. Stevenson, of Exeter, president; Arthur H. Sawyer, of Exeter, vice-president; Charles G. Sheldon, treasurer, and Williard M. Jenkins, secretary. The officers named, together with George E. Kent, were named as directors. Following the regular routine business of the meeting, a bird supper was served.

St. Louis.—Members of the St. Louis A. C. at a recent meeting voted without a dissenting voice to erect next year a new clubhouse farther out on the Clayton Road than its present quarters. In addition a downtown office will be opened and placed in charge of a secretary, who will look after the affairs of the club and the entertainment of visiting automobilists. A fund of information relative to the roads of the surrounding country, and in fact all information of importance to motorists, will be collected and placed at the disposal of interested parties.

Houston, Tex.—Thirty-five persons, many of them women, in fifteen machines, participated in the second automobile 'coon and 'possum run recently held by the Houston A. C. The run was made to C. L. Bering's rice farm, about ten miles from the city, on which is located a stretch of woods well suited for such purpose. Otto Webb was designated "official shaker," and provided with leg spikes for tree-climbing. After a hunt of some few hours two 'coons and a 'possum were bagged. A midnight lunch was served in the woods, during which thoughtful Harry Dooley produced from his auto a freezer of ice cream—to the women, the feature of the spread. Without further hunting the party made the return trip to Houston in the early morning hours thoroughly fatigued, but highly delighted with their novel outing. No mishaps, other than to the three animals, were recorded.

NEW PEERLESS PLANT.

Construction Begun on First of Group of Large Factory Buildings.

Special Correspondence.

CLEVELAND, Oct. 17.—As already announced in these columns, the Peerless Motor Car Company will occupy a new factory next spring, ground for the new plant having been broken on a 5 1-2-acre site on Oakdale street, adjoining the New York, Chicago & St. Louis Railroad tracks. The machine shop, a two-story building, 258 feet long and 50 feet wide, is already under construction. This is the first of a group of buildings which will cover the entire site. A foundry, 1,000 feet long by 70 feet wide, will also be put up at once. Other buildings which are projected for the company for next spring are an erecting shop and a painting and upholstering shop. The former will be 300 feet long by 60 feet wide, and the latter 200 feet long by 50 feet wide. The new plant will more than double the present facilities, and a large amount of new and improved machinery will be installed.

'According to the Troy (N. Y.) Times, there are now more than 100 automobiles owned in Troy.

WORLD'S FAIR AWARDS.

Medals All to Be of Bronze.—Concerns That Will Get Them.

All World's Fair medals are to be of bronze, according to information from St. Louis, although the awards are denominated "gold," "silver" and "bronze." The "gold" and "silver" medals are to be of the same metal as the medals awarded for the less meritorious exhibitions, being distinguished from them merely by having the words "gold" or "silver" stamped across their faces. The reason for this is ingeniously stated by the Fair officials to be that the Exposition company cannot afford the expense of giving so many medals of the more precious metals.

Notification of the awards made by the jury of automobile awards at the Fair to the American exhibitors has been sent to the exhibiting members of the National Association of Automobile Manufacturers by Manager Miles, of the N. A. A. M., as follows:

"We are advised that the following awards have been made at the St. Louis Exposition, and that there are others to be made that have not yet been made public:

"Grand Prize—Haynes-Apperson Co., George N. Pierce Co., Pope Motor Car Co., White Sewing Machine Co., and Woods Motor Vehicle Co. Gold Medal—Badger Brass Mfg. Co., Electric Vehicle Co., Hendee Mfg. Co., Knox Automobile Co., National Motor Vehicle Co., Packard Motor Car Co., Shelby Steel Tube Co., Veeder Mfg. Co., and the Vehicle Equipment Co.

"Silver Medal—Cadillac Automobile Co., Ford Motor Co., H. H. Franklin Mfg. Co., Gray & Davis, Grout Bros., Thos. B. Jeffery & Co., Olds Motor Works, Smith & Mabley, St. Louis Motor Carriage Co., E. R. Thomas Motor Co., and Winton Motor Carriage Co.

"Bronze Medal—Dayton Electrical Mfg. Co., Duryea Power Co., Motsinger Device Mfg. Co., Royal Motor Co., Twentieth Century Mfg. Co., and Waltham Mfg. Co."

In addition to the foregoing awards to American exhibitors, grand prizes were awarded in the foreign section for the exhibits of Renault, Panhard, Daimler, de Dietrich and Georges-Richard cars, and gold medals for the exhibits of Darracq and Benz vehicles.

A cleverly worded manifesto telling how nice an automobile exhibit is on view at St. Louis has been sent out by the National Association of Automobile Manufacturers. Reasons why the manufacturers didn't want to make an extensive exhibit in the earlier days of the movement are given. How this difficulty was gotten over and how pleased all the makers are with everything that has happened since are also set forth in good smooth English in this interesting paper. It shows that the cost to exhibitors has been only 50 cents a square foot, decorations and stand accommodations included. It is a pleasant little document, and it administers a nice little pat on the back of each one concerned. The general manager, S. A. Miles, has made quite an artistic job of the manifesto and sends with it for publication a fine large electrotype. As the illustrations have already occupied extensive space in these pages we regret that we are unable to make use of the excellent souvenir engraving.

BUFFALO SHOW QUESTION SETTLED.

Special Correspondence.

BUFFALO, Oct. 17.—At a meeting of the Board of Governors of the Automobile Club of Buffalo, a few days ago, it was

decided to accept the proposal of the Buffalo Automobile Trade Association regarding the automobile show to be held in the City Convention Hall next March. Some of the dealers have opposed the club's desire to take a part in the management of the show.

At the conclusion of the meeting it was announced that the show will be held by the trade association, but under the auspices of the automobile club. A committee of two—A. H. Knoll and H. A. Meldrum—was appointed to meet the representatives of the trade association to confer regarding arrangements for the exhibition.

N. Y. AUTO BOAT SHOW.

Decision to Assign Spaces in Order of the Applications.

The Motor Boat and Sportsmen's Show, which, as already stated in these columns, will be held at Madison Square Garden, New York, February 21 to March 9, 1905, was again discussed at considerable length at a recent meeting of the executive committee of the National Association of Engine and Boat Manufacturers, and some changes in the division of space were decided upon. The water front originally set apart for the use of launch builders was, after an estimate had been made of the probable demands for such space, deemed inadequate, and the island, which was at first intended for exhibitors of motors, has been assigned to launch manufacturers who desire water front space. The motors will be exhibited at the east end of the Garden. There will be two bridges, one at each end of the lake, and a promenade will extend the full length of the island, from bridge to bridge, passing between the "wharves."

The great demand for space has led the committee to decide that members' applications must be sent in not later than November 1, and that space will be assigned in the order in which applications are received, at a meeting to be held on Tuesday evening, November 1, at the office of the association. After this allotment, the remaining space will be assigned to any intending exhibitors who make application after November 1.

Space will be charged for at the following rates:

Water front space for demonstrating the operation of launches afloat, with space 10 feet deep on platform, \$30 for each lineal foot.

Space for motor exhibits at the east end of the building, \$20 for each lineal foot.

Gallery spaces, as shown in the diagram sent out by the association, \$120 each.

The association has opened offices at 314 Madison avenue, New York. This location is close to the Grand Central Depot, and out-of-town members of the association will be invited to make these rooms their headquarters while in New York.

RECENT INCORPORATIONS.

Rogers Automobile Co., Springfield, Mass.; capital, \$100,000. Incorporators, L. F. Ivers and C. M. Woodward.

Law Automobile Co., of Bristol, Conn.; capital, \$50,000. Incorporators, Frederick A. Law, of Hartford; F. M. Manross and E. Peck, of Bristol.

Morse Automobile Co., Springfield, Mass.; capital, \$250,000; to manufacture automobiles. Incorporators, Sewall Morse, of Detroit, Mich.; F. H. Young, J. Frank Drake, A. E. Snow, Edward H. Cullen, Charles L. Hoyt, J. Douglas Law and Clinton Gowdy, all of Springfield.

THE AUTOMOBILE

WEEKLY

NEW YORK—SATURDAY, OCTOBER 29, 1904—CHICAGO

10 CENTS

AUTOMOBILES IN MILITARY SERVICE.

THE military authorities of the principal countries of the world are showing an ever-increasing interest in the automobile, and are realizing that the motor vehicle is one of the most important factors in modern transportation, and not simply a vehicle suited to pleasure travelling only. It is believed by many military officers that the automobile will be-

sufficient power for leisurely, easy movement; baggage and supply trains made up of automobiles, and the list might be continued almost indefinitely. Quite extensive experiments have, in fact, already been made in these directions, mainly in England and on the Continent, though the United States Army authorities are giving the matter some attention. Most of the ex-

motor, was used in the autumn manoeuvres of the British Army on the Essex coast for transporting officers rapidly from place to place. The car used is illustrated herewith, the photograph having been taken at Wheeling, Essex, while on duty in a sham engagement. Lieutenant P. W. Northey is at the wheel, and seated beside him is the Danish attaché, Captain Alex. de Kauff-



MILITARY OFFICERS IN CADILLAC LIGHT TONNEAU CAR PHOTOGRAPHED WHILE ON DUTY AT A SHAM BATTLE AT WHEELING, ENGLAND, IN THE BRITISH MILITARY MANŒUVRES.

come an important adjunct to the equipment of an army; and it may not be many years before we shall see field guns hurried to the front by specially constructed motor machines; men in considerable numbers conveyed from place to place in big cars; ambulances motor driven, and field hospitals mounted on wheels and provided with

perimenting, so far, has been done with comparatively large and heavy cars. The light machine has undeniable advantages, however, as this season's endurance contests have shown. That this has been recognized, at least by English military men, is evidenced by the fact that a Cadillac light tonneau car, with 9 1-2-horsepower

mann, A. D. C. to the King of Denmark. The occupants of the tonneau are Major J. H. V. Crowe, R. A., on the left-hand tonneau seat, and the Italian attaché, Count Trombi, on the other side.

The motorcycle, as well as its larger relative, the automobile, is coming in for considerable serious attention from military

officers in various countries, who believe that it will form a valuable addition to their field equipment if it can be sufficiently substantial and reliable to stand the severe tests military service would necessarily entail. The subject of military motorcycles is just beginning to receive practical consideration from the army officers in this country, but in England and on the continent more progress has been made, there being quite a number of volunteer and regular motorcycle corps in existence. Germany, always progressive in matters military, has taken up the motorcycle, and the accompanying photograph shows a number of Teutonic Tommies making a thorough investigation of a machine.

As a result of growing agitation in England against the use of the highways for automobiles, the proposition has been put forward by members of the Roads Improvement Association to repair and adapt the old Roman roads to motor vehicle traf-

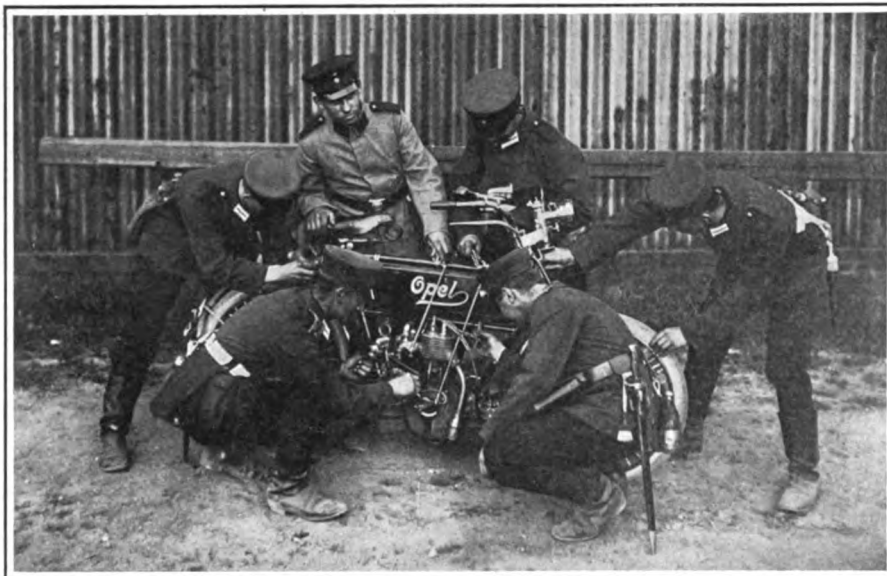

GERMAN SOLDIERS LEARNING THE MYSTERIES OF THE MOTORCYCLE.

fic. These old highways are, in many cases, almost entirely unused, and a sub-committee has been appointed to look into the practicability of putting them into usable condition. It is pointed out by a military authority that in the event of an invasion of England, the very probable extensive use of automobiles for military purposes would render such roads of the highest importance and value.

The Paris-Lyons Mediterranean Railway Company has inaugurated an automobile train service over its line between Paris and Monterreau, a distance of forty-five miles. The cars are thirty-six feet in length, with first-class passenger compartments for twelve persons; second class, twenty-four, and accommodation for twelve additional on the platform at the rear. Each car costs \$8,000, as against \$22,000 for the ordinary steam locomotive.

Auto-Boat Race to Poughkeepsie.

Smith & Mabley-Crocker Match Changed to Open Race—Details of Construction of Crocker's Herreshoff Built Boat.

THE proposed private match between the *Challenger*, owned by Smith & Mabley, and the new speed launch just completed by the Herreshoff Manufacturing Co. for Frank Crocker, on Saturday, October 29, has been changed to an open race, and promises to be one of the important events of the season. In addition to the *Challenger* and the Crocker boat, the *Vingt-et-Un II.* and the *Onontio* are entered, and several other fast launches are expected to enter before Saturday.

The original proposal was for a match race from New York to Albany and return, but this was changed to a shorter course, New York to Poughkeepsie, where fuel will be taken in a control, and return. The start will take place on Saturday

inches; the after end of the keel runs up to meet the transom at the waterline. The stem rakes forward at a moderate angle, the freeboard being about 3 feet; the forefoot is rounded off into the keel, which runs down gradually to a point a little forward of the mid-length, then up more rapidly. There is an outside keel about 2 inches wide and 1 inch deep, widening to 4 inches where the shaft passes through.

PECULIAR FORM OF STERN.

The stern is peculiar, and not easily described without a picture. The deck plan shows the breadth well amidship, narrowing in quickly toward the stern, which ends in a point. There is a raking transom, approaching a V in horizontal section, but with the sides slightly curved and also flaring out at the top. The depth of this transom is one foot, which is the freeboard at the stern.

The load waterline is quite straight in the forebody, with just a little hollow at the entrance; in the afterbody it runs to a point at the transom. All the thwartship sections from stem to stern show a flat V shape, the midship section having an easy bilge and a moderate flare to the topsides. The sections of the afterbody all are out to meet the deck, which is the widest part; there is no suspicion of tumble-home anywhere. The forward sections also show a good flare, in addition to the fairly high freeboard.

SECTION OF TURTLEBACK.

The crown of the turtleback is not a circular sweep, but flattened in the middle with a good round to the sides. The turtleback extends about half the length of the boat, completely covering the motor, and at this point it has a high crown. The deck beams are of bent oak, about 1-2 inch square, and spaced 5 1-2 inches on centers, the decking is of 5-16 inch white cedar, covered with painted canvas. Immediately over the motor the turtleback is cut, the two halves being fitted with hinges to open outward. From the termination of the turtleback the deck slopes down quickly alongside the cockpit, the after deck having very little crown. It is only from 12 to 15 inches above the water.

HULL IS DOUBLE-SKIN.

The hull is double-skin, the outer planking of mahogany, the frames being of bent oak, about 1-2 inch square and spaced 5 1-2 inches on centers, a few frames in the way of the engine being of larger size. The engine, a Mercedes car motor of about 90-horsepower, with the Mercedes belt reverse, is carried on two engine keelsons of oak running well fore and aft.

The cockpit is about 9 feet long, with a low flaring covering. The finish of the

morning, from the Columbia Yacht Club, foot of West Eighty-sixth street, New York.

HERRESHOFF'S LATEST IDEAS.

The Crocker launch, which passes under the peculiar name of *X. P. D. N. C.*, is a most interesting craft, apart from the fact that she represents the latest ideas of N. G. Herreshoff, a master in the designing of the fastest of power and sailing craft. Like most Herreshoff boats, she is thoroughly original in form and detail. The striking features are the absence of purely freak ideas, and the very complete protection afforded by a long turtleback and a small cockpit.

The exact dimensions are not known, but the hull is about 45 feet long and between 5 and 6 feet in breadth. The greatest drop to bottom of keel amidship is about 12 inches, and at the forefoot it is about 8

boat, within and without, is shipshape and workmanlike, there being nothing temporary or flimsy. The wheel is about 22 inches diameter by 42 inches pitch, with three blades, each almost rectangular in shape, the breadth being about 6 inches at the hub and 5 1-2 inches at the outer ends, which are almost square. The rudder is of bronze, mounted just abaft the wheel, about 15 inches long on top, nearly rectangular, but with the lower forward corner cut away; the same rudder as in the old Herreshoff half-raters.

The bronze tiller swings over the deck, with flat-link bronze chain in the pulleys and light steel wire along the deck. Small and neatly made bronze turnbuckles are used to set up the tiller lines. An automobile wheel is used, about the middle of the cockpit.

The hull is very handsomely finished, the entire outside, below and above water, being varnished. The boat is undoubtedly very fast, and she is reputed to run easily without going off her trim. A test of this model with *Challenger*, *Vingt-et-Un II.*, *Onontio* and other speed boats should give valuable results.

Auto-Boat Onontio.

A RECENT addition to New York's fleet of auto-boats is the *Onontio*, launched recently at the works of the Electric Launch Co., at Bayonne, N. J., where she was built for Commodore Harrison B. Moore, of the Atlantic Yacht Club. She is the work of two designers, Henry J. Gielow and James Craig, Jr., of New York, laboring together to produce a perfect combination of hull and machinery, with a view to high speed. Mr. Gielow is well known from his many successful yachts, both power and sailing craft, and by his work in general marine engineering. Mr. Craig has been engaged for the past four years in the building of the usual type of fairly heavy marine gasoline motor for cruising yachts, auxiliaries and working vessels. The new motor is a radical departure, every effort being made to produce a high-speed motor of great power with a minimum of weight.

The hull is 60 feet over all, 59 feet 9 inches on deck and 57 feet 11 inches on the water line, with a breadth of 7 feet and a draft of

1 foot 6 inches, the extreme draft being 3 feet. As in all of Mr. Gielow's later yachts, the dividing lines or ribband lines are the prominent features of the design, these being made perfectly fair and of easy sweep. The entrance is long and fine, and the raking midship section gives a clean run. The stem rakes forward and the stern is of the torpedo type, semicircular in plan.

The boat is built with a bent keel of oak, 10 inches wide amidships and 1 3-4 inches thick, with a stem worked from a hackmatac knee. The frames are of steamed oak, sided 7-8 inch, moulded 7-8 inch at heels and 3-4 inch at heads, spaced 8 inches on centers. Floors of white oak are used beside each frame. The planking is double, 3-8 inch mahogany outside and 5-16 inch white cedar inside, both skins running fore and aft, with a special cement between and well riveted between the frames. A heavy white oak sheerstrake, worked with a solid moulding, is used, with planksheers of 5-8 inch mahogany and decks of narrow 1-2 inch white pine. There are six watertight bulkheads, each built of two thicknesses of 5-16 inch white cedar crossed diagonally and laid in cement.

A special feature of the hull is the fore and aft trussing from end to end, giving more than local support for the engine and also stiffening the entire hull. There are two trusses, parallel to the keel and about three feet apart, each with a lower member in the shape of a side keelson of yellow pine 2 by 2 1-2 inches, and an upper member 2 1-2 by 3 inches, with deep floors of hackmatac separating them, the whole being thoroughly bolted with Tobin bronze rod. The whole floor system of the boat is thus one large truss, and the engine bedplate is supported upon oak keelsons side by side with each of the upper members and resting on the hackmatac floors.

There are three cockpits, the forward one, of heart shape with pointed coaming, for the helmsman, the middle one for the motor, and the after one for the passengers.

Apart from the motor itself, the details are original and interesting. The exhaust from each group of four cylinders is taken separately in large copper pipes and carried through the bottom of the boat near the keel. Two rudders are used, each rec-

tangular, about 12 inches deep and 15 inches long, placed on each side nearly abreast the propeller. Each is partly balanced, of bronze with a stock of the same metal, and below the deck each carries a short tiller, the pair being connected by a bronze rod, to which the steering lines are made fast. The steering wheel is of the ordinary yacht type, at the forward end of the cockpit.

The propeller is of the reversible type, three-bladed, the blades operated by bevel gearing from a central arbor within the hollow shaft. The hub is circular in form, ending in a long conical taper aft. The blades are of peculiar form, nearly circular in shape and about one foot in diameter. The maximum pitch of the wheel is something over 5 feet, with a diameter of 30 inches; the pitch may be decreased while running, or the blades may be feathered or reversed. The blades are controlled by a screw gear and handwheel, the latter similar to the steering wheel of an automobile, on the port side of the engine.

The motor follows in a general way the modern marine type of steam engine, with open framework, the cylinders supported on light stanchions running up from a cast bedplate. It is of the four-cycle type, with eight cylinders, each 7 3-4 inches diameter by 10 inches stroke. The cylinders are independent of each other, but arranged in two groups of four each, being practically two four-cylinder engines in tandem. The bedplate is of the box-girder type, cast in manganese bronze, in two pieces bolted together. Each cylinder is cast with four arms at the lower end, the stanchions passing through the arms. There are ten stanchions of steel about 7-8 inch in diameter for each four cylinders, with diagonal braces thwartship.

The water-jackets are cast with the cylinders; the cylinder heads are in the general form of a stuffing-box gland, turned to fit down into the upper end of the cylinder with a copper packing in the joints, each head having projecting lugs for the holding-down bolts. The heads which contain the valves are provided with ample space for the circulating water, the main water-jacket in each cylinder being connected with the water-jacket in the head by means of a separate brass pipe with unions, an-

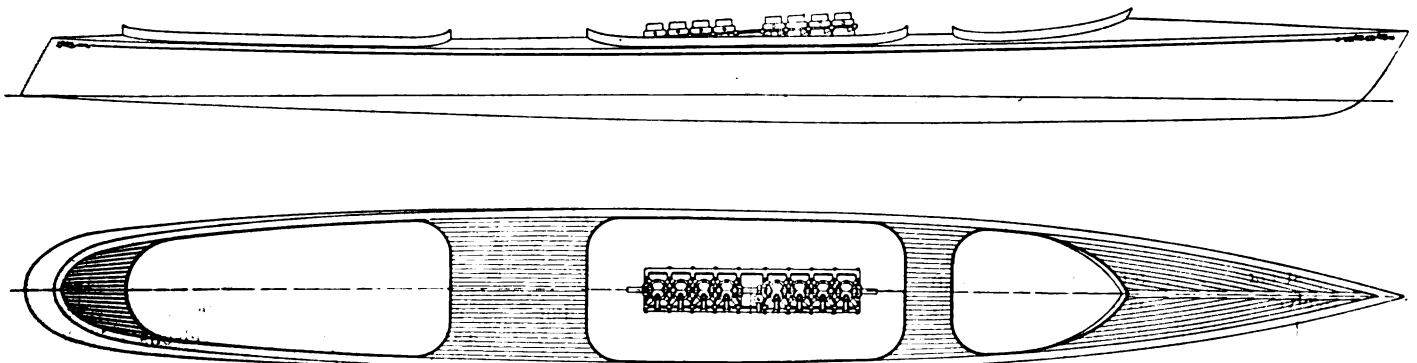

OUTBOARD PROFILE, SHOWING WATER PLAN AND DECK PLAN OF THE NEW AUTO-BOAT ONONTIO BUILT FOR HARRISON B. MOORE, FROM HULL AND ENGINE DESIGNS BY HENRY J. GIELOW AND JAMES CRAIG, JR., OF NEW YORK.

other similar pipe carrying the water from the head to the exhaust pipe.

Special attention has been paid to the sizes and shapes of the inlet and outlet passages. Copper pipes of large diameter and with easy curves and no sharp angles are used for the gas, and the inlet valves are double and mechanically operated. Similarly, double exhaust valves are used, with large exhaust pipes sweeping down and aft in easy curves to outlets in the bottom of the launch just abaft the motor. Each group has its own exhaust opening, the out-board delivery being a bronze casting forming part of the bottom of the boat, the aperture being rectangular and about 4 inches by 18 inches—the greater dimension running thwartship—and raking aft. No muffler is used, but it is expected that there will be a free delivery of the exhaust without noise or back pressure.

The crank shaft is in two parts, connected by a clutch which forms a part of the flywheel, located between the two groups of cylinders. The clutch may be disconnected and the four after cylinders run alone. The flywheel is very small and light, only 18 inches in diameter with 5 inches face.

The main bearings and crankpins are bored out, and the shaft is shaped according to torpedo boat practice. The two end cranks of each part are at angles of 180 degrees with the two middle cranks, and each set of four is at angles of 45 degrees with the other.

The half-time shaft lies on the port side, abreast the cylinders, carrying the usual cams. It is driven from the main shaft by a vertical jackshaft with helical gearing, a feature of all the Craig motors. The valves are, as already stated, in the cylinder heads, two inlet and two exhaust. Two bronze brackets bolted to each cylinder carry a short shaft, on which rock two bell cranks, the vertical arm of each being in contact with its cam on the half-time shaft, while the horizontal arm, running thwartship over its two valves, bears on their spindles. One valve is timed to open a little in advance of its mate, so as to relieve the pressure.

The connecting rods are hollow, carrying oil to the crankpins; positive lubrication is provided to all bearings by means of the feeder between the two parts of the motor. The dynamo is also located between the fourth and fifth cylinders. The make-and-break ignition is used, as perfected in the older motors. The motor is designed to give 175 horsepower at 650 revolutions; it will, of course, be run much faster, with a proportionate increase of horsepower when bearings and pistons are in perfect condition. The total weight of the motor is but 3,500 pounds.

The *Ontio* has been under trial on Newark Bay and New York Bay for the past month, and, if reports be true, she will put all American records in danger. She will make her debut in the New York Poughkeepsie race Saturday.

Lava in Commercial Form.

Lava, in its commercial state, familiar to automobilists by its use for the insulation of spark plugs and for burner tips in acetylene lamps, is not the natural volcanic product, but is made of talc, ground and compounded into slabs, when it may be sawn, turned, drilled and otherwise machined with tools very similar to those used for the manipulation of brass.

Having been reduced to the proper forms, the pieces are kiln baked at a temperature of 2,000 degrees Fahrenheit, after which they are unaffected by any temperature lower than the baking temperature, and are so hard that they can scarcely be cut without the use of a diamond.

An advantage claimed for lava is that its expansion and contraction from changes of temperature are so extremely slight as to be practically negligible. Its insulating qualities are placed very high—from 75 to 250 volts for each 1-1,000th of an inch of thickness, the exact figure depending upon the density and other qualities of the sample tested. The cost of manufacturing lava is said to have been reduced so greatly that it is frequently cheaper than wood, horn, fiber or rubber compositions. Lava can be turned out in almost any shape desired, and screw threads can be cut on rods of this material with the greatest facility.

An interesting treatise on the subject is issued by the American Lava Company, of Chattanooga, Tenn., which has offices in both New York and Chicago. Its booklet is illustrated with a number of interesting engravings showing about 150 forms of lava products.

Denmark Wants Postal Stages.

The Danish Government, through a commission composed of post-office officials and especially appointed engineers, has been making investigations regarding the adaptability of the automobile for mail service over short routes, and has arrived at the following conclusions:

That the service rendered by the automobile, in cases where it has been used for mail and similar work, is of the best; that the motor vehicle has an advantage over railroad trains in the matter of punctuality on short routes, and that the automobile is a great saver of time in this work.

It is now the intention of the Danish Government to replace the present horse-drawn stage coaches with automobile stages, which will, in addition to transporting the mails, carry sixteen passengers and a quantity of freight each. To this end a contract has been entered into with a Danish concern to deliver mails over the stage routes for a period of ten years.

The vehicles to be used will be passed upon by the government commission, whose decision as to suitability will be final. The conditions they are required to fulfill are decidedly severe. The commission must first approve of the body of the vehicle. The

machine must be run 1,243 miles, at the manufacturer's expense, after leaving the factory, having on board an appointee of the commission all the time. The car will then be taken to pieces and every individual part carefully examined and cleaned, and after readjustment, will be run for three days more, still at the maker's expense. The machine will then be sent to Copenhagen, where it will be operated for three months by a driver furnished by the maker, accompanied, as before, by an agent of the commission. During this test the commission will pay the driver and furnish supplies and housing for the car. One-third of the price of the machine will be paid to the makers when the car is ordered, one-third upon its delivery at Copenhagen, and the remainder at the end of the three months' trial, if the vehicle is found satisfactory.

The car must have accommodation for sixteen passengers, including the driver, and also for a ton of freight, all of which must be hauled up a 9 per cent. grade at an average speed of twelve miles an hour. Raymond D. Frazier, United States Consul at Copenhagen, Denmark, who gives the foregoing information in one of his reports, states that the commission is desirous of interesting American manufacturers. Letters sent to the consulate will be forwarded promptly to the proper officials.

TO CONTINUE WORLD TOUR.

Special Correspondence.

BOSTON, Oct. 24.—Two weeks from Wednesday, that is, on November 9, Mr. and Mrs. Charles J. Glidden, who are now in this city, will continue their world-girdling tour by automobile. Their car is now in Vancouver, where it was left after they had completed their tour across the continent, partly on the railroad tracks, this fall. They will ship their car first to Suva, capital of the Fiji Islands.

From the Fiji Islands the route which the Gliddens have mapped out is to New Zealand, Tasmania, Australia, New Guinea, Java, Malaya, Sumatra and Borneo, in all about 6,000 miles. The weather in these lands during our winter season is warm and dry, the climate of Wellington, New Zealand, being about the same as that of Boston in July. In New Zealand there is an information bureau for tourists under the direction of the government, and offices are located at all principal points. The scenery combines the beautiful features of all countries, and the points of interest can be reached by good roads.

The Gliddens will take along the railroad wheels for their automobile, to be used in going to places that cannot be reached easily by the highways. During the close of 1905 they expect to drive in Japan, China, India and Egypt, and will return to Boston in 1906.

The Russian government is reported to have ordered several railroad inspection cars from the Olds Motor Works, to be used on the Siberian Railway.

EIGHT-CYLINDER FOUR-CYCLE CRAIG GASOLINE MOTOR FOR AUTO-BOAT ONONTIO.

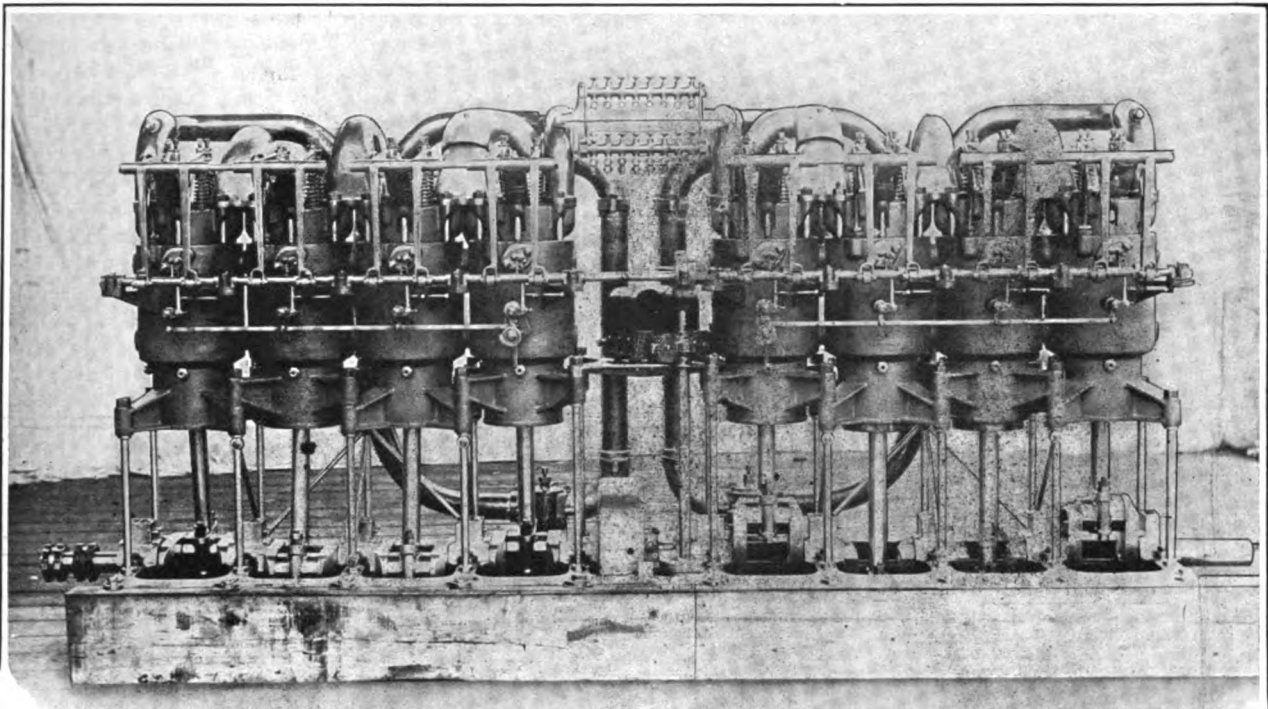

Port Side, showing Half-time Shaft, just Below Tops of Cylinders, and Lower Ends of Bell Crank Tappets.

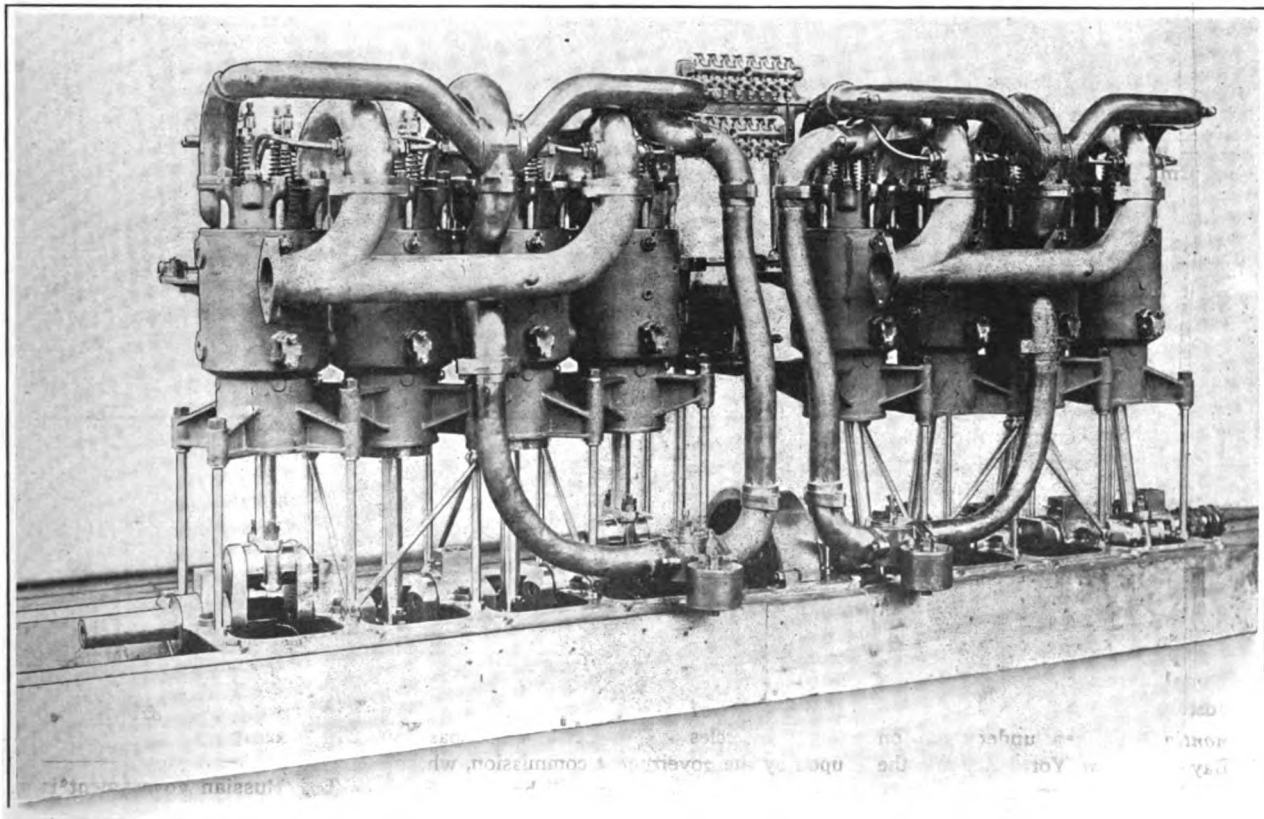

Starboard Side, showing Comparative Sizes, and Shapes of Inlet and Exhaust Pipes.

Development of Motoring in Toledo.

Special Correspondence.

TOLEDO, OHIO, Oct. 24.—When Peter Gendron, president of the Gendron Coal Co., brought his 6-horsepower Winton automobile to Toledo, his machine was the first owned in Toledo, if not the first ever seen on her streets, and it attracted much attention. That was in 1898, and now instead of one automobile there are more than 250 in Toledo, and the number is rapidly increasing. And Mr. Gendron, instead of being looked upon as a foolish experimenter, as he was then, is honored as Toledo's pioneer motorist. Many of the most ardent local automobilists bless the day when he first frightened horses on the downtown streets. His vehicle, then looked upon as a monster, did good work until a few months ago, when it was completely demolished by colliding with a street car.

From one car to 250 in six years tells in eight words the growth of automobiling in Toledo. Tourists and visitors from other cities state that for its size and comparative wealth Toledo has more automobiles in active use than any other city in the country.

The first machines used here were devoted almost exclusively to pleasure. While the great majority are largely confined to that use, yet business and professional men have adapted them to their needs within the past year. Few physicians—perhaps not more than a dozen—use automobiles regularly in their work, but this number is significant when it is borne in mind that little more than a year ago the doctors using them could be counted on the fingers of one hand.

Merchants are gradually adopting them as delivery wagons, and none who has tried them has returned to the use of horse and wagon. Business and professional men are also beginning to use them in going to and from their offices.

The latest and most successful tour by Toledoans has just been completed by Mr. and Mrs. J. R. B. Ransom and H. G. Tillson, who made a trip to Chicago, returning by way of Dayton. When alighting at their homes they were loud in their praise of that method of traveling.

The Toledo Automobile Club, with about 80 members, frequently arranges for and conducts Saturday afternoon runs. These usually take in a number of near-by towns and average from thirty to fifty miles, sometimes reaching as high as seventy-five miles in length. In the office of the secretary of the club is a record of nearly all persons owning machines in Toledo. It is kept as nearly up to date as possible, and shows that of the machines owned here about three-fourths are of the gasoline class. Of the remainder, perhaps a half-dozen are steamers and the rest are electrics. In the residence district, where women aspire to the ownership or the driving of an automobile, the electric machine is found.

Much of the activity in local automobile circles during the last two years has been brought about by the Toledo Automobile Club, which was formed largely through the personal efforts of Dr. Charles P. Wagar, who was president last year and is now secretary. In the summer of 1902 Mr. Wagar circulated a call among automobile owners for a meeting to form a club. The initial session was well attended and a temporary organization resulted. In a few days another meeting was called, and when it adjourned the Toledo Automobile Club had been founded. Its first officers were: President, D. A. Leffring; vice-president, C. P. Wagar; secretary and treasurer, G. D. Palmer, Jr.

Since then the club has been foremost in bringing about the improvement of country roads, the development of automobiling as a sport and a pastime, and the education of the public to the fact that the automobile is a necessity. A special committee has just completed a road map of a number of the counties in northwestern Ohio, and when the participants in the New York-St. Louis tour passed through the city they were presented with good maps showing the best roads leading out of the State. At present the club is urging concerted action by the Detroit, Cleveland, Toledo, Cincinnati and Chicago automobile clubs in the publishing of a map showing the best routes between these cities.

The club wielded not a little influence in automobile legislation at Columbus last winter, although it fared not so well in reference to city laws. The local license law, which is now being enforced after being a dead letter for two years, requires the payment of an annual registration fee of \$4 by owners of machines. This is looked upon as exorbitant, when neighboring cities require only a quarter or half as much, and already the club is laying careful plans for a change in the ordinance.

Well-furnished club rooms are maintained in the Toledo Conservatory of Music, and a modern clubhouse is already projected by the more progressive members.

The roads around Toledo, generally speaking, are fair, and little trouble is experienced in reaching any of the points of historic or scenic interest. A ride down the Maumee Valley on one side of the Maumee River and back on the other side possesses never-failing charms. The roads are excellent, and hardly is one historic spot passed until another comes into view. Here is Fort Meigs, there is the battle ground of Fallen Timbers, a little further on is the widely known Turkey Foot Rock, and so on, for a long list of interesting places prominent in the history of the old Northwest and of the campaign of "Mad" Anthony Wayne in northwestern Ohio.

To the north is Monroe, with its battle-famed River Raisin, and a few miles further on is Detroit, with its Belle Isle and boulevards. Inside the city limits of Toledo are parks and boulevards enough for an afternoon's good ride. They are extensive, well kept, and never so crowded as to make automobile driving unsafe or tiresome.

Mention should be made of the home of the Pope Motor Car Company. With its 1,000 employes, it turns out during the busy season from thirty to thirty-five machines a week. A number of improvements have been made in the factory during the present season, and within a short time it will add to its already extensive plant a large addition that is now building. In addition to this, there are four well-equipped retail stores and garages in the city, where machines of any make can be purchased or repairs secured.

An account of automobiling in Toledo, be it ever so brief, would be incomplete without at least a reference to Barney Oldfield. The city looks to him as her representative on the race track or on the road where a strong heart and steady nerve are required. Oldfield's mother is a quiet, nervous little woman, who takes great pride in her son's achievements.

H. H. Lytle, also of this city, has created a name for himself as a driver this season, and his development is being watched closely by local enthusiasts.

The Fickle Crowd.

I.

An automobile broke down. The chauffeur tried to find out what was the matter with it, but could not, and the occupants of the vehicle had to get out and walk.

"Get a horse!" yelled the crowd.

II.

A horse balked. The driver tried every plan he knew of to start the animal, but it wouldn't budge.

"Get an automobile!" yelled the fickle crowd.—*Chicago Tribune.*

Mr. Gurney, third clerk of the British embassy at Washington, who was riding in a fast automobile, and was fined by a Massachusetts 'squire in defiance of the law of nations and the peace and dignity of the kingdoms of half the world or so, is still in the newspapers. It is now recited that he was simply riding in the questionable automobile, and was the guest of another man, who was the real infractor of the village ordinances whose breaking caused the trouble in the first place. All right. We are willing to admit this and almost anything else that Mr. Gurney desires if he will only subside, go on with his writing or go home, and not obstruct the journalistic view of the Russo-Japanese war, the presidential campaign, the barb wire factory, the Kraehwinkel festival and other things of more importance than he is.—*Transcript, Peoria.*

Experimental Spring Wheels.

The accompanying illustration shows the essential features of a spring wheel invented by Dr. Horace A. Taylor, of San Jose, California, and experimentally applied to a heavy automobile built especially for W. E. Mack, of South Bend, Ind. The object of the invention is to secure a suspension that will render a pneumatic tire unnecessary by providing springs in its stead to absorb vibration caused by road inequalities. The wheel has a double hub, the inner member being movable in the plane of the wheel and prevented from moving laterally by plates or flanges. Six pairs of coil springs afford the required elasticity. Each pair is mounted on a yoke carried on the end of a threaded rod projecting from the periphery of the outer hub. A rod extending from the inner hub passes through each spring, sliding freely through the yoke, but being rigidly secured to the hub at its inner end. These rods serve to hold the parts in position and act as guides for the springs. The tension of the springs is regulated by nuts on the end-threaded rods passing through the centers of the yokes.

The device is said by Mr. Mack to have proved entirely successful, both in absorbing vibration and in transmitting power. If a spring breaks it can be replaced on the road with a very small outlay of time and money. The front tires of the experimental set of wheels are of plain steel, while those



AN INVENTION OFFERED AS A SUBSTITUTE FOR PNEUMATIC TIRES.

on the rear wheels are of channel steel, the channels being filled with hydraulic packing to give traction.

Tour of British Isles.

The Oldsmobile light touring car and Oldsmobile runabout which Charles Jarrott & Letts, Limited, of London, the English representatives of the Olds Motor Works, sent out on September 21 to make a run

of 3,000 miles through the British Isles, under ordinary touring conditions, recently completed 2,000 miles on schedule time with no serious trouble of any kind.

During the first part of the run the roads were in good condition, but rain set in later and the roads, especially in Ireland, were so slimy that at time progress was almost impossible. The schedule calls for 100 miles a day for thirty days. After fifty miles in the morning there is a noon stop for lunch, when adjustments are made, oiling done and supplies taken on, as in ordinary touring.

During the portion of the run that lay through Ireland, much interest was shown by the populace, who would frequently come considerable distances, it is said, to watch the cars go by. Some trouble was experienced with excited drivers, who would cover up the heads of their horses with sacks, hold down their ears and try in other ways to shut out the strange sight and sound from their animals. These, however, seemed to stand the shock better than their drivers.

A source of danger frequently encountered was the rather common appearance at night of wagons jogging along with drivers fast asleep and no lights shown. Stray animals also caused annoyance, a donkey on one occasion being run into by the light tonneau. The shock threw the animal and automobile into the ditches on opposite sides of the road, but neither was any the worse for the encounter. When he regained his feet the donkey stood watching the automobile with interest.

Experiments with motor vans in the Paris postal service having proved most satisfactory, it was decided to place a number of electric vehicles in service about the middle of this month, transporting mail between the central and suburban post offices. The service will be much improved by the saving in time.



Three gasoline passenger 'busses like the one illustrated herewith, are in daily use on a regular route between Etna and Allison Park, Pa., a distance of five miles. These vehicles are operated by the Auto Traffic Company, of Pittsburg, Pa., organized some months ago. Citizens of Sharpsburg and Hoboken are said to have asked that the stage line be extended to those places. A fare of twenty cents is charged at present, and the enterprise is said to be paying well. Plans are being considered for the establishment of cross-town lines in Pittsburg, and also for the operation of special lines for the transportation of school children. The chassis of the bus illustrated is a Knox product, while the body was built by the Ellis Omnibus and Cab Company.

Adams-Farwell Car with Rotating Motor.

A gasoline automobile embodying some ingenious departures from common practice has lately been produced, as the result of experiments extending over several years, by the Adams Co., of Dubuque, Iowa. Although the makers are withholding certain particulars, notably regarding the change gear device, the following details, made public by them, will be of interest:

The motor has three cylinders radially disposed about a common crankshaft, but, instead of the shaft rotating, the cylinders and crankcase themselves revolve, the shaft being fixed. Thus the cylinders, which are air-cooled, are at all times in a strong centrifugal air current of their own making, regardless of the speed of the car. This feature permits the use of large cylinders

der the rear seat in a partly closed compartment, and is geared to the speed changing mechanism directly below it, from which a single chain driving to the live rear axle completes the transmission system.

Examining the motor in detail, it will be seen that the large end of each connecting rod is suitably forked so that the single crankpin may accommodate three rod ends, and that the rods work on a common sleeve bushed with bronze, which performs the actual rotating about the crankpin and distributes the pressure, while the rods turn on the sleeve to the slight extent required by the in and out movement of the pistons. The rods are bronze castings.

The periphery of the crank case is built up of three sectors, each cast integrally with

currents, into which the exhaust gases discharge, the usual bark of the exhaust is subdued so that, as they express it, the discharge "acts upon the air like a skyrocket, not like a gun."

The carbureter operates with a constant level, but no float is used, the gasoline being pumped through the upper pipe 19, Fig. 3, into the overflow cup 18, in which is a cavity covered with a watch crystal, through which the level may be noted and water, if any, detected. The surplus gasoline returns to the pump well 20 by the lower tube. From the cup 18 the gasoline passes through a needle valve, regulated by hand, to a second needle valve attached to the light swing valve across the air pipe at the top of Fig. 4. The air passes through the linen filter indicated by the dotted lines, and, impinging on the swing valve, lifts the latter and with it the second needle valve,

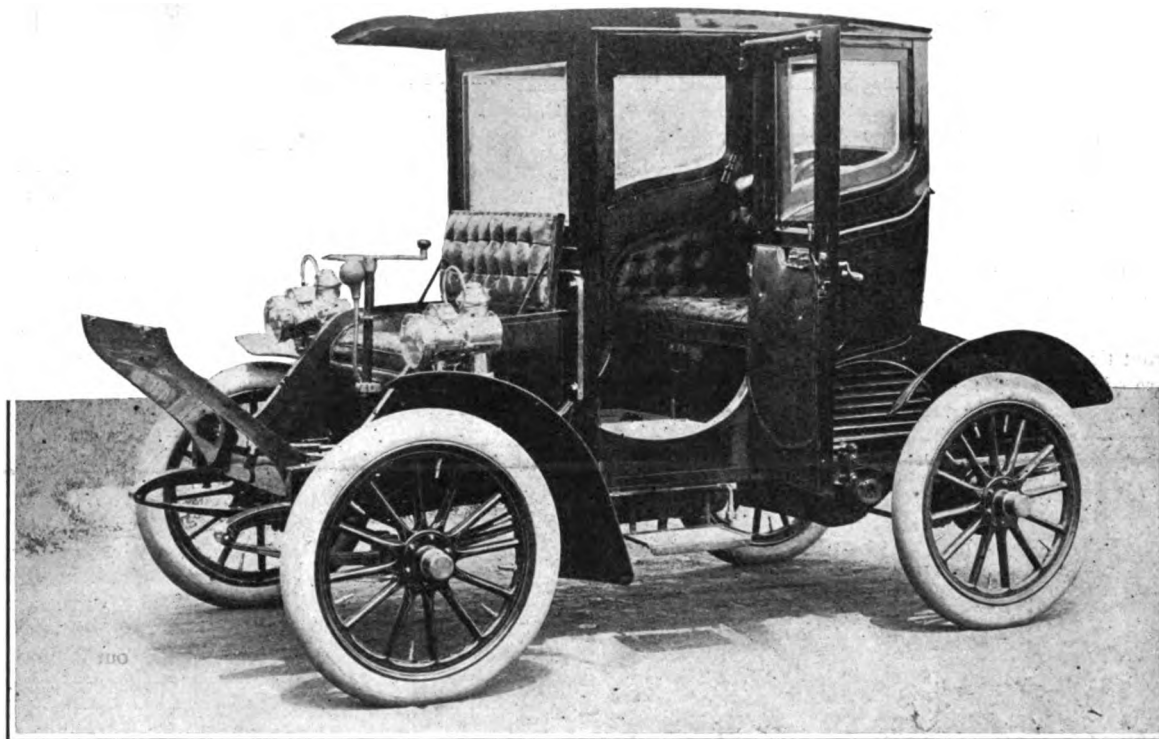

FIG. 1.—ADAMS-FARWELL "CONVERTIBLE BROUGHAM," HAVING NOVEL FEATURES OF BODY AND MECHANISM.

without overheating, the bore being 5 inches and the stroke 4 1-2. The motor is rated at 20 horsepower, and is stated to weigh 230 pounds, of which 190 pounds are in the revolving parts. The absence of the usual flywheel—here unnecessary—and the use of a single pair of cranks and a short crankcase for all three cylinders, explains the exceptional lightness.

Instead of being disposed in the conventional manner with the shaft horizontal, the motor revolves in a horizontal plane about a vertical axis, and transmits its motion to the speed changing mechanism by bevel gears. This is done partly for convenience in arrangement, and partly, no doubt, to get rid of the gyrostatic effect of so heavy a revolving mass in resisting the steering of the car on curves. As the illustrations show, the motor is located un-

der its cylinder, and is held together in part by the cast steel top and bottom heads. A single cam, actuated by gears in the lower part of the case, actuates both the inlet and exhaust valves of all three cylinders. These valves have very light springs, the makers relying on the centrifugal force of the valves themselves to close them, except in starting and at low speeds, when the springs are needed.

A singular feature of the engine is that no muffler is employed, the exhaust gases passing directly from the cylinder into the centrifugal air currents drawing past the longitudinal ribs of the cylinders. Supplementary ports in the cylinder walls are uncovered by the pistons, so that the valves open against a pressure little if any above atmospheric. The makers state that, by reason of the high velocity of the air

causing gasoline to be taken up as the air enters the central mixing chamber, between which and the revolving crankcase is seen a sort of stuffing box.

The engine speed is controlled not by a throttle, but by a variable action of the valve cam, by which the inlet valve may be held open at pleasure for a greater or less period of the compression stroke. Thus a portion of the intaken charge is expelled, being transferred to the next cylinder, and only the last portion of the suction stroke of the latter draws fresh gas into the mixing chamber. Necessarily this reduces the theoretical efficiency of the motor, owing to the heating of the charges before they are used, but, on the other hand, the arrangement is favorable to a maximum efficiency of the mixing device.

But one spark coil is used, and no vibra-

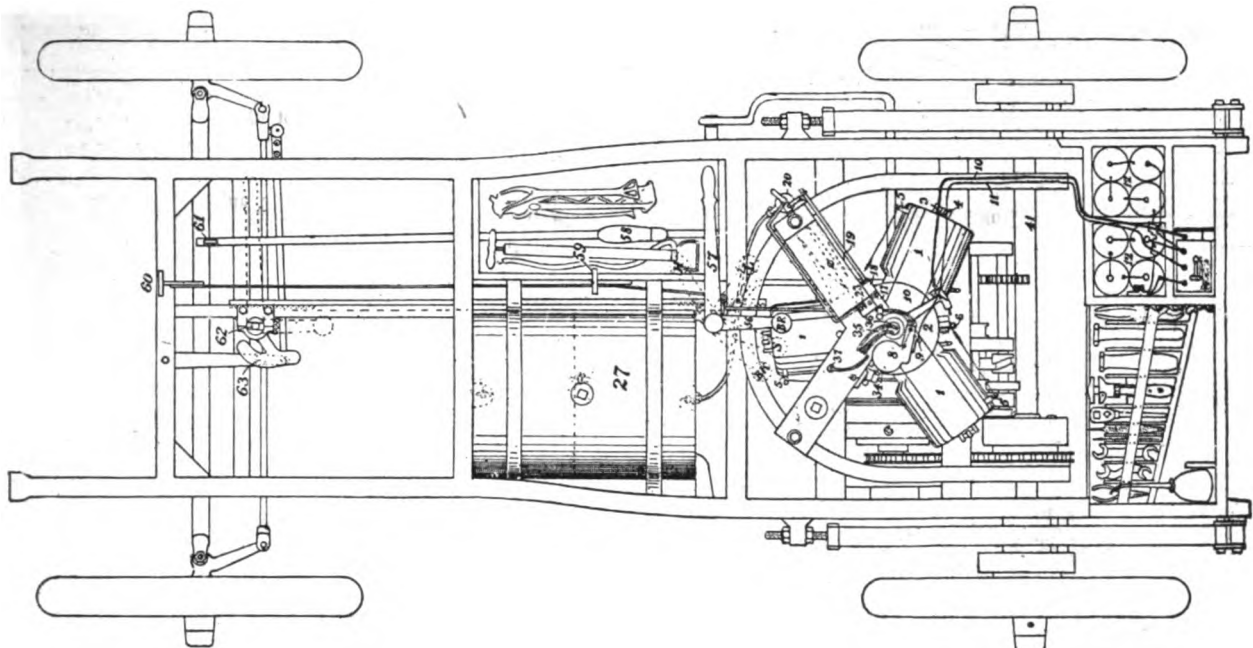

FIG. 2.—CHASSIS OF ADAMS-FARWELL CAR, SHOWING HORIZONTAL DISPOSITION OF ROTATING MOTOR UNDER REAR SEAT.

Description of Reference Numbers Applying to Figs. 2 and 3.—1, Cylinders. 2, Crankcase. 3, Exhaust valve. 4, Inlet valve. 5, Spark plug. 6, Porcelain insulator. 7, High tension distributor. 8, Circuit breaker. 10, High tension wire. 11, Primary wire. 12, Batteries. 13, Spark coil. 17, Crystal showing valve. 23, 18, Constant level gasoline reservoir. 19, Gasoline inlet and overflow pipe. 20, Gasoline well and pump. 27, Gasoline tank. 35, Cylinder oil tube. 36, Crank oil tube. 37, By-pass for oil. 54, Engine starting lever. 56, Clutch-operating lever. 57, Steering lever. 58, Engine speed treadle. 59, Hub brake pedals. 60, Forward position for brake pedal. 59. 61, Forward position for treadle. 58. 62, Forward position for levers 56 and 57. 63, Steering gear cam.

tor, one spark being produced on each primary contact. A centrifugal governor

advances the time of contact automatically to suit the motor speed, and likewise varies

the arc of contact from 1-36 of the engine's revolution at low speed to 1-12 at 900 r.p.m., thus saving the batteries at the slower speeds. From the coil the high tension current goes by wire 10 to the distributor 7, an insulated segment with a brass strip on the lower edge. From each spark plug 5 a wire runs to an insulated block 6, and 7 is so placed that the current jumps from it to 6, when the latter passes under, but does not quite touch, the brass strip. Thus an auxiliary spark gap is incidentally provided.

The ease with which any cylinder may be removed, by taking out the six side bolts and the four in the top and bottom flanges, is an especial point claimed for this motor.

The motor is supported by a stiff cast bronze spider, which is bolted to the frame of the car and into the center of which the lower end of the crankshaft is keyed. All the accessories, such as oil tank, carbureters and clutch operating mechanism, are likewise supported by this spider; and the speed changing gears are also carried by it and may be removed with it.

Angle steel is the material of the main frame. The wheel base is 84 inches, and the springs are all 40 inches long. A novel feature is the use of an auxiliary leaf on top of the main leaf of each spring. When the springs are lightly loaded, the ends of these auxiliary leaves are detached, but when the vehicle is to carry, at front or rear, its full complement of passengers, the front or rear auxiliary leaves are clamped down so that they will contribute their share of support. This operation requires but a moment's time, and results in very easy riding under light load, a thing usually hard to secure.

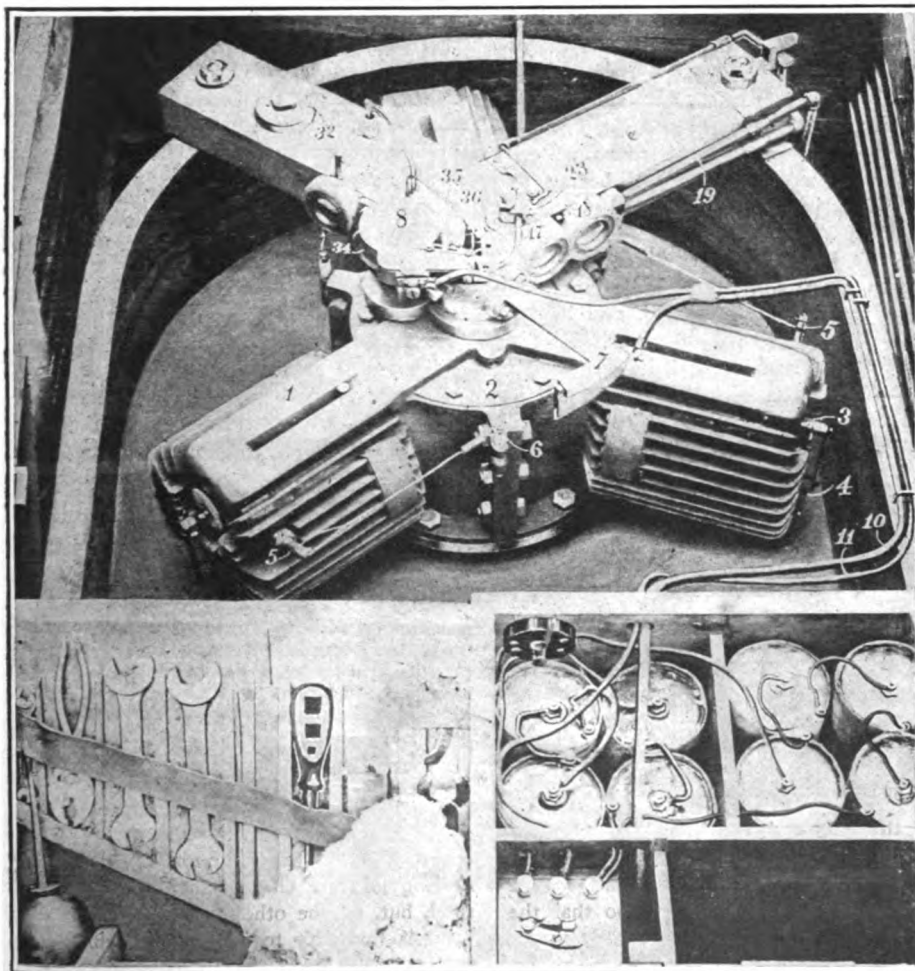

FIG. 3.—PHOTOGRAPH OF MOTOR IN PLACE SHOWING METHOD OF PIPING AND WIRING.

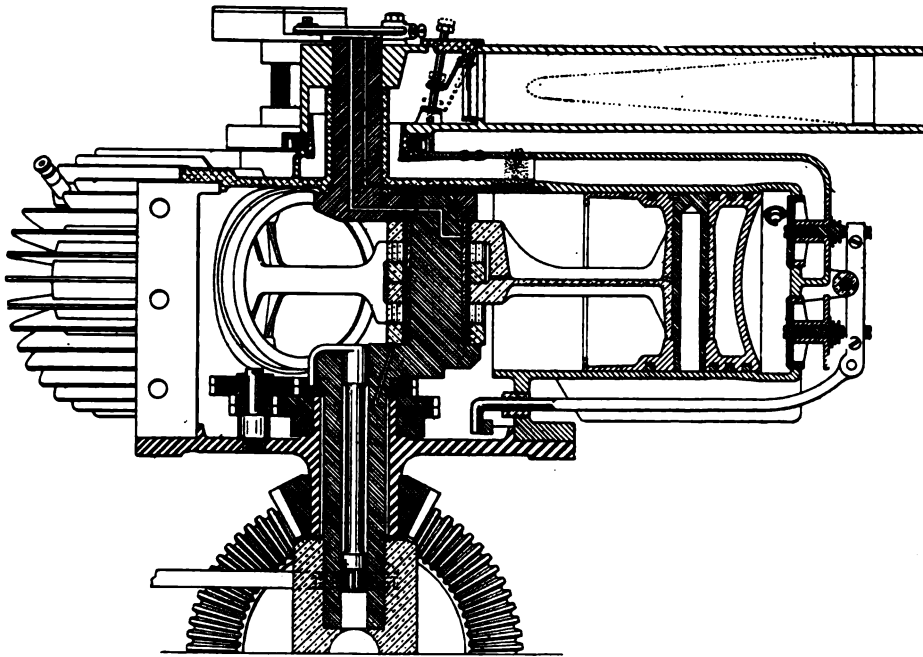

FIG. 4.—PART SECTIONAL DRAWING OF ONE-CYLINDER OF ADAMS-FARWELL MOTOR.

The independence of convention which marks this car extends to the body as well as to the chassis. Dissatisfied with the shut-in effect of the canopy top car, when its curtains are down, the makers have produced a "convertible" brougham, which is convertible in the sense that the front operator's seat may be closed up, the control devices taken up and transferred inside, and the car operated from the rear seat at short notice. The parts thus moved consist of the "controlling column," at the top of which are the steering and speed-changing levers, and one treadle under the left foot, by rocking which the valve cam is shifted to control the engine speed. In addition, there is for each set a pedal by which the emergency hub brakes are applied.

The steering gear, though operated by hand, is claimed to be practically irreversible, as it works through a cam movement, instead of direct. The speed changing or clutch lever, when straight back, locks the hub brakes. The first forward movement to the right releases the brake and engages the low gear, as indicated by letters in Fig. 2. When clear forward, it engages the high gear. The reverse is operated by the same lever when to the left of the braking position. The spark, as previously noted, is governed automatically.

The motor is lubricated by a multiple force pump, operated by a worm. This pump feeds four oil tubes, of which two supply an oil duct leading to the top of each cylinder, where the oil is taken up by the pistons. The third tube feeds the crankpin bearing, from which the surplus of oil escapes to the crankcase and is splashed on the valve gears and into the lower part of the cylinders. The oil tank is located close to the engine, where it will keep warm in cold weather.

The makers of this machine, which they call the Adams-Farwell motor, state that

all the novel features, such as revolving the cylinders around a vertical, stationary crank shaft, system of muffling, variable compression control, automatic spark regulator, control from front and rear seat, variable strength springs, carbureter, oiling system, etc., are the subjects of patents granted and pending in this and foreign countries.

Motor Well-Boring Machine.

The latest commercial development of the automobile is reported from the Pacific Coast. A self-propelled well-boring machine has just been completed for J. A. Yates of Alturas, Modock County, Calif., and will be used in the northern part of that State. Mr. Yates already has a well-boring machine in the field, and hauls it from place to place with horses. He finds this an expensive method, however, owing to the cost of keeping the horses, and has had the new machine built to overcome this and other difficulties.

Power is furnished by a gasoline engine with double opposed cylinders of 6-inch bore and 8-inch stroke, running at a maximum speed of 800 revolutions per minute. Valves are large and of nickel steel. The crankshaft also is of nickel steel, two inches in diameter, with main bearings two inches by four and one-half inches, bushed with bronze. Connecting rods are of steel, marine type. Ignition is by jump spark, the source of current being a dynamo. Speed of the motor is governed by throttle. Gasoline is supplied to the vaporizing chamber by means of a pump, the level being constant and the surplus returning to the tank through a by-pass. The transmission, which is the invention of P. J. Scharbock, president of the Hill Climber Auto Mfg. Co., that built the machine, gives three forward speeds and reverse, one lever being used for all speed changes. The gears are always in mesh, and the drive is direct on the high gear. The gears are of steel and bronze, the speed, change and differential gears running in the same oil-tight case. The three gear positions give speeds of 1 1-2, 3 and 6 miles an hour.

On account of the extremely bad roads and long hills to be negotiated in traveling through the country, the rear wheels, which are very heavy and strong, are provided with steel tires five inches wide with three-quarter-inch "grousers," riveted on to give a grip where traction is poor. In case the wheels cannot get grip enough to move the machine out of a bad place, a steel cable, 800 feet long, can be reeled out, secured to a tree, rock or "dead man" and the motor thrown into gear with the cable drum, thus pulling the machine out. The frame of the vehicle is constructed of steel of I-section, with channel steel cross members.

The machine was tested by its builders, and proved capable of climbing any hill that could be found with a road on it. The complete machine weighs 4,559 pounds. The engine weighs 720 pounds.

The same engine that furnishes the propulsive power is used for operating the well-boring machinery when the usual derrick is rigged.

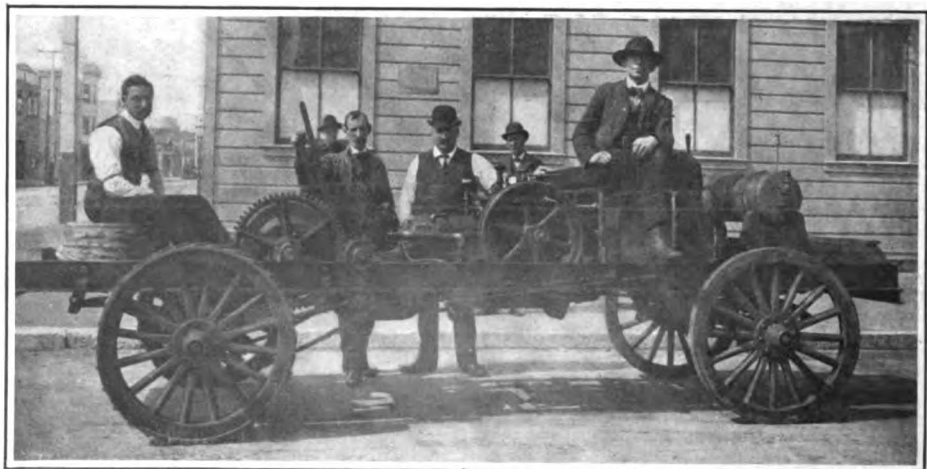

AUTOMOBILE WELL-BORING MACHINE IN USE IN NORTHERN CALIFORNIA.

The Charter Touring Car.

The 50-horsepower four-cylinder touring car illustrated herewith embodies a number of features upon which the designer and builder, James A. Charter, of Chicago, has worked for several years, and which were first incorporated in a 16-horsepower motor for testing and experimental purposes. The motor, honeycomb radiator, fan and other details of the mechanism are arranged in the conventional manner. Each cylinder of the motor is a separate casting and can be removed from the aluminum crankcase without disturbing the remainder of the engine. All joints are ground so that no packing need be used in the entire motor. The cylinder heads are cast separately from the cylinders and are kept compression-tight by ground joints. The water jackets are made separately and slipped over the cylinders. The inlet valves are automatic, and are placed directly over the exhaust valves, in the same housing. Both valves are in cages and can be removed, without the use of tools, by loosening a thumb-nut. The cam-shaft, driven in the usual way by a pinion on the crankshaft, serves to drive the circuit-breaker and the circulating pump.

An ingenious arrangement for preventing the breakage of the pump in event of its being so obstructed as to be unable to revolve, consists of a spring drive. A flat spring is attached to the pump shaft at right angles, and engages with a double-arm driver on the end of the secondary shaft. Should the pump become clogged, the driving arms will merely cause the spring to

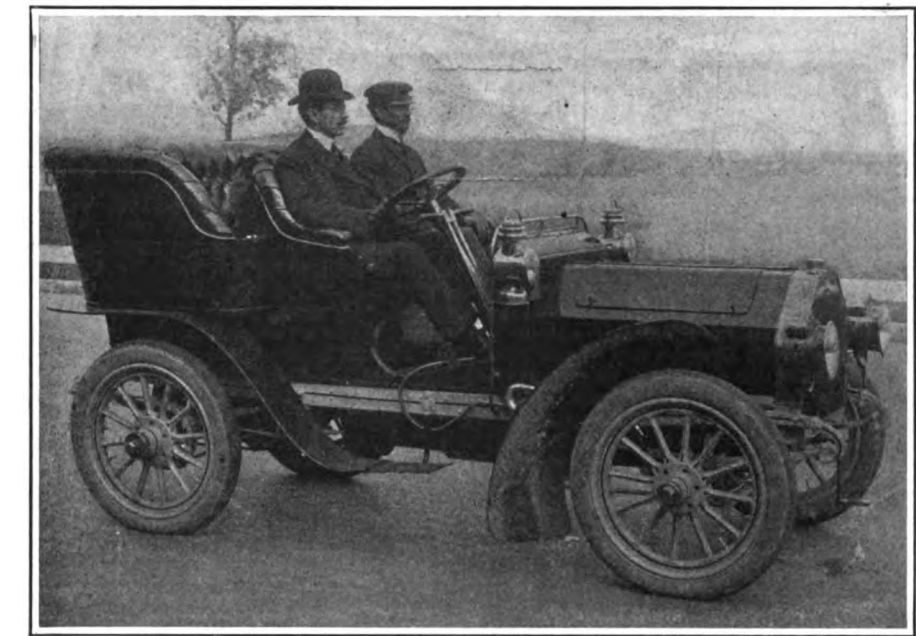

CHARTER 50-HORSEPOWER TOURING CAR, BUILT IN CHICAGO.

bend and then snap past, continuing to do so until the obstruction is removed. This ought to make sufficient noise to notify the operator that the pump requires attention. A by-pass allows the water to return to the tank if the pressure becomes excessive on account of obstructed piping. A pressure gauge keeps the driver informed as to the pressure on the water.

The crankcase of the motor is divided horizontally, and the lower half may be removed for examination of shaft, pistons, rods and bearings. Hand holes are pro-

vided in the upper part of the case for less extensive examinations. The drive from the motor is through a cone clutch, planetary change-speed gear, propeller shaft, with universal joint and bevel gears to the live rear axle.

The transmission provides two forward speeds and reverse, the low-speed and reverse being brought into operation by means of brake bands, while the high-speed drive is direct. The toggle joint through which the high-speed gear is operated is adjustable by a single nut. The transmission case is kept filled with oil, and provision is made for the lubrication of the cone clutch in the flywheel from the transmission gear case. Connection between the motor and the change-speed gearing is through a heavy coiled spring that absorbs much of the shock of starting when the clutch is thrown in. This is also designed to relieve the motor from sudden jars, and is said to make the car smooth running to a marked degree.

The speed-controlling levers are on the steering column, a disposition rendered possible by the slight amount of force required to operate planetary gearing. The two forward speeds are operated by a lever on the right of the column, while a lever on the left is used for reversing. The brake pedal interlocks with the clutch, so that the application of the brake disengages the motor from the driving gear. The throttle and spark advancer are operated simultaneously by a small lever in the center of the steering wheel. It is stated that by means of this system of control the car can be run from four to forty-five miles an hour on the high gear.

The frame of the Charter car and the cross members that carry the mechanism are of pressed steel. The springs are semi-elliptic, both front and rear. The dashboard is of the hollow type.

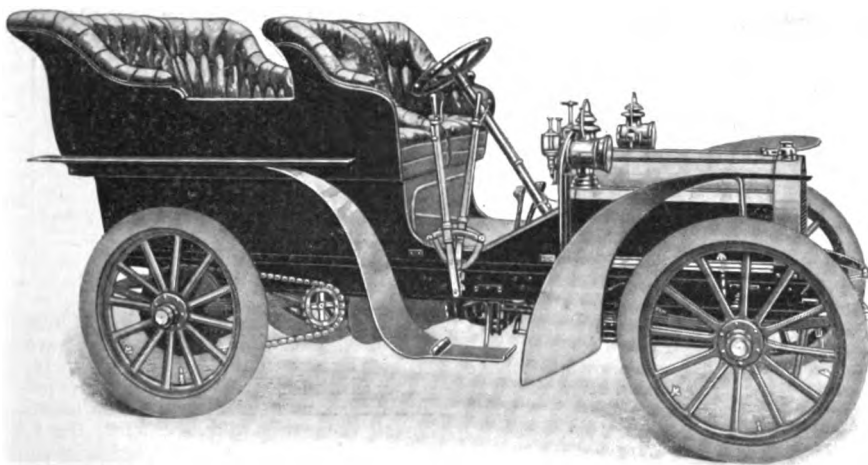

The 24-horsepower Berg automobile, illustrated herewith, has a frame of armored wood so proportioned that a large and roomy body may be attached. The motor is of the four-cylinder vertical type, with cylinders of 4 inches bore and 5 inches stroke, fitted with automatic inlet valves. Ignition is by jump spark, a quadruple coil, located on the dashboard, being employed and three sets of storage batteries. The sliding gear transmission gives four forward speeds and reverse, and the drive to the rear axle is by means of double chains from a countershaft. The radiator is of the tubular type, and the water tank is located in the rear of the chassis. The springs are semi-elliptical, 42 inches long in front and 48 inches in the rear. Wheels are of wood, 34 inches in diameter, with 4-inch clincher tires. Steering is irreversible, and the steering-wheel column comes up through the dash instead of through the floor, which is thus left clear except for the pedals, of which there are three—clutch, differential brake and accelerator.

Big Crowd Disappointed at Brighton Beach.

Bad Turns, "Hold-Up" at the Gate, and Oldfield's Sulky Action Spoiled Sport at Saturday's Meet.

WRETCHED entertainment failed to repay one of the largest crowds that attended a race meet in the Metropolitan District for the long jaunt through the cold west wind to Brighton Beach track last Saturday. The expectation of seeing Barney Oldfield put up some fast exhibitions with the *Green Dragon*, and of seeing Théry and Caillois in exhibition rides, added to the stimulating influence of the Vanderbilt Cup Race upon automobile racing in general, drew out a much larger attendance than the management had anticipated, as was evidenced by the fact that the supply of programs was exhausted completely soon after the racing began.

The sharp turns of the mile track were so soft from a storm of Friday morning that the fast cars skidded badly all the way around them, and only one or two of the

racing was over. Evidently the coupon merely indicated that the lessee of the privilege from the track management assumed responsibility for the car and its contents during the time the racing was in progress. Owners of cars were not given the option of checking their cars or not as they preferred. As there were upward of 500 cars at the meet, the lessee must have taken in \$200 to \$250 in this way without giving anything in return.

The larger number of spectators, who attended the races by way of the alleged Brooklyn Rapid Transit trains, arrived in anything but a good humor, after spending three hours on the way, owing to the poor train service.

OLDFIELD DISPLEASES THE CROWD.

This early dissatisfaction, increased by the inability of the late arrivals to secure

each. Oldfield and C. G. Wridgway were the only contestants in the heat for American cars, the former driving the 60-horsepower green Peerless and the latter a 24-horsepower car of the same make. Oldfield won, of course, with ease, by more than ten seconds. Bernin, with the 60-horsepower Renault, and Guy Vaughn, with a 40-horsepower Decauville, came together in the heat for French cars, with the natural result that Bernin made a runaway, winning by almost half a minute. As Paul Sartori, with Vanderbilt's 90-horsepower F.I.A.T., was the only representative of Italy, the Italian heat was not run.

This brought Oldfield, Bernin and Sartori to the tape for the final, the American on the pole and Sartori on the outside. Oldfield got the best start and in the dash for the turn arrived first, Bernin in the center and Sartori on the outside, lapping his rear wheels, about a length back. They swung around the turn in a spectacular way, each throwing up clouds of dirt as the wheels skidded. In the backstretch Oldfield pulled away from Bernin and continued to increase his lead to the tape, finishing the mile about 150 feet in the lead, with Sartori trailing Bernin about four lengths back. Bernin



SOME OF THE MANY SPECTATORS' CARS PARKED AT BRIGHTON BEACH TRACK LAST SATURDAY UNDER A COMPULSORY CHARGE.

drivers of the big cars dared to take them at high speed without shutting off. Oldfield showed more fear of the turns than anyone else, cutting out his motor invariably at the tape in front of the grandstand and coasting around the first turn, whereas Guy Vaughn in the 40-horsepower Decauville and M. G. Bernin in W. G. Brokaw's 60-horsepower Vanderbilt Cup car took the turns better, with the motors acting.

HELD UP FOR PARKING PRIVILEGE.

The temper of the spectators who attended the races in their automobiles was ruffled immediately upon their arrival at the track by a hold-up at the gate with a demand for half a dollar for the privilege of parking their cars in the enclosure—a demand enforced by the presence of a city policeman apparently detailed for the purpose. In return for the 50 cents the driver of the car was handed the stub of a green paper check bearing a serial number, but was not directed where to place his car and was not assisted in locating it when the

programs and the mediocre sport witnessed, was increased to the point of disgust by the exhibition of poor sportsmanship shown by Oldfield in the trial of the International Cup race, when, realizing that he was beaten by Bernin in the Renault, deliberately slowed down, finishing a very bad third in 5:44 4-5, as against Bernin's 5:03 3-5.

When the program was brought to an unprecedentedly early close at 4:50 p.m. by the announcement that the referee refused to allow the running of the advertised record trials, owing to the bad condition of the turns, the spectators could not get away fast enough. The first of the electric cars back to the city were crowded to the steps, and the parties in automobiles raced back over Ocean Parkway at a pace that rivaled the cars on the race track.

INTERNATIONAL CUP RACE.

The International Cup Race, run in heats by countries, was the feature of the program. Two heats were run, at three miles

took the turns at better speed than Oldfield and closed part of the gap, so that when Oldfield swung to the outside of the track in the third mile to cut into the pole on the far turn, as usual, Bernin, who kept the pole all the way around, reached the turn at the same time as the *Green Dragon* and they rounded it side by side, with the American high up on the bank. This apparently made Oldfield sulky, or frightened him, for he slowed down, allowing both Bernin and Sartori to pass him. The two foreigners made a good race to the finish, Bernin doing the fifth and last mile in 58 3-5 seconds, the fastest of the day, and winning by nearly a quarter of a mile.

DIAMOND CUP RACES.

When Bernin and Oldfield came together again as competitors a little later in the five-mile race for the Diamond Cup, which would have become the permanent property of the Peerless company had Oldfield won, Oldfield repeated his performance. C. G.

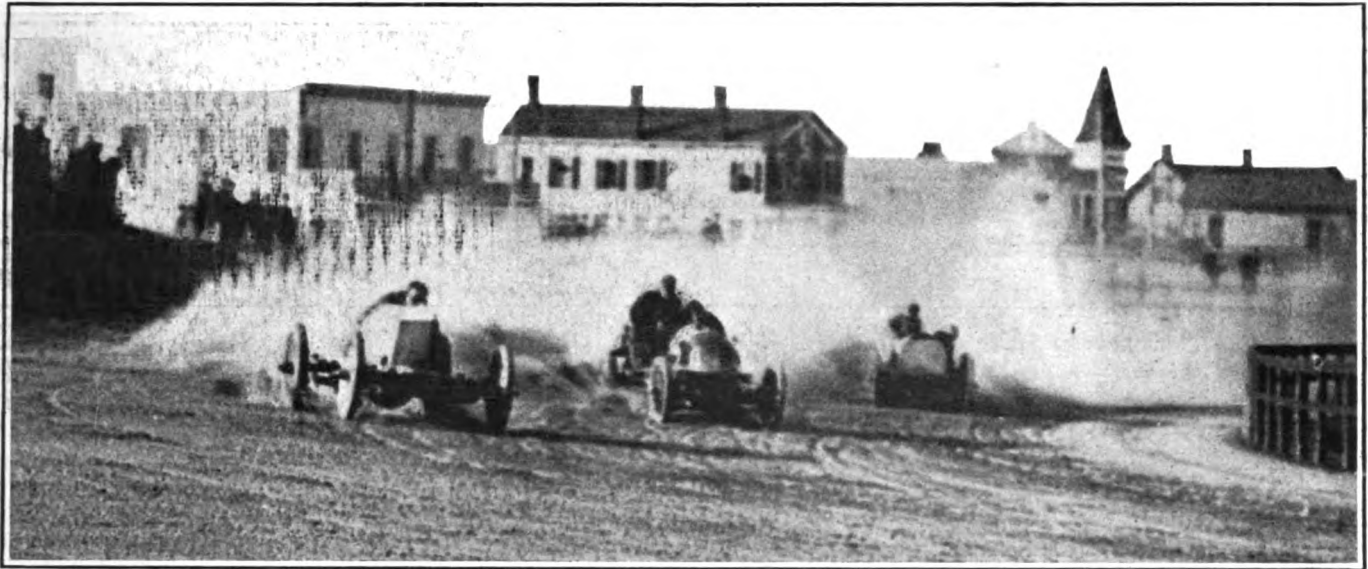

OLDFIELD, BERNIN AND SARTORI SWINGING AROUND THE TURN TOGETHER IN THE FINAL OF THE INTERNATIONAL RACE.

Wridgway, with the 24-horsepower Peerless, was the third competitor. The *Green Dragon* got away first and led around the turn and into the backstretch, where Oldfield slowed down, letting Bernin go ahead and win by three-quarters of a mile in 5:08 3-5.

THE HANDICAP RACES.

A novelty was introduced in the Brighton Handicap, the handicappers giving time allowance to the cars starting in the finals upon the basis of their performance in the qualifying heats of the same race. Another innovation was the handicapping of the cars in the mile race for the Seabreeze Cup, according to their retail prices. This might have worked out better had the race been restricted to gasoline cars, or been over a distance of five miles, but, as it turned out, a Stanley steamer, which was given 300 yards start, made a runaway of the race in a quick dash before its surplus pressure ran down, winning by 26 seconds from an Autocar that started at 100 yards and by 37 4-5 seconds from a Cadillac that started at 250 yards.

WRIDGWAY THROWN FROM HIS CAR.

The only approach to an accident during the afternoon was in the second heat of the Brighton Handicap that concluded the program. The winners had completed their last laps, but were making another circuit of the track at speed, apparently uncertain whether or not they had finished, when, as

he rounded the turn into the homestretch, Wridgway's seat came off and he was thrown out of the machine, lighting on the track on his shoulder and the side of his head. The car cut diagonally across the track and plunged through the outer fence, coming to a stop against the inner wall of one of the sheds. There was excitement in the stand and around the track, but the announcer quickly megaphoned that Wridgway was not injured, and soon afterward that popular driver ran down the track past the judges, vaulted the fences and disappeared in the clubhouse. As he passed the judges he told them he was not hurt, although blood on his face showed that he had got a nasty fall.

In the final of this race Oldfield, whose *Green Dragon* got away very slowly and was firing badly, was passed in the second mile by Vaughn in the Decauville and Bernin in the Renault, and at the end of the lap pulled out of the race. Bernin overtook Vaughn on the first turn of the fourth lap and passed, but was unable to overcome the handicap of 115 seconds given the new 25-horsepower Standard racing car driven by Philip Adams, which won in 8:17 by more than 100 feet. Bernin was second and Vaughn third.

THE SUMMARIES.

The summaries follow:
Seabreeze Handicap, one mile, for stock cars of any motive power retailing for

\$1,000 or less—L. F. N. Baldwin (10-hp. Stanley), 300 yards handicap, 1st, time, 1:27 1-5; Rodney Peeler (10-hp. Autocar) 100 yards, 2d, time, 1:53 2-5; Clyde Adams (8-hp. Cadillac) 250 yards, 3d, time, 2:05.

Diamond Cup, five miles open—M. G. Bernin (W. G. Brokaw's 60-hp. Renault), 1st, time, 5:08 3-5; Barney Oldfield (60-hp. Peerless *Green Dragon*), 2d, time, 5:54 2-5; C. G. Wridgway (24-hp. Peerless), 3d, time, 6:01 3-5.

International Cup, free for all, heats by countries—First heat, three miles, French cars—M. G. Bernin (60-hp. Renault), 1st, time, 3:06 1-2; Guy Vaughn (40-hp. Decauville), 2d, time, 3:35. Second heat, Italian cars—Paul Sartori (A. G. Vanderbilt's 90-hp. F.I.A.T.), the only representative; heat not run. Third heat, American cars—Barney Oldfield (60-hp. Peerless), 1st, time, 3:25 3-5; C. G. Wridgway (24-hp. Peerless), 2d, time, 3:36.

Final heat, five miles—M. G. Bernin (60-hp. Renault), 1st, time, 5:03 3-5; Paul Sartori (90-hp. F.I.A.T.), 2d, time, 5:17 4-5; Barney Oldfield (60-hp. Peerless), 3d, time, 5:44 4-5.

Brighton Handicap, five miles open—First heat—Rodney Peeler (10-hp. Autocar), 225 seconds handicap, 1st, time, 8:49 4-5; M. G. Bernin (30-hp. Renault) scratch, 2d, time, 5:29 1-5; Philip Adams (25-hp. Standard), 35 sec., 3d. Second heat—Guy Vaughn (40-hp. Decauville), 50 sec., 1st,

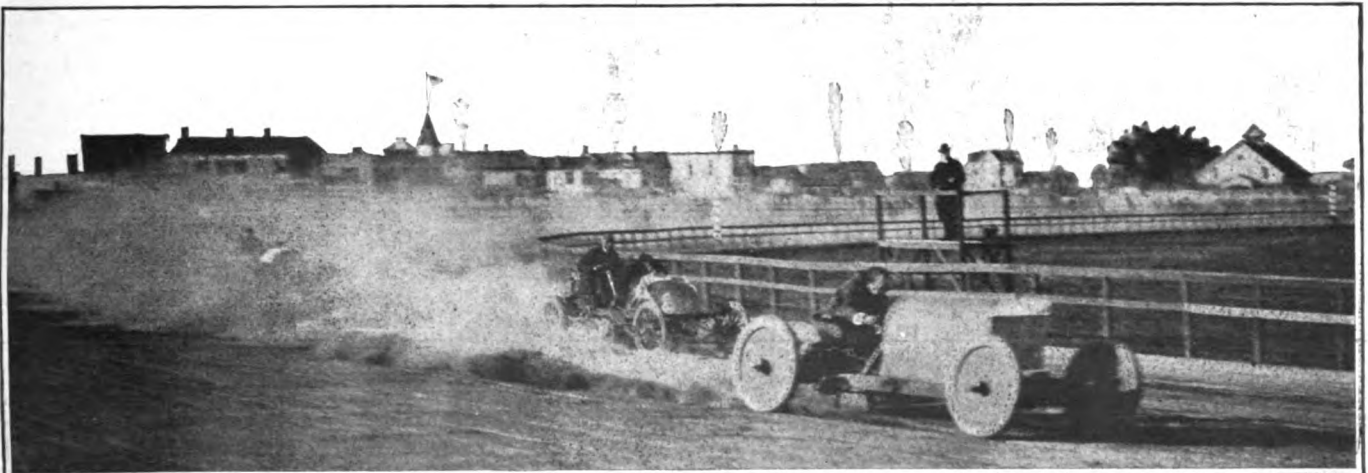

BERNIN, WITH THE RENAULT, HOLDING THE POLE, OLDFIELD TRYING TO CUT IN, AND SARTORI TRAILING IN THE DUST.

time, 6:49; C. G. Wridgway (24-hp. Peerless), 45 sec., 2d, time, 6:50; Barney Oldfield (60-hp. Peerless), scratch, 3d, time, 6:54 2-5.

Final heat—Philip Adams (25-hp. Standard), 115 sec., 1st, time, 8:17; M. G. Bernin (30-hp. Renault), 25 sec., 2d, time, 8:19 1-5; Guy Vaughn (40-hp. Decauville), 45 sec., 3d, time, 8:24.

ST. LOUIS SUNDAY RACES

Kiser Lowers Track Times and Dorris Wins Everything He Enters.

Special Correspondence.

St. Louis, Oct. 24.—New records for the local course from one to five miles was the result of Earl Kiser's third attempt to lower the track records at the race meet Sunday. Kiser arrived Saturday from Cleveland with *Bullet No. 2*.

He was scheduled for two exhibitions, one at five miles and one at ten miles, but after his failure to lower the times of Oldfield and Webb, asked for a third chance. This time he succeeded in putting up new figures up to five miles. He beat Oldfield's mile in 1:04 3-5 by 2 1-5 seconds, and A. C. Webb's five-mile mark of 5:25 by 6 seconds.

Kiser said that the track was very slow and that the time here was harder to make than less than one minute to the mile on the Eastern tracks.

G. P. Dorris, with a 24-horsepower St. Louis, won everything in which he entered. The local driver of the White could not get it to working right until the last event, which he won easily.

The Marion people sent D. J. Hayden direct from the Indianapolis factory to drive the Marion in the light-weight events, but the best he could do was second place in each.

The weather was all that could be desired, and more than 2,000 spectators were in attendance.

THE SUMMARIES.

Five-mile exhibition by Earl Kiser.—Time by miles, 1:10, 2:21, 3:31, 4:40 3-5, 5:49 3-5.

Five miles for cars weighing 1,432 to 2,204 pounds, with road equipment, driven by

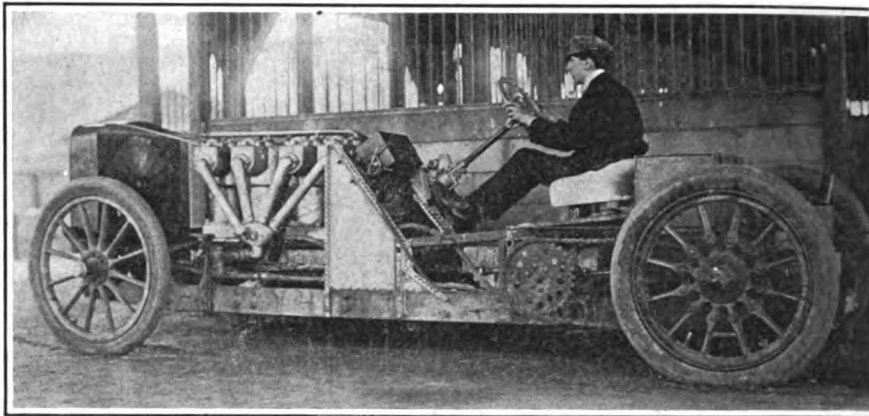

HARKNESS'S HOME-MADE RACER THAT IS ALWAYS ENTERED BUT NEVER STARTS.

owners and carrying four persons.—C. A. Tileston (14-h.p. Renault), 1st; Edward Godsey (24-h.p. St. Louis), 2nd. Time, 8:30 2-5.

Five miles for motorcycles up to 110 pounds.—E. F. Martin (13-4-h.p. Miami), 1st; Bahnsen (13-4-h.p. Indian), 2nd; E. Silverberg (13-4-h.p. Rambler), 3rd. Time, 7:55 1-5.

One-mile record trials for cars weighing 1,432 to 2,204 pounds.—G. P. Dorris (24-h.p. St. Louis), 1st; C. A. Tileston (14-h.p. Renault), 2nd; W. W. Leathers (10-h.p. White), 3rd. Time, 1:23.

Ten-mile exhibition by Earl Kiser.—Time, 11:13.

Five-mile race for cars weighing 1,432 to 2,204 pounds.—First heat—G. P. Dorris (24-h.p. St. Louis), 1st; C. A. Tileston (14-h.p. Renault), 2nd; W. W. Leathers (10-h.p. White), 3rd. Time, 6:25 1-5. Second heat—G. P. Dorris (24-h.p. St. Louis), 1st; C. A. Tileston (14-h.p. Renault), 2nd; W. W. Leathers (10-h.p. White), 3rd. Time, 6:56.

Two miles for cars weighing 881 to 1,432 pounds.—E. B. Godsey (12-h.p. St. Louis), 1st; C. N. Hayden (16-h.p. Marion), 2nd. Time, 3:28 2-5.

Five-mile trial for track record by Earl Kiser.—Time by miles, 1:02 2-5, 2:06, 3:10, 4:14 2-5, 5:19.

WASHINGTON SOMNOLENT.

With All Conditions Favoring Good Sport There is "Nothing Doing."

Special Correspondence.

WASHINGTON, D. C., Oct. 24.—It is apparent to the most casual observer that there is something wrong with the automobile spirit in Washington. This fact was forcibly brought out on Labor Day, when the Central Labor Union undertook to promote an automobile parade in the morning and a series of races in the afternoon. Out of a total of 850 registered cars in the National Capital, only sixteen turned out for the parade, while more than 200 automobilists had signified their intention of participating.

The races, as has already been reported in *THE AUTOMOBILE*, were a "frost," so far as sport was concerned. One of the greatest crowds in the history of the Bennings race track, which is conceded to be one of the finest and most picturesque in the country, turned out in anticipation of seeing some stirring events. A program of eight events had been framed, with a total of thirty entries. When it came time to toe the scratch nearly two-thirds of those who had entered got "cold feet," and it was necessary to cut out three numbers, while the remaining five had hardly enough contestants to make things interesting. Handsome silver cups had been donated for prizes, and there was every incentive for the local amateurs to go out and show a representative Washington crowd what they could do in the way of driving a car around a mile track. Had it not been for the presence of Frank Kullick, in the little Ford racer, the afternoon would have been most dreary.

If the Central Labor Union can muster a crowd of 10,000 to see a badly-advertised and poorly-managed meet, it is evident that automobile racing has many friends in Washington. A well-managed meet, with several of the stars as a drawing card, would undoubtedly net a handsome revenue for the promoters and be a distinct aid to the local dealers in the way of making sales. With a population of less than 200,000 white people, the National Capital has close to 900 automobiles in use. This is a good ratio that few cities exceed. As an automobile market Washington is one of the best in the country, for it is here the wealth and fashion of the country comes to spend a good portion of its time. There are hundreds of officials in the Government service, foreign ambassadors, ministers, attaches of legations, and private individuals of wealth who make Washington their home, and who will ultimately be a market for automobiles, either this year or some season to come.

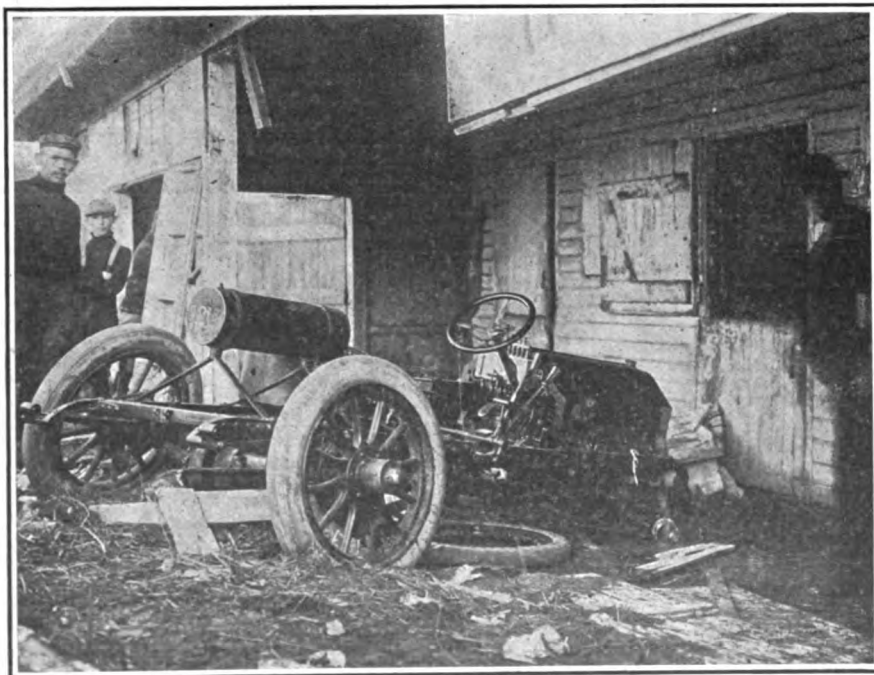

WRIDGWAY'S CAR AFTER THROWING ITS DRIVER AND PLUNGING THROUGH SHED.

Correspondence

Anti-Freezing Solution.

Editor THE AUTOMOBILE.

Sir:—Kindly inform me what is the best recipe to use to prevent water from freezing in a gasoline car in winter. Is there anything that can be used without harm to the copper pipes, and the like? What about refrigerating oil? I have seen that spoken of.

F. E.

Keene, N. H.

Certain grades of refrigerating machine oil have been used for cooling purposes in winter, with good success, apparently, though we know of no very conclusive experiments in that direction. The material most commonly used is a solution of calcium chloride in water, of density depending on the temperature to be resisted. A mixture of 3 pounds of the chloride to one gallon of water will freeze at about zero Fahrenheit, and a mixture of four pounds to the gallon at about 20 degrees below zero. In buying, be careful to get a good commercially pure grade, as impurities are likely to have an injurious effect on the valves and other metal work. Do not get chloride of lime by mistake. This material is very corrosive to iron and steel, and is, without question, the cause of injuries often laid, incorrectly, to calcium chloride.

Losses from the chloride solution, due to evaporation, should be made up by adding pure water. Losses by leakage should be made up by adding fresh solution. It is well to draw off the solution once a month or so, and wash out the pipes, and the like, before replenishing with fresh solution.

Anti-Freezing Solutions in Winnipeg.

Editor THE AUTOMOBILE:

Sir:—In western Canada, where the thermometer often falls 40 degrees below zero, the question of a non-freezing solution for use in the water circulating system is agitating the minds of automobilists, and it is hoped that the difficulty will be overcome by the use of a new compound, which Professor Kenrick, the government analyst and secretary of the Winnipeg Automobile Club, has prepared. The formula for the preparation is at present a secret, but it has stood numerous tests made at 40 degrees below zero without showing any signs of freezing.

A mixture used by Mr. D. Bain with great success all last winter, during which the machine was protected only by a tarpaulin cover, was composed of 60 per cent. glycerine and 40 per cent. water, and, in spite of last winter being the coldest experienced in the West for a number of years, no trouble from frozen water pipes was experienced. The drawback to the use of this preparation, however, lies in the fact that the acids always present in commercial glycerine affect the tanks and coils, eating into

the surface and weakening them considerably.

Mr. Bain is now endeavoring to find a neutralizer to remove this trouble, and would be glad of any hints from users of automobiles during the winter months that would help him in his experiments. The question was brought forcibly home to automobilists here during a recent cold snap, no less than six machines being placed on the retired list in one night, when the temperature unexpectedly fell well below the freezing point.

A. E.

Winnipeg, Manitoba.

Another Anti-Freezing Inquiry.

Editor THE AUTOMOBILE.

Sir:—Kindly inform me what is the best anti-freezing mixture to use in an automobile in winter. Is kerosene safe? Last winter I used calcium chloride and nearly ruined my valves and their attachments owing to the thick rust which resulted. I am told 20 per cent. glycerine solution has to be replaced every two weeks else it becomes thick, and also is not efficient in coldest weather. I use my machine in my professional work in place of a horse, hence the problem is an important one.

DR. C.

Auburn, N. Y.

See the answer to F. E. in the first column on this page. Probably your dealer gave you chloride of lime by mistake; or a cheap grade of calcium chloride. The glycerine solution has to be replaced somewhat frequently, and it rots the rubber hose commonly used for connections. Kerosene is not safe for use in the water jacket.

A Bicycle Idea.

Editor THE AUTOMOBILE.

Sir:—Would there be any weight to an invention of the front wheels of an automobile in which they are made to slope as on a bicycle—that is, when turning corners, and the like?

It seems to me that as the center of gravity of the car would be lowered in proportion to the turning of the wheels, the life of tire, steering knuckles, strain on hubs and a few unseen points would be quite pronounced. The line drawn through center of gravity, the hubs and tread would be quite straight, and breakage of steering apparatus would be reduced to a minimum; skidding, too, would be less. J. H. P., Jr.

Cleveland, O.

Giving the steering pivots a backward rake at the top relieves the steering connections to some extent of road shocks, but it complicates the design of the connections and makes correct action more difficult when turning corners. For this reason the pivots are generally vertical or slightly inclined inward at the top, which has a greater effect in reducing road shocks than the backward rake.

Steam Car Power Plant.

Editor THE AUTOMOBILE.

Sir:—I am thinking of building a steam runabout to carry two persons, and would like to ask you will a 2 1-2 by 3 inch steam engine be large enough? And would it be necessary to use back gears to climb hills? I think of making a vertical fire tube boiler 19 inches diameter and 20 inches high. Would that size be right? How many, and what size flues would be best? Where can I get the flues? Also, where can I get a burner for such a boiler? I have never had any experience with this class of machinery, and any information will be thankfully received.

A. A.

Cherry Creek, N. Y.

The double cylinder, double acting steam engine of 2 1-2 inch bore by 3 inch stroke will be large enough for a runabout weighing not more than 900 or 1,000 pounds. It is not customary to put reduction gear on a steam engine of this class, but there are good reasons to think that it would be an advantage to do so. You will have to make your boiler of the same diameter as the burner, and burners are made, we believe, only in even diameters, as 16, 18 and 20 inches. The 18-inch burner and boiler would be ample for your rig. Write Charles W. Miller, 97 Reade Street, New York, or E. J. Willis, Park Place, New York, or to the Automobile Supply Company, Chicago, for the burners. You can get tubes for your boiler of the Ansonia Brass and Copper Co., Ansonia, Conn., or the Waterbury Brass Company, Waterbury, Conn., or of the U. T. Hungerford Brass and Copper Company, Pearl and Park Streets, New York City. The tubes should be 1-2 inch outside diameter, and about 14 gauge, and the tubes should be spaced 11-16 inch or 3-4 inch center to center.

Wheels Lifting on Curve.

Editor THE AUTOMOBILE.

Sir:—To settle a dispute kindly answer the following: An automobile going at a high speed turns a sharp curve, which causes it to turn on two wheels. "A" says the wheels on the outside, or those which are away from the curve, will leave the ground. "B" says the wheels nearest the curve will leave the ground. By answering the foregoing you will greatly oblige.

J. H. L.

New York.

As the centrifugal force due to turning tends to carry the vehicle forward in a straight line, and as this force is resisted only by the contact of the wheels on the ground, it follows that it will tend to tip the vehicle over toward the outside of the curve. The inside wheels therefore will be those to lift. The very latest foreign racing machines are so designed that they do not lift at all on corners when traveling at any speed that the driver would attempt.

Automobile Situation in St. Louis.

Large Increase in the Number of Machines Used.—Particulars of the Various Concerns in the Trade.

Special Correspondence.

ST. LOUIS, Oct. 24.—Probably no other industry in St. Louis has shown such remarkable advancement in the present year as has the automobile business. At the beginning of the year there were about 200 licensed motor vehicles in the city, and many of these were transfer and truck automobiles used by the large manufacturing concerns and retail houses. At the present time there are more than 700 licensed cars in St. Louis, about 550 being private machines, and the others transfer and trucking vehicles.

The August tour from New York to St. Louis accomplished a great deal for the automobile conditions of the Middle West and the country around St. Louis. There were more than 300 cars in the mammoth parade held during automobile week, and,

tour, and the club is now working for higher speed limits. A bill was introduced recently into the House of Delegates providing for a ten-mile-an-hour limit in the crowded districts down town and a twelve-mile limit farther out. The St. Louis Automobile Club, of which A. B. Lambert is president, is behind the pending bill, and it is understood that the club has assurances that this bill will become a law.

MANY CHANGES FOR THE BETTER.

A number of changes for the better have been brought about through the efforts of this organization, which is working for more favorable state legislation, as well as better street conditions in this city. The club membership has grown in the past year from about 30 to 150, with such men as

ing year. It is a fairly conservative estimate that within a year there will be 2,000 automobiles owned by St. Louis residents.

The tendency of the dealers is to locate on Olive street. Most of the dealers are located on Olive street between Grand avenue and Walton street. Nearly all started with practically nothing in some little out-of-the-way place, and have increased their trade and moved farther west on Olive street, until now they are centered well out.

CONCERNS IN THE TRADE.

Among the largest dealers in the city, as well as the oldest in local trade circles, are the Halsey Automobile Co., and the Mississippi Valley Automobile Co. The former, organized in September, 1900, is located at 3924 Olive street, having moved to its present location in March, 1903. The business is now capitalized at \$30,000, with A. C. and O. L. Halsey as the principal stockholders. The Halsey Company handles the Packard, Winton, Franklin, Stevens-Duryea and Cadillac cars. It does a general storage and repairing business and



A TYPICAL AUTOMOBILE HEADQUARTERS IN THE CITY OF SAINT LOUIS.

barring those of the tourists, they were strictly St. Louis owned machines.

MANY NEW CONCERNS.

The number of concerns dealing in automobiles has increased to seventeen, several of the largest having been organized in the last twelve-month. With the rapid growth of the trade, there has developed increased interest in the conditions governing and affecting automobiling in and around the city. Efforts have been made to improve these conditions, such as unfavorable city ordinances and the antipathy of a large section of the non-motoring residents to the latest mode of travel.

St. Louis at present is handicapped by ordinances that retard the growth of motoring; apathy of the automobilists last winter and earlier, as well as insolent disregard for the safety of others by a few reckless drivers, being responsible for their passage. These limit us to eight miles an hour on the streets and to six miles an hour on the park drives. Happily, there was an awakening about the time of the World's Fair

Mayor Rolla Wells, Wallace Simmons, Louis and Charles Lemp and other prominent business men of the city who are active workers in behalf of automobiling. Probably the one man who has done more than any other is President A. B. Lambert, who has worked incessantly for better laws.

A bill for a state law, which the St. Louis and Kansas City clubs are backing, calls for a maximum speed of fifteen miles an hour throughout the state and a uniform license fee. An effort will be made during the next session of the Legislature, which convenes the first Tuesday in January, to have this bill passed. The greatest objection to the present St. Louis ordinance is that clause which requires an annual license fee of \$10. The local motorists are greatly incensed at this requirement. All the benefit they derive from it is the privilege of running their autos over the streets of the city, which is their constitutional right anyway. With more favorable laws, better paved streets and increased interest in automobiling, St. Louis should go to the front rapidly as an automobile center in the com-

has storage accommodations for 250 machines. The building is a two-story structure 66 by 125 feet in size, with a one-story addition 55 by 125 feet. J. D. Lewis has charge of the repair department and has the distinction of having built one of the first automobiles in America.

The Mississippi Valley Automobile Co. was organized in 1899 by Harry Turner, Jr., with headquarters at 4359 Olive street. After making several changes in location, the concern moved to 3927-37 Olive street, the present home. The company now owns three buildings, with 50,000 square feet of floor space. The Pope-Toledo, Pope-Hartford, Knox, Oldsmobile, Columbia and Autocar are sold. Storing and repairing constitute the bulk of the business aside from the sales department. C. A. Marien has charge of the repair department. Garage has accommodations for 200 machines.

The W. W. Leathers Automobile Co., at 3914-18 Washington avenue, is the only concern in the city selling steam machines. It has the agency for the White steamer. The main building is 50 by 100 feet, with an



FRONT AND SIDE VIEW OF THE WESTERN AUTOMOBILE CO.'S GARAGE.

addition just completed 25 by 100 feet. This concern is one of the later ones in St. Louis, having been organized in November, 1903. W. W. Leathers is the salesman and H. D. Van Leunen has charge of the repairs. Garage accommodations for 60 machines.

The Western Automobile Co. is one of the more recent organizations, as well as one of the largest in the city. It was organized in January, 1904, by Messrs. M. L. Lambert and Sam Braden. The offices are located at the corner of Washington and Walton avenues. This building is 45 by 125 feet, and also contains the salesrooms and repair shops. The garage is located across the street at 618-620 Walton, 50 by 150 feet. This concern handles the Pierce, Peerless and Thomas machines. F. G. Turner, formerly with the Peerless Co., has charge of the repair department. Garage accommodates 75 machines.

The American Automobile Co., located at 4150-54 Olive street, is agent for the St. Louis and Overland machines. Repairing and storing are features. Messrs. S. M. Frank and V. Heinrich, incorporators. Garage accommodates 30 machines. Mr. Frank acts as salesman and Mr. Heinrich attends to the repairs.

The Northern Automobile Co. is located at 4105-07 Olive street. The Northern machine is sold. Garage accommodates 10 machines.

The Westminster Automobile Co. is a recent organization, located at No. 4390 Olive street. The National gasoline and National electric and the Eldridge are sold. Storing, repairing and renting. Garage accommodates 30 machines. D. W. Dean, manager.

The Morgan & Harding Automobile Co., located at 3964-70 Olive street, have just moved into their new quarters. Features, automobile repairs and sundries. Handle the Newmastic tire. Garage accommodates 200 machines. Building 86 by 145 feet, two stories. Business organized in 1898 and capitalized at \$10,000. Machines to be sold, not announced.

The A. L. Dyke Automobile Supply Co.

is located at the junction of Washington, Walton and Olive streets. The main building is 127 by 150 feet, and has just been completed at a cost of \$30,000. An addition, 60 by 115 feet, will be completed by the first of the year at an additional cost of \$20,000. With this addition, the building will be the "flatiron" building of St. Louis. The business was organized in 1899 by A. L. Dyke, but Robert and Roy Britton became the owners on August 30, 1904. The garage has accommodations for 50 machines at the present time, and will have room for 100 when the addition is completed. F. Miller has charge of the repairs. Aside from the supply department the company sells the Marion machine. Concern is capitalized at \$40,000, with the Messrs. Britton controlling the stock.

The Mound City Automobile Co., located at 3944-46 Olive, represents the Queen and Cameron machines. The company was incorporated in May, 1904, with a capital of \$10,000. Building 50 by 154 feet. J. A. Scott has charge of the repairs and acts as business manager. Garage accommodates 60 machines. A. M. Robertson, president.

The J. H. Neustadt Co., of 826-30 S. Eighteenth street, manufactures all parts for the assembling of automobiles. Jobbers of all kinds of engines, transmissions, wheels and tires and all general supplies pertaining to automobiles. Organized in 1900 in a little room on corner of Ninth and Clark streets. Present building 75 by 200 feet, two stories. Gives employment to seventy-five men in season. Any machine repaired.

The St. Louis Motor Car Co., of 1211-19 N. Vandeventer, is one of the oldest manufacturing concerns in the United States and the oldest in the west. This business was inaugurated at Nashville, Tenn., in 1895, and moved to St. Louis the following year. It has grown from a concern occupying one room 25 by 30 feet and employing three men to a large, modern automobile factory occupying a main building 100 by 120 feet and three stories high, and an addition 50 by 125 feet. The company makes the St. Louis machines in their entirety with the exception of the tires and lamps. The business is incorporated for \$50,000, but the investment is much larger. Jesse French, Sr., and son, Jesse, Jr., control the business. This was the third automobile company in the United States, the Haynes-Apperson and Winton preceding it.

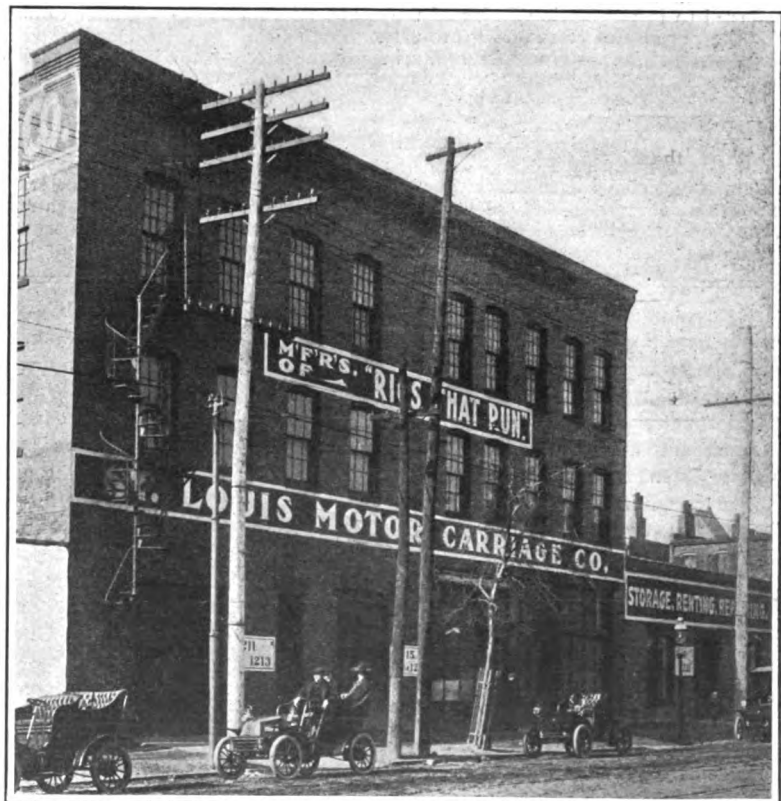

ONE OF THE PIONEER AUTOMOBILE MANUFACTURERS IN THE UNITED STATES.

RULES FOR INTERNATIONAL AUTO-BOAT RACE.

The following rules for the British International Race for Motor Boats, otherwise known as the Harmsworth Cup race, for 1905, have been received from Basil H. Joy, secretary of the Automobile Club of Great Britain and Ireland. By an important change in Rule 6, the boats will be sent away with flying start and all competitors are to start together. Rule 4 alters the length of the course from between six and twelve nautical miles to between thirty and thirty-five nautical miles, so that a better type of boat will probably be evolved. Careful definitions of the course in Rule 4 are expected to eliminate sharp curves from the course. There have also been minor changes in Rules 5, 14 and 15.

RULES PURSUANT TO THE DEED OF GIFT.

1. **POSSESSION OF CUP OR TROPHY BY WINNER.**—The cup or trophy shall be handed to the club of the winning boat, and held by such club for one year or any other further period by the consent of the committee hereinafter mentioned, provided a succeeding competition shall not take place within one year, but if the said club are called upon by the trustees, then they shall forthwith return the same on demand at any time after the expiration of twelve months from the date of the race at which the same was won.

2. **CUSTODY OF CUP AND INSURANCE.**—On the said cup being handed over to the winning club, such club shall thereby become and be deemed to be the custodians of the said cup, and shall be deemed to undertake for the safe custody of the same, and shall also insure the same for £500, or such other sum or sums as the committee shall decide, and the insurance premium for that year shall be paid by the club holding the same. Such insurance shall not only cover loss by fire, but also any other loss or damage whatsoever.

3. **COURSES.**—The race shall be held over a suitable course in sheltered waters of the country holding the cup, or failing that in similar waters in Great Britain or Ireland.

4. **LENGTH OF COURSE.**—The length of the course shall not be less than 30 or more than 35 nautical miles, and shall be so arranged as to avoid any angle in the course of less than 120 deg., and there shall be a distance of at least 100 yards between any two marks. The length of each round shall not be less than 5 nautical miles.

5. **PLACE WHERE RACE TO BE HELD.**—The course shall be determined by the club holding the cup, and particulars thereof shall be sent to all clubs which have challenged, within twenty-eight days of the receipt of a challenge. In any case the course shall conform to Nos. 3 and 4 of these rules.

6. **STARTING LINE.**—The start shall be a flying start, and all competitors shall be started together by signal, five minutes after the preparatory signal. Both these signals shall consist of flag and sound signals. That boat of which any portion of the hull first crosses the finishing line shall be adjudged the winner of the race.

7. **MEASUREMENTS AND MODE OF STARTING.**—Measurements and starting of the competing vessels and the judging of the race shall be carried out under the direction of the International Commission defined by Condition 10 hereof, who also shall be the Racing Committee referred to in the Racing Rules of the Marine Motor Association for the purpose of considering protests.

8. **LIMITATION OF SIZE.**—The only limitation of the size of the competing vessels shall be in the overall length of the hull, which shall not exceed 40 feet.

9. **FLAGS TO BE CARRIED.**—Each boat shall carry a distinguishing flag, which may be of any material, and which shall not be less than 12 inches hoist nor 15 inches fly, and shall be carried at a height of not less than 2 feet clear of the deck.

10. **ENGINES AND MOTORS.**—There shall be no restriction on the number, size, or horsepower of the engines or motors, except that each boat taking part in any race shall contain and be fitted with

such mechanical power as will drive her astern at a rate of speed of not less than four knots an hour in still water.

11. **MINIMUM SPEED FOR QUALIFYING.**—If none of the competitors are able to complete the course at an average over the whole length thereof of 12 knots an hour from any cause whatsoever, then the race shall be abandoned for the day, and the same shall be run on a day to be agreed upon and fixed by the International Commission, but such day shall not be more than three days after the abandoned race. If only one of the competitors is then ready, that competitor shall go over the course and shall be adjudged the winner of the cup. If none of the said competitors are ready within the three days hereinbefore mentioned, the race shall be again postponed to a date to be decided by the International Commission, and if again no vessel is ready, the event shall be again postponed, and so on until one boat go over the course on one of the dates to be fixed as aforesaid by the International Commission, and such boat shall be deemed to be the winner of the cup.

12. **ACCIDENT TO COMPETING BOAT.**—In the event of any temporary accident to or derangement of any one of the competing vessels during the race, no assistance shall be rendered to the boat other than by the two hands carried by the said boat. If the accident or derangement is of such a nature that outside assistance shall be necessary, the distinguishing flag shall be hauled down and the vessel shall take no further part in the races. Outside assistance may not be given or rendered or procured until the distinguishing flag has been hauled down, but after the same has been hauled down assistance may be given, but the vessel shall be immediately removed from the course, and shall not interfere in any way with the other competitors.

13. **COMPETITOR NOT TO ASSIST IN ANY ACCIDENT BUT TO FINISH COURSE.**—In case of an accident to one of the competitors the other competitors shall continue the race and finish the course. In the event of one competitor going to the assistance of another the committee shall decide whether the race shall be run again.

14. **CHALLENGE.**—In the case of no challenge having been received by the club holding the cup on or before the 1st of February in any year, no race can take place for the cup during that year; and in no case shall a race take place within six months from the date of the receipt of a challenge; and the last date at which an entry may be received is July 1st in any year.

15. **ALTERATION OF COURSE.**—If in the opinion of the International Commission, constituted as provided in Condition 10 of the Deed of Gift, a postponement of the race or an alteration of the course shall be desirable, owing to unfavorable weather or any unforeseen cause, this commission shall have power to take such action as may be necessary; but in any case the course must conform to Nos. 3 and 4 of these rules.

16. **LIFEBUOYS.**—Each boat competing for the cup must carry two lifebuoys in a position ready for use.

RECOMMENDATION.—LIFE-SAVING APPARATUS.—It is recommended that each member taking part in the British International Cup Race should wear a life-jacket or make use of any other device or apparatus for life-saving in case of immersion.

The Missouri Automobile Works are located at 1621-23 S. Jefferson, and sells the Elmore, Crestmobile and Pope-Tribune. Business includes repairing, storing and renting. Garage accommodates 75 machines. Capitalized at \$10,000, fully paid up. Company is making arrangements to branch out and manufacture parts. Building 40 by 150 feet, two floors.

The Lemon Automobile and Manufacturing Co. is the style of the latest organized company in St. Louis. This company was incorporated the latter part of May with a capital stock of \$100,000. It manufactures one style of machine known as the Meteor surrey. The factory is located at 3419 Lindell boulevard, and the offices are in the new Frisco building. The Meteor is built on the style of buckboards, having two seats instead of one.

The O. L. Collins Automobile Co., with offices at 1314 Chemical building, is agent for the Glide machine, manufactured at Peoria, Ill.

The Macnish Automobile Co. has recently moved into the new quarters at 3667-69 Olive, among the largest in the city. The building is 50 by 110 feet, three floors. The company is a close corporation, capitalized at \$10,000, with F. J. and J. Macnish controlling the stock. Agents for the Haynes-Apperson and Courier machines. Garage accommodates 100. One of the features of this garage is that the machines have ample room to turn on coming out, without crossing the street car tracks.

Besides the companies mentioned, there are a great many private agents in the city for various automobiles, but as these have no regular headquarters, it is impos-

sible to find what other machines are sold. The Ford has been represented here at different times, but the agency changes so often that nothing definite can be learned.

The automobile livery industry is a new one, at this time only two concerns in the city doing a strictly automobile livery business. These are the Auto Livery Co., of 3944 Olive street, and the Keyes-Marshall Bros. Auto Livery Co., of 1122 St. Charles street. The former uses Wintons, Packards, St. Louis and Royal touring cars, while the latter use Cadillacs, Panhards and other French machines.

Police Commissioner McAduo, of New York city, has issued instructions to all his police stations that the amount of bail required in cases of automobile speeding shall not exceed \$100.

Patents

Valve Mechanism.

No. 771,095.—E. C. Richard, of Detroit, Michigan.

This invention consists mainly in the forked type of levers used to operate valves

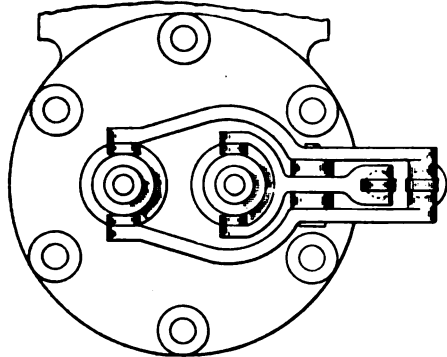

RICHARD VALVE-OPERATING LEVERS.

located in the cylinder heads, one lever straddling the other, as shown. The valve stems have flanged caps inside of which the valve springs are located, and the levers have anti-friction rollers at their ends, which bear on the flanges of these caps and on the push rods rising from the cams.

Speed Changing Lever.

No. 770,251.—J. L. FitzGerald, of Newport, R. I.

A pick-up device for operating four-gear changes by one lever without passing through the intermediate speeds in going from high to low. The lever 2 is pivoted at its base to move freely fore and aft, and it carries a handle 10 pivoted to rock from

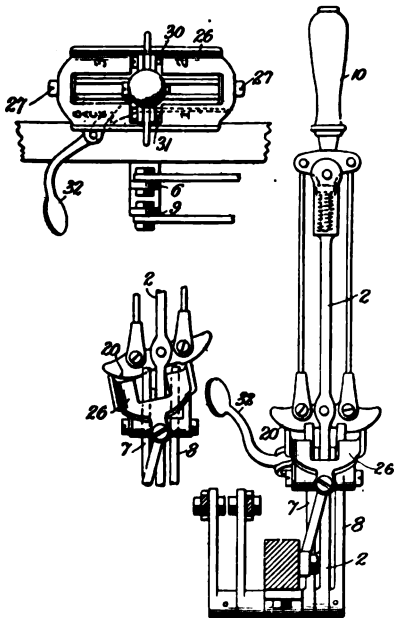

FITZGERALD SPEED-CHANGE LEVERS.

side to side, a spring (dotted) at the base of the handle tending to keep it vertical. When thus rocked it rocks the cam piece

20 21, as seen in the detail. This cam piece normally engages notches in the tops of levers 7 and 8, connected to the gear mechanism, but when rocked it disconnects from one of them. It also acts on the segmental locking plate 26, which is pivoted at its ends by screws 27, and which has central recesses 30 31, which normally engage and lock 7 and 8. In the neutral position, therefore, as shown in the full rear view, no movement of 7 and 8 is possible. When 20 is rocked, however, 26 is rocked also by the cam piece, so that one lever, as 7, is free to move in the long central slot in 26, this also being the lever still engaged by the cam piece. The other, as 8, is both released by 20 and locked by 26, so that it remains stationary while the fore-and-aft movement is performed, which engages the gears. Pedal 32 actuates a supplementary lock, which prevents engagement of the reverse till it is pressed.

Speed Changing Gears.

No. 770,820.—T. B. Rennell, of Denver, Colo.

A mechanism by means of which the gears are shifted and at the same time are caused to mesh at the tips of the teeth, as

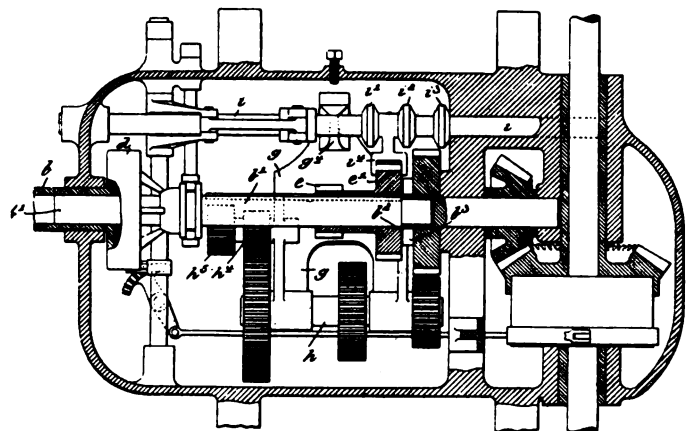

RENNELL SLIDING GEAR CHANGE-SPEED MECHANISM.

in the Renault machine, instead of at the ends, as ordinarily. In the plan section, *b* is the driving shaft, *d* a clutch answering to the usual flywheel clutch, and *b1* the first gear shaft, on which pinions *e* and *e1* slide. The direct drive is obtained by the claw clutch *b2 b3* in the position shown. In this position none of the change gears are in mesh. The jackshaft *h* is carried in bearings in a wide ribbed casting *g*, pivoted at *g1* to rock, so as to engage or disengage the gears at the tips of the teeth. A spring (not shown) holds it normally in the disengaged position, as shown by dotted lines in the vertical section. It is brought to the active position by any one of the coned disks, *i1, i2, i3* on the shifter rod *i*, these disks acting on a raised or cam portion *g4* on *g*. The pinions are shifted by *i4*, and when they are nearly in the working positions, the complementary gears are brought into mesh with them by the cam

action described. The third position is for the reverse, through pinions *h4, h5*.

Control Mechanism.

No. 768,148.—T. B. Rennell, of Denver, Colo.

A combination of levers operated by the hand lever at the side, so arranged that fore-and-aft movement of the hand lever shifts and meshes the gears described in

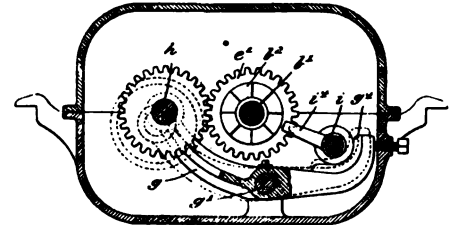

VERTICAL SECTION OF RENNELL GEAR.

No. 770,820, and right-and-left oscillation movement of the same lever effects engagement or release of the clutch.

Detachable Driving Mechanism

No. 770,936.—W. S. Simpson, of London, Eng.

A detachable frame 1, carrying a motor and tank, with the necessary accessories. A rear trailer wheel 4 is carried by a

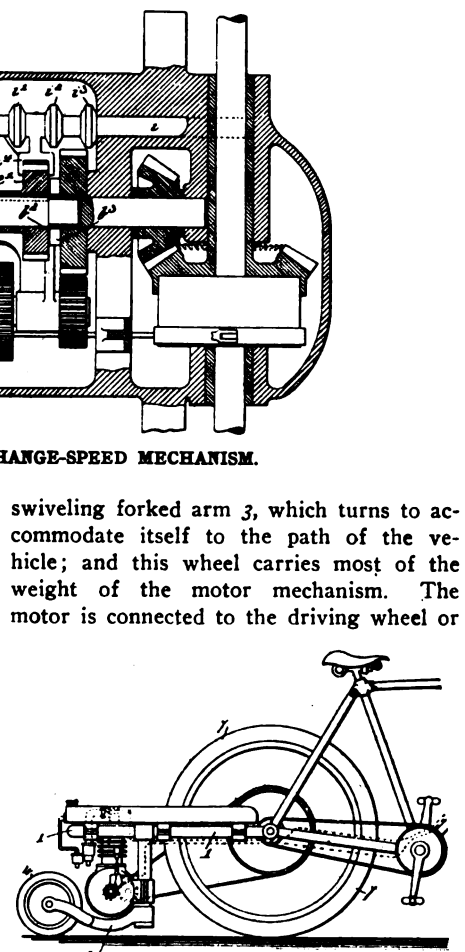

SIMPSON BICYCLE-DRIVING TRAILER.

wheels 7 by a chain or belt. According to the inventor, this device may be applied to any sort of light vehicle.



VOL. XL

No. 1

Published every Saturday by

THE CLASS JOURNAL CO.,

Flatiron Building, Madison Square,
NEW YORK CITY.Cable Address - - - Autoland, New York
Long Distance Telephone - 300 Gramercy, New York

SUBSCRIPTION RATES:

United States, Canada and Mexico, - One Year, \$2.00
Other Countries in Postal Union, - One Year, \$3.00To Subscribers—Do not send money by ordinary mail.
Remit by Draft, Post-Office or Express Money Order,
or Register your letter.

FOREIGN SUBSCRIPTION AGENTS:

ENGLAND:—Iiffe & Sons, Limited, 3 St. Bride Street,
Ludgate Circus, London, E. C.FRANCE:—Boyveau & Chevillet, 22 Rue de la Banque,
Paris.

GERMANY:—A. Seydel, Mohrenstrasse 9, Berlin.

To Advertisers—Copy or changes in orders for advertisements should reach us not later than 5 o'clock p. m. Monday for the issue of Saturday following.

Copyright, 1904, by The Class Journal Company.
Entered at New York, N. Y., as second-class matter.

The Automobile is a consolidation of The Automobile (monthly) and the Motor Review (weekly).

Copies Printed This Issue, - - 12,000

" " Since Jan. 1, - 531,000

Track Racing in America.

Apparently the Vanderbilt road race has had the effect of greatly stimulating public interest in automobilism. Enquiries for cars from unexpected sources have been numerous in the metropolitan district of New York since the race, and a wider expression of public interest is found in the very large attendance at the track races at Brighton Beach last Saturday. With this increasing public interest in automobile racing comes an increased responsibility on the part of those charged with the conduct of such races in any capacity.

There is no reason in morals or sportsmanship why automobile races should not be conducted with as strict regard for the proprieties as horse races, for example. This applies more especially to track races. Road races, endurance trials and the like have for their real purpose the technical trial of design and construction under scientific methods of observation, and the sporting side of such contests is really only incidental. It is quite the reverse with track races; they are sporting events pure and simple, of little practical and no scientific value.

If a machine breaks down in a track race or fails by reason of faulty construction it is simply not among the winners. The reason for its failure is not recorded by the race management, and the performances of

any but the winners are not even announced. No scientific record of excellence of performance is kept.

The track race provides an afternoon's sport for the public at so much a head. Its chief purpose is to make money for the management, and in this important respect it has nothing in common with the serious trials of cars, which are usually a source of considerable expense to the promoters, and are invariably conducted without charge to the spectators. When a man has paid an admission fee to witness a race he has certainly acquired a proprietary right; a right to have the race conducted as represented and with strict adherence to the written and unwritten rules of good sportsmanship.

This was certainly not the experience of those who attend the Brighton Beach meeting. Several cars advertised to be driven in competition did not put in an appearance, and in two races the most widely advertised driver, Barney Oldfield, "laid down," in sporting parlance, when passed by another driver. This last offense corresponds exactly to that detestable practice in horse racing known as "pulling" a horse, a charge which, if proven, would cause any jockey club of repute, the world over, to rule the offender off the track.

For failure to start and for misconduct of drivers in races the management cannot be blamed, when, as in the case at Brighton Beach, it has booked the entries in good faith. It is distinctly up to the Racing Board of the American Automobile Association to stop these practices. This organization is the jockey club of automobilism in this country, and it cannot shirk its responsibilities without such a loss of prestige as will inevitably lead to the passing out of its hands of racing control into those of some more courageous body. Entries for self-advertisement are not only unsportsmanlike, but unfair to a public which pays the required price of admission.

Another unpleasant feature of Saturday's races, for which it is not clear that the race promoters are free of responsibility, was the petty "graft" in the nature of a charge of 50 cents for each car that entered the enclosure. This was nominally in return for a "Buggy and Carriage Check," but was actually a "holdup," as no services worth any monetary consideration were given in return by the track proprietors.

Let us have clean, high-class racing or none at all.

**Information About Customers.**

It is essential that an automobile dealer obtain information of the means and standing of those who desire credit of him. This is no easy task, and many people seem to have given it up in despair. Some, having no faith in human testimony, will sell to no one on credit whom they have not known from long personal acquaintance. Others take the opposite course, sell to all applicants alike, trust-

ing to Providence for a safe deliverance from all their fears. One frequently possible source of information is any similar establishment with which the customer has had dealings. This information, of course, may be defective, but it is usually better than none, and the ordinary courtesies of trade should lead to an impartial and prompt report from one dealer to another. Other sources of information are from parties not in the trade, but known to the dealer, who live in the same locality as the applicant. The professed object of the mercantile agencies is to collect reliable data relative to the home standing and character of the men engaged in all lines of business throughout the country, and to embody it in reports for the convenience of those who are willing to pay for it. If this system could be infallible—or, in other words, if all the correspondents of these agencies were omniscient men, above all favor and prejudice,—it would be as perfect as anything could be. But, unfortunately, this cannot be; their reports are not infallible, as satisfactory evidence has repeatedly demonstrated, hence the necessity for independent investigation.

The main source of information is to see the man and listen to his own statements. This, like all other means of investigation, will sometimes fail, but generally the appearance and manner of a man will show his character. A man who is not worth a dollar in visible property is frequently more worthy of credit than another who has visible assets of thousands. Losses very often occur in trusting to property and reports and not to men. "If you have a doubt whether a customer be honest or tricky, speculative or prudent," says an old banker to his fellow-bankers, "be guided by the impressions of the first interview. In nine cases out of ten these impressions will be found to be correct."

It is a good plan also to expect that strangers desiring credit shall be introduced by some person to whom they are personally known, in which case the character and reputation of the introducer should not be overlooked in making judgment of his friend. Where the reference is good and the impression of the first interview favorable, it would be an excellent custom to have what might be called an "Information Book," in which to jot down notes of the statements made at these times. The data collected in this manner is more accurate, in a majority of cases, than the report of any outside party.

Of course, the smaller the business, and the more locally confined, the easier this plan is to follow. Were it a general rule to require satisfactory advance information, it would be accepted as a matter of course, though some would no doubt be disposed to "skulk" definite statements. It would possibly improve the credit system to repeal all laws for the collection of debts (a plan advocated by a great many persons) and increase the penalties for false representation.

Liability to Damages.

When automobiling on the highway the driver of a car should not forget that, quite aside from any local or State speed laws he is called upon to observe, there are legal obligations imposed upon him in common with all other road users. In a general way it may be said that speed laws regulate the management of the car as a unit and apply equally in a crowded street or a lonely country road, while other provisions of law apply to the management of a car in its relation to other road users. This point, which we have referred to on occasion, is very often forgotten by drivers, and seems to have been lost sight of altogether by the defendant in a recent damage suit in New York State. Substantial damages against the driver of a car were awarded by the jury in the fourth judicial district in New York, before Justice Spencer, who held that reckless disregard of the proper use of a public highway and the rights of those entitled to use it in a proper manner was sufficient ground for recovery for wilful assault.

The parties to the suit were Charles D. Clement, a farmer of the town of Saratoga Springs, and Milton C. Hastings, chauffeur for Edward D. Murphy, Jr., son of former Senator Murphy of Troy, N. Y. The accident happened at Saratoga Springs on July 11 last on Union avenue.

On the trial the evidence showed that Clement was driving to his home when Hastings came up behind his carriage and, colliding with the rear wheel, overturned the vehicle, throwing the plaintiff heavily to the ground. His injuries were slight, but his carriage was wrecked. Hastings and three companions were out for a ride and testified that on approaching the carriage the chauffeur gave warning of his approach, expecting the driver would turn to one side. They were going at a rate of speed that prevented clearing the wagon when the driver did not turn out. Clement testified that he was deaf and did not hear the signals nor the approach of the automobile from the rear. Attempts were made on the trial to prove that Clement could have heard the warning signals and tests were made, but without success.

Justice Spencer charged the jury that at the time of the collision the plaintiff was entitled to the use of the highway; that if defendant was driving in a reckless and wanton manner, and indifferent to the consequences, it constituted wilfulness, and the plaintiff was entitled to recover. The jury returned a verdict of \$600 damages.

Italy's entry for the 1905 Gordon Bennett race for 1905 has already been forwarded to the Automobile Club of France. Three firms have notified the Automobile Club of Turin of their intention of entering Fiat, Rapid and Italia cars in the elimination trials. The Napier team has already been appointed by S. F. Edge, and will consist of Cecil Edge, J. W. Stocks and A. MacDonald. Mr. Edge himself has no intention of driving in the event.

EUROPEAN RACING CIRCUIT IS PROPOSED.

Italian Sportsman Suggests Grouping Leading Contests in Six-Weeks Program Beginning in Paris and Ending at Palermo, Italy.—Motorcycle and Auto-Boat News.

Special Correspondence.

PARIS, Oct. 14.—The latest in automobile races is the *Circuit Latin*. A rich Italian sportsman, the Chevalier Vincenzo Florio, has brought forward a scheme to group together five existing contests, and to create a sixth, so arranging them that instead of being six opposing meetings they shall form parts of one great contest. The races are: 1—The Mount Ventoux race; 2—The Mount Cenis race; 3—The Brescia contest; 4—The Kilometre at Podone; 5—The Consuma race; 6—The Palermo race.

The prizes for these different races amount to about 20,000 francs (\$4,000) which, together with the 10,000 francs to be gained for tires, would amount to 30,000 francs (\$6,000) for the car winning the entire series. The dates of the meetings would be so arranged that all the cars could travel by road. Starting from Paris they would go to Avignon, then to Mount Cenis, Brescia, Padone, Florence, and finally to Palermo. For the return to France, Chevalier Florio, who is also one of the directors of an important Italian steamship company, offers to transport gratuitously to France, on one of his company's vessels, all the automobiles taking part in the Palermo race.

The circuit would afford about three weeks of good sport, say from the end of August to the middle of September, and would not incur very much expense on the part of automobile builders. While the intention is to create a contest extending over the six meetings, local entries would also be accepted from those only wishing to run in one race.

100-KILOMETER MOTORCYCLE TEST.

The "third of a litre test," the finals of which were run at the Parc des Princes, Paris, on October 9, while not affording anything new in the way of record breaking, was interesting as a test of the capabilities of motorcycles. The event was limited to motorcycles with cylinders of one-third of a litre capacity, and after a week's preliminary races, twelve machines were brought together for the final. The remarkably even running of the motors is shown by the fact that all twelve competitors finished the race, there being a difference of only twenty minutes between the first and last. The race, 100 kilometers, was won by Anzani in a belt-driven Alcyon motorcycle, his time being 1:18:37.5. The record for the hour was 77 kilometers 900 meters. The last cycle finished in 1:41:58.

If permission can be obtained, next year's race will probably be on the road, and will be over a distance of at least 300 kilometers. By this means an even more practical test of the powers of motorcycles will be obtained.

SEINE AUTO-BOAT RACE MEDALS.

The motor boat race in connection with the Salon d'Automobile, held annually in Paris during the month of December, promises to be a great success. Starting from the Alexandre III. bridge, in the center of the city, and within two minutes of the Grand Palais, in which the automobile show is held, it will be sure to draw together a large number of spectators. Gold medals have been offered by nearly all the Parisian newspapers of importance. The following classes have been organized:

The *Gaulois* medal for cruisers up to 6 1-2 meters, *Press* medal for cruisers of 6 1-2 to 8 meters, *Yachting Gazette* medal for cruisers of 8 to 12 meters, *L'Echo de Paris* medal for cruisers of 12 to 18 meters, *Matin* medal for racers up to 8 meters, *Figaro* medal for racers from 8 to 12 meters.

Extra classes: *La France Automobile* medal for motors up to 8 horsepower, *Eclair* medal for motors from 8 to 12 horsepower, *Petit Journal* medal for motors from 12 to 24 horsepower, and *Journal des Débats* medal for motors above 24 horsepower.

RACE AROUND FRENCH COURSE.

The auto-boat race now being organized by *Le Journal* is not lacking in originality. Known as *Le Tour de France*, the race will start from some port on the northeast coast of France and will continue by stages down the channel and along the west coast of France to Bordeaux. By means of the Garonne and the two canals, the Mediterranean will be reached, and the race will finish at Toulon.

The scheme is daring, for a tour round the coast of France, even in good weather, is no small affair for a motor-boat. The difficulties of organization, too, are great, and all details need to be carefully studied if the event is to be of any practical value.

LAW UNCONSTITUTIONAL.

Illinois Judge Holds Six-Mile Limit is Unreasonable and Discriminates.

Special Correspondence.

STERLING, Ill., Oct. 24.—Judge O. E. Heard, of the Lee County Circuit Court, handed down an important decision on an ordinance recently passed by the city council of Dixon limiting the speed of automobiles to six miles an hour. The judge held that the law was unconstitutional, ruling that cities could not govern the speed of automobiles.

Several months ago the city council of Dixon passed an ordinance regulating the use of autos within the city limits, and fixed the maximum speed at six miles an hour. Automobile owners took offense at the ordinance and, after consulting attorneys, decided to test it. Egbert R. Kent was arrested on the charge of violating the regulation and was given a trial before the police court. He pleaded guilty to the charge and was fined \$20. He appealed the case to the Lee County Circuit Court.

Judge Heard, in his decision, says: "The ordinance limiting the rate of speed of autos to six miles an hour is unreasonable and void because it is oppressive; said ordinance unduly discriminates against autos and is void; said ordinance is void, because while in some portions of the business district of the city of Dixon the rate of speed might be limited to six or eight miles per hour and be reasonable, yet in other portions of the city the speed limit of six miles an hour is unreasonable, oppressive and tends to create a monopoly in favor of means of travel not included in the ordinance or expressly excepted from its operation."

The Boston Automobile and Power Boat Show for 1905 will be held in the Mechanics Building, Boston, Mass., March 13 to 18 inclusive. The exhibition will be under the auspices of the Boston Automobile Dealers' Association, incorporated. Space diagrams have been issued; these and other information may be obtained from Chester I. Campbell, Manager, 5 Park Square, Boston, to whom all communications should be addressed.

NEW WORLD'S RECORD.

Kiser and Gorndt Put Up New Figures from Sixteen to Fifty Miles.

Special Correspondence.

CLEVELAND, Oct. 24.—As the result of the record-breaking trials held on the Glenville track last Wednesday afternoon, all world's track records from ten to fifty miles, and the one mile record, are now held by Winton cars. To vindicate the two *Bullets*, which failed to show satisfactorily in the races the previous Saturday, arrangements were made to send both cars after all world's records, with A. A. A. sanction. The trials constituted the entire program of a free matinee given under the auspices of the Cleveland Automobile Club. About 3,000 spectators took advantage of the opportunity for a free show.

Charles Gorndt, with the four-cylinder Gordon Bennett racer of 1903—*Bullet No. 3*—was sent after the 50-mile record made by H. S. Harkness with the Mercedes at Asbury Park last August. It was 2 p.m. when Gorndt was sent away with a flying start. He seemed to have trouble with his machine during the first part of the trial, his time for the eighth mile, which was his slowest, being 1:17 1-5. The eleventh mile was almost as slow, and then he began to improve gradually until the twenty-ninth mile, when he reached a maximum speed of 1:02 4-5 seconds for the mile. From the thirty-sixth mile his speed gradually decreased, and from that on his work was erratic. When he began to get inside the records at twenty-one miles he was given a round of applause. Mr. Winton signalled to Gorndt that he was doing well and Gorndt waved his acknowledgment.

Some of the officials wanted him to go on and break the sixty and seventy-five mile records, but Mr. Winton feared that the tires were in danger. When Gorndt stopped in front of the grandstand almost the first to greet him was his wife, followed by his enthusiastic brothers and sisters.

Much to the surprise of everyone, it was found that the tires on the car were hardly warm and apparently were in as good condition as when they were put on.

Kiser with *Bullet No. 2* was then started for the twenty-five-mile record. The magneto sparking apparatus which had given trouble the week before had been removed and the old dry batteries had been put on for the trial. With a flying start, the first mile was made in 58 seconds, two miles in 1:55 2-5, three in 2:53 2-5 and four in 3:52 4-5. At this rate he was a long way from the records for the lower marks and he was stopped. It was found that one of the wires leading to a spark plug had been grounded. After this had been remedied the car gradually increased its speed. At fifteen miles Kiser was only three seconds from Oldfield's record, and at sixteen miles he was more than twenty seconds inside of Sartori's record made at Empire City track. At twenty miles he was twenty-nine seconds ahead of Sartori's record, and after that he began cutting down the figures which Gorndt had just made with the smaller car. Kiser's twenty-first mile was made in 56 seconds, the fastest of the day. His time for the twenty-five miles was almost five minutes faster than Harkness's record. A lower record than that of Harkness is claimed, however, by Oldfield, who made twenty-five miles at Buffalo in the *Green Dragon* in 26:42. This was beaten by Kiser, but was not equalled by Gorndt.

Oldfield was present and watched the work with interest. He was asked to bring the *Green Dragon* out for a trial, but the car was being overhauled preparatory to being shipped East. L. P. Mooers, of the Peerless Company, was asked if Oldfield would be sent after the new records, and he stated that Oldfield would go after all records up to 100 miles in the near future.

Not a little credit for the work of the *Bullet* was due to Charles W. Mears, editor of the Winton house organ, who arranged a schedule and signal code to keep the drivers informed what they were doing.

The new records are as follows:

NEW WORLD'S RECORDS MADE BY KISER AND GORNDT, OCTOBER 19.

Miles.	Times.	Holder.	Previous Record.	Made by.	Car.	Place.	Date.
16	15:20 2-5	Kiser	15:41 2-5	Sartori	Mercedes	Yonkers	July 18, '04
17	16:17	"	16:39 4-5	"	"	"	" " "
18	17:14	"	17:38 4-5	"	"	"	" " "
19	18:11	"	18:37 1-5	"	"	"	" " "
20	19:08 2-5	"	19:37 1-5	"	"	"	" " "
21	20:04 2-5	"	23:47	Gorndt	Winton	Glenville	Oct. 19, "
22	21:01 2-5	"	24:52 2-5	"	"	"	" " "
23	21:59 3-5	"	25:56	"	"	"	" " "
24	22:58	"	26:59 3-5	"	"	"	" " "
25	23:59	"	28:03 2-5	"	"	"	" " "
26	29:07 1-5	Gorndt	Harkness	Mercedes	Long Branch	Aug. 18, "
27	30:11	"	"	"	"	" " "
28	31:14 3-5	"	"	"	"	" " "
29	32:17 2-5	"	"	"	"	" " "
30	33:20 4-5	"	34:09 1-5	"	"	"	" " "
31	34:25	"	"	"	"	" " "
32	35:29 4-5	"	"	"	"	" " "
33	36:35 3-5	"	"	"	"	" " "
34	37:41	"	"	"	"	" " "
35	38:46 3-5	"	39:51 1-5	"	"	"	" " "
36	39:53	"	"	"	"	" " "
37	41:00 2-5	"	"	"	"	" " "
38	42:08 2-5	"	"	"	"	" " "
39	43:14 4-5	"	"	"	"	" " "
40	44:20 2-5	"	45:30 2-5	"	"	"	" " "
41	45:26	"	"	"	"	" " "
42	46:32	"	"	"	"	" " "
43	47:39 4-5	"	"	"	"	" " "
44	48:47	"	"	"	"	" " "
45	49:55 3-5	"	51:08 4-5	"	"	"	" " "
46	51:04	"	"	"	"	" " "
47	52:13	"	"	"	"	" " "
48	53:22 1-5	"	"	"	"	" " "
49	54:32 2-5	"	"	"	"	" " "
50	55:42	"	1:01:23 1-5	"	"	"	" " "

GRADE CROSSING SUIT.

E. B. Cornwall Asks Damages from R. W. & O. R. R. for Rochester Accident.

Special Correspondence.

ROCHESTER, Oct. 24.—The halftone which appeared on page 475 of last week's *AUTOMOBILE*, showing the wreck of Edward B. Cornwall's Winton touring car that had been struck by a locomotive on the Rome, Watertown & Ogdensburg Railroad, is from one of a set of photographs that is being used as evidence in a suit brought by Mr. Cornwall against the railroad company for damages.

This is probably the first time in the history of automobiling that the damaged party has brought suit against the railroad for a grade crossing accident, and if Mr. Cornwall can convince the jury that what he says is the truth he seems to stand an excellent chance of recovering the full amount sued for—\$25,426.70.

As the picture of the wrecked machine plainly shows, the automobile was completely demolished, being carried on the pilot of the locomotive a distance of 200 feet. The clothing of both Mr. Cornwall and his aged mother, who accompanied him, were ruined. Mrs. Cornwall lost a diamond valued at \$40, a pair of eyeglasses valued at \$9 and a pair of gloves valued at \$2. All of these items are included in the suit, as well as a big doctor's bill for each patient, hospital charges, and money compensation for receiving injuries from which entire recovery is impossible.

Summons and complaint in both suits were filed Saturday with the Monroe County Clerk. Negligence on the part of the flagman at the crossing and the excessive speed of the train are alleged by the plaintiffs to have been responsible for the accident. John Van Voorhis & Sons are the attorneys for the Cornwalls.

Cornwall's complaint alleges that he was driving his automobile carefully and cautiously in an easterly direction along Clifford street, and on nearing the tracks brought the machine to a stop to ascertain if it were safe to cross. Cornwall asserts that a flagman was stationed at the crossing, and that after he had brought the automobile to a stop the flagman signaled to him to cross.

Cornwall started the machine and was almost on the tracks when he discovered the approaching train, which, he alleges, was going at an illegal rate of speed. He tried to stop, but it was too late. The engine crashed into them and carried the machine and occupants 200 feet down the track before it could stop. Both occupants were rendered unconscious. Mr. Cornwall received a broken collar bone, a fractured left shoulder, a number of severe scalp wounds, had his forehead torn open, his right leg below the knee skinned and bruised, his left leg and left wrist sprained and will always be deprived of the free use of his left arm and shoulder, he declares.

Mrs. Cornwall had two ribs fractured, her collar bone broken, her right shoulder dislocated, her right thigh severely cut, left arm bruised, wrist and ankle sprained and suffered a general muscular strain and concussion of the brain. The doctors say she will never fully recover from the shock to her nervous system or have the free use of her arms again.

Both allege that the crossing is a most dangerous one, that the flagman was incompetent, that the train was running at an unlawful speed and that it gave no warning by either bell or whistle.

AMERICAN AND FOREIGN AUTOMOBILE AND AUTO-BOAT FIXTURES.

- Oct. 29.—Special Race at Empire City Track, Yonkers.
- Oct. 29.—Auto-Boat Race, New York to Poughkeepsie, Hudson River.
- Oct. 30.—Gailion Hill Climb, France. *L'Auto*.
- Nov. 20.—100-Kilometer Trials. A. C. of Algeria.
- Nov. 24.—Hill Climbing Contest, Eagle Rock Hill, Orange, N. J. W. J. Morgan and New Jersey A. & M. C.
- Dec. 9-25.—French Automobile Salon. Paris.
- Dec. 26-Jan. 2.—Reliability Trials. Motor Union of Western India.
- Jan. 11-24.—First Annual Importers' Automobile Salon, [Herald Square Hall, New York.
- Jan. 12-21.—Fifth Annual Automobile Show, Madison Square [Garden, New York. N. A. A. M., Madison Square Garden Co. and A. C. A.
- Jan. 14-24.—Fourth Annual Automobile Show at Brussels, Belgium.
- Jan. 23-28.—Philadelphia Annual Automobile Show. A. C. of Philadelphia and Auto. Dealers' Assn. of Phila.
- Jan. 27-Feb. 4.—Fourth Annual Automobile Show, Crystal Palace, London.
- Feb. 4-11.—Fifth Annual Automobile Exhibition, Chicago. Coliseum Building. N. A. A. M. and C. A. C.
- Feb. 4-19.—Automobile Exhibition at Berlin, Germany.
- Feb. 5-19.—Automobile Week, Nice, France.
- Feb. 10-18.—Automobile Exhibition, London, England. Society of Motor Manufacturers and Traders.
- Feb. 13-18.—Fourth Annual Exhibition at Detroit. Tri-State Automobile and Sporting Goods Association.
- Feb. 21-March 9.—National Motor Boat Show, Madison Square Garden, New York. Nat. Assn. Engine and Boat Mfrs.
- Feb. 27-March 4.—Cleveland Automobile Show. Cleveland Automobile Club.
- Feb. 27-March 4.—Automobile Exhibition, Toronto Canada.
- March 3-11.—Motorcycle Show, Liverpool, England.
- March 6-11.—Third Annual Buffalo Automobile Show, Convention Hall, Buffalo. Buffalo Automobile Trade Assn. and Buffalo A. C.
- March 4-18.—Fourth Annual Automobile Show, Boston. Boston Automobile Dealers' Assn.
- March 27-April 5.—Fifth Annual Washington Automobile Show. Washington Auto. Dealers' Assn.
- April 1.—Light Van Trials. A. C. of Great Britain.
- April 2-16.—Monaco Motor Boat Fortnight.
- June 26.—Mont Cenis Hill Climb.

EAGLE ROCK HILL CLIMB.

Many Entries Presage Unusually Good Sport on Thanksgiving Day.

The Eagle Rock Hill Climb will be held on November 24, as usual, and the classification list just issued by the Automobile Club of New Jersey is so comprehensive that a full entry list should result. Several entries were received early this week, even before the entry blanks had been officially sent out. William K. Vanderbilt, Jr., entered his new 90-horsepower Mercedes, which he will drive himself; William Wallace will drive his 90-horsepower F.I.A.T.; Paul Sartori will drive A. G. Vanderbilt's 90-horsepower F.I.A.T.; and E. T. Birdsall has entered a 40-horsepower Decauville, which will be driven by Guy Vaughn. Among those who have expressed the intention of entering are E. R. Thomas, 60-horsepower Mercedes; H. L. Bowden, 60-horsepower Mercedes; ex-Jockey Tod Sloan, 40-horsepower Decauville; F. A. La Roche, 80-horsepower Darracq racer, a new car that is now on its way to this country; James L. Breese, 60-horsepower Mercedes; Leon Théry, 80-horsepower Richard-Brasier; W. Gould Brokaw, 60-horsepower Renault. These are all in the racing classes.

- The classes are as follows:
- Event 1.—Electric stock cars.
 - Event 2.—Steam stock cars.
 - Event 3.—Gasoline stock cars selling for \$850 and under.
 - Event 4.—Gasoline stock cars selling for \$850 to \$1,250.
 - Event 5.—Gasoline stock cars selling for \$1,250 to \$2,000.
 - Event 6.—Gasoline stock cars selling for \$2,000 to \$3,000.
 - Event 7.—Gasoline stock cars selling for \$3,000 to \$5,000.
 - Event 8.—Gasoline stock cars selling for over \$5,000.
 - Event 9.—Class A, 1,432 to 2,204 pounds.
 - Event 10.—Class B, 851 to 1,432 pounds.
 - Event 11.—Class C, 551 to 851 pounds.

Stock cars must be equipped according to catalogue specifications. In events 2 and 4, however, tonneaus may be removed; two persons must occupy each car. Each car competing in events 5, 6 and 7 must carry a tonneau and four persons. Cars in event No. 8 may be stripped. Entries will be received by C. H. Gillette, 31 West Forty-second Street, New York, the entry fee being \$5. Foreign cars must be entered at their selling price in the United States.

"The list of stock car entries will be something fierce," said C. H. Gillette. "I wouldn't be surprised if we had, all told, sixty cars on the hill on Thanksgiving

Day. The best time ever made on the hill was made last year by W. K. Vanderbilt, Jr., in a 60-horsepower Mors. His time was 1 minute 36 3-4 seconds. But those big 90-horsepower cars will go up the hill as if they were on the level, and the car that makes the best time will be the car that makes the best turns. The turns are downright bad at high speed. The record will be lowered to 1 minute 30 seconds easily."

Harlan W. Whipple will drive a White steam car in the stock car classes, Joseph Tracy will drive a Royal Tourist, and C. H. Gillette will pilot a Pope-Hartford. The timing will be done with the McMurtry electric timing apparatus, which will be in the capable hands of Mr. McMurtry himself. The stock cars will probably be sent up at 3-minute intervals; but the racers will go one at a time. The referees will be A. R. Pardington, who will officiate at the start, and S. A. Miles, who will welcome the competitors at the finish. Secretary Butler, of the A. C. A., will be one of the timekeepers. The other timekeepers, the clerks of the course and the judges have not yet been appointed. A technical committee of three will be appointed to inspect all machines to see that the rules of the contest are complied with in every way.

For the information of those who are not familiar with the Eagle Rock Hill, it may be said that it is exactly a mile long from the beginning of the grade to the commencement of level road at the top. The grade runs all the way up to 17 per cent, though this figure is touched only at one point and for a very short distance. In general, the grade is from 8 to 12 per cent, and the road is a fairly good one. What makes the hill very difficult, however, is its sinuosity, two turns in particular being very sharp. In fact, one is somewhat sharper than a right angle, and is on the steepest part of the hill near the top.

When a car has climbed the hill it will not be permitted to return the way it came, but must keep to the left and return to the starting point by a roundabout way, the distance being between two and three miles.

The winners will be awarded banners and certificates, and President Farrington, of the Automobile Club of New Jersey, will put up a trophy for the car making the fastest time of the day.

BOSTON DEALERS BECOME SOCIABLE.

Special Correspondence.

BOSTON, Oct. 27.—The first outing of the members of the Boston Automobile Dealers' Association was held last Friday. Rain came down in torrents during the afternoon, and the wind blew a gale, but the men in the trade are used to all conditions, so the

rain and wind did not prevent them from having a most enjoyable trip over the roads to Fern Croft Inn at Danvers, where dinner was served. Afterward the motorists drove back to Boston.

This outing was a result of a suggestion at a recent meeting of the association, that the members ought to infuse a little more sociability into their gatherings. They have gathered for business purposes time and again, and now it is proposed that they get together once in a while for a pleasant time, with shop talk barred. Among those on the outing were J. H. MacAlman of the Locomobile agency; A. E. Morrison of the Peerless; Harry Fosdick of the Winton; E. A. Gilmore of the Rambler; J. Hathaway of the White; Charles E. Fay of the Winton; A. R. Bangs of the Franklin, and many other agents and dealers.

RECENT INCORPORATIONS.

Automobile Supply Mfg. Co., Brooklyn, N. Y.; capital, \$15,000. Directors, Salvatore Salvine, New York; Errico Pascucci, and Louis Rubes, Brooklyn.

Aquamobile Company, Oakland, Cal.; capital, \$250,000; to deal in steam, gas, electric, gasoline and other motors. Incorporators, James D. McFarland, of Fruitvale, and others.

Berkshire Automobile Co., Springfield, Mass.; capital, \$15,000; to manufacture automobiles. Incorporators, Dr. William J. Mercer, Frank V. Wyland, F. A. Cooley and Clarence P. Hollister.

Zent Automobile Mfg. Co., Bellefontaine, O.; capital, \$25,000.

Neal, Clark & Neal Co., Buffalo, N. Y.; capital, \$7,500; to deal in automobile and bicycle sundries. Incorporators, Olin L. Neal, Harry B. Clark and Benjamin E. Neal.

Electric City Motor Co., Lynn, Mass.; capital, \$25,000. Incorporators, Samuel Bonton and John H. Madden.

Delaware Auto Storage and Repair Co., Wilmington, Del.; capital, \$25,000; to buy, sell, repair and deal in automobiles and motorcycles. Incorporators, Lewis Rumford, William E. Seaton and Leonard E. Wales.

It is reported that experiments have been made in running automobiles in sandy tracts in Great Britain, with a view to using these machines for passenger service in the Sudan. It is expected that after some alterations are made, the cars will be shipped to Khartoum. If this plan works successfully, desert travel will be robbed of many of its terrors.

BOSTON AGITATED OVER LIVERY AUTOS.

Cab Drivers' Union Induces Police Board to Threaten to Require City Licenses and Fix Hour Rates for Rented Automobiles.

Special Correspondence.

BOSTON, Oct. 24.—It looks now as if the automobile agents of Boston who rent cars by the hour, day or week, would have to bear more licensing and regulations. All automobilists in the State are now required to have certificates of registration, numbers, and operator's licenses from the State Highway Commission. In addition to these, the board of police may require another set of licenses and registration cards and possibly more numbers, for Judge Emmons has decided that automobiles that are rented are public conveyances, and as such should come under the rules and regulations applying to cabs and public hacks.

Another announcement that bothers the automobile livery men more than the prospective licensing by the police board, is that the police board intends to establish a fixed scale of prices to be charged by automobile owners renting their cars. The prevailing price in Boston is \$3 for the first hour and \$2 for each subsequent hour for a machine with a chauffeur. The established hour charge for horse-drawn carriages is as follows: For hacks, coupes, etc., \$1.50 for the first hour or fraction thereof, and fifty cents for each twenty minutes thereafter; for cabs, \$1.00 for the first hour or fraction, and twenty-five cents for each quarter hour thereafter.

The whole subject of the licensing of automobiles by the city, and the establishment of rates has been brought up by the cab drivers' union. When the Sightseeing Auto Company first put the "rubberneck" wagons in service in Boston a delegation from the union appeared at police headquarters and protested against the granting of licenses for these wagons. The cab drivers complained that the sightseeing wagons took away much of their business, and that they were so big that they blocked the streets and frightened the horses. The police board, however, after investigation, found that these vehicles are considered and treated as public conveyances in other cities, and therefore granted the licenses for them.

The cab drivers' union then turned its attention to the automobile agents in the city who are advertising automobiles for rent. They said that automobiles were being rented greatly to the detriment of their business. The police board hadn't heard officially of the renting of automobiles, and when it asked for more particulars, the union men brought to the office a card of an automobile agent, upon which were given the rates for the renting of automobiles.

As a result, the police board has instructed the captains of the different police divisions to canvass their territory and send to the board a list of all persons who are renting automobiles. When these reports are in the board will invite the automobilists to a conference at police headquarters, and the questions of proper automobile rates will be talked over. The board thinks that the present rates charged for automobiles are too high, and it may cause them to be lowered considerably. The board has already decided that automobile owners who rent their cars must take out carriage licenses, the same as owners of horse-drawn public vehicles. Public conveyances are also required to have a city number, and if the same requirement is made in the case

of the automobile, there is likely to be some complication, as the State Highway Commission now requires that a number be shown on almost every available place.

There are only a few local dealers now in the business of renting machines at hour rates, although quite a number are accustomed to rent cars by the day, but they all recognize that there may be a future in the automobile livery business, and therefore they will stand together in opposing onerous police regulation. The agents who let cars saw their attorneys, and the latter, after a scrutiny of the city ordinances, found that the police board has the power to fix rates and require licenses for public vehicles.

The agents have conferred with one another, and when they come before the police board they hope to be able to present their case so that rates will not be made which will make the automobile livery business unprofitable. They claim that their business does not interfere with that of the cab drivers, as it is of an entirely different nature. Said one of them to-day: "We are not competing with the carriage men in any way. If a man wants to go to the station or to the theatre or to make any short trip around town, he does not call for an automobile, but jumps into a cab just as he always did. He takes an automobile when he wants to make a long journey out of town, which he would make otherwise by train. We do not have our cars standing on the street corners soliciting passengers, but we have them ready for pleasure or business trips which nobody would think of making in a horse-drawn vehicle. Another thing which will make it difficult for the police board to fix an equitable scale of rates is the difference in automobiles. If rates are made they will have to be graduated. I cannot let my touring car, accommodating four or five besides the chauffeur, and capable of making a 100-mile run without a stop, at the same rate I can rent a little runabout for a short jaunt into the suburbs. If a man wants a finely equipped, enclosed electric carriage for an evening trip he cannot expect to get it for the same price he would pay for a small steamer."

CO-OPERATIVE GARAGE.

New Yorkers Organize a Sort of Private Service.—Brighton Beach Club.

Special Correspondence.

ALBANY, Oct. 24.—With the Secretary of State has been filed the certificate of incorporation of "The Club Garage of America," an organization or club composed of persons owning or operating self-propelled pleasure vehicles for personal or private use; to secure to members the best care for their machines and service at the places of their residences and other localities, thereby increasing and promoting the pleasure of touring; to furnish automobiles for the use of its members; to enter into contracts and arrangements for such terms as its governors or managers shall approve for the erection, leasing and care of buildings; the operation of shops, the making of repairs upon and furnishing care, attendants and operators for automobiles and motor-cars, and the buying and selling of the same on its account and for its members, or for any such purposes. And generally to maintain a club to secure the more efficient care and operation of motor vehicles and promote the sport of automobilism."

The principal office is in New York city. The directors are: Samuel F. Scott, 104 West Ninety-fourth street; George T. Williams, 251 West Eighty-first street; Waldo G. Morse, 10 Wall street; Lewis M.

Machado, 115 Broadway, and Leander Richardson, 109 West Forty-second street, all of New York city.

The Brighton Beach Automobile Club has also been incorporated for the purpose of conducting races, exhibitions and endurance tests of automobiles, and to manufacture, buy, sell or deal in automobiles. The capital stock is \$2,000, divided into 200 shares. The principal office is in the Borough of Brooklyn, and the directors are: William A. Engeman and Alzamora H. Battersby, of 215 Montague street, Brooklyn, and Charles H. Hyde, of 44 Court street, Brooklyn.

WORLD'S FAIR AUTO AWARDS.

Official List as Given Out by Superintendent of Transportation.

Special Correspondence.

ST. LOUIS, Oct. 24.—The automobile awards as given out by Willard Smith, Superintendent of Transportation at the World's Fair, are causing considerable comment, because they are so different from what many of the members of the National Association of Automobile Manufacturers expected. THE AUTOMOBILE representative was shown the list of awards as revised by the Superior Jury and the National Commission. The list is as follows:

Hors Concours (out of competition because the exhibitors were members of the jury); Adolphe Clement, Kellner, Rheims & Auscher, Malicet & Blin.

Grand Prize.—Hayes-Apperson Co., Electric Vehicle Co., Packard Motor Car Co., Geo. N. Pierce Co., Pope Manufacturing Co., Winton Motor Car Co., White Sewing Machine Co., Woods Motor Vehicle Co., Miami Cycle & Manufacturing Co. Among the French makes, Darracq & Co., Dietrich & Co., Michelin & Co., Renault Freres, Panhard & Levassor, Georges Richard, Societe Anonyme d'Electricite & d'Automobiles Mors, Societe Anonyme la Metropole (chainless bicycles). In the German automobile section Benz & Co., Daimler, Continental Caoutchouc & Gutta Percha Co. (pneumatic tires).

Gold Medal.—Knox Automobile Co., Vehicle Equipment Co., National Motor Vehicle Co., Eames Tricycle Co., Badger Brass Manufacturing Co. (automobile lamps), Goodyear Tire Co., Shelby Steel Tube Co. (automobile and vehicle tubes), Veedler Manufacturing Co. (odometers), Hendee Manufacturing Co. (motorcycles), Pope Manufacturing Co. (bicycles), J. H. Williams (forgings for automobiles). In the French section, Jeantaud, Societe Anonyme L'Aster, Postel-Vinay, Vauzelle Morel & Co., Hommond, Monter & Co., Botiaux & Cie.; among French lamp exhibitors, Bleriot, Chas. Billy, Ducellier. In the German section, Mitteldeutsche Gummaiwarenfabrik (pneumatic tires).

Silver Medal.—Cadillac, Ford Manufacturing Co., H. H. Franklin, Grout Bros., McCord & Co., Northwestern Military Academy (military automobiles), St. Louis Motor Carriage Co., Sintz Gas Engine Co., Smith & Mabley, E. R. Thomas Motor Co., Olds, Gray & Davis (auto lamps), T. B. Jeffery & Co., Saks & Co. (automobile clothing).

Bronze Medals.—Duryea Power Co., E. C. Redick (auto tires), Graham Co. (auto springs), Motsinger Device Manufacturing Co. (automobile sparker).

An automobile police patrol wagon will be placed in service by the civic authorities in Springfield, Mass., to replace the old horse-drawn wagons. It is thought that a gasoline machine will be selected.



The Racing Board of the American Automobile Association held a meeting on October 24 to consider the clash in dates between the Ormond Beach tournament, January 23 to 28, and the importers' automobile show, January 11 to 24. Owing to the fact that many of the foreign racing cars would be tied up at the exhibition while the racing was in progress on the beach, it was suggested that the date of the Florida carnival be changed. Racing at the beach is governed altogether by the condition of the tide, however, and when it was shown that the dates already fixed are the best available, taking the tide into consideration, it was decided to recommend that the cars leave the exhibition on Saturday, January 21, and be sent to the beach by specially arranged transportation facilities, which would ensure their delivery at Ormond on the following Monday. The promoters of the Florida meet agreed to have the most important events placed in the middle of the week, to give the late arrivals a chance to tune up. Those present at the meeting were W. K. Vanderbilt, Jr., Harlan W. Whipple, A. R. Pardington, James L. Breese, E. T. Birdsall and A. L. Riker.

* * *

The A.A.A. Racing Board now has all necessary information in hand regarding the controversy between Barney Oldfield and the Chicago Automobile Club, which organization, as reported in THE AUTOMOBILE of October 8, demanded the driver's disqualification on the ground that he raced at Pittsburg while under contract to race at Chicago on the same date. Oldfield has sent his side of the story to the Racing Board, and the matter is now under consideration. A meeting will be held in the near future to come to a final decision.

* * *

Barney Oldfield's fiasco at the Brighton Beach track on Saturday, October 22, brought down such a storm of criticism on his head that he begged for an opportunity to redeem himself in the eyes of the public. He now has all the chance he can desire, for a match race has been arranged between Oldfield, Thery, Bernin and Sartori, to take place at the Empire track on Saturday, October 29. The distance will be 10 miles and the race will be run off in two heats and a final. The prize will be a \$500 cup.

* * *

The law forbidding automobiles driven by steam or explosive motors to have their motors in operation on ferryboats, which made such a stir in automobiling circles last summer, is to be tested. When W. W. Niles and Jefferson Seligman, of the Automobile Club of America, went to Washington to secure, if possible, a more favorable interpretation of the law from Mr. Metcalf, secretary of the Department of Commerce and Labor, they were informed that nothing could be done except to institute a test case. This is now being done, and the United States Government will appear as plaintiff and the Brooklyn Ferry Company as defendant, with the object of ascertaining definitely just what the law requires of automobiles using the ferries. The papers are in the hands of Assistant United States District Attorney Baldwin, who is preparing the case. Nevada N. Stranahan, Collector

of the Port of New York, will appear for the government. It is not definitely known when the case will come up, but prompt action is expected.

* * *

Commissioner McAdoo is turning his attention to reckless drivers, other than automobilists, who make the streets of New York unsafe for all who use them. The cabby who prowls along the wrong side of the road in search of fares, the delivery wagon drivers who block traffic, and the irresponsible boys who scorch around corners and make themselves generally troublesome and dangerous; are all on the commissioner's list, and will come in for a share of his attention.

* * *

Last week's reports to the effect that Edward Shotwell had been committed to jail for thirty days in default of the payment of a fine of \$75 for exceeding the speed limit in New York city while driving Levi C. Weir's automobile, is denied by that chauffeur, who states that the fine was paid promptly at the time. According to his account, he had been ordered by his employer to bring the car in from the owner's Long Island home to meet him in town, but that, instead of going direct from the Hunter's Point ferry to meet the owner, Shotwell was on his way to change his clothing when arrested. He considers, therefore, that he was not making unauthorized use of the car at the time, as reported.

* * *

An interesting feature of the exhibition of foreign automobiles to be held in Macy's Hall, New York, January 11 to 24, will be the foreign racing machines, which will be exhibited for the first time at an American automobile show. The Clement-Bayard, Fiat, Panhard, and De Dietrich cars that took part in the Vanderbilt Cup race will probably be in this country for the Ormond tournament, or at least most of them, and will be seen at the show—according to present arrangements.

* * *

A general meeting of the American Power Boat Association was called for Friday evening, October 28, at the Hotel Astor, New York, to enable the executive committee to submit for approval several amendments to the rules. The amendments, which were unanimously approved by the members of the executive committee, refer to the measurement and power rating of boats.

A challenge for the American Power Boat Association gold cup has been made by Price McKinney, the owner of the *Standard*, through the Thousand Islands Yacht Club. The cup is now in the hands of the Chippewa Bay Club, having been won by *Vingt-et-Un II.*, owned by W. S. Kilmer, who is a member of that organization. The race will take place early next season.

* * *

The West Side Y.M.C.A. of New York has issued a prospectus giving in detail the automobile course of instruction to be given during the coming winter. Detailed information can be obtained by addressing the West Side Young Men's Christian Association, 318 West Fifty-seventh Street, New York city.

Rosedale cemetery, Orange, N. J., which has been quite a popular place for automobiling on account of its fine shaded roads, has now been closed against motor vehicles because, it is said, some chauffeurs seemed unable to remember that they were in a cemetery, and some rather harrowing encounters with funeral processions occurred. While those offending were few in number, it was thought best to exclude all automobiles rather than run the risk of further unpleasantness.

* * *

The Pope Motor Car Company is building at the Toledo factory a 90-horsepower racing car, which, according to present plans, is to be sent against the world's mile record at the Ormond-Daytona tournament in January. The machine will have a six-cylinder motor, and will be an out-and-out racing machine.

* * *

James L. Breese, the well-known New York automobilist, has put forward the suggestion that steps be taken to see if an automobile race track, of about ten miles in circumference, could be laid out on Long Island. Mr. Breese's idea also contemplated the building of a smaller track for short distance contests.

* * *

An attractively illustrated little folder has been issued by the management of The Inn, Ormond Beach, Florida, announcing the opening of that ~~hostelry~~ *on December 1*, and setting forth some of its advantages, especially from the point of view of the automobilist. Particulars may be obtained from Manager Wm. S. Kenney, who will be at The Inn after November 1. Information may also be obtained in New York city at 3 Park Place or 1216 Broadway.

* * *

W. D. Grand, the well-known New York horse auctioneer, will hold his second annual automobile auction at the American Horse Exchange, Fiftieth Street and Broadway, New York, on November 10. Mr. Grand states that he has already received several scores of entries and he expects to make these auctions a regular feature.

* * *

The Packard Motor Car Company, Detroit, Mich., has secured quarters in Long-acre Square, New York, where preparations are being made for the establishment of a very complete garage and salesroom for the Packard product. William H. Hurlbut will manage the business for New York city.

* * *

The Olds Motor Works, Detroit, Mich., contemplates opening a branch or placing a direct agency in New York city next spring, and will be open for proposals from responsible persons.

* * *

The family of Carl Mensel, the mechanic who lost his life in the Vanderbilt Cup race, has been cared for by Mr. Arents, in whose hands the matter was left, at his own request.



C. A. Duerr, of the Duerr-Ward Company, New York, has purchased F. A. Ward's interest in the concern.

The Acme Motor Car Company, of Reading, Pa., has secured the services of F. E. Moscovics as sales manager.

The Pontiac Body Company, of Pontiac, Mich., has let the contract for a one-story addition, 60 feet wide and 150 feet long, to its automobile body building plant.

The increasing business of the Lobe Pump & Machinery Company, of Buffalo, has made necessary the addition of five new automatic machines to the manufacturing plant.

The Automobile Supply Company, 1,534 Glenarm Street, Denver, Colorado, under the management of E. T. Weiant, is in the market for automobile supplies and accessories.

The Wilmington Garage Co., of Wilmington, Del., which is composed of prominent local owners of automobiles, has purchased a large building at the southwest corner of Eleventh and West streets, and will convert it into a first-class garage.

An Italian agency for American automobiles, parts and sundries has been established in Milan, Italy, by Ferrari & Company, 6 Via Ponte Seveso, who would be glad to hear from American manufacturers who desire to introduce their goods in Italy.

The Lansden Company, of Harrison, N. J., is completing twelve electric trucks for the Adams Express Company in Washington, D. C. Edison batteries will be used, and Thomas A. Edison is said to be personally supervising the installation of his batteries at the Lansden factory.

The Ford Motor Co. of Canada, Ltd., capitalized at \$125,000, has commenced the manufacture of automobiles at Walkerville, Ont. About sixty hands will be employed throughout the winter. Machines for the Canadian trade will be ready early next year.

The Hartford Rubber Works Company will move its Buffalo branch to the store which is soon to be vacated by the Geo. N. Pierce Company, and the Fisk Rubber Company will take the Main Street store formerly occupied by the Buffalo Motor Car Company.

Archibald Ford, of London, recently made a non-stop run of 2,390 miles in a 15-horsepower Darracq, finishing in the London Hippodrome, where he was given a reception by representatives of the Darracq company and presented with the car he had driven.

H. Bernard Hallam & Co. have organized in Seattle, Wash., to handle automobiles. A new building, to be finished in December, is being erected for the business at the corner of Madison avenue and Broadway, Seattle. Pending its completion the office of the concern is at 602 New York Block.

The Poppenberg Automobile Company has taken the Buffalo agency for Rambler automobiles, formerly handled by the D. H. Lewis Company. The Poppenberg Company will add the store at 670 Main Street to its present salesroom and will build a large two-story garage in the rear of the store, extending back to Pearl Street.

Thos. B. Jeffery & Company, of Kenosha, Wis., have established a Rambler branch house in Philadelphia at 242 North Broad street, with W. F. Smith, formerly traveling representative of the company in Pennsylvania, New Jersey and Delaware, in charge.

The Pope Motor Car Co. is preparing for an active campaign in Europe, which it will open by exhibiting at the Paris automobile show in December. H. H. Lyttle, who drove a 24-horsepower Pope-Toledo car in the Vanderbilt Cup race, leaves next month for Paris, where he will act as demonstrator at the automobile show.

The entire output of the Reo cars by the recently organized Reo Car Company, of Lansing, Mich., will be sold through R. A. Rainey and R. M. Owen, of New York, who are well-known in connection with the Franklin and Olds machines. It is expected that the first of the Reo cars will be exhibited at Madison Square Garden show in January next.

The Waltham Mfg. Co. will turn out a four-cylinder touring car with side entrance for the season of 1905, and also a smaller machine at a lower price in addition to its present line. The manufacturing and selling force of this concern has been reorganized. The construction department will be under the superintendence of Leo Melanowski, while C. E. Lozier is sales manager.

The vice-presidency of the Knox Automobile Company, Springfield, Mass., has been resigned by Harry A. Knox, who has held the position since the formation of the company in 1900, and he is no longer connected with the concern, having sold his interest to other stockholders. Mr. Knox will take a long vacation before again entering into active business. James H. Jones has been promoted to the position of head mechanical engineer of the Knox company.

The Western Motor Car Company, Pacific Coast agent for the Thomas Flyer, informs us that in the official races at Los Angeles, California, Thomas Flyers took first and second places in the five-mile open event for cars costing \$2,500 and less, third place in an open event which was won by a 60-horsepower racing machine, and first and second places in the ten-mile race for cars costing \$2,500 and less. The best mile made in this race was run in 1 minute and 14 seconds.

A. L. Dyke, of St. Louis, Mo., who, as already reported, has sold his interest in the A. L. Dyke Auto Supply Company and entered into a business of his own, has incorporated a company called the Original Auto Supply Company, capitalized at \$10,000. A. L. Dyke is president and Carrie J. Dyke secretary and treasurer. Work has been commenced on the company's new quarters at 4427-4431 Olive street, pending the completion of which business will be conducted at 311-Pine street.

C. S. Henshaw, Boston agent for the Thomas car, left that city last Saturday on the continuation of the long journey which is being made with the 1905 four-cylinder 40-horsepower model. He intended first to visit Worcester, where the car was to be demonstrated; Northampton, Mass.; Hartford, Conn.; Pittsfield, Mass., and then drive to Montreal, where he will hand over the car to another driver, who will take it

to several places in Canada. Thence it will go south in time to reach Florida, where the Ormond-Daytona races are run. The first 5,000 miles of the journey of the car were completed October 18, when Mr. Henshaw drove the machine into Boston from New Bedford. He took it in charge in New York, after Mr. Thomas had driven it from Buffalo to Philadelphia and Washington, and drove it through the principal cities of southern New England.

The annual meeting of the Diamond Rubber Company, at Akron, O., resulted in the election of the following officers: President, F. A. Hardy; vice-president and general superintendent, A. H. Marks; secretary, W. B. Miller; treasurer, A. H. Noah. These officers, with O. C. Barber, J. K. Robinson and R. C. Lake of Chicago, constitute the board of directors. Mr. Lake takes the place of W. B. Hardy, now residing in London, and is the only new member of the directorate. The company reports a profitable year's business, and will erect a new office building this fall.

All of the large automobile manufacturing concerns in Buffalo are locating in one part of the business section, and as soon as the George N. Pierce Company occupies its new building, next door to the Teck Theatre building, near Main and Edward streets, the centralization will be complete. The automobile stores have been moving uptown, until now they are nearly all only a stone's throw from one another. The Pierce company's new building is a handsome structure, three stories high, and will have every modern facility known to the automobile world. It will have one of the largest garages in the western part of the state.

The manufacturers of the Jones speedometer call attention to the fact that several recent cases of alleged illegal speeding by automobilists have been decided in favor of the defendants on the strength of the testimony of the speedometer. The latest case was that of Miss Eloise Breese, a sister of the well-known automobilist, James L. Breese. The policeman who preferred the charge against Miss Breese is said to have timed the car with a stop watch; but the court accepted the speed indicated by the speedometer, with which the automobile was equipped, as being more probably correct, and dismissed the case.

The Cook & Stoddard Co., of Washington, D. C., has been incorporated with a capital stock of \$15,000. The officers are: J. M. Stoddard, president; E. R. Alexander, vice-president; R. W. Cook, secretary and treasurer. Mr. Cook was a member of the firm of Cook & Owessney, recently dissolved, and Mr. Alexander was formerly manager of the Baker Motor Vehicle Agency, which has been absorbed by the new firm. In addition to having a strong selling line, including the Winton, Cadillac, Baker electric, White and Stevens-Duryea, the new firm will do an extensive repair and storage business. It has secured the large garage at 1028 Connecticut avenue, formerly occupied by the local branch of the Locomobile Co. of America, and should be an important factor in Washington trade. Mr. Metzger, of the Cadillac Automobile Co., who was in the capital last week, transferred the Cadillac agency to the new firm.

THE AUTOMOBILE

WEEKLY

NEW YORK—SATURDAY, NOVEMBER 5, 1904—CHICAGO

10 CENTS

TREND OF THE GERMAN AUTO INDUSTRY.

Exhibition at Leipzig Shows Many Copies of American Runabouts—Friction Drive Experimented with Also—Mercedes Factory Trying to Eliminate Change Speed Gears and Will Build Low-Priced Cars.

From Our Own Correspondent.

BERLIN, Oct. 22.—Only a short time ago German sportsmen and manufacturers looked down with sovereign superiority on the American automobile industry. Conditions are now different. In the past Germany has built dear but very good machines, modeled on French types, but later machines after the Mercedes pattern. More recently, however, the market for such costly machines seems to be a little exhausted and manufacturers are attempting to increase sales by building very inexpensive light cars. Those especially who have not large funds are doing so, forgetting that very great capital is the first consideration for successful low-priced mass-manufacturing. They think their success guaranteed after having copied the Oldsmobile type, more or less extensively, and, indeed, some of these imitations are very good ones.

So we find in the exhibition at Leipzig a great series of similar cars, with horizontal single cylinder motors of 4 inches and more bore and 5 to 6 inches stroke and with planetary change speed gear, with only two modifications of speed and reversing. The Oldsmobile type itself is, of course, also exhibited; especially a small racing car after this type which attracted much interest.

Another very remarkable item also con-

nected to the efforts to build cheaply is the frequent use of the friction change speed gear; not less than four factories exhibiting in all more than fifteen cars of the kind. Besides, it will be interesting for American readers to know also that the Daimler-Motoren Gesellschaft in Unterturkheim has lately made some trials with the friction change speed drive, using this gear

transmitted by one or two chains on the rear axle. As the movement of the second disc across the face of the first allows all modifications of speed whatever, the arrangement seems to be a very simple and recommendable one.

But as these friction discs must be very large, in order to avoid rapid wear, the motor and the change speed gear must be supported very high and the car becomes easily ill-shaped in appearance. To remove this difficulty the builders of the cars shown at Leipzig located the great friction disc so low that its lower edge nearly touched the ground. This might answer for cars used in town, but so little distance between the lowest point of the machinery and the ground is not permissible for use on bad roads.

Especially one of the friction change speed gears is a remarkable one, and will perhaps solve this difficult structural question. Its discs are quite unused in the

greatest speeds, as the motor then operates on the driving wheels by a friction clutch and Cardan jointed shaft. This arrangement avoids the loss of power in high speeds.

NEW MERCEDES CONSTRUCTIONS.

Mercedes.—These well-known and famous works have exhibited a touring car and a chassis, both type 1904. The novelties

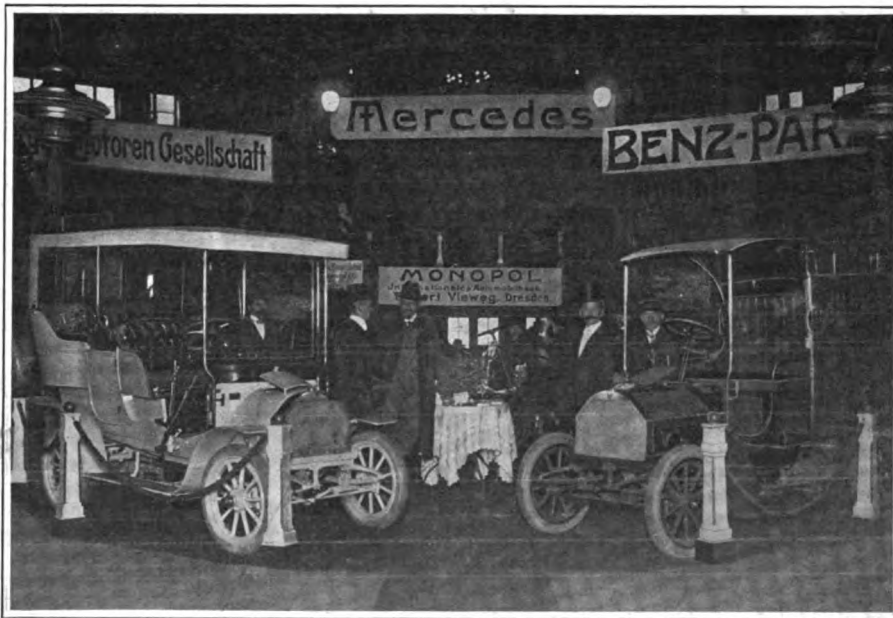

MERCEDES AND BENZ-PARSIFAL CARS EXHIBITED AT LEIPZIG, GERMANY, OCTOBER 14-25.

experimentally for lorries. These experiments of the Mercedes concern, however, had no satisfying results. The friction change speed gears in the exhibition at Leipzig are all built after one model, that is, the motor drives a great disc, serving as a fly wheel, on which another disc is pressed, which is fitted slidable on its shaft, and from this gear the motion is

will first come out in the Paris Salon, for the Daimler works sell a great deal more of their costly cars to France, America and England than to Germany, where people who are open to spend so enormous a sum for a single car are very seldom. Knowing well this circumstance these works are understood to be also about building low priced light cars. As the competition in this line is now very considerable, this is not very pleasant news for the French and German automobile industries. It is of much interest also that for these light cars side chains (not live axle) shall be used.

But the very last novelty of Mercedes projects is a car without change speed gears at all; but this is yet remote. Instead of replacing the change speed gear by using eight cylinders, as French and American builders have tried sometimes, the Daimler engineers intend rather a combination of the usual gasoline motor and steam engine, an idea which is not new, but becomes interesting by this great factory's intention. Its designers intend to heat the boiler by the exhausting gases of the motor, using therefore fire tubes which pass through the boiler. Thus would entirely vanish the exhausting noise, as the gasoline motor gases cool very rapidly on the tube walls contained in the boiler.

In operation it is only necessary to set at work the motor some minutes before starting, which in this little time produces steam enough to assist the motor when going. During the course of travel a sufficient quantity of steam is generated to get over nearly all gradients. If one of them should be too steep, the car is stopped and the motor allowed to go alone for a short time to obtain the necessary quantity of steam. In regular road travel, the exhaust serves sufficiently to keep plenty of steam for use on grades.

This system would be a little complicated, indeed, but would have all advantages of a steam and explosion motor. Only in starting is it necessary to turn over the

motor cylinder/by hand, and for a whole day thereafter the motor would start automatically, controlled by a little lever. The water consumption is a very trifle, because steam is only wanted for starting and for hill climbs. No change speed gear at all is employed.

To be sure, it is yet far from the time that this construction has demonstrated sufficient reliability to allow such a great factory and one of so high reputation to go on the market with it. But there is no



TIRE PROTECTOR AND ANTI-SKID.

hurry at all. The works are understood to be very much occupied, having to effect orders for about \$9,000,000. The great factory in Unterturkheim is in the condition to finish ninety great cars monthly. That is more than 1,000 cars in the year, which represent a value of about \$5,000,000, as only very costly cars are built. But more remarkable than this great sum is the circumstance that the works profited nearly nothing the last year, and its branch in Marienfelde had even some loss, as is plain to be seen in the last financial report.

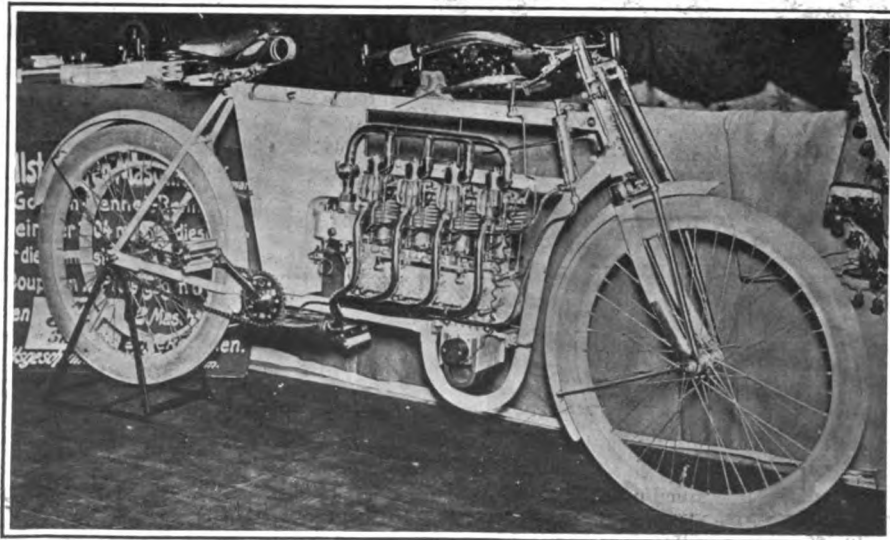

FOUR-CYLINDER 12-H.P. RACING MOTORCYCLE, BUILT BY LAURIN & CLEMENT.



GERMAN 8-H.P. RACING MOTORCYCLE.

Other types are exhibited by the Benz Co., De Dietrich, Argusmotoren Gesellschaft, Otto Weiss & Co., E. Nacke, Renault Frères, and a great many other factories. The greatest interest was paid, of course, to the De Dietrich celebrated racing car, which, driven by Rougier, competed honorably in the French trials, and in the Gordon Bennett cup race, and in the race on the steep Mont Ventoux.

The Benz cars represent themselves very well indeed, especially their bodies, which are built after the best French types, and are very roomy and, nevertheless, very fine and pretty. All cars of this firm and of the firms of distinction are built in the limousine and landaulet types. The Argus cars are copied after the Mercedes type and very well finished indeed. This imitation is no reproach, for all copy to-day. Otto Weiss & Co. have built doubtless the most elegant cab of the exhibition; also the cabs of E. Nacke are very good.

The building of cabs is actually very much followed. Ten German works at least took up the construction of cabs with motors, and in Berlin, Cologne and Hamburg many of such cabs are already used.

MOTOR CYCLES ON EXHIBITION.

The two most interesting motorcycles of the exhibition in Leipzig were the racing motorcycle built by Laurin & Clément with four vertical cylinders, and the motorcycle of the Express Fahrradwerke, with two inclined cylinders. The motorcycle built by Laurin & Clément makes no overloaded appearance with its four cylinders, and, although these cylinders are arranged one after the other, and, therefore, are not cooled very well, the motorcycle has a very good speed. As shown in the photograph, the motion is transmitted by bevel pinions. The two-cylinder Express-Motorcycle is remarkable by reason of its frame. These numerous connections between the frame-tubes make the cycle very solid, but too expensive for touring purposes.

Besides these two types, a great number of single cylinder motorcycles are exhibited. One of them, with a motor furnished with clutch planetary change speed gear. Power is transmitted by bevel pinions.

Tires are not well represented at the exhibition. The most attractive object is a new protector from Albers. The accompanying photograph shows the different shapes of it. The leather jacket fastened on so many places can never fly off. Slide-slip is prevented by steel points, steel rivets or plates, which are riveted on the leather.

World's Records in Special Race at Yonkers.

Oldfield Wins Ten-Mile Match Against Théry, Bernin and Sartori in 9:12 3-5.—Kulick's New Records.

BARNEY OLDFIELD recovered his lost nerve in time to win the four-cornered 10-mile match race at the Empire track, Yonkers, N. Y., on Saturday, October 29, and at the same time he made new world's records for five miles with standing start in his trial heat, in which he had Bernin as an opponent in W. G. Brokaw's 60-horsepower Renault, and for ten miles in the final heat against Sartori in A. G. Vanderbilt's 90-horsepower F.I.A.T. New track figures for five miles for the light and middle weight classes, 551 to 881 pounds and 881 to 1,432 pounds, respectively, were established in the first event of the day by the 20-h.p. Ford racer driven by F. Kulick.

No accidents or breakdowns of any kind marred the afternoon's sport, and, though the programme was short, it was of a character which sustained interest from beginning to end. The track showed the effects of a thorough grooming, being in unusually good condition, and the weather, though somewhat cool, was ideal for racing. There

horsepower Richard-Brasier car, with which he won the Gordon Bennett cup; Bernin, in W. Gould Brokaw's 60-horsepower Renault racer; Sartori, in A. G. Vanderbilt's 90-horsepower F.I.A.T., and Barney Oldfield in the 60-horsepower Peerless *Green Dragon*, would be run in two trial heats and a final, with standing starts, the distance being 10 miles in each case.

Théry and Sartori contested the first heat. Sartori drew the pole, and on the crack of the pistol jumped into the lead, gathered headway more rapidly than Théry, and gradually increased his advantage throughout the heat, winning handily in 9 min. 45.4-5 secs., Théry finishing 14 1-5 secs. later. This was the slowest heat of the match.

Théry's track work was watched with much interest by the spectators, who were curious to see how the Frenchman would fare in his first track competition. Probably the most notable feature of his driving was the manner in which he took the turns. Like Charles Schmidt in the Packard *Gray*

heat, and great driving was anticipated. Oldfield took the pole. The *Green Dragon* was expected to get decidedly the worst of the start, owing to her having but two speeds, but a muffled roar of surprise went up when, at the pistol, Oldfield, who had his machine pushed off, forged ahead rapidly, Bernin, who declined a push, making a poor start, and thus losing what would have been a decided advantage.

Oldfield set a terrific pace and kept increasing his lead to the end, finishing in 9 minutes 20 seconds, Bernin's time being 9 minutes 44.4-5 seconds. After the sixth mile it was announced that Oldfield had broken the world's track record from 1 to 5 miles with standing start.

There was an intermission of 20 minutes before the final was called, and Sartori and Oldfield came to the line, the Italian at the pole. Like the two preliminary heats, the final was a foregone conclusion, barring accidents, after the cars were well under way.

Oldfield got a little the worst of the start this time, but overtook the Italian before the first half mile had been covered, and, going like the wind, steadily widened the gap until at the finish there was a difference of 27 1-5 seconds between the racers. Oldfield's time was 9 minutes 12.3-5 sec-

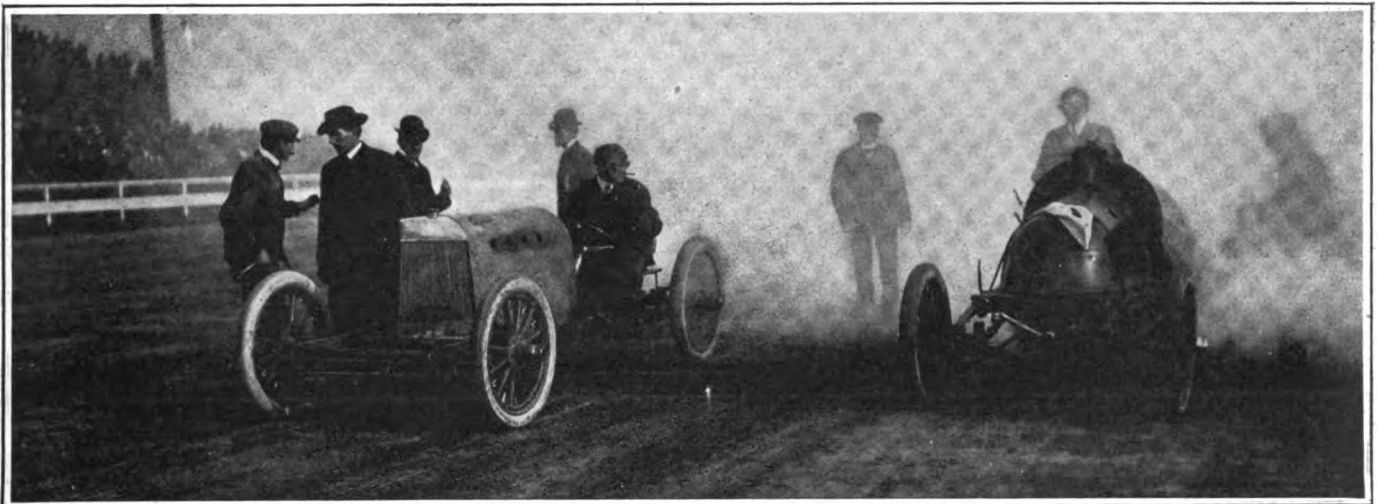

OLDFIELD IN PEERLESS "GREEN DRAGON," AT LEFT, AND BERNIN IN RENAULT, AT RIGHT, AT STARTING LINE IN TRIAL HEAT.

was very little dust on the turns, and no wind. The attendance was about 5,000.

The first event was a five-mile exhibition by the Ford skeleton, and Kulick started in with a rush that kept the spectators, who had prepared for a mild "filler" as a preliminary, in a state of excitement throughout the trial. The first mile was spun off, with flying start, in 59 seconds flat, a new figure for the light and medium weight classes, and every succeeding announcement made by Prunty, the Megaphone Man, was followed by the brief statement: "World's record."

Kulick's machine ran with the utmost regularity and was faultlessly driven. The crowd cheered heartily when the new record, 4 minutes 43 3-5 seconds, was announced. The best previous times for the mile and five miles were 59 4-5 seconds and 5 minutes 1 second, respectively.

A five-mile exhibition by the 25-horsepower Standard racer, driven by Phil Adams, followed, but the car failed to do better than 1 minute 12 3-5 seconds for the first mile and 5 minutes 56 2-5 seconds for the five miles, which seemed tame after the snappy work of the Ford car.

Announcement was then made that the match race between Théry, driving the 80-

Wolf in the Vanderbilt Cup race, he seemed to do a great deal of skidding before striking the sharpest part of the turns, and he frequently made the more excitable occupants of the grandstand hold their breath when his rear wheels slid out and left the car pointing toward the fence. On the straights and at the corners he kept his front axle just about 18 inches from the fence, all the way around.

He certainly made a splendid display of skill and nerve, and looking at his driving one could easily figure why he had won the Gordon Bennett. When he came in after the heat it was seen that nearly all the tread on the tire of his right front wheel was ground away, leaving the fabric exposed and giving him two front wheels of practically unequal diameters. On the corners, after his rear wheels had skidded so that the car was momentarily pointed for the fence, he straightened up with apparent ease, though the skidding cost him some time in each round. He had had the racer out of the Custom's House only two days, and it had not been properly tuned up for track racing. The sprockets were not just the correct diameter for one thing.

Oldfield and his conqueror at Brighton Beach, Bernin, were paired in the second

onds, and the driver of the pea-green car was given an uproarious cheering when it was announced that he had made a new world's record by two-fifths of a second.

This ended the racing for the day. The pursuit race, in which Théry and Bernin were to have engaged, was called off. Endeavors were unsuccessfully made to get Oldfield to go after the mile record, and the Ford to go after figures up to 10 miles.

Sartori complained after the race that he had been forced to run on his third speed all the time, never having been able to get in his fourth. He expressed an intense desire to meet Oldfield on the road for a race at any distance. Sartori got into trouble in driving his big car home, being arrested for speeding; but on explaining that owing to the high gear he was compelled to run fast for a little distance, and then let the car coast, he was discharged.

Following are the summaries:
 Five mile exhibition by 20-horsepower Ford, driven by Frank Kulick.

Miles.	Time, M. S.
1.....	0:59
2.....	1:56 2-5
3.....	2:53 1-5
4.....	3:48 2-5
5.....	4:43 4-5

Blackpool Mile and Kilometer Trials.

Special Correspondence.

Five mile exhibition by 25-horsepower Standard, driven by Phil. Adams. Miles.

	Time.
	M. S.
1.....	1:12 3-5

Intermediate times not announced.

5.....	5:56 2-5
--------	----------

Special match race, 10 miles; first heat; starters, Théry and Sartori.

Miles.	Sartori.	Théry.
1.....	1:09 3-5	1:10 4-5
2.....	2:08 1-5	2:10 1-5
3.....	3:05 4-5	3:09
4.....	4:03	4:07 4-5
5.....	5:00	5:06 2-5
6.....	5:56 2-5	6:05
7.....	6:53 2-5	7:03 2-5
8.....	7:50 2-5	8:02
9.....	8:47 4-5	9:01
10.....	9:45 4-5	10:00

Special match race, 10 miles; second heat; starters, Oldfield and Bernin.

Miles.	Oldfield.	Bernin.
1.....	1:06	1:11 2-5
2.....	1:59 2-5	2:10 1-5
3.....	2:52 2-5	3:07
4.....	3:46 2-5	4:03 2-5
5.....	4:41	5:00 2-5
6.....	5:35	5:57 3-5
7.....	6:31 2-5	6:54 4-5
8.....	7:28 3-5	7:51 3-5
9.....	8:25 3-5	8:48
10.....	9:20	9:44 4-5

Special match race, 10 miles; final heat; starters, Oldfield and Sartori.

Miles.	Oldfield.	Sartori.
1.....	1:05 3-5	1:08 2-5
2.....	1:59 1-5	2:05
3.....	2:53 3-5	3:01 1-5
4.....	3:47 3-5	3:58 2-5
5.....	4:42	4:55
6.....	5:36 3-5	5:51
7.....	6:31 2-5	6:47
8.....	7:25 2-5	7:44
9.....	8:19 1-5	8:42
10.....	9:12 3-5	9:39 4-5

A trial of mechanically driven transport wagons was held near Paris during the first week of last month by the French military authorities. During eight successive days the wagons were required to cover a distance of 510 kilometers (316 miles) and various tests were applied. The War Office announced that the first three prize winners would be bought by the government, but only three of the ten wagons entered appeared for the test. Builders complain that not sufficient notice was given them to finish their vehicles in time

LIVERPOOL, Eng., Oct. 18.—Two days' straightaway speed trials were run off on Friday and Saturday, October 14 and 15, on the smooth white asphalt boulevard along the shore at Blackpool, the well-known seaside resort. The 250 entries were divided into nine classes, mainly on the

light cars, then the touring cars, and finally the racing machines. The first day, T. Tessier, on a 4 1-2-horsepower Bat motorcycle, won in the class for cycles weighing less than 170 pounds, covering the mile with standing start in 1:13 2-5, or at the rate of forty-nine miles an hour, and in the

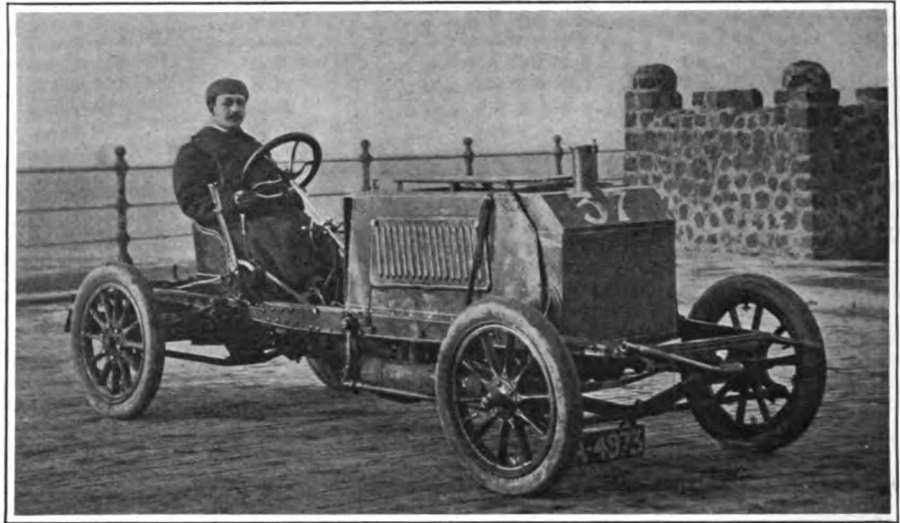

CLIFFORD EARP IN 80-HORSEPOWER NAPIER, HOLDER ENGLISH KILOMETER RECORD.

basis of selling price. There were two classes for motorcycles, five for touring cars and two for racing cars. To give variety to the racing, Friday's events were run over a mile course, with standing start, while on Saturday the flying kilometer was essayed by all.

A crowd estimated at between 60,000 and 80,000 lined the course on either side. The course was roped off and patrolled by policemen, who kept it clear. The spectators were kept informed of the results of the events in an ingenious way. The trials were run in heats of two competitors each, one of the competitors wearing a blue sash and the other a white sash. After each pair crossed the finish line a blue or white flag was raised, according to the color of the winner, and similar flags were hoisted on poles along the whole length of the course.

TESSIER FASTEST ON A MOTORCYCLE.

Each day's racing opened with the motorcycle events, followed by trials of the

second class, for machines of any weight, won with the same machine in 1:15.

There were thirteen starters in the class for touring cars costing £250 (\$1,250) or less, and they were sent off in pairs. A 10-horsepower Duryea was first in the final, in 1:49 2-5, but was afterward disqualified, on the ground that the selling price was more than £250, so that first place was given to a 10-horsepower Speedwell, and second place to an 8-horsepower Cadillac.

DARRACQS WIN IN TWO CLASSES.

Of the seventeen cars that ran in the class with a price limit of £500 (\$2,500), a surprising number were 15-horsepower Darracqs, which seemed to be very popular vehicles. The final was won by F. Noar, on one of these French machines, which covered the mile in 1:36 3-5.

A 30-horsepower Darracq made the best time (1:34) in the class for cars selling for not more than £750 (\$3,750), and carrying four passengers and a 20-horsepower

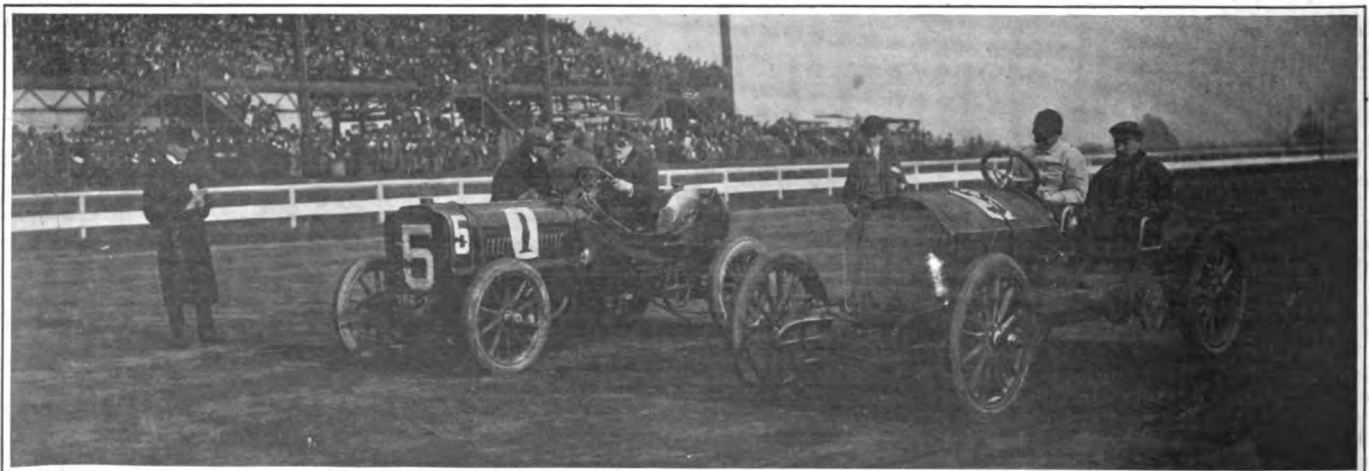

THEYRY IN RICHARD-BRASIER, AT LEFT, AND SARTORI IN F. I. A. T., AT RIGHT, STARTING IN FIRST HEAT OF YONKERS RACE.

Some exciting racing was seen in the class for cars costing up to £1,000 (\$5,000), the fastest heat being that in which a 28-horsepower Daimler beat a 24-horsepower Bollée in 1:09. As this was from a standing start, it is clear that the Daimler is capable of a speed of nearly, if not quite sixty miles an hour—not bad for a genuine touring car.

DOROTHY LEVITT WINS HER HEAT.

In another heat Miss Dorothy Levitt gained a victory in her 20-horsepower Napier (English) over an 18-22-horsepower Mercedes (German) in 1:30 3-5. But in the final she was just beaten at the finish by a 40-horsepower Bollée in 1:21 3-5. The Daimler was unable to run in the final owing to a broken pump.

Even greater interest was excited when the heats started in the class for cars of any price. A 65-horsepower Napier and a 70-horsepower Wolseley (both English) were disqualified on the ground that they were not *bona fide* touring cars, being, in fact, racers with light tonneau hung on the rear. The competing cars included five 60-horsepower Mercedes cars, a 60-horsepower F. I. A. T. (Italian), a 40-horsepower C. G. V. (French), a 45-horsepower Bollée (French) and many others. Great interest was shown in the heat between Miss D. Hampson's 60-horsepower Mercedes, driven by herself, and Mr. Walker's Mercedes of the same power. Owing to a broken gear, Miss Hampson was beaten by twenty yards.

In the final, L. Williamson, in a 60-horsepower Mercedes, beat Mr. Dew's 40-horsepower Bollée by about 200 yards in 1:15.

RACING CARS RUN IN THE DARK.

The racing cars were sent off singly, although the course was sufficiently wide to allow them to run in pairs. Evening was coming on, and in the gathering dusk the racers dared not let their machines out at full speed; hence comparatively poor times were recorded. G. Higginbotham, on a 96-horsepower Wolseley, covered the mile in 56 seconds, equal to a speed of 64 1-2 miles an hour. A. Fletcher drove his 90-horsepower Mercedes over the course in 57 seconds, while Hon. C. S. Rolls, on a 100-horsepower Mors, and Mr. Rawlinson, on a 100-horsepower British built Darracq, both attained a speed of sixty miles an hour. The final was a keen struggle between the two Wolseleys, Mr. Higginbotham winning in 0:58 3-5, or at a speed of 61.43 miles an hour.

ALL-DAY SPORT ON SATURDAY.

Saturday's racing was started at 9:30 A. M. to avoid having to finish the trials in the dark. Tessier, on his 4 1-2-horsepower Bat, was again victorious in both motorcycle classes, his times for the flying kilometer being 36 3-5 and 35 3-5 seconds, respectively, the latter being equivalent to a speed of 63 miles an hour. In all four motorcycle events, J. Crundall, on a 4-horsepower Humber, came in second.

In the classes for touring cars the competitors were despatched in a continuous stream, no heats being run, but the fastest in each class adjudged the winner. In the class for cars under £250, the 10-horsepower Speedwell and 8-horsepower Cadillac took first and second places, their speeds being equal to 36 and 35 miles an hour, respectively. In the class for cars under £500, the first three places were taken by 15-horsepower Darracqs, the speeds being 45.43 and 42 miles an hour. A 20-horsepower Winton was fourth, with a speed of 41 miles an hour.

The next event was a competition, open only to Darracq cars, for a magnificent challenge cup presented by the Darracq company. It was run over the standing mile

in classes according to horsepower, the winners of the classes running together in a handicap for the final. Four 12-horsepower, six 15-horsepower and two 30-horsepower Darracqs competed. H. Kennedy's 12-horsepower car was first, in 1:43, with Mr. Walker's 30-horsepower car second.

Several private matches were then run off, the first being between a 12-horsepower Lanchester and a 60-horsepower Mercedes, the former having one minute start in the mile. The Mercedes was beaten by about ten yards. In another match, Mr. Instone's 28-horsepower Daimler beat a 24-horsepower De Dietrich, the latter having 10 seconds start.

Fourteen competitors started in the class for cars costing under £750. Mr. Walker's 30-horsepower Darracq was first, in 0:45 4-5, with a 20-horsepower car of the same make second, in 0:47 4-5. Ten competitors ran in heats in the class with a price limit of £1,200, and in the final, as on the previous day, Miss Levitt's 20-horsepower Napier was just beaten by the 40-horsepower Bollée in 0:40 3-5. A 19-horsepower Mors was third, in 0:44 3-5.

The class for touring cars of any price was won by L. Williamson, whose 60-horsepower Mercedes covered the kilometer in

to enabling attempts to be made to break the world's record of 103 miles an hour, held by Rigolly, with the Gobron-Brillée.

INVESTIGATING KISER'S RECORD.

Special Correspondence.

CLEVELAND, Oct. 31.—The racing board of the American Automobile Association has been making an investigation to ascertain if the mile Earl Kiser is credited with having made at Glenville, August 22, in 52 4-5 seconds, may properly be classed as official. This time was made in the last mile of the special five-mile race for eight-cylinder cars. The fact which led to the investigation is that the times for the miles are remarkably irregular. The times for the successive miles were: 1:04 4-5, 0:54 4-5, 0:56 1-5, 1:03 1-5 and 0:52 4-5.

There were four timers in this race—J. H. Collister, P. Hussey, Charles E. Weaver, of Cleveland, and Ned Broadwell, of Detroit. All of these men are experienced timers of bicycles and automobile events and their work has never been questioned. At the time there was a slight controversy over the time of this mile. One of the timers caught the fourth mile considerably faster than was announced, although all of the



HON. C. S. ROLLS, IN 100-H.P. MORS AT BLACKPOOL TRIALS, ENGLAND.

33 2-5 seconds, equal to a speed of 67 miles an hour—excellent time for a touring car. Mr. Cordingly's 60-horsepower Mercedes was second, and a 36-horsepower Spyker third.

ENGLISH KILOMETER RECORD BROKEN.

Finally, the racing cars made an attempt on the English kilometer record, which was held by the Hon. C. S. Rolls, whose 100-horsepower Mors had reached a speed of 83.7 miles an hour at Welbeck early in 1903. Each car made three attempts, and in nearly every case the first attempt proved fastest. The following were the speeds attained:

Driver.	H.P.	Car.	Miles per hour.		
			I.	II.	III.
Clifford Earp	80	Napier	84.68	82.80	80.4
A. Fletcher	90	Mercedes	79.27	69.3
A. Callan	96	Wolseley	67.7	63.5
G. Higginbotham	96	Wolseley	77
Hon. C. S. Rolls	100	Mors	46.5	54.2	84.3
A. Rawlinson	100	Darracq	82.40	80.4	82.8

It will be seen that both Mr. Earp and Mr. Rolls broke the English record.

At the time of writing, the Blackpool Corporation considers the meet has been so successful that in a few weeks it intends to hold a special racing car meet, with a view

timers agreed on the time for five miles. If a mistake was made on the fourth mile, this, of course, would destroy the record, but as three of the timers agreed, there was no hesitation about announcing the time. Neither the referee nor the starter was in the stand when the timing was done.

"DENNIS McGRATH, AUTOCRAT."

Edward Porter is the author of a small book under the title "Dennis McGrath, Autocrat, and Other Horseless Tales Hanging Thereby." Evidently he is not an Irishman, for the spontaneous humor that one is led by the title to expect does not scintillate in the small volume, which is published by Herbert B. Turner & Co., of Boston. The narrative, if such it may by grace be called, seems, after a perusal of the first half-dozen chapters, to be written around several automobiles for the purpose of attracting purchasers, as it is pointless and minus a plot, and displays a lack of familiarity with automobiles. However, since the author in the "foreword" quotes as follows: "The best thing to kill the blue-devils and to brace a fellow up is a little business-like idiocy," the reader ought, perhaps, to take the hodge-podge at the author's own valuation and seek only the most superficial amusement in the volume, or suspend judgment altogether.

"XPDNC" Wins the Hudson River Race.

Maintains an Average Rate of Speed of 22.86 Knots—"Vingt-et-Un II" is Handicapped by Motor Troubles.

THE long-distance race of auto-boats from New York to Poughkeepsie and return, on Saturday, October 29 last, proved a success, as two out of the three starters covered the course in good condition and at high speed, the winner, *XPDNC*, showing an average of 22.86 knots for a continuous run of 118.60 nautical miles.

The first proposal for a private match between *Challenger* and *XPDNC* was amended to a sweepstakes of \$500 a side, with the expectation that several other auto-boats, in particular the new *Ontario*, would enter; the only one to do so, however, was *Vingt-et-Un II*, steered by her designer, C. H. Crane.

The course was from off the Columbia Yacht Club station, West Eighty-sixth street, New York, around a tugboat anchored 1,500 feet below the railway bridge at Poughkeepsie, a distance of 68.30 statute miles, or a total of 136.60. The starting arrangements were in the hands of President W. H. Ketcham, of the American Power Boat Association and the Columbia Yacht Club, while the boats were measured



FRANK CROKER IN BOATING COSTUME.

by J. H. McIntosh, of the same club. The entries were as follows:

	Helmsman.	Rating.
<i>Challenger</i>	A. D. Proctor Smith.	88.35
<i>XPDNC</i>	Frank Croker.....	79.70
<i>Vingt-et-Un II</i> .	Clinton H. Crane....	79.35

The morning was clear and sunny—warm for the end of October—and with a very light southerly breeze. The start was set for 10 a.m., about an hour before high water at Eighty-sixth street; the tide turning at Poughkeepsie nearly four hours later. The river was smooth and the conditions all that could be asked. The *Challenger* was at the club float a little after 9 o'clock, and everything was in readiness for the start before the appointed hour, a number of yachtsmen, including Commodore H. B. Moore, Atlantic Yacht Club; H. J. Gielow, F. B. Herreshoff, C. L. Seabury, Messrs. Mabley and Bunting and Mr. Curtis, the inventor of the Curtis turbine, being present.

All eyes were turned up the river in a tedious wait for *XPDNC* and *Vingt-et-Un II*, they being reported by telephone as having started at the same time from Smith & Mabley's launch works, at Astoria. It was not until 11:15 a.m. that *Vingt-et-Un II* arrived, reporting that the other was apparently ready, when she started. After the patience of the officials and spectators was pretty well exhausted the Croker launch was sighted up the river, and at about five minutes before noon she swung into the float. The other two were ready, and Mr. Ketcham asked Mr. Croker whether he would be ready to start at 12:05 o'clock, receiving an affirmative reply.

The preparatory gun was fired promptly at noon, and all hands started to get under way. In the effort to turn the motor, the starting bar of *Vingt-et-Un II* was broken, and one of her crew made a mis-step into

the electrical wiring, breaking all the connections. A spare starting bar was secured, but it was necessary to make all the connections anew, with no time for perfect adjustment.

Mr. Croker, who was accompanied by a mechanic and a friend, spent a few minutes in the final preparations, the motor was cranked, starting promptly, and as the gun was fired the launch was pushed off from the float, the clutch thrown in, and she crossed the line with but 20 seconds' loss, picking up speed very fast. The *Challenger* was less fortunate, being slow in starting her motor and losing some time when out in the stream, finally crossing two minutes astern of *XPDNC*; she soon attained a racing speed, and when she was lost to sight she seemed to be holding her own with the leader. A full quarter of an hour later *Vingt-et-Un II* started with 11 minutes 25 seconds handicap.

The Croker launch was fitted with tank capacity for the full run, but it was a question whether *Challenger* could cover the first half of the course without a stop, while *Vingt-et-Un II* could carry only enough gasoline to run to Highland Falls, where a supply boat was stationed in advance. On *Challenger* two tanks are used, the gasoline being under pressure, and it is possible to run four cylinders from one tank, while the other tank, supplying the remaining four cylinders, is being filled.

The boats ran well, making good time, though it was impossible to judge of the relative gains and losses as they passed the intermediate points. Off Haverstraw, *Challenger* struck a floating log and damaged her propeller, so that she was compelled to withdraw. The stop for gasoline delayed *Vingt-et-Un II*, so that no fair comparison of her speed with that of *XPDNC* is possible.



C. H. CRANE, DESIGNER OF VINGT-ET-UN II.



A. PROCTOR SMITH ENJOYS A JOKE.

The turn was made by *XPDNC* at 2:35:50, her elapsed time being 2:30:50 for the distance of 68.30 miles, or an average speed of 27.17 statute miles. The *Vingt-et-Un II* rounded at 3:24:30, or 48 minutes 40 seconds after *XPDNC*, her elapsed time being 3:19:30 and her speed average 20:54 miles.

On the run down they had the tide with them and a light southerly wind against

Auto Boats in War.

In referring to S. F. Edge's offer to loan the British government his auto boats for naval experiments, United States Consul Halstead, Birmingham, England, quotes from published statements of Mr. Edge claiming several points of utility for auto-boats in naval warfare, and of Fred T. Jane, an author on naval matters, who takes the

rapid return made without giving the enemy a chance of retaliation. A motor boat, moreover, is practically immune from attack by a torpedo."

The counter arguments put forth by Mr. Jane are that gasoline is too dangerous for use on shipboard, and that motor boats are of too limited a radius to be able to operate without a convenient base of supplies; that the high speed gasoline motor will not stand

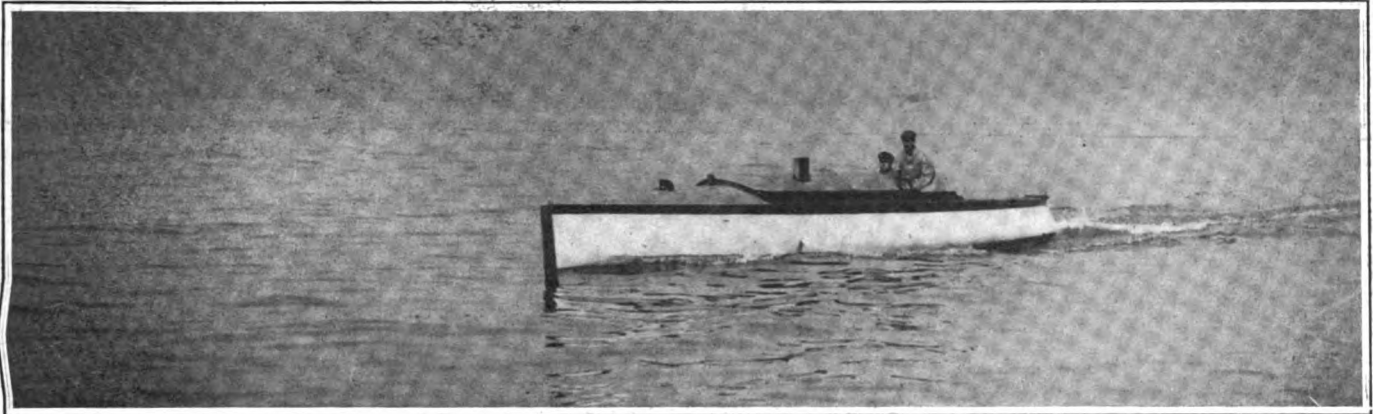

VIEW OF THE SMITH & MABLEY AUTO BOAT "VINGT-ET-UN II" GOING AT HIGH SPEED, FROM OFF THE PORT BOW.

them; the elapsed time was a little longer, but *Vingt-et-Un II* made a far better showing. The finish was timed at 5:16:50 for *XPDNC*, her elapsed time for the leg being 2:41, or an average of 25.45 miles; while *Vingt-et-Un II* was timed at 6:16, her elapsed time being 2:50:30 and her average speed 24.04 miles. The total elapsed time of *XPDNC* was 5:11:50, an average of 26.29 statute miles, and of *Vingt-et-Un II*

negative side of the question. Mr. Edge argues that the speed his boats are able to sustain—which he places at 25 miles an hour—renders them practically safe from being hit by projectiles from war vessels; that the steersman of a boat would have time, after seeing the smoke of a gun, to stop his boat or alter its course before the arrival of the shot, and so dodge disaster—though the possibility of dodging into the

the hard service and rough and ready handling and repairing it would receive on shipboard; that carbureters cannot be made to work satisfactorily in a seaway; that the huge bow wave or cloud of spray would be exceedingly easy of detection, even at night; that the auto-boat has not yet shown sufficient all-round advantage over steam launches; and finally, that the proposal to raise a corps of motor boat volunteers for



NEW HERRESHOFF AUTO BOAT "XPDNC" BUILT FOR FRANK CROKER, WINNER OF RACE TO POUGHKEEPSIE AND RETURN.

6:10, an average of 22.15 statute miles. The delay at the start, the derangement of the wiring, which could not be perfectly repaired, and the stops for gasoline combine to make a very poor showing for *Vingt-et-Un II*, and a fair comparison of the two boats is hardly possible under the circumstances. *XPDNC* ran very smoothly, with no marked variation of trim at speed, and she promises to be one of the fast boats of next season.

jaws of death does not seem to have been considered. Mr. Edge claims that the boats when in motion are almost invisible, as they lie in the hollows of the waves or are out of sight in their own tracks, and can spy upon the enemy unseen by him. He considers the motor boat the only means available for attacking submarines. "Behind a motor boat a torpedo can be trailed," Mr. Edge is reported as saying. "The submarine outside a port sighted and exploded and a

coast defense, using torpedoes, is nothing short of ridiculous, because torpedoes are only of use in the hands of skilled regulars.

"I tell you," said the man who owns two automobiles, "that the horse must go."

"Yes," replied the old-fashioned fellow, who had just stepped out of his station wagon, "I see one went for \$70,000 at an auction sale in New York the other day." —*Chicago Record-Herald*.

Ontario's Fast Mile.

The first public trial of the new auto-boat *Ontario*, owned by Commodore H. B. Moore, Atlantic Yacht Club, and described last week in *THE AUTOMOBILE*, was made on Saturday on the occasion of the New York-Poughkeepsie race. It was expected that the *Ontario* would start, but she did not do so; however, she came up the Hudson about 11 o'clock and ran by the Columbia Yacht Club later on, spurting with the racing boats as they passed up. She then came in to the club float and took on board Commodore Moore and Mr. Gielow, her designer; James Craig, Jr., the designer of the motor, being already on board. She then ran up the river and made a trial over the measured mile, beginning off Eighty-ninth street, with a very light wind and against the tide and carrying a party of passengers. She made the mile in 2 minutes 26 seconds, or at a speed of 24.65 knots. Her performance was most satisfactory, as she held her trim and left the water very cleanly.

The Cape Cart Hood.

Many merits combine to make the Cape cart hood the popular cover for automobiles that it has become this season. In the East, where thousands of large touring cars are owned this style of hood has come into such extensive use as to rival the canopy top, and some of the finest and most expensive touring cars have been fitted with them. In one of the accompanying reproductions from photographs is shown a large Napier car owned in New York and so equipped, the hood being raised and strapped at the front to the dash, though more commonly the straps are attached farther forward on the car. This is an unusually large hood, having five bows instead of the customary three. Such a hood, made of water-proofed khaki colored duck, is very light and convenient to attach and detach, affords ample protection from the sun and, with side curtains buttoned into place, keeps the inside of the car with its occupants perfectly dry in bad weather. The smaller engraving shows a Pierce Arrow car fitted with a Cape cart hood folded back for fair

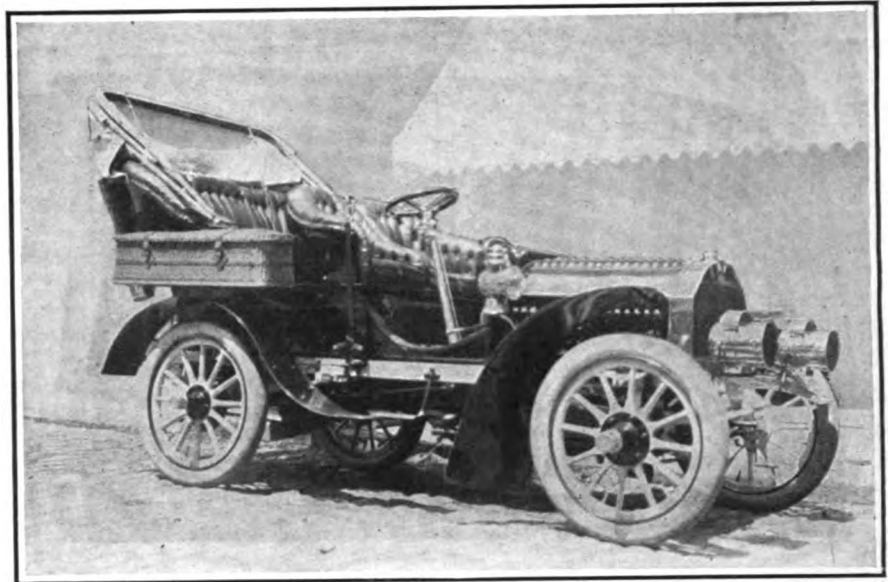

PIERCE CAR WITH CAPE CART HOOD FOLDED BACK FOR FAIR WEATHER.

weather driving. In this position the hood serves admirably as a dust protector, preventing the dust raised by the car from curling up over the back of the tonneau seats and settling on the necks, hair and clothing of the passengers. It is not necessary to raise the hood when entering or leaving the tonneau by the rear door, as the head can be inclined sufficiently to clear the cloth and bows.

Berlin International Show.

An international automobile exposition will be held in Berlin February 4 to 19, under the presidency of the Duke of Ratibor and the joint control and management of the German Automobile Club of Berlin and the Association of German Motor Vehicle Manufacturers at Cannstatt. These two organizations, writes Consul General Frank H. Mason to the Department of Commerce and Labor at Washington, comprise and represent, respectively, the varied interests of Germany in the use and manufacture of motor vehicles for purposes of sport, travel, and transportation.

The exhibition will be held in what is

known as the "Landes Ausstellung Park," near the Lehrte railway station, which incloses the large group of one-story buildings in which the annual art exposition, the "Salon" of Berlin, is held each year from May to October. Hitherto all automobile exhibitions in Berlin have suffered more or less from not only the want of adequate room under roof for the exhibits and the throngs which they brought together, but from a lack of conveniently adjacent space in which the various machines could be shown and tested in operation. So far as the first of these conditions may be concerned, the event of next February will certainly leave little or nothing to be desired. The floor space under roof is 12,000 square meters (129,168 square feet) in extent, all on the same level, with all the principal rooms lighted from above and so spacious as to fulfill every requirement in that respect. The exhibition will be divided into five general departments or sections, namely:

- (1.) Motor vehicles for the transportation of persons, also for sanitary, fire department, and military service.
- (2.) Motor wagons for transporting freight.
- (3.) Motor bicycles.

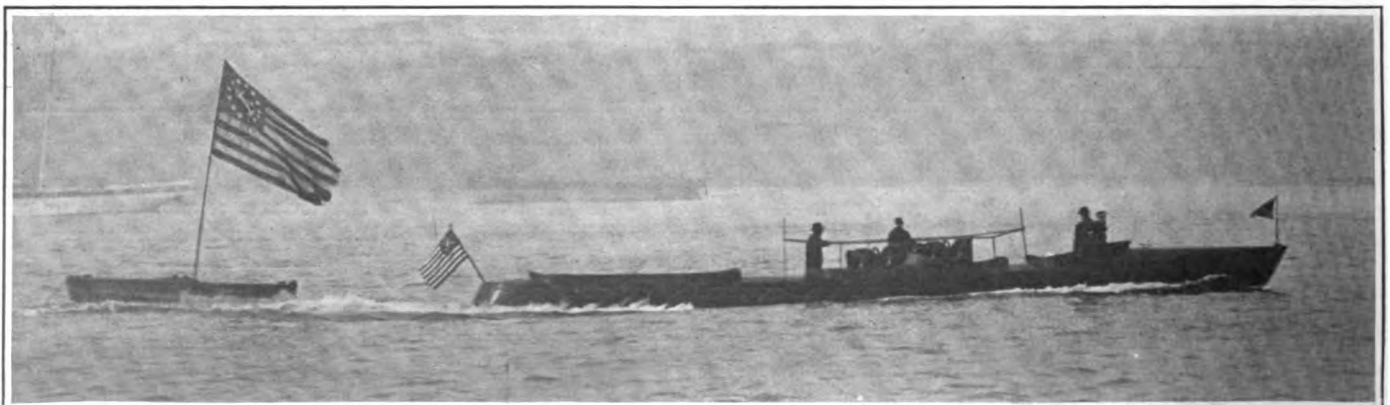

H. B. MOORE'S NEW AUTO-BOAT "ONONTIO" RUNNING A MILE IN 2:26, OR AT RATE OF 24.65 NAUTICAL MILES AN HOUR.

(4.) Motor boats, in so far as the size and conditions of the exhibition space may be adequate and adaptable to such exhibits.

(5.) Parts, belongings, and materials for motor vehicles, and tools, fixtures, clothing, drawings, maps, and literature pertaining to the use of automobiles for sport, travel and transportation.

The rent of floor space will be at the rate of 30 marks (\$7.14), and for wall space 25 marks (\$5.95) per square meter (10.764 square feet). Outside the buildings space will be charged for at the rate of 10 marks (\$2.38) per square meter (10.764 square feet). The first allotment of space will be made to exhibitors who shall have filed their applications by the end of October, so that there is every inducement in favor of immediate application by all who may intend to exhibit. Any exhibit or part thereof may be sold during the exposition, but can be removed for delivery only after the close of the display. All the details of insurance, protection to exhibits, and the rights and privileges of exhibitors are arranged on the liberal scale and with the intelligent spirit which characterizes the management of a first-class, up-to-date exhibition. Applications for space and all further information should be addressed to the managing director, Freiherr von Brandenstein, No. 4 a Sommer-Strasse, Berlin, N. W.

Here will be presented an opportunity for American manufacturers to bring their work easily and effectively before the German public; for automobiling, which began here after it had become established and popular in France, England, and the United States, has now reached a stage which makes Germany a ready market for many different

types of machines. While the fame of the Mercedes and other German-made racing and touring vehicles is world-wide, there is a distinct impression here that in respect to electric carriages for city use and the smaller vehicles of moderate price for business and recreation, American makers are still quite in advance. Some of the leading types of American-made "runabouts" are already sold here and are highly appreciated.

An international motor-vehicle exposition at Berlin always attracts a throng of interested visitors from Austria, Russia, and other neighboring countries. The exhibition of next February will be far more extensive, complete, and therefore important, than either of its predecessors, and the opportunity which it will present to manufacturers will be correspondingly timely and valuable.

Feminine Unconcern.

Bicycle Policeman Rensselaer brought a whole menagerie to Jefferson Market Police Court with him yesterday afternoon, says the *New York Sun*. There was a wild automobile and a tame bulldog—one of the old-fashioned four-poster mahogany kind—a mysterious Woman with an Ecu Mask, ditto in a Lace Hat and two quarts of diamonds, and last and least a chauffeur. He was the only non-mysterious member of the troop. He gave his name as Harry Roberts. Rensselaer said he had arrested Roberts at Eighteenth street and Sixth avenue, going eighteen miles an hour.

While the examination was in progress Lace Hat and Ecu Mask sat in a back seat, mining for sweets in a bonbon box. At first

Ecu Mask kept the birdcage arrangement close over her face and peered about the court through a little glass window. But this interfered with candy-consumption, and the edge of the mask was raised to the bridge of her nose. Nobody could identify the nose. Magistrate Hogan asked the chauffeur who was with him.

"My missus," he replied.

"What is her name?" was the next question. The chauffeur mumbled a syllable that sounded like "Burns." John Foley raised his voice seven feet in the air and shouted:

"Mrs. Burns." Ecu Mask glanced around doubtfully, consulted Lace Hat, took another bonbon out of the box, and then rose.

"What is that woman waiting for?" asked Foley, scornfully.

Then she came forward. The mahogany pup followed her gravely down to the gate, where a grim copper shut him out. The woman mounted the bridge and looked at the Magistrate sweetly under the lace edges of her bird cage.

"Do you wish to say anything, madam?" queried Magistrate Hogan, after a long silence.

"Why, yes! What shall I say?" came out of the bird cage.

"I'm sure I can't tell you," was the only help she got.

"Oh!" with a little start. "Why, of course. Our automobile can't go more than five miles an hour on a slippery pavement."

"The pavement was dry as a bone," remarked the bike cop, in a still dryer tone.

"I am sorry to be obliged to differ with you," said the woman.

"One hundred dollars bail for trial," concluded the Magistrate. Then Ecu Mask lifted her hand, which had an equal number of fingers and rings, and asked if they wouldn't please take money.

"I have \$300," she said.

"No, madam," volunteered John Foley. "You must get a man that owns property."

"Oh," she remarked again, and looked relieved. Then the two women went outside and began to fuss around the automobile. An admiring assembly of a hundred people blocked the sidewalk. After a little coaxing the wild automobile consented to go. It rolled off with the tame mahogany pup, the diamonds, Lace Hat, Ecu Mask and the bonbon box, out of the cheering crowd. Later the whole outfit came back with a man and a deed to real estate. The chauffeur was bailed out by Charles Spotswood, proprietor of the Hotel Lemartine, 12 East Thirty-first street.

An automobile passed through our town Tuesday. It was quite a curiosity for the children, and some of the older folks too.—*Maryville (Tenn.) Record*.

We forgot in our last issue to say one of those automodevils passed through here. It was a fine one, but when she struck Knowlton's plastering sand she stopped all right.—*Berlin (Wis.) Courier*.



NAPIER CAR WITH CAPE CART HOOD RAISED FOR HOT WEATHER USE.

Packard, Model N, 1905 Touring Car.

THE new Packard touring car for 1905, designated as Model N, illustrated herewith, is about ready for delivery, after a series of tests through the mountains of Pennsylvania and the sandy roads of southern Michigan. The motor of this machine is rated at 22-28-horsepower.

The frame is of pressed steel of the usual channel section, and the cross members are also of channel steel, with the open sides downward. The side members are 4 1-2 inches high in the middle, where the duty is heaviest, and 1 3-4 inches wide, tapering toward each end. Near the front the frames are bent inward to reduce the width of the frame where the motor is hung. The frames are strengthened where they are bent by being increased in width. All

and 10 spokes in the front wheels. Detachable tires 4 inches in diameter are on all wheels. The front wheels run on adjustable roller bearings, and the live rear axle, which is driven by bevel gears, runs in double ball bearings, and is provided with radius rods similar to those used on the front axle.

The spring system is of the type regularly used in the Packard cars. The two semi-elliptic springs in the rear are 49 1-4 inches long and 2 inches wide, attached to forged steel brackets on the main frames, while the front of the body is supported on a single transverse spring shackled at each end to the steering knuckles and carrying the front end of the car on its centre. The weight is thus supported close to the wheels

seats. The cam shaft, cams, rollers and lift rods are hardened and ground. The guides for the valve stems and for the lift rods are of bronze, and particularly long, to give a good bearing surface. The cam rollers are mounted on the ends of forged steel arms which extend to the opposite side of the crank case, where they are pivoted. The object of this arrangement is to retain the alignment of the cam-lifting rods.

Each piston has four rings, all of which are at the upper end. The diameter of the piston is reduced at the centre so that at this point there is no bearing on the cylinder walls, this being done to reduce friction. The forged steel connecting rods have adjustable bronze bearings at each end.

An oil pump operated by a shaft, gear-driven from the same shaft that drives the ignition current distributor, forces oil to the various frictional points of the motor, a

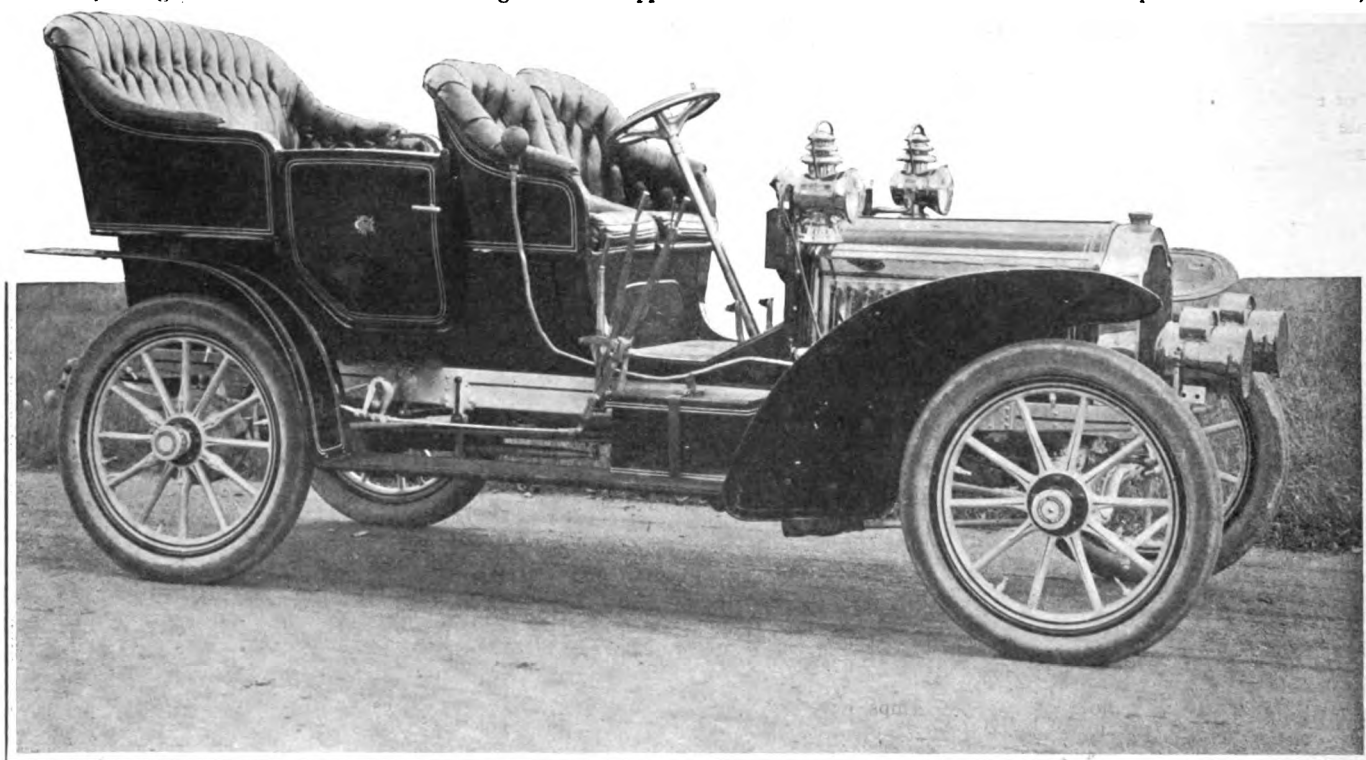

NEW 1905 MODEL N PACKARD 22-28 HORSEPOWER TOURING CAR, WITH SIDE ENTRANCE TO THE REAR SEAT.

riveted joints are reinforced with forged steel plates, those at the corners being forged in one piece with the spring hangers. There is no auxiliary frame for the motor, which is hung from six forged steel brackets, three on a side, riveted to the narrowed portion of the main frame.

The front axle is of weldless steel tubing 2 inches in diameter and 1-4 inch thickness of wall, with the steering knuckle stubs brazed into the ends. The steering pivots are long and turn in ball bearings. The joints between the pivot arms and the connecting rods are ball and socket joints, and spring cushions are provided. The axle is kept in its place at right angles to the frame by two adjustable radius rods secured to the frame.

Wheels are of wood, 34 inches in diameter, having 12 spokes in the rear wheels

and twisting strains on the frame are minimized. The motor is rated at 22-28-horsepower at 900 revolutions a minute, and has four vertical cylinders cast in pairs with the water jackets and valve housings cast integral, the water jackets extending around the valve housings. The aluminum crank case is cast in two parts, one of which may be removed for making examinations and adjustments. Six arms cast on the crank case are secured to the six brackets already referred to on the main frames.

All the valves are mechanically operated from a single cam shaft which runs along the left side of the motor inside the crank case, where it runs in oil, carried in three bronze bearings. The inlet and exhaust valves are exactly alike and are interchangeable, forged from nickel steel, and have heads of substantial thickness and broad

sight glass on the dash serving to indicate the rate of feed. The cooling system heretofore used in the Packard cars is retained unchanged.

The power transmitting mechanism has been found by the Packard Company so satisfactory during the past year that no change has been made in applying it to the new car. The drive is by bevel gears and propeller shaft, and the transmission and differential are mounted on the axle, of which they form an integral part. The rear axle has double ball bearings, and ball thrust bearings are provided wherever necessary in the driving gear. Two levers on the right hand side of the car operate the three forward speeds and reverse, and a third is used to apply the emergency brake. The clutch is conical.

The ignition is by jump spark, a double

California Tourist Cars.

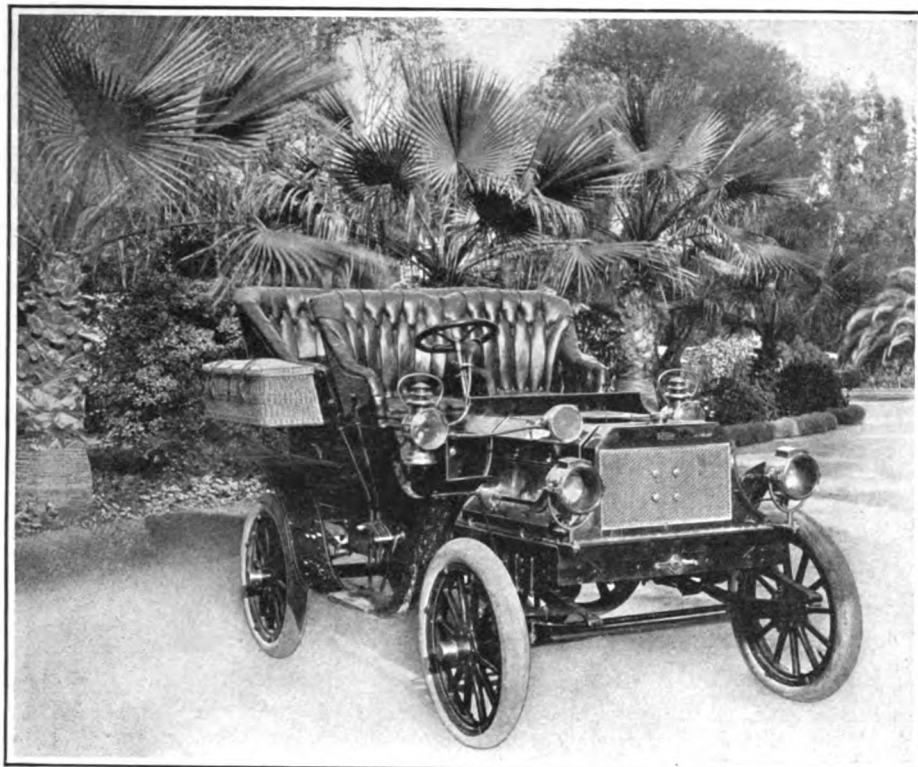

"TOURIST" CAR BUILT IN LOS ANGELES ESPECIALLY FOR CALIFORNIA ROAD CONDITIONS.

set of batteries and quadruple coil, the latter placed on the dash board, being used.

The distributor is located at the top of a vertical shaft driven from the cam shaft, and is self-contained. The distributor casing is of aluminum with fibre lining. The four brass contact bars are imbedded in the fibre and electrical connection is formed by an arm which extends from the end of the distributor driving shaft, and carries at its extremity a roller which bears against the inner surface of the fibre lining, making contact as it passes over the brass bars. The spark plugs screw into caps which close the openings over the valve chambers.

The carbureter is of the float feed type, and the mixing chamber, which is dome-shaped, is jacketed with hot water from the cooling system to provide, as nearly as possible, a uniform vaporizing temperature. The air inlet is also hot water jacketed in order to warm and dry the entering air. A regulating valve is placed in the air inlet pipe. There is also an auxiliary air inlet, acting automatically, to allow the ingress of a sufficient quantity of air to meet the demands of the motor when the speed is increased. A throttle is operated by a lever on the top of the steering wheel, and the same throttle is in connection with a centrifugal governor. The accelerator throws the governor out of engagement with the throttle and permits the latter to be opened to its widest limit.

The braking arrangements are calculated to leave as narrow a margin as possible for accidents. There are no brakes on the gearing or shafts; but on each rear hub is a drum upon which all braking is done. The ordinary brakes, applied by a pedal, are of

the band type, working on the outer surfaces of the drums, while the emergency brakes consist of lever-operated expanding rings inside the drums. All braking is thus done close to the point of resistance.

The body of the new Packard has side entrances, and the rear seat is very spacious, there being ample room on it for three passengers. The front seats are individual and both front and rear seats have high backs. The mud guards are large and, with the running boards, form a continuous guard. The body is finished in Richelieu blue and the running gear in cream, the same as the 1904 Packard standard finish. The car is completely equipped, when delivered, with lamps, horn and tools.

Automobiling has taken an exceedingly strong hold on the people of the sunny State of California, and the opportunity for a manufacturer to put out a good car has not been overlooked. The Auto Vehicle Company, 943 Main street, Los Angeles, is building an automobile especially adapted to the road conditions to be found in California, one of which is the frequent occurrence of heavy grades. The car, which is made in two models, is called the Tourist. The touring model has a double opposed motor of 15-horsepower located under the bonnet, the shaft extending lengthwise of the vehicle, and driving by propeller shaft and bevel gears to the rear axle. The change speed gear is of the sliding type, gives three forward speeds and reverse, and is located under the footboard. Each cylinder exhausts into a separate muffler placed well toward the rear of the frame. A combined cellular radiator and tank occupies the usual position, and radiation is assisted by a fan. The mud guards form, with the steps, continuous fenders on both sides.

The Tourist runabout also has a double opposed motor located in front, rated at 12-horsepower and driving to the rear axle through a planetary change speed gear and chain. This machine weighs about 1,400 pounds. It is similar in most respects to the 1903 runabout built by this concern, which, however, had a motor of only 8-horsepower. The increased power is considered very desirable in order to give the car ample hill-climbing ability.

The touring car will carry five passengers and is rated to do thirty miles an hour on a good level road. It is sold equipped with horn and lamps, and all ready to put on the road. The factory, we are informed, has a capacity of ten cars a month, and it is expected that the total product for this year will be more than 100 complete automobiles.

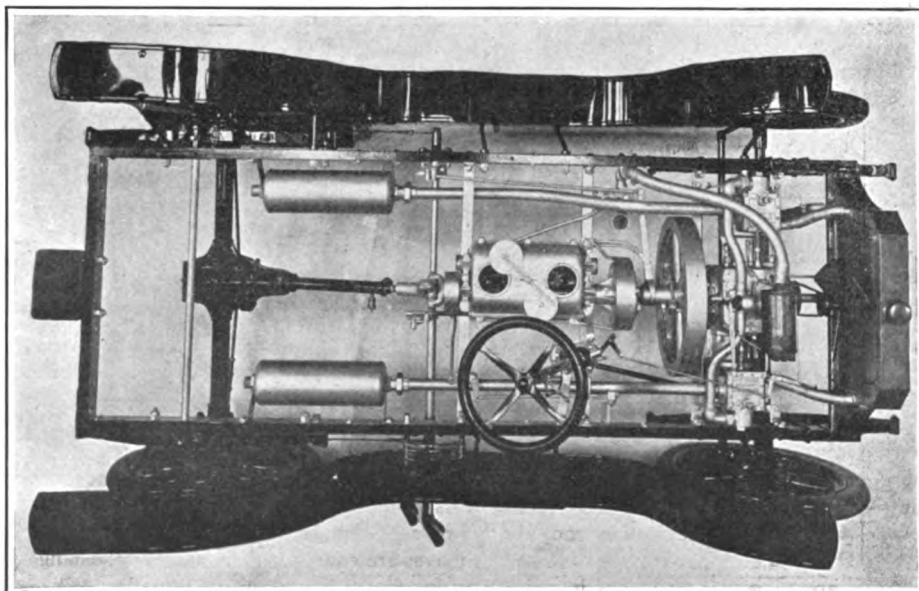

CHASSIS OF "TOURIST" CAR, WITH TRANSVERSE OPPOSED 15-HORSEPOWER MOTOR IN FRONT

Michigan Light Touring Car.

This is built to meet the demand for a four-passenger car of a fairly long wheel-base and reasonable power, at the lowest practicable cost. It has a two-cylinder horizontal engine of the opposed type, with cylinders 4.5-8 inches bore by 5 inches stroke. The heads are cast integrally, and both inlet and exhaust valves, which are of good size and located underneath, are mechanically operated, the exhaust valves by a single cam and the inlet valves by two separate and smaller cams, one on each side. The connecting rods are Whiteley steel castings. Jump-spark ignition is used, and the engine is lubricated by splash, fed by a pressure oiler, with pipes leading to each cylinder and each main bearing, each pipe



FIG. 1.—MICHIGAN TONNEAU TOURING CAR—TO CARRY FOUR PASSENGERS.

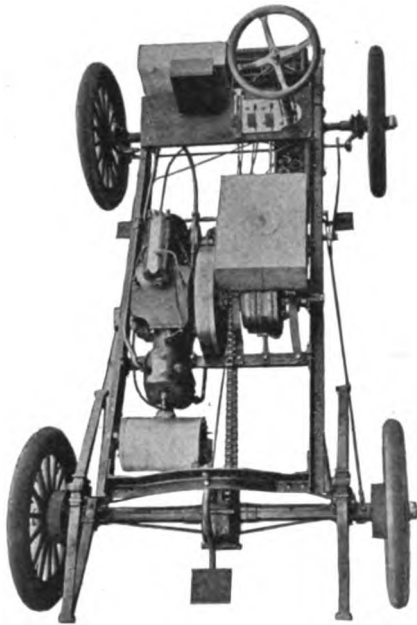

FIG. 2.—CHASSIS OF MICHIGAN CAR.

having its own sight feed. The engine is rated 12 horsepower at 1,000 revolutions per minute.

The speed-changing gear is of the planetary type, and is carried on a shaft separate

from the engine shaft, being bolted thereto by a flange coupling. The engine is supported on two cross-irons in the angle-iron frame, and the outer end of the planetary gear runs in another bearing attached to the right-side member of the frame. The details of the planetary gear are shown in Fig. 3. Only spur gears are used, there being no internal gears. A disk clutch gives the direct drive for the high speed.

Control is by a lever just outside the body, which gives the high speed in its forward and the low speed in its back position. The reverse is operated by a pedal. Other pedals apply the service and emergency brakes. Consequently, if the operator gets confused he cannot put his foot on any pedal that will not stop the car. It is, of course, necessary to move the speed-changing lever to neutral position.

The rear axle is made of crucible axle steel by the Crucible Steel Co. of America, and it is 1 1/4 inches in diameter. The Warner differential gear is surrounded by a malleable iron casing connecting the two fixed axle tubes in which the 1 1/4-inch shaft runs in four Hyatt roller-bearings. These tubes are of Shelby tubing. The wheelbase is 78

inches, and the springs are 32 and 36 inches long in front and rear, respectively, both being full elliptic. Radius rods preserve the rear axle alignment, and emergency-brake drums are fitted to the rear wheel hubs. Steering is by pinion and gear segment and

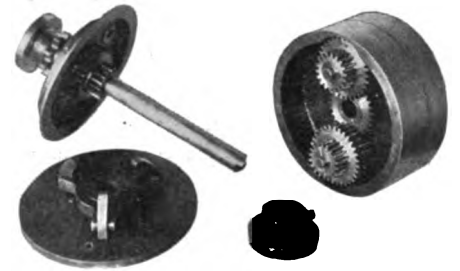
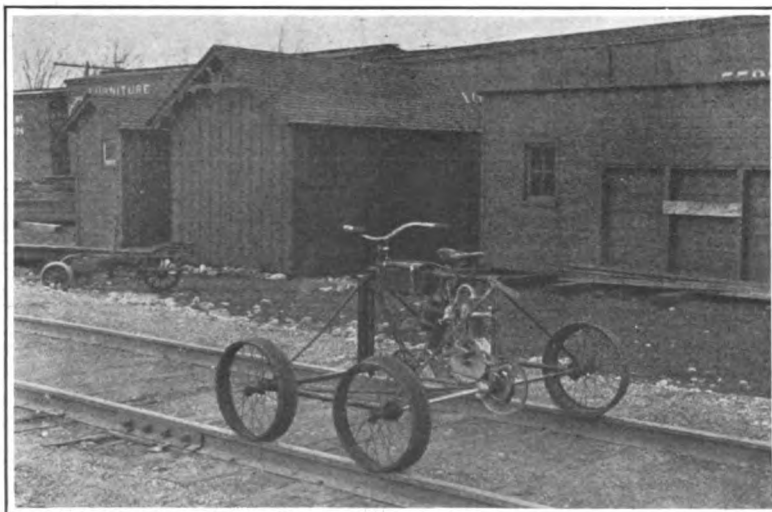

FIG. 3.—PLANETARY GEAR OF MICHIGAN CAR.

tilting wheel. The weight is stated to be 1,400 pounds, and the length 9 feet 4 inches over all. The car is built by the Michigan Automobile Co., of Kalamazoo.

Railway Inspection Car.

The accompanying illustration shows a railway inspection car fitted by the Merkel Manufacturing Co., Milwaukee, Wis., with one of its regular bicycle motors of 2 1/4 horsepower to show what the motor would do under the circumstances. A pedal driven railway cycle, made by the Kalamazoo Railway Supply Co., Kalamazoo, Mich., was fitted with a motor driving the rear wheels through a spur gearing. Starting is effected in the same manner as with a road motorcycle, by pedalling. The machine has worked well, the maximum speed obtained being about 30 miles an hour, while it may be reduced to about four. A band brake on the large gear on the rear axle will stop the car, when running at full speed, in about 15 feet. It is thought that the machine will be useful as a railway inspection car, or for any light service to which railway velocipedes are put.



RAILROAD INSPECTION QUADRICYCLE FITTED WITH MERKEL MOTOR

New Speed Indicator.

The ever increasing need for some means whereby the speed of an automobile may be ascertained by the occupants at any moment has had the effect of bringing out a number of speed indicators operated in various ways, the latest being the invention of Hartwell W. Webb, secretary and treasurer of the Webb Company, 417 Park Row Building, New York city. The Webb speed indicator depends for its action upon the lifting force of a column of air, set in motion by a small pump taking its motion from one of the road wheels of the automobile, which raises a small piston carrying on a rod an indicating head which moves up and down in a glass tube marked with a scale of miles.

The little pump is exactly similar in construction and action to the gear pumps used for circulating cooling water, and is driven by a gear secured to the hub of one of the front wheels. A feature of this gear is that it can be trued up after it has been attached. One of the pump gears is hollow, containing sufficient lubricating oil for a thousand miles. The pump body and gears are of bronze, the large driving gear of bronze and the pinion of steel. A special rubber tube covered with a protecting cover of varnished whipcord conducts the air from the indicator to the pump. The tubing may be cut to any requisite length.

The recording instrument, which is illustrated herewith, is attached to the dash. The lower part of the instrument consists of a brass tube, communicating at its lower end with the atmosphere, and at its upper end with the tube leading to the little air pump. The bore of the tube is tapering, the smallest diameter being at the bottom. An aluminum piston, from the upper side of which a rod extends upward into a glass

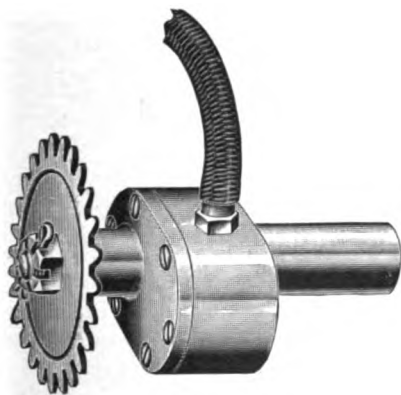

SPEEDMETER SPUR WHEEL AND PUMP.

tube above and in line with the lower tube, is free to move in the tapered bore, the smaller end of which it fits closely.

When the automobile moves the air pump rotates and draws a current of air up through the tapered tube. At a speed of two miles an hour the vacuum produced on the upper side of the little aluminum piston is sufficient to raise it and its index to the two-mile mark on the scale. The piston and rod weigh together 5 1-2 grains.

As the piston rises in the increasingly large bore of the tube, the amount of air that passes it increases until a point of equilibrium is reached, when, if the speed of the vehicle is constant, the piston and its index remain stationary.

It is stated by the manufacturers that the indicating head of such diameter in moved from the correct position by any

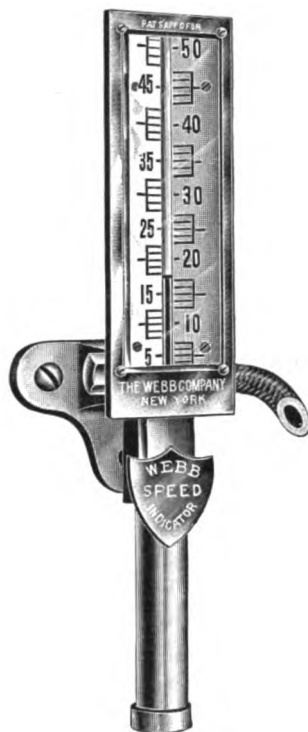

WEBB SPEED INDICATOR.

jolting or jarring of the car, but is "dead beat," this feature being secured by making the indicating head of such diameter in proportion to the diameter of the glass tube in which it rises and falls that its action is like that of the plunger of a dashpot in preventing sudden fluctuations. The instrument may be read, it is stated, at a distance of 20 feet, and from the tonneau seats with ease, if it is within the range of vision. A tilting mounting allows the indicator to be set at the most convenient angle to the eye of the operator. A heavy bevel glass plate covers the glass tube in which the indicating head moves and the indicating head is of a vivid red color. The body of the instrument is of brass, substantial in construction and ornamental yet unobtrusive in design.

When a doctor was haled before Judge Weand at the fall term at Norristown, Pa., recently charged with exceeding the legal speed limit, and his counsel explained that it was absolutely necessary on that occasion that his client make the highest rate of speed of which his machine was capable, as it was a case of life or death, the judge said: "In that case, it will make a very material difference in my sentence. Had the doctor been on pleasure bent I should have considered the advisability of inflicting the full penalty"—\$100 fine or thirty days in jail.

BOSTON AUTOMOBILE COURSE.

Y. M. C. A. School to Begin Second Winter's Instruction on November 8.

Special Correspondence.

BOSTON, Oct. 31.—The second winter course in the Boston Y. M. C. A. automobile school will begin on election night, November 8. Admission will be free that night. The programme that has been laid out provides for a general discussion of the automobile, past, present and future. Parker H. Kemble, who was in charge of the steam section last year, is superintendent of the course. He will describe the objects of the school in a general way. Dr. Walter G. Chase, who has just made a tour around the world, will speak on "The Motor Car in the Fiji Islands, and other out-of-the way Places." A. C. Fletcher, secretary of the Massachusetts Highway Commission, will be another speaker. His subject will be "Observment of the Speed Regulations, and the Registration of Cars." Other speakers will be Elliot C. Lee, president of the Massachusetts Automobile Club, and Colonel James F. Soutter, ex-president of the club and chairman of the advisory board of the school.

The governing board of the automobile school is the same as last year. Colonel Soutter is chairman, and the other members are George H. Lowe, New England manager of the White Sewing Machine Company; A. F. Neale, of the Studebaker Company; Isaac H. Davis, of the Crest Manufacturing Company, and J. S. Hathaway, secretary. Since last year this board has been busy making its plans for perfecting the course, and has proposed a considerable number of new details, which will make the instruction more valuable for all classes of persons interested in automobiles.

There will be courses of lectures on steam, gasoline and electric vehicles, and shop-work courses corresponding to the lectures. There will also be a drafting course. More attention will be given this year to the practical operation of cars, and road lessons will form an important feature of the school. There will be regular quizzes for the students and written examinations. Students who pass the examinations will be given certificates or diplomas.

The shop work on steam vehicles will be conducted in the Park Square automobile station, and will begin on the evening of November 10, the Thursday following the lecture. It is expected that the work on the steam carriages will be completed by the end of the year, and the lectures on gasoline cars will probably be started December 27. It is planned to start the electrical course February 28.

The success of the school last year is testified to by the fact that nearly all of the competent men who were graduated last spring readily found situations, one party taking three young men from the school. The management feels much flattered by the widespread imitation of the school throughout the country. From the time of the inception of the school the managers received queries from all parts of the United States and from abroad, and as a result of the information given schools are this year to be established in many places. In New England there are to be schools on the Boston plan at Providence, Worcester, Springfield and Brocton. Similar schools have also been established in New York, San Francisco, Chicago, Detroit, Cleveland, and other places.

Correspondence

Two-Cycle Engine Design.

Editor THE AUTOMOBILE.

[100].—What will be the height and width of the exhaust port of a two-cycle engine of 4 by 4 at 750 revolutions? E. A. Montreal, Canada.

Make the exhaust port 3-4 inch high and about 4 inches wide, measured around the cylinder wall. Have the bottom edges of both the exhaust and inlet or "transfer" ports flush with the top of the piston when the latter is at the end of its stroke, and make the inlet port 1-2 inch high and 3 inches wide.

Single Chain Driven Cars.

Editor THE AUTOMOBILE.

[101].—I have a friend who is building a motor car, and he asked me why there were not more single chain driven cars with the motor under the hood. Will you please tell me the objections to such an arrangement? A. E. S.

Windsor, Vt.

It is a little difficult to state in concise terms the objection to the arrangement proposed. It is an entirely practical arrangement, and is not preferred simply because the more common arrangements are more convenient or more efficient. If the motor is placed with its shaft lines across the frame of the car, there is not the usual room for the speed-changing mechanism inside of it, and this necessitates transmitting by a chain to a gear box, or planetary gear behind the motor. This results in two chains arranged tandem, which is an awkward arrangement when it becomes necessary to adjust the chains. When the car is small and light, it is possible to place the compact planetary gear outside the engine and drive from that to the rear axle through the single chain. If the chain is not too long this makes a very satisfactory arrangement. An example of it is seen in the Franklin runabout. If, on the other hand, the motor is placed with this shaft fore and aft, one is confronted with the necessity of using first the bevel pinion gear, and after that the chain, and this combination involves a greater friction loss than the bevel gears used with the customary propeller shaft. Consequently, the arrangement you propose, although very convenient for home-made machines, is not to be considered among the marketable devices.

Rights of Autos on the Streets.

Editor THE AUTOMOBILE:

[102].—I purchased a Grout steamer about three years ago, and as it was the first one in this city, it, of course, caused some of our town horses to shy. To-day one of my old friends filed an injunction to restrain me from running and operating

the car on the streets of this city, and my attorneys asked the Judge to allow the matter to rest for a few days until they could look up the law on such matters. Inasmuch as there is very little law upon the subject, especially in this State, I write to ask if you have at hand any decisions relative to the rights of automobiles upon the streets and highways. E. J. S. Paragould, Ark.

Amount of Compression Space.

Editor THE AUTOMOBILE.

[103].—About what should the compression space be of a 3 1-2 by 4 inch cylinder? Also the diameter and weight of fly wheels to be enclosed in the crank case? Also please tell me what the horsepower of such an engine would be. R. W. M. Toronto, Canada.

Compression space should be about 10 cubic inches if the motor is to run 1,200 to 1,500 revolutions per minute. The diameter of the fly wheels should be about 10 inches, and there is not much danger of putting too much metal into them. The inside diameter of the rim might be 6 inches, and the width as great as the crankcase will accommodate. You will, of course, cast a suitable counterbalance inside the rim opposite the cranks and crank pin. The motor should deliver about 5 horsepower at 1,500 revolutions per minute.

Not Interested in Racing.

Editor THE AUTOMOBILE.

[104].—We hope that you will not overlook the fact that some of your readers and subscribers are not interested in automobile racing. We must say that your number of October 15 was a great disappointment to us. We hope that some later numbers will have something more of interest to the average automobile user. E. B. L. San Antonio, Tex.

Replying to your letter, we beg to assure you that we were not unaware that some of our 12,000 subscribers are not specially "interested in automobile racing," for we have been long enough in the publishing business to appreciate that it is highly improbable that 12,000 persons scattered throughout the length and breadth of America and in various foreign countries would have exactly similar tastes or interests.

While your statement is quite accurate so far as it goes, you altogether overlook the real and only grounds for question on the part of a subscriber—do we give value received for the subscription price demanded per year? Let us see. In the forty-four issues of THE AUTOMOBILE, from January 2, 1904, to October 29, 1904, inclusive, we have published 1,210 pages of editorial reading matter, not counting a single page of the advertising section. These pages contain about 1,280,000 words, and not less than 1,266 original engravings. Practically all of the reading matter is original, and the

engravings are almost without exception made by ourselves, and hundreds of them from original photographs made exclusively for us, some costing as much as \$10 apiece. Our bill for photographs in the Vanderbilt race alone, for example, was nearly \$200.

All this matter the subscriber has had for just one dollar and sixty-eight cents.

Leaving out of consideration every line and every picture about racing that we have printed during the year, we submit that the remainder is value received for \$1.68.

Did it ever occur to you that there are some persons who are interested in reading about races, and that out of 1,200 pages of reading matter we have already published this year, they are entitled to a small percentage? The interest of the automobile reading public in the Vanderbilt race is so great that although, in anticipation of that interest we published 1,000 extra copies of the issue of October 15, the edition is all sold out, and we are not only unable to fill repeat orders of the American News Company, but are unable to meet the demand for extra copies from our own subscribers.

We would like to be in a position to include in the subscription to THE AUTOMOBILE, a complete copy of the Encyclopedia Britannica, the Century Dictionary and a few other similar works, but regret that it is financially impossible.

We suggest to you the thought that if you get as good returns for all the money you expend in other directions as you do in a subscription to THE AUTOMOBILE you are certainly ahead of the game of life.

Nails on Vanderbilt Cup Course.

Editor THE AUTOMOBILE.

[105].—I have noticed in different publications since the Vanderbilt Cup Race the theory advanced that nails and broken glass were intentionally scattered upon the course for the purpose of injuring tires. This may be entirely true, but on the other hand, I think that my experience on that day tends to show that the tire troubles which were so prevalent during the race were simply from natural results of running the event over the public roads.

I had occasion to walk from the grand stand to the Mineola crossroad—about two and a half miles. This side of the stand my attention was attracted to half of a broken horseshoe lying in the middle of the oiled surface of the road. After removing the same I made a point of walking up the road in the middle of the track, keeping a careful eye on the road for any similar objects that might be there. In the next two miles I found three half horseshoes, three bolts running from three to four inches long and from one-quarter to three-sixteenths of an inch in diameter, and five large nails, all of them of sufficient size to puncture a tire. The rusted condition of these objects showed me that they had been on the road for some time and

had apparently worked through the oiled surface to the top of the road.

If all of these could be found in two miles by one person, in a more or less unused part of the road, the average for the whole track per mile would be pretty heavy, and I think fully sufficient to account for the troubles the men had with the tires.

I am writing this to you, as I think it is only just to those people who may come under suspicion of having intentionally "salted the track." R. A. GREENE.

New York.

The personal inspection made by our correspondent would seem to confirm the report that nails were intentionally scattered over the course, rather than the reverse. Because the nails were rusted it would not necessarily follow that the rust had been gathered in the particular spot where the nails were found. Nails will rust almost anywhere if left exposed in the open, and accumulations of old horseshoe scrap and nails are not uncommon in farmyards.

Representatives of THE AUTOMOBILE drove over the roads repeatedly in the weeks intervening between the location of the course and the holding of the race. On none of these trips was any tire trouble experienced, and careful scrutiny of the road surface at many points did not show any abnormal surface conditions.

It has been suggested that immediately before the holding of a road race an electromagnet of suitable shape be drawn over the surface of the course so that any loose nails or iron scraps would be removed. This plan, though a good one, would not prevent tire troubles caused by broken glass.

True Navy Searchlights.

Editor THE AUTOMOBILE.

[106].—I have read the article "Headlights and Night Driving," by Joseph Tracy, in your paper, and I am a little surprised that you should publish an article containing so many evident misstatements.

Mr. Tracy has evidently done very little fast night riding and is evidently quite unfamiliar with the true Navy standard searchlight, as he refers to "so-called" searchlights.

Mr. Tracy's remarks about the dark shadows cast by the lights apply only when the lights are hung very low upon the car. With Navy type searchlights carried more than three feet above the road surface, hollows in the road that are safe to pass at high speed do not cause shadows.

No experienced driver would ever attempt high speed with any car fitted with only rigid lights, for very few roads are straight for any great distance. With a large swing light mounted upon the dash or mounted out forward and controlled by means of a convenient lever it is safer on most good roads to run at high speed by night than by day, and I have in my possession letters from many prominent motorists attesting to this.

A single nine-inch Navy type searchlight mounted high up on the dash will show a team or a bend in the road at 1,000 feet, or over, and I have often seen the reflection from the back of a carriage at fully 2,000 feet.

With a good searchlight fast riding is safer by night than by day, for several reasons. In the first place, there is much less traffic in the way, people with scary or supposed scary horses see the beam a mile or more away and get out of the road in ample time, and the motorist never is aware of their presence except, perhaps, for their dust as they pulled into some side road. Notwithstanding repeated statements to the contrary by excited drivers, the powerful light from the searchlight positively quiets horses that would run away at the sight of the car in the daytime. Horses are not frightened by the sound or smell of an automobile, but only by its appearance, and there never was a runaway when the searchlight was kept full in the horses' eyes until the car came alongside of him.

This effect of a powerful light is well shown by the fact that cats, rabbits and foxes will squat down in the road, and if the car is going very fast they are often run over.

I do not know who made the "so-called" searchlights that Mr. Tracy refers to. The Rushmore searchlight is exactly the same in every detail and proportion as the U. S. Navy searchlight, the only difference being that at the focal point of the mirror there is placed an acetylene flame instead of the electric arc. There are numerous "so-called" searchlights on the market, but they are only cheap imitations of the real Navy standard type, and with them, as Mr. Tracy has perhaps noted, fast night riding is not safe. S. W. RUSHMORE.

Plainfield, N. J.

REPLY.

Editor THE AUTOMOBILE.

Sir:—Mr. Rushmore in his letter says that my article contains "many evident misstatements."

It does not require a "true Navy standard searchlight" to see that Mr. Rushmore has a chopping instrument to grind; this may be seen even with such a poor equipment as one of the "numerous so-called searchlights which are on the market."

The writer has driven rather fast at night—forty to fifty miles an hour—and, strange as it may appear, without the aid of the "true Navy standard searchlight." My car was fitted with "rigid lights." According to Mr. Rushmore, high speed would not be attempted by any "experienced driver" in a car fitted with such lights.

Further on Mr. Rushmore says: "With a large swing light mounted upon the dash . . . it is safer on most good roads to run at high speed by night than by day."

If this statement is correct, why not have the Gordon Bennett and Vanderbilt cup races run at night in future? The com-

peting cars would, of course, be equipped with "a large swing light mounted upon the dash or mounted out forward," preferably, "a true Navy standard searchlight."

Several other statements in Mr. Rushmore's letter, as, for instance, "the powerful light from the searchlight positively quiets horses," will be news to most experienced motorists. Possibly there may be a preponderance of the violet or soothing rays in the light emitted by Mr. Rushmore's searchlights; if this is the case, a brisk demand for "true Navy standard searchlights" may be expected—from the horse trainers.

Regarding Mr. Rushmore's statement that "horses are not frightened by the sound or smell of an automobile," how does he explain why a horse runs away when an automobile comes up from behind, when the horse cannot see it? Or, why it is not uncommon for blind horses to take fright on the approach of a car?

In conclusion, my references to "so-called searchlights" did not mean any lamp in particular, and the expression was used merely to distinguish the movable light from the fixed one. JOSEPH TRACY.

New York.

Thomas Racer Completed.

There may be two E. R. Thomas cars in the Eagle Rock hill climb on November 24, for the 60-horsepower Mercedes entered by E. R. Thomas, the New York broker, may be supplemented by a new 60-horsepower, six-cylinder racing car that has just been completed by the E. R. Thomas Motor Company, of Buffalo. This new machine, of which vague hints have been given from time to time, was last week completed and nearly assembled. A road test was to be given it this week, after which a racing body, patterned somewhat after the foreign cars that took part in the recent Vanderbilt cup race, will be put on.

It is not known yet who will drive the car in the hill-climbing contest, should it be entered, but Charles S. Henshaw, Boston representative for Thomas cars and a former tandem team mate of Charles Hedstrom, is mentioned as a possibility. C. J. S. Hill, the wealthy yachtsman and clubman of Warren, Pa., may, however, be first to drive the Thomas racer in a contest, as Mr. Thomas admitted last week that Mr. Hill had placed his order for a six-cylinder Thomas racer, which will be taken to Florida for the January tournament. Should it do well in the trials and races there, it is contemplated to enter it for the Gordon Bennett race.

Although 60 horsepower seems low for a racing car, as compared with the 90-horsepower Panhards and Mercedes, the fact that the regular 1905 model Thomas Flyer of 40 horsepower is capable of making a mile a minute on good roads leads Mr. Thomas to believe that the racing car can take care of itself in very fast company. The result of the entrance of the Buffalo manufacturer in racing will be watched with interest.

Patents

Tubular Metallic Wheel.

No. 772,812.—T. Midgley, of Columbus, Ohio.

A wheel whose special feature is the reinforcement of the end of the spoke by means of a steel thimble 4, which is stamped from a blank 11 of the form shown in detail. This thimble is attached to the rim

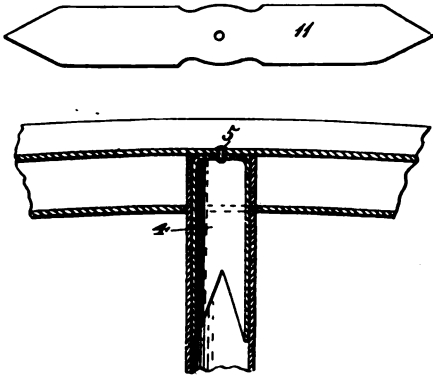

MIDGLEY METAL SPOKE REINFORCEMENT.

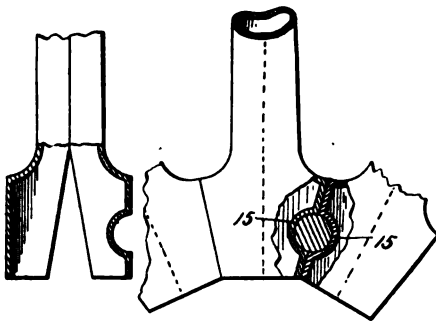

MIDGLEY STEEL SPOKE AND FASTENING.

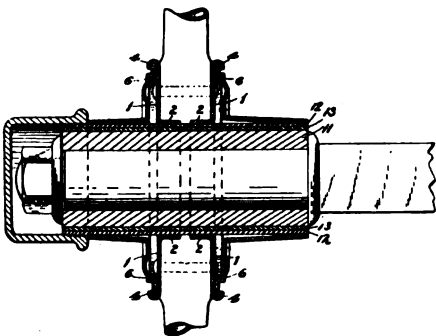

MIDGLEY PRESSED STEEL WHEEL HUB.

by a small rivet 5, which merely holds it in place until the brazing is accomplished.

Metallic Wheel Spoke.

No. 772,814.—T. Midgley, of Columbus, Ohio.

This spoke is stamped up out of sheet steel and is welded to form a tube with a longitudinal seam, which is subsequently brazed. Instead of the transverse bolt passing through the base of an ordinary wood spoke, a bolt is used which passes through notches 15, which are formed in the last stamping operation.

Metallic Wheel Hub.

No. 772,813.—T. Midgley, of Columbus, Ohio.

A pressed steel hub, built up of portions 1 1 with flanges 2 2, and portions 6 6 attached to 1 1 by lips 4 4, and lined by bushings, 11, 12, 13 substantially as shown.

Induction Coil Protector.

No. 772,590.—R. Varley, of Providence, R. I.

This device is a loose hood of soft rub-

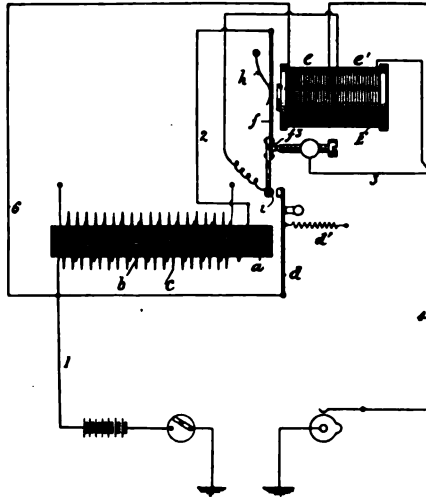

VARLEY INDUCTION COIL.

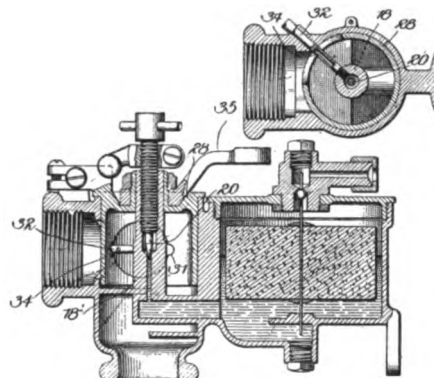

KINGSTON FLOAT-FEED CARBURETER.



APPLE LEAD BATTERY CELL.

in a moment without disturbing any screw connections. The plugs are irregularly spaced, so that the coil cannot be incorrectly replaced.

Induction Coil.

No. 772,592.—R. Varley, of Providence, R. I.

On the ordinary induction coil with magnetic vibrator it is desirable both to make the vibrator spring stiff enough to insure good contact between it and the contact screw, and at the same time to have the

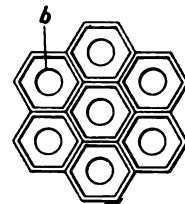
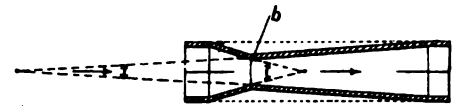

GROUVELLE AND ARQUEMBOURG RADIATOR.

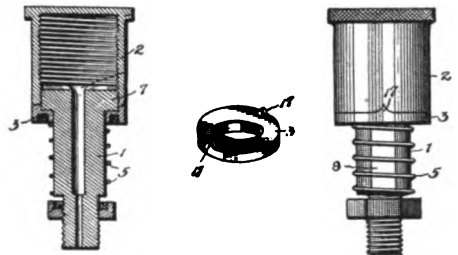

BOWEN GREASE CUP CAP LOCK.

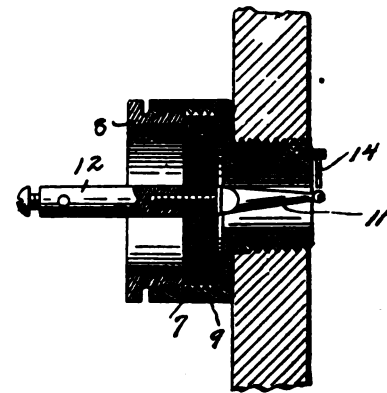

WISNER SPARK PLUG.

ber, arranged to be slipped snugly over the round coil, so that it protects the vibrator and attached parts. By reason of the flexibility of the hood, it is possible to adjust the vibrator without exposing it, by gripping the screw heads through the rubber.

Induction Coil.

No. 772,591.—R. Varley, of Providence, R. I.

A coil in which the place of binding post is taken by spring contact plugs fixed on the post of the box holding the coil, so that the coil may be lifted out and replaced

spring light enough to demand the minimum of magnetic force to break the contact. The object of the present invention is to get around these conflicting requirements. The core and primary and secondary windings of the spark coil are represented by a, b, c, and the vibrator armature by d. An additional coil E is provided, which has two windings, e, e1, which are connected in relation to each other so that when current flows through both the magnetism of the core is neutralized.

The armature d strikes an insulated contact on the end of the armature f. When

the parts are in position shown, the principal battery current follows the path *1, b, 2, f, 3* and *4*. A portion, however, goes through *6, e* and *7*, thus energizing the magnet *E*. When *d* is attracted, it strikes the end of *f*, and breaks the latter's contact, thereby producing the spark; but it also makes contact at *i*, so that coil *ei* is energized, thus instantly neutralizing the magnetic attraction on *f*. Consequently, *a* has only the light springs *dI* and *h* to overcome.

Carbureter.

No. 771,985.—G. Kingston, of Kokomo, Ind.

A modified form of the well-known Kingston carbureter. The spray orifice *34* is drilled in a tube *32*, which is screwed into the stand-pipe *18*. This orifice is located at one side of the passage, and as the passage is gradually closed by the shutter *28*, operated by lever *35*, the air stream is more and more concentrated on the orifice *34*. Thus the gasoline is always taken up by a sharp stream, and to prevent too much from being taken up when the passage is nearly closed, the threaded needle valve *20* is so connected to *28* that rotation of the latter partly screws down the needle, thus restricting the flow of gasoline to *34*. Means are provided, as shown, to adjust *20* and *31* relatively to the shutter.

Lead Cell for Storage Batteries.

No. 772,123.—V. G. Apple, of Dayton, O.

This containing cell is intended for small batteries, such as ignition batteries, and acts as one element as well as the case or jar. It has internal ribs *5*, as shown in the plan view herewith, which are dove-tailed, leaving spaces *6*, which may be filled with active material if the cell is to be of the "pasted" type. The bottom of the cell is indicated by *3b*.

Radiator Tubes.

No. 772,279.—J. Grouvelle and H. Arquebourg, of Paris, France.

A tube with hexagonal ends, which may be soldered together, as the end view shows, and which are contracted at *b* to a circular cross-section. The inventors claim that a minimum of resistance to the passage of air through the tube may be obtained by experimental selection of the angles indicated by the dotted lines.

Spark Plug.

No. 770,927.—W. Roche, of Jersey City.

A spark plug in which the porcelain is packed partly by asbestos or other fibrous packing, and partly by metal rings between the fibrous packing and the metal. These rings act as washers, the inner end of the stem has a mushroom head, from which the spark jumps across a space made by coning the end of the porcelain and of the body of the plug. In one form of this plug the stem is surrounded by a mica sleeve.

Spark Plug.

No. 772,856.—C. H. Wisner, of Flint, Mich.

This is a somewhat novel departure from the ordinary types of spark plug. The insulating material is a bundle of disks of mica *9*, whose edges are compressed between the shell *7* and the threaded bushing *8*. The center stem *11* is screwed into the binding posts *12*, thereby compressing the mica to prevent leakage. The stem *11* is surrounded for the most part by burnt gases.

Planetary Gear.

No. 772,274.—C. H. Day, of Hornellsville, N. Y.

The special feature of this gear is the formation of all the spur pinions for the several speeds in a single unit, as shown, together with the fact that they revolve at all times with the flywheel *12*, whose hub *11* is keyed on the engine shaft *10*. No internal gears are used. For the slow speed forward, band *34* is tightened, rendering *31*

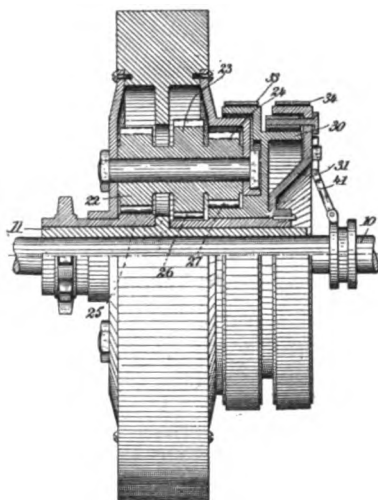

DAY PLANETARY CHANGE-SPEED GEAR.

and gear *26* stationary. Pinions *22* and *23* then act as a lever fulcrum on *26*, and the slow speed is imparted to gear *25*. For the reverse, band *33* is tightened, rendering *27* the fulcrum and giving a reverse motion to *25*, owing to the fact that *22* is larger than *24*. For the direct drive, *30* and *31* are locked together by a clutch band and toggles *41*.

Vehicle Wheel.

No. 772,648.—T. A. Edison, Llewellyn Park, N. J.

This invention consists essentially in the use of sections of endogenous wood, such as the palm, arranged with the fibres extending radially. These sections may constitute merely a tire, in which case their merit is that of being formed of tough fibres connected by soft intercellular matter, so that their surface picks up the sand and dirt from the road and becomes filled therewith. This at once protects the wood from abrasions and gives it an anti-slipping

quality, stated by the inventor to be much superior to that of the pneumatic tire. The inventor prefers, however, to have these sections extend nearly to the hub, thus forming a solid, spokeless wheel, and with this construction he proposes to use a ring of pure and very elastic rubber between the inner ends of these sections and the hub proper, where it forms a protected elastic cushion.

Grease Cup.

No. 772,399.—G. W. Bowen, of Auburn, N. Y.

The object of this invention is to prevent possible jarring loose of the screw cap *2*. This is done by notching its lower edge to match projections *17* in a ring *3*, which surrounds the stem *1*. The latter has flattened sides *9*, which *3* fits, to prevent the latter from turning, and the spring *5* keeps the teeth and notches in engagement when *2* is not forcibly turned by hand.

Electric Vehicle.

No. 772,571.—H. P. Maxim, H. M. Pope and H. W. Alden, Hartford, Conn.

This patent, the application for which was filed in 1897, covers in a comprehensive manner many of the now familiar safety devices for using and charging vehicle batteries, and for commutating the same to control the motor speed. Patent has 31 claims.

Speed Indicator.

No. 772,625.—F. Montandon, Chaux De Fonds, Switzerland.

This is essentially a stop watch, which is stopped and started at regular space intervals by a friction wheel and flexible shaft, driven from one of the front hubs. The dial has a supplementary graduation, reading directly in miles or kilometers per hour, and when the vehicle is in motion the stop watch is successively started, stopped at the end of the distance chosen—e.g., 200 metres—and returned to zero. The driver is able during the alternate intervals to read his speed by the point at which the hand stops.

Battery Holder.

No. 772,415.—F. Jackson, Denver, Colo.

This invention is intended to dispense with binding posts. Each cell is placed in a compartment by itself, with a spring clip of metal, by which contact is made with the zinc shell of the battery. The top of this spring clip is extended into a spring of suitable form to make contact with the carbon element of the next cell.

Battery Charging Apparatus.

No. 772,030.—G. H. Condict, of New York.

A movable table, resembling a turn-table, on which an electric car may be run between guides to have its battery tray drawn out by power apparatus; with power means acting on the guides to locate the vehicle exactly in position.



VOL. XI.

No. 19

Published every Saturday by

THE CLASS JOURNAL CO.,
Flatiron Building, Madison Square,
NEW YORK CITY.

Cable Address - - - - Autoland, New York
Long Distance Telephone - 300 Gramercy, New York

SUBSCRIPTION RATES:

United States, Canada and Mexico, - One Year, \$2.00
Other Countries in Postal Union, - One Year, \$3.00

To Subscribers—Do not send money by ordinary mail.
Remit by Draft, Post-Office or Express Money Order,
or Register your letter.

FOREIGN SUBSCRIPTION AGENTS:

ENGLAND:—Iliffe & Sons, Limited, 3 St. Beide Street,
Ludgate Circus, London, E. C.

FRANCE:—Boyveau & Chevillet, 22 Rue de la Banque,
Paris.

GERMANY:—A. Seydel, Mohrenstrasse 9, Berlin.

To Advertisers—Copy or changes in orders for advertisements should reach us not later than 5 o'clock p. m. Monday for the issue of Saturday following.

Copyright, 1904, by The Class Journal Company.
Entered at New York, N. Y., as second-class matter.

The Automobile is a consolidation of The Automobile (monthly) and the Motor Review (weekly).

Copies Printed This Issue, - - 12,000

“ “ Since Jan. 1, - 543,000

Construction Tendencies Here and Abroad. One feature which will distinguish the annual automobile show to be held in Madison Square Garden next January will be the number of large touring cars marketed by our builders, many of whom have been identified hitherto with the construction of light cars only. It is apparently coming to be recognized in all the automobile building countries that one type of machine alone is not sufficient for all needs, and that, as in the case of horse-drawn vehicles, there should be special consideration shown in design for the particular use for which the vehicle is intended, so as to insure the best results in operation. This recognition is also the cause of the intended construction of a “line of cars” by some of the builders who, in the past, made only the larger types. In each individual case the question of types is, of course, purely a business consideration. A number of builders who have made a splendid success of some one particular type, will stick to the construction of that type only, the needed output taxing all their facilities. In the American industry as a whole, however, there is a marked tendency toward the construction of the larger type of touring cars of the now conventional four vertical cylinder model.

Hitherto the greatest effort has been in the runabout class, in which, indeed, America now leads the world. The growth has

been indigenous and has proceeded along lines of gradual evolution from the early days when an automobile was practically an ordinary carriage with a motor attachment.

The motor in front type of car, with separate chassis (the modern road locomotive) is an exotic, and as such its cultivation was not as general as the domestic variety. A few far-seeing builders early adopted this form for the larger cars, and their names have come to be identified with the type. Yet it is doubtful if this type of car would have achieved its present popularity here had not the imported machines of the type demonstrated to the car-purchasing public the advantages of the model, in the larger sizes at least.

Educated on runabouts, the car-owning public wants larger and more powerful vehicles, and the home builders are going to meet the demand in the coming year.

Abroad the conditions are almost the reverse. The early invention of the modern four-cylinder motor-in-front tonneau car led to the concentration of attention on this type, and its rapid development was made possible largely by the practical trials in road races. Social conditions abroad, which give the rich and influential the lead in such movements as the introduction of the automobile into daily life, made a ready market for the higher-priced machines. The market for such machines is not inexhaustible, however, even in the wealthiest nations, and so the attention of the foreign builder turns to the smaller and lower-priced cars.

Our Berlin correspondent, in an article published in this issue, writes that even the originators of the costly Mercedes car are planning to build a low-priced machine. In the exhibition at Leipzig, which he reports, the small car, in many cases a direct copy of the American runabout, is numerous. In England the small car is now in the center of public attention; special trials for small cars have been carried out, and at the Stanley Show this month, the runabout class will have the floor.

It would seem that the present is a fine opportunity for the American runabout builders to work up an export trade. The situation abroad is almost a parallel for that which existed in the tonneau class in this country a year or two ago, and which stirred the activities and largely increased the profits of the French and German builders.

That great technical authority, the *New York Times*, in discussing editorially the airship of the future, expresses the opinion that “in all probability they will consist of a very simple plane surface, pushed along over the air by stronger and lighter engines than can be built at present.”

We have italicized “over,” but a lower altitude for ours when we take our maiden airship voyage.

The *Times* scientist admits the necessity for “stronger and lighter engines,” and yet it is only a few days ago that he solemnly said that the “Vanderbilt race proved nothing of interest and value” in the practical development of automobile mechanics. Will our scientific contemporaries please explain how stronger and lighter engines can be built without such practical trials as the Vanderbilt and similar road races impose? Design, as we understand it, is only a process of trial and error, the latter minimized by the application of modern scientific knowledge. Wont the *Times* please disclose the secret whereby the maximum power output for the minimum weight of materials can be attained without severe and prolonged trials? But an editor who can ride “over the air” will find no difficulty in getting over any trifling technical difficulty of design.



Automobile Insurance Liability.

In a letter received from a correspondent on the subject of automobile liability insurance, he calls attention to a clause in all the policies that have been offered to him by agents, which relieves the company from all liability in any accident occurring when the car is moving at a rate of speed in excess of that allowed by law. He says that in his locality an eight mile an hour limit is in force, and he has found by “following many machines” that the speed registered by his speedometer averages eighteen miles an hour. “What is the use of an insurance policy under these circumstances?” he inquires; answering his own query, however, by the statement that he is informed by the agents that the clause “don’t mean anything,” and that many cases have been defended and settled without reference to it.

The answer quoted is, of course, an interesting one. A disinterested reply is that any insurance company of repute is engaged in a lawful business and is not putting a premium on lawlessness. Were it the practice of an insurance company to issue policies that would enable any driver to break the law, the company guaranteeing him immunity from financial loss in case of damage to property or injury to person, would be a fit subject for investigation by the District Attorney in the locality where the company issued such policies.

Insurance companies are not privileged to disobey the law or to aid others in doing so, no more than private individuals. It is to their interest, indeed, not only to obey the law themselves, but in duty to their stockholders, not to accept the risks of law-breakers. The moral hazard has a well-defined place in insurance practice.

In every day affairs, the illegal storage of explosives in a building, for example, will vitiate all fire insurance policies covering the premises. Or in the case of a ship lost at sea, if it is proven that the vessel at the time

of the loss is engaged in some illegal enterprise, or is recklessly navigated in violation of law, it is a question whether payment of a policy could be enforced.

It is quite probable, as the agents informed our correspondent, that in case of loss under a policy where no question of the rate of speed is raised, the company may pay the loss without asking troublesome questions. Where the case hinged on a rate of speed in excess of that permitted by law, the company would certainly be acting within its rights to withhold payment. Otherwise, where would the line be drawn? If the legal limit is eight miles, would the man with a car capable of only twenty miles an hour and going at that speed be entitled to compensation, and the man with a car capable of seventy miles an hour and going at that rate of speed, be entitled to none, in the case of mishap covered by a policy? Who shall say?

NEW OFFICERS FOR A. L. A. M.

At the annual meeting of the Association of Licensed Automobile Manufacturers, held at the offices of the association, 7 East Forty-second Street, New York, on November 2, the following new board of officers was elected:

President, Charles Clifton, of the George N. Pierce Company, Buffalo, N. Y.; vice-president, W. E. Metzger, of the Cadillac Automobile Company, Detroit; treasurer, H. H. Franklin, of the H. H. Franklin Company, Syracuse, N. Y.; secretary, L. H. Kittredge, of the Peerless Motor Car Company, Cleveland, O. The board of directors stands unchanged, the members being Charles Clifton, F. L. Smith, E. H. Cutler, S. T. Davis, Jr., and M. J. Budlong.

The reports made concerning the season's business were considered favorable, and special comment was made upon the success of the recent meeting in New York City of the heads of mechanical departments.

The examination of witnesses in the Selden patent suits, now pending, was reported upon, but no mention was made as to the probable date of a decision.

If there is one word, more than any other, that those who build, sell, buy, drive, write about or talk about automobiles seem unable to get straight it is the simple one accelerator. Every man seems to have his own version of it. The automobilist who becomes intoxicated with high speed might be pardoned for calling it exhilarator, even if Daniel Webster *did* leave that word out of his book; but there is no excuse for such weird coinages as auxiliator, excelerator, excilirator and the many other similar mixtures used in this connection. An *ACCELERATOR* is that which accelerates or increases motion. Why not let it go at that?

There is a club of women in the city which ought to be called the automobile club, not that any of them own an automobile, but because they meet to "run everybody down." We got it in the neck the last time they met.—*Grenville (Mich.) Call*.

D. U. Brown has sold his motorcycle to a party in Manning. D. U. says his wife objected to the wearing out of his coat tails so often by flapping in the wind as he rode, so he was forced to sell it.—*Sac City (Ia.) Democrat*.

Milwaukee now records 320 licensed automobiles.

A. C. A. TICKET MADE UP.

Nominations for Officers and Governors by Board of Governors—Other Business.

Nominations for officers and governors were made at a meeting of the Board of Governors of the Automobile Club of America, held November 2 at the club headquarters in New York, the gentlemen selected being as follows:

President, Dave H. Morris.

First Vice-President, Colgate Hoyt.

Second Vice-President, William K. Vanderbilt, Jr.

Third Vice-President, C. G. Dinsmore.

Treasurer, Samuel H. Valentine.

Three Governors, to serve for three years, James L. Breese, Melville D. Chapman, Harlan W. Whipple.

The matter of building and equipping a suitable club house and garage was placed for consideration in the hands of a special committee consisting of A. R. Shattuck, Jefferson Seligman, Col. John Jacob Astor, William K. Vanderbilt, Jr., Arthur Iselin and Harlan W. Whipple.

The letter sent by the club to railroad superintendents regarding the failure of locomotive engineers to comply with the law in the matter of signals at grade crossings brought replies from the Long Island, Erie, New York Central, Pennsylvania, Lehigh Valley, New York, Ontario and Western and a number of other roads, stating that engineers had been instructed to live up to the requirements of the statutes.

The club will endeavor to have a State law passed compelling horse-drawn vehicles to carry lights after sunset. Investigation has shown that most of the villages and towns in New York and the neighboring States have no such ordinance, and those which have an ordinance do not enforce it.

The following were elected to active membership: E. Shriver Reese, president of the Automobile Club of Cleveland; Samuel Untermyer and Clifford M. Bouggy.

The meeting for the election of officers will be held at the club rooms, 753 Fifth Avenue, New York, on November 21.

CHANGES IN AWARDS.

Changes have been made in the list of prizes awarded to automobile manufacturers at the St. Louis Exposition as follows:

Electric Vehicle Company, original award gold medal, raised to Grand Prize.

Packard Motor Car Company, original award gold medal, raised to Grand Prize.

Winton Motor Carriage Company, original award silver medal, raised to Grand Prize.

Olds Motor Works, original award silver medal, raised to gold medal.

E. R. Thomas Motor Company, original award silver medal, raised to gold medal.

AUTO SCHOOL IN TORONTO.

Special Correspondence.

TORONTO, Oct. 31.—A class for motor drivers will be opened in connection with the

Toronto Y. M. C. A. to-morrow. The advisory committee, consisting of Dr. P. E. Doolittle, president of the Toronto Automobile Club; W. A. Kemp, vice-president; A. F. Webster, secretary, and John Westren, a prominent member of the club, have drawn up the course.

The work will include a course of lectures and demonstrations in the mechanism, structure, and operation of electrical, steam and gasoline automobiles. There is a demand here for competent drivers, and the class is expected to give men such training as will fit them for the work. The course will cover twenty weeks.

ALBANY HALLOWE'EN PARADE

Queen of the Festivities Rides in One of Fifty Cars Participating.

Special Correspondence.

ALBANY, Nov. 1.—One of the main features of Albany's first general and official celebration of All Hallowe'en was an automobile parade, in which more than fifty motor cars participated. The Queen of the Day, who, as Queen Titania, ruled the festivities of the program from morning until midnight, the carnival committee, and the friends of the automobile men, all arrayed in fantastic costumes, rode in the cars, which were decorated with the carnival colors of orange, white and green flags, and various floral and other designs.

Matthew Van Alstyn's canopy-topped touring car was covered with white and yellow chrysanthemums, and in it rode Queen Titania and her maids of honor and pages. Dr. W. E. Milbank, vice-president of the State Automobile Association, had his Knox car completely hidden by the carnival colors, and had as passengers three little girls dressed in white. He led the procession, which traversed all the principal streets of the city.

Among those who had their decorated automobiles in line were: Walter Allen, F. G. Robinson, Thomas Hun, Frank Graves, Dr. Hakes, Joseph Taylor, John L. Mallet, Walter Lemley, J. Lucey, O. A. Quayle, E. R. Burnham, P. E. Martin, Howard Martin, Spencer Neemes, Charles M. Hyatt, John Newell, J. F. Randerson, Allan A. Gilmour, Alex. Kramrath, Harry Simmons, Jr., Henry Kramrath, Charles M. Page, J. B. Lyon, Fred. Griesman, Harvey Muller, C. D. Ransom and F. H. Fish, all of Albany; N. J. Battle, of Cohoes; E. M. Powell, of Waterford, and C. B. Benson, Arthur S. Gray, R. V. Rhodes, D. S. Van Allen, Edward W. Healey and Arthur Fitch, of Hudson.

There was but one accident—a collision between the cars of Messrs. Gilmour and Robinson, caused by the skidding of the rear wheels of the Robinson car, as it crossed the street car tracks. A young woman passenger was thrown out of the Robinson car and a comb she wore inflicted a slight scalp wound.

PERMITS DRIVING ONLY AT NIGHT.

Special Correspondence.

NASHVILLE, Tenn., Oct. 31.—The discovery of a long forgotten "blue law" on the statutes of Tennessee is being used as a threat by the agriculturists who object to the automobile on the turnpikes. It is said that suit may be brought under this law to put a stop to fast running on the turnpikes.

The old statute was framed to regulate the operation of steam traction engines when those machines were first used. It provides that any vehicle propelled by steam or other power, except horses, mules or oxen, may be operated only between the

AMERICAN AND FOREIGN AUTOMOBILE AND AUTO-BOAT FIXTURES.

- Nov. 8.—Race Meet, Empire City Track, Yonkers, N. Y.
 Nov. 24.—Hill Climbing Contest, Eagle Rock Hill, Orange, N. J. A. C. of N. J.
 Dec. 9-25.—French Automobile Salon. Paris.
 Dec. 26-Jan. 2.—Reliability Trials. Motor Union of Western India.
 Jan. 11-24.—First Annual Importers' Automobile Salon, Herald Square Hall, New York.
 Jan. 12-21.—Fifth Annual Automobile Show, Madison Square Garden, New York. N. A. A. M., Madison Square Garden Co. and A. C. A.
 Jan. 14-24.—Fourth Annual Automobile Show at Brussels, Belgium.
 Jan. 23-28.—Ormond-Daytona Automobile Tournament. Florida East Coast Automobile Association.
 Jan. 23-28.—Philadelphia Annual Automobile Show. A. C. of Philadelphia and Auto. Dealers' Assn. of Phila.
 Jan. 27-Feb. 4.—Fourth Annual Automobile Show, Crystal Palace, London.
 Feb. 1-3.—Auto-Boat Races. Palm Beach, Fla. Palm Beach Power Boat Association.
 Feb. 4-11.—Fifth Annual Automobile Exhibition, Chicago. Coliseum Building. N. A. A. M. and C. A. C.
 Feb. 4-19.—Automobile Exhibition at Berlin, Germany.
 Feb. 5-19.—Automobile Week, Nice, France.
 Feb. 10-18.—Automobile Exhibition, London, England. Society of Motor Manufacturers and Traders.
 Feb. 13-18.—Fourth Annual Exhibition at Detroit. Tri-State Automobile and Sporting Goods Association.
 Feb. 21-March 9.—National Motor Boat Show, Madison Square Garden, New York. Nat. Assn. Engine and Boat Mfrs.
 Feb. 27-March 4.—Cleveland Automobile Show. Cleveland Automobile Club.
 Feb. 27-March 4.—Automobile Exhibition, Toronto Canada.
 March 3-11.—Motorcycle Show, Liverpool, England.
 March 6-11.—Third Annual Buffalo Automobile Show, Convention Hall, Buffalo. Buffalo Automobile Trade Assn. and Buffalo A. C.
 March 4-18.—Fourth Annual Automobile Show, Boston. Boston Automobile Dealers' Assn.
 March 27-April 5.—Fifth Annual Washington Automobile Show. Washington Auto. Dealers Assn.
 April 1.—Light Van Trials. A. C. of Great Britain.
 April 2-16.—Monaco Motor Boat Fortnight.
 June 26.—Mont Cenis Hill Climb.

hours of 9 p.m. and 4 a.m., and that such a vehicle must have a guard 200 yards ahead to give warning of the approach of the vehicle.

Imagine a big touring car preceded by a guard with a red flag or a lantern to wave off all travelers on the country road, and venturing out only by moonlight! Yet the law still stands on the books, forgotten even in its application to the traction engine, which now goes abroad at any time of day. It is considered hardly likely that a serious hearing would be given a suit brought under this statute.

RELICS SOLD CHEAPLY IN CLEVELAND

Special Correspondence.

CLEVELAND, Oct. 31.—The first automobile auction ever held in this section was held here Friday and Saturday in the quarters formerly occupied by the Cleveland Automobile & Supply Company on Vincent street. Mr. Bowler, a machinery dealer, who has handled second-hand cars for several years, had bought up a large number of machines and also arranged for the sale of old cars for local and out-of-town owners. The sale was freely advertised in surrounding towns, and there were a number of out-of-town purchasers.

About seventy-five cars of all descriptions were disposed of, and as a rule they brought very fair prices, although there were some good bargains. Some of the machines were of historical interest. A white-enameled Winton touring car of the 1902 model, fitted with canopy top, was owned originally by Reginald Vanderbilt, and is the one in which he took his wedding tour, it is asserted, and was also the first American car with a canopy top in New York. The big Wick blue car, which attracted attention at the New York, Chicago and Cleveland shows three years ago, as being the largest and most expensive car built in this country at that time, was knocked down at \$765 to Roy York, of the F. B. Stearns Company, who will have it rebuilt. This car, which was built for Henry Wick, a Youngstown, O., millionaire, was damaged by a street car in bringing it to Cleveland, but it can be put into good shape for a small amount.

EXPORTS OF AUTOS AND PARTS.

Exports of American automobiles and parts to foreign countries for the nine months, ending with September, 1904, aggregated in value \$1,445,986, representing an increase over the same period of 1903 of \$253,157, and over the same period of 1902 of \$598,000.

Exports of automobiles and parts for the month of September, 1904, reached the total value of \$123,487.

NEW WHITE STORE.

Fine Establishment Completed in New York for White Sewing Machine Co.

The completion of alterations by the White Sewing Machine Company on the building at 42-44 West Sixty-second street, New York, marks the passing of a large livery stable and the establishment of another stronghold of the "emancipator of the horse." The new headquarters of the White are up-to-date throughout, every need of man and machine having been anticipated.

The basement is large and light, with cement floor, and extends under the entire building, 65 feet wide and 100 feet deep. It will be devoted to the storage of cars whose owners and chauffeurs prefer to do their own repairing and tinkering, and these will have ample opportunity to do all the work they desire. In the rear of the basement is a chauffeurs' room, the walls of which are lined with lockers.

Outside the building, to the rear, is a large gasoline tank, enclosed in solid masonry and piped to a pump, which is also enclosed in a brick house with iron door. In a corner of the basement is the boiler room, where the heating apparatus for the entire building is located. The boilers are enclosed in a brick vault with a solid fire-brick ceiling separated from the ceiling of the basement by a twelve-inch air space and a steel sheathing.

The large elevator for carrying cars rises to the top floor. There is also a small hoist, built like a dumb-waiter, to be used for tools, repair parts and supplies. The blacksmith shop, which is not completed, will be in the basement.

The main, or street, floor will be devoted entirely to "live" storage, those cars which are most constantly in use being kept there. The washing of cars will be done on this floor. An office is located to the left of the entrance, and just beyond this are two dressing rooms for women, equipped with every comfort and convenience. A passage from the office leads to a large number of owners' lockers. This corner of the building is particularly attractive. From the rear of the main floor an iron door gives entrance to the gasoline pump vault, already mentioned, which is entirely separate from the main building.

In the front of the second floor is the salesroom for new cars. It is handsomely finished in natural wood, with polished floor. Squares of heavy matting are provided for the cars to stand on. The main New York offices of the company are located on this floor and are handsomely furnished. Back of the salesroom is the second-hand car de-

partment, a large room where only second-hand cars will be placed for sale. To the right of this is the stock room, large and completely equipped with everything—from a tire to a complete engine.

The third floor, which is not divided, will be used for "live" storage, while the repair department is on the fourth floor. This entire story is given up to repair work, the rear portion being equipped with all necessary machine tools, driven by an electric motor. The fifth floor will be utilized for dead storage, and later part of it will be partitioned off for a paint room.

RECENT INCORPORATIONS.

The Motoring and Boating Co., East Orange, N. J.; capital, \$100,000; publishers. Incorporators: James P. Holland, John H. Gerrie and Charles H. Munger.

Kensington Automobile Co., Camden, N. Y.; capital, \$100,000. Incorporators: V. W. Sipes, D. G. Cameron, E. C. Huselton and H. A. Tucker.

James Brown Machine Co., Providence, R. I.; capital, \$300,000; to manufacture motor cars. Incorporators: S. Fred Carpenter, Susan A., Ruth S., Alice J. and James S. Brown.

American Canvas and Tarpaulin Corporation, Buffalo, N. Y.; to manufacture automobile and wagon covers, tarpaulins and sails.

W. J. Kells Mfg. Co., New York City; capital, \$15,000; automobile equipment. Incorporators: W. J. Kells, Marion, N. J.; Q. H. Timpson and F. E. Pratt, New York City.

St. Louis Automobile Service Co., St. Louis, Mo.; capital, \$2,000. Incorporators: W. H. Bradsley, C. E. Harris, A. G. Harding, E. L. and W. R. Morgan.

Wilson & Hayes Mfg. Co., Detroit, Mich.; capital, \$50,000; to manufacture automobiles. Incorporators: Thos. H. Wilson, H. Jay Hayes and Edwin A. Stevens, Jr.

Cleveland Automobile Dealers' Co., Cleveland, O.; capital, \$1,000. Incorporators: C. B. Haskins, G. S. Waite, C. M. Brocknay, L. M. Alenders and M. K. Eyre.

Garfield Automobile Co., Chicago, Ill.; capital, \$15,000; to manufacture automobiles. Incorporators: N. E. McDaniels, George Schein and Justus Chancellor.

East Coast Automobile Co., Jacksonville, Fla. Directors, D. H. McMillan, W. F. Coachman, H. E. McEachern, Guy Champ-lain, Ed. Groover, Telfair Stockton and P. L. Sutherland.

AUTO-COACH LINE FOR WASHINGTON

Special Correspondence.

WASHINGTON, D. C., Oct. 31.—The probabilities are that within another month the National Capital will have a line of electric coaches for passenger service operating on a regular schedule and traversing a section of the city at present without street-car service. It is understood that a company has been formed with this object in view, which will have ample financial backing, and will put into service a sufficient number of automobile coaches to meet all the requirements of the traffic.

The coaches will have a capacity of forty passengers each, and the rate of fare will be five cents. The company is now waiting to receive from the manufacturers one of the coaches to place on the route. When this arrives, formal application will be made to the District Commissioners for the necessary permit to operate it. It is believed this permit will be readily granted in view of the benefit to the traveling public which will result.

NEW ONTARIO REGULATIONS.

Special Correspondence.

TORONTO, CAN., Oct. 31.—The Ontario government recently issued an order in council containing new regulations for automobiles. In brief the regulations provide a fee of \$3 instead of \$2 for license and number tag. The latter remains the property of the Province and is taken up if the owner of the auto license does not comply with

the regulations. This would, of course, immediately bar the automobiles from the use of Ontario roads. The number tag must always be displayed on the automobile.

Manufacturers will receive special tags for autos they are offering for sale. These may not be used by manufacturers on their private vehicles, nor may they be used on autos at a distance of more than five miles from the manufacturing establishment or showrooms.

The last regulation is considered a hardship by dealers, as they claim it is often necessary to drive a new car several miles into the country to demonstrate it to a customer, a common run for this purpose being from Toronto to Hamilton, a distance of fifty miles. The Provincial Secretary, on the other hand, when seen by THE AUTOMOBILE man, stated that the dealers were themselves to blame, as they had abused their privileges by allowing machines to be driven all over the country at reckless speed, with the result that numerous complaints from the police had been received.

At a recent meeting of the Common Council of Buffalo a resolution was adopted directing Superintendent Bull, of the Police Department, to enforce the provisions of the automobile law, and to see that automobiles do not travel faster than "a reasonable and proper rate of speed." The resolution was introduced by Alderman Martin, adopted by the Board of Aldermen and sanctioned by the Board of Councilmen.

TWO AUTO SHOWS FOR BOSTON.

Special Correspondence.

BOSTON, Oct. 31.—Plans now under consideration provide for the holding of two automobile shows here in March, one under the direction of the local dealers' association, and the other an importers' salon similar to that which will be held at Herald Square in New York at the time of the Madison Square Garden show. Two months ago there was talk of two shows in Boston, to be managed by factions of the local dealers, but the disagreement which caused that talk was settled and the Boston Automobile Dealers' show in Mechanics' Hall will have as a competitor for patronage only the importers' salon.

After the dealers' association had secured the N. A. A. M. sanction, the members of the Boston Automobile Trade Association were invited to come into the regular show in Mechanics' Hall, which was finally done. This show ought to be the biggest exhibition of automobiles ever held in New England. In Mechanics' Hall there is much more space than in Symphony Hall, where the show was held last year and the year before, and there has been a demand for space which will test the capacity, even, of the big hall.

The importers' salon will be along much the same lines as in New York. The local agents for foreign cars will show in Mechanics' Hall, and the New York agents will show in Symphony Hall. It will be the first time that Bostonians have had a chance at home to see the big foreign cars.

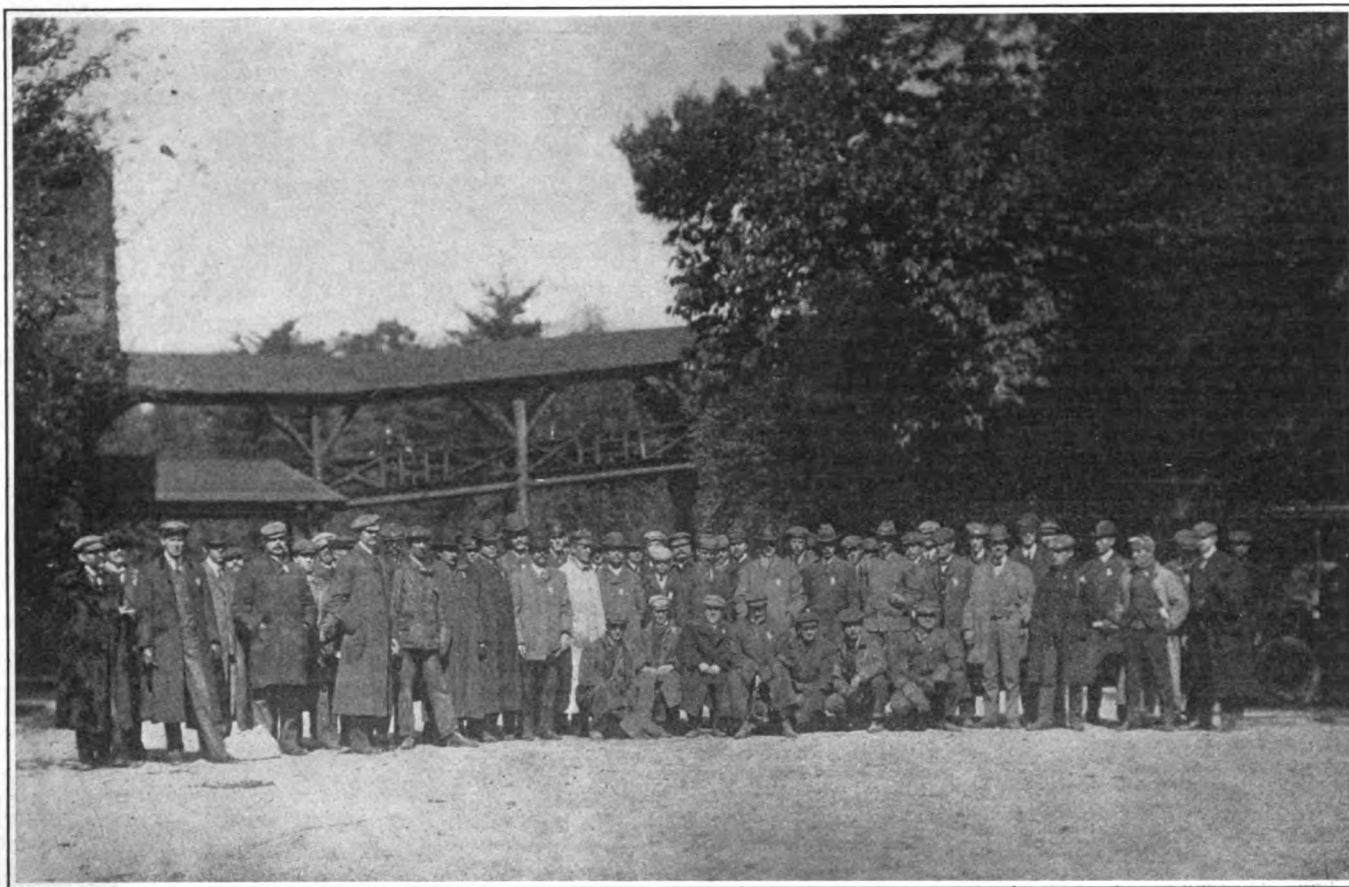

Group of men at the heads of the technical and mechanical departments of the plants of members of the Association of Licensed Automobile Manufacturers, photographed at the Ardsley Club upon the occasion of the seventy-mile automobile run from New York City to Elmsford, N. Y., and back, October 7. At ten points along the route the entire procession of eighteen gasoline cars, all of American manufacture, were stopped and the occupants changed cars, so that every man rode in ten different cars besides his own, thereby becoming more familiar with them all. Luncheon was served at the Ardsley Club, and upon returning to New York the party of fifty-three had dinner at the Casino in Central Park, during which the project of forming a branch of the A. L. A. M. was discussed. The following day most of the men attended the Vanderbilt Cup Race, the report of which event prevented the appearance of the accompanying engraving in our issue of October 15, along with the account of the convention.



OHIO VALLEY CLUB FORMED.

Organization Effected at Steubenville to Promote Automobile Interests

Special Correspondence.

COLUMBUS, Ohio, Oct. 31.—Automobilists of Ohio valley cities met last week at Steubenville, and effected an organization which proposes to become a member of the American Automobile Association. Twenty-two persons were present, representing Steubenville, Toronto and Brilliant, of this State, and Wellsburg, W. Va.

After a general discussion of the objects of the organization, S. C. Gill, of Steubenville, was appointed chairman, and a committee, consisting of the chairman, J. C. Lashley and F. E. Low, of Steubenville, and Asa G. Neville and F. A. Chapman, of Wellsburg, was appointed to confer with Pittsburg and Wheeling associations to secure information which will be useful to the local club in perfecting its organization. Great enthusiasm was displayed at the gathering, and everything indicates that the movement will promote automobiling in the Ohio valley, between Pittsburg and Wheeling, and place it on a splendid basis.

The club will use its best endeavors to advance the good roads movement, which is being agitated in Ohio, and in this particular will be of much help to Hon. Samuel Huston, of Steubenville, State Commissioner of Highways, who will establish his office soon after the first of the new year. This department was created by the General Assembly of Ohio last winter, but as the appropriations for its maintenance were not made available until 1905, Commissioner Huston has been unable to do anything officially yet. He is an earnest advocate of good roads, and has devoted many years to the study of this question.

The members of the club will co-operate with the authorities in the enforcement of all laws regulating the use of automobiles, as well as the driving of teams. One of the things that the association will strive especially to do will be to discourage reckless driving of automobiles in disregard of danger to other users of the highways. The laws regulating speed will be rigidly observed.

WANT GLASS THROWERS PUNISHED.

Special Correspondence.

PHILADELPHIA, Oct. 31.—At a recent Friday night regular meeting of the Automobile Club of Philadelphia, it was proposed that the club introduce a measure at the next meeting of the Legislature by which any one convicted of throwing nails, tacks and broken glass on the highways may be suitably punished. An endeavor will be made to enlist the co-operation of motor-car owners and tradesmen all over the state. As many blooded horse drivers are now using pneumatic-tired speed wagons, they are sufferers in common with the automobilists—indeed, they suffer more, for the thin tires of a horse-drawn vehicle are much more easily punctured than are the heavy tires of automobiles. An effort will therefore be made to enlist their aid in the war against the common enemy.

The various toll fights came up for discussion, but nothing was done except to urge the members to gather all data for use in the future, when an organized effort will be made to keep the demands of the turnpike companies within bounds.

Some talk of a parade was indulged in, but the scheme was indefinitely postponed, another cross-country "run" having been decided upon. With the experience gained, each of these affairs is over a longer route than its predecessor, and it is quite likely that the next event will be to Atlantic City and return—about 120 miles. One feature of this run will be that the committee will decide to a minute the minimum time in which the run can be legally made, and all contestants finishing inside the limit will be disqualified. The cup, which will be hung up by Horace A. Beale, Jr., will be awarded to the car finishing nearest the limit and outside of it. The carrying of watches or speedometers by the contestants will be forbidden.

CLEVELAND DEALERS ORGANIZE.

Special Correspondence.

CLEVELAND, Oct. 31.—The Cleveland Automobile Dealers' Company has been organized, with \$10,000 capital stock, by Clifford B. Haskins, George S. Waite, Clarence E. Brockway, L. M. Henters and M. K. Eyre. This is the outgrowth of the dealers' association, which was formed a short time ago. The charter gives the association the right to hold automobile shows, race meets and other ventures of interest to the automobile trade and sport.

The persons who conducted the local shows heretofore, and who threatened for a time to make trouble with the new dealers' association over the matter of a sanction for the show here this winter, have been won over and will co-operate with the new organization. The date for the local exhibition this year has not been decided upon, and a meeting will be held this week for that purpose and to elect officers.

NOTES OF THE CLUBS.

PRINCETON, N. J.—The Princeton Automobile Club, recently organized, has elected the following officers for the ensuing year: Childs Frick (1905), Pittsburg, president; S. H. Bird (1906), New York City, vice-president; J. S. Martin (1906), Belleville, N. J., treasurer. The charter membership of the club numbers more than thirty.

BOSTON, Mass.—The Boston Chauffeurs' Club has been formed, with the following officers: Frank Butler, president; Lewis Wallaston, vice-president; W. E. Layman, secretary, and A. L. Bennett, treasurer. A committee was appointed to draft by-laws and regulations to be submitted for adoption at an early meeting.

OSHKOSH, Wis.—Twenty local machine owners have formed the Oshkosh Automobile Club. Constitution and by-laws were adopted and the following officers elected: Dr. H. B. Dale, president; A. H. Meyer, vice-president; W. J. Campbell, secretary, and Frank Gates, treasurer. The president appointed the following committee to secure new members: Dr. W. H. Titus, Frank Gates and Leorr Chase.

KANSAS CITY.—The A. C. of Kansas City recently instructed its attorney to make a test case of the validity of the new ordinance requiring licenses for the operation of automobiles in this city. A case will probably be taken to the Court of Appeals, and from there to the Supreme Court of Missouri, thus reaching a final decision quicker than by the usual process through the criminal courts.

BUFFALO.—It has been found by the officers of the Automobile Club of Buffalo that the present headquarters at 59 Franklin street are not in a satisfactory location, and it is possible that the club may move to new quarters in the Teck Theatre Building on January 1. A movement toward that end is now afoot. The rooms on Franklin street are attractive and modern in every particular, but it has not proved the popular meeting place of automobilists that was expected, and prospects of the rooms becoming the headquarters of members and motorists have waned. The Teck Theatre Building is right in the heart of the automobile trade district.

PHILADELPHIA.—After a delay of nearly three weeks, the Tours and Runs Committee of the Automobile Club of Philadelphia announced the result of its cross-country run on October 1. The committee decided that C. H. Gillette's protest over a four-minute delay at West Chester was legitimate, and that W. O. Griffith should be allowed three minutes for a similar delay. This gave the E. Bartol Brazier cup to Gillette, who beat Griffith's time by four minutes. Macmillan Hoopes finished third; L. Knowles Perot fourth; S. E. Hutchinson fifth; H. A. Beale, Jr., sixth, and Kern Dodge, seventh. No times were announced.

SPRINGFIELD, VT.—Secretary W. D. Woolson, of the Vermont Automobile Club, has recently compiled a list of all of the owners of automobiles in the State of Vermont, so far as he has heard from them. There are 215 names on his list, but he estimates that there are not less than 275 owners, as many new cars have been purchased lately whose owners' names have not yet been listed. The machines are divided among the towns of the State as follows: Burlington, 38; Barre, 27; Brattleboro, 26; Rutland, 21; St. Johnsbury, 16; Richford, 10; Montpelier and Bennington, each 7; Woodstock, 6, and South Londonderry, Springfield and St. Albans, each 4.

LEAVENWORTH, KAN.—At a recent meeting of the Interstate Automobile Association, held here, officers were elected for the ensuing year as follows: Omar Abernathy, Leavenworth, president; H. N. Strait, Kansas City, vice-president; "Ned" Osborne, Topeka, secretary; Dr. Beitzel, Atchison, treasurer. This association is composed of motorists of Missouri and Kansas and meets every year. The next meeting will be held in Kansas City. Fifty members were in attendance. Committees were appointed to prepare maps of Missouri and Kansas roads and to work with the farmers to secure good roads legislation, which has been recognized as a great need. Candidates of both the political parties are running for election in both States on the issue of good roads alone, and are receiving hearty support.

WASHINGTON, D. C.—A movement started by Whitman Osgood, John C. Wood, A. L. Cline, and other leading automobilists here seems likely to result in the organization of a strong club. The National Capital Automobile Club, formed several years ago by General Nelson A. Miles, W. J. Foss, and others, has gradually declined, until to-day it exists in name only. The need of a strong club that would combine sociability with practical work in fighting oppressive legislation in the District of Columbia and the adjacent states, is becoming more evident every week. There are between 800 and 900 motorists in Washington, and the promoters are awakening interest in the project by personal interviews with those whom it is desired to have identified with the club. One of the propositions is to have a clubhouse on one of the roads leading out of the city into Maryland or Virginia.



The executive committee of the National Association of Automobile Manufacturers, Incorporated, held its regular monthly meeting at the rooms of the association, 7 East Forty-second street, New York, on Wednesday, November 2, fourteen members being present out of a total membership of fifteen.

The show committee reported that sanctions for shows had been refused the Automobile Club of Springfield, Mass., and the Automobile Club of St. Louis, Mo., and that agreements had been reached between the clubs and the dealers' associations in Buffalo and Cleveland, to whom sanctions will be granted shortly.

The freight committee regretted to report that the railway Official Classification Committee had refused its application for a reduction of freight rates on automobiles. The freight committee was thanked for its efforts and dissolved.

The association's counsel, Mr. Terry, submitted the opinion that it was contrary to the Federal constitution and to the constitutions of many of the States to require automobilists to take out state, township or county licenses. As the committee did not feel inclined to urge the abolition of all licensing, however, the matter was referred back to Mr. Terry for an opinion as to whether a license issued in one state must be recognized in other states.

General Manager Samuel A. Miles reported that the allotment of space at the New York and Chicago shows had been commenced, but would not be completed before the middle of next week. Announcement of the disposition of space will be made a few days thereafter.

The Commercial Motor Vehicle Company, of Detroit, Mich., was admitted to membership in the association.

The January meeting of the executive committee will be held at Madison Square Garden on Tuesday, January 17, during show week, and the annual meeting will be held on the following day, Wednesday. The annual banquet will be held in the same week, and will be in charge of a committee to be appointed by the president of the association.

* * *

George Arents, Jr., the young millionaire who was injured in the Vanderbilt Cup race, was removed from the Nassau County Hospital, Mineola, a short time ago and taken to the Garden City Hotel. His memory and reasoning faculties are somewhat affected at present by the clot of blood which presses on his brain; but the physicians expect that this will dissolve in time and entirely relieve the condition.

* * *

There will be an automobile race meet at the Empire track, Yonkers, N. Y., on November 8, election day, the star event of which will be a special match race between Maurice G. Bernin, driving W. Gould Brokaw's 60-horsepower Renault, and Paul Sartori in A. G. Vanderbilt's 90-horsepower F.I.A.T. The track is in fine condition for racing owing to the work done on it for the meet on October 29. In addition to the match race there will be a one-mile handicap race for gasoline cars selling for less than \$1,000; a two-mile open race for American touring cars; a two-mile race for the amateur championship cup; the five-

mile Empire handicap, and the popular International handicap which will be run in heats of three miles, and a final of five miles, a heat for each country represented. It is possible that Edward Hawley will drive E. R. Thomas's 90-horsepower Mercedes in the International, and also in a record trial.

* * *

Eagle Rock Hill is a lively mile of road on fine days, Sundays in particular, many automobilists who have entered or intend to enter for the hill climbing contest on November 24 taking practice runs and getting a line on the ascent. Those who attack the hill have to do so almost from a standing start, as there is a very bad gully only a few yards from the commencement of the grade, and it is impossible to take a run at the hill. The Automobile Club of New Jersey, which is promoting the meet, will have this remedied in time for the contest, however, and other minor objectionable features will be removed. It has been decided that contestants will be given only one trial, though a number have asked for two. With the large entry expected this would be impossible. Entries may be made with C. H. Gillette, secretary of the club, 31 West Forty-second street, New York.

* * *

The Y. M. C. A. course in automobile instruction promises to be a decided success. The applicants up to November 1 numbered about 80, and a postponement of the opening, which had been set for October 31, was made necessary owing to the inadequacy of class arrangements. A large proportion of the applicants for instruction are young men who expect to become professional chauffeurs.

* * *

One of the features of automobile race meets, and one that was particularly noticeable at last Saturday's meet at the Empire track in Yonkers, is the fact that the band generally butts in and commences to bray just as the announcer is performing a megaphone solo, and all hands, the newspaper men in particular, are stretching their ears to the utmost to catch the times. The things the reporters said about the musicians were not of a complimentary nature, and did not bear on musical matters.

* * *

Chief Croker, of the New York Fire Department, had a narrow escape from injury while going to a fire in his automobile early in the morning of October 31. The car was running at high speed, when a hole in the road was struck. The force of the rebound was so great that the chief was shot into the air, and only missed being thrown into the street by the narrowest margin. He was considerably shaken up, but recovered in a few minutes.

* * *

The R. E. Hardy Co., formerly known as the Detroit Motor Works, has removed to New York City, where it has secured a location in the downtown business district at 225 West Broadway, near Franklin street. The original company was incorporated in July, 1900. It now has a line of twenty-one different sizes of Sta-Rite spark plugs, a gasoline gauge, spark coils, timers, dynamos and other specialties.

A meeting was held in Bretton Hall, Broadway and Eighty-sixth street, New York, on the evening of October 29 to discuss the proposition to organize an automobile club in New York which should be run on popular lines, with nominal initiation fees and dues. S. A. Miles was appointed temporary chairman and L. R. Smith temporary secretary, and the New York Motor Club was agreed to as a name. It was decided to issue a general call for a meeting to be held on Wednesday, November 9, to go more deeply into the matter. A suite of rooms on the top floor of Bretton Hall was offered for use as a club home by J. D. Price. Those present were "Senator" Morgan, R. L. Lounsbury, W. C. Conklin, A. Scheller, Isaac B. Potter, J. Eustace, J. D. Price, E. T. Horsey, J. S. Smith, Walter Wardrop, J. M. Capels, E. V. Stratton, Frank J. Griffin, John C. Wetmore and Ed. Spooner.

* * *

The Park Commissioners of New York City have posted notices on Riverside Drive announcing a reduction of speed to 8 miles an hour from Seventy-second street to One Hundred and twenty-eighth street. The former maximum speed allowed on Riverside Drive was 10 miles an hour, the same as in the ordinary city streets, but the Commissioners have taken advantage of their powers to regulate speed in the park system, to which Riverside Drive belongs, to make the reduction.

* * *

The regular Tuesday evening meetings of the Automobile Club of America will be resumed at the club house, 753 Fifth avenue, New York, on Tuesday evening, November 15. It was at first intended to hold the first meeting on November 8, but this was afterward changed to the later date. The subject for the lecture, which is always a feature of these assemblies, will be announced later.

* * *

The New York City garage of the Pope Manufacturing Company, which is now under construction on Broadway between Fifty-fifth and Fifty-sixth streets, will have a capacity of 168 machines in addition to those in the salesrooms. The building will be ready for occupation about the first of the year.

* * *

Théry and Caillois, the Richard-Brasier drivers, are booked to leave for France this week, though it was hoped they would stay over for the race meet at the Empire track on the following Tuesday. Both expect to return and take part in the Ormond Beach automobile tournament in January.

* * *

Hollander & Tangeman, American agents for the Italian F.I.A.T. cars, have added to their establishment the adjoining building. The partition walls have been torn down and when all work is completed the firm will have plenty of room for both garage and offices.

* * *

A. L. Picard has resigned his connection with the American Darracq Company, New York City, and has accepted the sales management of the Walter Car Company, of the same city. The company will establish a garage at Fiftieth street and Broadway.



Among the legislative matters that will be called up early in the next session of Congress are the Boutwell bills reducing the tax on pure grain spirits from \$1.10 to 70 cents a gallon and granting free methylated alcohol for industrial purposes. Automobile manufacturers and users are interested in these two measures, and it is expected that the trade will join with other industries in urging Congress to enact the desired legislation. Alcohol is used extensively in the automobile industry, while the increasing price of gasoline suggests alcohol as a fuel for internal combustion engines if the tax is removed.

Minneapolis automobile dealers tried conclusions last Monday afternoon on the State Fair Ground track, and G. W. Caplin, in his 35-horsepower Royal, was an easy winner. The race was for ten miles, which Mr. Caplin covered in 12:40 1-5. He was nearly three-quarters of a mile in the lead of A. C. Bennett's 20-horsepower Winton. Ralph Bayle, in a 22-horsepower Packard, was third; L. H. Fawkes' Rambler, fourth, and W. G. Benz, in a Ford, fifth. The Royal took the lead from the start, and increased it with every mile. The most interesting fight was for second and third positions.

The Winton Motor Carriage Company has made formal announcement of its line for next season. There will be four cars in the line—a 40-horsepower car at \$4,500, a 40-horsepower car at \$3,500, a 24-horsepower car at \$2,500, and a 16-horsepower car at \$1,800. All of the cars will be fitted with four-cylinder motors of the vertical type, in contrast to the two-cylinder horizontal motors which the company has always advocated heretofore. The \$4,500 and the \$3,500 models will resemble each other mechanically, but the higher-priced car will have a special body and improved fittings.

José Belin, who has been manager of the Automobile Garage and Repair Company of Cleveland, has resigned his position and will go into business for himself. He will have an establishment on Canal street, where he will handle a number of French specialties, and will also manufacture several articles of his own design. Mr. Belin has been appointed instructor of a class of automobile engineering in the local Y. M. C. A. course. More than fifty young men have taken up the course, indicating the amount of interest in this subject in Cleveland.

The assessment on automobiles in Minnesota has been raised by the State board of tax levy 33 1-3 per cent. This increases the average valuation in the State from \$479.52 to \$636.96. The assessment in Ramsey county, in which St. Paul is located, was raised from \$309 to \$463.50. The returns show 374 automobiles in Minneapolis and ninety-four in St. Paul. In considering St. Louis county it was found that there were nine automobiles in Duluth. The average assessment of \$331.25 was raised 25 per cent.

The October number of *The Launch*, a house organ published quarterly by the Truscott Boat Mfg. Co., of St. Joseph, Mich., contains some well illustrated and interesting articles. Among them is the narrative of a launch tour of sixty miles through a chain of beautiful lakes and small rivers, from Cheboygan to Oden, Mich., an announcement of the company's intention to place in the market next season three sizes of auto-boats of a type intermediate

between the racing boat and the family pleasure launch; reviews of the season's auto-boat racing in home waters and abroad, a double-page halftone engraving from a photograph of the boats in the Transportation Day parade at the St. Louis Fair, and some useful hints on gas engines and the care of a launch.

The first car turned out by the new Reo Car Co. (first organized as the R. E. Olds Co.) in its temporary factory in Lansing, Mich., was completed last week and tested by Mr. Olds, who expressed himself as being pleased beyond expectation with its performance. The car has a 16-horsepower engine and weighs only 1,400 pounds, it is said, although the aim of the builders was to produce a car with one horsepower for every 100 pounds. The new Reo car is built along French lines and, Mr. Olds states, "climbs a hill like a skyrocket."

An unprecedented drouth in Tennessee has covered the fine limestone turnpikes with several inches of blinding, choking dust and has made motoring small pleasure. Every car that leaves Nashville returns with a white coating of dust which is alike destructive to temper and machinery. Motorists and farmers have found a common cause at last. A treatment of crude oil such as the Vanderbilt race course had would be welcomed by all.

A five-ton electric truck with a carrying capacity of 7 1-2 tons of flour, has been put into service in Minneapolis by the Pillsbury Company, probably the largest flour milling concern in the world. This truck, which was bought through the Pence Automobile Company, local agents for automobiles, was put into service October 22, and marked the introduction into the northwest of the latest and most approved means of handling merchandise in large quantities in the city.

The Diamond Rubber Co., of Akron, O., has opened a branch at 611 First Avenue S., Minneapolis, where W. E. Roby will be in charge, and another at 3966 Olive street, St. Louis, under the management of R. L. McCrea. The new stores were opened about November 1, and will carry complete stocks of Diamond tires.

The Packard Electric Co., Ltd., of St. Catharines, Ont., is erecting a new automobile plant in that city, which it expects to have in operation by the first of the year. It will be given a fixed assessment by the municipality, for which it agrees to employ a minimum of fifty hands and pay \$25,000 annually in wages.

The Locomobile Company of America reports that a large amount of money is being invested in new machinery to enable the plant to handle work promptly. The additional machine tools include gear cutters, screw-cutting machines, cylinder boring machines, valve grinders and forging machinery.

The Wilson & Todd Manufacturing Company has removed from its original location at 246 Jefferson avenue, Detroit, to 12 and 14 Sherman street in that city.

Dr. John C. Robinson, of Wilmington, Del., who purchased a new touring car recently, made a round trip last Friday, between Wilmington and Philadelphia, without making any stops en route, covering the distance (26 miles each way) in about four hours' actual riding time. The road between Wilmington and Philadelphia is

very hilly and rough in places, and it is necessary to run through Chester, where the speed limit is very low.

Frank H. Stolp, who on September 1 resigned the general managership of the Long Manufacturing Company, of Chicago, Ill., has organized a company called the Stolp Manufacturing Company, of Chicago, with headquarters at the northwest corner of Huron and Townsend streets. The object of the firm will be the manufacture of a wired cooler tubing invented by Mr. Stolp. The company expects to have goods on the market in a very short time.

Lack of storage room at the Broad Street headquarters of the Philadelphia branch of the Thomas B. Jeffery Company has necessitated the leasing of a large warehouse at Twenty-seventh and Thompson streets. This depot will be used as the distributing point for Rambler automobiles throughout Pennsylvania, New Jersey and Delaware, the present quarters being retained for sales and exhibition purposes.

The business formerly conducted by Harry R. Geer, "The Motorcycle Man," of St. Louis, Mo., will hereafter be carried on under the name of the Harry R. Geer Company, on the same lines and under the same management. This concern makes a specialty of motorcycles and supplies, both as manufacturers and jobbers.

Nashville, Tenn., now has a law requiring the use of large and legible numbers on automobiles. The Nashville Automobile Club offered no objections to the law, as the committee of the city council which framed it accepted a number of suggestions from a prominent attorney who is an enthusiastic motorist.

The Haynes-Apperson Company, Kokomo, Ind., states that its two-cylinder car was the only two-cylinder machine at the St. Louis Exposition to receive a gold medal, and for that reason the award is considered particularly valuable.

We are informed by the Locomobile Company of America that two Locomobile touring cars have been employed for campaign work by the Republican candidate for the governorship of Illinois, who has been enabled to do a large amount of extra work with their aid.

The Whitlock Coil Pipe Company, Hartford, Conn., is preparing to increase the floor area of its factory by about 20,000 square feet, this having been made necessary by the increased volume of automobile cooler business.

The Timken Roller Bearing Axle Company, Canton, O., states that its bearings were awarded a gold medal at the St. Louis Exposition for the best anti-friction bearings for automobile axles.

Oakes & Dow Company, 40 Ludbury Street, Boston, Mass., has made an improvement in the Comet spark plug, and the new design can now be delivered in quantities.

The Marion automobile will be represented in Philadelphia by Neill Wolfe, who has opened an agency at 215-217 North Broad Street.

The Oleo spark plug is being imported direct from the manufacturers by the Angier Company, 43 Columbus Avenue, Boston, Mass.

THE AUTOMOBILE

WEEKLY

NEW YORK—SATURDAY, DECEMBER 3, 1904—CHICAGO

10 CENTS

FOURTH ANNUAL EAGLE ROCK HILL CLIMB.

SIXTEEN and three-quarters seconds were cut off of last year's record up Eagle Rock hill last Thursday. Public sentiment regarding the result of the day's sport was divided between regret that William K. Vanderbilt, Jr., who made the record of 1:36 3-4 last year, should have lost first place this year by three-fifths of

1:20 flat, or at the rate of forty-five miles an hour. Vanderbilt, with his 90-horsepower Mercedes, probably would have made as good time had he not skidded badly on the sharp turn at the top of the hill, where his car swung around nearly at right angles to the road. A quick appreciation of the danger and a sudden twist of the steering

lent performances of the three F. I. A. T. cars entered by William Wallace, A. G. Vanderbilt, and Hollander & Tangeman, and driven respectively by Mr. Wallace, Sartori and Emanuel Cedrino. In the eighth event, for gasoline cars costing more than \$5,000, these cars ran one, two, three, and in event No. 9, for gasoline cars weigh-

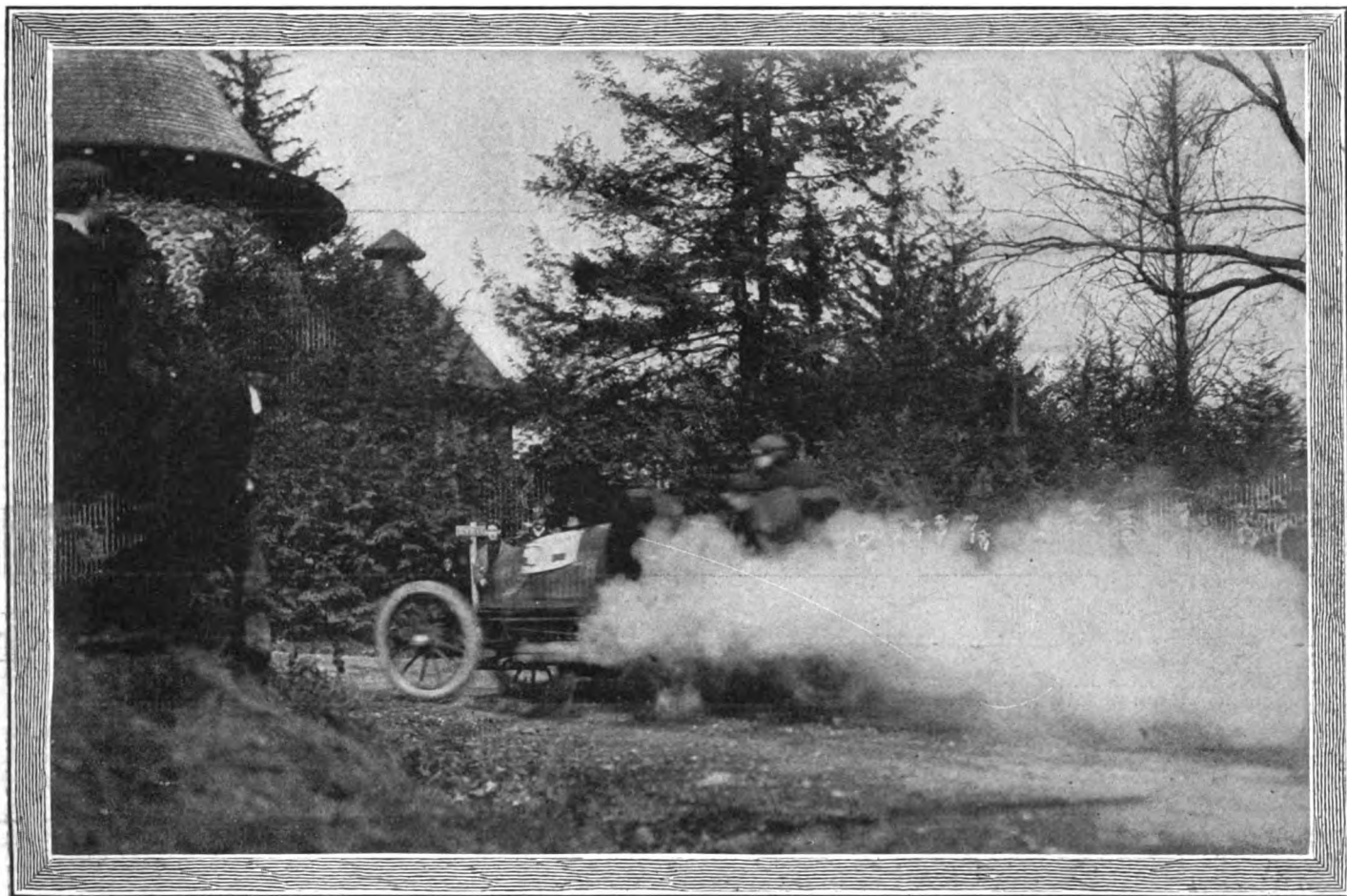

MAURICE BERNIN, IN W. G. BROKAW'S 60-H. P. RENAULT, TAKING FIRST SHARP TURN NEAR TOP OF HILL.—TIME FOR MILE, 1:20.

a second, and gratification that Maurice Bernin, who had had bad fortune in the Vanderbilt Cup race in October with W. G. Brokaw's 60-horsepower Renault, should have succeeded in demonstrating both his own ability as a road driver and the speed and power of the new Renault. Bernin's time for the tortuous mile course up the grade varying from 0 to 17 per cent was

wheel righted the big machine in its course, and no harm resulted.

Paul Sartori and William Wallace, both with their Vanderbilt Cup 90-horsepower F. I. A. T. cars, also skidded dangerously on the turns, despite which they made the excellent times respectively of 1:22 1-5 and 1:22. One of the striking features of the occasion, indeed, was the uniformly excel-

ing 1,432 to 2,204 pounds, they ran third, fourth and fifth in the same order.

More notable still were the performances of Webb Jay, in a 15-horsepower White steam car of the regular stock pattern for 1905, stripped down. With this car Jay not only cut down to 1:28 2-5 the record for steam cars of 2:42, made by W. J. Stewart with a Locomobile in 1902, but entering in

the event for Class A gasoline cars, made the fifth best time in the event—1:23 2-5—beating the times of six other cars, ranging in power from a 24-horsepower Pope-Toledo to Frank Croker's 75-horsepower Simplex. The White lists at \$2,500, while some of the cars whose times it beat cost from \$10,000 to \$15,000. In justice to Frank Croker, however, it is but fair to state that his car skidded badly on the turns.

LIMITATIONS OF COURSE REACHED.

The skidding of the big 75 and 90-horsepower cars clearly demonstrated that Eagle Rock hill is hardly a suitable course for testing the hill-climbing powers of the highest types of automobiles. The right angle turn about midway up the hill and the still sharper S turn just at the top, make it impossible to take the entire course at top speed; each of the drivers of these huge cars had to shut off on these two turns, so

way from the bottom to the top, more than 10,000 persons congregating by 9 o'clock to see the beginning of the sport in which nearly three dozen competitors took part. The first contest was held on Election day, 1901. The best ascent was made by W. J. Stewart in a Locomobile steamer in 2:43, and the second best by Charles E. Duryea in a Duryea gasoline car in 3:54 1-3.

Owing to the difference in classification and the changes in the conditions for the contest, comparison of the times made this year with those formerly existing is impossible except in a few cases, as follows:

ELECTRIC, ALL PRICES.					
Record.	Car.	H.P.	Best time.	Car.	H.P.
1903. 6:38 1-4	Columbia	8	1904. 4:22 3-5	Torbensen	3
STEAM, ALL PRICES.					
1902. 2:42	Locomobile	—	1904. 1:23 2-5	White	15
GASOLINE, MORE THAN \$3,000.					
1903. 1:36 3-4	Mors	30	1904. 1:20	Renault	60

horsepower runabouts which climbed the grade with two persons aboard on the high gear in 3:06 1-5 and 4:33 2-5 respectively, and of the low priced cars of 12, 15 and 22-horsepower that carried two persons up the mile hill in from 2:18 2-5 to 2:41 4-5—all in shorter time than any of the 12 to 40-horsepower cars costing not more than \$3,000 and carrying four passengers. It was surely a great demonstration for the low priced and moderate powered American machine.

CROWD NEARLY SPOILS CONTEST.

Only the skill of the drivers, extremely good luck and the agility of the average American in extricating himself quickly from a position of great danger, prevented serious and perhaps fatal accidents. The slight respect which the thousands of spectators who crowded the turns showed for the first few cars that made the ascent soon wore away and the people pressed in closer

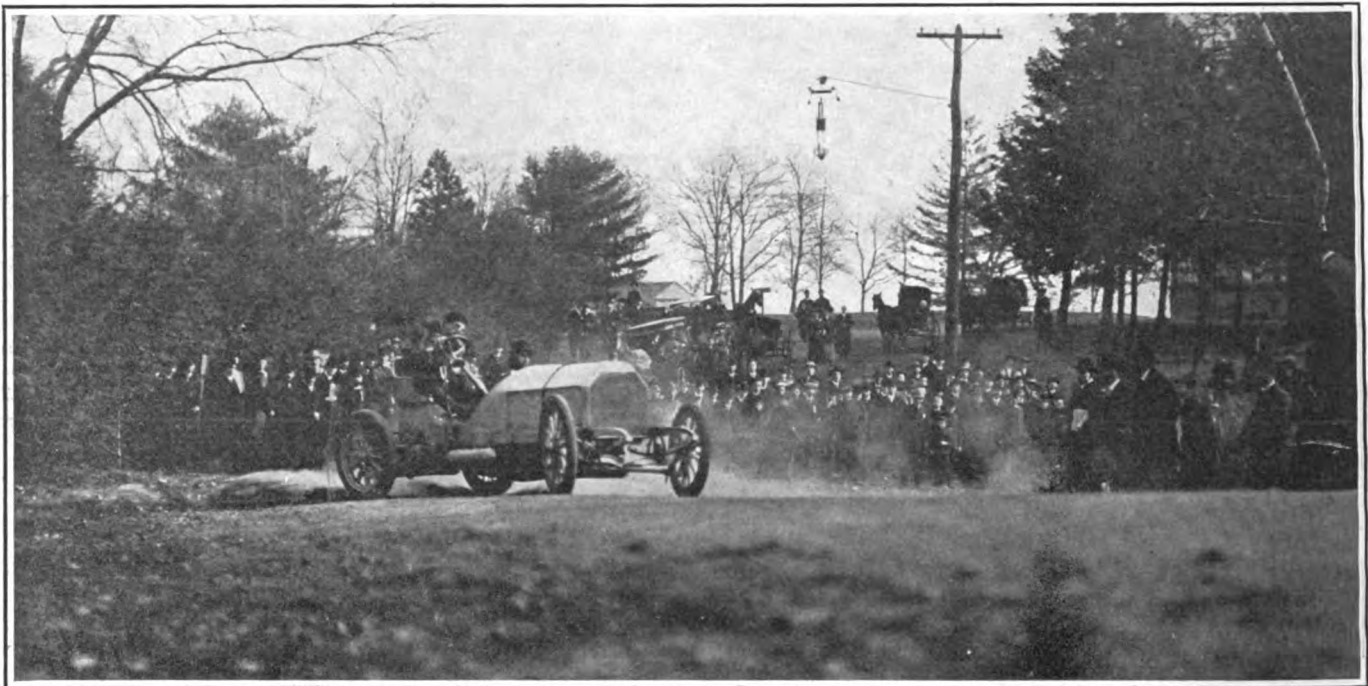

W. K. VANDERBILT, JR., IN 90-H. P. MERCEDES, DEXTEROUSLY RECOVERING FROM A BAD SKID ON TURN NEAR TOP.—TIME, 1:20 3-5.

the Eagle Rock course has, since the inception of this annual event four years ago, come to be more of a test of driving skill than of the improvement in automobiles. The limitations of this course, which only a few years ago was considered a most difficult grade, have been reached this year, and recognizing this fact, and also having grown weary of the tactics of the town council of West Orange in placing impediments in the way of the contest at the eleventh hour, the officers of the promoting club, the Automobile Club of New Jersey, have practically decided to hold next year's contest in some other locality, on a steeper, straighter hill.

Each year the Eagle Rock hill climb has increased immensely in popularity. Whereas four years ago only a few hundred spectators turned out to see a dozen cars laboriously climb the hill, the course was lined three or four deep this year all the

In former contests the cars were all permitted to be stripped except in the class for touring cars of all prices last year, in which the competing machines were required to be equipped in touring condition, but were not required to carry any passengers. This year all cars competing in events Nos. 3 and 4 had to carry one passenger besides the driver, and in events Nos. 5, 6 and 7 were obliged to carry three passengers in addition to the operator.

It was a matter of general regret that the cars and drivers who made the best performances last year were absent this year—as the Stevens-Duryea and Otto Nestman, and the Phelps and L. J. Phelps, who have been very successful in hill work.

SUCCESS OF MODERATE PRICED CARS.

Especially noteworthy were the performances this year of the American 6 and 8¼-

and closer upon the roadway until a lane barely a dozen feet wide in places was left. Onlookers crossed and recrossed even this narrow passage constantly, and the whole police force of West Orange (consisting of seventeen policemen and their chief) was powerless to keep the roadway safely clear. There were a number of very narrow escapes.

Finally, about noon, the conditions became so hazardous that the officials at the top of the hill telephoned down to the start for an officer to keep the crowd back, and H. W. Whipple and Clerk of the Course Gillette took a policeman up in Mr. Whipple's car, the trials being suspended until their return. When they came down, Mr. Whipple, who was greatly excited, announced to the chief of police and to Referee Pardington, Judge W. C. Temple and Timer S. M. Butler, that it was impossible to continue the contest and



JAMES L. BREESE PASSING FINISH STAND AT TOP OF EAGLE ROCK HILL IN HIS 40-H.P. MERCEDES.

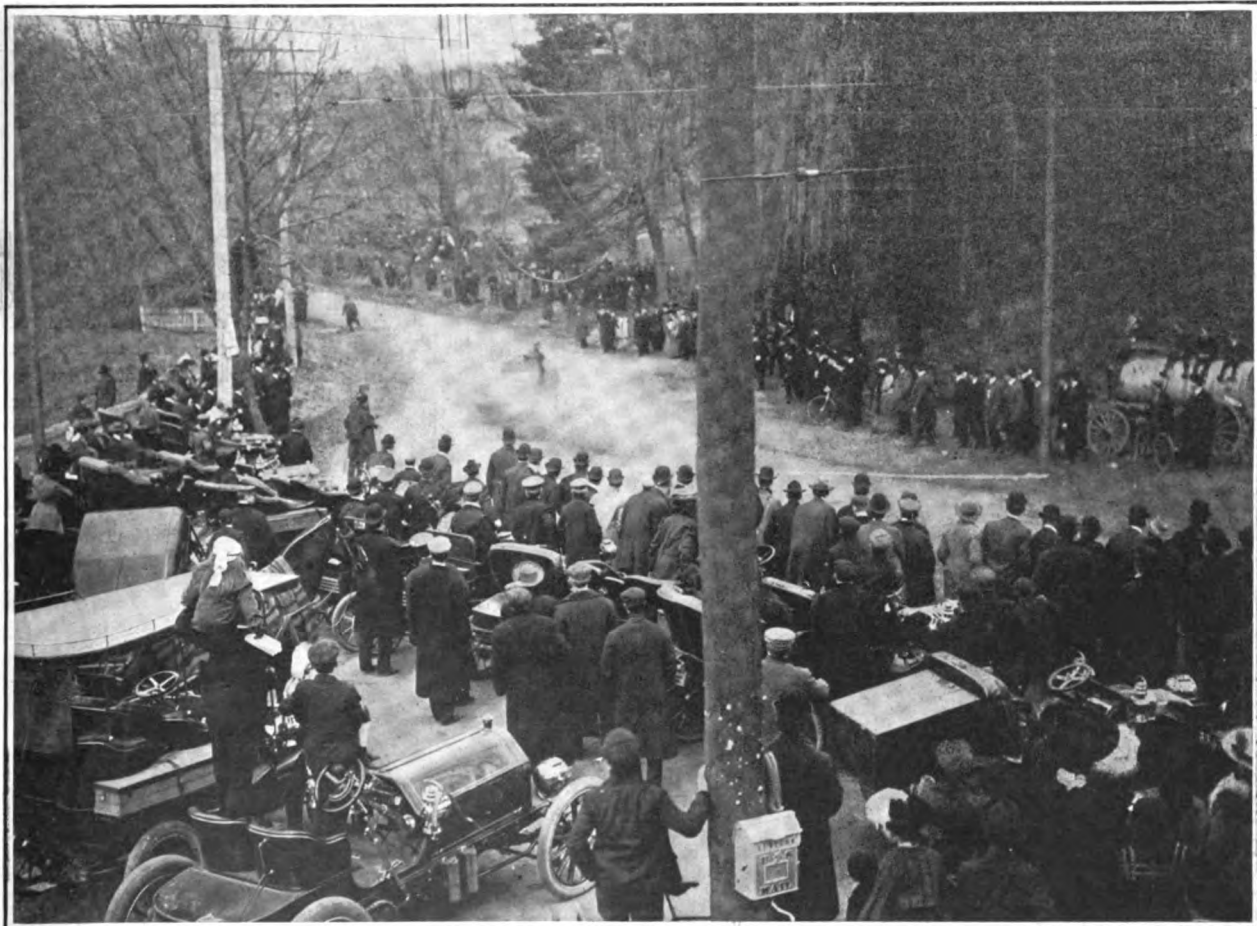

SPECTACULAR START AT FOOT OF THE HILL—CROSSING THE TAPE ON AN S CURVE AND SKIDDING IN LOOSE DIRT.

that so far as he was concerned it should be called off. There followed half an hour's delay while the chief of police and his force, supplemented by the appeals to the spectators of the officials of the contest, tried to clear the roadway under threats of stopping the racing. The matter was then left to Referee S. A. Miles, at the top of the hill, to decide whether to go on or call the rest of the program off. Mr. Miles telephoned down to send up one more car, and if the people did not keep back for it to abandon the trials. So William Wallace was sent up in his 90-horsepower F. I. A. T. at 12:18 o'clock. He reported to the officials at the finish that the way was safe, so Webb Jay in the White, James L. Breese in his 40-horsepower Mercedes, Guy Vaughan in a 40-horsepower Decauville and a number of other drivers in large and fast cars were sent up, followed by several attempts with motor cycles that concluded the program for the day at about 1 o'clock.

The weather throughout was magnificent, and the road in good condition with the exception of the turns, where there was considerable loose gravel.

ONLOOKERS IN THE DARK.

Owing to the irregular arrival of cars at the start, the contest was run in a disorganized way, neither the events nor the contestants being started in catalogue order. Whenever a contestant was ready to make an ascent and the course was reported clear, he was sent away. To add to the difficulty of following the course of events and of knowing how the competitors stood at any stage of the proceedings, not more than half of the onlookers were able to secure programs, and no times were announced or even given out. The reason for not announcing the times was, it is explained, be-

cause of the possibility that the police might interfere on the ground that the speed was illegal.

The movement of the large crowd which gathered to witness the contest can be likened to the tide, which, coming in from the ocean, flows up a river, losing part of its volume in each creek and pool along the way until it gradually comes to rest, and then retraces its course back to the ocean. So the crowd on Thursday wended its way up Eagle Rock hill during the early hours of the contest while the small cars were

struggling to reach the top, grew smaller and smaller as different ones settled in places offering a good view of the course, until it finally came to rest while the big cars tore up the ascent. Then, without waiting for the culmination of the contest, this human tide flowed back down the course, to scatter to numerous homes where Thanksgiving turkeys awaited sharpened appetites. It was more than evident that a large majority of the people present came to see the big racing machines make the ascent and were not interested in the performances of the other contestants.

The crowd took possession of the course and held to it tenaciously. Even when the big cars roared up the hill at a fifty-mile clip the road would be blocked with people hardly 100 yards ahead. The united efforts of the dozen police and the score or more of official clerks who were stationed all along the course with red flags and megaphones were insufficient to control the crowd, and Mr. Whipple's rather dubious personal appeal, as he rode up and down the hill in an automobile, threatening to stop the contest, were of no avail.

COMPOSITION OF THE CROWD.

The composition of the crowd was interesting. There were hundreds of persons from New York city, and it seemed as if all of the Oranges, Newark, and other neighboring places had turned out *en masse*. Several hundred automobiles were parked along the course and almost as many stylish horse-drawn vehicles lined up on the cross roads. Nearly fifty women and men rode to the hill on horseback, but only a few were able to watch the competing cars, the others being fully occupied in keeping their mounts from climbing the hillsides when a car with its muffler disconnected was within hearing.

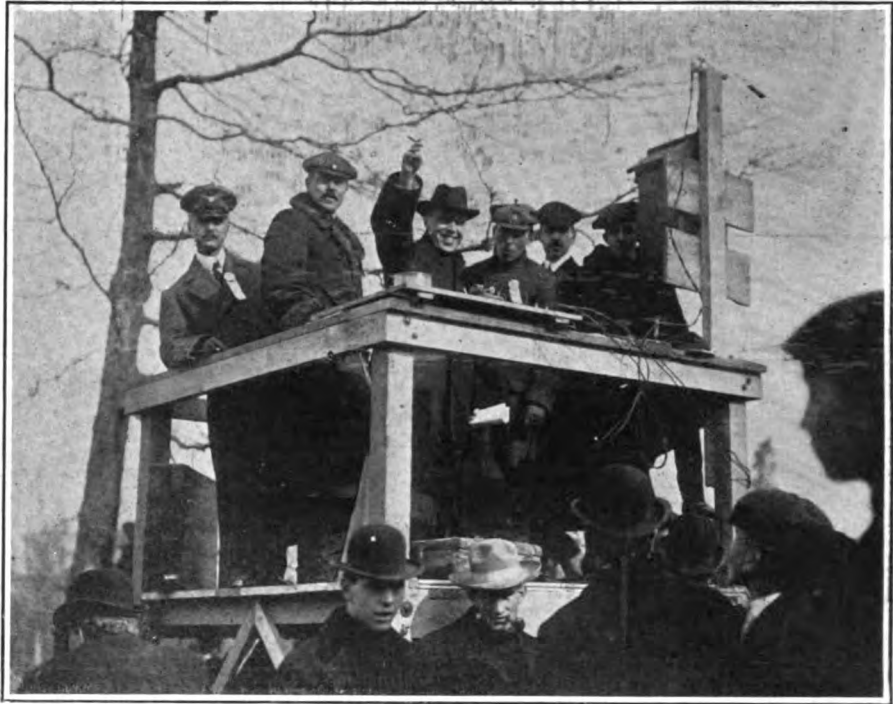

REFEREE MILES AND JUDGES AND TIMERS IN STAND AT FINISH LINE.



HEADQUARTERS AT FOOT OF HILL—OFFICIALS IN VERANDA BALCONY CAN SEE TAPE SHOWN ON PRECEDING PAGE.

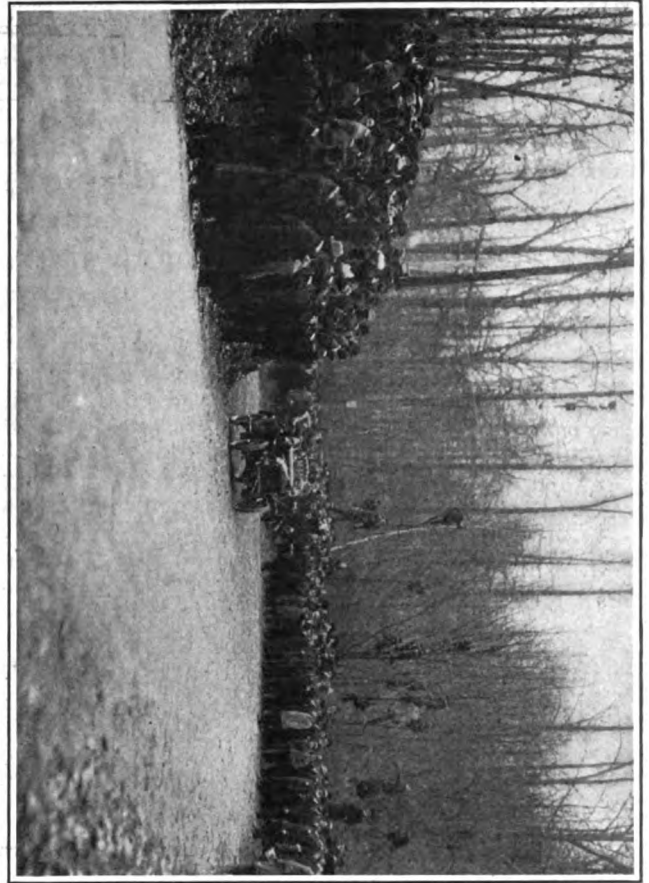

M. H. Roberts in Thomas Flyer, Taking Halfway Turn with Three Passengers. Time, 2:42 4-5.

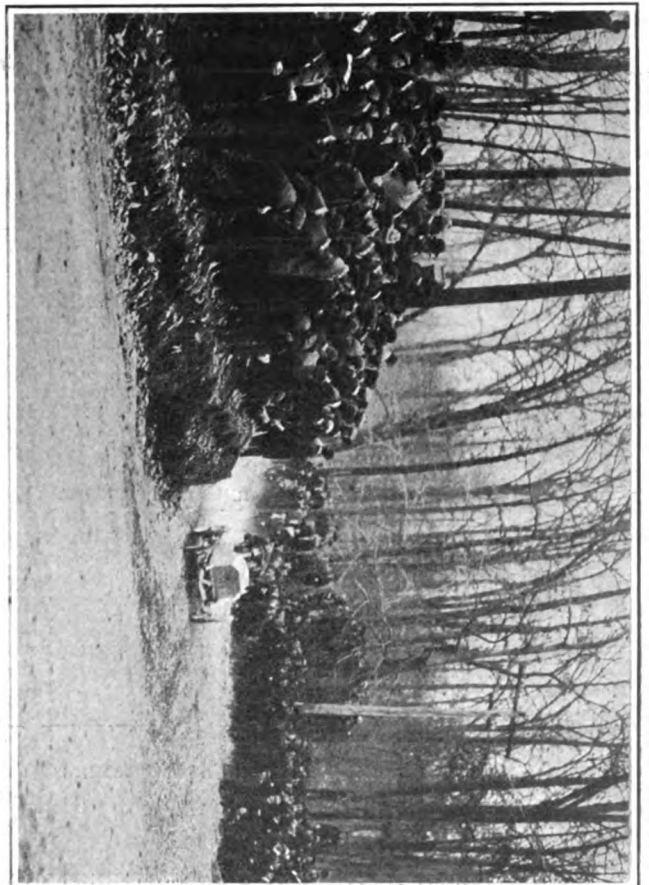

Vanderbilt Negotiating Same Right-Angle Turn in His 90-H. P. Mercedes Time 1:20 3-5.

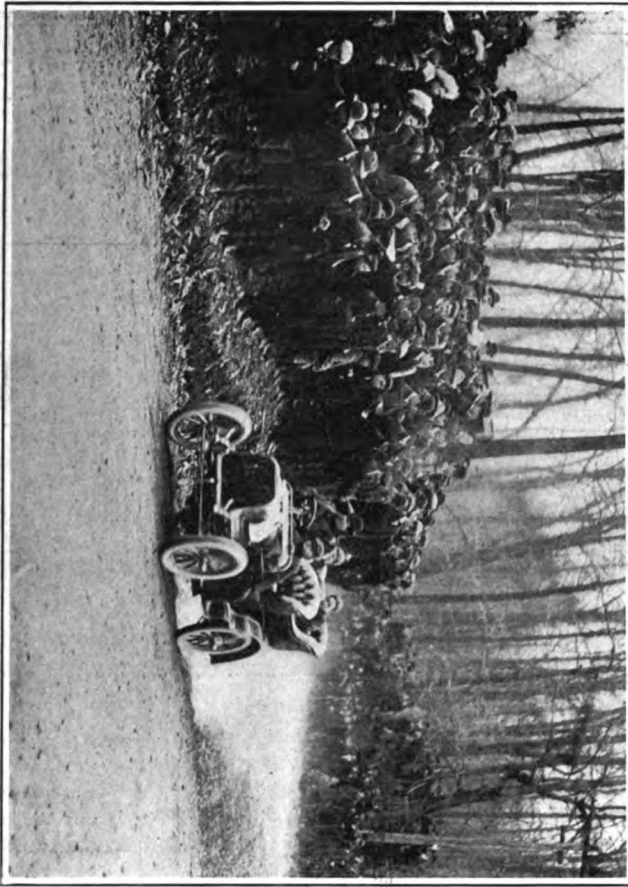

R. E. Fulton, in 24-H. P. Pope-Tolado, Cutting Corner Close in Tourist Event
BIG RACING AND TOURING CARS NEGOTIATING THE DIFFICULT TURNS OF EAGLE ROCK HILL COURSE, THANKSGIVING DAY, NOVEMBER 24.

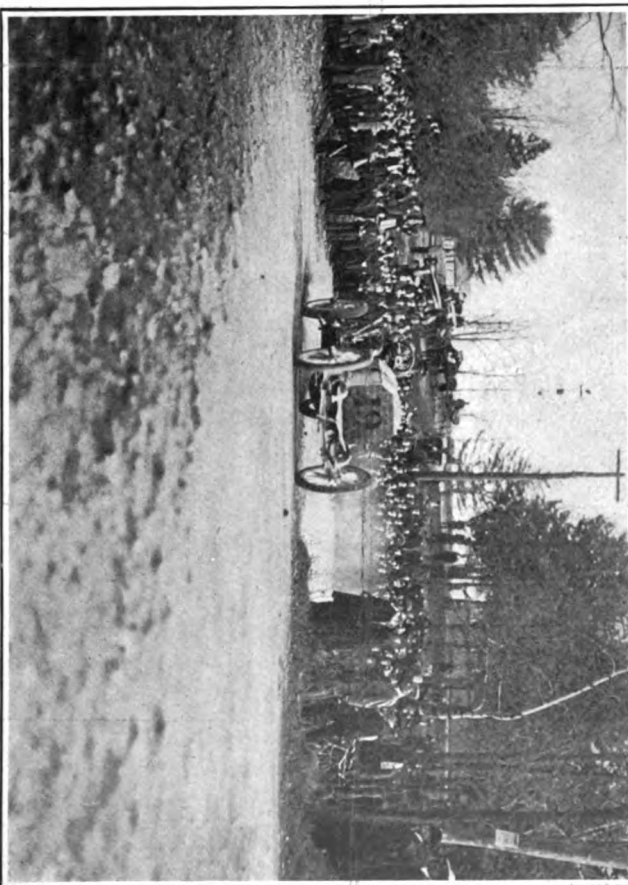

William Wallace, in 90-H. P. F. L. A. T., Making Upper Turn on S Curve. Time, 1:23 4-5.

Scores of bicycles were seen along the course. Near the top of the hill a dozen hunters, with beagles and setters in leash and with shotguns under their arms smoked big pipes and watched the ascents of the different cars with interest. Evidently there was little hunting in that vicinity on Thursday, and one old hunter said, as one

of the nineties flew by with a bang and roar: "You couldn't find a bird within ten miles of that noise."

All of the racing cars shut off their power on the two worst turns. Frank Croker, in his first ascent, had a very close escape from a serious accident on the lower turn. His car skidded badly and he drove

COMPLETE SUMMARY OF EAGLE ROCK HILL CLIMBING TRIALS, THANKSGIVING DAY, NOV. 24.

EVENT NO. 1—ELECTRIC STOCK CARS, ALL PRICES.					
Car.	Price.	Weight.	H.P.	Driver.	Time.
Torbensen	\$2,000	2,100	3	J. W. Aylesworth	4:22 3-5
Columbia	H. W. Ewbank	5:23 3-5
EVENT NO. 2—STEAM STOCK CARS, ALL PRICES.					
White	2,500	1,415	15	Webb Jay	1:28 2-5
Prescott	1,000	7 1-2	E. J. Foley	1:52 2-5
Stanley	700	800	10	Edwin Shuttleworth	4:27 3-5
EVENT NO. 3—GASOLINE CARS COSTING NOT MORE THAN \$850. CARRYING TWO PASSENGERS.					
Oldsmobile	650	900	6	George Paddock	3:06 1-5
Cadillac	800	1,400	8 1-4	C. C. Henry	4:33 2-5
EVENT NO. 4—GASOLINE CARS COSTING \$850 TO \$1,250. CARRYING TWO PASSENGERS.					
Buick	1,200	1,700	22	H. J. Koehler	2:18 2-5
Duryea	1,200	800	12	C. A. Kohl	2:33 2-5
Elmore	1,050	1,400	15	H. L. Newton	2:41 4-5
Elmore	1,050	1,400	15	H. B. Patton	2:45 3-5
Buckmobile	1,400	15	A. F. Robinson	3:52 1-5
Torbensen	1,100	1,400	12	Vigo Torbensen	4:25 4-5
Franklin	1,250	1,100	10	W. H. Bex	5:03 1-5
Rambler	1,700	16	Arthur Gardner	5:25 1-5
EVENT NO. 5—GASOLINE CARS COSTING \$1,250 TO \$2,000. CARRYING FOUR PASSENGERS.					
Columbia	1,750	1,800	14	H. W. Alden	3:14 2-5
Franklin	1,650	1,250	12	W. H. Bex	4:03 3-5
Rambler	1,700	16	Arthur Gardner	4:13 2-5
EVENT NO. 6—GASOLINE CARS COSTING \$2,000 TO \$3,000. CARRYING FOUR PASSENGERS.					
*Thomas Flyer	3,000	2,500	40	M. H. Roberts	2:42 4-5
*No other competitor.					
EVENT NO. 7—GASOLINE CARS COSTING \$3,000 TO \$5,000. CARRYING FOUR PASSENGERS.					
Walter	4,000	2,400	24-30	W. Walter	1:54 2-5
Pope-Toledo	3,500	2,350	24	R. E. Fulton	2:15 4-5
Matheson	5,000	2,880	24	C. R. Greuter	2:21 4-5
Columbia	4,000	30-35	Harry Sendall	2:53 4-5
Desberon	3,500	2,200	30	S. T. Stinzing	4:29 1-5
EVENT NO. 8—GASOLINE CARS COSTING MORE THAN \$5,000.					
F. I. A. T.	16,000	2,000	90	William Wallace	1:23 4-5
F. I. A. T.	16,000	2,204	90	Paul Sartori	1:24 1-5
F. I. A. T.	13,500	2,000	60	Emanuel Cedrino	1:24 4-5
Mercedes	10,000	2,203	90	W. K. Vanderbilt, Jr.	1:26 3-5
Simplex	15,000	2,204	75	Frank Croker	1:29 2-5
Mercedes	2,000	60	George H. Flint	1:38 1-5
Mercedes	11,000	40	James L. Breese	1:43 3-5
EVENT NO. 9—CLASS A GASOLINE CARS WEIGHING 1,432 TO 2,240 POUNDS.					
Renault	2,200	60	Maurice Bernin	1:20
Mercedes	2,203	90	W. K. Vanderbilt, Jr.	1:20 3-5
F. I. A. T.	2,000	90	William Wallace	1:22
F. I. A. T.	2,204	90	Paul Sartori	1:22 1-5
White	1,415	15	Webb Jay	1:23 2-5
F. I. A. T.	2,000	60	Emanuel Cedrino	1:29 1-5
Simplex	2,204	75	Frank Croker	1:32 3-5
Mercedes	2,000	60	George H. Flint	1:33 1-5
Mercedes	40	James L. Breese	1:39 3-5
Pope-Toledo	24	A. P. Heyer	1:43 3-5
Desberon	2,000	30	S. T. Stinzing	2:09 4-5
EVENT NO. 10—CLASS B CARS WEIGHING 851 TO 1,432 POUNDS.					
Decauville	1,370	40	Guy Vaughan	1:37 1-5
Prescott	1,000	7 1-2	E. J. Foley	1:37 3-5
White	1,415	15	Webb Jay	1:48
EVENT NO. 11—CLASS C CARS WEIGHING 551 TO 851 POUNDS.					
Franklin	800	12	W. F. Winchester	2:26
Cameron	700	10	F. F. Cameron	3:07 1-5



C. H. GILLETTE CONFERRING WITH OFFICER:

into the far ditch, ran several yards along it, then hit a large stone which caused the car to bound into the road, where it headed directly for the opposite side. Before Mr. Croker could straighten it out the monster was in the inner ditch, having missed hitting an automobile which was parked there by only a few inches. His speed had been greatly reduced by this time and Mr. Croker swung the car out into the road and continued. The crowd, which had taken to the woods when Croker's machine started to go wild, slowly returned, but not again during the contest did it approach close to the road.



JOHN A. HILL, OF RACE COMMITTEE.

The spectators along the course had no way of knowing how the different contestants were doing, and it was often remarked that the times should be passed down the line by the clerks with their megaphones.

BERNIN'S SPECTACULAR ASCENT.

W. Gould Brokaw was standing near the second sharp turn when his big Renault made its record-breaking ascent under the skillful driving of Maurice Bernin. Although the car skidded badly, Bernin negotiated the two turns in such a masterly way that but little headway was lost. He made a very spectacular turn in front of Mr. Brokaw, the car throwing up a cloud of stones and dust resembling the bow wave of a speeding boat.

James L. Breese, in his Mercedes, made this turn better than any other contestant. He cut in close and in some manner kept from skidding very much. In consequence his car lost none of its headway. When asked how the course compared with the Mt. Washington course, Mr. Breese replied: "There is absolutely no comparison. This is as smooth as a billiard table, compared to the other, and there are fifty turns on the Mt. Washington course as bad as these two."



WINTHROP E. SCARRITT AT THE TELEPHONE AWAITING START OF THE CONTEST.

All the small cars seemed to make hard work of it in the loose stones on the corners, but for the most part their speed was not sufficient to cause any danger. The Duryea, however, which was the first to take the corner at anything like speed, seemed to be handicapped by its peculiar steering gear, for as soon as it struck the turn it began a series of zig-zag movements that

compelled the crowd to execute a hasty retreat.

Things really began to warm up when Sartori came up with A. G. Vanderbilt's 90-horsepower F. I. A. T. The clerks of the course, stationed at intervals all along the way with red flags and megaphones, transmitted the signal from the foot of the hill, "Car coming," and this was quickly supplemented by the cry "Big car coming," as the roar of the exhaust became audible. Sartori came tearing up, and men and boys started running across the road to reach better viewpoints. The driver's heart must have leaped into his mouth; for as he commenced to turn, two men were crossing the road, probably misjudging the speed of the big racing car, and just escaped being run down by the smallest margin. A shower of small stones flying from the wheels pelted the spectators on the outside of the curve. After that they were more cautious; but a car running off the road, or even making a bad swerve, would have run into the crowd.

BAD TURN AT THE TOP.

The worst turn, near the top of the hill, which is the sharpest on the course and at the same time is on the steepest grade, furnished some exciting scenes. Owing to the straightness of the road just before the turn the big cars got up considerable speed, and though power was cut off in almost every instance at the turn, the machines went up the pitch and around the curve at such a rate that startling side slips occurred frequently; in fact, in one or two instances the cars turned almost at right angles to the road, and fine work on the part of the drivers was the only thing that prevented disaster. Sartori, running too far into the



S. M. BUTLER CATCHING THE TIMES OVER TELEPHONE AT BOTTOM OF THE HILL.

ditch in order to take advantage of the banking, bent an axle.

INTERFERENCE BEFORE THE TRIALS.

There was a time when it looked as if there would be no hill climb this year. Secretary C. H. Gillette, of the Automobile Club of New Jersey, says that he was called upon to appear before the town council of West Orange on Tuesday evening preceding the day for the contest, and a demand was made for the immediate payment of bills for road work and policing the course, the former amounting to \$247 and the latter an unknown quantity.

"Naturally I was taken by surprise," said Mr. Gillette. "I had been doing my best for several days to learn the amount of the bill for road work, but had been unable to do so up to that time. As for the policing bill, I could not pay it without knowing the amount, and the members of the council could not enlighten me. I explained the situation and arranged to pay the bill for road work the following morning, and also the policing bill, if I could discover its amount.

DEMANDED \$5,000 CASH INDEMNITY.

"On Wednesday morning everything had been nicely arranged when I received a telephone call from a member of the council saying that he was worried about the bills. Upon being informed that payment would be made that morning, a demand was made for a cash deposit of \$5,000 as indemnity against any trouble that might arise from accidents during the contest.

"It seems that one of the contestants, while practicing on the hill, had run into a carriage and done some damage, and the town council decided to make a demand for a deposit that would cover every accident on the hill or anywhere near it, whether the club was responsible for it or not. After explaining that the Automobile Club of New



LITTLE CHALET AT SHARP TURN OF COURSE AT TURN NEAR TOP OF HILL.

Jersey was a small one and hadn't one-fifth of that amount in its treasury, the council condescended to accept a bond for the amount, and I hustled around and got it. Upon presenting it that evening the council decided that it was not satisfactory, as it covered only accidents for which the club might reasonably be held responsible. They threatened to stop the contest if the particular variety of bond they wanted was not forthcoming, which was an impossibility on the evening before the climb.

"Finally, I stated that as the council had promised us the use of the roads on certain conditions, and as we had fulfilled the conditions and paid for permanent improvements, we would institute suit to recover the amount if the council failed to stick to its word. Thereupon a grudging assent was

given for the climb to be pulled off; but throughout the whole business the council exhibited such an obstructive spirit, and did so much to make things hard for us, that we were heartily sick of it.

ON ANOTHER HILL NEXT YEAR.

"One thing you can bank on," concluded Mr. Gillette, "is that the next hill climb will not be held on Eagle Rock hill, and the West Orange town council will not be given an opportunity to make trouble. Another thing is that the limit of speed has been about reached on Eagle Rock hill, and the next contest will be held on a steeper, straighter hill somewhere in the same vicinity. The cars will thus be tested more severely; there will be less danger, owing to the absence of turns; better views will be obtainable; and by having a definite understanding beforehand we will make sure that no hitches occur."

HILL CLIMB IN PROVIDENCE.

Special Correspondence.

PROVIDENCE, Nov. 28.—Hill-climbing furnished some good sport here last Saturday, and incidentally the former records for the hill were smashed. The course is slightly more than a third of a mile long and has an average gradient of 14 per cent and a maximum grade of 23 per cent. There are two sharp turns. The road was in good condition, but a strong wind somewhat retarded the contestants.

There were four classes—steam, electric, light gasoline and heavy gasoline cars. The best time, 46 seconds, was made by a 24-horsepower Peerless, driven by J. L. Snow. A Stanley steamer took second place in 47 4-5 seconds and a Pope-Toledo third in 48 seconds.

Maud—What effect does advancing the spark have?"

Tom—"It accelerates progress on the way to the license bureau."



TIMBERED HOUSE AT EDGE OF LLEWELLYN PARK. GIVING FOREIGN TOUCH TO SCENE.

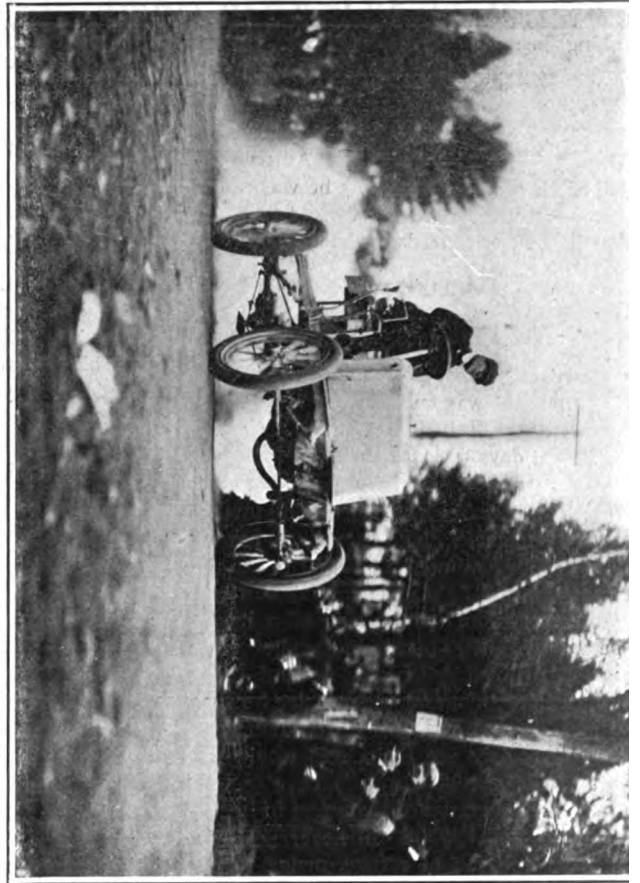

Webb Jay, in White Steamer, Making Mile up 10 to 17 Per Cent. Grade in 1:23-3-5.

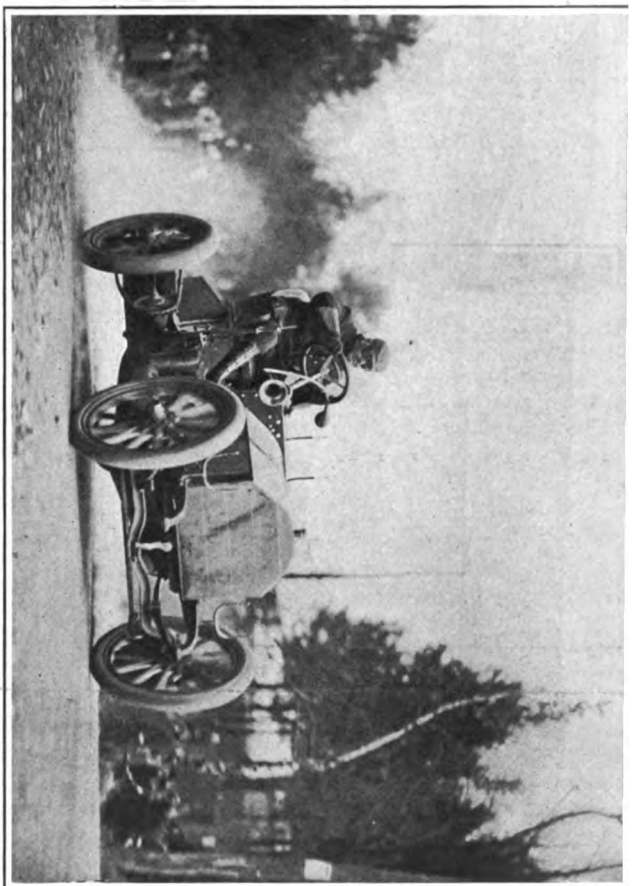

James L. Breeze, in His 40-H. P. Mercedes, Making the Prettiest Fast Run of the Day.

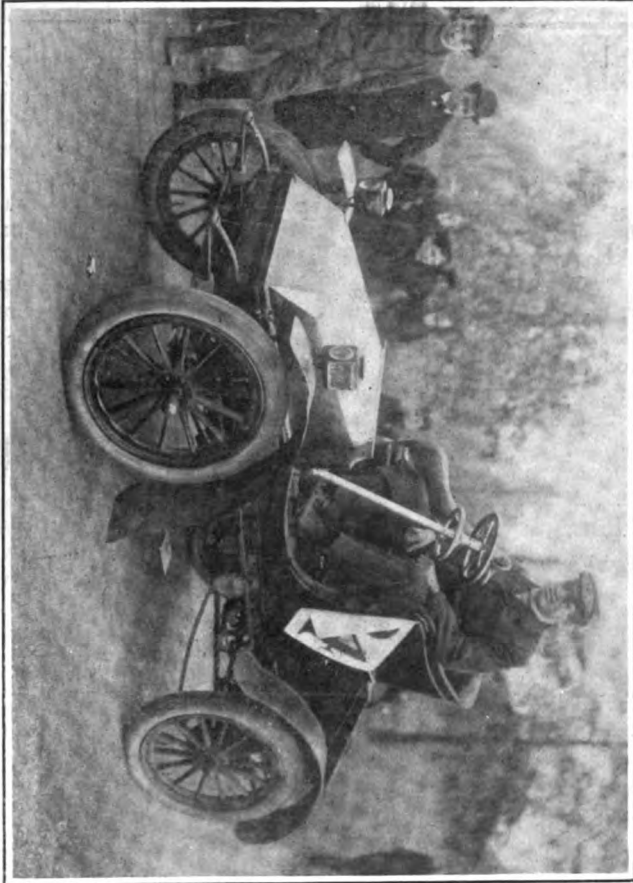

J. W. Aynworth, in Torbensen Electric, Which Cut 2 Min., 16 Sec. of Last Year's Record. 3:24

SOME OF THE COMPETITORS AND CARS THAT MADE NOTEWORTHY PERFORMANCES IN THEIR SEVERAL CLASSES ON THE EAGLE ROCK COURSE.

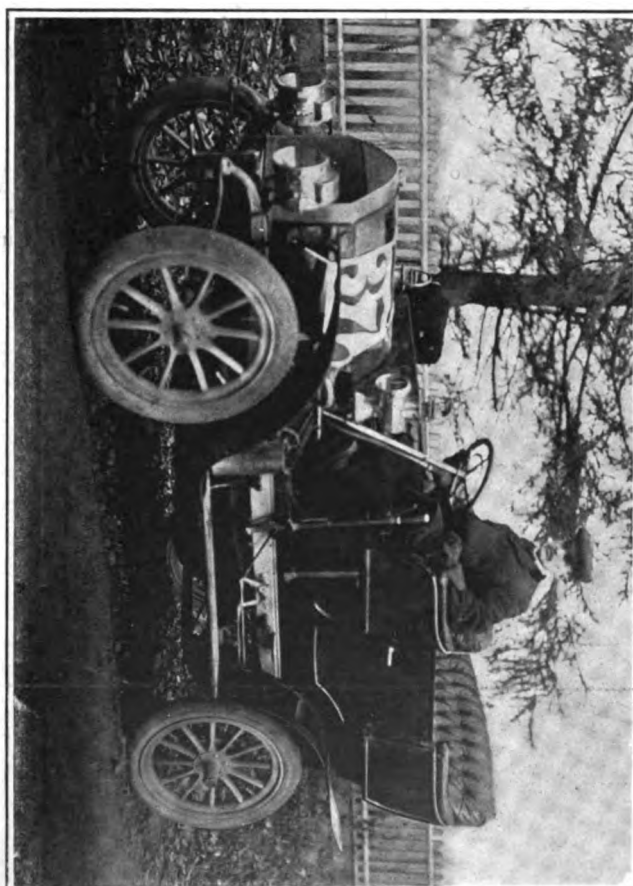

H. W. Allen, in Columbia 14-H. P. Gasoline Touring Car. Time With Passengers, 3:14-3-5.

British Tendencies in Motorcycle Construction.

THE motor bicycle industry in England is just now in a somewhat peculiar condition. Anticipating an enormous demand for motorcycles of all kinds, basing their estimates on the rapid rise of this mode of locomotion in the public estimation within the past two years, the British manufacturers have made the mistake of over producing. The public, on the other hand, is not falling over itself to get motorcycles in the manner expected. As a result motorcycles are obtainable on the easiest possible terms, though owing to their high power, great weight and consequently expensive construction, the prices are somewhat high.

WANTS A HEAVY MACHINE.

The Britisher has a strong leaning toward a heavy machine, with an excessively powerful motor, and cannot be brought to see the advantages of a light machine unless it will almost carry him up the side of a house. The tourist is often placed in the unenviable position of having to walk several miles with an almost unpedalable machine because his gasoline has run out, his accumulators (they invariably use them, and would not understand "storage battery") have become exhausted or because of some sort of breakdown. Fortunately he can never get very far from a haven of refuge, owing to the numerous villages throughout the country.

The Englishman builds his machine to carry him at good speed up the steepest hill he knows of, and, unless he is either climb-

ing that particular hill or running at terrific speed on the level, he gets no benefit from his excessively powerful motor, while the great weight of the machine is a fearful nuisance when it has to be handled, and the expense for tires, belts (which are almost universally used in England), fuel and oil is high. The fact that the average English motorcycle will take a trailer or side-car, containing a passenger, up almost any ordinary hill indicates clearly that the power available is far in excess of what is required to carry one man. English manufacturers seem to think the matter of weight is of very little consequence; one may look in vain for weights in the advertisements of motorcycle manufacturers, though plenty of other details are given.

CYLINDERS PLACED VERTICALLY.

A thing the English maker will not do, except in a few odd instances, is to incline the cylinder of his motor out of the vertical plane. He stands it straight up just forward of the seat mast. He places the large tank necessary to keep his powerful motor supplied with fuel below the top tube of the frame, and this placing of the motor and tank, being almost universal, makes it impossible to distinguish one make from another, unless the observer is close enough to be able to recognize some of the details in which differences exist.

The belt, to which the British manufacturer adheres with characteristic tenacity,

is the cause of an enormous amount of trouble. Belts are made in every imaginable form—round, solid, twisted, flat, triangular, belts made of leather blocks connected by metal links, leather band-and-block belts, cotton belts—in fact, everything seems to have been tried. Belt expense is quite a serious item to the motorcyclist, for a good belt costs anything up to a dollar a foot, 25 cents a foot being about the minimum for a belt of any sort.

A plain leather belt is continually stretching, and dismounting at regular intervals to tighten belts is necessary. The belt, as a rule, stretches until all the stretch is pulled out of it, and then breaks. The weight and power of a heavy machine greatly aggravates belt troubles. The more expensive belts partake more or less of the nature of chains—in fact, some are simply chains with leather-covered links, and, as their makers and users claim that they never slip under any circumstances, it is somewhat surprising that they do not go just a little further and use a chain and sprocket drive.

MANY PULLEY ARRANGEMENTS.

The universal use of the belt has given rise to a large variety of pulley arrangements. The small pulley on the motor is the seat of most of the slipping, and it is made with all sorts of irregular surfaces to get around the difficulty. The result is generally simply another form of trouble—rapid wearing out of belts. They are keeping everlastingly at it, however, and only time can tell which will come first, the perfect belt or the adoption of chain drive.

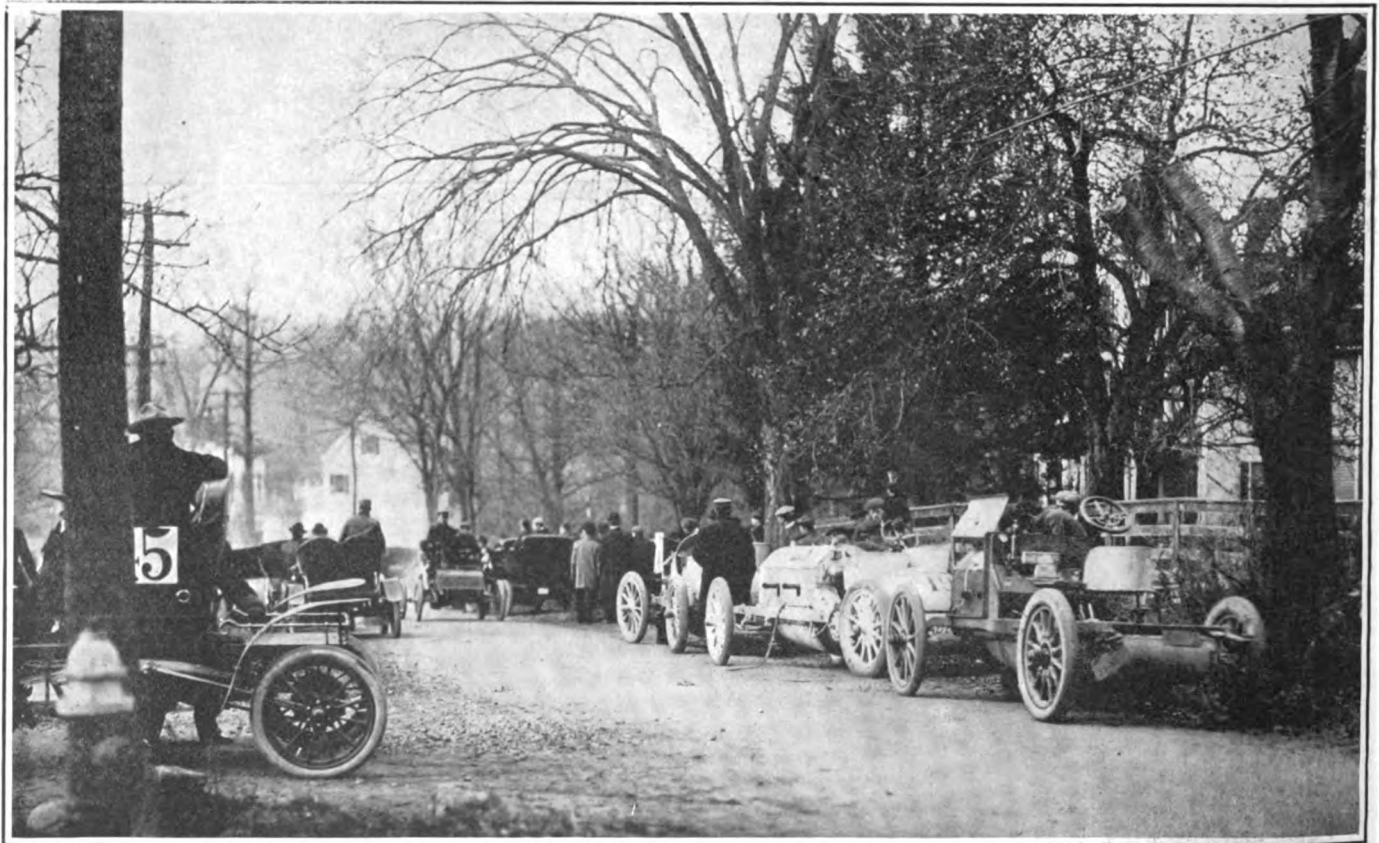

RACING AND TOURING CARS WAITING TO MAKE THEIR HILL CLIMBING TRIALS.—EAGLE ROCK MOUNTAIN IN BACKGROUND.

The size and power of the English motorcycle and the English tendency to tow or push an attachment for carrying a passenger makes it but a short step to the various forms of miniature automobile that retain the vague title of motorcycle. For instance, the forecar consists of a pair of wheels with a seat slung between them. The front wheel of the motor bicycle is removed and the fore part of the machine attached to the rear of the forecar. This detachable arrangement soon gave way to a permanent combination, the motor doubling in power and becoming water cooled, the simple transmission being replaced by a two-speed gear, the bicycle frame by a horizontal tubular trussed frame, the handlebars by a regular steering wheel with levers and handles on the column, and, finally, the only thing left of the bicycle, the saddle, disappears and in its place springs up a coach-built body with an upholstered seat over the motor.

The result is a small three-wheeled automobile with seat for two passengers sitting unsociably in tandem fashion. Why this arrangement should be preferred to a light runabout, in which the two passengers can sit in comfort side by side, it is hard to understand, as there is but little difference in the price, and a great deal of difference in comfort, convenience and appearance.

Olds to Tour Europe.

Special Correspondence.

PARIS, Nov. 22.—That well-known American car, the Oldsmobile, was the cause of a crowd which stopped all traffic in the Rue Richelieu, Paris, on November 19. A few days before, Mr. Dartelle, a rich sportsman, had alluded scoffingly to the Oldsmobile as a car fit only for a run round the Bois de Boulogne, or for the well-kept avenues of Paris. Immediately Henry Fournier took up the claims of the American car, declaring that it was capable of going anywhere. The outcome of the discussion was a bet of \$20,000 that the car should make a tour round Europe, covering a distance of 2,500 miles in twenty days.

The start was made at the offices of *Le Journal*, where a large number of prominent motor men had gathered. After the formalities of control had been gone through—for the driver of the little car carries with him a pass-book which must be signed at different stages of the journey—the departure was made promptly at three o'clock.

About twenty Oldsmobiles had turned up to act as escort to the sister car, and accompanied her through the city as far as the Bois de Boulogne, the unique procession

attracting much attention on the part of passers-by. The runabout is manned by Maurice Fournier, brother of Henry Fournier, and Ashley, an English chauffeur, who has recently made the successful tour round England on an Olds.

The principal towns passed through will be Bordeaux, Marseilles, Rome, Venice, Budapest, Vienna, Dresden, Berlin, Hamburg, Amsterdam, Brussels, and Paris.

CANADIANS PROTEST.

Special Correspondence.

TORONTO, Nov. 28.—The York County Council has decided to petition the Ontario



DAVE HENHEN MORRIS, THE NEW A. C. A. PRESIDENT.

Legislature to place the regulation of speed of automobiles in the hands of the local authorities having charge of the roads. At present a maximum speed of nine miles an hour in cities and fifteen miles in the country is prescribed throughout the province.

The farmers of York, of which Toronto is the center, complain of the growing prevalence of autos on the roads, and, more particularly, of over-fast driving on the part of reckless chauffeurs. They say the latter is becoming a common nuisance.

A new excuse for non-attendance at church is alleged by some farmers along highways like the Kingston Road, which is a popular run. They are afraid to drive to church, they say, because of the large number of autos on the road on Sunday and the consequent danger of runaway accidents. Farmers' wives have in many cases had to give up driving out alone.

Dave Hennen Morris.

Dave Hennen Morris, the new president of the Automobile Club of America for the ensuing year, was born in New Orleans, La., in 1872, his father being John A. Morris, of Westchester, N. Y., and his ancestors English. Mr. Morris began his education under tutors in France, Germany and the United States, and entered Harvard in 1890; but ill health forced him to abandon study for a year, during which time he traveled. He then took special medical courses, and had considerable hospital experience. Returning to Harvard in 1892,

he became a member of a number of Greek letter and other societies, and received a "Detur" prize in his sophomore year for general excellence in his studies. As a junior he was married to Alice Vanderbilt Shepard, daughter of Colonel Elliott F. Shepard, owner of the *Mail and Express*. He graduated in 1896 with honors. Later he graduated from the New York Law School, was admitted to the Bar, and has been practising law ever since.

Mr. Morris, who is a lover of horses, is partner with his brother in the racing firm of A. H. & D. H. Morris, is managing owner of the Morris Park race track, north of the metropolis, and also of the Morris Building, in New York. He has large real estate interests; is a musician, a member of the Metropolitan University, Racquet and other New York clubs, a yachtsman and—last and, in this case, most important—an automobilist.

He began his automobile career with a little steam machine, to run which he had to take out an engineer's license. Since that time he has owned a number of cars of various makes. He was

one of the first members of the Automobile Club of America, and was elected a governor in 1900, being nominated on two tickets. He was re-elected to the board of governors last year, and has still two years of his term to serve. In addition, he has been acting chairman of the racing board for two years.

President Morris's New York home is at 269 West Seventy-second street, and his summers are usually spent at Bar Harbor, Me.

A man who was driving a Pipe
Ran into a number of shipe;
When a little white lamb
Distinctly baa'd "Damb!
Do you think you can drive in your slipe?"

"What was the verdict in the case of that chauffeur who ran down a pedestrian?"
"Automobilicide in the first degree."
—Judge.

Juvenile Races on Long Island.

THE first boys' automobile race meet to be held in America was run off last Saturday morning on the Coney Island Cycle Path at the Park Circle, Brooklyn. The juvenile automobiles were propelled by muscular power of the legs and feet, but had automobile bodies, built on the lines of well-known racing cars, mounted on four wheels.

The idea of such a race was imported from Paris, where boys' automobile races have been very popular. But in transferring the sport to this side of the ocean, some radical changes have been made. In Paris the little autos are not built to be pedaled, but merely to coast down hill, and such coasting contests are held on hilly streets in the suburbs of Paris quite frequently. Leading Parisian automobile dealers have built a number of these little cars, bearing the names of the machines they handle, and lend them to the boys to race with. The American toy autos, however, have pedals and miniature automobile steering wheels and gear.

The race in Brooklyn last Saturday was over a 100-yard straightaway course and slightly up grade. Boys between the ages of six and twelve years were eligible. There were 192 starters, necessitating forty-eight heats with four contestants in each. A few of the boys had home-made cars, but most of them used the little wagons provided by a dry goods concern under whose management the race was held. As no final heats were run, the prizes will either be awarded to the three who made the fastest times, or else final heats will be held later, those having the race in charge having not yet come to a decision in the matter.

Austin Duff, who lives in East New York, on Long Island, made the fastest time, covering the 100 yards in 24 seconds. He pedaled a home-made machine which was built for him by his father, and the construction of which is unique. The only thing on it that was bought was the horn. The wheels and the springs were taken from an old baby carriage. The hand starting wheel of a sewing machine was used for a steering wheel, and the steering column was made from a piece of iron rod that fell off a junk cart in front of the Duff home one day. The driving chain, sprocket wheels and pedals were taken from an old bicycle which was geared to 70. The body and seats were built out of soap boxes.

Several hundred adults and youngsters gathered to witness the competition. Many of the contestants had trouble in keeping their cars straight, and the essential qualities for success were skill in steering and strength. A strong wind blew up the course, and on several occasions a severe gust stalled the contestants, who were unable to continue until it died down.

The best times made were: Austin Duff, :24; Jack McKenna, :25; Sam Corlis, :26; John Selkirk, :26; John Palmer, :26 1-5;

Charlie Hearn, :26 1-5; George Briggs, :26 2-5, and James Lazarus, :26 4-5.

One of the boys drove his machine into a fair sized dog, which had come to a standstill in the center of the path. The machine stopped dead, and the dog, which had not been moved out of his tracks by the collision, turned and looked at the little "devil wagon" for a moment, then calmly walked away.

Toward the end of the race the enthusiasm of the young spectators became intense, and they insisted on invading the course, just as their elders do at a real auto race. A big policeman cut a switch and ran down the course, darting here and there among the contestants, chasing away the enthusiasts who were trying to aid their favorites with vigorous pushes. The races were from



AUSTIN DUFF, WINNER, IN HOME MADE CAR.

standing starts, and when the boys received the word they would reach over the sides and push on the rear wheels to get their machines into motion. From a distance these motions resembled closely those of the drivers in a regular automobile race as they throw their gears into one speed after another.

Lubricating Oils.

A very important question must be studied with reference to automobiles, that of the lubricants to be made use of for the motor and bearings, but it must be remembered that the lubricant of an engine of 2 horsepower cannot be the same as the lubricant of one of 20 horsepower.

Absolutely fixed rules cannot be given for the composition of the lubricant to be used in all motors. It is especially necessary that the supply of the lubricant to the cylinders should be made as regular as possible, and it must not be forgotten that the inside

of the cylinder is regularly submitted to a very high temperature, due to the explosions, which occasions the vaporization of the lubricant, and even its decomposition. In the latter case, a deposit of carbon takes place, which inconvenience should be suppressed as far as possible. That is why lubricants not readily decomposed are preferable to those of the opposite tendency, and consequently petroleum oils are to be preferred to colza and olive oils, and to fats. The composition of the oils to be employed is quite varied, but we give that of a good lubricant suitable for automobiles of from 6 to 10 horsepower; 10 gallons of Russian motor oil, 1 gallon of extra refined cylinder oil, 30 gallons of heavy American motor oil.

For vehicles of less power a lighter American oil may be employed, and for those of greater power the quantity of cylinder oil may be increased. Some chauffeurs prefer to add a certain quantity of fatty oils, like olive oil, but we think that these should not be employed for the reasons given previously. The higher flashing points of oils are embraced between 530 degrees and 600 degrees Fahrenheit. Such oils would be excellent for lubrication, but cannot be employed, not being sufficiently fluid. That is why oils are preferred for motors of which the flashing point is 420 degrees F.

For the cylinders of automobiles worked by steam, it may be said that an excellent lubricant can be prepared by mixing varying quantities of cylinder oil and of heavy motor oil, with a certain quantity of fatty oil; for example, 30 gallons of cylinder oil; 20 gallons of heavy motor oil; 4 gallons of tallow.—*Le Journal du Pétrole.*

PROPOSED JERSEY LAW AMENDMENT.

Special Correspondence.

PHILADELPHIA, Nov. 28.—Assemblyman Harry S. Scovel, of Camden county, New Jersey, believes that the present automobile laws of that state are inadequate in a number of particulars, and announces his intention of introducing at the next session of the Assembly several amendments thereto. Among them will be one giving officials the right to arrest an offender without a warrant; another will propose a reduction of the present maximum speed limit of twenty miles an hour, and still another will prohibit the carrying on an automobile of more than one license tag—that of the state of New Jersey. Mr. Scovel asserts that a multiplicity of tags has frequently prevented the dealing out of justice to offenders against the law.

It has been officially decided by the International Brotherhood of Teamsters that chauffeurs are teamsters, and the New York branch of that organization has been instructed to take steps to unionize the automobile drivers.

Why is it that a 6-horsepower automobile cannot beat a two-horse team up a steep hill?

Because the farmer wants to do the beating himself.

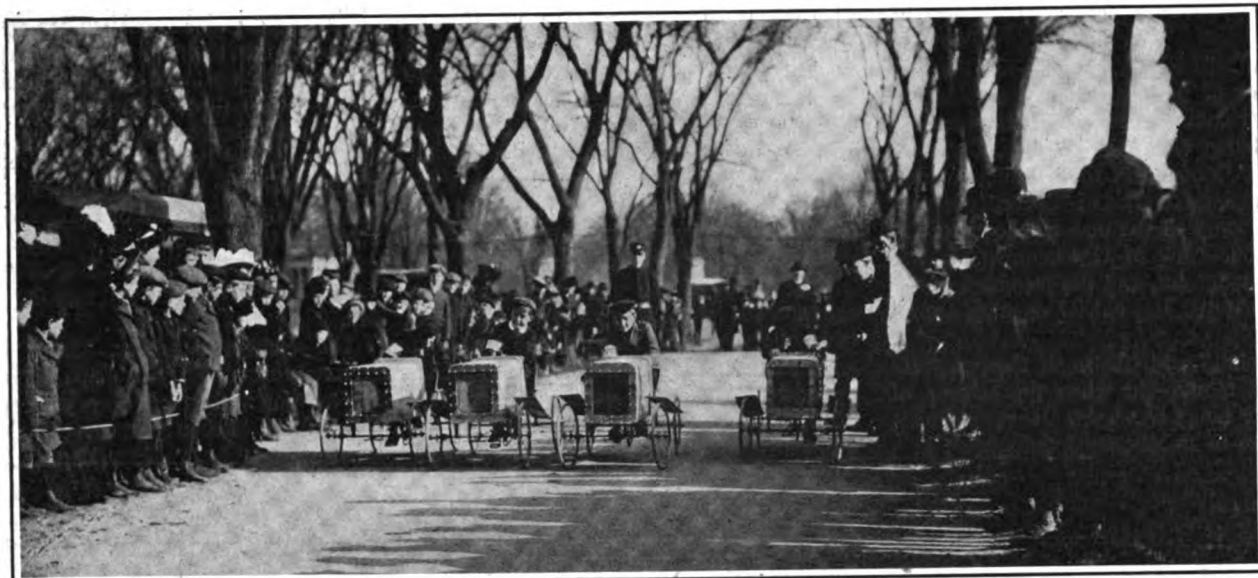

FOUR PANHARD RACERS, LINED UP FOR FIRST HEAT IN BOYS' RACE ON CONEY ISLAND CYCLE PATH.



HEATH II. FINISHING IN FRONT OF THE GRAND STAND NOTE THE SPECTATORS CROWDING THE COURSE.



TYPES OF JUVENILE AUTOS COPIED AFTER WELL-KNOWN RACING CARS. PANHARD ON LEFT AND BULLET IN CENTER.

Germantown Club's Fine Home Opened.

Special Correspondence.

PHILADELPHIA, Nov. 28.—In the presence of upward of 400 members and guests, including every one of prominence in automobiling circles in the city, Chairman Robert P. Hooper, of the building committee, in response to cries of "Speech! speech!" told the story of the new clubhouse of the Automobile Club of Germantown. It was Thanksgiving eve, and the members of the club celebrated the official opening appropriately.

"Our club," said Chairman Hooper, "was hardly a month old when the scheme of building a house was born. It was at lunch, and three of us discussed the subject in a

scribed, but the membership limit of 100 was reached before the excavations were begun. We now have a waiting list which is almost half as long as our membership list, and I violate no confidence when I state that the enlargement of the garage, if not of the clubhouse proper, is already being seriously discussed by the board of governors.

"The result of the work of the building committee is before you. We feel confident, in handing over this house to the club, that no one can find fault with us for not acting promptly. Whether or not the best interests of the club will be served by the present arrangement of the house can only be dis-

Emlen and Carpenter streets on an irregularly shaped plot of ground measuring on its four sides approximately 250 by 100 by 300 by 40 feet, the main front looking nearly towards the west and facing Emlen street. But a stone's throw away is Carpenter station on the Germantown and Chestnut Hill branch of the Pennsylvania Railroad, and as the clubhouse is situated on rising ground the view from the front of the house toward the west takes in all that beautiful section of suburban Philadelphia which includes the valleys of the Wissahickon and the Schuylkill.

The clubhouse proper, which is constructed throughout of Indiana limestone, is 65 feet long and 45 feet deep, with an L extension for kitchen purposes at the rear, measuring 31 by 16 feet, also of Indiana



FINE NEW \$30,000 CLUBHOUSE BUILT BY GERMANTOWN CLUB IN PHILADELPHIA SUBURB AND OPENED THANKSGIVING EVE.

general way and decided to suggest something of the kind at the next meeting, which we did. The result exceeded our most sanguine expectations. Committees were appointed to solicit subscriptions, for which bonds were to be issued.

"That was seven months ago. In less than a fortnight the responses were sufficiently numerous to warrant the appointment of a building committee. Ground was then selected and bought outright, plans approved, and five months ago building operations were begun. Quite a number of the members have devoted no little time to the work; but with the enthusiasm so intense, it was a labor for which the workers feel amply recompensed.

"An idea of the popularity of the movement may be had from the statement that not only were all the necessary funds sub-

covered by actual experience. I extend in the name of the club, a hearty invitation to our many guests to inspect the results of our work. As for the building committee, I feel that we will eat our Thanksgiving dinner to-morrow with additional zest, now that our work is practically completed."

Speeches by President Adamson and others of the board of governors comprised the opening exercises, and at 10 o'clock the first number of the long dance program was started, and it was not until the milkmen and other early morning workers were abroad in Germantown that the festivities came to an end and the members and guests departed in their automobiles and horse-drawn vehicles.

COMMANDING LOCATION OF CLUBHOUSE.

The house of the Automobile Club of Germantown is located at the corner of

limestone. Along the entire front of the main building is a spacious veranda, the roof of which is supported by seven massive columns.

Leading to the porch from the street are two handsome rough stone entrances, which meet on the terrace on which the house stands and lead thence to the veranda in front of the main entrance by a still wider stairway flanked by rough stonework. Two other stairways lead to the porch—one from the southern end giving easy access from the garage, and the other at the opposite end leading from the rear of the garage to the entrance to the women's apartments. No inside entrances from the garage to the upper floors are provided, the idea having been to shut off all odors from the main clubhouse. This idea is still further carried out by a ventilating system of flues and

electric fans that draw all fumes of gasoline and odors of burned oils to the chimneys.

PALM GARDEN ON THE VERANDA.

The roof of the veranda, which is more than twelve feet wide, is enclosed by a railing, and in the summer time will be fitted with awnings and furnished with tables, chairs and plants, to be used as a palm garden. The extreme overhang of the eaves—fully six feet—with the handsome supporting brackets, adds much to the artistic appearance of the proposed palm garden. The dark green shingles and the galvanized iron ridge poles set off the roof construction, which is crowned with a square cupola, also shingled, and with the overhanging eaves, while Old Glory constantly waves in the breeze at the top of a staff rising from the cupola.

EXCELLENTLY PLANNED GARAGE.

The garage is believed to be more conveniently planned and equipped than any other in the country. Indeed, Chairman Hooper, of the building committee, asserts that the entire clubhouse is peculiar to itself, the search for a precedent when the plans were being prepared having been fruitless. The entrance to the garage is on the south front of the main building, and a winding driveway, cut down to make an easy approach, leads to it from the street. Three cast-iron posts form the only obstruction in the garage, which will accommodate about twenty-two cars. To the left of the entrance is a washing stand and to the right a repair pit, 4 by 10 feet and 4 feet deep. Under the veranda are the toilet room and the storage room for lubricating oils. Adjoining these a small machine shop and workbench have been fitted up for the use of members in making small repairs. Outside the entrance to the door is a Bowser long-distance gasoline storage and pumping outfit, protected from the weather by a neat cover. The main gasoline tank is located 40 feet from the house, and has a capacity of 1,100 gallons. In the machine shop the club carries an extensive line of tires and small parts which are bought in quantities and sold to members at a slight advance

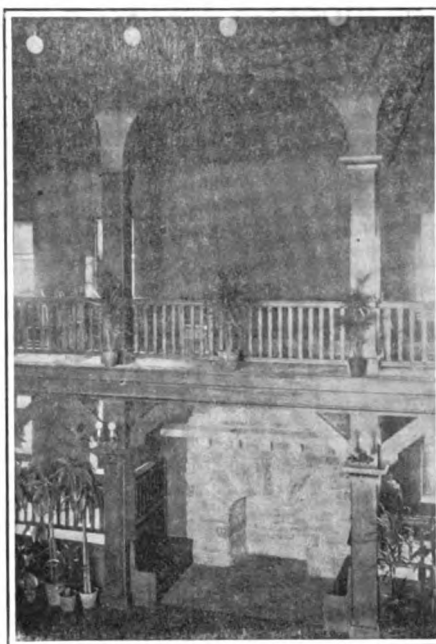

FIREPLACE, WITH INGLENOOKS AND ORCHESTRAL BALCONY ABOVE

over the wholesale cost. The club expects to be enabled to pay the wages of its garage attendant from the profits on such sales, while at the same time the members save enough to pay their yearly club dues (\$25 per annum).

BOWLING ALLEYS, STEAM HEAT AND ELECTRIC LIGHT.

Adjoining the garage, and extending the full length of the building under the addition, are the bowling alleys, two in number, of the official Brunswick-Blake-Collender construction, besides a row of lockers for the bowling contingent of the club. Immediately behind the pin pits are the storage rooms, supplies for which, as well as for the kitchen, are put in at the rear of the building.

Steam heat is used throughout the house, except in the main hall, or ballroom where hardwood logs are used in the stone fireplace, and in the kitchen, where gas is used as fuel for the ranges and the water heater.

The house is equipped with radiators, the steam being supplied from the pipes of the Germantown Steam Heating plant, located more than a mile away. Electricity is used throughout for lighting, and by these means the insurance premiums have been very much reduced, the danger from fire having thus been brought down to a minimum.

SPACIOUS MAIN HALL.

The architect has succeeded in avoiding all similarity of appearance to a residence, both externally and inside. Upon entering the main doorway from the porch, the visitor comes at once into the main hall, or ballroom, which is the club's "living room" at all times except on festal occasions. Ordinarily the main hall is furnished with rugs, leather cushioned sofas, comfortable, easy chairs and a huge square center table—all in Mission style—with an electric lamp springing from the center of the latter. These are all cleared away for dances, and the result is a dance floor 32 by 35 feet of polished maple—as indeed is the flooring throughout the house.

The most striking feature of the main hall is the huge rough stone fireplace, directly facing the front entrance and flanked on either side by a dark polished chestnut inglenook. On either side of the huge chimney is a balcony, one of which is to be used by the orchestra at dances, and both forming landings on the stairways leading to the second floor.

The interior of the main hall, open in the center to the roof of the cupola and with the second floor galleries extending around all four sides, is most unique, the effect being greatly enhanced by the dark polished chestnut pillars and arches and the Russian red decorations. Sixty large incandescent electric globes give ample illumination, a sufficient number of the lamps being placed under the galleries and behind the arches to bring out every feature of construction. The whole effect of this interior is decidedly Moorish.

THE WOMEN'S SUITE.

To the left of the main hall are the women's quarters, the walls of which are

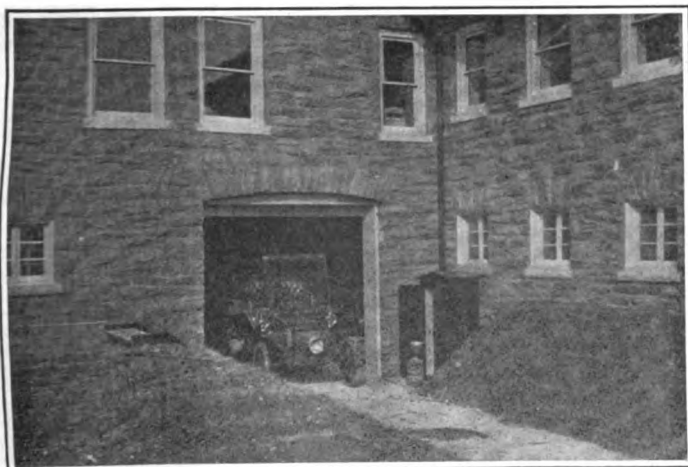

ENTRANCE TO GARAGE IN BASEMENT UNDER MAIN BUILDING.



BILLIARD ROOM ON SECOND FLOOR. ADJOINING SMOKING ROOM.

decorated in plum yellow paneled with dark chestnut, and the windows set off with dainty lace curtains. The suite comprises a parlor, card room, retiring rooms. Mission furniture, in natural silver gray wood and light upholstery, makes a striking contrast with the sombre tones of the main hall.

BANQUET HALL AND SMOKING ROOM.

On the opposite side of the main hall is the banquet hall, 21 by 16 feet, decorated throughout in hunter's green and capable of accommodating fifty diners at a time. In the rear of the banquet hall is the smoking room, fitted up with rugs, easy chairs, center table and reading lamps, with dark chestnut cushioned benches in Mission style along the walls, which are adorned with many handsome paintings and engravings—gifts of the members. Back of the smoking room are the men's lavatory and the coat room, the latter with ample facilities for checking the coats of 100 members and guests.

KITCHEN AND WINE CELLAR.

Leading off from the smoking room, and so situated that none of the culinary odors can reach the clubhouse proper, is the kitchen, handsomely fitted up in tile-work and supplied with all modern conveniences, including ample gas ranges and a huge instantaneous water heater. Close to the kitchen, where a cook is constantly in attendance, are the dumb waiter (leading to the second floor), the pantry and the wine cellar. The wine cellar contains thousands of bottles of rare vintages, all placed on racks, neck down, and slanting in a decidedly professional manner. The club steward, engaged for his skill in such matters, is at all times ready to concoct the favorite mixtures of the members on short notice. Back of the kitchen are two rooms for the servants.

SECOND FLOOR ROOMS.

Access to the second floor is by the stairways at the rear of the main hall. To the right is the billiard room, fitted with two tables of approved make and furnished with chairs and Mission style wall benches cushioned in dark red leather. Adjoining the billiard room are the locker room for the tennis players, and the shower baths, whence a servants' stairway leads to the kitchen below.

On the opposite side of the gallery are the "bachelors' quarters"—four rooms nicely furnished and intended for the use of members detained in town by business during vacation time. To the rear of these are the janitor's quarters.

From the front of the second floor gallery a door gives onto the porch roof.

Everything possible has been done to add to the pleasure and convenience of the members—a series of four tennis courts on the lawn below the house providing for outdoor sport in pleasant weather. The house system of telephones, with a central switchboard in charge of one of the employees, is connected with the Bell and Keystone local and long-distance lines. The handsome

lawn back of the house, plentifully shaded by big trees, will prove a delightful lounging place next summer.

Chairman Robert P. Hooper, Harry K. Duffus, Harry W. Butterworth, Thomas B. Prosser and Charles H. Thompson, comprising the building committee, expended a trifle over \$20,000 on the house and secured the ground for about \$5,000—very reasonable figures, considering the size and location of the lot and the substantial nature of

stud. Countersink the hole for riveting stud *A* and rivet over.

It is not usually necessary to touch the small friction points, as they are adjusted at the factory. The large friction joint, however, must be adjusted, and for this purpose a special spanner is provided. Unscrew the square headed screw in the collar until the latter is loose, and place the special spanner on the collar and turn until the necessary friction is attained. All joints

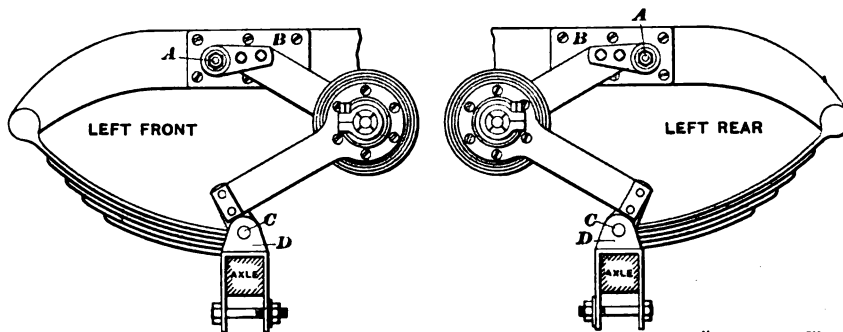

TRUFFAULT-HARTFORD SUSPENSION DEVICE ATTACHED AT FRONT AND REAR OF FRAME.

the clubhouse construction. The architect was Joseph M. Huston, and George F. Payne & Company were the builders.

The present officers of the club are: President, Prescott Adamson; Vice-President, Harry W. Butterworth; Secretary-Treasurer, Robert P. Hooper. These gentlemen and Harry K. Duffus, Thomas B. Prosser, William E. Helme, Mark B. Reeves and Stephen B. Ferguson form the board of governors.

Truffault-Hartford Suspension.

The accompanying line drawing shows one of the methods of applying the Truffault-Hartford suspension to automobiles, while the photograph shows the suspension in actual use on a front spring. It is not at all necessary that either of these particular plans should be employed; the device should be put on in the way best suited to the construction of the car. The usual method is to place it outside the frame, though the arrangements of some cars make an inside attachment more practicable. The angle at the joint may point either forward or backward. Broadly speaking, the free end of one arm should be attached to the frame and the free end of the other to the axle, great care being taken that the arms cannot possibly come together when the springs are compressed onto the bumpers. If found more convenient to attach some of the forgings to opposite sides of the arms, file off the head of the copper rivet and remove it and rivet on a small piece where required. Run in a 3-8 inch 24 thread tap to make sure that the square headed screws will fit properly. When the plates which will have to be made to suit the car have been fitted the hole for stud *A* should be drilled. Drill a hole less than 1-2 inch—3-8 will answer—and then run through a 1-2 inch drill, which will leave the hole a good driving fit for the

should have as nearly as possible the same amount of friction, and this should be tested by hand before attaching to the car. After the suspension has been applied, the car should be driven over rough roads and the friction adjusted until the car will not jump when passing over obstructions, but still will not ride stiffly. It will take the leather washers in the friction joints a few days to wear down to a good seating, and a little tightening up will be required, but afterward the wear should be so slight as to be almost imperceptible.

Inquirer—And how is the car stopped?
Scorcher—Mostly by a policeman.

—*Motoring Illustrated.*



DEVICE IN USE ON MERCEDES CAR.

Patents

Detachable Sprag.

No. 774,685.—C. A. Miller, of Hazleton, Pa.

A sprag intended to be attachable to any round or nearly round axle. It has a jaw end 4 4, which abuts against an axle band 10 (material not stated, but presumably leather), and is loosely held in place by the buckled leather strap 6 8.

Heavy Vehicle Running Gear.

No. 774,771.—C. B. Mills, of Wilkins, and A. Williams, of Pittsburg, Pa.

A truck or dump wagon having the body directly supported on the rear axle by helical springs, separate from the conventional side springs which carry the frame. The

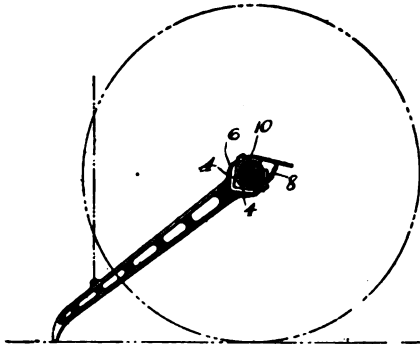

MILLER DETACHABLE SPRAG.

boiler—steam power being assumed—rests on the front end of the frame, and the motor is located about midway from front to rear, where it acts directly on a sprocket countershaft. Pedestal guides connect the body and the frame, and the front end of the body rests on a cross spring attached to the frame. The object is to support the motor on lighter springs than the body.

Non-Freezing Radiators.

No. 774,556.—F. E. Brock, of Washington, D. C.

A radiator enclosed in a housing having metal slats like those of a window blind at front and rear, and a small burner below, which it is proposed to light to keep the radiator from freezing during a stop on the road. The slats are then closed, but open at other times.

Spark Plug.

No. 774,432.—E. B. Jacobson, of West Somerville, Mass.

A plug with mica rolled around the central stem and surrounded by mica washers in place of the usual porcelain.

Speed Control Lever.

No. 773,812.—C. W. Russell, of Springfield, O.

A free lever having a hand-operated latch by means of which it picks up one or the

other of two short operating levers located one on each side of it.

Running Gear.

No. 773,639.—N. T. Harrington, of Detroit, Mich.

The gear of the Olds "touring runabout,"



HARRINGTON SIDE SPRING FRAME.

etc. The usual side springs *B* are supplemented in front by an X spring *E*, whose ends are attached by shackles to the frame and to brackets reaching up from the axle, permitting the spring to straighten out when compressed.

Electric Vehicle.

No. 773,575.—A. S. Krotz, of Springfield, Ohio.

An electric motor fixed to the rear axle adjacent to one of the side springs, and driving a large gear containing the differential. Of the main differential gears, one is keyed to the adjacent wheel hub, which turns loosely on the shaft to which the other gear and other wheel are keyed.

Carbureter.

No. 774,079.—C. J. Jager, of Boston, Mass.

A carbureter with spray nozzle *b* and float chamber *d*. The main air stream goes up through gauze strainers *e* and *f*, the latter being attached to a light shutter *f*, which is lifted more or less according to the intensity of the suction, thus opening supplementary oriñces *a*, which act to re-

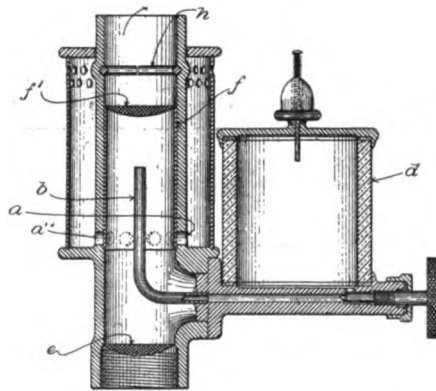

JAGER AUTOMATIC CARBURETER.

duce the vacuum, but not to dilute the mixture. The wire *h* limits the upward movement of *f*.

Steam Engine.

Nos. 774,433 and 774,434.—D. E. Johnson, of Hartford, Conn.

An engine having two high-pressure and two low-pressure cylinders, both single-acting, and a special piston valve mechanism operated by one forward and one reverse motion eccentric.

Ignition Apparatus.

No. 772,649.—E. Eisemann, of Stuttgart, Germany.

This is a modification of the well-known Eisemann igniter in extensive use abroad. In it the customary double-pole magneto is replaced by a multi-polar field, producing a number of alternations of the current in each revolution. The current is not taken from the armature by the two collector rings usual with alternate current apparatus, but by one collector ring and one brush, which bears on a serrated or otherwise broken ring, so that contact is made and

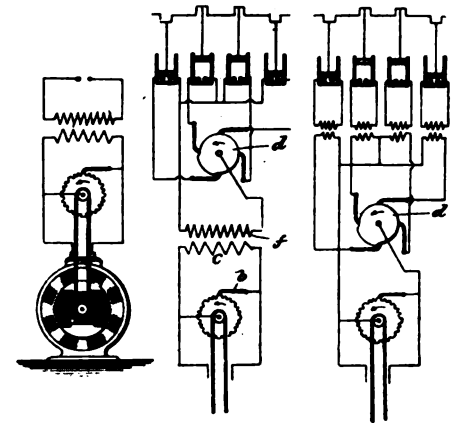

EISEMANN IGNITION APPARATUS.

broken a number of times for each phase of the alternating current. The effect of this is to produce a current curve of the character shown in the lower detail. The successive contacts follow so rapidly that exact synchronism of the apparatus with the motor is not required. In one form of the apparatus the Eisemann system of short-circuiting the armature on itself is followed. According to this system the primary winding *c* of the induction coil receives the momentary extra current due to self-induction in the armature when the finger *b* breaks the short circuit. Thus a continuous stream of current pulsations is induced in the secondary winding *f*, and these are sent to one or another cylinder by the distributor *d*. The other diagram shows the commoner system, with the distributor *d* in the primary circuit, and a separate induction coil for each cylinder.

Fair novitiate, at the show—"But, Algernon, why do they put a cooler on the front of the car and a muffler below?"

Algernon, who attended the banquet the night before—"They put the cooler on the bonnet and the muffler near the feet because, after a toot, the car is apt to steam wild."

Correspondence

Road Rights of Automobiles.

Editor THE AUTOMOBILE:—

[115].—In the November 5 issue of your journal "E. J. S.," of Paragould, Ark., stated that an injunction had been filed against him "by a friend" to prevent him using his steam car on the streets of that town, and asked for copies of decisions relative to the rights of automobiles upon the streets and highways.

To help deliver "E. J. S." from his "friend the enemy," I give you herewith some excerpts from legal opinions bearing on the subject, some of which were reprinted in the 1901 year book of the Automobile Club of America, and which were called to my attention by Secretary S. M. Butler, of the club.

A decision bearing directly upon the subject was rendered by Judge Sutherland, of Rochester, N. Y., in the case of *Mason vs. West* (31 Misc., 583). The decision was on an appeal taken by West from a judgment of the municipal court for damages and costs. West was the inventor and owner of a steam vehicle. While operating it in Tracy Park, October 18, 1898, a horse belonging to Mason became frightened at the vehicle and ran away, resulting in alleged injury to the horse and damage to the wagon. Judge Sunderland, in his decision, stated that the evidence had shown that the steam car did not differ materially from "the steam automobiles which are coming into common use."

"The horse had no paramount or exclusive right to the road," he said, "and the mere fact that a horse takes fright at some vehicle run by new and improved methods and smashes things does not give the injured party a cause for action. As Judge Cooley says, in *Macomber vs. Nichols*, 12 Mich., 212: 'When the highway is not restricted in its dedication to some particular mode of use, it is open to all suitable methods, and it cannot be assumed that these will be the same from age to age, or that the new means of making the way useful must be excluded merely because their introduction may tend to the inconvenience or even to the injury of those who continue to use the road after the same manner as formerly.'

"If the defendant's motor carriage is practicable for the purpose of travel, and the noise and vapor caused by its use are kept within reasonable limitations, and are no greater than are fairly incident to the use of motor carriages which are found adapted to the needs of the general public, then I cannot see how the defendant can be held liable in the absence of evidence that at the particular time complained of the carriage was operated carelessly.

"If one should find it desirable to go back to primitive methods and trek along a city street with a four-ox team and

wagon of the prairie schooner variety, it would possibly cause some uneasiness in horses unused to such sights. Yet it could not be actionable, in my opinion, if a runaway should result, provided due care were shown not unnecessarily to interfere with the use of the highway. Horses may take fright at conveyances that have become obsolete, as well as at those which are novel; but this is one of the dangers incident to the driving of horses, and the fact cannot be interposed as a barrier to retrogression of progress in the method of locomotion. Bicycles used to frighten horses, but no right of action accrued (*Holland vs. Barch*, 120 Ind., 46; *Thompson vs. Dodge*, 58 Minn., 555). Electric street cars have caused many runaways. Automobiles operated without steam, by storage batteries or by gasoline explosion engines, running at moderate speed, may cause fright to horses unused to them; yet the horse must get used to them or the driver take his chances.

"The temporary inconvenience and dangers incident to the introduction of these modern and practical modes of travel upon the highway must be subordinate to the larger and permanent benefits to the general public resulting from the adoption of the improvements which science and inventive skill have perfected.

"The judgment appealed from is reversed."

Another interesting judicial opinion was given in the charge of Judge Gaynor, of the New York Supreme Court, in Nassau county, New York, to the jury in the suit of *Knight vs. Lanier* (69 Third Division Appellate Court, 454), on March 27, 1901.

"The precise claim of the plaintiff here," said Judge Gaynor, "is that the defendant was negligent in the management of this horseless carriage or automobile, whichever it may be called, in that, seeing the horse unmanageable, and seeing the plaintiff and his party in a dangerous predicament with the horse, he nevertheless started up the automobile, and added to that predicament, made it worse than it was, and in that way made the horse get beyond control and throw the plaintiff, and turn the wagon over and get away.

"Now, there is no question with you and me about the rights of the defendant in this lane or in the highways. Far be it from us to have any prejudices against a horseless carriage. To be sure, the world is filled with all sorts of stupid prejudices, always was, and always will be, I suppose, about every change that ever occurred in the world. Even the best one that we can think of was met by, I suppose, the majority of people with some stupid prejudice against it. * * * But here we have no such prejudice.

"The automobile has as much right in the streets as the horse has. The bicycle used to be under the ban, but nobody now thinks of having any ill feeling against the bicycle. The same way the improvement of

the automobile is good. Many saw it was good from the start. Nobody has any prejudice against it. * * * You certainly have no prejudice, except against a man who uses it in a reckless manner, and you would have a prejudice against a man that drove a horse in that way, but against this means of travel you have no objection whatever.

"In addition to that, the law is with this means of travel. It has a right in the streets, as much right as a horse has, and, to some extent, it is superseding the horse, and is useful and pleasant, and by all means let this defendant have an absolutely fair show as far as that is concerned." * * *

New York City.

P. W. H.

Paragould Injunction Withdrawn.

Editor THE AUTOMOBILE:—

[116].—The party who instituted injunction proceedings against me for running my automobile on the streets of this city has realized what a ridiculous position he has placed himself in, and has consequently dropped them, but I hope you can get the manufacturers and clubs to respond to my letter of inquiry, and that you will print the replies in your magazine for the benefit of the public as well as of automobile owners.

E. J. S.

Paragould, Ark.

A Wrinkle in Operation.

Editor THE AUTOMOBILE:—

[117].—An explanation of one of my early troubles might be beneficial or interesting to some one.

My runabout ran good until I lost the screw cap for the gasoline tank. I got a new one, and thinking to make it better, and not lose it again, and keep gasoline further, put on a leather washer and screwed it down tight. After running a few miles the engine would keep missing. I found the spark O.K., but short of gasoline, with an almost full tank. Thought tank or pipes dirty, so when I got home I took it off and washed it out as thoroughly as I could; still no better. I took it to the agent, who thought a bit of galvanizing might wash over the hole at times; it ran all right as he tried it there, but when I got a mile or so away it commenced to kick again. I was in a dilemma, with lots of spectators, which did not improve my good nature. I happened to think of the tire pump, so uncoupled the carbureter, and forced air through the pipe, to blow any stoppage back into the tank. I pumped too much and got an air pressure in the tank, and too much gasoline, which I throttled and was all right, so had a connection made to pump so as to get along without disconnecting. One day as I stood giving it my blessing, I happened to unscrew the gasoline tank cap. I could hear it suck in the air, so removed the leather washer and have had no trouble from that since.

J. E. M.

New York.

Glycerine in Gas Lamps.

Editor THE AUTOMOBILE:—

[118].—I have a Rushmore acetylene lamp on my machine. Should I add a little glycerine to the water in the generator to keep it from freezing? Would there be any danger of chemical action taking place? In other words, would it be safe to burn the lamp with a little glycerine in the water?

LOUIS P. B.

St. Louis, Mo.

As to the chemical action which takes place between glycerine and calcium carbide, we find no reference whatever in the chemical authorities. Water and calcium carbide react to form acetylene gas and calcium hydrate. Any glycerine in the water used, if decomposed, would probably give off hydrogen gas, which would simply burn with the acetylene, no explosive compounds being formed. The only way, however, to find out exactly what would happen would be to try the experiment, of course taking such precautions that no harm would be done if the lamp should explode.

In order to lower the freezing point materially, much glycerine must be added to the water; a 30 per cent. solution freezes at 21 deg. Fahrenheit. Such a mixture is thicker than water, and there may be mechanical difficulties in its use in a lamp designed for the use of water.

A Record in Maintenance Expenses.

Editor THE AUTOMOBILE:—

[119].—I have been interested in reading letters from different persons on the subject of repairs and expense of cars, also comparing the expense of a car to that of a horse and buggy. It seems to me that some persons like to discourage the automobile business by complaining about the expense of operating a runabout or touring car. I think if persons owning an automobile would take more time and trouble to learn something about their machine, and how to keep it in good condition, instead of constantly running to the repair shop, they would get along much better. I have been running a 1,200-pound runabout for almost two seasons, and think I certainly must have had extra good luck, especially this season.

My rig has a double-cylinder 8-horse-power motor. I take care of it myself, and it has not been to the repair shop this season; although I had some trouble last season, I finally located and remedied it. I am well pleased with my machine and expect to have an automobile so long as I am able to own and operate one. I expect to sell the rig I have or trade it for a larger car soon, and have no intention of being without one.

There is a great amount of pleasure in getting out into the country and traveling along at from 12 to 20 miles an hour, but I am anxious to own a car now that will take me at the rate of 20 to 40 miles. I am always glad to read letters from others setting forth their ideas, likes and dislikes on

the subject of country touring. If there are any other owners that have had less trouble and expense this season than myself, I would be glad to hear from them.

Below are the items of expense for this season, and I have had many nice rides over the country roads, including good roads, hills, dirt roads and about all kinds one finds in this section of Indiana. I put in a set of batteries early last spring, and the items below include all expenses for the season, not including the first set of batteries:

Four small cells.....\$.80
Repair on tire..... .35

Total \$1.15

If any one can beat these figures, I would be glad to hear from him.

It may seem strange to some, but I did not have a single puncture last season, and but one this summer. I do not remember of my motor stopping but twice of its own accord, once on account of a weak spark, and the other time because I cut the supply of gasoline down too fine.

I am in favor of the automobile first, last and all the time. S. T. M.

Terre Haute, Ind.

We hope that some of our subscribers will act on the suggestion of our correspondent and send in tabulated lists of expenses for car maintenance. Our correspondent has certainly made a record in the way of expenditures, as the amount is smaller than anything that has come under our notice. He enjoys the advantage of living in a state in which there is no general speed law in force. We are very glad to receive for publication interesting communications of this character.

ROAD RIGHTS FIRMLY ESTABLISHED.

Special Correspondence.

PHILADELPHIA, Nov. 28.—Assistant Secretary Gundlfinger, of the Automobile Club of Philadelphia, was kept busy last week answering inquiries as to the possibility of applying to automobiles the law of 1885, requiring a mounted man to precede threshing or other self-propelled farming machinery in transit on the state roads. An item in the local dailies to the effect that wealthy farmers of Allegheny county would endeavor to have the law so applied caused the commotion.

The club's counsel, Ellis Ames Ballard, promptly furnished the advice that the Pennsylvania ordinance of 1903 superseded all previous measures, and that the rights of automobiles on the roads of the state were now firmly established. The man on horseback, he said, was nowhere mentioned in the present law.

An automobile train of four cars was given a successful test recently by the German military authorities near Berlin. A speed of fifteen miles an hour was attained. Field Marshal Count Von Schlieffen, chief of the general staff, and several cabinet ministers were passengers during the test.

AUTOS AND LOCAL OPTION.

Special Correspondence.

TOLEDO, Nov. 26.—The last few weeks have witnessed some remarkable changes that show the rapidly increasing popularity of the automobile in northwestern Ohio.

The Brannock local option election law was enacted by the Ohio legislature last spring. Under it city districts may be mapped out and the question of local option put to a popular vote within the boundaries of that district. Since the enactment of the law Toledo has been nearly covered by these districts, and the automobile has been an important factor in the fight between the saloon advocates and the temperance people, or the "wets" and "drys," as they are called.

The first election to be held was in a district outlined by the "drys," but the "wets" won out by a handsome vote. The "drys" were content to employ one horse and buggy for bringing voters to the polls, but the "wets" were more progressive and employed a monster automobile, and to this they attribute a large share of their success. While the "drys" were bringing one or two persons to the polls the "wets" were bringing a half dozen, and while the "drys" were making one trip the "wets" were making two.

The hardest fight in the city was in the "Farm" district, so called because it included the Farm summer theater. By the time this election came off the "drys" were wise and had an automobile at work, but the "wets" were again ahead, more progressive, and had two machines in the field, and accordingly won again.

Both sides state that the automobile is an important element in Brannock election work, and assert that no more close elections will be held without the automobile playing an important part in the contest.

Another important fact which has become apparent during the past few weeks is that there is a gradually decreasing number of horse-drawn drays in Toledo. A few days ago the writer had this interesting conversation with one of the oldest draymen in the city:

"Well, Mr —, how is business?"

"Never worse since I have been in the city," was the reply. "You see, these automobile fellows are cutting into our work. Look around this corner; you know how many drays used to be found here at all hours of the day. Well, they are gone. If it keeps up, I suppose I will have to go, too.

"Yes, sir, during the past few weeks several of the old-time draymen in Toledo have gone to the country and are now on small truck farms. I have no doubt that they will make more money there than they made in Toledo. That's one of them fellows now"—just then an automobile truck went by—"and there goes some of our business, I suppose; but that is what we have to expect nowadays," and with that he climbed into his wagon and drove away.



VOL. XI.

No. 23

Published every Saturday by

THE CLASS JOURNAL CO.,Flatiron Building, Madison Square,
NEW YORK CITY.Cable Address - - - Autoland, New York
Long Distance Telephone - 300 Gramercy, New York

SUBSCRIPTION RATES:

United States, Canada and Mexico, - One Year, \$2.00
Other Countries in Postal Union, - One Year, \$3.00To Subscribers—Do not send money by ordinary mail.
Remit by Draft, Post-Office or Express Money Order,
or Register your letter.

FOREIGN SUBSCRIPTION AGENTS:

ENGLAND:—Iliffe & Sons, Limited, 3 St. Beide Street,
Ludgate Circus, London, E. C.FRANCE:—Boyveau & Chevillet, 22 Rue de la Banque,
Paris.

GERMANY:—A. Seydel, Mohrenstrasse 9, Berlin.

To Advertisers—Copy or changes in orders for adver-
tisements should reach us not later than 5 o'clock p. m.
Monday for the issue of Saturday following.Copyright, 1904, by The Class Journal Company.
Entered at New York, N. Y., as second-class matter.The Automobile is a consolidation of *The Automobile*
(monthly) and the *Motor Review* (weekly).

Copies Printed This Issue, - - 12,000

“ “ Since Jan. 1, - 591,000

ANNOUNCEMENT.

Mr. H. F. Donaldson, Editor of THE AUTOMOBILE, sailed from New York on December 1 to represent this publication at the Paris Automobile Salon. While on the continent Mr. Donaldson will visit a number of the foreign factories and the principal dealers, and will return by way of England, where further investigation into the state of the art in Europe will be made. While abroad he will also arrange for an extension of the European news service and subscription agencies of THE AUTOMOBILE in various important centers.

Panhard Racer for Mile Record.

It is practically a certainty that William K. Vanderbilt, Jr., will not drive a Mercedes car when he again attacks the mile record at Ormond Beach in January. Instead, he will drive a special Panhard racer, now under construction in Paris. Powerful as were the Panhard cars that competed in the Vanderbilt race on Long Island, the new machine that is being built to lower the world's record will be of much greater power. Just how much is as yet a shop secret, though on good authority it is said that the motor will be of not less than 130 "nominal" horsepower. There are rumors that the car will be equipped with a motor capable of developing not less than 200 horsepower. Consid-

ering the weight limitation, this is probably an exaggeration. Whatever the rated horsepower may be, it is a certainty that the car will embody all the experience gained in a long series of racing contests and will be enormously powerful and of tremendous speed. The French concern is out for the record. It is significant that Mr. Vanderbilt should decide to drive a Panhard, as he has been in recent days a patron of the Mercedes concern. More than likely the splendid showing made by Heath's car in the Vanderbilt race and the relatively poor work of the Canstatt cars in that race may have influenced the decision.

Details of the construction of the new car will be received with much interest by the automobile world. The increase in power without any increase in weight would seem to indicate the adoption of a multi-cylinder motor of more than four cylinders, reducing the weight of speed-changing mechanism to a minimum, if not making its use unnecessary. The Pope-Toledo car entered for the tournament is of the six-cylinder type, and in this car there is no speed-changing gear whatever.

No more interesting feature of the coming meeting by the sea will be the contests of these mechanical monsters in an effort to reduce the time for the mile, which, in the English-speaking countries at least, is the popular standard for speed.

Artistic Treatment of Shows.

One probable good result of the holding of two independent shows in New York in January will be a more careful consideration of the artistic side of automobile expositions. Comparisons popular and expert are sure to be made, and it should, and doubtless will, be a matter of pride, or really business policy, on the part of the respective managements to produce an artistic "impression" in each case. There is certainly an abundant opportunity for the display of artistic skill in the larger show at Madison Square Garden. It is especially necessary, as the interior of the main hall is of a character that demands skillful treatment to adapt it to the purposes of an automobile show. Fortunately the exhibits of complete machines in this hall lend themselves to artistic treatment, as color and form pleasing to the eye are essentials in machines that a majority of the exhibits will be found to possess.

To get the correct results, it will be necessary to go further than to merely indicate the dimensions of the signs that may be used by exhibitors. Their shape and color and the character of the lettering must be the subject of regulation or agreement if good taste is to be observed and the records of past shows eliminated. In the separate rooms, such as the dining hall and basement, the production of pleasing results is an easier matter and should present no very serious problem to either management or exhibitors. The Garden Show is certainly profitable enough to permit some

financial attention to this feature, which makes a large impression on the visiting public.

A good picture needs a good frame. From many points of view unconnected with pure art it is desirable that the æsthetic side of the automobile should be emphasized at the annual show, if it is not to degenerate finally into a mere trading place for agents and dealers. A few dollars now spent will help the box office receipts from the general public at this and future expositions.

Lessons of Eagle Rock Hill Climb.

Hills, for long a great bugaboo to automobilists, have lost their terrors in the last year or two of automobile development. The Mount Washington "Climb to the Clouds" and the Eagle Rock hill-climbing contest of Thanksgiving Day only emphasized a fact that was being demonstrated every day in cities famous for their hills, like Pittsburg, Cincinnati and Kansas City, and on almost every tour. Grades of 15, 20 and even 25 per cent have not proved insurmountable by the average runabout and touring car, except in exceptional cases, where the road surface was particularly muddy, sandy or rocky.

This most satisfactory state of affairs is the result of increased engine efficiency, reduction of car weight without decrease of strength, and general improvement of transmission mechanism whereby friction losses have been reduced. The improvements have been prosecuted all along the line, so that to-day gasoline, steam and electric cars are all better hill climbers than ever before, as is plainly shown by the great reductions of times in all classes in last Thursday's contest at West Orange, New Jersey. Nearly two minutes in the mile were cut off of the best previous time for electric; the steam car record, that had stood at 2:43 and one second lower for two years, was cut down to 1:23 3-5, and more than sixteen seconds were sliced off of the 1903 record of 1:36 3-4 in the gasoline class.

Increased size and power of the engines is, of course, largely responsible for the lower times, the winning steamer this year having three times the power of the old record holder, and the Renault car having double the power of the 30-horsepower Mors with which Mr. Vanderbilt captured the gasoline record a year ago.

The most satisfactory aspect of the matter, however, is that the ordinary touring cars and runabouts of moderate power and low price not only had no trouble in surmounting the tortuous ascent with a maximum grade of about 17 per cent., but also showed much better time results than a year ago, thereby demonstrating great mechanical improvement in a class of cars for which American manufacturers have made their country famous in automobile circles throughout the world. The greatest good to the greatest number will result from progress along this particular line, and the largest commercial success will come to

the manufacturer who makes the most rapid advance.

That ordinary runabouts and touring cars ranging in power from 6 to 22 horsepower should be able to climb a mile long continuous grade, increasing from zero to 17 per cent. on ordinary macadam pavement, negotiating several sharp turns and many sinuosities at the rate of from twenty to forty-two miles an hour, indicates conclusively that while a large reserve power is desirable, it is not necessary to have a huge road locomotive in order to surmount the obstacles likely to be met in touring over American roads—notoriously the worst in any civilized country. As the laws in most of the states in which automobiles are used extensively do not permit speed in excess of the lowest of these rates, the law-abiding motorist has no need for greater power than will enable him to get up hills and through mud and sand at that minimum rate.

Except for legitimate racing, the car of 90 and 100 horsepower has no proper place, and, indeed, it is likely to become a dangerous monster in the hands of any but a thoroughly experienced, cool and quick-witted driver. The obvious conclusion is that American constructors are making progress in the most desirable direction, and that what is most needed now to increase the value of American cars to their owners is tires or tire attachments that will prevent skidding and give good traction on wet surfaces on ascending grades.



General Kuropatkin is reported to have received a new 20-horsepower automobile, with which he is enabled to get from one point to another of his extended line of defense with greater facility than on horseback. When the active little Japs get busy in earnest again the General will probably regret more than ever that the automobile transport wagons which he asked for did not arrive, and that his own car is not a 90-horsepower racer. It is a long, cold ride from Mukden to Harbin.



Judging from the growing frequency of the relief of runs on small Ohio banks by quick work with automobiles, these institutions would find it a good investment to place orders with automobile makers and dealers in that state for fast cars. They could consider the cost in the light of a premium on insurance against having to close their doors.



Canadian farmers are now offering as a new excuse for not attending church on Sundays that reckless driving by a few inconsiderate motorists and chauffeurs frightens their horses. Would the same danger keep them from going to a circus?

Up-to-date urchin (to driver of broken-down equine)—“Hey, mister, git an automobile.”

TEN PRIZE CUPS FOR BRESCIA CIRCUIT.

Florio Trophy Offered by Italian for Cars Under 2,204 Pounds Over Course of 497 to 621 Miles—Auto Boat Events at Monaco in April for \$20,000 in Prizes.

Special Correspondence.

PARIS, Nov. 15.—Another international challenge cup for automobiles has just been created, thanks to the initiative of the Italian sportsman, Vincenzo Florio. The new cup, which in reality consists of seven small cups and one large cup, will be competed for during the Brescia week, about the end of August, and will doubtless add much to the importance of this northern Italy meeting. The Brescia Circuit is already endowed with two cups, the Coupe d'Italie and a cup offered by the Princess Laetitia. These prizes will still remain distinct, but will be competed for over short distances of the longer race for the Florio cup.

The new challenge cup is reserved for cars of less than 1,000 kilos in weight (2,204 pounds), and will be competed for during seven consecutive years, beginning in 1905, over a distance of 800 to 1,000 kilometers (497 to 621 miles), and must always be run in Italy. Each year a reduction or miniature of the original cup will be presented to the owner of the winning car, but the original cup will be awarded to the make of car having won the largest number of times in the annual races. If, owing to a series of victories, the cup is assured to one particular firm, the prize will be considered won without the full seven races having been run. The cup becomes the absolute property of the winning firm.

In addition to the cup, three money prizes are offered annually: 1st, \$600; 2nd, \$240; 3rd, \$160. Competition for the cup is open to all, the entrance fee being \$50 for each car.

It will be seen that in general the Vincenzo Florio cup resembles the Gordon Bennett cup. The increased distance of the course is a change well in harmony with the increase in speed and efficiency of motor cars during the last few years. But one may ask what will be the type of car taking part in the seventh year's race?

THE MONACO AUTO BOAT MEETING.

The second year's meeting at Monaco begins April 2, and promises to be as interesting and important as that of 1904. Prince Albert of Monaco has accepted the presidency of the regattas, the committee, consisting of persons of standing in the automobile and auto boat world representing their different countries. The United States representative is Clarence Gray Dinsmore, the representative in Europe of the Automobile Club of America. April 2, 3, 4 and 5 will be taken up with an exhibition of all boats entered for the races. On the succeeding three days the boats will be launched and trial trips run, and from April 9 to 16 racing will take place.

The boats will be divided into three classes—racers, cruisers and ship's boats and fishing craft. Racers are divided into three sub-classes—boats not more than 8 meters long, boats of 8 to 12 meters and craft from 12 to 18 meters. Cruisers are divided into a number of sub-classes, according to their length, power of their motors, their freeboard, and the number of places for passengers. Ship's boats must be capable of being either sailed or driven by motor, must be constructed so that they can be beached without the screw touching the bottom, and must be able to carry four persons in any ordinary weather.

The first race, for racers of 8 meters, will be run on Sunday, April 9, over a 100-kilometer (62 miles) course. The four prizes amount to \$1,800, a gold medal being offered for the boat creating the record for fifty nautical miles. The same day a race for cruisers will be run from Monaco to Nice and back, the prize money amounting to \$1,200. The second day will be for 40-foot racers, distance 100 kilometers and prize money \$1,800; and for cruisers of 8 meters, from Monaco to Nice, back to Monaco, to Menton and return to Monaco, for prizes amounting to \$1,600. The third day racers of 12 to 18 meters (40 to 60 feet) will run 100 kilometers, and cruisers of 12 meters will run from Monaco to Nice, Antibes, back to Monaco, to Menton, and back to Monaco. The fourth day is for cruisers of 12 to 18 meters, from Monaco to Nice, San Remo, Nice, Monaco, and for ship's boats with previous rowing and sailing tests. The fishing boats will also race on the same day.

The fifth day the 200-kilometer championship for all racers or cruisers up to 18 meters will be run, and on the sixth day various handicaps will be decided. The closing day the championship for the nautical mile and the kilometer flying start for any craft having won in the previous races will be decided. The total prizes amount to \$20,000, in addition to which there are a number of gold medals for records in the different classes.

Influenced by the success of auto boats in the various races held during the season that has just finished the French Minister of Marine has decided to organize races and tests to be held early next season.

WORLD'S RECORDS HELD BY DARRACQ'S.

The honor of holding all the world's mile and kilometer championships now belongs to Darracq cars. At the Ostend meeting yesterday Baras, with a 100-horsepower Darracq, attained in the kilometer flying start the stupendous speed of 168 kilometers 22 meters (102.4 miles) an hour. His time, 21 2-5 seconds, beats Rigolly's previous record by one-fifth of a second. By this performance the Darracq firm has secured all the six world's records in the mile and kilometer championships, as follows:

Heavy cars: One mile, standing start, Baras, :48 3-5; one kilometer, flying start, Baras, :21 2-5.

Light cars: One mile, standing start, Hémary, :51 2-5; one kilometer, flying start, Hémary, :26.

Voiturettes: One mile, standing, Villemain, 1 :21 4-5; one kilometer, flying start, Villemain, :33.

It will be remembered that in the recent Gaillon hill race Baras and Rigolly made a dead heat in 29 seconds, but that the cup continued to be held by Rigolly, as he was the previous year's holder. As Rigolly refused to accept his rival's challenge to run over the course again, the cup does not change hands, and Edge's challenge to meet the two French chauffeurs at the same time consequently falls to the ground.

SEEKING GORDON BENNETT COURSE.

Although the Gordon Bennett race is yet far in the distance, the choice of a course is already under consideration. René de Knyff and Quimonés de Léon have just visited a proposed course in the environs of Vichy, near Paris, and the neighborhood of Aix-les-Bains has also been proposed as a suitable circuit.

At the French Automobile Club the opinion is pretty evenly divided between two parties. The first looks upon the race as a sporting, and at the same time a great social, event, which should be so organized as to draw together those rich persons who

are likely to become interested in automobilism as a pastime. For this party it is essential that the race should be run near to some important social center, in order that spectators may be attracted and be provided for in the best possible manner. The other school regards the race from an industrial point of view, and urges the necessity of the best possible course with few or no neutralizations, so that the cars may give their best possible performances. Whether it is conveniently situated or not is, they maintain, a matter of no importance, for persons really interested will be present wherever the race may be held.

For the French eliminatory trial the entrance fee has been fixed at \$2,000.

CHAUFFEURS' UNION FORMED.

A Chauffeurs' Union has just been formed at Paris with the object of protecting the interests of automobilists in general, and in particular of putting a stop to the arbitrary proceedings of the police in regard to summonses for alleged excessive speed. The chauffeur, in ignorance as to what has taken place until he receives official notice of the summons, is unable to disprove the statements of the police, and often finds it more convenient to pay than to protest.

Upon their return from the Gaillon hill contest, a party of automobilists discovered a gendarme hidden by the roadside, taking the numbers of as many cars as possible. On being brought out of his hiding-place and surrounded by a number of motor men, he confessed that he had hoped to get forty summonses during the day.

Localities vary considerably; in some districts there is nothing whatever to fear from the police, in others the motorist runs great danger of being summoned no matter at what speed he travels. The town of St. Germain, quite near to Paris, has in this respect proved itself most obnoxious, and for some time has been actively boycotted by motorists. A. Clement is among those who are interesting themselves in this matter, and he is placing, at his own expense, at the entrance of towns and villages proved to be hostile to automobilists, large notice boards bearing the inscription: "Chauffeurs, beware! Unjust Police Proceedings."

FATAL GRADE CROSSING ACCIDENT.

Another automobile accident has occurred on a Long Island grade crossing, the result being the instant death of one man, the injury of another, and the demolition of the automobile. The Dorchester Road crossing of the Brighton Beach electric railway was the scene of the accident.

Guy Loomis, of the lumber firm of John S. Loomis & Co., Brooklyn, N. Y., was driving in his car on November 23, and states that he approached the tracks at about eight miles an hour. The approaching train was hidden by a hedge and a large wooden advertising sign, and Loomis failed to see his danger until it was too late. The three-car electric train struck the forward part of the automobile, and Loomis and Maurice Ward were thrown out, Ward being killed instantly and Loomis escaping with comparatively slight injuries.

The crossing is without gates or other safety devices, though efforts had been made to cause the Brooklyn Rapid Transit Co., which operates the railroad, to put up gates. There was no flagman on duty when this accident occurred, and a policeman who was a witness states that the motorman of the train did not blow his whistle, though this is contradicted by the motorman himself. Others who were either witnesses or passengers on the train corroborate the statement of the policeman. The motorman stated that the hedge and sign hid the automobile from his sight.

AUTOS ARE CARRIAGES IN MEANING OF LAW.

Massachusetts Supreme Court Holds that Highways Must Be Kept in Safe Condition for Use by Them—Sustains Verdict of Damages.

Special Correspondence.

BOSTON, Nov. 28.—By a decision of the full bench of the Supreme Court of Massachusetts, handed down last week, the automobile is adjudged a carriage within the meaning of the statute (R.L. C5L, Sec. 1), which provides that highways must be kept in a state of repair by towns and cities so as to be reasonably safe and convenient for travelers with horses, teams and carriages at all seasons. The court does not say that highways must be kept in such condition that automobiles can pass over them with assured safety, as it does not feel called upon to go into that aspect of the law in the case before it.

This important decision was brought about through a damage suit instituted by Joseph Baker, a chauffeur, against the city of Fall River. Baker was operating his employer's car through Bedford street, Fall River, last spring early in the morning. A part of the street was excavated for the laying of a drain, and a rope was stretched across a part of the street. Baker did not see the rope and ran into it. He tried to stop his machine, but could not, and was injured. Suit was brought against the city, and in the Superior Court Baker was awarded a verdict of \$175.

The defendants took an appeal to the full bench on the interpretation of the law as laid down by the presiding justice of the Superior Court. The city's main claim was that an automobile is not a carriage in the meaning of the statute governing the care and repair of roads, and that therefore the city was not responsible for injuries to a person riding in one upon its roads. The city claimed that when the statute was enacted automobiles were not in use, and therefore the Legislature of 1786 had no such thing in mind in making the law.

The decision of the Supreme Court was written by Judge Barker. Regarding the contention of the city, that the automobile is not a carriage within the meaning of the law, but is more like a machine, the court says: "Plainly an automobile is a vehicle which can carry passengers or inanimate merchandise, and so is such a carriage as the Legislature had in view in the use of that word in the statute. In the present case the alleged defect was one which would be dangerous to ordinary vehicles. Therefore, we now have no occasion to consider whether roads must be kept in such a state of repair and smoothness that an automobile can go over them with assured safety."

The court cites the established practice of considering a bicyclist able to recover for injuries received by a defect in a road that is dangerous to ordinary travel. The court also states: "The automobile is a vehicle in common use for transporting both persons and merchandise upon public ways."

The defendants claimed that the plaintiff should have turned out and gone to the left, instead of trying to run by the excavation on the right, and the court holds that he was obeying the law of the road and so should have kept to the right, as he did. The court overruled the exceptions of the defendant and plaintiff holds his verdict.

CHAUFFEUR'S CASE ADJOURNED.

George Mack, the chauffeur, who was held in \$500 bail charged with running down Jacob Clemons on Pelham Parkway,

near New York city, early in the morning of November 17, as reported in these pages, was arraigned before Magistrate Hogan in the Morrisania Court, New York, November 26. The case was adjourned until December 7 because Clemons was unable to appear, being still in a serious condition as a result of the collision. Counsel was engaged by the Westchester Gardeners' Association, of which Clemons is a member, to prosecute Mack.

A 17-year-old girl who was with Mack at the time of the accident has admitted, it is said, that she pinned around Clemons the blanket in which he was found wrapped, to make him as comfortable as possible until someone found him. Nearly a score of men and women, all said to have been members of the revelling party, were in the courtroom as witnesses.

BOAT MAKERS' MEETING.

Ten Members Admitted to the National Association—Show Space in Demand.

The executive committee of the National Association of Engine and Boat Manufacturers held a meeting at the association headquarters, 314 Madison avenue, New York city, on November 25. The report of the committee on exhibitions showed that nearly all the space in Madison Square Garden set aside for motors and launches at the National Motor Boat Show, February 21 to March 9, was either taken or spoken for.

Several applications for membership in the association were received, and the following were elected: James A. Reeves, representing the Western Launch & Engine Works, Inc.; Everett Hunter, representing the Hunter-Wechler Boat Co.; John A. Murray, representing Murray & Tregurtha; L. D. Huntington, Jr., representing the Huntington Mfg. Co.; Frank A. Brockway, representing the Lake Shore Engine Works; Thomas Stone, representing Thos. Stone & Co.; C. D. Holmes, representing the Auto Boat Co.; John W. Newbury, representing Newbury & Dunham; H. E. Danzenbecker, representing the Yacht, Gas Engine & Launch Co., and W. H. Mullins, representing the W. H. Mullins Co.

A membership committee was appointed consisting of the following: H. Newton Whittelsey, chairman; Albert E. Eldredge and J. S. Bunting.

During the first week of the show the association will hold its annual meeting, when addresses by prominent members will be made upon topics of interest to the members.

OUTLOOK FOR CLEVELAND SHOW.

Special Correspondence.

CLEVELAND, Nov. 28.—The Cleveland Automobile Dealers' Association and the Cleveland Automobile Club have been granted the week of February 21 for the annual automobile show, which will be held at Gray's Armory, as in former years. A number of those interested were in favor of holding the show this year in the Central Armory, which is considerably larger than the other quarters, but the plan was voted down because of the undesirable location of the Central Armory. There is every probability that there will be more applicants for space this year than can be accommodated, as the building was badly crowded last year, and there are more dealers and manufacturers in town now than ever before.

With eight automobiles plying the streets, DeKalb is keeping well up with the procession in this as in other things.—Advertiser, DeKalb, Ill.

PLEASING WINTER PROGRAM.

Lectures and Vaudeville to Be Given in
Pittsburg Club's New House.

Special Correspondence.

PITTSBURG, Nov. 28.—A strenuous winter program has been prepared by the entertainment and house committees of the Pittsburg Automobile Club. Lectures on motoring topics and first-class vaudeville are to be the special features, with box-ball and bowling always at hand. The handsome new clubhouse is open all days in the week and at all hours. A complete grill room has been fitted up in Antwerpian style and is proving immensely popular. The billiard room, which is being finished in Flemish oak and in tones of red and green, will be opened for use this week.

The triangular-shaped reception room facing east and south is as sunny and comfortable as it is luxurious in its antique furnishings. Both men and women attend the club functions, and several small informal dances have been given in this room.

At the rear of the reception room and directly across from the grill room is a small room partitioned off by rich velour portieres, where lunches may be served more privately, or where committee meetings may be held. Farther down the broad hall are the billiard room and the women's rooms.

Downstairs, on the main floor, are the long rows of lockers for motorists and the box-ball room, which is large and comfortable. No garage is kept by the club, but a number of garages are within two blocks of the clubhouse, and the new Hiland garage, which will open next week, is directly across the street.

The membership of the Pittsburg Automobile Club now exceeds 300 members, and a waiting list is soon to be formed. The initiation fee has been raised from \$5 to \$25. The treasurer of the club, Reuben Miller, Jr., is most energetic, and through his careful attention to details dues of every kind are paid promptly.

The recent club run, from Pittsburg to Zelionople and return, a distance of thirty miles, was participated in by thirty cars, of which only the pilot car fell by the wayside. The trip was most enjoyable, but it is to be deplored that over the rough fall roads a few men drove so recklessly as to cause ill will among the farmers. One prominent club member said: "No man who owned his own car put it through at so jeopardizing a pace."

MOTOR CLUB TICKET.

First Election of New York Club to Be
Enlivened by Moving Pictures.

The nominating committee of the New York Motor Club has prepared the following ticket for the first annual election of that organization, which will be held Thursday, December 8.; President, S. A. Miles; first vice-president, Charles H. Hyde; second vice-president, W. J. P. Moore; treasurer, A. L. McMurtry; secretary, Louis R. Smith; directors, Angus Sinclair, F. J. Griffin, Joseph Cowan and K. C. Pardee.

The club has taken a permanent home at Bretton Hall, Eighty-sixth street and Broadway, where an attractive suite of rooms has been leased. The organization has arranged for an interesting entertainment on the evening of the election, which will undoubtedly attract automobilists from all over the country who are in the city. The feature of the evening will be moving pictures of the principal automobile events

of the past season, in many of which the members of the organization took an active part. Among them will be the Vanderbilt Cup Race, the Mt. Washington Climb to the Clouds, the Eagle Rock Hill Climb and European pictures of the Gordon Bennett race, the Gaillon Hill contest and the Circuit des Ardennes.

EMERSON BROOKS, TREASURER.

A meeting of the new Board of Governors of the Automobile Club of America was held at the clubrooms, New York city, on November 23, the new president, Dave Hennen Morris, presiding. Samuel H. Valentine, the newly elected treasurer, resigned on account of pressure of other duties, and Emerson Brooks was appointed to preside over the club's finances for the coming year. Mr. Morris's election to the presidency left a vacancy in the Board of Governors, which was filled by the election of Winthrop E. Scarritt, the retiring president, to the governorship.

Considerable discussion was indulged in regarding the plans for a new clubhouse, but although ideas are becoming crystallized to some extent, nothing definite has actually been done. Many new members are coming in, and a large number of applications remain to be passed upon.

EX-PRESIDENT SCARRITT HONORED.

After the conclusion of the Eagle Rock hill climb, last Thursday, many of the officials, contestants and press men adjourned to the Orange Club as guests at luncheon of Harlan W. Whipple, president of the American Automobile Association. Advantage was taken of the occasion for the presentation by the governors of the Automobile Club of America of a 1905 White touring car to Winthrop E. Scarritt, retiring president of that organization, as a mark of esteem and of appreciation of Mr. Scarritt's efforts on behalf of the club and of automobilists in general. The presentation address was made by John A. Hill, of the technical committee of the club.

CHARTER FOR NORFOLK COMPANY.

Special Correspondence.

NORFOLK, Va., Nov. 26.—The Virginia Automobile Company to-day forwarded application to the corporation commission at Richmond for a charter, and will establish headquarters in this city as soon as possible. The principal objects of the company, which will have a capital stock of from \$10,000 to \$25,000, are to operate sightseeing automobiles and touring cars in Norfolk and its suburbs, and to act as selling agents for manufacturers of automobiles and auto boats.

The charter applied for permits the manufacture of automobiles of all kinds, and of power boats, and grants the privilege of transferring passengers and baggage to and from steamship and railroad depots, and to establish terminals or stations, in which restaurants and amusements may be installed. Authority is also given to own and operate race tracks and to hold races and automobile shows.

Officers of the new company for the first year are: President, Moses G. Nusbaum; vice-president, James W. McCarrick; secretary, J. Roy Collins, and treasurer, J. J. Hennelly. The board of directors includes, besides the foregoing persons, V. Trehy, Charles H. Consolvo, G. Sidney Yeager and E. C. Hathaway. All are prominent citizens of Norfolk. Secretary Collins is also secretary of the Virginia East Coast Automobile Association.

TO CENTRALIZE SALESROOMS.

Huge Building Will Be Erected in Cleveland for Auto Tenants Only.

Special Correspondence.

CLEVELAND, Nov. 28.—The Perry-Payne Company, one of the leading realty owning concerns of this city, hopes to create a new automobile center in Cleveland. The company is preparing to erect a building about 500 feet square, to occupy an entire square in the downtown section of the city, and which it is expected will be occupied exclusively by concerns manufacturing and handling automobiles.

Two years ago the company erected a magnificent power block, occupying the greater portion of the block bounded by St. Clair, Erie, Oregon and Murison streets, and the new automobile building is to be built on the square adjoining this. The structure will thus have streets on all sides, and can be provided with plenty of exits opening onto paved thoroughfares.

The building will be one story high, of brick, steel, cement and wire glass construction. It will be divided into ten sections of fifty feet each, but the dividing walls will not be placed until tenants have made definite plans as to space required. Over each section will be a sloping wire glass skylight, and there will be large plate glass windows on the street sides. The rooms will be arranged so that they can be used for garage, salesroom or manufacturing purposes.

The building is to be erected in answer to numerous demands for centrally located property suitable for automobile stations and manufacturing purposes. The Perry-Payne Company believes that it will have no difficulty in practically filling the building with concerns identified with the automobile industry.

NEW CANADIAN VENTURE.

Large Electrical Company of St. Catherines
Erecting Automobile Plant.

Special Correspondence.

TORONTO, Can., Nov. 28.—Following the incorporation of the Ford Motor Company, of Canada, to manufacture Ford cars on this side of the border, at Walkerville, comes the announcement of the intention of the Packard Electric Manufacturing Company to manufacture gasoline automobiles on a large scale for the season of 1905.

This will be a side line with the Packard company, which has a large plant at St. Catherines for the manufacture of incandescent globes and electric supplies. The St. Catherines city council has agreed to submit a by-law to fix the assessment on the industry at \$12,000, and this will be voted on shortly. The company is required to pay \$25,000 annually in wages, and to have the plant in operation by February. In the meantime it is going ahead with the erection of a building for the purpose.

The Packard company is a purely Canadian one, and has no connection with the Packard Motor Car Company, of Detroit. It will turn out a car of exclusively its own model, and not at all similar to the Packard car. The name also will be different.

Seventy automobiles are owned and operated in Nashville, Tenn.



A run on a bank at Willoughby, twenty miles from Cleveland, Ohio, was stopped one day last week by quick work with an automobile. The idea was suggested by a similar emergency run, made from Columbus to Lancaster, Ohio, a short time ago. The run last week threatened to close the Willoughby branch of the Wade Park Bank, of Cleveland, and banks of that city were telephoned to for assistance. The officers of the Euclid Park Bank piled \$75,000 into the tonneau of a touring car and told the chauffeur to break the record to Willoughby. The trip was made in less than fifty minutes, and when the crowd saw the men unload the bags of currency the run began to dwindle, and in an hour the trouble was over.

One of the largest orders ever received by an automobile concern was that turned in to the Pope Motor Car Co., of Toledo, by its western representative, F. M. Keeton, last week. After a three-weeks' trip, Mr. Keeton returned with orders for 180 cars, aggregating in value \$649,100. The consignments are to be as follows: Chicago, \$379,000; St. Louis, \$87,500; Kansas City, \$52,500; Omaha and Denver, \$35,000 each; Lincoln, Neb., \$25,500; Davenport, Ia., and New Orleans, \$17,500 each. Although the company is behind in its orders, owing to the demand for cars, partial shipments will be made to all these cities in a few days, and it is hoped that the final shipments will be made within a month.

The Cameron cars, which have been made by the United Motor Corporation, of Pawtucket, R. I., will be constructed hereafter by The James Brown Machine Company, also of Pawtucket, one of the oldest machine manufacturers in the country, established since 1820. For the season of 1905 the concern, which has succeeded the United Motor Corporation, will put on the market a two-cylinder 8-horsepower air-cooled car and a three-cylinder touring car. It is expected that at least 800 cars will be placed on the market for the season.

The announcement of a complete line of four varieties of Winton cars for 1905 has greatly increased the demand for the Winton agency, but dealers will have to be unusually well equipped to secure the agency. A prospective agent is required not only to give details of his financial standing, but he is requested to fill out a blank with description of his establishment, number of men employed, facilities for storing and repairing cars, and location with reference to the business district.

Sanctions for local shows have been granted by the National Association of Automobile Manufacturers to the Cleveland Automobile Club for February 20 to 25, and to the Automobile Club of Buffalo for March 6 to 11, 1905. The national and local shows sanctioned to date are, in their order, as follows: New York, Philadelphia, Chicago, Detroit, Cleveland, Toronto, Buffalo, Boston and Washington.

O. L. Remington, representing William McLean & Co., of Melbourne, who handle exclusively in Australia the products of a number of American automobile accessories concerns, sailed for England and the Continent last week after spending several weeks in this country. He expects to return to the United States about December

21, on his way back to Australia, and will spend a few days in New York. His company is now laying plans for entering vigorously into the automobile trade, and is open to negotiations from manufacturers with meritorious lines to offer who desire Australian connections. While in New York, Mr. Remington's address will be the Astor House.

The dastardly trick of squirting ammonia into the eyes of a policeman, which originated in New York, has found an imitator in Cleveland, and the police are anxious to locate him. A few days ago a member of the bicycle squad undertook to stop a driver who was breaking the speed ordinance. He got alongside the car, when he was suddenly blinded by a stream of ammonia. He fell from his bicycle, badly bruising himself, and it was some time before he recovered his vision.

The automobile bus line established recently in Philadelphia over a route extending from Fifty-second street and Lancaster avenue to Meriondale, and discontinued after two days' operation, owing to the breaking of the crank-shaft of one of the two cars composing the rolling stock, may not be re-established until January 1. The short time of operation developed several defects in the cars, and they will be given a thorough overhauling before they are again put in service.

An automobile repair shop has been opened at 22 Plain St., Albany, N. Y., by James Bradley and G. Feltman, who have purchased a building at that address and fitted it up with machinery and tools suitable for automobile work. The main floor is 100 by 40 feet wide, and there are three other floors, all connected by an elevator. The main floor is available for storage and sales purposes. The owners are open to the appointment of an agency.

W. S. Howard, who was in charge of the automobile department of the Charles L. Seabury and Gas Engine & Power Co., of Morris Heights, N. Y., last year, has formed a new company, at Yonkers, N. Y., which has been incorporated with \$50,000 capital stock, under the name Howard Motor Car Co., and is now building its first lot of twenty-five cars for the season of 1905.

The City Transfer Co., of Tampa, Fla., has added to its string of passenger transfer vehicles an automobile bus, seating twelve persons, which will be used in conveying passengers to and from the depots and hotels, or to other parts of the city. The fare to any part of the city will be 25 cents for each person.

Bakersfield, California, now has fifteen automobiles, and the Bakersfield Automobile & Cycle Co. has opened a garage and salesroom, the proprietors being L. P. Signer and H. I. Arms. Mr. Signer spent two years in the Pierce factory, and is well qualified to attend to the requirements of automobilists.

William P. Gray and Edward Shanks left Louisville on Thanksgiving eve for an automobile tour of the Blue Grass Region of Kentucky. They visited the towns of Shelbyville, Frankfort, Georgetown, Paris, Lexington and Harrodsburg, and, returning Sunday afternoon, reported a delightful trip. The weather in that section

has been very mild and dry. The roads were, therefore, in good condition, except for much dust.

Mr. and Mrs. A. J. Briggs, of Des Moines, Ia., left that city November 26 for an automobile tour to Florida. They expect to arrive at Palm Beach about the middle of December, provided, of course, they are favored with reasonably good weather.

The firm of Whitten & Clark, automobile dealers, of Springfield, Mass., has reorganized, Mr. Whitten having resigned, and the concern will hereafter be known as the E. R. Clark Automobile Station. The Thomas car will be handled by the new concern.

The Fisk Rubber Tire Co., of Chicopee Falls, Mass., has taken out a license to manufacture the Bailey "Won't Slip" tire treads, which will be supplied on the Fisk detachable tire in all standard sizes.

Jerome A. Ellis, of Chicago, has ordered a 70-horsepower Apperson Bros. car, to be built on lines similar to his present 40-horsepower car of the same make.

A patent on the construction of the Jewel mica spark plug was granted to Ed. B. Jacobson, assignor to the Pittsfield Coil Co., on November 8.

The Autocar Equipment Co., of Chicago, Ill., has removed to 240-244 West Lake St., Chicago, where its new factory is located.

RECENT INCORPORATIONS.

Hammer Motor Co., Detroit, Mich.; capital \$10,000. Incorporators, Henry F. Hammer, Leon J. Paszki, Foster W. Allen and Harry W. Nichoolk.

Flint Auto Brass & Aluminum Co., Flint, Mich.; capital \$25,000; to manufacture machine-finished brass, aluminum and other metal castings, wood rims, brass and metal auto rails, auto parts and sanitary finishings for automobiles. Officers, James W. Hines, president; J. George Snyder, vice-president; Thomas D. Buick, secretary, and Bert J. Smith, treasurer.

Wayne Automobile Co., Detroit, Mich. (formerly a partnership company); capital \$300,000; to manufacture automobiles. Incorporators, Roger J. Sullivan, William Kelly, Chas. L. Palms, E. A. Skae and J. B. Brook.

Seneca Automobile Co., Rochester, N. Y.; capital \$10,000; to manufacture motors. Incorporators, F. H. Clum, G. W. Robeson and A. H. Dalzell.

National Automobile Co., Jersey City, N. J.; capital \$250,000, in common stock. Incorporators, Louis B. Dailey, H. O. Coughlan and B. Stafford Mantz.

McDuffie Automobile Co., Chicago; capital \$2,400; to manufacture automobiles. Incorporators, J. H. McDuffie, W. E. Harvey and H. L. Babcock.

International Auto Sight Seeing Co., New York; capital \$15,000. Directors, Martin O'Neill Galvin, Florence J. Sullivan, Thomas T. Graham.

Kensington Automobile Co., Camden, N. J.; capital \$100,000. Incorporators, V. W. Sipes, D. G. Cameron, E. C. Huselton and H. A. Tucker.

Union Automobile Mfg. Co., St. Louis, Mo.; capital \$12,000. Incorporators, Benjamin B. Hulbert, George H. Martin and George B. Louderback.

THE AUTOMOBILE

WEEKLY

NEW YORK—SATURDAY, DECEMBER 10, 1904—CHICAGO

10 CENTS

MILITARY TESTS OF TRACKLESS TRAIN.

THE recognition of the vast possibilities of the automobile for army use has been even more rapid than its appreciation for ordinary commercial ends, and the primitive experiments of two or three years ago with ordinary touring cars and trucks have produced a large number of special vehicles for military uses. The war departments of the great nations are already on the alert to avail themselves of the latest developments in this special field of motoring.

The Renard automobile train, the invention of a French officer, was introduced at the Paris show of last winter, and has since been in practical operation in France. One of these trains has been ordered by the German War Office, and recently made its way by road under its own power from Paris to Berlin.

Upon arrival at the German capital the train was very thoroughly tested in a series of maneuvers in the presence of the Minister of Agriculture, Herr von Podbielski; the Chief of the General Army Staff, Count von Schlieffen; the Quartermaster General, Lieut.-General von Moltke; the Chief

Starting from the military balloon depot, the train was fully explained by the president of the German Officers' Club, Herr

ground of Berlin, and run successfully over rough ground. It is probable that the new train will find a place in the rapidly grow-

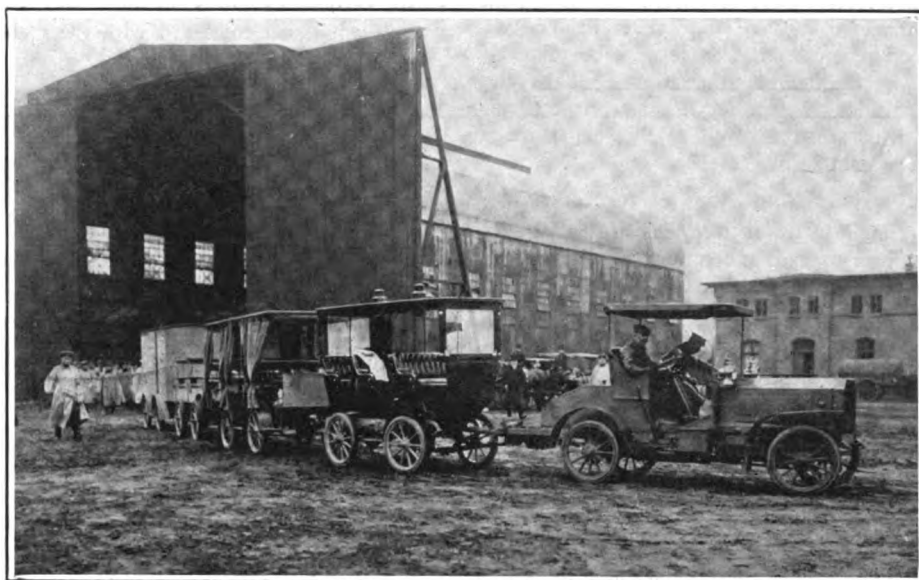

RENARD AUTOMOBILE TRAIN EMERGING FROM GERMAN ARMY BALLOON SHED IN BERLIN.



DEMONSTRATION TO SHOW HOW EACH CAR FOLLOWS IN TRACKS OF LEADER IN TURNING.

Quartermaster, Lieutenant von Gayl; Count von Merbach, of the Upper House, and staff officers of the War Office and the railway and traffic regiments.

von Wedel, and by M. de Pomian, representative of the builders, and some practical tests were made, after which it was taken to the Tempelhofer Field, the big drill

ing automobile division of the German army.

In the Renard train the first car is a strongly built automobile, with a Darracq motor of 60 horsepower, driving on the rear wheels in the usual manner, and also carrying a supplementary shaft fitted on the rear end with a coupling and universal joint. Each individual car of the train is similarly fitted with a section of shaft for its full length, with a universal coupling on each end, this shaft being geared to a second short shaft, which in turn drives the rear wheels in the usual way. In this way there is no traction on the part of the motive car, and consequently no need for the great weight and heavy wheels required in the old type of traction motor.

The steering is effected in a similar manner, each following car being positively steered in the track of its leader, by means of shafts and gearing controlled by the driver of the motive car. The train as a whole is thus under far more perfect control than where the cars are merely drawn after a tractor.

Motor Exhibits at the Stanley Show.

First London Exhibition of the Season Reflects Growing Popularity of Motorcycles, "Tri-Cars" and Light Automobiles.

Special Correspondence.

LONDON, Nov. 26.—The twenty-eighth annual Stanley Cycle and Motor Show was opened at the Agricultural Hall, London, on Friday, November 18. Although in reality a cycle show, the motorcycles, and in a few cases motor cars, staged by some of the exhibiting firms, give it a claim to the added title of motor show.

In England the sport of motorcycling has taken hold of a rapidly increasing section of the community; in fact, from a government return it appears that in the first half of this year more than 30,000 motorcycles were registered, surpassing the number of motor cars by several thousands. Consequent to this state of affairs, nearly every English manufacturer of pedal cycles has added a motorcycle department to his works, and the result of this departure is very evident at the show.

HEAVY AND LIGHT MOTORCYCLES.

Single-seated motorcycles are to be seen on every stand, and some are quite worthy of note. The Humber Company has a complete range of models fitted, as usual, with chain transmission. The 3-horsepower machine, weighing about 160 pounds, and capable of speeding up to forty miles an hour, is retailed at £45 (\$225), and seems a very popular mount. As a contrast, a 2-horsepower model, weighing only seventy-one pounds when ready for the road, is on view.

Other firms follow in line, most of them having a heavyweight machine of about 3 to 3 1-2 horsepower, with a 2-horsepower model weighing less than 100 pounds. The

average prices range from £35 to £45 (\$175 to \$225).

The Belgian Minerva Company, although not an English firm, has many models on exhibition and its machines are most frequently seen on the road. This time the company has quite astounded the English motor trade by retailing its machines at £27, £29 and £32 for the 2 horsepower, 2 3-4 horsepower and 3 1-2 horsepower, respectively. One of the novelties in the motorcycle line is the 4-horsepower "F. N." machine, made by a Belgian firm. This has four small vertical cylinders in line, and the magnificent finish combined with the com-

outside diameter flywheel carries the friction clutch and from here the power is taken to the gear box by a shaft with universal joints, to allow for any springing of the frame. Within the gear box are three gears of the usual Panhard sliding type. From the gear box a propeller shaft leads to the rear wheel, which receives the drive by means of a worm, or skew, gearing. Foot pedals are fitted to work the clutch as on a car, and also an enclosed expanding band brake on the back wheel. A side lever changes the speeds and a similar lever sets the brakes on the front wheels. Steering is by wheel, the column being supported on ball bearings, and is of the irreversible Ackerman type. A large bucket seat, well suspended on springs and upholstered, is provided for the driver, and a long and comfortable carriage for the passenger in front. Pneumatic tires, size 2 1-2 inches, are fitted to the wheels, which are covered by wide mud-guards. Many other excellent

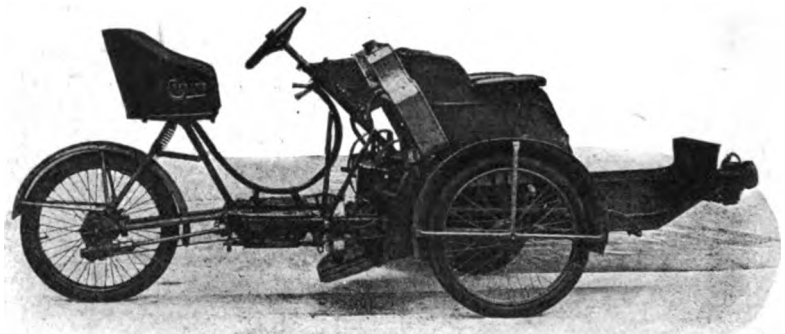

GARRARD 8-H.P. "TRI-CAR," A TYPE OF VEHICLE POPULAR IN ENGLAND.

paratively low price of £48 makes this a popular motorcycle.

Leaving the motorcycles pure and simple, we come to a kind of hybrid, which has a position between the motorcycle and the small car. This is the "tri-car," or "fore-carriage," a type of three-wheeled car, steering with two wheels in front and the single rear wheel taking the drive of the engine. The driver sits over the back portion of the machine, while the passenger is seated in a well-sprung basket chair between the front wheels. This type of motor has so far advanced in public favor during the past two years that it is now a serious rival of the small car of 6 horsepower or thereabouts, which type the fore-cars easily surpass in point of numbers. Perhaps a description of one of the most up-to-date models would be of interest to American readers.

THE GARRARD TRI-CAR.

The Garrard tri-car is made by the Garrard Engineering Company, of Birmingham. Power is supplied by a two-cylinder engine, set athwart of the front part of the frame. Each cylinder is 85 mm. by 85mm., bore and stroke, and the engine develops 8 horsepower on the brake. The cylinders are water cooled, pump circulation with tank and radiators being adopted. The 14-inch

devices are fitted, among which are two sparking plugs in each cylinder, so that if one fails the other can be switched into use. There is also a wipe contact breaker, which by means of bevel gears and a long shaft runs on the center of the steering wheel, so that the rider has the engine ignition under his notice continually. This machine weighs complete about 460 to 480 pounds and is priced at £130.

This type of machine is extremely popular and one or more are to be seen on nearly every stand.

ROVER LIGHT CAR.

Owing to an agreement made by the promoters of the Stanley show with an opposition firm, only a limited number of cars are displayed. Several of those shown are well worth examination, and in particular the Rover light car is very interesting. This car, made by the old established Rover Cycle Company, Ltd., of Coventry, made its first appearance in the light car trials at Hereford, at the end of last August, where it was put out of the running by a broken timing wheel, after doing very well for two days. The car possesses many unique features, the most notable of which is that it has no frame. The engine, gear-box, shaft casing and back axle casing form one continuous girder. To the front

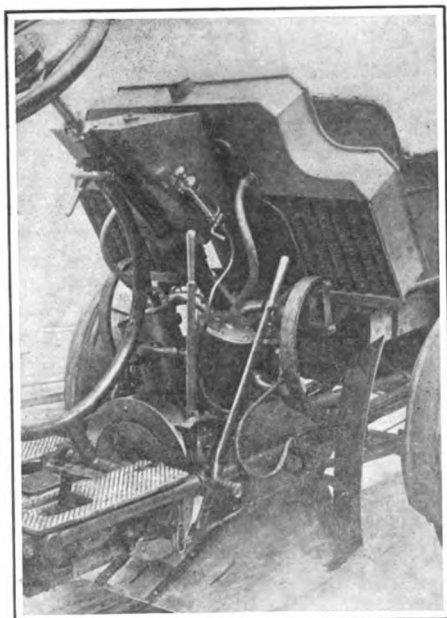

GARRARD MOTOR, TANKS AND RADIATOR.

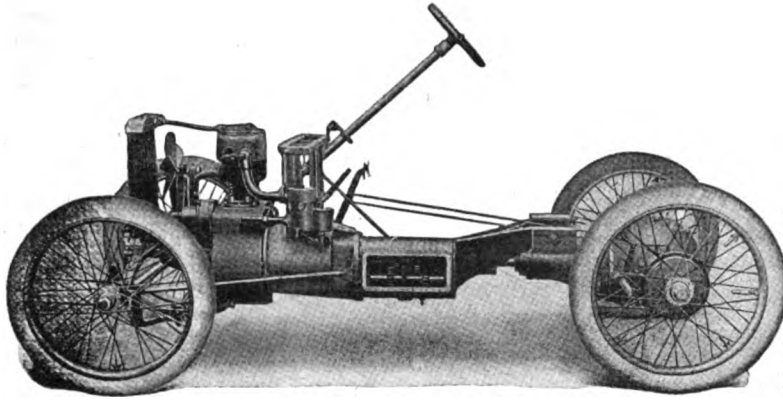

UNIQUE CHASSIS OF ROVER FRAMELESS ENGLISH LIGHT CAR.

of the engine the axle and front wheels are pivoted on a swivel bearing, on which also the front portion of the body is suspended, the rear part of the body being supported on springs attached to the casing of the back axle. The engine has a single water-cooled cylinder of 112 mm. bore and 125 mm. stroke, developing 8 horsepower at 900 revolutions, although it can be accelerated above this speed. Three flywheels—two inside of the aluminum crankcase and one externally fitted—are used, their total weight being more than 120 pounds, or one-eighth of the total weight of the car. In this way a very steady running engine is obtained, with good hill-climbing powers. The crank bearings run on ball races, and ball bearings are used throughout the car wherever possible.

The cams working the valves are very interesting; normally, the valves work in the usual manner, but by an ingenious mechanism the cams are altered and the lift of the valves is gradually reduced till the engine is running at any desired speed. By a further change the engine sucks air in every time, and, as the air is compressed at every alternate stroke, the engine acts as a powerful brake. Ignition is effected in

the usual way by means of accumulators and coil. The water circulation is maintained by means of a double-bladed propeller pump, and so efficient are the radi-

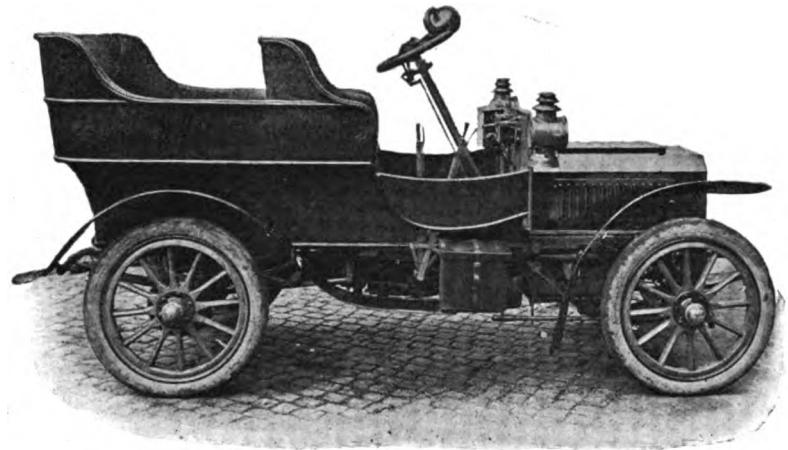

HUMBER 8-10-H.P. FOUR-CYLINDER LIGHT CAR WITH THREE SPEEDS.

ators that only one-half a gallon of water is carried.

From the engine the power is transmitted through a metal-to-metal clutch to the gearbox, where sliding gear wheels provide three

speeds forward and a reverse. Thence a shaft transmits the power to the differential by a bevel gear, which drives the live rear axle.

Other notable features on this car are the steering, which is worked by wires from the bottom of the steering column, and the Rover automatic carbureter, which provides a uniform mixture to the engine at varying speeds. A tank carries five gallons of fuel, enough for 200 miles over ordinary roads. The weight of this car complete is 10 1-2 hundredweight (1,050 pounds), and the price is £200, with two-seated body.

This car will climb all ordinary grades on top speed, and on first speed will mount a 20 per cent. gradient. With ordinary gears a Rover car reached a speed of thirty-two miles an hour at the Blackpool trials. Great interest is centered in the Rover exhibit at the show.

HUMBER FOUR-CYLINDER LIGHT CAR.

Another light car exhibited for the first time, and which is of interest, is the 8-10-horsepower Humber. This car has a four-cylinder engine—an unusual feature in light car construction—which develops 10 horsepower on the brake. An aluminum clutch covered with leather is contained in the flywheel, and by a simple device four points project and give gradual engagement, thus preventing jerking when starting. The transmission is entirely by gear. The Panhard type change speed gives three speeds of eight, eighteen and thirty-two miles an hour, and a low speed reverse. The frame is tubular and combines rigidity and strength with lightness. Gasoline sufficient for 150 miles is carried in a tank under the seat, and all important moving parts are oiled from a pressure sight-feed lubricator fitted on the dashboard. The standard type of body holds three persons, having a seat for the driver and two at the rear, which are reached by passing the driver's seat from the front. Artillery wood wheels, size 28 inches by 3 inches, are fitted with Michelin tires as standard. The car has powerful brakes. The total weight is only 11 1-2 cwt. (1,150 pounds).

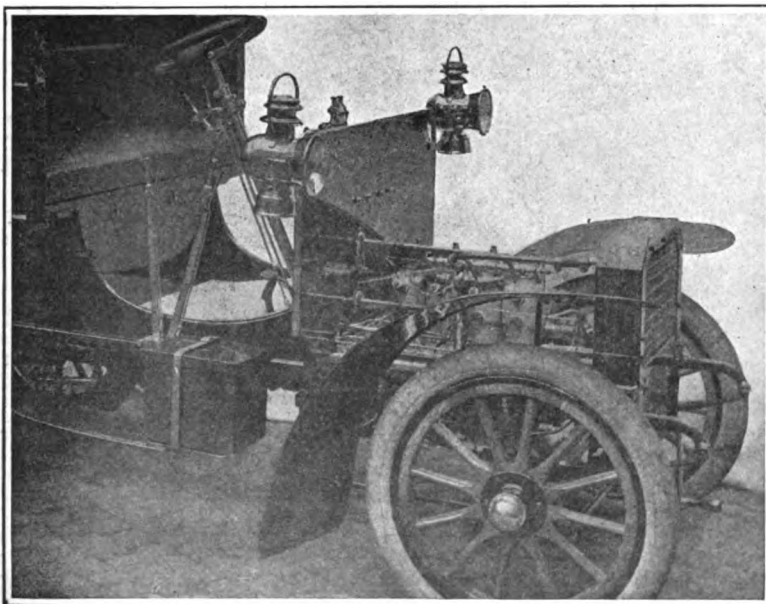

ENGINE AND CONTROL MECHANISM OF HUMBER THREE-PASSE GER CAR.

This car has been run for some months on the road, and is now quite out of the experimental stage. The price of the standard car is 225 guineas (\$1,180).

STAR TWO-CYLINDER CAR.

The Star light car should also be mentioned. This is fitted with a 7-horsepower, two-cylinder engine, with automatic governor. Three speeds and reverse are provided by sliding gears and power is transmitted to the rear wheels by side chains. The frame is made of wood, strengthened with steel fitch plates, and wooden wheels with three-inch tires are on the standard model. This is a car which has given much satisfaction to its users, and gained an award in the light car trials. The price is £175 for two-seated body, and £190 with accommodation for three passengers.

The Siddeley 6-horsepower car, similar to the one which gained a gold medal at the Hereford trials, is on exhibition. It is listed at £175.

The rest of the motor exhibits consist of Horbick, Clement-Talbot and Darracq cars, of which last many fine specimens are shown.

The cars exhibited at this show are only a few examples of the English small car industry, which is rapidly rising in importance. At the Crystal Palace show in January, and the Olympia show in February next, light cars will be present in great numbers, and all the 1905 models will then be on view.

French Comment on the Show.

Special Correspondence.

LONDON, Nov. 20.—As a rival to the coming Paris show, with its array of gorgeous exhibits, the present London show would stand a very poor chance. There are, however, at "the Hall," as the Londoners call the Agricultural Hall, where the Stanley show has been held as long as the cycle and motor trades have existed, a great many novelties or improvements on old things which do not lack of interest.

Without going into a detailed description of the exhibits, one may note the general tendency, as the English people show in motor design the same uniformity of general practice which has always characterized their work in the cycle trade.

The general impression of one who has watched the development of design in England in all lines of the automobile industry is that of increased complication; having as an excuse, and a very acceptable and real one at that, increased efficiency.

The motorcycles, which last year were rather underpowered, and could not take their rider up any reasonable hill, are now ranging from 2 3-4 to as much as 4 1-2 horsepower nominal, and any of these mounts can now take its driver without pedalling anywhere a horse and carriage can go.

The general lines of all English motorcycles, which are also those of practically

all French ones, include a vertical high-powered engine, as near to front wheel as possible in order to obtain long and efficient belt drive; bottom bracket or pedal hanger well behind in ordinary cycle position, but with extra large width and chain line, 28-inch wheels, 2 1-4-inch tires, 24-inch frame.

The improvements which mark the difference between the various firms are automatic or mechanical inlet valve, the latter seeming to have the preference; magneto or accumulator ignition, the former, although in lesser number than the latter, seeming to have made great progress and to be about to carry the market; chain drive with two speed sliding gear change speed combined with bottom bracket; spring forks or seats, automatic carbureter.

The average weight of these machines is 125 pounds, and the average power 3 1-2 horsepower, average fuel capacity, 150 miles, most being machines with a long wheel base and a high frame.

The greatest novelty of the year is, however, not the new and improved motorcycle—which in fact seems to be on a decline on account of a pretended lack of sociability—but the "tricar."

American readers will not be slow to appreciate the lack of mechanical efficiency of these machines, the price of which is often higher than that of the average American runabout; and which are hardly any more sociable than a motorcycle and trailer, while much less so than a motorcycle and side carriage.

It is a wonder to all disinterested minds how the craze for such a vehicle has come

to a whole country, and it is a question which all of any experience ask themselves as to how long this fad will last; as it is to be hoped that it will prove to be only a fad.

When one remembers the utter failure of the Bollée three wheelers of six years ago, of which some of the tricars of to-day are almost exact copies, although their designers may not know it, one is simply frightened at the future of firms risking their entire capital in the manufacture of such things. It may be that these fears will prove entirely erroneous, but they are at any rate the expression of the ideas of many experts, both French and English, and might well be considered by all engaged in the manufacture of such vehicles.

The few light cars exhibited do not show much originality; they are mere copies of larger cars, built on well known principles and simply reduced both in size and quality in order to obtain relative cheapness; and are at the same time sold at a price a good deal higher than that of the average American runabout.

British Patent Office rules will, after January 1, 1905, be subject to an amendment providing that when an application for a patent has been made, the examiner shall, in addition to the inquiries he is directed to make by the Patents Act of 1883, investigate for the purpose of ascertaining whether the invention claimed has been claimed or described, wholly or in part, in any specification other than a provisional specification not followed by a complete specification, in any application for a patent in the preceding fifty years.

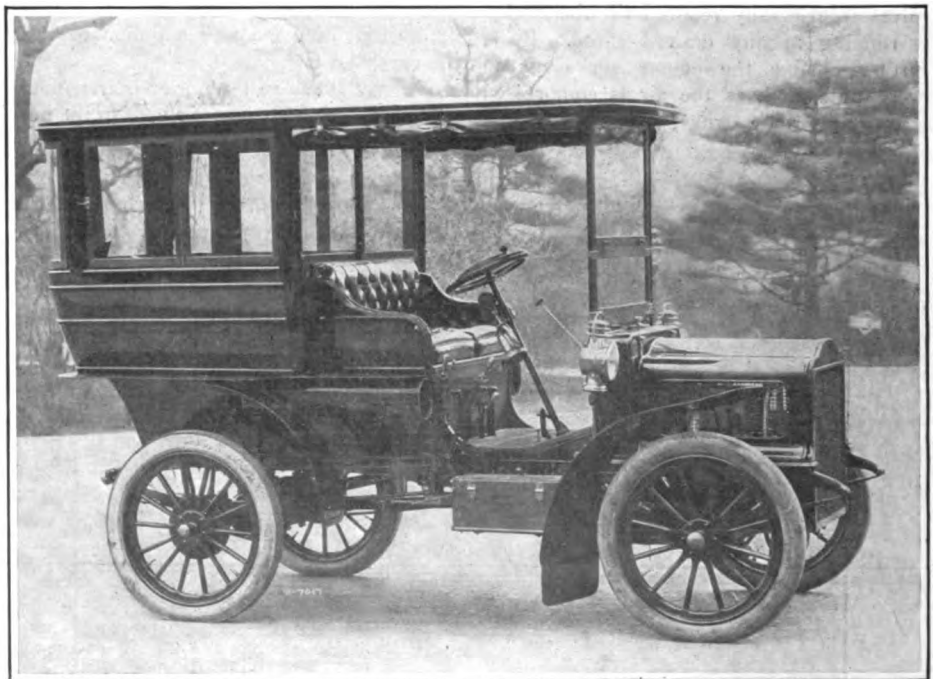

The engraving above is from a photograph of a 1905 model White steam car, fitted with limousine body, to the order of Charles A. Starbuck, of New York, to whom it was delivered last week. The interior seats four persons comfortably, is handsomely upholstered in Russian leather, and is illuminated at night by means of electricity supplied from a storage battery on the car. The windows are fitted with black silk spring roller curtains.

Simplex 30-H.P. Touring Car.

WORK is actively in progress upon a first lot of forty Simplex touring cars of 30 horsepower, built in design and construction like the 75-horsepower S. & M. Simplex special racing machine driven by Frank Croker in the Vanderbilt Cup race, except as to size and the slight changes necessary to adapt them to the different purposes. The severe testing that the racing car received has been of great value to the builders in getting out the touring car, although it is stated that the trials of the racing car served mainly to verify the correctness of the work already done.

The Simplex cars, which are about to make their initial appearance before the public, are of the four-cylinder vertical engine type, embodying what the designers believe is best in foreign and domestic engineering practice, and are built on the interchangeable plan throughout.

In placing the cars on the market the Smith & Mabley Manufacturing Company, Inc., will follow the foreign custom of selling the chassis without body, permitting the customer to have the body especially built to please his personal taste.

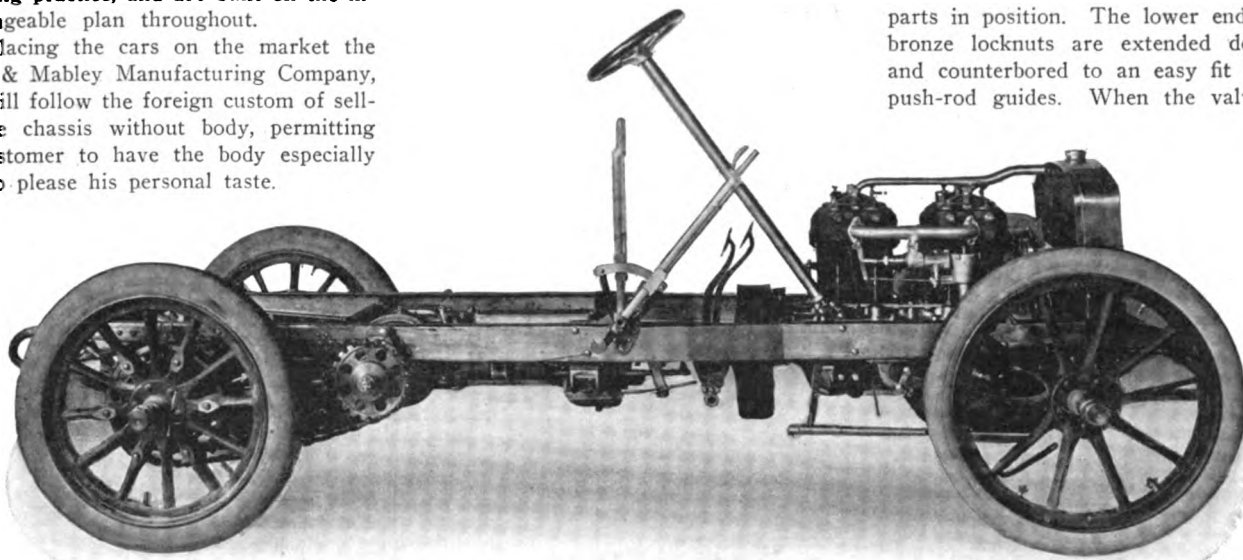

CHASSIS OF NEW 30-HORSEPOWER FOUR-CYLINDER SMITH & MABLEY SIMPLEX TOURING CAR.

Facilities for making every part of the cars are provided in the company's shops at 614 East 83d street, New York, with the exception of castings and a few special parts.

The chassis of the touring car, complete without body, weighs slightly more than 2,400 pounds. The wheelbase is 105 inches and the tread is standard. Drive is by side chains from a countershaft to the rear sprockets, and four forward speeds of approximately eleven, nineteen, twenty-nine and forty-one miles an hour are provided with reverse at eight miles an hour, the motor running at 1,000 revolutions a minute, and with standard touring sprockets.

FEATURES OF CYLINDERS AND PISTONS.

The motor is similar, in its main features, to the Smith & Mabley marine motor, of which a lot of thirty is being put through simultaneously with the cars. It is smaller, however, the bore being 4 1-2 inches and the stroke 5 1-2 inches. The cylinders are

cast in pairs, with integral heads and water jackets, an opening at the top through each cylinder head and water jacket being closed by a single plug that screws into the top of the cylinder and has a shoulder which forms a joint in a corresponding recess in the top of the water jacket. Gun iron is used for the castings and each casting is subjected to 500 pounds hydraulic pressure before it is passed. That this test is more than a formality is shown by the fact that in one or two cases cylinders have failed under the test and been rejected.

The pistons are very long, of light construction, and each is stiffened at the closed end by six deep interior ribs. Four packing rings are placed in separate grooves, all near the upper end. An oil groove encircling the piston is cut close to the lower

end. Oil is fed under pressure to this groove through the cylinder wall. The tool steel gudgeon pin, which is hollow, receives oil from the opening in the cylinder wall and carries it to an oil hole communicating with the bearing surface. The small end bearing in the connecting rod is solid, with bronze bushing, and the big end bearing is adjustable, a cap being secured by bolts and castellated nuts. Drop forged steel is used for the connecting rod itself, which is of I section. Bronze, with babbitt lining forms the crankpin and main shaft bearings, the latter being 1 7-8 inches in diameter and nearly 4 inches long. One intermediate bearing is placed between the two pairs of cylinders, and is of the same size as the outer bearings. Crankpin lubrication is effected by means of short tubes, screwed into the bearing caps and bent to point in the direction of rotation, so that they scoop the oil forcibly into the bearings. This system was used in the

motor of the autoboat *Vingt-et-Un*, and gave satisfaction.

The cylinders are finished by a process which closely resembles the conditions of actual use in its smoothing effect on the inner walls, provision being made for perfect accuracy in size and roundness. Pistons and rings are finished in the same manner, the manufacturers preferring this method to the grinding process.

VALVES MECHANICALLY OPERATED.

All valves are mechanically operated, a cam-shaft running along each side of the crankcase completely housed. Each cam-shaft, with its cams, is made in a single solid piece of steel hardened and ground, there being no separately attached cams. The push rods are hollow, carrying rollers at the enlarged lower ends, against which the cams bear, and being tapped at the upper ends to take the threaded ends of the valve stems. This allows of adjustment, and lock nuts on the valve stems hold the parts in position. The lower ends of the bronze locknuts are extended downward and counterbored to an easy fit over the push-rod guides. When the valves drop

under the pressure of the springs this arrangement acts as a dash-pot, easing somewhat the impact of the valves against the seats when the motor is running fast. This, in combination with the large fillets of the valves, tends to prevent the breakage of the latter. All the inlet valves are on the right-hand side and the exhaust valves on the left. The valves are seated directly on the cast iron and are removable through the usual openings above them, the covers of which are held down by yokes in the now customary manner.

The carbureter is a modification of the Mercedes type. Lubrication of the motor is by force feed, sight glasses being located on the dashboard.

THE COOLING SYSTEM.

A cellular cooler and tank combined is located as usual and circulation is maintained by a centrifugal pump secured to the crankcase on the left-hand side, where it is driven by gear and shaft from the half-

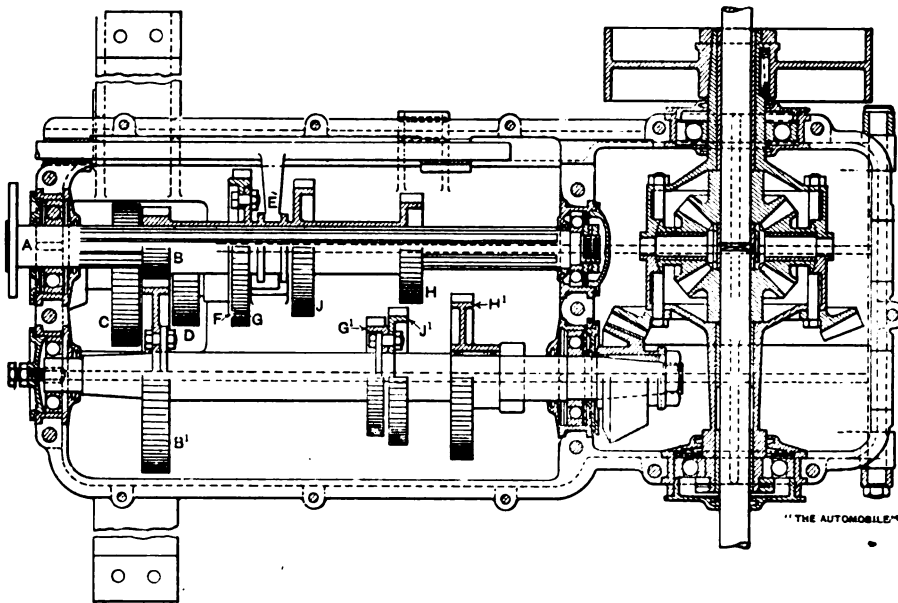

CHANGE-SPEED AND DIFFERENTIAL GEARING OF SIMPLEX CAR HOUSED IN ONE BOX.

time gears. Fiber and bronze gears, unusually large and with broad teeth, drive the cam shafts. These gears run very silently and their large contact line insures long wear, freedom from accidental breakage and accuracy of timing, even after long use.

The spark plugs are screwed into the sides of the inlet valve chambers, and the distributor, driven by the half-time gears, is located on the right hand side at the front of the motor.

ALUMINUM CLUTCH, LEATHER FACED.

The clutch, of the self-contained pattern is of aluminum, faced with leather, and may be removed by taking out the ring that retains it within the flywheel. It is of large size and great strength, features that are carried out throughout the power transmitting system. An interlock is provided so that application of the brake also throws out the clutch. The flywheel is of gun iron, finished all over, and weighs 100 pounds.

CHANGE SPEED AND DIFFERENTIAL GEARING.

The change speed and differential gears are enclosed in one aluminum case, the differential being on a countershaft, from the ends of which the rear wheels are driven by sprockets and chains, the rear axle being "dead." Four forward speeds and one reverse are given by the change speed gears.

In the accompanying drawing the first or slowest speed gears are engaged, the drive being through shaft *A* and gears *B* and *B'*. To engage the reverse, the gear-shifting fork *E* is moved to the left by means of its sliding shaft, which is moved longitudinally by the operating lever at the driver's seat. Gears *C* and *D* are mounted on a short countershaft below the shaft *A*, and together are movable to the left against a helical spring which tends to keep them out of mesh in their normal

position, as seen in the drawing. When gear *B* meshes with *C*, the countershaft revolves idly until the further movement of the lever brings an annular projecting face *F*, formed on gear *G*, against the side of *D*. This occurs just as *B* frees itself from *B'* and fully meshes with *C*. The gears on the countershaft are now forced

to the left, *C* and *D* maintaining their positions with relation to each other, and *D* meshes with *B'*, which is thus rotated in the reverse direction. When the gears are shifted back to the low-speed position the reverse countershaft with its gears is carried back to normal position by the spring. It will be seen that none of the reversing gears is in mesh when the car is running forward. For the second speed the sliding shaft is shifted to the right until *H* and *H'* mesh, while further movement in the same direction causes the successive meshing of *J* and *J'*, and of *G* and *G'*, the former giving the third and the latter the fourth or highest speed. Ball bearings of what is called the Mercedes type are used throughout the change speed and differential gearing.

The constructional details and the arrangement of the bevel gear differential are clearly indicated in the drawing. The differential brake drum is carried on the right-hand side, just outside the casing, and is of cast steel.

PRESSED STEEL FRAME.

Following modern practice, the frame is made of pressed steel, cold formed, the greatest dimensions being 4 1-2 inches deep, 1 3-4 inches wide and 3-16 of an inch thickness of metal. The top of the frame is 24 inches from the ground. A narrow front is

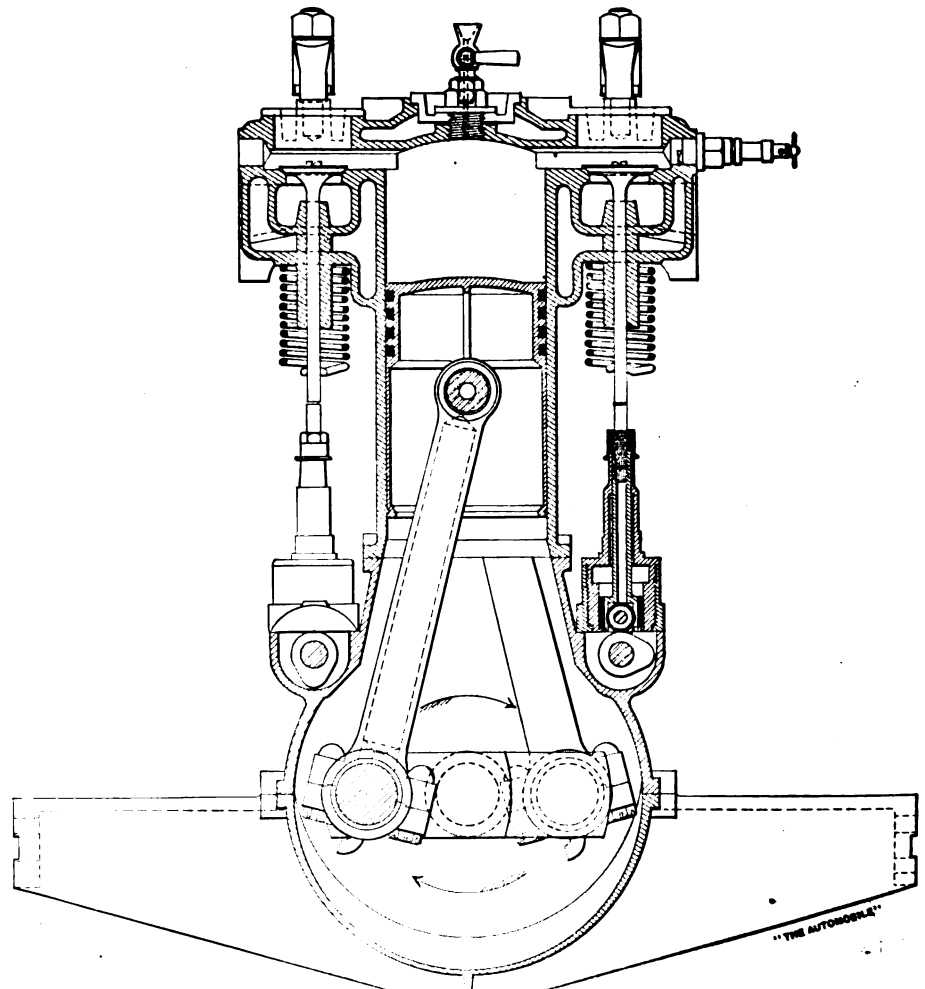

VERTICAL TRANSVERSE SECTION OF ONE OF THE CYLINDERS.

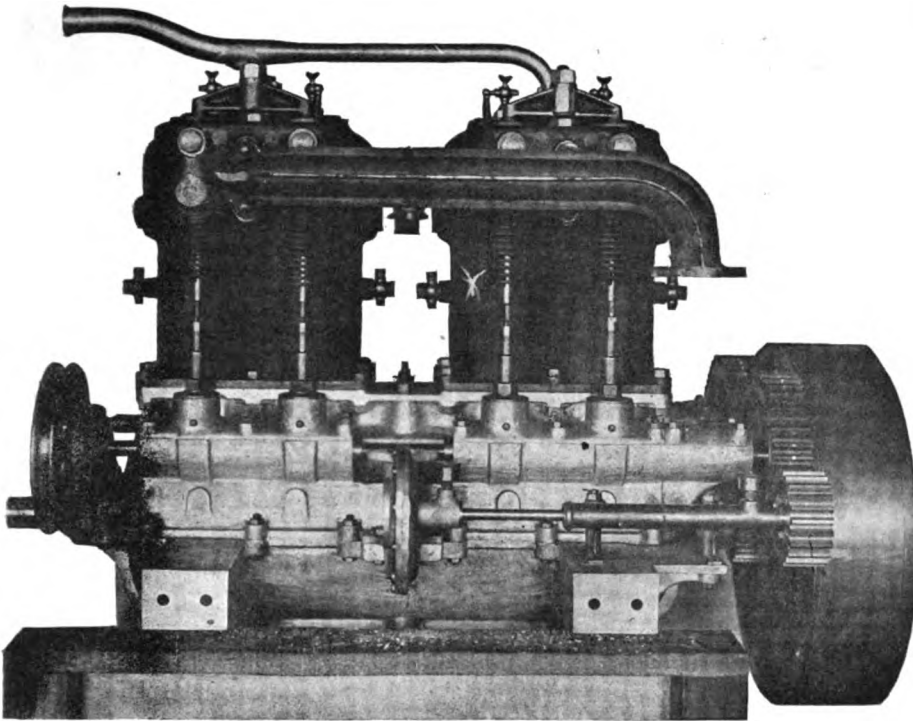

EXHAUST SIDE OF SIMPLEX MOTOR, SHOWING WIDE GEARS AND CIRCULATION PUMP.

secured by offsets just behind the motor space. Heavy cross members of I section support the motor and transmission gear box, but the frame ends are of the same material as the side members, securely braced at the corners. Steel forgings are used for the spring hangers, and are hot riveted to the frame, extending well back.

NOVEL DISTANCE ROD ADJUSTMENT.

Parallelism of the rear axle and the countershaft from which the rear wheels are driven is secured by the use of distance rods. Each rod is of heavy steel of I section, one end being flattened to form the rear axle connection and the other end round in section and hollow, the hole being tapped to receive a short, hollow rod, threaded for its full length outside and smooth inside, and having a hexagon head at one end. This piece screws into the hollow end of the rod and in turn receives the shank of the piece that forms the connection at the countershaft. This connecting piece extends through the hollow in-

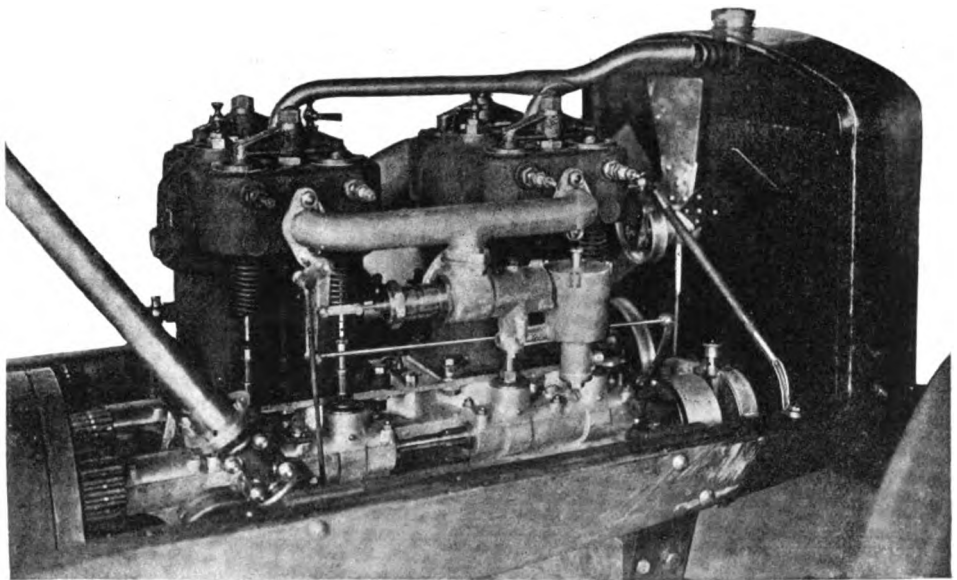

INLET SIDE OF ENGINE, SHOWING MERCEDES TYPE CARBURETER AND VALVE CAP YOKES.

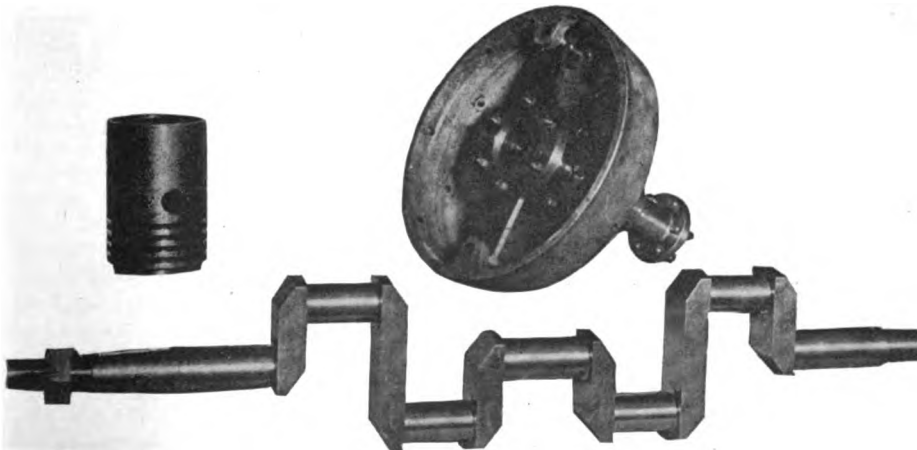

ALUMINUM CLUTCH, LONG PISTON AND FOUR-THROW CRANKSHAFT OF SIMPLEX CAR.

intermediate member in which it is an easy fit, and is retained in position by a nut pinned in place. By applying a wrench to the hexagon head of the threaded member, the rod may be adjusted as to its length without disconnecting the joints. A split lug on one side of the hollow end of the main rod, with a clamping bolt, provides a simple and efficient locking arrangement by which the adjustment is held. Steel forgings are used for this rod, which must be able to withstand considerable strain at times.

NEW IDEA IN SPRING SUSPENSION.

Semi-elliptic springs are used fore and aft, and these embody some ideas that do not appear at a casual glance. In order to secure the necessary flexibility without excessive range of movement, the rear springs are made with their rear portions quite short and stiff, while the front portions are considerably longer and more flexible. Under ordinary road conditions the greater part of the work is done by the long, flexible forward parts of the springs, but an unusually severe shock will quickly bring these down to a point where they offer as much resistance as the stiff rear por-

tions. When this happens the rear ends are brought into action and check the deflection before it becomes excessive. The rebound is prevented from being too violent by the fact that the stiff ends of the springs rapidly return to their normal state, while the flexible ends have not sufficient strength to cause a violent reaction.

In practice this system has given excellent satisfaction to the builders, the first severe trial having been given on Frank Croker's Vanderbilt Cup racing car, which was equipped with rear springs made according to this theory. This is now the standard suspension of the Simplex cars. The front springs, however, are of the usual semi-elliptic pattern, both ends being of the same strength.

EXTERNAL BAND BRAKES.

Brakes are all of the exterior band type, the drums being of cast steel and the bands of copper. The bands are made in halves, hinged at one side and provided with a powerful toggle joint at the other, to which the operating lever is connected by a steel cable. A spring acting on the toggle lever causes the brake to release when the operating lever is placed in the off position. Limit stops placed on each side prevent excessive movement of one-half of the band and insufficient movement of the other, with consequent dragging. Water, oil and dirt are stated to be equally incapable of impairing the action of this brake. The same arrangement, with slight modification in detail, is used for the differential brake on the countershaft. The drums are large and heavy, providing ample braking surface.

STEERING AND CONTROL MECHANISM.

Worm and sector steering gear of the usual type is employed, the worm being of

steel are used. The lower end of the pivot has a long bearing in a socket in the knuckle, while the upper end turns in a ball bearing, which serves to keep the pivot in line and prevents binding. The body of the pivot is bored out from top downward, and the hollow space is used as an oil reservoir, a hole leading from the bottom of the space communicating with a spiral groove cut on the surface of the lower bearing of the pivot. A steel cap covers the top of the hollow in the pivot, and a small oil-hole in the center of the cap is closed by a screw plug. The arms on the knuckles and the connecting rods of the steering gear are steel forgings, the joints being ball-and-socket.

Hickory wheels of artillery pattern are mounted on plain bronze bushed bearings. Rims and tires are imported, the latter being Michelin, 920 by 120 millimeters rear and 910 by 90 millimeters front. Front and rear axles are of forged steel of oc-

mixture may be employed as gasoline at 0.670 sp. gr. (79 degrees Beaume) and of 0.730 sp. gr. (61.7 degrees Beaume) in order to obtain a density from 0.680 to 0.685 sp. gr., but such a product is not satisfactory, for the heavier gasoline is not volatile enough to burn quite freely in the combustion chamber of the motor. A heavy petroleum requires more air than a light petroleum, consequently, if the carbureter is adjusted for a light product it will not be properly suited to a heavy oil in which there is generally a certain residual which will not be consumed, and a scale will be formed which will clog the motor.

Certain automobiles of the heavy type consume paraffine or petroleum oils. The advantage of this employment rests especially on the fact that such products are obtained more readily than gasoline, and that there is more security in their use. Gasoline is very inflammable, and its vapor is exceedingly liable to explosion, much more

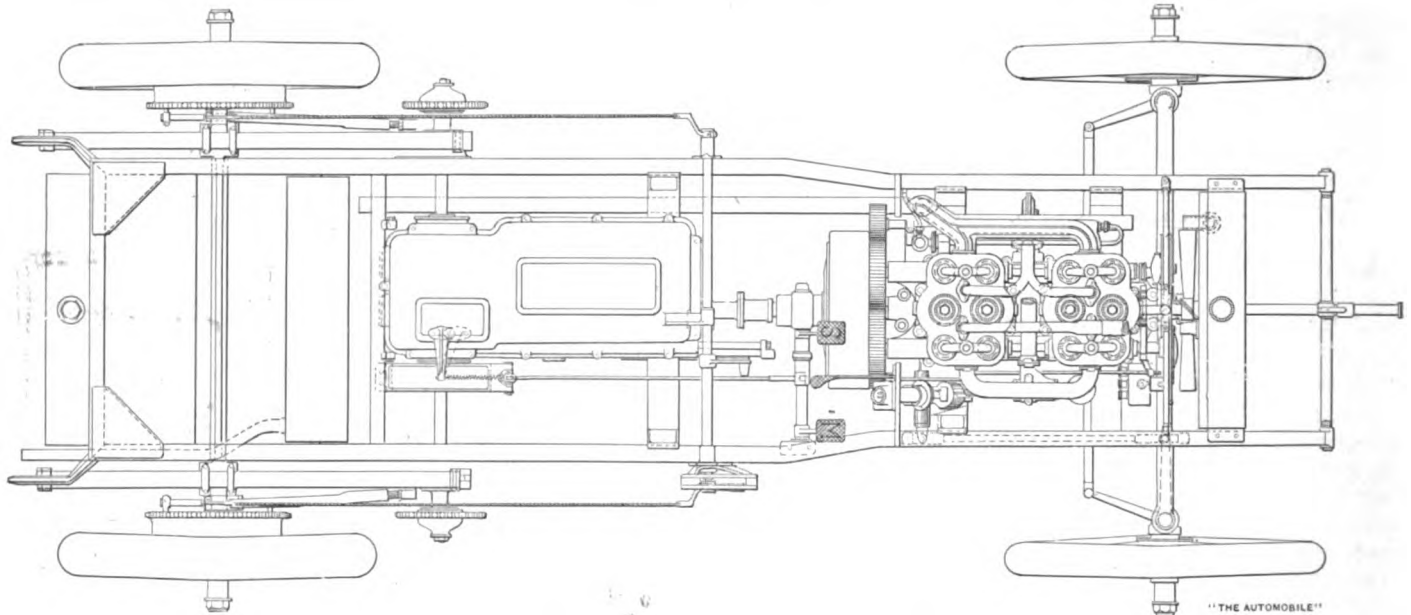

PLAN DRAWING OF SIMPLEX 30-H.P. TOURING CAR CHASSIS.

steel and the sector of bronze. The steering wheel is of wood and aluminum construction, and is keyed to the column with a steel key. Throttle and ignition levers are placed on top of the steering wheel, convenient to the fingers. Each lever connects with a quick-threaded screw and nut arrangement within the column, by means of which two steel rods, one operating the throttle in the carbureter and the other the ignition timer, are drawn up. As any force tending to push the rods downward would have the tendency to bend them, springs are provided on the bell-cranks, through which motion is transmitted, to produce the return movement when the levers are moved in the opposite direction. Thus the rods are subjected to tension only. The usual pedal accelerator works on the throttle.

STEERING KNUCKLE OILING SYSTEM.

Substantial steering knuckles of forged

tagonal section, and are heavy and substantial. The muffler is of steel, large size, and is located just back of the gear box, extending across the frame. The bonnet is of aluminum. Gasoline is carried in a heavy copper tank of twenty-four gallons capacity, hung at the extreme rear end of the frame.

Velvet bronze, the composition used for bearings in this car, is an alloy selected by the Pennsylvania Railroad for bearing metal after something like 1,000 tests of various compositions had been made. Every nut on the car is castellated or pinned.

A Note on Gasoline.

A recent study on the qualities which gasoline ought to possess for advantageous employment in automobiles has reached the following results. It should be very limpid, possessing a density of 0.680 to 0.690 specific gravity, and perfect homogeneity. A

so than that of petroleum oils. The flashing point of American oils varies from 73 degrees to 110 degrees F.; the flashing point of Russian oils, from 80 to 100 degrees F. Scotch oils vary from 105 to 120 degrees. It should not be forgotten that a motor employing oils having a low flashing point will work better than one employing Scotch oils, for instance. This quality must be kept in view in the use of petroleum oils in motors. —*Le Journal du Petrole.*

A Matter of Association.

Last year she simply would not wear
A glove from soil made clean;
Cleaned gloves, she said, disgusting were,
They smelled of gasoline.

This year a man who's wooing her,
He rides her miles and miles
In his new gasoline machine,
And she just smiles and smiles.

Digitized by Google Post.

The Claudel Kerosene Carbureter.

Designer's Theory of the Gasification of Heavy Oils, and Its Practical Application to Automobile Motors.

A LONG study of the difficult but very important problem of substituting kerosene and other heavy oils for gasoline in explosion motors has been made by H. Claudel, of France, who has invented a special carbureter to utilize kerosene oil that is attracting much favorable notice in Europe. In a recent issue of *La France Automobile*, Maurice Chérie gives a clear and full description of this new device and also of the inventor's theory of combustion in the gas engine, which is hardly less interesting than the carbureter. Following is a translation of the article.

In order that the oil shall produce its maximum thermic effect, resulting in a complete combustion at the highest possible temperature, it is necessary that at the instant of ignition its constituent elements shall be dissociated, brought to gaseous state, and brought into intimate contact with some exact quantity of air. The broad principles of the operation are fixed, but it still remains to discover the exact laws of this vaporization, which, in certain cases, remains incomplete and falls short of an absolute gasification.

VAPOR VERSUS GAS.

These two terms, vaporization and gasification, are not really synonymous, the difference between them being described by Mr. Claudel as follows:

Vaporization, in bringing to an atomic state the combustible particles, increases considerably their volume compared with that in a gaseous state; it also limits the combustion to the outer surface of each globule, and does not permit of the combustion of the central kernel, except to a limited degree and slowly under the action of certain elements in excess, the useless products from these resulting in a loss of heat.

Combustion from the atomic state shows two successive stages, the first being the combustion of the outer envelope, which leaves a mass of inert products isolating the central kernel. This kernel can be ignited only after the envelope of inert gases has been dispersed by the explosive wave or enriched by a waste of some valuable element. The kernel when superheated by this combustion of its surface is partially disrupted, and—in the case of a heavy oil—forms a deposit on the parts of the motor, enveloping them with a refractory substance which resents all attempts at lubrication.

To this imperfect combustion are due the fumes and acrid odors of the exhaust from kerosene motors, and also the necessity for frequent taking apart and cleaning, which make the heavy-oil motors so unsuitable for the continued service demanded in the automobile and the launch.

It is also true that the use of gasoline under such unscientific conditions is accompanied by fewer drawbacks than attend any other form of liquid fuel. The slight cohesion of its constituent molecules, due to its extreme volatility, facilitates their intimate mixture with other elements, and permits the convenient use of gasoline in the most perfect form of heat engine—the explosion motor, so highly rated for its absolute regularity, its power, and its economy. The physical qualities of gasoline are such that its vapor closely approaches a true gas; this characteristic especially adapting it for use in automobiles.

CHEMISTRY OF THE OPERATION.

The Claudel carbureter is designed especially for the complete disruption of heavy oils in accordance with the foregoing theory, the details being thus stated: If the vapor of water (H_2O) be mixed in a superheated tube or retort with the vapor of kerosene, and the molecules of oil be brought to the point of disruption, above 850 degrees, there results a transformation into oxygen and hydrogen; the oxygen in a nascent state, with the carbon, combines to form carbonic oxide, volatile and inflammable, and mixes freely with the other explosive gases and the free hydrogen, itself a highly inflammable gas. There results from this combination a reclamation of lost heat and a destruction of all the solid products of combustion.

If, on the other hand, in place of the vapor of water, one should introduce carbonic acid (CO_2) under the same conditions, the result will be a separation into carbonic oxide and oxygen ($CO + O$). The oxygen will transform the carbon into carbonic oxide before the production of coke; and this phenomenon, which will occur only in contact with the most highly heated parts of the retort, will induce a partial regeneration of the combustible elements at the same time that it will leave at liberty the inert gases, assuring the disruption of the remaining elements.

These two reactions may be produced separately or together; but where can one find the vapor of water and the carbonic acid? Most fortunately, the motor itself assumes the task of providing the oxidizing elements for its fuel, the exhaust gases from an explosion motor being composed, in effect, of the vapor of water, carbonic acid and nitrogen. The first two elements play their part in the oxidation of the carbon, and the third—nitrogen—far from being an obstacle, contributes its part to aid the disruption. It is necessary only to introduce in correct proportion and under proper means of regulation the exhaust from the motor into the retort of a carbureter to ensure complete gasification,

and with entire freedom from deposits of waste.

UTILIZATION OF THE HOT EXHAUST.

But, to avoid this phenomenon of carbonization, which would result if the fuel were projected in a liquid state on the walls of the retort, the oil is first brought to a state of superheated vapor; and, owing to its high temperature, the exhaust from the motor offers a convenient means to this end. In order to be assured of a perfect disruption of the oil particles, this part of the work has been made completely independent of the aspiration of the motor, and it is prolonged for the full duration of the cycle by the slow and evenly regulated introduction of the oil in a fixed quantity. The duration of this period of introduction is consequently four or five times longer than in the case of simple aspiration through a vaporizer.

By this sequence of several simple and elementary processes, a perfect gasification of heavy oils may be assured, with a maximum of thermic efficiency, and also a partial recovery of heat elements usually wasted; at the same time there is a total absence of a deposit of solid residuum encumbering the internal parts and interfering with the lubrication. It is, however, necessary to reduce the excessive temperature of the exhaust, which may attain a point harmful to the best operation of the motor; and to this end Mr. Claudel has introduced, as the oxidizing element, atmospheric air, composed of oxygen and nitrogen. The combustible mixture thus obtained includes a certain quantity of petroleum vapor, which is accelerated in its passage by the particles of fixed gas, the result being a combustion which is practically perfect.

MEANS OF AUTOMATIC REGULATION.

In the practical application of this theory the important point is the regulation of the various elements, which Mr. Claudel has endeavored to simplify and to make automatic. In his apparatus the aspiration of the motor produces an automatic introduction of the liquid fuel and of the air necessary to the oxidation of the coke, the air and the liquid being brought into contact in the interior of the retort, which is heated externally by the exhaust from the motor. The product of the resulting disruption of the oil is drawn by the aspiration from the retort to a mixing chamber, where it meets an additional supply of air drawn in after the usual manner by the aspiration of the motor.

The route which the liquid, in its transformation first to a vapor and then to a gas, is obliged to follow in contact with the proper quantity of air, makes certain the transformation of the coke into oxide of carbon, thanks to the oxidation produced by the air, which gives up almost all of its oxygen. The quantity of air supplied to the retort is proportioned to the amount of coke produced by the oil; and it is always very small in proportion to the amount of air re-

quired to perfect the final mixture. The passages from the retort to the mixing chamber, as well as the disrupting tubes arranged in the interior of the retort, are designed to produce such a resistance as may best facilitate the complete union of the elements in the mixing chamber. This resistance increases with the speed of the flow, that is to say, with the suction of the motor in the mixing chamber; it results, consequently, that when the speed of flow increases, the pressure in the retort decreases—and consequently the flow from the oil-supply orifice also increases, but in a lesser ratio than if the oil orifice were in direct communication with the mixing chamber or the main body of aspirated air. The various obstructions necessary to the disrupting and mixing operations are so arranged that the carburation is constant at the maximum, minimum, and all intervening speeds. With no movable part or regulator whatever, there is still a most perfect control of the carburation.

CONSTRUCTION OF THE CARBURETER.

Referring now to the apparatus itself and its mode of operation, the carbureter is composed of a double heating chamber *u*, in the center of which is placed the retort *m*. In the annular space included between the retort and the outer walls of the heating chamber, the exhaust from the motor circulates, entering by the pipe *k* and escaping by the pipe *l*. The position of the retort *m* is assymmetric with regard to the center of the heating chamber, in proportion to the supply and exhaust pipes, *k* and *c*; so that the amount of heat imparted to the retort may be regulated by the movement of the valve *i*, in Fig. 3.

With the valve *i* in the position shown, the flow of heated gases from the exhaust follows the course of the arrow *z*, being in contact with only a small portion of the circumference of the retort, and imparting but little heat. With the valve in the position *i'*, shown by the dotted lines, the current of gas, following the direction of

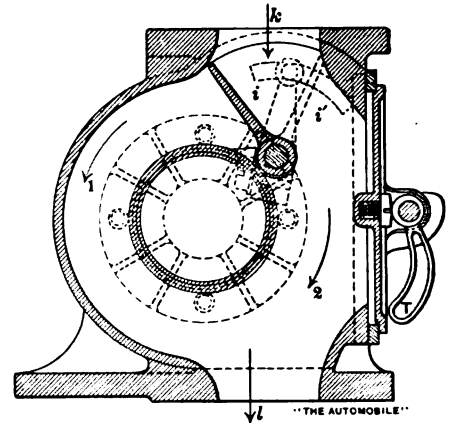

FIG. 3.—TRANSVERSE VERTICAL SECTION THROUGH RETORT AND EXHAUST PIPE. arrow 1, almost completely surrounds the retort.

The difference between the two passages is further increased by a very thin wall on the right of arrow 2, which may be in the form of a screen or damper permitting an ingress of outside air; while the wall on the left of arrow 1 is a part of the casting of considerable thickness, thus retarding the radiation. The valve *i* is operated by the lever and spring stop *j*, Fig. 1, while the cam lever *T*, Fig. 3, regulates and locks the cooling damper. By the proper adjustment of these two valves, and the diversion of the exhaust, the retort may be maintained at any desired temperature up to the maximum limit of the exhaust.

RETORT AND MIXING CHAMBER.

The retort is made of drawn tubing, which may be formed with an internal web *n*, increasing the heating surface and breaking the flow of the combustible contents. The retort is connected with the mixing chamber *y* by the tubes *o, o, o*, of such size and form as to act in connection with the web *n* to break up the various elements within the retort and to provide the throttling which is essential to automatic regulation.

The mixing chamber is provided with three openings; one for the main air supply, *p*; one for an auxiliary air supply, *s*; and one, *r*, for the passage of the mixture to the motor. An internal diaphragm directs the course of the air admitted by *p* and *s*, and regulates the suction according to the speed and other conditions. The opening *s* is fitted with a damper by which the auxiliary supply may be regulated according to the kind of oil used.

Attached to the mixing chamber is the float chamber *B* of the ordinary gasoline carbureter, with the float *b*, regulating the level of the gasoline which enters by the tube *a*, and which is discharged into the air of the mixing chamber by the nipple *c*, on first starting the motor.

The regulation of the heavy oil supply is through the float chamber *G*, and float *g*, the oil entering at *f*, under the control of the point *F*. The float *g* operates a lever, shown in Fig. 2, which acts on the upper end of the pointed rod *F*, the exact ad-

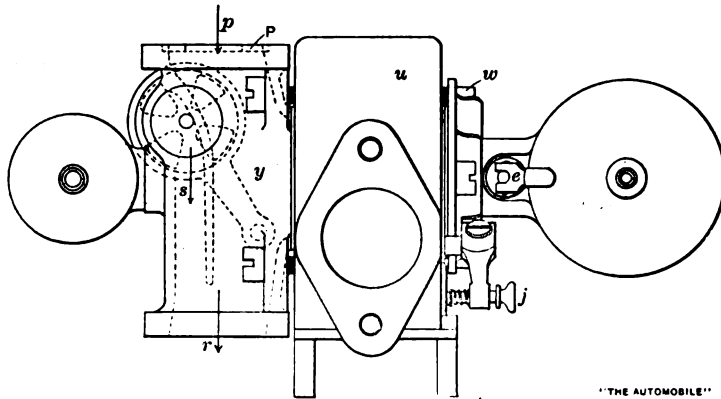

FIG. 1.—PLAN AND TOP VIEW OF CARBURETER. Dotted Lines Show Auxiliary Air Intake.

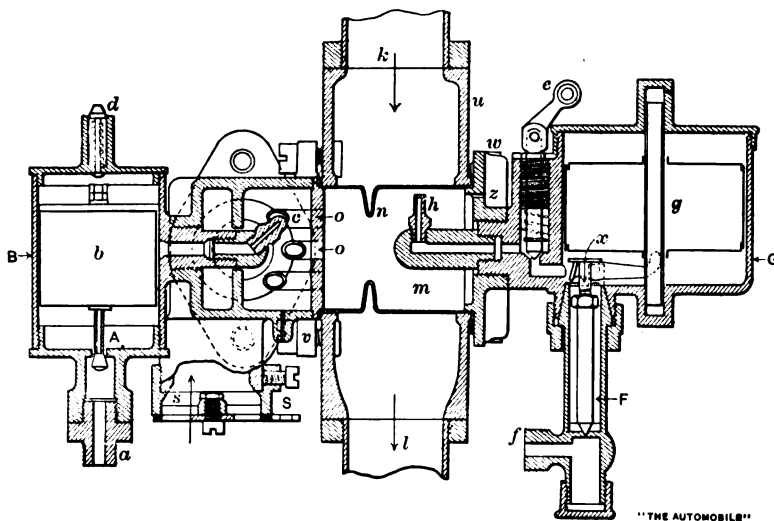

FIG. 2.—VERTICAL SECTION OF CLUDEL CARBURETER FOR HEAVY OILS.

A, Regulator for gasoline supply. B, Gasoline reservoir. F, Stop valve for oil supply. G, Oil reservoir. P, Damper of main air supply. S, Damper of auxiliary air supply. T, Locking lever of air damper of exhaust. a, Gasoline supply. b, Gasoline float. c, Gasoline feed nipple. d, Button for lowering float. e, Independent oil supply valve. r, Oil supply pipe. g, Oil float. h, Oil-feed nipple. i, Exhaust pipe valve. j, Stop and lever of exhaust pipe valve. k, Supply pipe from exhaust to carbureter. l, Discharge pipe of exhaust. m, Retort. n, Rib of retort. o, o, o, Mixing pipes from retort. p, Main air supply. r, Pipe from carbureter to motor. s, Auxiliary air supply. u, Heating chamber for retort. v, Drain. x, Adjusting screw of oil supply valve. y, Mixing chamber. z, Air duct to retort.

justment being made through the screw x and its nut. Between the discharge nipple h , within the retort, and the float chamber G is a spring valve operated by the lever e , Figs. 1 and 2, by which the passage of the oil may be controlled.

A very important detail of the retort is the plate w , which connects it with the oil float chamber, and which is pierced, as shown in Fig. 2, by a small opening s , which admits the necessary amount of free air in proximity to the nipple h .

METHODS OF STARTING.

In practical operation, the motor may be started by means of the auxiliary gasoline carburetor on the left, with a small reservoir for fuel, and when well under way and with the exhaust going, the gasoline may be shut off and the kerosene turned on. The motor may, however, be started directly on the oil, provided a torch is first used to heat the retort until a flow is secured from the exhaust.

The oil supply in the reservoir G is maintained at a constant level by means of the float g and its lever acting on the valve F ; the rate of feed through the nipple h is regulated by the amount of pressure within the retort m , which is in turn dependent upon the flow of the gases through the contracted opening of the rib n and the indirect passages of the mixing tubes o, o, o , which serve to alter the effect of the motor's aspiration and to make it prolonged and regular instead of intermittent. At the lower speeds there is very little resistance to the flow from the retort to the mixing chamber; but, as the speed increases and the aspirations of the motor become more powerful, the effect is to throttle the gas in its way through the indirect passages. The result of this apparently contradictory phenomenon is an automatic regulation which is practically perfect. Once set for a given quality of oil, the supplementary air supply s, s may be left without further attention; the air duct x of the retort remains unchanged; and the position of the regulating valve i in the exhaust pipe as set by the lever and stop j is also unchanged. It has been found in practice that the exhaust supply pipe k should be placed as close as possible to the heads of the cylinders.

AUTO BOAT CARNIVAL IN FLORIDA.

The Palm Beach Power Boat Association will hold its first annual auto boat and water carnival on Lake Worth, Palm Beach, Florida, on February 1, 2 and 3. W. J. Morgan, representing the association, has asked for entries and suggestions regarding the program of races, which has not yet been made up. It is proposed to hold four races each day. Arrangements for the transportation and care of boats will be made by the association, so that those who enter their craft will be relieved of this trouble. The president of the association is H. M. Flagler; vice-president, W. C. Allison; secretary and treasurer, Fred Sterry.

The Chrono-Velocimeter.

There is soon to be placed on the market by a Philadelphia concern a little instrument under the above name adapted to be fitted to both pleasure and commercial automobiles. As the name implies, the instrument measures both time and speed, and in effect is a combination of chronometer, speed recorder, and odometer. It furnishes to the owner of the car, the manager of a garage that rents automobiles, or to the manager of the delivery department of a large store a complete record of the daily performance of any vehicle to which it is attached. It furnishes a permanent record of the hour and minute at which a car leaves the garage or stable, of the miles traveled during the day, of the speed at which each mile was covered, and of the number and duration of all stops made.

The immense utility of such an instrument is apparent, as it provides the best possible check on the employe in charge of the pleasure car or the delivery wagon.

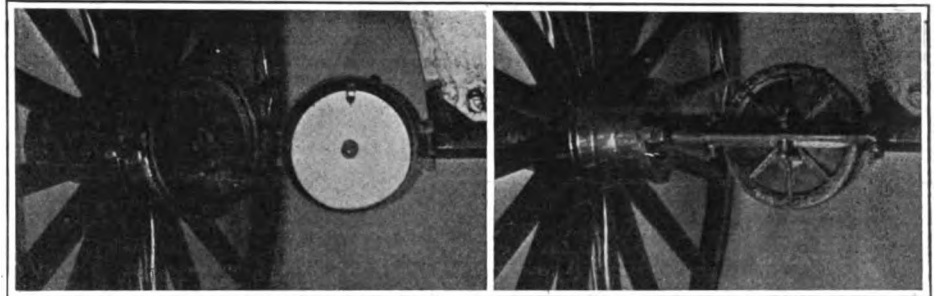

THE CHRONO-VELOCIMETER ATTACHED TO WAGON AXLE—CLOSED AND OPEN.

A general adoption of it should go a long way toward discouraging the too common practice of unscrupulous chauffeurs who go out for night drives in their employers' cars without the owners' knowledge and frequently figure in the police and criminal courts afterward.

The Chrono-Velocimeter consists of a clockwork apparatus enclosed in a dust- and water-proof metal case of circular form. Within the case is a circular sheet of paper having 144 radial markings at the edge. Every twelfth line is printed very heavy and is numbered for the hour of the day, there being twelve such marks. Every third one of the eleven intermediate marks is printed heavier than the others, but lighter than the hour lines, and is numbered for the quarter hour. The lightest marks indicate five-minute intervals during the twelve hours. This sheet of paper is rotated by the clockwork under the point of a needle, which perforates the paper at the end of each quarter mile, half mile or mile traversed, as preferred. The paper disc makes one complete revolution every twelve hours. The needle is actuated by means of a piston fixed on the axle of the car, which has a roller at its outer end bearing against a cam plate or ring attached to the hub of the wheel, as shown in the accompanying illustrations.

The engravings show a form of the

Chrono-Velocimeter that is made for horse-drawn wagons, and which has been in use by several of the large brewing companies in New York for nearly a year. The style to be brought out for automobile use will have the recording portion of the instrument adapted to be attached to the dash, the needle being worked by impulses transmitted by a flexible shaft from the piston on the axle. The case will be of suitable light metal and of a size that will not detract from the appearance of the car.

The case of the instrument is provided with a lock, the key to which is intended to be carried by the owner of the car, the manager of the garage or delivery department, or by the company furnishing the instruments. The device will record every movement of the car for a period of twenty-four hours, as at the end of one complete revolution of the dial the perforator automatically moves toward the center and begins a new circle of perforations.

When the case is opened and the dial removed, the number of punctures made dur-

ing any given interval as indicated by the printed lines indicates the distance traversed in that time. If the car is standing still there will be no perforations, or if it has been run at high speed the perforations will be close together. Thus it not only informs the owner if the car has been used without his authority, but if desired, can be used as evidence in a court to refute the charge of excessive speeding.

In a large renting business or delivery system, it saves much clerical work, obviates the need of "spotters" and provides the management with a complete record of the work done by the wagon and its driver.

A. C. A. DECIDES TO BUILD.

At a meeting of the Board of Governors of the Automobile Club of America, held in New York on December 7, the club house committee formally reported in favor of building a clubhouse and garage, and suggested two locations, one on either side of Central Park. President Morris, who was in the chair, was empowered to appoint a committee of three to choose a site and plans, subject to satisfactory financial arrangements. A subscription form will be issued to club members.

A reward of \$100 was offered for information leading to the arrest and conviction of the persons in an automobile who ran down Jacob Clemons, on November 17.

Suggestions to the Inexperienced.—XI.*

Systems of Side-Chain Drive from Counter-Shaft and Drive by Propeller Shaft to Live Axle Made Plain.

By A. D. RIVER.

A LIVE axle which drives the wheels by its own rotation must necessarily be made much more substantial than a "dead" axle, on whose ends the wheels turn freely under the influence of an external driving force. The "dead" axle is also cheaper, both to make and to repair, since it can frequently be welded if broken, whereas any break in the "live" axle necessitates replacement. Partly for these reasons, and partly because, in a car of very high power, the engine is usually placed in front, the "two-chain drive" is nearly universal with cars of over, say, 30-horsepower, though there are some notable exceptions.

A four-cylinder vertical motor, if of more than 10 or 15 horsepower, is almost neces-

sarily placed in front, with its shaft fore-and-aft; hence the speed-changing gears must be located behind it. A pair of bevel gears then becomes necessary to change the direction of motion, and the standard type of side-chain car results, as seen in Fig. 1. From almost every point of view this arrangement is as nearly ideal as is possible when so many conflicting requirements must be met. The rear axle has little to do, save support the dead weight of the car; the transverse countershaft, as the shaft carrying the sprocket pinions is termed, may be made lighter than a live axle could be, in proportion as it turns faster and against a smaller resistance; and the pull of the chains is applied to the wheel spokes, the sprocket wheels being bolted to these, so that the severe strains in the hubs of the live axle car are avoided.

The chief drawback to the side-chain drive is the necessity of keeping the chains—which, being close to the wheels, are much exposed to the dust picked up by the latter—clean and well lubricated. Owing to lack of room, it is nearly impossible to encase them, and the only thing to do is to give them regular attention. It is said by some drivers that the side-chain car is more liable to skid than the live axle car, but this cannot be considered proven, as other conditions affecting skidding, such as weight and its distribution, may vary considerably with different cars.

The inconvenience of cleaning and adjusting chains, as well as the occasional breakage from which no sprocket chain seems

to require attention on the road, and little beyond occasional filling of the case with oil or grease, and renewal or readjustment of the gears when worn, is called for at any time. It is impossible to change the ratio of gearing, as can readily be done in a chain-driven car.

It will be noted that the casing which surrounds the bevel gears in Figs. 2, 3 and 4, is of itself of such a form as to lend much stiffness to the axle. It is customarily made of cast steel, and generally ribbed at each end, where the fixed sleeves of the axle are brazed into it. The conventional practice is to key the wheels to the shafts, whereas some makers extend the sleeve of the axle into the hub to carry the load and drive from the outside of the hub by a loose connection with the live axle, as in Fig. 4, issue of November 12.

On account of the unavoidable dead weight of the bevel gears and case, and the heavy construction of the axle generally, the shaft drive, like the single-chain drive, is seldom found in cars of over 30 horsepower, except racers, where the time saved from possible breakages is considered more important than the added wear and tear on the tires.

For light cars, where cost is not the first consideration, the shaft drive is exceedingly satisfactory, as there is nothing about

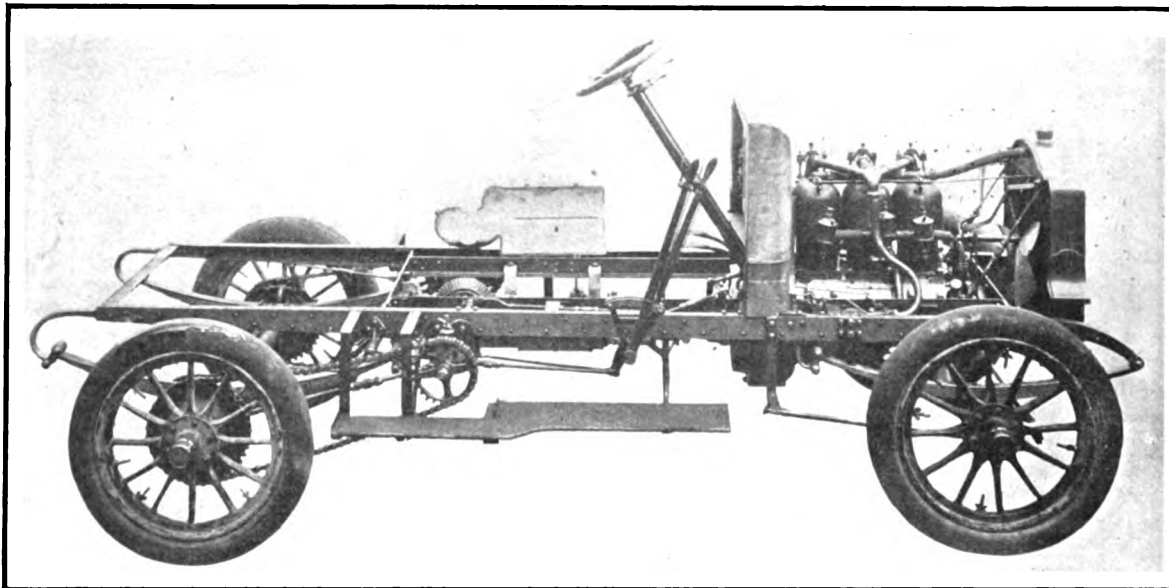

FIG. 1.—STANDARD TYPE OF CAR (THOMAS) WITH SIDE-CHAIN DRIVE FROM COUNTERSHAFT.

sarily placed in front, with its shaft fore-and-aft; hence the speed-changing gears must be located behind it. A pair of bevel gears then becomes necessary to change the direction of motion, and the standard type of side-chain car results, as seen in Fig. 1.

From almost every point of view this arrangement is as nearly ideal as is possible when so many conflicting requirements must be met. The rear axle has little to do, save support the dead weight of the car; the transverse countershaft, as the shaft carrying the sprocket pinions is termed, may be made lighter than a live axle could be, in proportion as it turns faster and against a smaller resistance; and the pull of the chains is applied to the wheel spokes, the sprocket wheels being bolted to these, so that the severe strains in the hubs of the live axle car are avoided.

to be exempt, are avoided by the "propeller shaft" drive, in which the live axle is once more used, but is driven by bevel gears, encased in the axle itself and connected to the final gear drive by shaft with a universal joint near each end. An example of this is shown in Fig. 3, which shows the two-part case forming the centre of the Peerless car axle, with the bevel gears inside and a portion of one universal joint. The bevel pinion shaft runs in two ball bearings, one in front of and the other behind the pinion, and ball bearings are provided also on each side of the differential box, under caps 'G G. These bearings sustain the thrust of the bevel gears also.

In the Pierce Arrow car the rear end of the propeller shaft is squared and fits loosely in the corresponding universal joint in front of the differential, so that it can slide in and out to accommodate the spring play.

It is held by some drivers that the shaft drive can turn corners more easily than the chain drive at anything above the lowest speeds. A probable explanation of this is that the chains of the latter system have a tendency to ride over, the sprockets and cause great friction, due to the effect of centrifugal force on the loose chain, when turning.

For a car of moderate power the problem of cost has been solved very neatly in the Packard *voiture légère* by combining the bevel gear and change gear cases in a single structure, as is shown in Figs. 4 and 5.

For a car of moderate power the problem of cost has been solved very neatly in the Packard *voiture légère* by combining the bevel gear and change gear cases in a single structure, as is shown in Figs. 4 and 5.

*Continued from page 552, Issue of November 12.

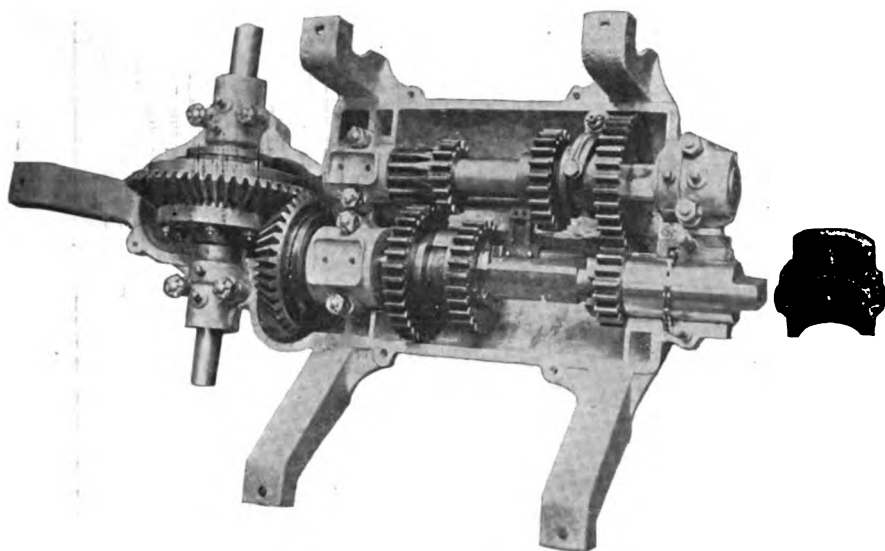

FIG. 2.—CHANGE-SPEED GEARING AND BEVEL DRIVE TO COUNTERSHAFT.

A light but strongly ribbed aluminum case encloses both sets of gears, and the propeller shaft, since it is never geared down to a speed slower than that of the engine, can likewise be very light. To prevent the front end of the gear case from rising, owing to the effort of the bevel pinion to climb up on the bevel gear, a steadying rod is fixed to it, whose front end is pivoted, with a spring cushion above and below, to a cross member of the frame under the footboard. This system is only practicable where, by using moderate powers and the highest grade of workmanship and material, the allowable limits of dead weight on the tires

are not exceeded; but within these limits it is certainly a very happy solution of the problem of putting a high-class car within reach of the man with not too plethoric a purse.

Besides the systems already described, which may be called the standard types of transmission, there are various special types. Thus, the motor of a runabout may be placed in front, with its shaft lying crosswise of the car, and a single chain may drive from a sliding gear or planetary device close to the engine. This is shown in the engraving of the Franklin car, Fig. 6.

Or the motor may be placed in this position, with a chain—usually a Renold "Silent" chain—transmitting from the motor to the speed-changing gears beneath the body; from these one chain or two side chains may complete the transmission.

Several runabouts are built with front motor, shaft drive, and planetary speed-changing gears. The objection to this is that the motors run at fairly high speed, and the planetary gear, which is driven at the motor speed, has a good deal of friction, and therefore at high speed absorbs a good deal of power.

There are two or three friction-driven cars on the market which seem to give fair results, but too little information regarding their performance is available to render it safe to express an opinion as to their future.

The main frame of an automobile may be made of structural steel—channel or angle sections—of wood

stiffened by steel plates or angles, of steel tubing brazed together, or of sheet steel formed into channel or other sections in a powerful press.

Steel tubing, though still employed by some good concerns abroad—notably by Renault—for light cars, has nearly dropped out of use. It is rather expensive, joints made by brazing it are somewhat uncertain, and its rigidity renders it hardly suitable for an automobile frame, in which a certain degree of flexibility is desirable.

Structural steel, especially angle steel, is much used in small and low-priced machines, because it is cheap to get and easy to work. It does not, however, admit of very light construction, though it can be improved in this respect by cutting away the unnecessary metal, as at the ends of a side member.

"Armored wood" is a very excellent material for frames, combining stiffness and toughness in high degree. The usual construction is to rivet a thin steel plate, deepest in the middle and tapering toward both ends, to the inner face of each side member. This gives a good surface for the attachment of cross members, brackets, and the like, and the steel and wood supplement each other's qualities.

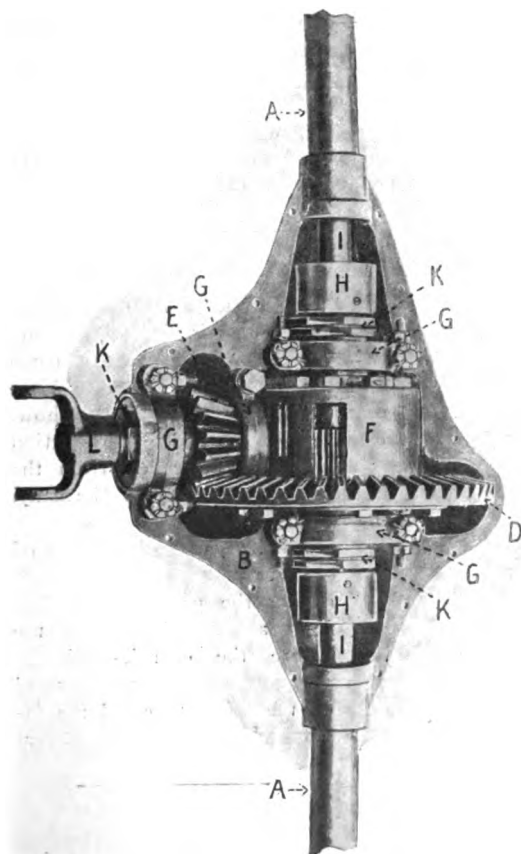

FIG. 3.—ENCASED PEERLESS DIFFERENTIAL AND BEVEL DRIVING GEARS.

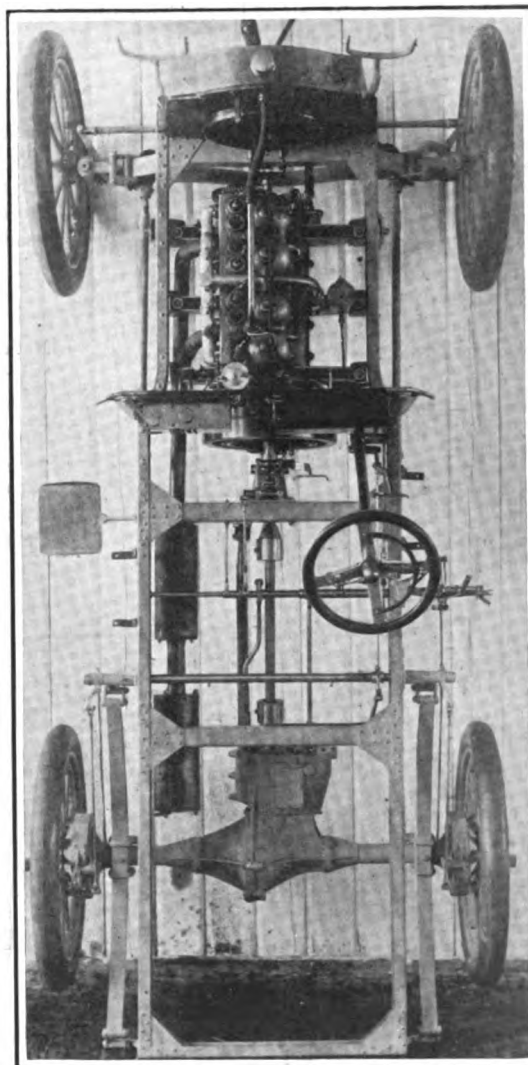

FIG. 4.—TOP VIEW OF PACKARD CHASSIS SHOWING COMBINED TRANSMISSION CASES.

Pressed steel, the latest material for frames, has sprung into great popularity at home and abroad in the past two years. It is expensive, unless large numbers of machines are to be built to a single pattern, since no two patterns of cars are likely to require exactly the same frame, and the dies for pressing the frames are costly. The side and cross members, and the false frame members, if any, are pressed separately and afterwards riveted together. This type of frame can be made very light, since the metal is very effectively placed, and quite thin material—often 1-8 inch—can be used. Consequently it is used in nearly all racers. An example of this class of frame is seen 123456123456 in Fig. 1.

The remark, that a certain degree of flexibility is desirable in an automobile frame, might have been extended. As a matter of fact, even if a rigid frame were desirable, it would be impossible to produce. The road shocks that any machine gets will twist the frame more or less, and the only effect of trying—within any permissible limit of weight—to make it rigid will be to localize these shocks and produce strains and crystallization, which are readily avoided by so constructing the frame that the point subjected to shock will yield somewhat and transmit a portion of the stress to other portions of the frame.

This condition, however, introduces a factor seldom encountered in other classes of machinery. It is impossible, theoretically, and nearly so practically, to "line up" one part, as the motor, with another part, as the gear box, the two parts being supported on different portions of the frame, and run a rigid shaft in bearings through both of these parts. The bearings will not stay in line, and when racked by road travel they will bind on the shaft and absorb power. For this reason it is found necessary, in a case such as that just cited, to use two

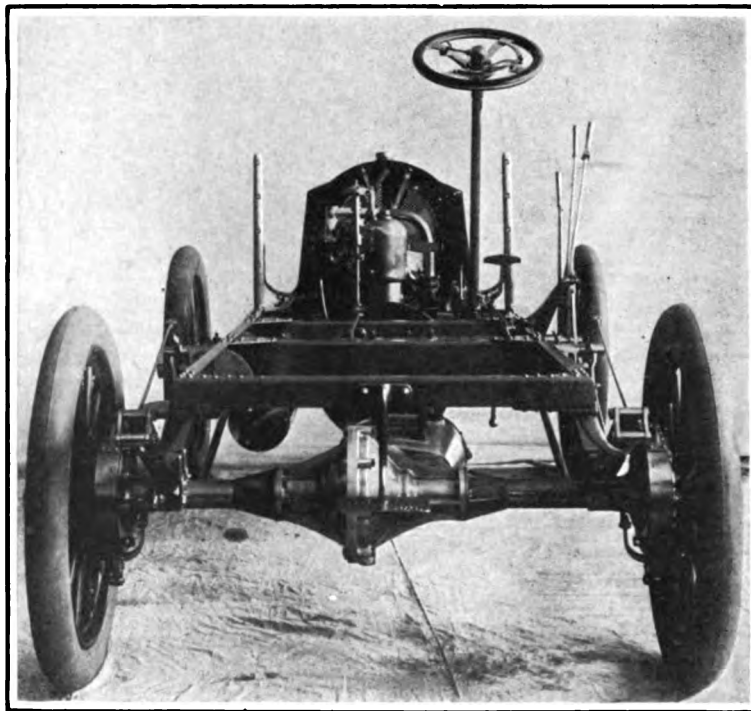

FIG. 5.—REAR VIEW OF PACKARD CHASSIS WITH SHAFT DRIVE.

shafts, and couple them end to end with a little play in the coupling. This principle applies to all connections between a motor and its gear box, save in the special case, where a single casting serves as base for both, and between the central portion of a cross countershaft and the ends carrying the sprocket pinions. With few exceptions, loose couplings of one or another sort are used at all of these points.

(To be continued.)

N. A. A. M. WILL TEST LICENSE LAWS.

The members of the executive committee of the National Association of Automobile Manufacturers placed themselves on record as favoring the institution of a suit for the purpose of testing the legality of the license laws, at a meeting held in New York on December 7, and appointed a committee to

confer with counsel and report at the next meeting.

It was decided to substitute a large smoker and entertainment on Friday of New York show week for the annual banquet, which has been abandoned.

The general manager reported on the allotment of show space. It was decided to subscribe \$500 toward making up the deficit in the Vanderbilt Cup race fund. Investigation of the present status of the Brownlow Good Roads bill and of good roads matters generally will be made by a special committee, which will report at the next meeting. Plans for future shows were discussed and referred to the show committee.

NEW AMERICAN MERCEDES CARS.

The Daimler Manufacturing Company is now busy at its works in Steinway, Long Island, with the first of the new American Mercedes cars, which it expects to have ready in time for the New York Show. These cars will be an exact reproduction of the German 1905 Mercedes, from the plans of the parent company in Germany.

The manufacture of the Daimler delivery truck, and also of the touring car marketed during the present year, has been abandoned, and in the future the energies of the company will be concentrated on the effort to equal the famous product of the Unter-Turkheim factory.

The Automobile Club of Argentine, recently formed at Buenos Ayres, according to latest reports, has enrolled more than 100 members.

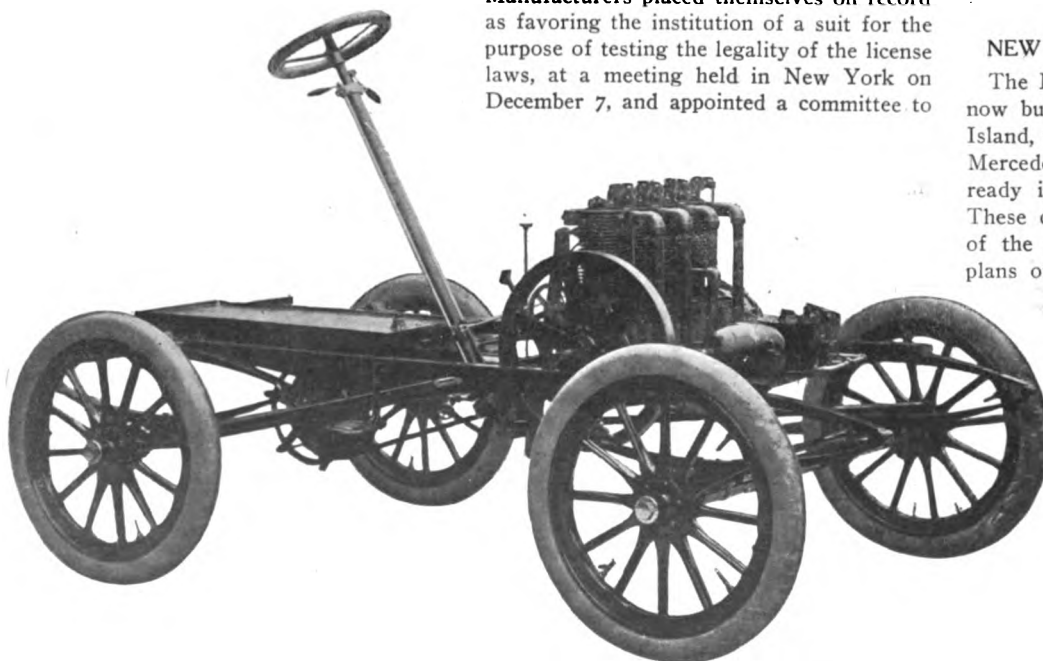

FIG. 6.—FRANKLIN CHASSIS, SHOWING DRIVE BY SINGLE CHAIN FROM ENGINE AT FRONT OF CAR.

THE WINTER CARE OF AUTOMOBILES.

AT this season the automobilist who does not put his car out of commission for the winter should attend to a number of little matters to get the car into proper trim for cold weather running. In the first place, the water should all be drained out of the cooling system as soon as the weather becomes cold enough to start things freezing. It is surprising how the water in the machine will freeze when the temperature hardly seems low enough to congeal anything. Should only a small quantity of water be left in the system its freezing will not burst anything, it is true, but it may cause the pump to stick tight enough to break something when the unsuspecting automobilist puts too much strain on the starting crank in the endeavor to get the motor to turn over. The difficulty of cranking the motor that has been standing all night in the cold is considerable, as the lubricating oil is much thickened by the cold, causing every bearing and frictional point to resist stoutly the first pull on the crank, so that the driver would not notice the slight additional resistance due to the sticking of the pump.

* * *

Assuming that all the water has been drained out, the next step is to replace it with an anti-freezing solution. A majority of automobilists prefer a calcium chloride solution for this purpose. Glycerine solutions and alcohol solutions, as well as special oils, have been used, but all seem open to suggestions which cannot be raised against the calcium chloride. Glycerine rots the rubber tubing, and is itself decomposed by heat. The strength of the chloride solution will depend upon the point to which the temperature is likely to drop, and may vary from two pounds to a gallon of water to four or five pounds. A solution of five pounds to a gallon of water will withstand a temperature of 15 degrees or more below zero. Dissolve the calcium chloride completely before putting the solution into the tank; and it is advisable to strain it also. Be careful, in buying the stuff, that you do not get chloride of lime—a mistake which is not infrequently made.

If the solution when in use evaporates sufficiently to require replenishing, add pure water only, as it is the water that evaporates and not the calcium chloride, so that as the water evaporates the solution becomes more concentrated. The added water simply reduces it to its original strength. The solution should also be entirely replaced with fresh mixture about once a month.

* * *

Another matter to be given careful attention is lubrication. Oils thicken greatly in cold weather, and will not flow readily, if

it flows at all, through the feeds. Therefore a thinner oil should be used in winter than in summer. All dealers in automobile supplies keep winter oil regularly in stock, so no difficulty will be experienced in obtaining it. When making this change in oils would be an excellent time to give the motor a thorough flushing out with kerosene. Do not use gasoline for this purpose, and take particular care that oil feeds are well cleared, so that there will be no obstruction to the flow of the thin oil by the residue of the same lubricant.

* * *

The use of a poor quality of lubricating oil leads to a diversity of evils, apart from inferior lubrication. Carbon deposits will form on the combustion chamber walls, on the piston head and on the sparking points, and insulation of the plug. Ignition will be interfered with and finally stopped through short-circuiting across the insulation of the plug. The deposit may, in time, become so thick as to hold sufficient heat from one explosion to another to cause pre-ignition, which is liable to cause the motor to run with more or less "pound." If pre-ignition is suspected a test can be made by cutting out the ignition current. If this fault is not present the motor will stop; but if pre-ignition is occurring the motor will run without the assistance of legitimate aids to ignition. Shutting off the supply of fuel will bring the machine to a standstill.

In extreme cases the carbon deposit may cause pre-ignition in another way. If the compression of the motor is high, the reduction of clearance space owing to the deposit may raise the compression to such a point that the charge becomes self-ignited. While this is rather an extreme, it may happen in high-compression motors whose pistons and valves are in good condition and will hold the compression well.

* * *

Tires suffer severely if driven carelessly over rough, frozen roads. It is easy to ruin a tire by allowing it to run in frozen ruts and scrape itself down to the bare canvas on the sides of the tread. If there is snow on the roads it is wise to be provided with something to give the tires a grip on slippery surfaces. If you have no regular anti-skidding device, it is a simple matter to keep in the tool box a supply of small chain to wrap round the tires in case of necessity; even a rope will do, although this is subject to rapid wear if used on rough roads. Chains, while giving a good grip, are open to the objection that they are liable to cut the tires and that they scratch the paint of the felly and spokes. There are a number of anti-skidding attachments on the market that do not injure the tires, and will effectually prevent slip-

ping, while they save time and annoyance to the driver if the car is to be used extensively in the winter.

* * *

More flushing of the carbureter is apt to be required in starting in cold than in warm weather, but this should not be carried to excess. If the mixture is over-rich it will be necessary to work off the surplus by turning over the motor until the mixture is reduced to an explosive quality. Another cold weather hint is to drain the gasoline from the carbureter if it has been standing for some time, as it is apt to become "stale" and make starting difficult. Of course gasoline in the tank becomes stale in time, but that in the carbureter does so more rapidly owing to the small quantity contained in the float chamber.

* * *

High-tension current is a difficult matter to insulate, and will leak away through the most unlikely channels. If the ignition acts queerly and the trouble cannot be located in the usual ways, look for a high-tension leak. The elusive fluid will frequently follow oily wood or cloth, if given an opportunity, causing the most mysterious short-circuits and sometimes shocking the driver most unexpectedly. If you get a shock from an apparently impossible point, you may be sure there is a high-tension leak interfering with your ignition.

* * *

In purchasing tires do not accept any in which the rubber is unusually hard or unyielding. Tires will occasionally be found that are hard enough when new to stand up and retain their shape with but little air in them, but on the road they are sure to fall down miserably. Rubber should be pliable and full of life; when not it is almost certain to contain large quantities of foreign substances, or to be improperly vulcanized.

CHICAGO'S BIGGEST SHOW.

The fifth annual Chicago Automobile Show, to be held in the Coliseum during the week of February 4 to 11, promises to be of unusual importance. A number of novel features are promised by the manufacturers, and the interest aroused is expected to draw a large attendance of motorists. General Manager S. A. Miles states that all space has been taken, and the allotments are being cut down in order to accommodate more exhibitors.

The Chicago Automobile Club is taking an active interest in the show, and will aid materially in making the social feature a prominent one. A number of banquets will be given at the club house during the show, among them being that of the American Motor League and another by the two Chicago automobile weeklies, in honor of the visiting newspapermen from the East.

Correspondence

Tour Through Central New York.

Editor THE AUTOMOBILE:—

[120].—In the spring of 1901 John Maxwell, of Oneida, N. Y., purchased a Haynes-Apperson surrey, securing State License 47, which still hangs on the rear axle. In 1903 he rebuilt it and put on some modern improvements, and the car made the trip of which a description follows, climbing all grades that were met and at times making a very rapid pace. Besides Mr. Maxwell, his friend, Mr. Frank B. Petrie, and the writer made the load.

On Friday, August 26, we left Oneida about 10 A. M. The country was in its richest dressing of summer verdure, frequent rains having fallen. At Munnsville we made an error, took the wrong road, and gradually rose to the top of the eastern side of the valley, yet we had nothing to regret; the view was beautiful and there was every indication of prosperity among the farmers. This is one of the greatest hop-growing regions in the United States, and the hop pickers were numerous. We gradually dropped down in to the Chenango Valley and reached Hamilton before noon.

After dinner at the Maxwell House, and securing some gasoline of a better quality, with an adjustment of the carbureter, we resumed our journey southward.

Soon we saw one of the evidences of advancement in transportation facilities, the Chenango Canal, abandoned some sixteen years ago, its bed being utilized by two railroad lines. As we moved out of Hamilton we were delighted with a brief view of the Colgate University. From Hamilton to North Norwich the road was made mostly of gravel, nicely graded and rounded up, and it was excellent. It follows the east side of the valley, and between Stockbridge and Hamilton is the summit; the grade from Hamilton to Binghamton is gently southward, excepting as it winds in and about the sides of the valley, and within a small space the waters flow northward to Lake Ontario and on the other slope southward to Chesapeake Bay. The towns and villages of this valley are clean, neat and tidy, with every indication of prosperity.

After ascending the hill at Chenango Forks, a hard climb, we found a very poor road for some distance; but from Chenango Bridge into Binghamton, with one mile of State road, it was unusually good. Much of it was on the old tow path of the abandoned canal.

The route from Oneida to Binghamton presents a pleasant variation of scenery, and one swings from one side of the valley to the other and along the sides with romantic curves and very little hill climbing; it is really an ideal run. We arrived at the Bennett House in Binghamton about 7 P. M., after about a hundred mile run. The

Binghamton Automobile Garage is about as near perfection as can be, and we were most hospitably received; many large and expensive cars are owned there.

Saturday morning, shortly before 10 o'clock, we left Binghamton headed westward. The road to Owego is good, four or five miles of the State road just outside of Binghamton being fine. We took the road on the south side of the river, crossing to the north at Owego for dinner, after which we resumed our journey on the south side until we arrived at the Smithboro bridge, then continuing to Waverly. The little brook which we passed at Hamilton had joined long ere this with the broad waters of the Susquehanna River, and the hills on each side of the valley were high and precipitous; on the low lands farmers were cutting tobacco and preparing it to dry.

We reached Elmira by a road which was good, bad and indifferent, and stopped at the Elmira Arms Company garage, where a few supplies were secured. Then we sped along the Chemung Valley, which had been entered near Waverly. About the finest scenery on the trip was on the slope in the valley leading to Seneca Lake, though the road was one of the poorest. Here again was a summit with the waters flowing north and south to the same points mentioned above. We arrived in Watkins just at dusk. Two experiences to-day both amused and annoyed us; we met six horses and buggies, in each of which were two ladies and one or two infants, and all within six miles; at another point we met a Sabbath-school picnic in fifteen or twenty different kinds of horse-drawn rigs, containing ladies and children. We stopped, shut down motors, and received the thanks of the superintendent and several of the ladies.

After dinner Sunday afternoon we started north from Watkins on the west side of Seneca Lake, finding fine views of the lake, glens and hills, but miserable roads, until nearing Geneva; the last seven miles were smooth and good, and we were registered at the Nestor House about 4.30; Geneva has a number of well paved streets, and is a busy little city.

On Monday morning, August 29, at 10.30, we passed around the foot of Seneca Lake, along its eastern shore to Willard State Hospital over a very inferior road; but after entering the grounds we found a smooth road, as we did from there to Oneida. We dined at the Franklin House at Ovid, then passed along to Farmer, thence down an easy grade to Kidder's Ferry, west shore of Cayuga Lake. The Busy Bee ferry boat seemed to us to be getting "dronish," but it carried us safely over two and a half miles of clear water to Kings Ferry, Cayuga County, where we had a hill climb of about a mile; but twenty-one miles of level road northward to Auburn were smooth enough, so that at times we had to be careful not to exceed speed limits. Tourists going westward

will do wisely to take this route, passing through the center of Seneca County to Geneva.

The beautiful city of Auburn was left behind on Tuesday morning, and we toured over fairly good roads, and after lunch in Syracuse, moved on to the place of starting—Oneida. While on the road we were held up by a threshing machine party, who had their driving belt across the highway, refusing at first to take it down, and advising us to take the field around them; only after threatening to cut the belt would they make a passage way for us.

We arrived at Mr. Maxwell's garage about 4.30 P. M., after a most enjoyable trip, having met with no mishaps nor accidents of any kind.

Our observations made us unanimous in one opinion, that the great river valleys provide far better and more level roads than the lake region, which abounds in hills, glens and gullies, making it necessary to climb many steep hills; although the scenery repays one for the wear and tear on motors and tires. The odometer marked 386 miles, and the speed ranged between 10 and 20 miles per hour. The eleven counties traversed were Madison, Chenango, Broome, Tioga, Chemung, Schuyler, Yates, Ontario, Seneca, Cayuga and Onondaga.

S. C. TALLMAN.

Auburn, N. Y.

A Progressive Farmer.

Editor THE AUTOMOBILE:—

[121].—Others of your readers will no doubt be interested, as I was, in reading the enclosed letter of one farmer of Charlotte, Vt., in reply to a letter from another farmer—Mr. Higbee—of the same place, who complained bitterly of the frightening of horses by the use of automobiles on the roads hereabouts, and suggested that they should be excluded altogether or their use hedged about by the utmost restrictive legislation. Both letters were printed in the *Burlington Free Press*. Mr. Johnson's answer to Mr. Higbee shows breadth of mind not usually displayed by inhabitants of the rural districts, who have so long enjoyed the all but exclusive use of the roads as apparently to have grown into the belief that travel upon them by any other means than by horse and wagon or carriage is an infringement of their especial rights.

M. H. S.

Burlington, Vt.

THE FARMER'S LETTER.

I am deeply interested in all things which concern the farmers of this county, as I have the honor of now being called farmer, myself; and I therefore beg to say a few words in behalf of the automobile which I believe is destined to be of great value to the farmer.

At present, automobiles are chiefly pleasure vehicles, and are in the experimental stage, which keeps the price of an automobile beyond most of the farmers; however, owing to the large number sold, automobiles are being built cheaper and more prac-

tical every day. so that it is only a question of time when a good automobile will be as cheap or cheaper than a span of horses, besides costing less to maintain and taking less time for care. * * *

The large majority of automobile owners are careful in running their machines, but of course there are always a few who, owing to their selfish or careless manner of operating, have brought down upon the heads of the autoists a multitude of curses. If this class of people were punished by imprisonment instead of fines, we would soon hear little complaint, for the man that is able to own a first-class automobile nowadays, is able to pay fines every day in the year; whereas the disgrace and sobering influence of a few days in the county jail would tend to give these careless operators a new view of things.

One of the greatest needs of rural communities to-day is good roads, and nowhere is this better illustrated than in the town of Charlotte. Autoists are doing everything in their power to secure better roads, especially in the rural parts of New England. Doesn't this benefit the farmer? What if some of his horses are afraid the first time they see an automobile? It will do both the horses and the farmer good to get acquainted with automobiles. It will take patience and perhaps a little hard work to get acquainted, but it is certainly worth the trouble.

One of the most interesting farming exhibits at St. Louis is an automobile mowing machine. There are also many automobile trucks, and even plows are exhibited which will lighten the labor of the farmers of this coming generation. Of course the farmers will require more education to run an automobile mowing machine than they would to swing a scythe, but the benefits will be put before their eyes in the shape of bright, round American dollars which the farmers are now getting after faster than ever before.

But the greatest benefit of the automobile is the saving of time of which the farmers are now beginning to realize the value.

CHAS. E. JOHNSON.

Charlotte, Vt.

Home-Made Crane Patented.

Editor THE AUTOMOBILE:—

[122].—We respectfully call your attention to the fact that we are the owners of certain Letters Patent of the United States, the claims of which cover such construction as is shown and described in the article, "Home Made Auto Crane," in your issue of November 19, and that we must protect our rights under said patent.

We assume that the manufacturers of the crane referred to in said article were not aware of the existence of our patent, and need only to be informed thereof to cease the manufacture of the crane.

We believe that you will willingly publish this communication for the protection of your readers.

FRANKLIN PORTABLE CRANE & HOIST CO.
Franklin, Pa.

Our understanding of the situation in connection with the home made crane illustrated and described is that the manufacturer made one merely for his own use, and, so far as we know, has not attempted to market the device. The builder probably did not know of the existence of the patent mentioned in the letter above.

Boiler for Runabout.

Editor THE AUTOMOBILE:—

[123].—In the reply to "A.A." in your issue of October 29, page 503, there are, I believe, some errors that should be corrected since the inexperienced individual has plenty to contend with even with the best advice. In the first place, he is left to believe that a boiler 20 inches high will be all right in a steam carriage, since it is not commented upon. Very few light car bodies would allow such a high boiler between seat and engine chain. Again, a boiler 14 inches diameter and 13 inches high will furnish with a good burner all the steam a runabout can use on the road.

Regarding thickness of tubes, I have yet to learn of one maker advertising heavier

moving the shell from the heads and tubes. The studs in the top are shown pitched too close; they should be about one inch centers; top ends of tube were swaged to 9-16 inch to allow for decreased spacing made necessary by the top joint. Three hundred 1-2 inch tubes could be easily spaced in the top head about 11-16 inch centers without swaging; bottom tube head, 3-4 inch centers. I have a home-made burner of 1-8 inch gas pipe and cannot use all my steam on the road. Have standard 2 1-2 inch by 3 1-2 inch Mason engine.

W. G. LUPER.

Vallejo, Cal.

To Stimulate Club Interest.

Editor THE AUTOMOBILE:—

[124].—Club officers and committeemen throughout the country are frequently confronted with the seemingly impossible task of keeping interest of the members actively alive through the winter months, when the cars are used less and business and social affairs are at their height. While club elections, weekly meetings with their lectures, and bowling and billiards attract a number of members more or less regularly, it is a common objection that these things draw out only a fractional part of the membership.

Friendly competition, in whatever direction, is one of the best stimulants to human interest. The house committee would probably find that one of the most effective ways of awakening the driving spirit and club interest among the members would be to start a mileage competition open to all. A bulletin board could be put up on a wall of the club room and a record kept of the total mileage of the members leading in the competition. A feature of each week's meeting would be the reports of the members of the mileage recorded by their odometers up to that evening. The placing of the names and distances on the bulletin board would give occasion for much good-natured bantering and raillery, and the ambition to head the list or surpass some friend would not only bring the members to the clubhouse to see how others progressed, but would also be an inducement for the more frequent use of their cars.

Other competitions could be arranged with the purpose of determining the lowest percentage of maintenance and repair cost to first price of the car, and to evolve the most economical user of fuel per mile traveled.

To make the weekly meetings of practical value to the members, small prizes or blue ribbons could be offered for the most practical written hint on emergency repair on the road, on manipulation of the car in cases of skidding, on anti-freezing solutions, and a variety of similar subjects.

Chicago.

W. N.

Arrangements are now being made for the establishment of a large automobile race track at Berlin.

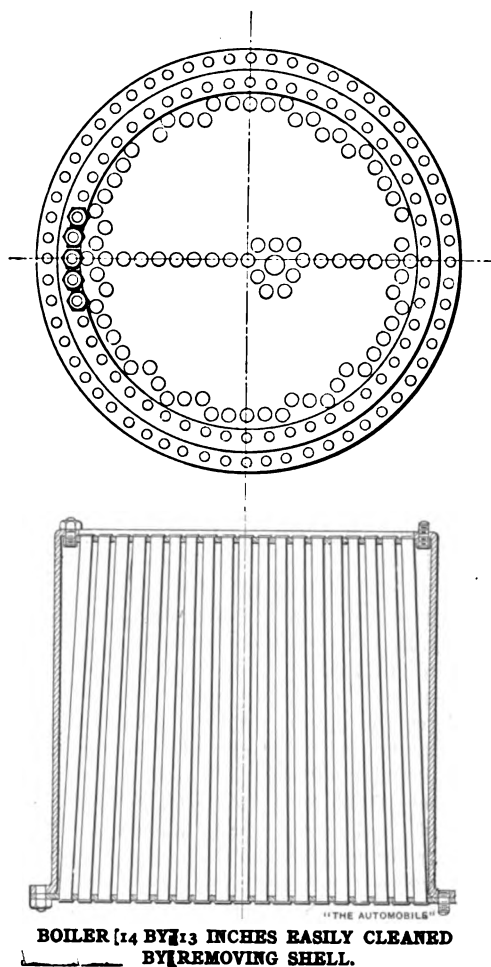

than 20 gauge half-inch tubes, which are .035 inch thick, whereas you advise the use of 14 gauge or .083 inch thickness. We are assured by the makers that 20 gauge tubes will stand from 1,000 to 1,350 pounds boiler pressure, and I have tested them to 800 pounds. That is much higher pressure than is needed in a steam runabout, and 20 gauge tubes, which are more than double the thickness of 14 gauge tubes, cause corresponding inefficiency from radiation and decreased area through tubes.

I enclose blue print to scale of a 14 by 13-inch boiler, that I made for my car, with 238 5-8 inch 18 gauge tubes, which has the advantage of being easily cleaned by re-



VOL. XI.

No. 24

Published every Saturday by

THE CLASS JOURNAL CO.,

Flatiron Building, Madison Square,
NEW YORK CITY.Cable Address - - - Autoland, New York
Long Distance Telephone - 300 Gramercy, New York

SUBSCRIPTION RATES:

United States, Canada and Mexico, - One Year, \$2.00
Other Countries in Postal Union, - One Year, \$3.00To Subscribers—Do not send money by ordinary mail.
Remit by Draft, Post-Office or Express Money Order,
or Register your letter.

FOREIGN SUBSCRIPTION AGENTS:

ENGLAND:—Iliffe & Sons, Limited, 3 St. Bride Street,
Ludgate Circus, London, E. C.FRANCE:—Boyet & Chevillet, 22 Rue de la Banque,
Paris.

GERMANY:—A. Seydel, Mohrenstrasse 9, Berlin.

To Advertisers—Copy or changes in orders for ad-
vertisements should reach us not later than 5 o'clock p. m.
Monday for the issue of Saturday following.Copyright, 1904, by The Class Journal Company.
Entered at New York, N. Y., as second-class matter.The Automobile is a consolidation of The Automobile
(monthly) and the Motor Review (weekly).

Copies Printed This Issue, - - 12,000

" " Since Jan. 1, - 603,000

Indexes to Volumes IX. and X. of THE AUTOMOBILE (July to December, 1903, and January to June, 1904), will be mailed, upon application, to all who desire to bind these volumes or to preserve the indexes for reference purposes. Address requests to the Editorial Department.



Fire Prevention The fire which destroyed in the ~~garage~~ one garage, and for a time threatened the principal garage district of New York and the large theaters and hotels adjoining, last Monday, is evidence that such institutions are not always guarded with that excess of vigilance which alone is a guarantee of safety. While those in charge of the garage offer no explanation of the immediate cause of the disaster, the main points show on the surface. A gasoline tank wagon was discharging gasoline into the garage tank, and in some manner the gasoline became ignited, the driver of the wagon started up immediately, without waiting to shut off the cock, and the trailing hose scattered the oil in all directions.

Anyone at all familiar with the average conditions existing in too many establishments of this kind will have no trouble in assigning several probable causes for such an occurrence. The omnipresent cigar and the still more numerous and dangerous cigarette have found in the modern garage even a wider field of destructiveness than they have enjoyed in the past in theaters

and other public buildings of only average inflammability; and in addition to them there is the electric current everywhere, on walls and cars.

Another element of danger in the garage as compared with most other buildings usually rated as extra hazardous, is the regular use of gasoline for cleansing purposes.

Only a short time since, within the limits of this same block, there occurred a fire that is almost typical of conditions that are entirely too common. While one mechanic was cleaning a motor with gasoline from an open pan, another was overhauling the sparking apparatus, the two thus deliberately producing in the center of a crowded garage the identical conditions of vaporization, mixture with air, and spark ignition that are supposed to be confined most rigidly to the interior of the motor. That the resulting fire was subdued before it had done any more damage than to burn the paint from the one car and to injure the wheels was merely a matter of good luck.

The automobile storage establishment is an absolute necessity in every large city; it cannot be banished to the suburbs, for it must be convenient to business or residential centers; and it cannot exist without a liberal supply of gasoline. From the narrowest viewpoint of self interest, the proprietors of such institutions owe it to themselves, if not to the public, to observe every possible precaution against fire; apart from immediate loss of life and financial damage, every disaster such as that in question must have its effect in raising insurance rates and drawing closer all municipal restrictions.

The first element of safety is a definite system of authority and discipline by which the rules of the garage are stringently enforced at all times. There should always be present some one person whose duty it is to enforce the rules; if this task be divided among several persons or left to chance, all discipline will relax.

There should be a rigid regulation of the use of gasoline, whether in filling the tanks of cars or in using it for general purposes about the storeroom and shop; in particular, special precautions as to general cleanliness and the total absence of lights should be taken whenever the main reservoir is replenished from the supply wagon.

Second only in importance is the matter of general cleanliness—the prevention of accumulations of dirt and waste in corners and closets, the immediate removal of gasoline and oil from the floors, and the maintenance of order and neatness throughout the establishment. With floors, lockers and closets in proper order, and with all oil and gasoline confined to their reservoirs, the possible danger from an accidental spark of any kind is reduced to a reasonably safe minimum.

There is no guarantee of safety in the mere posting of placards prohibiting smoking, even though phrased in several languages; the only safety lies in the rigid

enforcement of the rule by one central authority. The abolition of smoking will doubtless work a hardship to many, but it has been found necessary in the case of theaters and similar institutions, and sooner or later it will probably be made a legal requirement in the case of garages in the central portions of cities.



Special Cars for Commercial Use.

A subscriber connected with one of the telephone companies in the Middle States writes us to suggest a yet undeveloped field for the practical use of automobiles which seems to have somewhat more immediate promise of success than is sometimes the case. His company has for several years been experimenting with motor vehicles in the repair and maintenance of its long distance wires with seemingly a fair measure of success considering the fact that the vehicles used have been light runabouts not meant for commercial use, and he declares that telephone companies throughout the country would gladly adopt a machine of simple but high-class construction, equipped with a perfectly plain working body and devoid of all decorative frills and expensive finish. Such a car, seating one or two persons and provided with compartments for carrying a couple of telephones, wire and light repair tools, would be used in country work where regular transportation lines were inconvenient, and would be operated, we may suppose, by the "troubleman" himself, whose mechanical education could easily be stretched to cover this new requirement. Our correspondent names \$1,000 to \$1,500 as the price of such vehicles as it would now be necessary to purchase to answer the requirements, and seems to imply that if the money spent on carriage work and the expensive refinements of the pleasure vehicles were saved the purchase price could be made a great deal less.

That there are here two distinct propositions is evident. The motor vehicle may be well adapted to the line of work noted, and even distinctly economical, without being particularly "cheap" in first cost. As a matter of fact, we question if in the present state of the art, or even three or four years from now, a satisfactory car for such a service can be bought for less than \$800 or \$1,000. The lack of eagerness so far shown by automobile builders to enter the commercial field is after all based on the most hard-headed business sense. They are simply waiting till their experience with pleasure vehicles has shown them how to build genuinely successful commercial vehicles.

The man out for a spin does not reckon in dollars and cents time spent in trouble, but when a delivery wagon is laid up for an hour or two by the road it makes a deep cut in the working efficiency for that day. The goods are delayed, the vehicle is out of commission when it should be earning money, and the driver's time is likewise lost. To save such losses so far as possible, it is necessary to employ skilled driv-

ers, and until the supply of these comes within gunshot of the demand fancy wages and irresponsible men will be the rule. In the large cities, indeed, it has been found difficult to maintain delivery service with anything but electric vehicles, because as soon as a boy or man is broken in to run a gasoline machine he gets a job as chauffeur or repairman at double or treble his former wages, and the heart-breaking process of breaking in must be repeated.

Again, it is easy to dwell too much on the supposed high ratio of decorative work to useful work on an automobile. No ordinary body costs one-fourth as much as the chassis on which it rests, and many of them probably cost less than one-eighth. Some of the finish might be left off from the mechanism, but the much-talked-of "simplicity" of the future commercial vehicle is largely imaginary. If manufacturers knew how profitably to simplify their present machines they would do so.

If now we glance again at the telephone field, we will see that its especial recommendation, from the present point of view, is that little departure would be needed from present type of vehicles, because time-saving would be an object, and a car able to make less than 20 miles an hour would not be worth considering. Why would not it be a good idea to furnish for this work a standard car with special working body, and either fit a smaller motor or simply reduce the power of present motor types by suitable changes in design? Such a car would have the best possible chance of a long and useful life.



There is at the present time a marked effort on the part of the more prominent individuals and the governing bodies of the automobile world to secure a general compliance with the law, and to go even further in restraining all users of the automobile within the broad limits of fair play and manly courtesy.

Under such conditions it would seem that some spirit of recognition and reciprocity might be looked for in those who make and administer the law, but the tendency in too many cases is not to detect and punish the guilty, but to annoy and oppress all motorists.

An instance to the point is found in the bill now before the Vermont Legislature, with a fair prospect of passage, as told in our news columns this week. Some of the provisions of this bill are not only objectionable in themselves, but more archaic and out of date than those enacted in the first years of the automobile, marking a distinct retrogression in road legislation.

No proper understanding will be reached among road users until each class recognizes the rights of all others, and no good, either temporary or permanent, can come from such legislation as this, recognizing the rights of those who use but one means of travel.

FIRE IN NEW YORK GARAGE CENTER.

Eleven Men Injured by Jumping from Windows of Burning Standard Garage and Forty Expensive Cars Badly Damaged—Tank Wagon Spread the Flames.

Fire destroyed the garage of the Standard Automobile Company at 146 West Thirty-ninth street, New York, on Monday, December 4. Automobiles stored there were damaged to an amount estimated at \$150,000, some being practically destroyed and others escaping with the loss of the bodies. So rapidly did the flames spread that twenty men who were working on the second floor were cut off from the stairway and were forced to jump from the windows to the pavement below. In doing so eleven were injured, one man breaking both legs, three breaking their ankles, and the others suffering sprains, bruises and burns of more or less severity. They were taken to the Bellevue and New York hospitals, where all are doing well.

There is nothing to show just how or where the fire started. The facts, so far as known, are as follows: A gasoline tank wagon had drawn up in a narrow lane at the rear of the garage and was running gasoline into the large outside underground tank in which the fuel supply was stored, when an employee in a second floor window noticed a slight blaze near the tank opening. He shouted to the driver of the wagon, who, without trying to extinguish the blaze, or even to turn off the stream of fluid, whipped up his horses, dragging the hose from the opening and throwing a flood of gasoline into the fire. Instantly there was a roar of flame, and the entire end of the building was ablaze, the tank wagon, however, just getting clear in time. Escape by the stairway being cut off, the men on the second floor jumped from the front windows, some in their haste almost diving into the street. Others, less excited, hung by their hands from the coping and dropped carefully, escaping with little or no injury. The building was a wood and brick structure, and burned like tinder. By the time the fire apparatus arrived on the scene it was impossible to save the garage, and the efforts of the firemen were directed mainly toward preventing the spreading of the flames to adjoining garages.

The Cadillac garage, which was next door, was quickly cleared of cars, which were lined up in the street; but practically no damage was done to the building, and the machines were returned to it after the fire was extinguished.

There were thirty-five cars on the lower floor of the Standard garage which burned, and six on the floor above undergoing repairs or in storage. Only one car was saved, that being the property of Mayor McClellan, which was pushed out. Owing probably to the fact that one hub tore a splinter off the doorway as it went through, it was reported in one of the daily papers that the chauffeur did the marvelous stunt of driving his car at full speed through the closed doors, without any damage resulting beyond a slightly bent fender.

Many of the machines were insured, although there were nearly a dozen on which no insurance was carried. After viewing the ruins of the machines in the Standard garage several owners of cars stored in other garages hastened to take out policies. Eight or ten of the machines can, it is said, be repaired. The remainder are thought to be total losses, although possibly a more

careful inspection will show that the damage to some of the cars thought to be destroyed is not irreparable.

Peter Cooper Hewitt's racing car, said to have cost \$30,000 to build, is among the badly damaged cars, as was also a 70-horsepower Panhard belonging to C. C. Herman.

Sensational stories about gasoline explosions were freely circulated during and after the fire; but inquiry elicited the information that the only explosions that occurred were due to bursting tires. Some indignation was expressed regarding the action of the firemen, who slashed their axes into tires to prevent their exploding from the heat. The gasoline tank, it is stated, did not explode, and was found after the fire to contain the gasoline that had been run in. No gasoline was stored inside of the building. There were in the garage several barrels of lubricating oil, which were unaffected by the flames.

Earlier in the day a slight fire had occurred in the building, but it was quickly put out with the aid of fire extinguishers. Some of the men had hardly recovered their composure when the second fire started.

The Standard garage is in the heart of the automobile business district, and the progress of the conflagration was watched with anxiety by automobile men in the neighborhood. E. T. Birdsall and E. S. Partridge, president and vice-president of the Standard Company, are in Paris, having gone over to see the automobile show. The news of the fire was cabled to them at once by Acting Manager Weaver.

A. A. A. OFFICERS NOMINATED.

President Whipple Consents to Serve Another Year—New Clubs Admitted.

All of the officers of the American Automobile Association were unanimously renominated at the meeting of the Board of Directors, held at the rooms of the Automobile Club of America, in New York, on Tuesday, December 6. There was doubt at first as to whether President Whipple would accept the nomination, being a man of many affairs, and moreover residing near Boston, but he yielded to persuasion. The election will take place at the annual meeting in New York on January 14, the opening day of the Madison Square Automobile Show.

On the board of directors the names of Dave Hennen Morris, W. C. Temple, H. L. Lippitt and C. G. Burgoyne replace those of Dr. Julian A. Chase, Samuel H. Valentine, Barclay H. Warburton and Dr. W. E. Milbank.

A proposition was made to amend the constitution so as to allow every affiliated club having a membership of fifty or more to be represented, instead of electing seven directors, four to constitute a quorum, as at present. It was also proposed to make the second and third vice-presidents, as well as the president and first vice-president, ex-officio members of the board.

Forty-two clubs are now members of the association, five having been elected at the nomination meeting, as follows: Binghamton, Geneva and Chenango county, N. Y., and Dallas and Houston, Texas. This shows an increase of twenty-six clubs over last year's list.

Holland has abolished all restrictions regarding speed of automobiles in the country, except driving to the danger of the public, thus placing the entire responsibility upon the driver, as is the case with horse-drawn vehicles.

PROPOSED VERMONT LAW OBJECTIONABLE.

Requires Motorists to Stop Cars Within Respectful Distance of Every Horse, Grants Local Option in Speed Regulation and Provides for Cumulative Records of Convictions.

A bill introduced by Mr. Campbell, of Rockingham, and known by his name, is now before the Legislature of Vermont, having been reported favorably with amendments and being favored by a majority of the House of Representatives. It is designed to supersede the existing law, which is brief, and, in addition to requiring licensing and numbering, it introduces some new and particularly objectionable ideas in automobile legislation.

The bill calls for the registration of all automobiles and the licensing of operators, the fee being \$2; for the extension of privileges to non-residents and their cars, and for speed limits of fifteen and ten miles; the penalties being revocation of license or certificate, and fines of from \$25 to \$100, with not more than ten days' imprisonment.

For the usual provision requiring the stopping of a car upon notice from a driver of a horse is substituted the following:

"Upon all highways outside of city or village or thickly settled portion of a town or fire district, the operator of such automobile or motor vehicle shall stop such automobile or motor vehicle not less than seventy-five feet from any approaching vehicle drawn by a horse or horses, or a horse upon which any person is riding, and shall not proceed further until such driver or rider of such horse or horses shall have passed said automobile or motor vehicle or have reached a place of safety, unless such rider or driver of such horse or horses shall signal the person having in charge such automobile or motor vehicle to advance."

The detail of administering the added penalty prescribed for a second offense seems to be very fully provided.

"The Court convicting any person of violating any of the provisions of this Act shall at once notify the Secretary of State of such conviction, with the number or mark of the machine, owned or driven by him, and all other information obtained. This shall be recorded by the Secretary of State, and if at any time it shall appear that any person, owner or driver of an automobile, or motor vehicle, used in different cities, villages or towns of the State, has been convicted of a first offense in more than one court in the State, the fact of this conviction shall be deemed a second or subsequent offense, and the person, owner or driver shall be subject to further prosecution by the Secretary of State."

With the interests of the horse-drivers thus amply safeguarded, it would seem that nothing more were necessary, but the final section of the bill opens a wide door for all sorts of supplementary local legislation, inviting further onerous restrictions, as follows:

"Nothing herein contained shall be so construed as to affect the rights of boards of aldermen of cities, selectmen of towns or trustees or bailiffs of incorporated villages to make special regulations as to the speed of automobiles and motor vehicles, and as to the use of such vehicles upon particular roads or ways, including the right to exclude them altogether therefrom. Such exclusion, however, shall be subject to an appeal to the Secretary of State, whose decision in the case shall be final.

No such special legislation shall be effective unless notice of the same is posted conspicuously at the points where any road affected thereby joins other roads."

It would appear from the above that the standard speed limits of the bill—fifteen in the country and ten miles in towns—are not of necessity universal throughout the State, but may be nullified by the adoption of still lower limits by local authorities.

AMENDMENTS CRITICISED.

Blow Aimed at New York and Philadelphia Motorists by Jersey Assemblyman.

Special Correspondence.

PHILADELPHIA, Dec. 5.—Automobilists here are commenting rather unfavorably upon some of the proposed amendments to the automobile laws to be introduced by Assemblyman Harry Scovil at the next session of the New Jersey Legislature. To "compel" an automobilist to carry but one tag on his automobile is, they assert, unconstitutional; to carry the tag of the state in which he is at the time traveling over is the most that any state officials may insist upon. What other numbers or tags the automobilist may carry, these critics say, is beyond the officials' jurisdiction, so long as he does not carry "fake" numbers with an evident intention to confuse the authorities.

In south Jersey especially towns are comparatively few and far between, and the roads oftentimes run through mile after mile of sand barrens, with not a single human habitation in sight. To reduce the present twenty-mile-an-hour maximum speed rate through such sections, as proposed by Mr. Scovil, would be nonsensical, it is held. It seems evident from the tenor of the proposed amendments that they are aimed almost exclusively at New York and Philadelphia automobilists, and that some such anti-automobile plan of campaign as is at present in force in the townships to the west of this city is contemplated. If such be the case, automobile travel from the Quaker City to the various shore resorts next summer will be anything but an unalloyed joy.

FIRST 60-H.P. THOMAS TRIED.

Special Correspondence.

BUFFALO, Dec. 5.—The first Model 27 60-horsepower Thomas Flyer was given a road trial last Saturday. Designer Schultz held the wheel as the big six-cylinder car was driven over the snow and ice-covered roads in the vicinity of the factory.

This car is the property of Major C. J. S. Miller, a Franklin, Pa., yachtsman, soldier, horseman and automobilist, and makes the seventh auto for his stable. Major Miller has entered the new car for the Florida tournament, and will drive the machine himself on the Ormond-Daytona beach as well as on road and track next summer.

Duplicates of this car have been ordered by Walter M. Jermyn, a Scranton coal magnate; Charles S. Henshaw, who is now making arrangements to race it against a locomotive on one of the railroads entering Boston; Harry S. Haupt, whose four-cylinder Thomas won the recent free-for-all at Waverley, N. J., and later won Class 6 event in the Eagle Rock Hill Climb, and by several persons who want the machines for touring exclusively.

Everything is moving along smoothly in the Bates automobile murder mystery. Chicago reports the regular failure of a clew yesterday.—*Indianapolis News.*

INTERNATIONAL RACES FOR BAVARIAN CAPITAL.

Contests in Speed, Reliability and Hill-Climbing for Touring and Racing Cars Arranged for the Professor Von Herkomer and Baron Bleichroder Trophies.

There has just been issued the preliminary program of a varied and extended series of international competitions which will be held in August next at Munich for prizes offered by two German motorists, Prof. von Herkomer and Baron James Bleichröder. The competition, which is open to all members of clubs affiliated with the German Automobile Club, and in Germany with the Deutsche Automobil Verband, is under the management of the Bavarian Automobile Club in cooperation with the German Automobile Club.

The Herkomer prize competition is open to four-seated touring cars, the first event being a public exhibition of one day in Munich, with a competition for utility and beauty of bodies. On the second day there will be a hill-climbing contest over a 7-kilometer course on the Kesselberg, near Munich, and on the third day a speed trial over a 6-kilometer course on the level in the Forstenrieder Park. Following these will be a three-day reliability trial, the routes being: First day, Munich Bruck, Augsburg, Ulm, Tübingen, Baden Baden. The distribution of the prizes will take place on the seventh day. Each car in the reliability trial will carry an observer.

The Bleichröder competition, which follows immediately after, is for racing cars, and will occupy two days, the first devoted to a trial of the Kesselberg hill, the second to speed runs over the 6-kilometer course in the Forstenrieder Park, the cars being started singly and the prizes awarded on the basis of the best average time. It will be open to cars of not over 1,000 kilograms weight (with an extra 8 kilograms allowed for magneto-ignition), the different parts not being of necessity made in the country of the club represented.

The Herkomer prize is a trophy costing at least 10,000 marks (\$2,500), and in addition the portrait of each winner painted by Prof. von Herkomer and valued at about an equal sum. In addition, a silver trophy costing 1,000 marks is offered by H. R. H. Prince Ludwig Ferdinand of Bavaria to the car making the best average in the hill-climbing and speed trials; in the event of a tie, the prize to go to the winner of the hill trial. A silver trophy costing 1,000 marks will also be given by the German Automobile Club for the handsomest and most practical body. The Herkomer prize is to become the permanent property of the first competitor who shall win it twice within three years; if won by a different competitor each year, at the end of the third year the three shall draw lots for it. To the winner of 1905 will be awarded a special prize, a work of art by the sculptor, von Gohsen, valued at 2,000 marks, presented by Dr. Magin in the name of the Bavarian Automobile Club. Entries for the Herkomer trophy will close on May 31, 1905. The cars and bodies need not be built in the country of the entering club. The entrance fee is 300 marks.

The Bleichröder prizes are 8,000 marks in cash, with a second prize of 2,000 marks. Entries will close on June 30, 1905.

The management of the competitions has been placed by the Deutsche Automobil Verband in the hands of Count Sierstorff, Dr. Levin Stoelting and Baron Bronden-

stein, of the German Automobile Club, and Count C. Schönborn, Baron Schrenck-Notzing and Louis Poehlmann, of the Bavarian Automobile Club. Details will be furnished on application to the Secretary of the German Automobile Club, Sommerstrasse, 4a, Berlin, or to the Secretary of the Bavarian Automobile Club, Turkenstrasse, 98, III, Munich, Bavaria.

GREELY RECOMMENDS AUTOS.

Army Signal Officers Believe Them Valuable for Military Purposes.

Special Correspondence.

WASHINGTON, D. C., Dec. 5.—In his annual report, just submitted to the Secretary of War, General Greely, chief signal officer of the army, states that the evident value of self-propelled vehicles as parts of telegraph and balloon trains has led him to continue experiments with automobiles. While automobilism in its present state is evidently unsuited for general transportation in the field, the experiences of the Signal Corps, he says, have demonstrated the practicability and advisability of self-propelled vehicles for special military pur-

MURDER STILL A MYSTERY.

Chicago Police Unable to Find Motive or Author of Bate Crime.

Special Correspondence.

CHICAGO, Dec. 3.—The mysterious automobile murder on Archer road, twenty-five miles from Chicago, where John W. Bate, a chauffeur, was shot while driving a passenger who hired the machine at the Auditorium hotel, is still far from a solution. Detectives who have worked on the case for two weeks have made practically no progress. "Mr. Dove," the name given by the passenger, has not been located.

Why Bate should have been killed by his passenger, who did not call for the chauffeur by name, and who was unknown to him, is a question that half a dozen theories have been advanced to answer. Bate was a young man about twenty-one years old. He had been employed about Canary's garage for a year. He had no love affairs that "Dove" could have been interested in. There was no apparent connection between the two men.

"Mr. Dove" rode away from the lake front hotel about 9.30 o'clock in the even-

George W. Hugg, an ex-convict of Chicago, had often employed the name of Dove as an alias;

Hugg was near the Auditorium hotel a few minutes before a man who said his name was Dove ordered the automobile from the garage.

There the police stop. All search for Hugg or Dove have been fruitless. He has been reported as seen in twenty different places since the evening of the murder. He was described by the telephone boy who took the order as of slight build, about thirty-five years old, with smooth face, blue eyes, and wearing a light overcoat and red neck scarf. Every one who is of slight stature and has worn a red scarf and light top coat has been under suspicion. This style of dress is now on the decline about Chicago.

Archer Road, made famous by the Dooley stories, has been visited daily since the murder by hundreds of automobilists. On Sunday from early in the day until late at night there was a constant procession going to and coming from the place where the machine was found. About the various garages the one subject discussed has been the mystery of this murder. It is probable that Hugg can not long escape the police. Whether his arrest will solve the murder or not is a question. The probabilities seem to be that it will not.

TRACKLESS TROLLEY CAR.

New Type of Passenger 'Bus to Use Batteries or Overhead Wires.

Special Correspondence.

BUFFALO, Dec. 5.—A big trackless trolley car to be used in passenger service in Salamanca, N. Y., was completed in this city several days ago by the Auto Car Equipment Company. It was given a trial run in Buffalo last Tuesday, and at that time was operated by means of a storage battery. Two other similar cars will be shipped to Salamanca in a month.

The car is 15 1-2 feet long and 6 1-2 feet wide. It has glass vestibules at both ends and a permanent wooden roof. The six seats are placed crosswise and the car is open like a summer trolley car. There are self-acting curtains at either end of the seats so that the car can be wholly enclosed in case of storm. The normal seating capacity is 24 passengers. The motorman occupies a seat inside the vestibule. The car weighs three tons and the wheels are equipped with heavy rubber tires. The interior is lighted with incandescent lights and there is an electric headlight. The maximum speed is twelve miles an hour and the storage battery will run it for forty miles.

In operating the vehicle as a trolley car the storage battery will be supplanted by a flexible wire that will slide on a double trolley wire overhead. One wire will be a conductor and the other will complete the electric circuit. The flexible wire loop will be arranged to give the car a running radius of eight or ten feet on either side.

Several prominent men are interested in the concern which will operate the trackless trolley system, and which is known as the Salamanca Electric Traffic Company.

She—"Been drinking, George?"

He—"No, dear."

She—"Why are you chewing cloves, then?"

He—"Oh, I've been riding with a friend in his automobile and I didn't want to annoy you with the smell of the gasoline."

—Acetylene Journal.

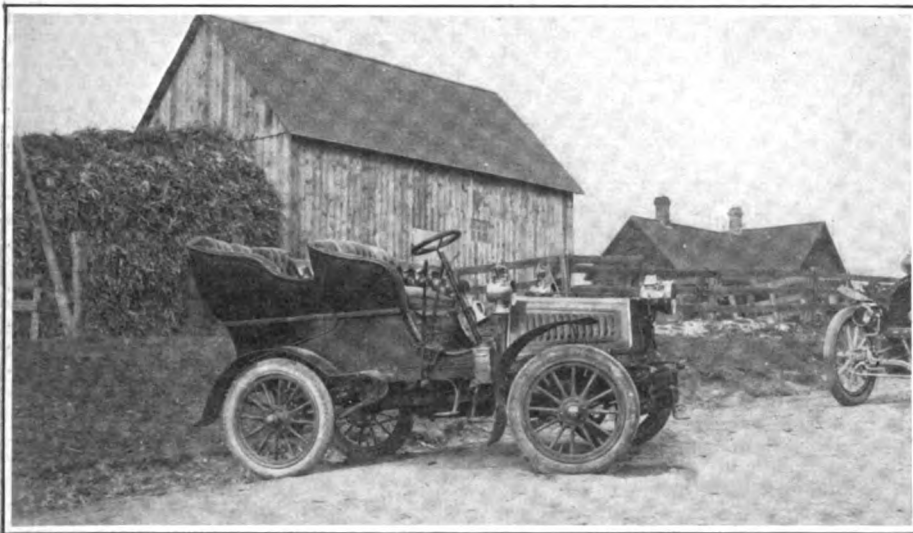

CAR AND PLACE IN WHICH CHAUFFEUR BATE WAS FOUND SHOT DEAD.

poses. General Greely adds that experiments in foreign armies likewise confirm this opinion.

While the good points of electric and steam vehicles are thoroughly recognized, yet the internal combustion type, using kerosene or other oil, seems better suited for war purposes in the opinion of the chief signal officer. This type, he says, has especially valuable features from a military standpoint in its small fuel and water consumption, an essential quality for reliable service in field operations.

EXPORTS FOR FOUR MONTHS.

Comparative exports of American automobiles during the months of July to October, inclusive, in 1903 and 1904, were as follows:

	1903.	1904.
July	\$159,739	\$183,180
August	171,132	168,303
September	143,518	123,487
October	119,131	130,891

An automobile from Morrison and its occupants called at Glenwood farm one day recently. It isn't every farm that has the distinction of entertaining an automobile party.—Morrison (Ill.) Sentinel.

ing. If there were other passengers in the automobile they entered after leaving the hotel. It is the belief of many that either a woman or a man did join "Dove" later. If "Dove" and his companion had a quarrel which resulted in a murder, "Dove" may have killed his chauffeur to hide the first crime.

When the detectives made a search of the dismal country surrounding the scene of the murder it was with the firm belief that another body would be discovered. A farmer's wife near the place where the murdered man was found in his machine heard a woman's voice when the automobilists stopped on the evening of the murder to inquire the way. This statement was attested to by the woman's husband. Others who live on Archer Road heard, or claimed that they heard, the voices of persons in dispute. If these statements are true—and there is no reason to doubt them—"Dove" may have killed a woman in a jealous rage and then shot down the chauffeur because of his knowledge of the affair.

The detectives have so far been able to learn this much:

A man who registered in Aurora as D. B. Love two days before the murder sold a stolen horse and buggy in Elgin the next day;



SUCCESSFUL NEWARK CLUB.

Causes of Growth of New Jersey Automobile and Motor Club.

Special Correspondence.

NEWARK, Dec. 5.—A well attended and enthusiastic meeting of the New Jersey Automobile and Motor Club was held last Friday evening in the Newark Board of Trade Rooms. The treasurer's report showed a balance of more than \$1,500, and a membership of 200. The following were elected to honorary membership: Mayor Henry M. Doremus, of Newark; James M. Reilly, P. J. Murray, Benjamin Mayer, Joseph V. Clark and J. J. O'Connor.

It is expected that the question of joining the A. A. A., which was laid on the table, will be settled at the next meeting.

B. M. Shanley, Jr.; R. C. Jenkinson, and James M. Reilly were appointed to confer with the Road Horse Association in regard to the erection of a joint clubhouse near the new Speedway.

Secretary C. H. Gillette and Chairman of the Tours Committee Augustus Post, of the A. A. A., made an address showing what the association has done in the past, and advising the club to join, so that the New York and New Jersey clubs may be banded together to bring about the building of a suitable highway between Jersey City and Newark.

A committee was appointed to take up, with the Board of Trade and the city officials, the matter of improving the roads.

The board of governors held a meeting at the close of the club meeting, to make arrangements for a smoker to be held in the near future.

Although one of the youngest organizations of its kind, the growth of the New Jersey Automobile and Motor Club is considered marvelous, for the members have never had any meeting place except the rooms of the Newark Board of Trade, which they share in common with several other organizations, and, with the exception of a parade last spring, a club run one Sunday recently, and the race meet at Waverley Park last month, have done little that would be expected to attract new members.

There are two reasons for this rapid growth. One is the indefatigable efforts of the president, Frederick R. Pratt, who was elected last spring, and who has declared that he will not vacate his office next May, with a membership of less than 500. The other explanation is the club's policy, defined in the constitution, of co-operating to secure rational legislation governing the use of motor vehicles in city and country; to protect the interests of owners and users of automobiles against unjust or unreasonable legislation; to maintain the lawful rights and privileges of owners or users of all forms of self-propelled pleasure vehicles wherever such rights or privileges are menaced, and to promote and encourage in all ways the construction and maintenance of good roads and the improvement of existing highways.

The protection of its members from unjust persecution has taken precedence over everything else. Almost the first thing the club did was to retain a lawyer as its permanent counsel, at a salary, to advise the members whenever they get in trouble and to defend the suits that may be brought

against them, all without cost to them, provided the legal committee of the club, after examining into the circumstances of the case, conclude that the defendant is not to blame in the matter.

The first case which the lawyer was called upon to defend for a member was that brought by Wm. Fitzgerald against Wm. I. Fisk, a real estate dealer, and prominent member of the club, whose car collided with Fitzgerald on April 5 last while the latter was crossing a busy street in Newark. Fitzgerald suffered injuries more or less serious and immediately started suit for heavy damages. The case was tried before the Chief Justice of the New Jersey Supreme Court this fall, who granted a non-suit in favor of the defendant, declaring that Fitzgerald was guilty of contributory negligence in not looking well where he was going when he undertook to cross the thoroughfare.

As the outcome of the recent race meet, held by the club at Waverley Park track, B. M. Shanley, Jr., former president of the organization, tendered a mushroom dinner on November 30 to the officials who assisted in making the affair a success. Fourteen invited men journeyed twenty-five miles in four cars to the Maison Pidefour, where the dinner was served. On board of Mr. Shanley's 90-horsepower Mercedes was President Frederick R. Pratt, Dr. English, and Secretary C. S. Wells. W. C. Murray, in his Decauville, carried P. G. Murray, J. W. Mason and J. H. Wood. W. V. Snyder, in a Peerless, had with him R. T. Newton and J. H. Dawson. In another Decauville R. H. Burt had J. V. Clark, James Reilly and J. J. O'Connor, Jr.

After the repast several hours was spent in relating stories on motoring. It was also decided to continue to hold the race meets at Waverley.

A contingent of motorcycle members of the club, held a race meet of their own last Saturday at Waverley Park. Only three machines were entered and two events run off, both for ten miles. The two races were won by Allen Reid, on a 4-horsepower Orient, the time for the first race being 15:30 and for the second, 16:30. The trials were so successful that similar races will be held next year.

NOTES OF THE CLUBS.

BROOKLYN.—The annual dinner of the Long Island Automobile Club will be held on December 21 at the new clubhouse, 360 Cumberland avenue, Brooklyn.

NEWARK.—At the annual meeting of the Physicians' A. C. of this city, to be held soon, plans are to be discussed by which the Newark club can be made into an international body. Such a step has been contemplated because of inquiries received from Paris and London about the objects of the club and the interest shown in its welfare by automobilists living abroad.

NEW YORK.—On account of the destruction by fire of the plates used in printing the maps issued to members of the A. C. of America, new ones will be prepared at once, and will embrace revisions and corrections of the errors in the first edition of these maps. Members are urgently requested to forward at once to the club secretary any corrections which they deem necessary, and also to send full and detailed descriptions of any good routes in the territory covered by the old maps, as well as in the area north

and south of the central New Jersey section published this year. Maps of southern and northern New Jersey, and the adjacent parts of Pennsylvania, Delaware and New York are in preparation, and are to be issued to members on or about May 1.

CHICAGO.—At the recent monthly meeting of the Board of Directors of the Chicago Automobile Club the following applications for membership were favorably acted upon: Joseph Beifeld, William Howard Hoops, William Herrick and Benjamin S. Walker.

NEWARK, N. J.—The regular meeting of the A. C. of New Jersey was held at the clubrooms in Harrison avenue, East Orange, on December 1, when the result of the recent Eagle Rock hill climbing contest was discussed. Secretary Gillett's report was gratifying from a financial point.

NEW YORK.—Hon. Leroy B. Crane, a city magistrate who has come into a good deal of prominence because of his reported strictness against automobilists brought before him charged with excessive speeding, is announced to deliver an address on "The Automobile and the Magistrate" before the Automobile Club of America, at its Tuesday evening meeting, December 13.

LONDON.—The Ladies' Automobile Club of Great Britain and Ireland has arranged for a course of six lectures to be given to its members on the internal combustion engine, as applied to self-propelled vehicles. The lectures commenced on November 22 and will be concluded on January 24. Mr. Sedgwick Currie, who is consulting engineer to the Ladies' A. C., will give the addresses.

BERLIN, Germany.—The German Automobile Club will shortly move from its present premises at 4a Sommer Strasse, Berlin, to 16 Leipziger Platz, a house belonging to Dr. James von Bleichroeder, which the club has acquired at a very reasonable sum. The suite of rooms at the Sommer Strasse proved too small for the steady growth of the club. Dr. von Bleichroeder is a leading member of the organization.

PITTSBURG.—The Pittsburg division of the American Motor League has arranged for new winter quarters on the second floor of the Hiland garage, on Beatty street. The officers are already planning to get reduced railway rates for the New York Show, and it is probable that at least 100 motorists will take advantage of this to visit the Madison Square Garden event and also the Automobile Salon of the dealers in foreign cars.

PHILADELPHIA.—On Tuesday morning last, at the residence of the bride's parents, H. Bartol Brazier, the popular secretary-treasurer of the A. C. of Philadelphia, was married to Miss Annie E. Milne, daughter of Mr. and Mrs. Francis F. Milne. The groom's clubmates were prominent among the guests, several of them assisting in the ceremony in the capacity of groomsman or ushers. After the wedding breakfast Mr. and Mrs. Brazier left for the south on a fortnight's wedding trip.

BUFFALO.—At a meeting of the A. C. of Buffalo, held last Wednesday, William H. Hotchkiss announced his intention of retiring from the presidency at the expiration of his present term. An election of officers is to be held December 19, and Augustus H. Knoll was nominated for president. Other nominations are as follows: Vice-President, H. A. Meldrum; secretary, D. H. Lewis; treasurer, Col. Charles Clifton. The board of governors for the ensuing year will be composed of Edward H. Butler, E. R. Thomas and W. H. Baker. President Hotchkiss has received from Assistant State Engineer Rockwell, at Roch-

Current News From New York.

ester, a fine map of New York State, showing every road west of Utica. This has been framed and hung in the club rooms. On the map is a detailed description of every road shown and other general information of value to automobile tourists.

PITTSBURG.—The A. C. of Pittsburg is making every effort to make the winter as enjoyable to its 250 members as the summer and fall were. A hockey team has been organized among the following members, who are expected to become experts in a short time: A. E. Mashey, T. F. Dunn, D. P. Collins, A. L. Banker, Charles Rowe, Richard Pollard and Ralph Clemson. The men will be assigned positions in a few days and the team will compete with various business men's clubs this winter.

NEWTON, Mass.—Seventy members and guests of the Newton A. C. attended the first annual banquet of the club, held last Wednesday evening at the Newton Club, in Newtonville. Among the guests were President Harlan W. Whipple, of the American Automobile Association; President Elliot C. Lee, of the Massachusetts Automobile Club; Alexander Winton, of Cleveland, and Hon. Samuel L. Powers, Congressman from the district that includes Newton. President William M. Ferris presided, and the after-dinner speaking was more or less informal. The guests spoke generally upon the use of automobiles and related some of their experiences. Local speakers outlined briefly the efforts that are to be made at the incoming legislature to have some of the restrictions on automobiles repealed, and to have good roads extended to some parts of the state where they do not at present exist.

BOSTON.—The committee of the Massachusetts Automobile Club, which has had in charge the arrangements for a house-warming of the enlarged clubhouse, have decided that the event shall take place next Friday evening. The extension was completed and occupied and was opened early last summer on the day the Boston contingent of the A. A. A. St. Louis tour left this city. Since then it has been in use constantly, but there has been no formal dedication. The committee in charge of this function consists of Stephen Sleeper, Harlan W. Whipple and Dr. J. C. Stedman. The exercises will begin at 6.30 o'clock with dinner, which will be followed by an entertainment, a reception and a late lunch. It is expected that a large number of automobilists who belong to the club will attend the house-warming, and the event will be a sort of reunion of local enthusiasts. The building is three stories high and has a frontage of 120 feet on Boylston street, with a depth of about 100 feet. There are two entrances for cars and separate entrances for the office and the ladies' apartment on the ground floor. The second and third floors of the old clubhouse are used for club purposes, but all the space in the addition is used for the storage of cars and for the machine shop.

EXPORTS OF AUTOS AND PARTS.

Automobiles and parts of same to the value of \$130,891 were exported from the United States during the month of October, 1904, as compared with similar exports aggregating \$119,131 in the same month a year ago, showing an increase of \$11,760.

For the ten months ending with October, 1904, the exports totaled \$1,576,877, as compared with \$1,311,960 for the same period in 1903, representing an increase of \$264,917.

An express motor-omnibus and parcel delivery service has been established in the Isle of Wight.

One American Gordon Bennett candidate has appeared. Dr. H. E. Thomas, of Chicago, has entered his Locomobile racer, an entirely new 90-horsepower car designed by A. L. Riker, the engineer of the Locomobile Company of America. The machine, which is not yet completed, is building after the general design of Locomobile touring cars, and is not radical in important features. Though the entry list closes on December 15, and only one entry is as yet on the books, no doubt seems to exist in the minds of the A. C. A. officials concerning the making up of a team, owing to the American habit of deferring entry until the last week—or even the last hour.

The old plank road between Jersey City and Newark, N. J., is to be repaired, or rather rebuilt, and widened to 100 feet. Doubt exists, however, concerning the proper paving to lay, and arrangements for commencing the work cannot be made until this point is settled. From Newark fine macadamized roads radiate in all directions, and poor roads are almost unknown; but the two shortest routes to Newark from New York city—the plank road and the Arlington Pike—are in very bad condition. New Jersey automobilists, while glad that the plank road is to be made usable, are anxious to see the Arlington Pike put in good condition, and are quietly working to have this done.

At the last meeting of the Executive Committee of the National Association of Engine and Boat Manufacturers it was decided that sanction would be granted for only one show during 1905. That will be the one to be held in conjunction with the Sportsmen's Show in Madison Square Garden in February. For that occasion, water space has been reserved for the boats and has almost all of it been sold. As this is the first national power-boat show, the interest taken insures a most interesting exhibition of this industry.

Hold-ups of automobilists, conducted in the customary manner, have grown almost commonplace and unworthy of much comment; but interest has been aroused anew by a novel hold-up game played by a few clever rascals near Belleville, N. J. It is reported that two men, wearing what appeared to be police badges, held up several automobilists, took them before a bogus judge deep in the woods, with a box for a bench and another for a desk, who fined them handsomely under the greenwood tree. There is a warm time awaiting these geniuses—when they are caught.

The Pipe car, of Belgian manufacture, is now represented in this country by Joseph S. Heller, with headquarters at 123 West Fifty-second street, New York city. Mr. Heller says that, having secured the exclusive agency for this machine for the United States, Canada, Mexico, Central America and the West Indies, he will establish sub-agencies as may be required. A Pipe racing car will, he says, be entered in the Florida tournament. Concerning the adaptability of the Pipe car for American roads, it is stated that the Belgian roads are, for the most part, exceedingly rough, testing the strength of a car very severely. A 15-horsepower machine has arrived and will be exhibited at the Importers' Salon, where space has been secured. It has a limousine body, with luxurious appoint-

ments for six passengers, including electric lighting, folding table and other features making for comfort and convenience.

Another fresh importation for the Salon is a Delahaye car of 30 horsepower, with Cape cart hood. The American agent for this car is L. J. Caugler.

The Union Motor Supply Company, with headquarters at 1 West Thirty-fourth street, New York city, which was incorporated recently with Baron Frederic de Turkheim as president, J. J. Bradley vice-president, and R. E. Jarrige, treasurer and manager, will handle automobile supplies and accessories of all kinds, but not complete cars. Foreign goods will be imported and American goods exported. Branch offices will be established at once in Paris and Berlin, and later in other European centers.

The Automobile Club of America will be represented by Clarence Gray Dinsmore at two conferences in Paris, one to be held on December 10 and the other on December 12. Gordon Bennett race matters, including the proposed changes in the conditions, will be discussed at the first conference, and automobile matters in general at the second.

In view of the wholesale destruction of automobiles by the burning of the Standard garage on Monday, the announcement of Beardsley, Stiles & Co., 22 Clinton street, Newark, N. J., regarding automobile insurance should be of interest to automobilists. This firm states that it issues fire insurance policies covering damage by fire from any cause whatever, and good in any part of the United States, as well as accident and liability policies.

The 80-horsepower De Dietrich racing car that took part in the Vanderbilt Cup race, driven by Gabriel, has been purchased by O. F. Thomas, of New York, a cousin of E. R. Thomas. The car will be raced in the Florida tournament, and will be driven by an American driver, Fletcher. There promises to be keen friendly rivalry between the two cousins for supremacy in the automobile racing game. The American De Dietrich Company, of New York, will also enter a De Dietrich racer for the Florida events, and efforts are being made to arrange to have Gabriel come to this country to drive the machine, which will be almost a duplicate of the one sold to Mr. Thomas.

The Harrolds Motor Car Co., organized to handle the Oldsmobile and Pierce automobiles, with Harry Unwin, formerly secretary of the N.A.A.M. and later with the Olds Motor Works, at the head, has secured quarters in the Journal Building, Columbus Circle, New York, and the work of fitting up the place is progressing actively. A complete stock of Olds and Pierce cars will be carried, and the salesroom is intended to be a model of its kind. Every car will undergo a thorough cleaning before being placed on the floor, and under each will be placed a plate glass mirror so that the car can be examined readily. Accessories and supplies will be carried in stock as well as automobiles. R. G. Howell, who is closely identified with the Oldsmobile in New York city, has been retained by the Harrolds company.



The Kokomo Electric Company has been incorporated at Kokomo, Ind., for the purpose of manufacturing a full line of high grade electric ignition apparatus for gas engines, including spark coils, both jump spark and primary, storage batteries, dynamos and magnetos, spark plugs, commutators and timing devices, switches, wire terminals, etc. This company has purchased the factory and plant of the E. S. Huff Company, of Detroit, moved it to Komomo, and added a large amount of new machinery, making it one of the best equipped factories of its kind in the country. A large amount of the stock of the Kokomo Electric Company is held by members of the firm of Byrne, Kingston & Co., who will handle the entire output of the new plant. George Kingston, general manager of Bvrne, Kingston & Co., will also manage the Kokomo Electric Company, with E. S. Huff as electrical engineer. The output of this factory, which is already in operation, added to the line of carbureters, mufflers, circulating pumps, oiling devices, steering wheels, etc., of their own manufacture, will give Byrne, Kingston & Co. one of the most complete lines of accessories marketed in the United States.

The retail business of the E. R. Thomas Motor Company, of Buffalo, will be handled next season from the main factory, 1,190 to 1,200 Niagara street and the motorcycle business from factory No. 2, at 1,413 to 1,421 Niagara street. Both of these factories at the present time are being operated day and night and deliveries of the new models are being made daily. "Cal" Paxton, who had charge of the Thomas exhibition at the St. Louis exposition, will have charge of the retail department. The company will continue to market its three-cylinder model with the same improvements in engine and body as characterize the 40-horsepower four-cylinder model.

The Hartford Rubber Works Company is laying a foundation for future new business in Philadelphia just now. Ever since Friday last "Teddy" Edwards and W. R. Barnes have been showing the local automobile public how easily the Dunlop detachable tires can be manipulated. Many persons have witnessed these demonstrations, which were held Friday at the Tioga Automobile Station and at Wanamaker's Station, and on Saturday at the Quaker City Automobile Company's establishment. Monday the demonstrations were held at the garage of the Pennsylvania Electric Vehicle Company.

One of the women who do not consider the management of a gasoline automobile beyond their ability is Mrs. Catherine Baker, of Dayton, O., who takes solitary trips in her Haynes-Apperson runabout and occasionally ventures upon journeys of considerable length. Mrs. Baker recently made a round trip between Dayton and Kokomo, Ind., in her car, the total distance being 300 miles. The only trouble experienced was caused by the picking up of a pebble which broke the driving chain. Repairs made it necessary to take part of a second day to finish the first 150 miles, the return trip being completed in one day.

The Eastern Automobile Co., with headquarters at Philadelphia, has been organized by the following incorporators: M. E.

Brigham, A. B. Cumner, George T. Thompson, H. K. Buck and J. R. Maynes. Temporary offices are now located at 712 Girard Trust Building, but it will at an early date occupy a thoroughly equipped and centrally located garage and salesroom. The new company has secured the exclusive agency for the Philadelphia territory for the Peerless and Stevens-Duryea cars, and will add still another machine to complete its line.

The Reo Car Co., of Lansing, Mich., is busily engaged in preparations for manufacturing on a large scale, and sales manager R. M. Owen, who has recently returned from a visit to the factory, states that 3,000 machines will be turned out of the works during 1905. The factory itself is completed, most of the machinery has been installed, and material for automobile construction is arriving in large quantities. Twenty cars a day will, it is said, be the output of the works immediately after the New York automobile show.

Notwithstanding a recent investment of nearly \$30,000 for additional machinery, and the night operation of the plant up to 9 o'clock all through November, the Packard Motor Car Company, of Detroit, began work last week on a second floor addition to the north wing of the factory. This work is to be rushed to completion and when done will afford an additional floor 326 by 60 feet, or 19,560 square feet. This room is to be used to relieve pressure on several departments, especially on the painting and upholstering departments.

The Orange Automobile Garage has been organized at Orange, N. J., by Frederick C. Hinni, Jr., a graduate mechanical engineer, and R. Arthur Heller, a graduate of Columbia University, to deal in automobiles and automobile supplies. The new firm is equipped to give especial trained attention to expert repair work in addition to storing all kinds of vehicles and charging electric vehicles. A specialty will be made of repairing foreign cars.

The New York & New Jersey Lubricant Co. writes that Messrs. Anderson & Price, proprietors of the Ormond Hotel, have decided to furnish exclusively N. F. O. gas engine cylinder oil and non-fluid oils during the January races of the Florida East Coast Automobile Association. These lubricants were supplied exclusively during last winter's tournament and also during the Mt. Washington climb to the clouds last summer.

Among the recent changes in the Chicago automobile trade is the consolidation of F. J. Pardee, of Pardee & Co., who have handled the Packard cars in Chicago for the past four years, and Henry J. Ullman, who handled the White steamers for the past season. The new firm will be known as the Pardee-Ullman Company, and will handle both Packard and White machines.

In order to meet the increased demand for its cars, the Premier Motor Manufacturing Co., of Indianapolis, Ind., has doubled its capital stock, and now has under construction a new and larger factory, which it expects to occupy early in January. This will enable the company substantially to increase its output for 1905.

A two-story brick building is being erected on Michigan avenue, between Twelfth and Thirteenth streets, Chicago, for Orlando F. Weber's salesrooms and garage. Mr. Weber handles the Pope-Toledo cars, and is at present located on Wabash avenue, but expects to remove to his new quarters about January 1.

Preparations are now being perfected by the Automobile Club of Sweden to hold an automobile race meet next February on the ice of a river near Stockholm, the races to include many different classes. Owners of racing machines of other countries will be invited to take part in the contests.

Leading manufacturers of American automobiles who are desirous of placing their cars in foreign markets are invited to forward their catalogues to Earl Gilberto Arrivanhene, at the Palazzo Papadopoli, Venice, Italy.

The Miller-Knoblock Electric Manufacturing Co., of South Bend, Ind., has been succeeded by the Knoblock-Heideman Manufacturing Co., and the business will be continued as formerly.

The Truffault-Hartford Suspension Co., of 67 Vestry St., New York city, has been incorporated under the name of the Hartford Suspension Co., the address remaining the same.

The Chicago Automobile Exchange will handle the Ford cars for 1905. The Chicago agency for this machine was formerly held by the Illinois Motor Co.

James S. Levy, of the Mead Cycle Co., has secured the Chicago agency for the Autocar for 1905.

RECENT INCORPORATIONS.

De Mars Electrical Vehicle Co., Cleveland, O.; capital \$25,000. Incorporators, William O. De Mars, Charles Wilson Baker, John R. Blakeslee, Sr., Harry J. Gibbons and A. M. Barnes.

Auto Garage and Electrical Construction Co., Zanesville, O.; capital \$5,000. Incorporators, C. A. Rosa et al.

Union Motor Supply Co., Manhattan, N. Y. C.; capital \$25,000. Incorporators, Rene E. Jarridge, Jesse J. Beitler, Frederick C. Turckheim, all of Manhattan.

Harrolds Motor Car Co., Manhattan, N. Y. C.; capital \$30,000. Directors, Edward J. Steiner and Edward Brand, of New York, and Harry Unwin, of Detroit, Mich.

Curtis Automobile Co., Brooklyn, N. Y.; capital \$1,000. Directors, Charles G. Curtis, Van Wyck Curtis and Alice W. Curtis, all of Brooklyn.

Motor Supply Co., Yonkers, N. Y.; capital, \$1,000. Directors, David M. Harvey, William C. Dodge, of New York city, and P. F. W. Ruther, of Brooklyn.

Cahill Automobile Co., of Washington, D. C.; capital, \$5,000; to conduct automobile storage and repair business, including the buying and selling of machines. Incorporators, Frank S. Cahill, Wm. S. Duval and A. E. H. Middleton.

Rapid Motor Vehicle Co., Detroit, Mich.; capital, \$100,000. Incorporators, Albert Marx, Barney Finn, Delia Grabowski and Max Grabowski.

THE AUTOMOBILE

WEEKLY

NEW YORK—SATURDAY, DECEMBER 17 1904—CHICAGO

10 CENTS

PRACTICAL TEST OF HUB-MOTOR TRUCK.

C LIMBING Lexington Avenue hill, between 102nd and 103rd streets, New York, is a genuine test for a motor vehicle under any conditions; but making the ascent with a load of more than four tons (8,700 pounds, to be precise), and

the electric truck illustrated herewith, went up the grade last Saturday. The hill starts abruptly at 102nd street with a grade of 15 per cent., and increases to 16 per cent., which gradient is held through the greater length of the block. Right at the top there

and steers with front and rear wheels at the same time. There is a 2-horsepower motor in each wheel, and enclosed with it is the necessary transmission and reduction gearing. As a consequence of the equal distribution of the driving power the wheels



FOUR-WHEEL-DRIVE TRUCK CLIMBING NEW YORK'S STEEPEST HILL WITH FOUR-TON LOAD IN A HEAVY SNOWSTORM.

stopping and re-starting midway up the hill, during a snowstorm that had spread patches of snow on the stone block paving, is a feat few drivers would care to set their vehicles to attempt. Under such conditions

is a short pitch of 18 per cent., and the hill terminates more abruptly than it began.

The Holson electric truck, which made this demonstration, is peculiar in several respects. It drives through all four wheels,

are enabled to obtain a traction under the most unfavorable conditions, notwithstanding the solid rubber tires have a smooth tread. This was illustrated by bringing the two front wheels of the truck against a

curbing eight inches high and causing them to climb slowly to the top, without jerk or jar. On coming down, the motion was arrested, without using the brake, when the tires were within two or three inches of the road surface. After remaining stationary for a moment in this position, the four-ton truck was again made to mount the curb. This was repeated several times before the wheels were let down onto the paving again, and there was no sign of slipping at either front or rear wheels.

The manner in which this vehicle is maneuvered in congested traffic is likely to make the spectator, accustomed to the conventional methods of steering, stop to look again. Ordinarily the rear wheels turn in the opposite direction to the front wheels and at the same angle, so that they follow exactly in the tracks of the front wheels, as shown in one of the small engravings. With the wheels deflected to the limit, a

brated and sealed. The truck was first tested light, and afterwards with load. Snow fell continuously during the trials, and the road surface for the tests under load was considerably more slippery than during the light tests. This, however, did not seem to have any effect on the working of the vehicle. Empty, the truck started on level road on 15-18 amperes; under load of 8,700 pounds it started on 20-25 amperes. Owing to the difficulty of judging whether the road was actually level, the figures given are probably rather high, but are the result of repeated tests, all on rough, snow-covered streets. When running on level road, light, the meter showed an average of 30 amperes, while with load the average was 45 amperes. Running light up Lexington Avenue hill, the reading was 95 amperes. After stopping on the hill, the truck started light on 120 amperes. Climbing the Lexington Avenue hill with load, the average current con-

even in wet snow fully a foot deep, and even when stopped in the middle of deep snow and started, there was no slip. Slipping seemed to occur only when one wheel ran on a spot giving much less traction than the other three wheels were obtaining. When this occurred that wheel would slip somewhat, though not much. No variation in the speed was noticed, even when two wheels slipped at the same time, the other wheels seeming to take up the work and keep the machine moving at the same rate of speed.

When making turns in the snow, the advantage of having the rear wheels follow in the tracks of the front pair was made very apparent by first altering the steering to the oblique position, when each wheel made a separate track in turning, and then throwing in the regular gear, the rear wheels describing the same arc as the front ones. The difference was noticeable at

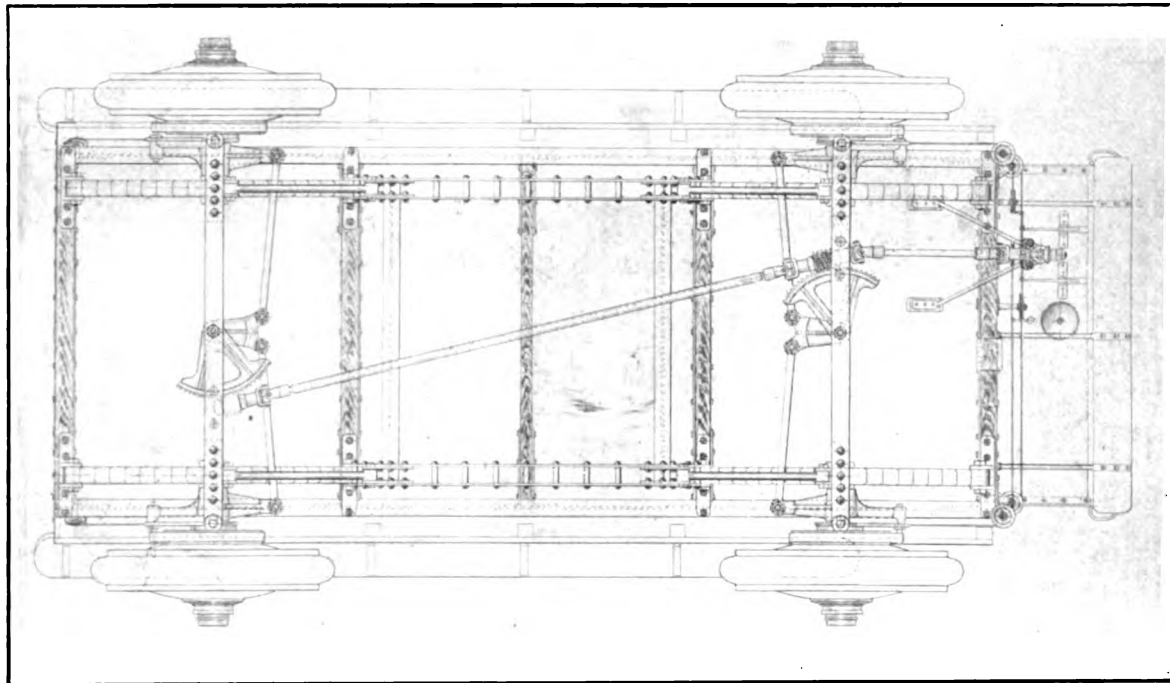

PLAN OF RUNNING GEAR SHOWING FRONT AND REAR WHEEL STEERING CONNECTIONS.

circle about twenty-five feet in diameter can be cut, the wheels following so accurately that but a single pair of tracks can be seen. When occasion offers, however, the steering connections can be so changed by a device worked from the driver's seat, that all four wheels will turn in the same direction and angle, and the truck will execute an oblique movement. Again, the rear wheels can be locked so they do not turn, when the machine will steer like any front steering automobile.

REMARKABLE ECONOMY OF POWER.

The assertions of the owners of the patents that the peculiar system of driving, transmission and steering is economical of power seem borne out by observations made by a representative of THE AUTOMOBILE, who made a trip with the truck last Saturday, and noted the current consumption as indicated by a Weston ammeter, newly cali-

sumption was 115 amperes, voltage 78. This increased at the steep pitch near the top to nearly 125 amperes, and on the first part of the hill was about 100 amperes. The truck was stopped midway up the hill and held, without applying the brakes, on 40 amperes. It was then started up the hill on 150 amperes, which dropped to 115 amperes as soon as the truck got under way.

SLIGHT SLIPPAGE IN SNOW.

A few days after this test, an opportunity was afforded to observe the operation of the truck in heavy, slushy snow. The current consumption fluctuated, naturally with the depth of the snow, which varied greatly, being piled a foot deep in some places where it had been shoveled from the sidewalks, while in other spots the pavement was merely coated with a thin layer of slush. When all four wheels were running under similar conditions no slip was noticeable,

once in the additional work done by the motors, as shown by the ammeter, which indicated an increase of several amperes.

CONSTRUCTION OF THE WHEELS.

The interesting features of the truck, apart from the steering, are centered in the wheels, each of which is formed of two deeply dished disks, between the edges of which the tire is secured. Inside of each disk, close to the tire, is a slightly beveled gear ring, having 225 teeth. The wheel revolves on a short axle hung on a steering knuckle, in the usual manner, and has two roller bearings, one at the hub of each disk. Between the disks and in effect forming part of the axle, the 2-horsepower electric motor is placed, its shaft being horizontal and approximately in the plane of rotation of the wheel. Each end of the shaft carries a nine-tooth pinion, two inches long, one meshing with the gear on one



FRONT AND REAR WHEELS SET AT OPPOSITE ANGLES.



ALL WHEELS SET AT SAME ANGLE FOR OBLIQUE MOVEMENT.

disk and the opposite pinion meshing with the gear on the opposite disk, the motor being set slightly askew to permit of this. Thus, both pinions drive the wheel in the same direction, instead of working against each other and locking the motor, as would be done if the pinions engaged on opposite sides of the same gear. The ratio of gearing is 25 to 1.

EQUALIZER IN ARMATURE SHAFT.

In order to overcome the mechanical difficulty of making both pinions mesh exactly with their respective gears, the motor shaft is divided on the opposite side from the commutator and an equalizing device is inserted to distribute the driving force equally to both pinions. As a result of this double drive, the bearings of the wheels have only the dead load of the vehicle and its lading to support, for, the power being applied on both sides of the axle, there is no unequal pressure on the bearings, and considerable friction loss is avoided, not only in the bearings but in the gearing itself.

Reference to the illustrations will make

the construction clear, it being understood that the motor is held stationary while the hollow wheel revolves around it. The stubs which form the journals of the axle are

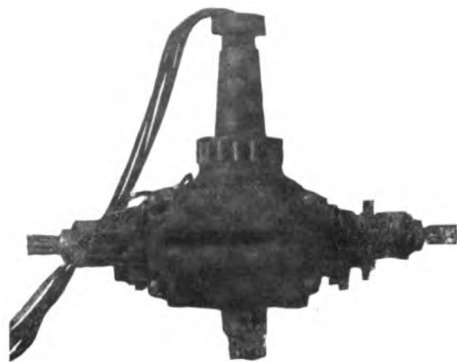

HUB MOTOR, SHOWING STUB JOURNAL AND WIRES, ROLLER BEARING AND DRIVE EQUALIZER.

solidly secured in the metal of the field castings. The part that is attached to the knuckle is tapered and the end threaded, and is held in its socket by a large nut. A

stout steel key holds it from turning. A brass cap on the outer end excludes dust and dirt from the bearing. Incidentally, the motors are protected thoroughly from dirt as well as from accidental injury.

Oil cups hung below the bearings supply lubrication through wicks to the motor bearings, which are of bronze. The wires from the motor lead through the axle, which is hollow, and sufficient slack is left to allow plenty of flexibility. Brake bands are attached to each wheel, and are large and strong. There are two brake pedals, one working the brakes on the two forward wheels and the other the brakes on the rear wheels. These brakes are efficient in action, as was shown when climbing the Lexington Avenue hill, one set being sufficient to hold the truck, weighing, with its load, more than eight tons, on the 16 per cent. grade, without special exertion on the part of the driver.

LONG LIFE OF BATTERY.

The battery, which consists of forty-two Exide cells, type MV 15, was installed in February, 1904, when the truck was com-

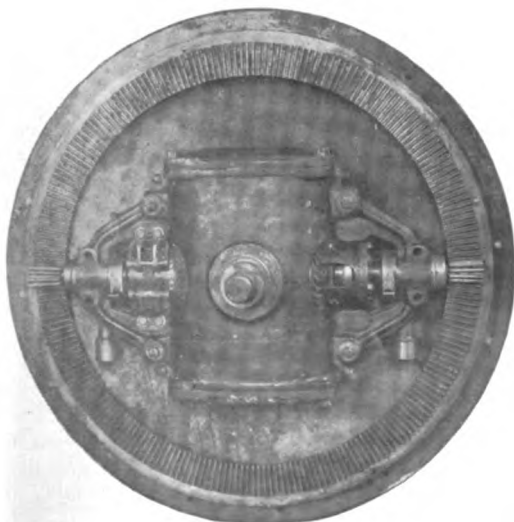

ONE HALF OF WHEEL, SHOWING MOTOR ENCASED.

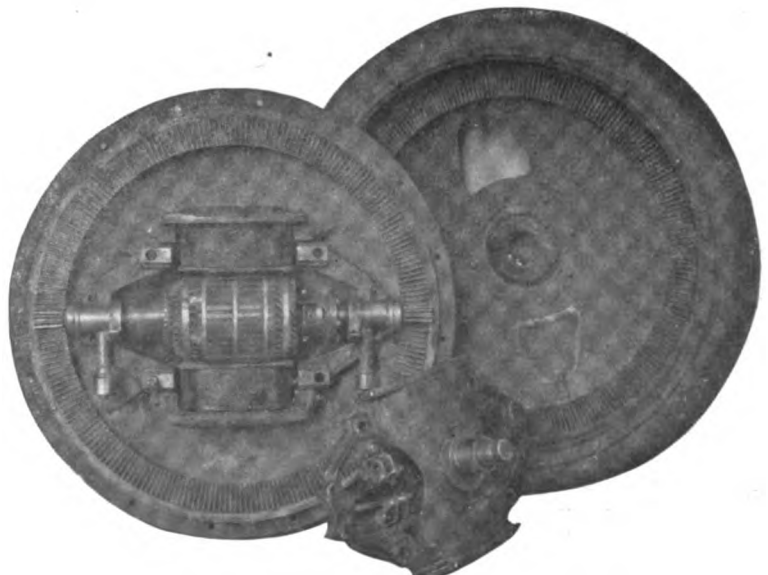

WHEEL DISSEMBLED, SHOWING MOTOR FIELDS AND ARMATURE.

pleted, and although it is said the truck has been in constant service since then, having run about 2,000 miles, the battery is still in excellent condition. It is said that not a plate has been replaced. An inspection of the plates shows that they are, apparently, good for a considerable amount of hard work before renewals will be necessary. This lack of wear and tear on the battery is attributed to the efficiency of the transmission and the directness of application of power to the work to be performed. The greatest mileage made on a single charge of the battery was forty-nine miles. The batteries were not exhausted, however, no attempt having been made to reach the limit.

SMALL WEAR ON TIRES AND GEARS.

An interesting point is the condition of the tires, which are of solid rubber, thirty-six inches in diameter and five inches section. They are smooth and show almost no wear. In fact, the rear tires look almost new, while but slight evidence of wear is visible on the front ones, which break the way, so to speak, for the rear wheels that follow in the paths made by the front ones. The wear on the bearings and gears is also slight. On the pinions, which might be expected to show some of the effects of long use, there was no appreciable wear, the teeth only being worn smooth. The wide area over which the wear on the gears is distributed ensures long life. Each pinion has to transmit only one-eighth of the whole power used, and as each pinion is two inches long, the wear is little more than would occur if the entire power were transmitted by a single pinion and gear with teeth sixteen inches long.

If one or two motors become disabled, one or both can be cut out and the truck propelled by the others. Even one motor will drive the truck up a slight grade, being susceptible of an enormous overload for short periods, and considerable overload continuously. Should the steering of one

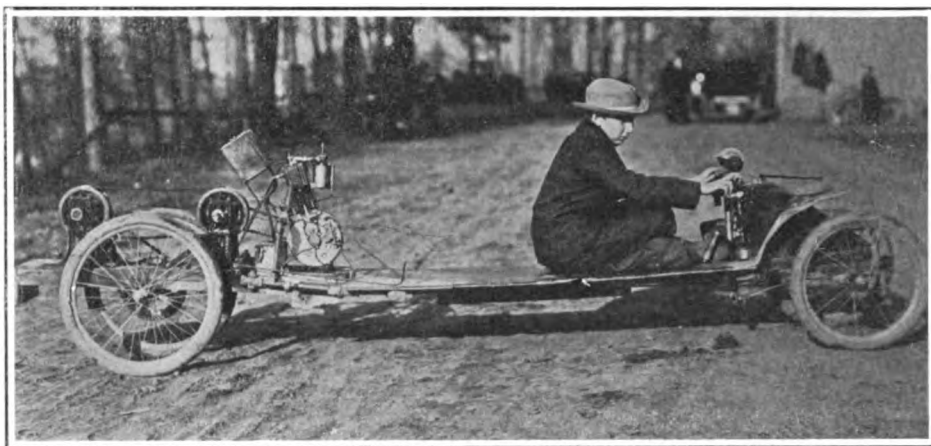

HOME-MADE GASOLINE BUCKBOARD BUILT BY NEW YORK BOYS AGED TWELVE YEARS.

pair of wheels meet with an accident, that pair may be disconnected and the steering done with the other pair, which happened once, while a heavy load was being carried.

The battery is carried in a box slung under the middle of the truck platform. The platform is twelve feet long and six feet wide. The wheelbase is about 100 inches and the tread six feet. Without load, the truck weighs about four tons.

This truck, which is the property of the Holson Motor Patents Company, Ltd., of Grand Rapids, Mich., was built in Chicago a little more than a year ago. Since leaving the shop where it was constructed, it has been in constant use for demonstration in various parts of the country, and was brought to New York in November, by M. B. Church, the general manager of the company.

The owners of the patents will probably arrange for the manufacture of the wheels, motors and steering gear, which will then be sold for attachment to existing vehicles, as this can be effected without serious difficulty. Pleasure vehicles will be con-

sidered later on. The vehicle illustrated herewith is the only one built as yet.

Boys' Home-Made Autos.

French boys have proved themselves exceedingly clever in imitating, on a small scale, the outward appearances of automobiles of various types, some of these miniature cars being such faithful copies that without the means for making comparisons the eye might readily be deceived at a distance. These ingenious toys possess a serious drawback, however, for they are without motive power, depending upon gravity for their propulsion. Their finely formed and gaily painted bodies are empty.

Young America, on the contrary, cares little or nothing for outward appearance so long as he can put together something that has motive power that will carry him with it.

Two striking examples of this are shown in the accompanying photographs of machines built by boys for their own use. The "steamer" was built by L. J. Wyckoff, of Newark, N. J., a lad employed in an automobile repair shop; and doubtless the young owner derives much pleasure from the work of his own hands. He drove in it to the Eagle Rock hill climb on Thanksgiving day, where his production attracted considerable attention.

The gasoline "car," of the buckboard type, was built by two twelve-year-old boys, Woodruff Halsey and E. J. Dimrock, of New York city. The engine is a bicycle motor of 1 3-4 horsepower, driving one rear wheel through an original and "specially designed" transmission. The most valuable feature about these two vehicles, in the eyes of their builders and owners, is that both will "go" under their own power and carry the boys at good speed.

Frank Sparling, the South Locust street groceryman, is the owner of an automobile that arrived from Kansas City Thursday. It is a gasoline "runabout," similar to the machine owned by Harry Brown. Mr. Sparling gives promise of becoming an experienced "chawfer."—*Chillicothe (Mo.) Democrat.*

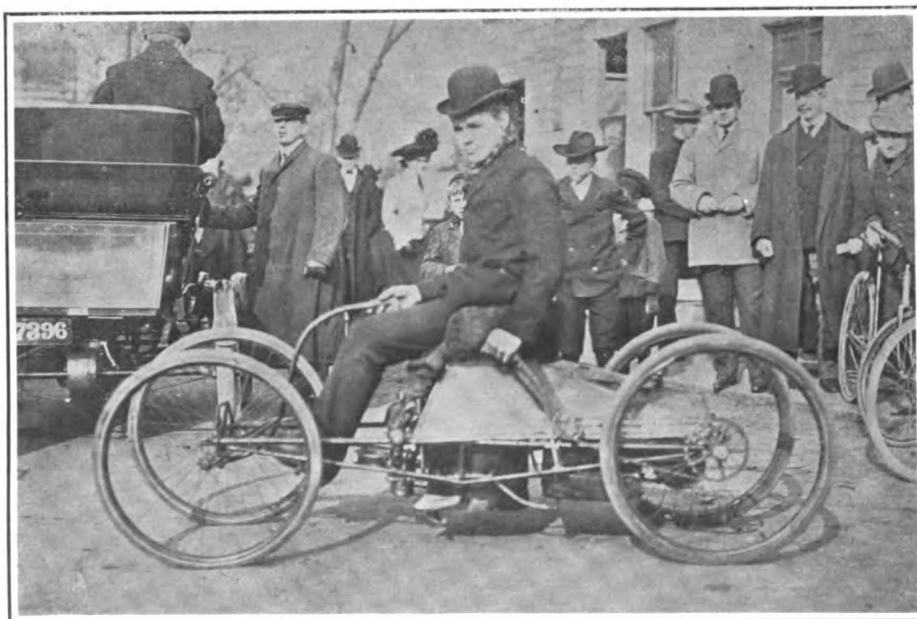

LIGHT STEAM RUNABOUT BUILT BY NEWARK BOY EMPLOYED IN REPAIR SHOP.

Winter Shopping with Autos.

Far from disappearing with the first fall of snow, the automobile is this year more in evidence than ever before in New York at this season. Cars of all descriptions are seen ranged along the curb throughout the shopping centers, and the "toot-toot" of the horn is heard on every thoroughfare, both uptown and in the financial quarter. What motoring means to the chauffeur of a livery cab on a snowy day is shown in one of our pictures; the lofty heights of his seat invite the wintry breezes which sweep across the city from river to river and whirl the eddying snow in all directions from the tall buildings.

The other side of the picture is shown in the second view—one of the most elegant of the new closed private gasoline cars departing with its owner from the entrance to a store. The car is fitted not only for city work, but has the power for suburban driving and touring.

The photograph presents an ideal picture of winter traffic conditions in the metropolitan shopping district during last Monday's heavy snowstorm. Immediately behind the automobile is a powerful electric sweeper for clearing the snow from the street car tracks and preventing the blockades that so quickly tie up a whole line of cars. To the right is a car moving in the opposite direction on slippery rails. These and the packing snow on the asphalt paving combine with the blustery wind and driving feathery flakes to make the threading of the maze a feat to test the ability and the composure of the most expert driver.

AN ARMY MOTOR AMBULANCE.

There has just been completed in England a motor car which is intended to give complete protection to the Royal Army

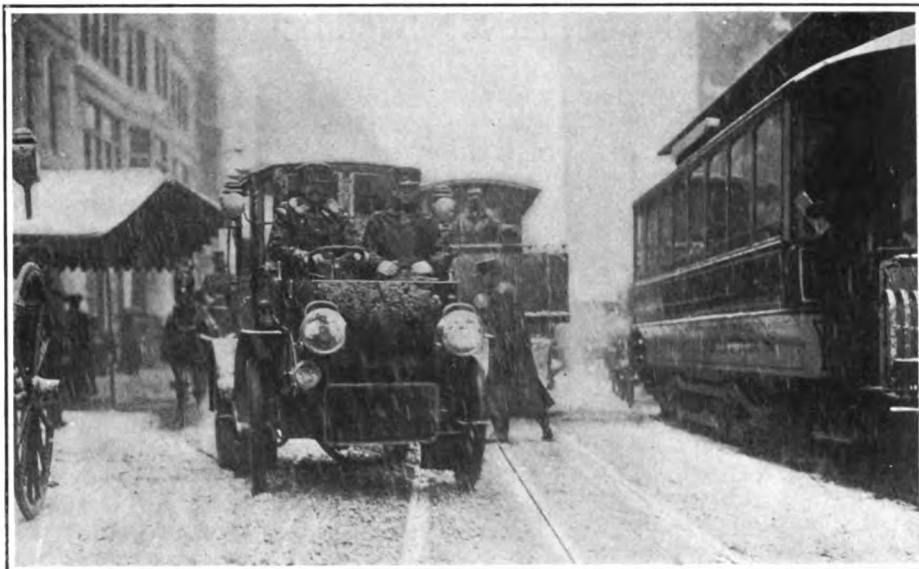

PRIVATE GASOLINE COUPE TAKING ITS OWNER FROM A RETAIL STORE DURING SNOWSTORM

Medical Corps while on service in the field, and as this purpose would be of the greatest of importance in times of war, the British War Office and the heads of the R. A. M. C. at once arranged for an inspection of this latest addition to the ranks of automobilism. The car was built by the Ivel Agricultural Motor Co., the motor itself being built for heavy work on the same lines as the agricultural motors turned out by this concern, and being capable of hauling not only a heavy service cart, but also a passenger load of nearly thirty persons. The car is protected by armor shields built of quarter-inch bullet-proof steel, and successfully resisted all attempts made to penetrate its wall in a recent trial at Bisley. The walls, however, can be folded together, while the ambulance motor, as it has been dubbed, is in motion, but on

their being spread out a large red cross appears on each shield, as a sign to friend and foe that the vehicle is used only for hospital purposes, bringing first aid to the wounded.

All the authorities have expressed their satisfaction with the car, which will probably be added to the service wagons of the Royal Army Medical Corps.

BRITISH 1905 RELIABILITY TRIALS.

At a recent meeting of the Industrial Committee of the Automobile Club of Great Britain and Ireland an outline of the coming reliability trials was given. It was at first suggested that they should be of a purely national character, open only to British-made cars, but this proposal was lost on the motion of Captain Deasy that the trials be open to all nations, but that cars of British manufacture be entered as such and so described in the program.

The classification will be by chassis price. The following classes were agreed upon: Class A, cars from £220 to under £300; Class B, £300 to under £400; Class C, £400 to under £500; Class D, £500 to under £650; Class E, £650 to under £800; Class F, £800 to under £1,000; Class G, £1,000 and upwards. Touring cars only are eligible, and no maker nor agent shall enter more than one car in any class. The distance is to be 2,000 miles and the horsepower is not limited.

The club executive committee has adopted the rules for the 1905 Gordon Bennett selection race, as prepared by the Race Committee, so the coming events are well under way in the various departments of that busy corporation.

"Jinx is awfully proud of that funny little motor car of his."

"Wonder why?"

"Oh, you can smell it a mile further off than any other make!"

—*Motoring Illustrated.*

Digitized by Google



DRIVER OF ELECTRIC CAB IN NEW YORK AWAITING SHOPPER IN MONDAY'S STORM.

Pedal and Lever Manipulation.

THERE is no better evidence of the expert driver than that perfect manipulation of the speed-change mechanism by which an even and quiet movement of the car is assured under all conditions, and the first efforts of the novice should be directed to this end. There may come a time, though even this is doubtful, when he will be justified in displaying his skill by sudden starting and other abrupt gyrations; but at the outset, and for some time after, his efforts are best concentrated upon the safe and certain handling of the mechanism without damage to gears, and to the avoidance of that disagreeable noise which gives public evidence of carelessness or lack of skill. An English exchange, *The Motor*, gives some plain instructions for the handling of the Panhard type of sliding gears which are applicable to the many cars thus fitted that are in use in this country.

The general arrangement of the cone clutch, the gear shafts and pinions, and the hand and foot levers, are presumably familiar from frequent descriptions and illustrations, and it will be assumed that the driver is seated in the car with the motor running and the clutch in, the change-speed lever being in the neutral notch of the quadrant. The gear wheels on the main shaft are now in motion, and any attempt to throw the hand lever forward is likely to result in the immediate grinding of the teeth of the live and dead gears as they come into contact; or, if this first maneuver prove successful and the gears actually mesh without damage, the car will be suddenly started with a strain which may badly damage the engine or transmission gears.

USE OF THE CLUTCH IN STARTING.

The first movement in starting is to depress the foot lever controlling the cone clutch, thus disconnecting the motor and the main shaft; when the latter is motionless, the hand lever may be released and thrown forward, thus engaging the gears of the main and the secondary shafts. Possibly the gears may fail to mesh, as shown by the stoppage of the hand lever before it reaches the first notch of the quadrant; in this case the safest thing for the novice is to raise the foot, thus allowing the engine to start the main shaft, then to depress the foot and throw out the engine, waiting a few seconds for the main shaft to come to rest, when the hand lever may be thrown forward. Should there follow a grating noise, it will show that the main shaft has not yet stopped, and the hand lever should be withdrawn. Should the lever still refuse to move when tried again, it will show that the gears are not yet in the meshing position. In such case the lever is kept in the neutral notch, the pedal is released gently to give a slight motion to the shaft, it is then depressed, and when the shaft has again stopped, a new trial is made.

The usual method in this case is more

rapid; if the gears fail to engage on the first attempt, the foot lever is slightly released, giving a slow movement to the main shaft, and as soon as this movement begins the hand lever is thrown on the chance that the gears may mesh. However justifiable this may be in the expert, it is likely to result in noise at the hands of the novice, and the more deliberate method is to be recommended until experience will warrant the other.

SLOW STARTING OF THE CAR.

The first step accomplished and the gears being thrown quietly and easily into mesh, there still remains the full starting of the car. After the lever has been moved the clutch must not be suddenly let in with a jerk and a bang, but the foot should be raised gently, so that the engine power is very, very slowly communicated to the rear wheels.

The "quick start" method is one of the little tricks of driving suitable only for getting off the mark in speed trials, and quite out of place upon the road. If adopted, its foolishness will be brought out quickly by the effects upon engine, gears, and tires. Letting in the clutch quickly with the car at a standstill may stop the engine, strip teeth off the gear wheels, or skid the rear wheels over the road before they can secure effective traction; and this last effect may be emphasized if the weight is not evenly distributed throughout the car, or if the road is muddy. It must never be forgotten that the whole power of the engine can be suddenly thrown upon the gear shafts by careless usage of the clutch, and it is solely to secure gradual application of force that the entering clutch member is leather covered. The strain is thereby gradually distributed over the whole mechanism without excessive pressure upon a single portion.

If we use the clutch to ease the strain gradually from engine to wheel rim, it will continue to do what is desired; let in the clutch suddenly and something may break. If the clutch is in good order, the slipping action provided by the leather face is a ready means of car control in traffic without the necessity of changing gear frequently; the jerking or banging use of the clutch will quickly remove this slipping property, and incautious users will find that the clutch will take up only a position of "right in" or "right out" without any intermediate point. Complaints are occasionally made of what is called a "fierce" clutch. In other words, the clutch will not slide or slip in, but permits the engine to get hold of it suddenly, and almost takes the starting control from the driver's hands. If the design is correct (there are one or two clutches on the market with incorrect angles which nothing will remedy), the trouble usually can be traced to a stone-hard clutch leather, which has been ruined by unskilful usage.

FROM FIRST TO SECOND SPEED.

We have eased in the clutch and started slowly off, but there need be no hurry to hasten in with the second speed. Allow the car to have good way upon it, say, by gradually advancing the ignition to half the limit the ignition lever permits, and now try to change up. The conditions are somewhat altered from the first point of standstill to movement; we have now to deal with a slowly-moving car, and we should endeavor to make it run at twice the speed without acquainting the whole neighborhood with the fact that the change is taking place.

The change must be made with certainty and at the first attempt. The proper meshing of the gears cannot be tried for, but they must be allowed to slide of their own accord, for when changing up, if the higher gear cannot be immediately attained, the car will lose its momentum, and when the second gear is eventually got in the extra work thereby put upon the engine will stop it. No great harm is done by this happening, but if in the midst of traffic, the proceedings are not of a dignified nature when the driver has to dismount suddenly, and turn the handle vigorously, being meanwhile the target of sarcastic remarks. To change the speed wheels to a higher gear, the clutch pedal must be depressed fully, so that the clutch is released entirely from the engine; when the clutch is right out, but not a fraction of a second before, move the lever quickly and surely from first speed notch to second speed notch and let the clutch in; the clutch movement may be very slightly accelerated beyond that advised for getting from neutral to first speed, but the movement must still be a gradual one until the clutch is fully home.

DIFFICULTIES OF SPEED CHANGING.

A part of the preceding sentence, "move the lever from first speed notch to second," is the stumbling-block to most men who find trouble in changing, combined with insufficient depression of the clutch pedal. After driving a car for some time the gear changing becomes as automatic as the steering of a bicycle, but at first many owners find it essential to look at the quadrant as the change is made, to be sure that the lever drops into the right notch. Some men never lose this habit of watching the quadrant, and night driving with them becomes almost a nightmare in hilly districts for fear of missing gear.

Now, nearly every change-speed lever is fitted with a spring clutch, which drops into one of the desired notches on the lever quadrant, and as a rule it is this catch which is the cause of part of the trouble. The driver, perhaps, clings tightly to the trigger after the lever has reached the side of the notch, and, letting in the clutch at the correct moment, the lever gets knocked back because the gear wheels do not mesh; or he lets go of the trigger but is uncertain whether the lever is against the notch or half-way between the two speeds. Anyway,

he trusts to luck, lets in the clutch, and we are treated to that delightful sound of grinding gear wheels with which we are all too familiar.

PROPER HANDLING OF THE TRIGGER.

There is an alternative to this haphazard method of gear changing, which prevents noise, ensures correct movement of the lever, and needs no watching of the quadrant. When the trigger is gripped (together with the lever), the time to let go is the moment the head of the catch tooth has passed the front edge of the notch; once released, do not touch it again. As the lever is pushed forward the tooth presses upon the face of the quadrant and quite naturally drops into the notch designed to receive it, stopping the lever in the correct position, without any muscular effort upon the driver's part or fear of passing the wished-for notch. Exactly the same use of the tooth and notch can be made for changing down or for getting in the reverse. This method depends entirely upon not letting go the trigger too early, as the lever starts to move, or the lever will be forced back into its original position. If carefully practised for a few minutes with the engine stopped, it will be found possible to depend entirely upon the sense of touch. The changes thus made should be tried with every gear in turn; at first it will be necessary to watch the quadrant to find the exact moment the lever has passed the old notch and is making for the new, so as to drop the tooth upon the quadrant face. Some drivers will find that it suits them better to drop the tooth midway between notches; in this respect the personal equation comes into action.

SPEED CHANGES ON HILLS.

For changing down speeds on a hill, the lever movement will, of course, be carried out upon a similar method; but for hill work the clutch must be taken out sharply by the foot, and as the foot gets the pedal down to its limit of travel the hand is pre-

pared to pull the lever back quickly to get into the lower speed when the clutch can be let go.

Working the clutch uphill requires somewhat different treatment from work upon the level, for the speed of the car is diminishing by reason of the resistance offered by the gradient, and, therefore, the clutch must be released quickly, the change-speed lever moved quickly, and the clutch again let in quickly, but without a symptom of jerkiness or harsh movement. If the speed gets slow uphill, the change must be made with rapidity, and, perhaps, jerkily, when the engine labors and "knocks," or the car will come to a standstill; this can always be obviated by changing gear before the engine reaches that stage of weariness.

In changing gear remember the golden rule whether on the level, uphill, or reversing: *Always*, without any exception, entirely disengage the clutch before attempting a change.

Oiled Roads in Scotland.

During the past summer the western section of the Scottish Automobile Club conducted experiments in the prevention of dust on roads by the use of westrumite and crude oil, writes Rufus Fleming, American Consul at Edinburgh.

Two stretches of roadway were selected, about half a mile in each place being treated, in which the metaling was in three stages of wear. Half a ton of westrumite was used in each case. Previous to the first application the road was cleaned and swept, then a 10 per cent. solution was applied by means of ordinary watering carts. Three days later another 10 per cent. solution was applied, but within a few hours of the second application a torrential rain, which washed away a considerable portion of the mixture, fell over the district; consequently a third 10 per cent. mixture was applied, instead of two successive applications of 5 per cent., as was originally intended.

Crude oil was used over a stretch of road comprising metaling at two stages of wear. The road surface was swept clean and the oil poured on by means of cans, and brushed over so as to saturate the surface uniformly.

In a report on the results, the secretary of the club says, in substance:

In about twelve hours after the application the road surface was dry enough in each case to take the traffic, and not a single complaint of damage done to the tires or paint of any vehicle thereby has been made. In the case of westrumite, for several weeks there was absolutely no dust raised by vehicles of any description passing over the road, and even three months afterwards there was but little dust. On the older portions, where the metal is much worn, the tendency to dust is greater than elsewhere. As to the crude-oil experiment, the results obtained from the different stages of wear of road surface are not so noticeable. This material is most effective, but for the first week or ten days after its application, especially if wet weather prevails, it is not so clean as the westrumite; neither is it so easily applied nor so clean to handle. There is one point in its favor—one application suffices for a season. With the westrumite several applications are necessary, at intervals varying according to the nature of the weather and the condition of the road.

The experiments have been so far successful, and have demonstrated the efficiency of the materials used for the purposes of dust prevention. The cost to the club has been approximately \$100 per mile, which may be accepted as a fair average of the cost of this method of road dressing. For long stretches of road in the country the cost of the application might make its general use prohibitive, but in villages or populous places or residential districts the complete absence of dust in dry weather would be appreciated, and would be well worth the expenditure required.



DESIGN FOR VINCENZO FLORIO SILVER TROPHY OFFERED FOR ITALIAN GORDON BENNETT RACE.

This is a new challenge trophy, offered by the Italian sportsman, Vincenzo Florio, to be competed for in seven consecutive years, in Northern Italy, by cars weighing less than 2,204 pounds. The races are to be run over a distance of from 497 to 621 miles, and must always be run in Italy. A *fac simile* in miniature of the trophy is to be awarded each year to the owner of the winning car, and the original will be presented at the end of the seven years to the makers of the cars that have won the largest number of the annual contests. Rules for the Brescia race will follow in general those for the Gordon Bennett cup contest. The races are to be run during "Brescia Week," also known as the "Brescia Circuit," about the end of August.

A Theoretical Investigation into the Possibilities of the Gas Turbine.

UNDER the above title, a paper of considerable interest and suggestiveness was read before the last meeting of the Institution of Mechanical Engineers, in London, by R. M. Neilson. It was purely a theoretical paper, in which the ideal efficiencies of different cycles were investigated, with a view to indicating in what directions the greatest promise of success seems to lie. To this end a number of hypothetical cases were considered, and ideal diagrams worked out from the data assumed.

Four cycles were examined, the first two being those designated by Dugald Clerk types 2 and 3, here called, respectively, Cycles 1 and 2. Cycle 1 is the combustion-at-constant-pressure cycle used in the Brayton engine. In this, as in all the cycles, the investigation is based on an assumed weight of gas being first compressed more or less, then heated more or less, either with or without expansion, then expanded beyond the original volume to atmospheric pressure, and finally cooled and compressed at atmospheric pressure to the original volume. This, of course, does not represent the actual processes in a gas engine in which successive weights of gas are taken, but it is the most convenient method for theoretical investigation. In all the examples taken, the specific heats are supposed to be constant at all temperatures as pressures, being 0.238 at constant pressure, and 0.17 at constant volume. It is assumed also that the weight per cubic foot of gases is 0.777 pounds at a pressure of 15 pounds per square inch absolute, and a temperature of 17 degrees C. The product of pressure and volume is supposed to be constant for isothermal expansion and compression, and to be constant with all pressures and temperatures. All the curves are true isothermal and adiabatic. It is pointed out that the ideal efficiency of an engine work-

ing on Cycle 1 is equal to $\frac{T-t}{T}$, where

T is the temperature at the end of combustion, and t the temperature at the end of adiabatic expansion.

It is assumed that a turbine of the Parsons type, with steel blades, could not stand a temperature in excess of 700 degrees C. Without some water-cooling device, and this temperature, or 973 degrees absolute, is made the limit in several of the assumed cases.

Starting with these premises and with an initial temperature of 17 degrees C. (290 degrees absolute), and a corresponding pressure of 15 pounds absolute, a trial is made of compressing to 42 pounds absolute, producing a temperature of 389 degrees absolute. Heat is now supplied, and the gas expanded at constant pressure, till the temperature is 973 degrees absolute, the allow-

able maximum. Gas is expanded without further addition of heat to 15 pounds absolute, and the ideal efficiency is found to be 0.25. The negative work represented by the compression curve is 0.4 of the gross

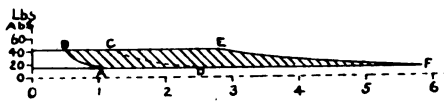

FIGURE 1.

work done. It is pointed out that in a turbine there is little difficulty in carrying the expansion line down to atmosphere, although that would be impracticable in a reciprocating engine.

Although water cooling would be out of

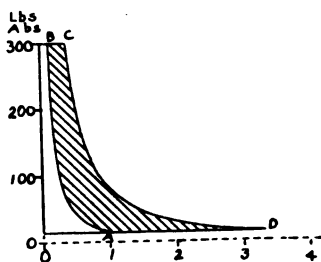

FIGURE 2.

the question in practice for a turbine, the author assumes cases in which the temperature is carried to 2,000 degrees C. (2,273 degrees absolute) for a purpose which will later appear. Compressing the gas to the same pressure as before, and

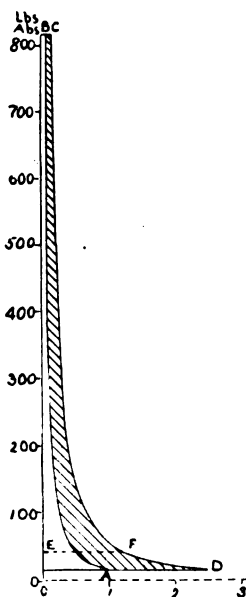

FIGURE 3.

continuing the application of heat till 2,273 degrees absolute is reached, the curve shown in Fig. 1 is obtained, in which the dotted line $C D$ shows the expansion curve in the first case assumed. The ideal efficiency with this engine is 0.25, as before,

the amount of heat applied making no difference in this respect, but the negative work is now only 0.171 of the gross work.

With the higher maximum temperature it is practicable to use a much higher compression than first assumed. If the compression be made 300 pounds absolute, the curve obtained in Fig. 2 is obtained, with a maximum temperature of 2,273 degrees at C. The ideal efficiency is now 0.58, and the ratio of negative to gross work 0.3. The temperature at the end of compression is 682.5 degrees absolute, or a little less than one-third the maximum. In other words, this curve is about what might be produced by a medium quality of gas heated by its own combustion. In this respect it differs from the preceding case, where the amount of heat supplied is greater than would be produced by the combustion of the gas itself.

If the compression in Fig. 2 be carried to such a point that the ratio of negative to gross work be 0.4, as in the first case assumed, we get Fig. 3, in which the ideal efficiency is 0.68. Although this shows much the higher efficiency, it is evidently impracticable on account of the excessive pressures employed, even were the negative work less.

The author now supposed that, instead of discharging the hot gases directly into a turbine of the Parsons type, they be directed through suitable divergent nozzles against the vanes of a turbine of the De Laval type. By doing this the gases may be cooled by their own expansion, so that no water cooling is necessary, even with a maximum temperature of 2,000 degrees.

If the case represented in Fig. 2 be taken and the gas allowed to expand adiabatically in a suitable nozzle to atmosphere, it will have at the end of expansion a temperature of 966 degrees absolute, which is just within the permissible limit. As the energy represented by its pressure is now converted into kinetic energy, a theoretical calculation shows the velocity to be 5,290 feet per second at the mouth of the nozzle. This is about 900 feet per second in excess of the theoretical velocity of saturated steam at 300 pounds absolute pressure, and of course, both are considerably in excess of the velocities which would be obtained in practice, owing to the friction in the nozzles and to the resistance of the surrounding air or gases. No such vane speed as would be indicated by these theoretical figures would be possible in practice, as the resulting centrifugal force would burst any wheel that could be made.

If the gas be compressed as in Fig. 3, and expanded in a divergent nozzle, it will reach 973 degrees absolute, with a pressure of 42 pounds absolute, so that 27 pounds can be dropped in the turbine. The theoretical velocity will then be 5,280 feet per second.

The sources of loss with any of the foregoing cycles will be as follows: Radiation and conduction, fluid friction, friction in bearings, and loss due to incomplete ex-

pansion. The first loss will be larger than with steam, but less than with reciprocating gas engines, owing to the higher velocities and higher permissible temperatures. The second loss will be considerable, but much less than in turbines using anything but highly superheated steam. The third and fourth losses should be small. Another source of loss, however, which may be very considerable, is the friction of the compressing pump. On account of high pressures, it is evident that reciprocating air compressors would be very inefficient unless compounded. Largely for this reason it is important to keep down as much as possible the ratio of negative to gross work, the need for this being illustrated by an extreme case. Suppose that the ratio of negative to gross work in an ideal engine is 0.5; that is, that the pump requires one-half the gross power of the machine, there being no friction. If now the machine is not ideal, and if the mechanical efficiency of the pump is only 2-3, and that of the motor proper only 3-4, no useful work whatever will be got out of the machine, the whole being absorbed in friction. For example, if the total power of the motor is 100, and the pump requires 50, the pump will take 75 if its efficiency is 2-3. This is exactly what the motor will give out after deducting friction, and therefore there will be no external work done.

Two cases are assumed of engines working on the modified Otto cycle, here called Cycle 2. In the first case, an ideal efficiency of 0.55 is realized, with compression to 101 pounds absolute, and an increase of temperature to 2,273 degrees absolute, raising the pressure to 459 pounds absolute. In the second case an efficiency of 0.68 is obtained, with compression to 417 pounds absolute, and an explosion pressure of 1,265 pounds. In both cases expansion is continued to atmospheric pressure.

The third cycle involves absorption in a water-jacket of a portion of the heat generated, and the conversion of this water into steam, partly by boiling and partly by heating of the waste products of combustion. This steam is then discharged, either with the burnt gases through a common nozzle, or simultaneously through a separate nozzle, and an analysis is made of the efficiency thereby obtained. It is shown that with pressure of 300 pounds (the Brayton cycle being used), the steam being generated at 300 pounds absolute and superheated to 700 degrees C., the combined efficiency is only 0.33, as compared with 0.58 for Fig. 2. Various methods of accomplishing this process are discussed, and the possibility is considered of expanding below the atmospheric line by condensing the steam, simply using a vacuum pump. Evidently a very large vacuum pump would be necessary; but, on the other hand, experiments seem to have shown that there is a great loss in the velocity of gas and steam jets from nozzles, when they have constantly to push away the surrounding air. As to whether the advantage

gained by condensing would be worth the cost, the author expresses an opinion.

In Cycle 4 the author presents a novel system of his own contriving, in which a very low compression is used, and the compressed gas heated by passing through a regenerator before fresh heat is supplied. The regenerator is kept hot by the exhaust gases, and the theoretical merit of the cycle is that it combines high ideal efficiency with low ratio of negative to gross work. Its disadvantage is that much heat will be wasted in the regenerator, and that the latter, which would have to be of fire brick, on account of the high temperature at which the gases exhaust, would generally be awkward to install. It is pointed out, however, that regeneration would be practicable with Cycle 1, and, as the temperatures dealt with are there much lower, the regenerator could take the form of simple iron exhaust pipes, around which the compressed charge would pass before ignition.

The author concludes by pointing out that for small units, in which the gas turbine might replace the electric motor, simplicity and low first cost are of more consequence than a high degree of economy, and for this class of work he suggests that Cycle 1, using a low compression, would be the most suitable. For authoritative opinion regarding relative efficiencies in larger motors, he points out that further knowledge is first necessary regarding radiation losses and transference to high pressures, regarding the expansion of hot gases in divergent nozzles, and regarding radiation losses and transference of heat from gases to metal at high temperatures.

The Bates Muffler.

A muffler devised with a view to reducing the volume of the exhaust gases as much as possible, by cooling before discharging them, is soon to be put on the market, and is shown in the accompanying illustration. The object of cooling the gases is of course to reduce their volume and thereby to reduce the necessity for obstructing their flow.

The muffler is cylindrical in form, and is placed lengthwise of the car, the left end in the engraving being the front end of the muffler. The gases may enter at either or both ends, and a cut-out may be placed at

the unused end. The central chamber *A*, which the gases enter first, is several times the volume of the engine cylinder and therefore gives the gases a chance to expand. The holes *B B* are likewise at least equal in total area to the cross-section of the exhaust pipe, and on passing through them the gases are still further expanded in the outer chamber *C*. Through this chamber pass several flues, *D*, open at both ends for the air to pass through freely. The exhaust gases enter these flues by the short pipes *E E*, which are directed backward into the tubes so that the issuing gases assist the motion of the vehicle in drawing cold air through the flues.

The cooling and condensation of the gases take place partly by convection through the walls of the flues and partly by the mixing of the air and gases in the latter. The muffler as shown is made with cast-iron heads and galvanized iron shells, and is surrounded by a jacket filled with asbestos fiber to deaden the noise. Necessarily this sacrifices a good deal of cooling effect, and it would seem that aluminum without the asbestos jacket might be preferable owing to the small resonance of that metal.

The muffler is made by F. E. Bates & Co., of Northfield, Minn.

FERRYBOAT TEST CASE TRIED.

Gasoline automobiles are sources of danger on ferryboats, according to the testimony of Professor F. R. Hutton, of Columbia University, New York, and Professor Jacobus, of the Stevens Institute of Technology, witnesses for the Government in the case of "the United States vs. the steam ferryboat *Texas*," tried before Judge Adams in the United States District Court, New York City, on December 14.

The case was instituted as a test of the Federal law regarding the carrying of automobiles on ferryboats, which is interpreted by the steamboat inspectors in such a way as to bar gasoline and steam automobiles from entering and leaving ferryboats under their own power. The witnesses explained the action of the carbureter and showed how muffler explosions might occur, on starting the motor, from gas forced into the muffler by shutting off the ignition current to stop the motor.

Assistant United States District Attorney E. E. Baldwin, acting for the Government, rested his case when this testimony had been given, and counsel for the defence did not attempt to enter contradictory evidence. Both sides were given two weeks to prepare briefs, Judge Adams reserving his decision. A number of automobilists were present at the trial and followed the case with interest.

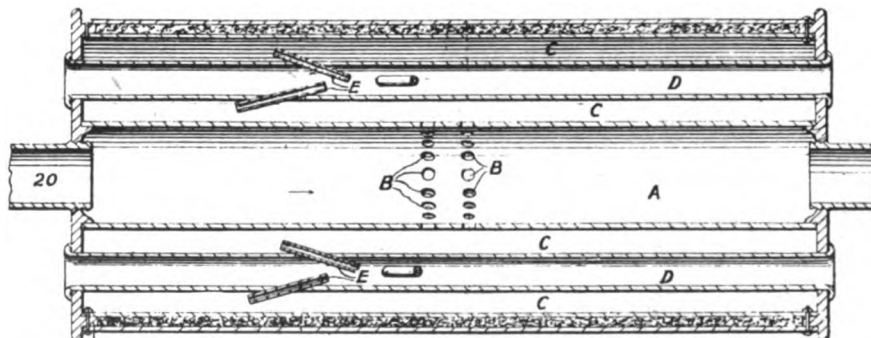

MUFFLER DESIGNED TO REDUCE VOLUME OF GASES BY COOLING BEFORE DISCHARGING.

Shock Absorbing Change Gear.

The technical defect of the sliding gear system of changing speeds is, as is well known, the severe shocks imposed on the gears when shifting from one speed to another. On account of these shocks, the gears have to be made of much more costly material than would be necessary were the regular driving stresses the only ones encountered, and the clutch cone and other parts connected to them have to be lightened beyond what would otherwise be required. The drawback is practical as well as technical, since it reduces the availability of the sliding gear system for runabouts, in which speed changes would be frequent, and it adds to the skill and dexterity needed for operation. Even the most experienced driver sometimes finds it a little awkward, in a tight place in traffic, to adjust his motor speed just right for the most successful shift. The sliding gear train has won its popularity in spite of this feature, by reason of its high efficiency and light weight, and if its cost could be lowered and the danger of stripping the gears eliminated, it is not improbable that it would soon be used, to the practical exclusion of all other change speed gears.

Such a non-stripping device would most naturally take the form of a shock absorber of some sort, which would relieve the engaging gear teeth of the duty of accelerating or retarding the clutch shaft to suit the newly-meshed pair of gears. Unfortunately, none of the few contrivances

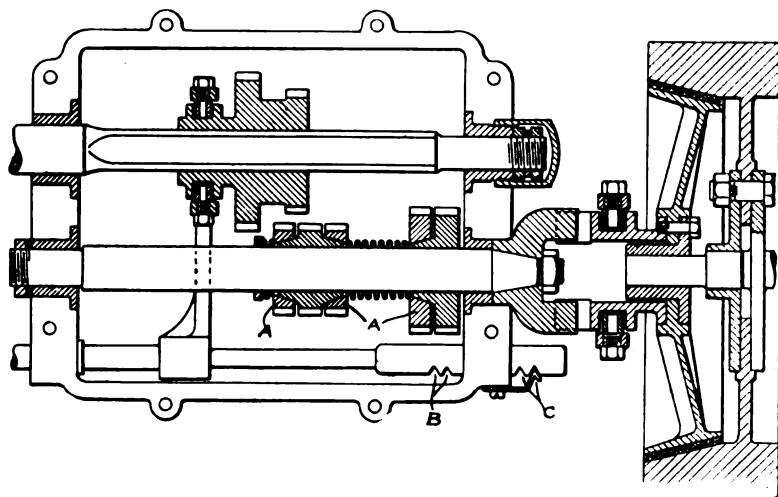

CHANGE-SPEED MECHANISM WITH SLIPPING GEARS TO ABSORB SHOCKS.

yet put forward has shown itself to be a conspicuously apt solution of the problem, though we recall a foreign device for halving the usual shock by means of a claw clutch connecting the driven gear shaft with the final drive. By releasing this clutch at the same time as the flywheel clutch, both gear shafts are free to turn.

A device which has not been marketed, but which is at least sufficiently practical to stimulate interest in the subject, has lately been patented by S. W. Rushmore, of Plainfield, N. J. Its principle is shown

in the accompanying engraving. It consists essentially in attaching to each of the gears which it is desired to protect one or two—as the case may be—"buffer gears" *AA*, which are loose on the shaft, but frictionally connected to the driving gear by a stiff spring clutch, preferably of conical form to save bulk. On changing speed, engagement is first made with the buffer gear, which slips and accelerates or retards the driving gear by friction. It is proposed to put deep position notches *BB*, *CC*, in the shifting bar or quadrant, which will be en-

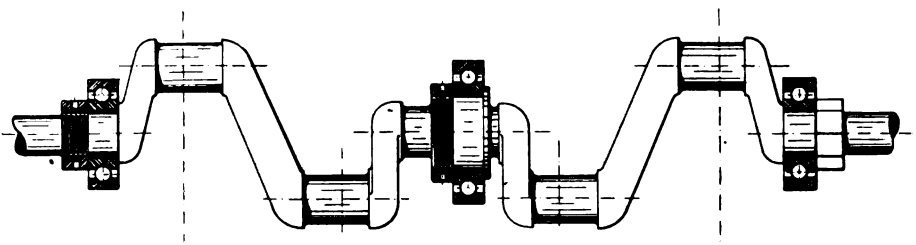

BALL-BEARING CRANKSHAFT ON NEW MERCEDES ENGINE AT PARIS SHOW.

gaged by roller arms with heavy springs, so that shifting can only be done by a series of jerks, like a street car controller, instead of gradually, as at present. Then a quick shift is made to the buffer gear—first notch—by a sudden push, and by the time the operator has steadied himself for a second push—to the driving gear—that gear has been accelerated and goes easily into mesh.

Obviously not all the gears need this sort of protection, and it would be applied

Ball-Bearing Crankshaft in New Mercedes Cars.

Special Correspondence.

BERLIN, Dec. 1.—The success of the ball bearings used in the wheels, change-speed gear and other parts of the Mercedes car, as shown in the diminished friction and the wonderful rapidity of starting, has led to the use of ball bearings for the crankshaft, as will be seen at the coming Paris show.

The noted chief engineer of the Daimler works, Mr. Mayback, has worked for some time over the difficult problem of constructing a ball bearing that would withstand the shocks of the explosions as transmitted by the connecting rod, and only recently has he achieved a successful solution by means of springs introduced between the balls. Where other methods of ball-bearing construction have failed in a few months at most, through the many strains to which they are subjected, and in particular through the shock of the explosion, these retain their perfect condition indefinitely.

The details of construction are shown in the accompanying diagram. The outer bearings are secured by nuts on the threaded projections of the seats for the ball race. The center bearing seat is made of such a size that both ball race and nut may be passed over the webs of the cranks from the left end.

The arrangement has many advantages; the length of the motor is reduced and the mechanical efficiency is increased; especially when the motor is run at low speeds, the loss due to friction being much higher in proportion at low than at full speed; the wear on the main bearings is greatly lessened; the consumption of lubricating oil is decreased, and no harm results if the bearings should accidentally run dry.

Redolence that Suggests Tact.

By a scant decade, I do ween,
When a man smelt of stale gasoline;
You might have been sure
That the fellow was poor
And his duds had attempted to clean.

Now time quite a change doth reveal—
Your way you must cautiously feel;
You never can tell,
For that gasoline smell
May have come from his automobile.

—*Courier-Journal, Louisville.*

only to those—generally the intermediates—getting the hardest usage.

"I think I'll try filling the tires of my automobile with illuminating gas," said the amateur chauffeur.

"Good joke," gurgled his fool friend.
"Expect to make it light. Ha, ha!"

"Nothing of the kind," rejoined the amateur. "I thought it might increase the speed of the machine. Just think how the stuff makes the wheels of a gas-meter spin around.—*Columbus Dispatch.*

Features of Wolseley Racer.

Several innovations in European design and construction are embodied in the Wolseley racing car of 96-horsepower, illustrated herewith, which ran second in the British Gordon Bennett elimination trials last May, and, driven by Sidney Girling, took seventh place in the race itself. It is interesting to note that this machine, built in Europe where the vertical motor in front is, as a rule, considered the only effective arrangement, has four horizontal cylinders below the top level of the frame—an arrangement that has become known as the "American type," owing to its wide and successful use in American runabouts and touring cars. Another peculiarity of the Wolseley racer is the location of the radiator in a position back of the front axle, where it is protected against injury by contact with vehicles ahead.

The motor is of the type used in the regular stock Wolseley cars, and has cylinders of 6 inches bore and 61-2 inches stroke. Four forward speeds are provided by the transmission gear, and are theoretically twenty-five, forty-two, fifty-seven and seventy-three miles an hour. A reverse is, of course, fitted. Power transmission is by chain, a Renold silent chain running from the motor shaft to the gear box, and side chains from the countershaft to the rear wheels, which run on a "dead" rear axle. An enormous flywheel is used for the purpose of causing the car to accelerate its speed rapidly.

Strength in resisting lateral strains is imparted to the wheels by auxiliary spokes of steel wire. Ball bearings are used throughout the gear box and in the road wheels, and balls are also used in an external crankshaft bearing. All braking is done on drums on the rear wheel hubs.

Wired tubing, one-quarter inch in diameter, forms the radiator, a large number of tubes being used, and a fan being placed behind the radiator. Circulation is maintained by a rotary pump driven by a telescopic and universally jointed shaft. A single carbureter supplies gas for all four

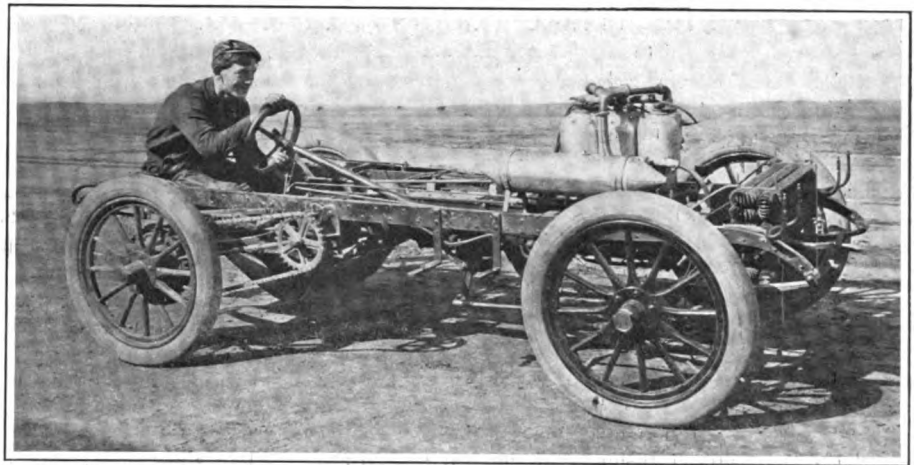

Stripping of a large touring car for racing is rarely carried to the extreme degree shown in the photograph reproduced above of the Thomas Flyer, which "made the running" at the Los Angeles, Cal., races in October. With this 24-horsepower, three-cylinder car, Frank Siefert, who is shown at the wheel, won the five-mile open, the Australian pursuit race and the ten-mile open for 24-horsepower cars. The Western Motor Car Company, of Los Angeles, which owned the car, not only removed the entire body, but changed the angle and length of the steering post, placed the driver's seat directly over the rear axle and on a level with the main frame, to lower the center of gravity, and provided a tank pointed at both ends and longitudinally disposed to reduce the air resistance. These changes gave the car an aspect greatly resembling the Ford and Premier light special racers of this year.

cylinders. The spark plugs are of large size, and there is a spark gap on each high tension lead. Cut-out switches for testing purposes are fitted to the low tension wires. The car has a wheel base of 108 inches, while the tread is 55 inches. The rear wheels are 36 inches in diameter with 5-inch tires, and the front wheels are 34 inches in diameter with 3 1-2-inch tires.

A sister to this car was driven by Charles Jarrott in the British Gordon Bennett elimination trials, taking third place, and in the race in Germany, in which it finished twelfth.

AUTOMOBILES IN QUEBEC.

Replying to a letter from an American interested in automobiles, who wishes to know the prospect of making sales of American automobiles and auto boats in

Quebec, Canada, Consul W. H. Henry writes to the State Department:

"I have seen, as yet, only four automobiles in this city of 70,000 inhabitants. There must be a market for a great many more. If the motor for boats is any improvement on the present gasoline motors, I am sure there must be an opening for the sale of a great many of them among the large number of fishermen who have fishing rights on the numerous lakes and rivers in this vicinity. If some manufacturer would come here and attach his motor on a boat and demonstrate that it is better than any other, I am sure he would be able to make good sales."

The Automobile Club of France is arranging for an automobile straightaway speed contest to be held in March, 1905, on the Croisset Road, near Rouen, where a straight road about two miles in length is available.

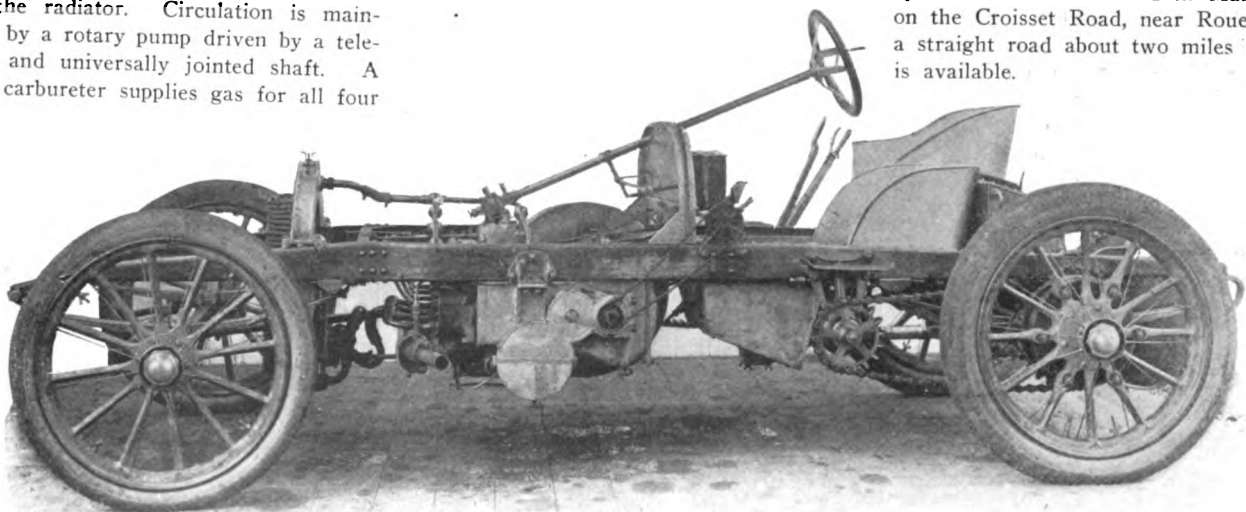

The Knox Models for 1905.

ONLY a few minor changes are made in the chassis of the new Knox pleasure vehicles for the coming season, but the body styles have been changed and improved, without, however, losing the individuality that has characterized the product of the Springfield factory heretofore. Three distinct styles will be manufactured—a run-about or stanhope, with single cylinder air-cooled engine, a folding back surrey, with two-cylinder opposed engine, and a side entrance touring car with a two-cylinder opposed motor.

In all styles of pleasure and commercial vehicles the company will use its standard air-cooled motor, mounted underneath the body, planetary transmission, and single chain drive to live rear axle. Several improvements have, however, been made in the

the body frame, are in effect a unit and cannot get out of alignment, regardless of the twisting movements of the running gear. This construction also permits the use of a lighter body frame.

The crankshaft in the double opposed engine has been shortened by placing the cylinders more nearly opposite each other and offsetting the crank-pin connection, thus bringing the main bearings closer together. The cylinders have 5-inch bore, as in the 1904 models, but the stroke has been shortened from seven inches to six inches. Three single piston rings are used, each having a peripheral groove to carry oil, instead of three sets of double independent rings, as formerly. The main shaft bearings are 2 1-2 inches in diameter by 4 1-16 inches long, and the crank-pins are 2 1-4 inches diameter by

The lubrication system has been changed to a sight-feed oiler on the dash, with capacity for sufficient oil for a run of 150 miles. After the oil passes the sight feeds by gravity it is forced to the main bearings, the cylinders and the crank-pins. Only one grease cup is employed, and it is on the planetary gearing, one oiling of which should suffice for a day's run. The differential gearing is packed in grease, which should not need renewing more than once a season.

All of the new cars are hung from one to one and a half inches lower than last season, but still give eleven inches road clearance.

The new side entrance touring car, shown in the large engraving herewith, has a 90-inch wheel-base and standard tread. The wheels are thirty inches in diameter and are fitted with 4-inch tires. The car has an extended hood front twenty-seven inches

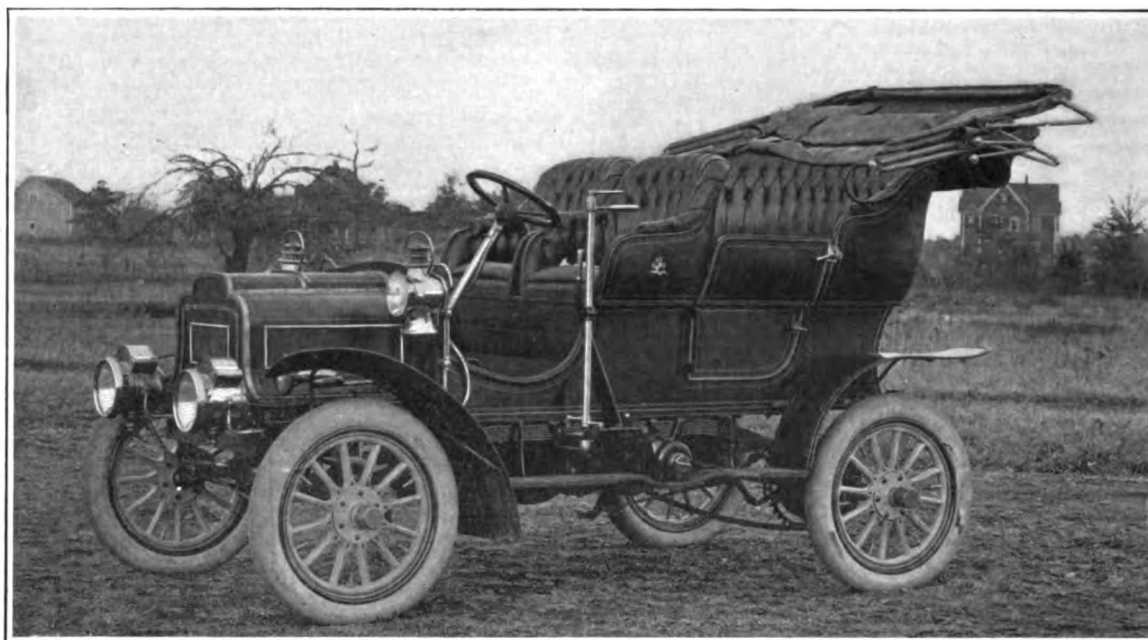

NEW KNOX SIDE ENTRANCE TOURING CAR, WITH TWO-CYLINDER, AIR-COOLED MOTOR AND BONNET FRONT.

engine and in the method of suspension in the chassis. A novel feature is the arrangement permitting removal of the transmission and access to the motor itself from the side of the car, without the necessity either of removing the body or of crawling beneath the vehicle. The motor and planetary change-speed gearing, which have a common shaft, are carried on a small, separate frame of angle steel that is pivoted on the engine side to the left side of the body frame, and on the transmission side is clamped to the right side of the body frame in such a way that the transmission side can be loosened readily and lowered part way to the floor. The engine and change-speed then incline at an angle and are in the most convenient position for examination from the side of the vehicle.

The engine and transmission, being disposed side by side on the same shaft and carried in a frame virtually independent of

2 1-2 inches long. The fly-wheel is lighter, being cast open, with fan spokes to draw the air away from the motor and establish a lateral circulation of air among the cooling pins. Cooling is further assisted by fans at the ends of the cylinders driven by belts running over pulleys on the time shaft, which is mounted longitudinally and is driven by a spiral gear from the engine shaft. The time shaft drives the make-and-break device, which is used instead of a commutator, and has cams that actuate the exhaust valves. The friction of this shaft has been reduced to a minimum by mounting it on adjustable ball bearings. The spiral gear is enclosed in the crank case. There is an improved adjustment between the rocker and exhaust valve stem. The carbureter has been provided with an automatic air inlet above the spray nozzle, and the automatic inlet valve has been changed to the top of the cylinder.

long and seventeen inches high, affording two compartments. In the front compartment, which is the more accessible, are carried the batteries and spark coil, two sets of four No. 6 dry cells being used. The steering is either by wheel or side lever, as desired. The side steering cars are fitted with the Lemp steering check, making the steering irreversible. Steering and control of the car is from the left divided front seat.

The rear portion of the body is roomy, and is entered from the side through a nineteen-inch door that is hinged at the front. Should the door be insecurely latched, it will tend to close itself, instead of swinging back when the car starts and bend or break the hinges. The rear seat is fifty-nine inches wide. When desired, this car is fitted with an extended double seat Cape cart top and glass front. The same chassis will carry equally well a full limousine body.

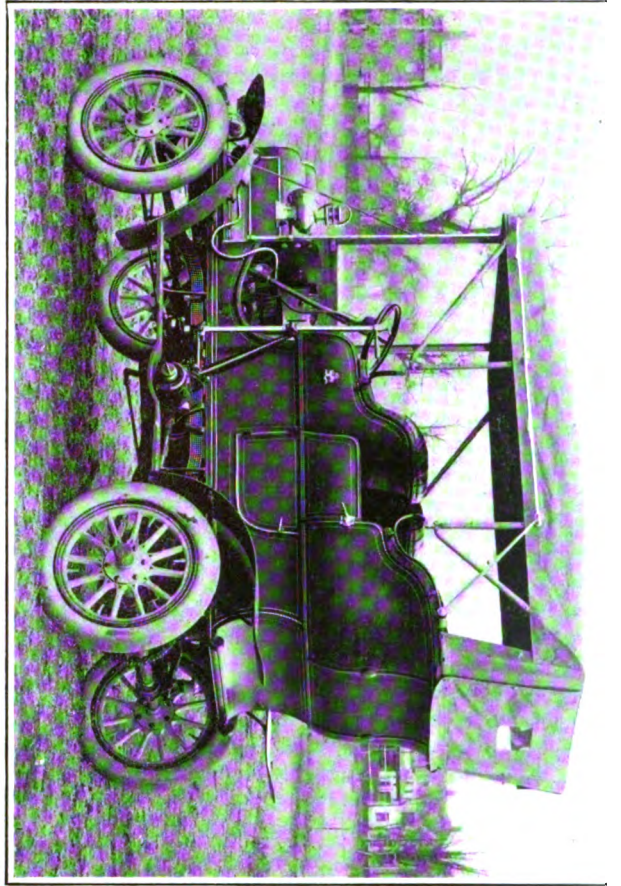

Knox 1905 Touring Car with Extension Cape and Hood Raised.

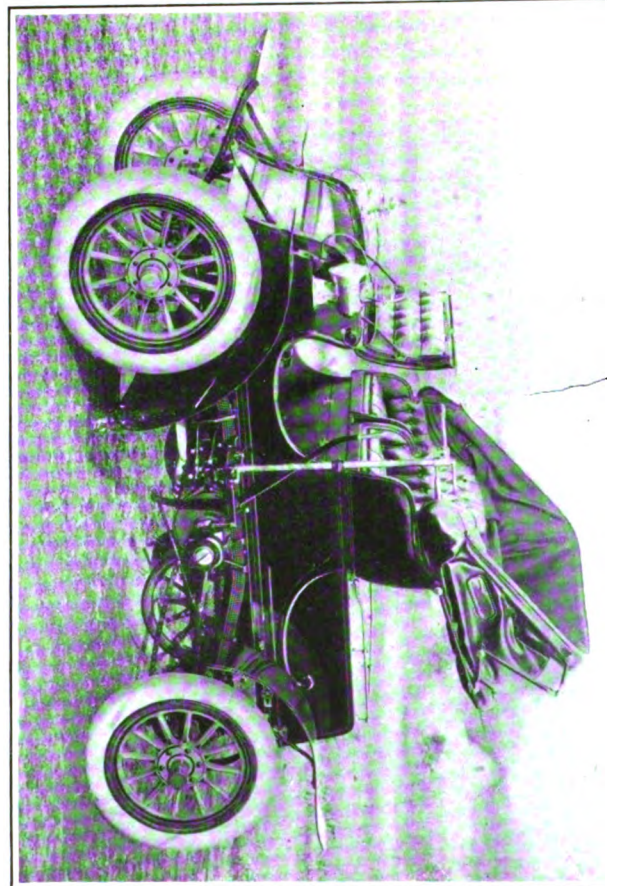

Runabout Model with Folding Front Seat Opened.

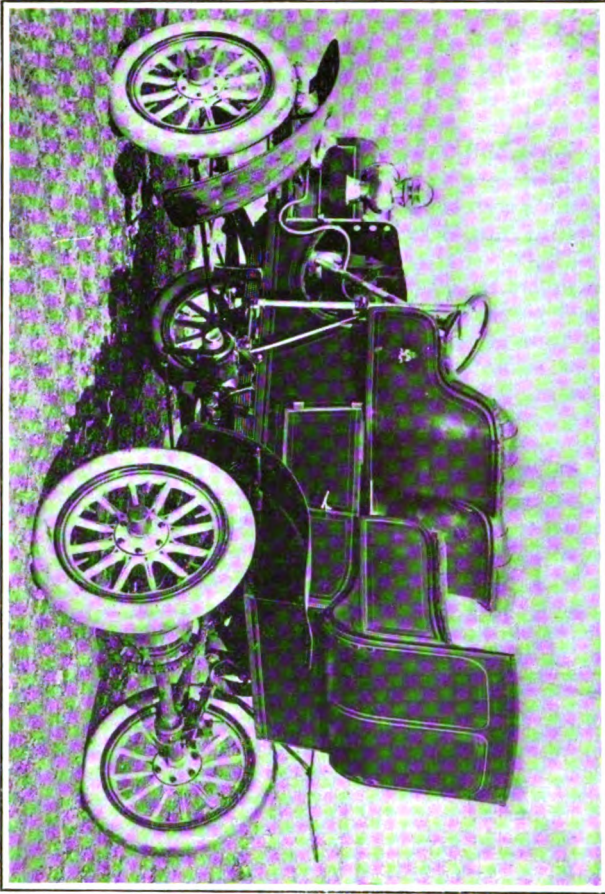

New Surrey Showing Folding Rear Seat Opened for Use.

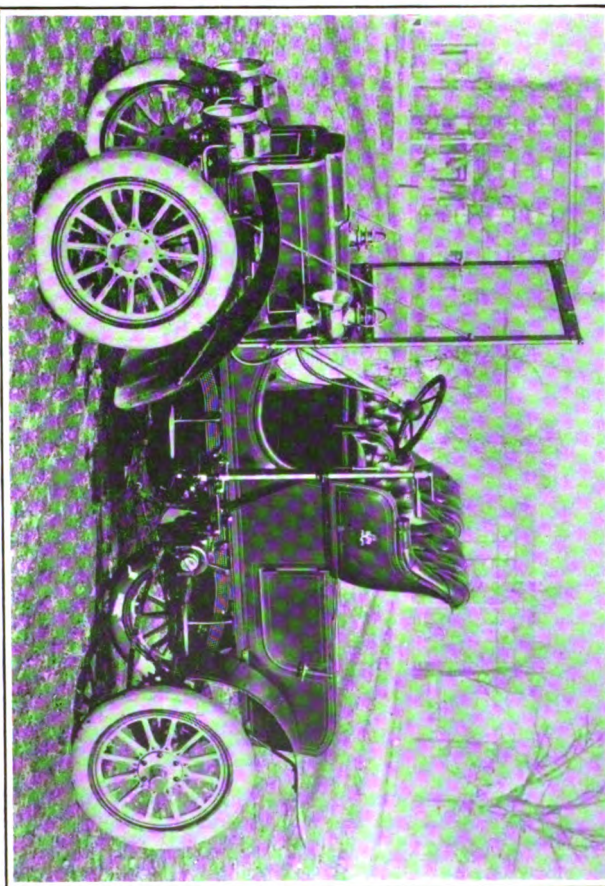

Surrey Showing Rear Seat Closed and Front Glass Fitted.

INTERESTING MODELS OF KNOX CARS FOR THE SEASON OF 1905, DESIGNED TO MEET REQUIREMENTS FOR A VARIETY OF USES AND IN ALL KINDS OF WEATHER.

Details of the New Winton Cars.

The space under the rear seat affords ample storage room for luggage and spares when touring.

The Knox surrey for four passengers, shown on the preceding page, presents interesting features in a car put out as a regular model. It is designed as a convertible vehicle peculiarly adaptable as a car for short pleasure rides for four passengers, or as a touring car for two, with generous storage room for luggage in the rear portion. In other respects similar to the touring car, the body of this vehicle has a folding rear seat, with high and comfortable back. When used by only one or two persons, the side panels, with arms attached, are removed from the rear seat and the back of the seat folded down, its top edge meeting and making a close fit with a hinged piece attached to the back of the front seat. Thus is formed a water-tight luggage compartment with doors on both sides. The wheel-base of this model is 87 inches and the tread 56 inches. The car is provided with a front glass and with a stanhope or victoria top for doctor's use when desired.

The single-cylinder runabout or stanhope is generally similar to the model of 1904, except that the wheel-base has been lengthened eleven inches, to 81 inches, and the body is made with a detachable rear portion. This part is made to slide backward for removal, leaving a flat platform, suitable for carrying a sample trunk, suit cases or boxes. The boards of the platform are removable, to give ready access to the engine and transmission. The top of the rear body portion is made watertight. The folding front seat that has been a feature of the light Knox cars heretofore is retained, but the main seat is of the individual or divided type.

"Jerrold wants to sell his auto."
"Indeed? Which of them is 'broke'?"
—Judge.

ACCESSIBILITY is the keynote of the vertical four-cylinder motors that so prominently differentiate the four models for 1905 from all previous models of the Winton Motor Carriage Company of Cleveland. The four new models are alike in their general features, which were outlined in the November 12 issue of THE AUTOMOBILE.

The engine is designed so that the crankshaft, connecting rods and pistons can be detached, taken out and returned without getting under the car or separating the cylinders from the crankcase. The aluminum crankcase is split vertically, one side being easily detachable. On this side are two openings, through either of which inspection may be made by turning a hand screw and lifting the cover. If it is desired to remove the working parts of the motor, the entire side of the crankcase may be detached by removing the bolts that hold it in place. To emphasize the fact that it is never necessary to get beneath the motor for any purpose, the dust pan below the engine is a permanent fixture and cannot be removed. The forward end of the crankcase encloses the cam-shaft gears, pump gear and magneto idler, permitting liberal lubrication and excluding dirt.

Crankshaft, connecting rods and valves are drop forged. Crankshaft and crankpin bearings are of ample length to minimize wear. The crank bushings are split to provide for adjustment to take up wear. The inlet valve chambers are cast in pairs and are bolted to the cylinders, the joints being packed with copper-asbestos gaskets. The inlet valve caps can be unscrewed by hand for inspection purposes, exposing the valves. Each pair of cylinders exhausts through one outlet, downward and then

longitudinally, to an expansion chamber placed beneath the rear end of the car.

GASOLINE FEED SYSTEM.

The carbureter is placed close to the motor and is water-jacketed so that temperature variation will not affect it. Gasoline is fed by pressure from the main fuel tank under the rear of the car to an auxiliary tank, located above the carbureter, and from there is fed by gravity to the carbureter float chamber. The gasoline passes into the auxiliary tank, through a strainer which removes foreign substances. A petcock on the auxiliary tank enables the operator to draw off gasoline for cleaning purposes. Extending through the dash is a hand screw, by turning which the supply of gasoline may be instantly cut off from the carbureter.

MAGNETO IGNITION SYSTEM.

The ignition equipment consists of an alternating magneto direct connected and driven by a positive gear operating a single non-vibrating coil, from which the secondary current is returned to the magneto and distributed to the spark plugs through a mechanism integral with the magneto, of which the interrupting mechanism is also a part. Being gear driven, the magneto obviates the possibility of irregular and intermittent ignition. The location of the magneto is shown in Fig. 1. The top water connection supports fiber bushed rings, carrying the wires to the spark plugs, preventing the chance of short circuit. A spark advance lever is attached to the steering column on top of the steering wheel.

INDIVIDUAL CLUTCH CHANGE-SPEED.

The change-speed mechanism is of the individual clutch type, used on the Winton

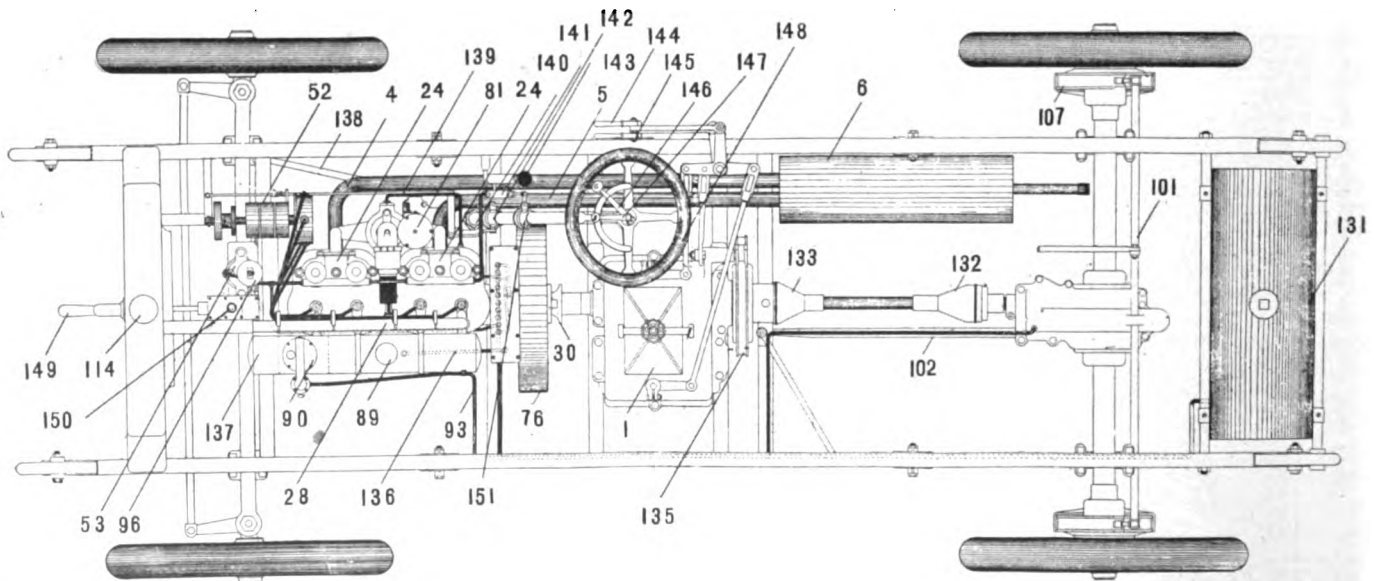
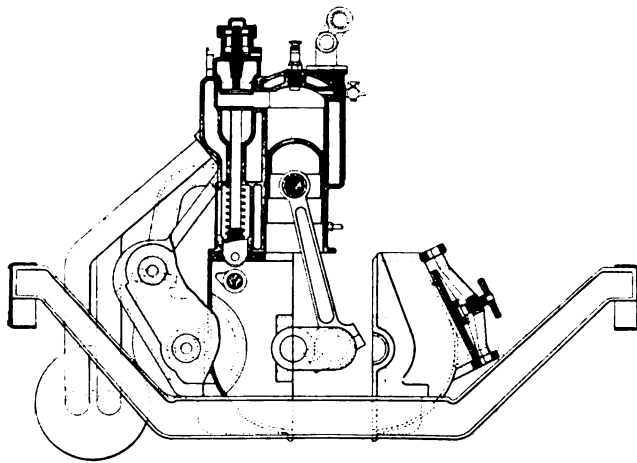
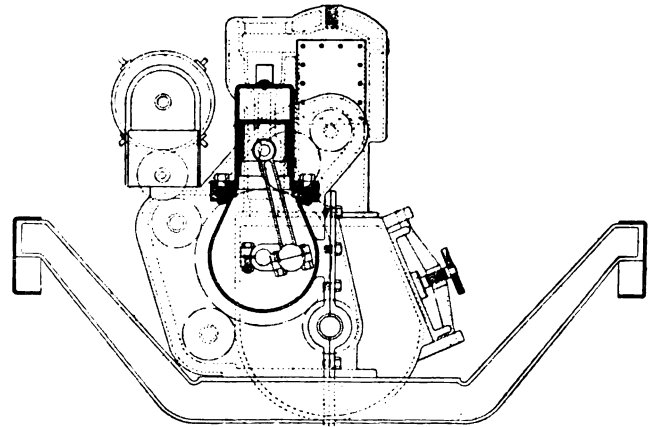

FIG. 1.—PLAN DRAWING OF CHASSIS OF WINTON CAR WITH VERTICAL ENGINE, SHOWING COMPRESSED AIR GOVERNING SYSTEM.

1, Hand-hole cover of crankcase and transmission gear box. 4, 5, Exhaust pipes. 6, Expansion chamber. 24, Inlet chamber. 28, Water line from cylinder to radiator. 30, Oldham coupling. 52, Magneto. 53, Air-pump cylinder. 76, Flywheel. 81, Carbureter. 89, Oil tank cap. 90, Auxiliary gasoline tank cap. 93, Gasoline line from main tank to auxiliary tank. 96, Air line reducing valve. 101, Hub-brake cross-rod. 102, Driving strut. 107, Hub-brake shoe. 114, Radiator filler cap. 131, Gasoline tank. 132, 133, Universal joints. 135, Emergency brake shoe. 136, Oil line from tank to oiler. 137, Air line receiver. 139, Carbureter water jacket pipe. 140, Steering gear case. 141, Foot button. 142, Spark advance sleeve. 143, Foot button cap. 144, High-speed and emergency brake lever. 145, Low speed and reverse lever. 146, Air control cut-out lever. 147, Spark control lever. 148, Steering wheel. 149, Starting crank. 150, Fan oil reservoir.



FRONT ELEVATION OF MOTOR PARTLY IN SECTION, SHOWING METHOD OF REMOVING PORTION OF CRANKCASE.



FRONT ELEVATION OF MOTOR AND SECTION THROUGH THE AIR-PUMP CYLINDER.

cars for a number of years. It gives two speeds forward and reverse. Between the motor and transmission is a flexible coupling which accommodates itself to abnormal road conditions without straining the mechanism. The universal joints on the direct shafts are all enclosed. The transmission box which is made of aluminum and split horizontally, is located immediately beneath the front foot-board. The cover which fits dust and oil tight, can be removed instantly for inspection and adjustment. By removing the upper half of the case, which is bolted to the lower half, the entire change-speed gearing can be removed.

ROLLER-FEED LUBRICATOR.

A lubricator with roller, driven by worm gears, is attached to the motor and extends through the dash. From a reservoir above the cylinders, lubricating oil is fed by gravity to the lubricator, being received in a float chamber, whereby a constant level is maintained, and the oil flow is stopped when the motor is not running. The oil passes from this chamber into the main chamber of the lubricator, where a gear driven aluminum roller revolves in it. The viscosity of the oil being variable with the temperature, the thickness of the oil film on the roller would increase as the temperature decreases, resulting in an excess of oil in a low temperature. To provide against this, an adjustable metallic scraper carries off the superfluous oil, limiting the thickness of the film to the distance between the scraper and the roller. Passing this scraper, the oil film engages a second scraper in contact with the roller, by which it is directed in equal quantities to ten oil leads extending to all bearings of the motor and the rear axle. All oil that works out of the external motor and transmission bearings is returned back to the case. Drains are placed at the bottom of the crankcase and the transmission box for removing oil. They also permit of flushing the cases with kerosene or gasoline.

This system of lubrication provides an oil feed in direct proportion to the motor speed, assures a uniform feed in any temperature with light or heavy oil, has no springs or valves, and operates without

pressure. As the oil reservoir and lubricator are both attached directly to the motor, the oil is kept warm and fluidity is assured in any temperature.

THE FORCED COOLING SYSTEM.

The centrifugal water circulating pump is gear driven. Water is admitted to the radiator at the top and flows downward through a sieve distributor into eighty-nine copper tubes, each seventeen inches long, with 13-16 inch square radiating fins, spaced 3-16 inch apart. The sieve distributor prevents the water from passing through any series of tubes in preference to all. From the bottom of the radiator, the water flows to the circulating pump, which is at the lowest point in the cooling system. The pump forces the water upward around the cylinders, the carbureter and the exhaust valve chambers into the upper water connection, which directs it back to the top of the radiator. Back of the radiator is a gear driven

fan surrounded by a casing. The passage of the air is further aided by a secondary fan cast in the flywheel. From the instant the motor starts, the circulation of water and suction of air are positive.

AIR GOVERNOR RETAINED.

The air governor used heretofore has been retained and improved. The throttle is actuated automatically by air pressure produced by a gear-driven pump which forces air against plungers on the inlet valves and keeps these valves seated; consequently the valves cannot open to supply mixture to the cylinders unless the pressure is relieved. There are two means for relief—a hand lever above the steering wheel and a button under the driver's right foot. By the use of either lever or button the air is released in a constant or variable volume as desired, so that the inlet valves split accordingly. The operator may relieve the pressure by minute degrees from the en-

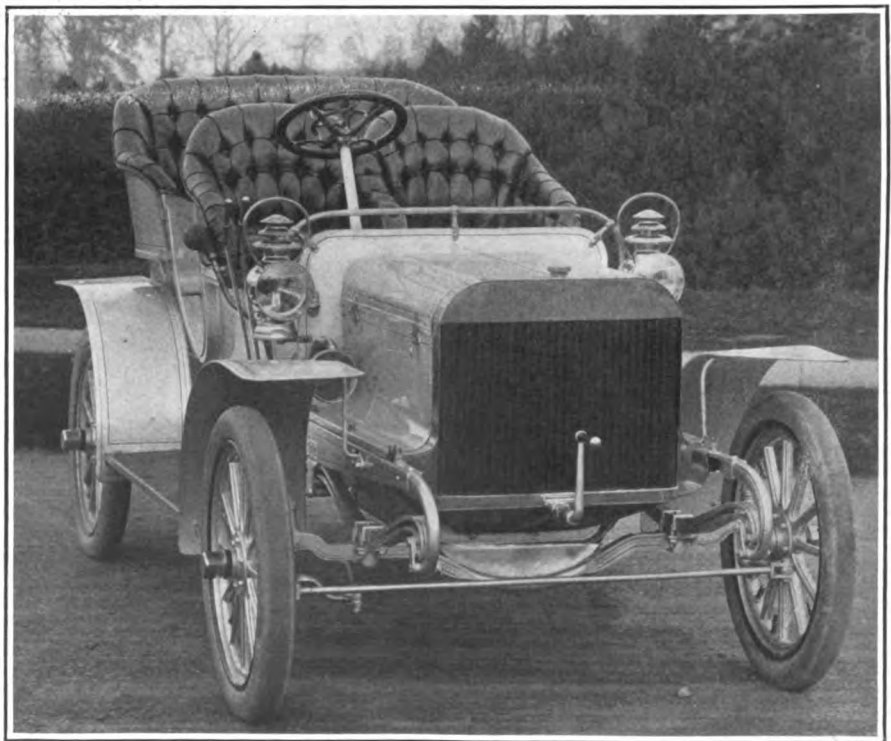

FRONT VIEW OF NEW WINTON MODEL C TOURING CAR WITH VERTICAL ENGINE.

tirely closed point to a point no greater than non-compressed air, so that the motor is governed with extreme flexibility.

CONTROL MECHANISM.

Two levers and one pedal control all transmission clutches and brakes, and it is asserted that the high-speed clutch may be used 95 per cent. of the time, carrying the speed by means of the air governor. The brake band on the drive shaft is operated on forward movement of the high-speed lever; two band brakes on the driving wheel hubs are operated by a pedal.

The front wheels and rear axle turn on roller bearings. The rear wheels are keyed to the live axle and held by nuts. The rear pinion shaft is hardened and revolves in a bronze bushing. In Model C, the axle case is split horizontally and held together by bolts. The other models have vertically split axle cases. The spindles and wheel hubs are tapered to facilitate removal of the wheels. A single ball joint strut limits the axle movement and absorbs braking and driving strains.

PRESSED STEEL FRAME.

The frame is of channel section pressed steel. No sub-frame is used, the motor and transmission being carried on malleable drop frames. The depth of frame varies from 1 3/4 inches to 5 inches. At the forward end, the radiator casting serves as a frame spreader and also as a bearing for the starting crank. Between the rear spring hangers two cross tubes stiffen the frame and support the fifteen gallon gasoline reservoir. The only other tank is one of three compartments placed above the engine cylinders. The first chamber acts as a reservoir for the compressed air, the middle chamber contains the auxiliary gasoline supply, and the rear compartment holds lubricating oil. Horns at either end of the frame receive the ends of semi-elliptical springs. A new compensating spring has been introduced. It consists of six leaves so shackled that only three leaves are engaged under light load, while six leaves are brought into engagement when the load increases.

The steering gear is of the screw and nut type, and wear is distributed on all threads equally. Spark and throttle levers are placed above the steering wheel.

The starting crank is not detachable but is shifted into engagement through a spiral slotted sleeve and out of engagement by a helical spring. When out of engagement it is held in a vertical position. The drop front axle is of Lemoine type, forward steer.

BODIES OF SIDE ENTRANCE TYPE.

In all models but the "A Special," the body is of the side entrance type, with doors on either side. Each has seating capacity for five passengers. The front seat is divided. Cast aluminum body panels support the laminated wood seats. The seats are thickly padded and covered with hand buffed leather over four-inch cushion

springs. There are pockets on the side doors, and roomy lockers beneath the front and rear seats for touring paraphernalia. The "A Special" model has a limousine body with side entrance.

Pipe Closed-Body Car.

Automobiles for winter use are increasing in popularity, largely on account of the great advances made in the reliability and smooth running of motors and the comforts and conveniences in body construction. One of the latest importations in this line is a 15-20-horsepower Pipe car, brought from Belgium by Joseph S. Heller, the American representative of the Pipe concern.

The car is fitted up especially with a view to its use in bad weather, both motor and passengers being well protected. As the accompanying illustration shows, the

is provided with a patent foot warmer, large enough to keep the interior warm in cold weather. A small trunk, tools, and supplies may be carried in the ample storage spaces under the rear seat and beneath the floor of the body, both being reached through doors in the rear of the car.

The motor is of moderate power, but ample for the work the car is intended to do, and runs with remarkably little vibration. Even when the car is standing with the motor running, only a slight tremor can be felt. The heads and water-jackets are cast integral with the cylinders, which have a bore of 140 millimeters and stroke of 192 millimeters. Lubrication is effected by means of an oil pump operated by belt from the secondary shaft. Sliding gears are used in the transmission, giving four forward speeds and one reverse with a single lever. Ignition and throttle are controlled by levers on top of the steering wheel, and the

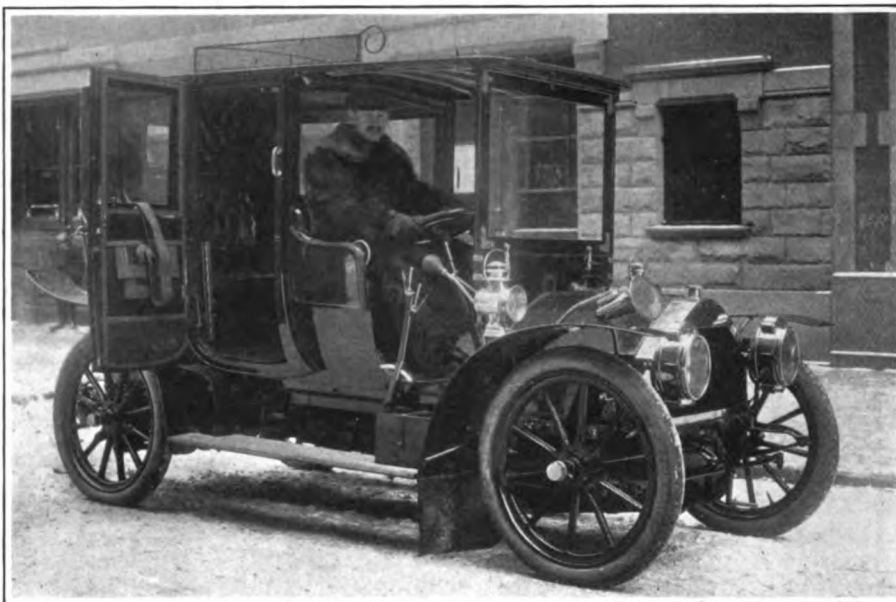

BELGIAN PIPE 15-20-HORSEPOWER CAR WITH CLOSED BODY FOR BAD WEATHER.

body is enclosed and provided with two side doors. Accommodations for four passengers are provided, and there is a surprising amount of space, which makes it possible for the occupants to be comfortable on long rides. The front seats of the coupé are hinged and fitted with springs, so that when a passenger rises to leave the car the seat automatically folds against the partition, leaving a clear passage through the door. The rear seats are of the usual fixed style.

Polished wood flaps swing out from each side and meet in the middle between the seats, forming a table extending entirely across the interior. An electric light in the ceiling is supplied with current from an independent storage battery. Communication with the driver is by means of a speaking tube which ends in a diminutive megaphone arrangement over the head of the chauffeur, who does not have to pick up the loose end of a tube to receive instructions. Each car

usual pedals operate the brake, clutch and accelerator. The clutch is faced with leather and the facing is backed by springs, so that the car can be started with extreme smoothness and entirely without jerking.

The frame is of pressed steel. Semi-elliptic springs are fitted all round, and are easy in action. Axles, knuckles and steering gear are of the latest Lemoine make, and are solid and substantial. The wheels are of wood, 105 by 915 millimeters, and the rear tires are provided with anti-skidding bands, set with metal studs. The wheel-base is 108 inches and the tread standard. In touring trim, the car weighs 2,500 pounds. Dark blue and black are used for the exterior finish, with red striping and polished mahogany window frames to give a certain relief and lightness to the coloring. A sheet metal pan completely protects the motor underneath, so that its operation will be unaffected by mud, water or snow.

Motor Yacht "Hurrion."

The new power boat *Hurrion*, recently completed by the Electric Launch Company, of Bayonne, N. J., for Raymond Hoagland, Esq., of Red Bank, N. J., is a notable example of the application of modern gas and electrical engineering to marine work, the gas engine, dynamo and storage battery being used in combination.

The main source of power is a pair of F.I.A.T. automobile engines especially imported by Hollander & Tangeinan. These engines are of 90 horsepower each, fitted to run on either gasoline or kerosene, and arranged in tandem with a connection by means of a heavy belt and idler, so that one or both may be used at will. They drive a dynamo, connected with a storage battery under the cabin floor, where the weight serves as ballast. The electric equipment of the engine room is very complete. The dynamo and battery may be used to start the engines, and the battery furnishes power for an electric fan, an electric pump, an electric air compressor, a searchlight, a full outfit of electric cooking utensils, and incandescent lamps throughout the yacht.

A false stack is used for ventilating purposes, all vapors being drawn from the engine room, galley and bilges by the electric fan blower and discharged through the stack. The electric compressor supplies air for the whistle and also for pressure on the water tanks which supply the lavatories.

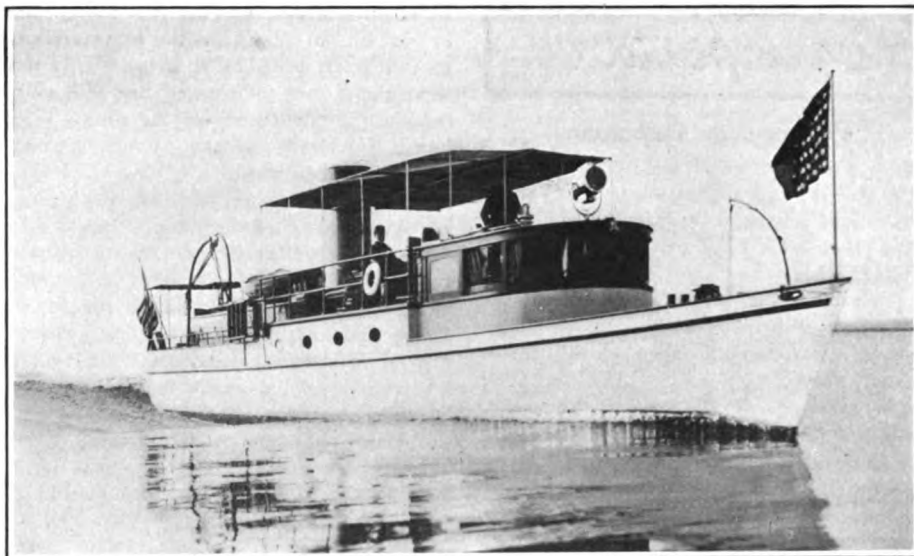

RAYMOND HOAGLAND'S YACHT "HURRION," FITTED WITH TWO 90-H.P. AUTO ENGINES.

The yacht, which was designed by the builders, is 80 feet over all, 11 feet in breadth, and draws 3 feet. She has a sunken pilot house with bridge deck, and the owner's quarters, including main saloon, private stateroom and bath, are aft. The galley is fitted with electric stove, boiler, urn, chafing-dish, one oven and plate-warmers. The tanks carry 700 gallons of fuel, gasoline being used in the trial. New carbureters for kerosene will be fitted before the yacht is placed in commission next spring. The

power tender is fitted with a 5-horsepower Peugeot automobile motor.

The Automobile Club of France has finally decided on the Arcahon Basin as the course for British International Cup contest of 1905; the first race being on September 11. The entry fee is 500 francs, half of which will be returned to every *bona fide* starter. The defending boats, three in number, will be selected by means of elementary trials.

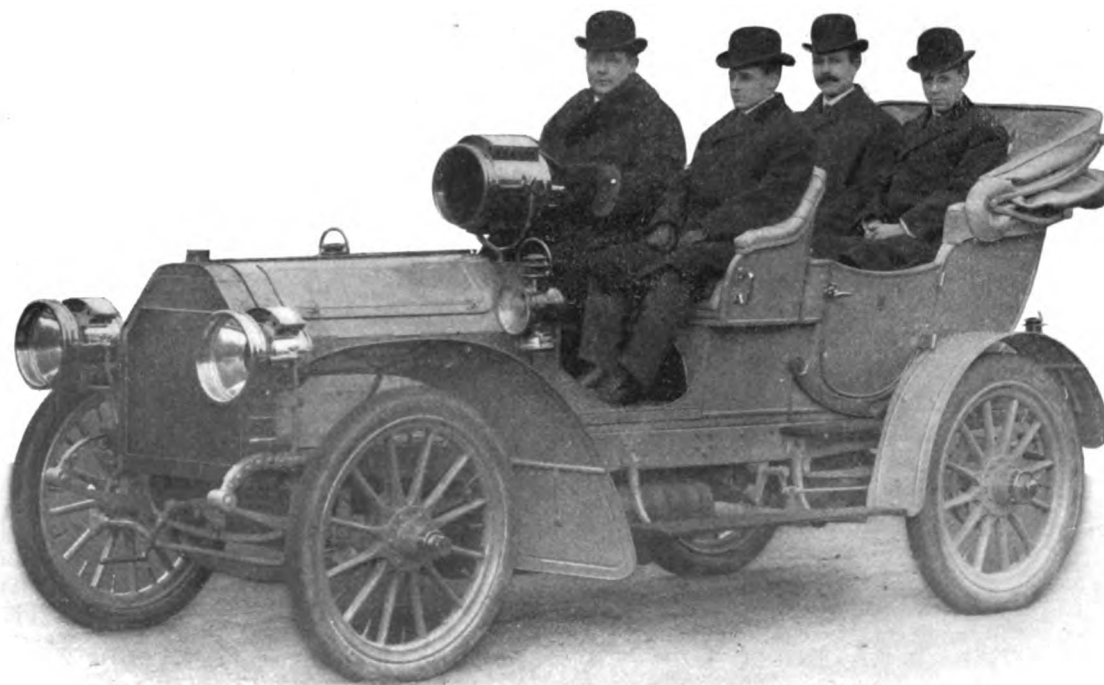

PEERLESS 1905 SIDE-ENTRANCE TOURING CAR FITTED WITH 50-H.P. MOTOR.

The engraving herewith shows the new 50-horsepower Peerless touring car, with side entrance, for the season of 1905. The construction follows the general practice of the Peerless company, and the motor is said to be practically a copy of the engine in the *Green Dragon*, which now holds world's track records for heavy-weight cars up to fifty miles. At the wheel of the car is A. E. Morrison, Boston agent for the company, and a successful competitor in track and road contests; seated at his side is L. H. Kittredge, general sales manager for the Peerless Motor Car Company in Cleveland; and in the rear seat are L. P. Mooers, engineer and superintendent of the factory, and E. H. Parkhurst, advertising manager.

Correspondence

Popping in the Carbureter.

Editor THE AUTOMOBILE:—

[125].—Will you please give me some suggestions through the columns of your paper that will help me to remedy the troubles I have experienced in the operation of my machine, viz.: Loss of power, pop in carbureter and missing explosions. The popping commences as soon as the car is started; then I may go one mile, the popping continuing, and the car will stop; after waiting a few minutes, I crank her and off she goes again. This performance may be repeated in the next mile, or perhaps not for ten miles. I have had the valves cleaned twice, carbureter adjusted and cleaned; have put in new batteries, new commutator spring, new spark plugs, and have had the coil adjusted, but all without avail. Any assistance will be appreciated.

W. G. H. R.

New York City.

Back-firing is usually due either to too poor a mixture, which continues to burn all through the exhaust stroke and ignites the fresh charge, or to failure of the inlet valve to seat properly. The only way in which ignition trouble could cause it would be by the charge failing to ignite at the proper time, and then being ignited so late in the stroke that it could not wholly burn in the time remaining. A thorough search along the above lines ought to disclose the cause of trouble. It may be, for example, that your carbureter float sticks and fails to close the valve; or something might be loose about the spark timer; or the combination of a broken wire and retarded spark would do the trick. If your compression is very weak it might have something to do with it.

Counter-Balancing Two-Cylinder Engine.

Editor THE AUTOMOBILE:—

[126].—What is the proper method of counter-balancing a two-cylinder, vertical engine? Of course, I am aware of the fact that a two-cylinder engine can not be perfectly counter-balanced where both crankpins are on the same side of the shaft, but wish to know how much counter-balance in excess of the actual weight of the cranks and connecting rod will give the minimum amount of vibration.

Please also give me the reason for not placing the cranks on the two-cylinder engine opposite each other except for irregular exhaust? This will, of course, more perfectly balance the engine, and would not, I should think, decrease its power to any appreciable extent.

G. C. B.

Logansport, Ind.

With the cranks together, you are hardly likely to find a better balance than that given by counterweight enough to put the shaft

in balance when the two connecting rods are put on the cranks and the whole allowed to roll freely on parallel strips. This will leave the pistons unbalanced, and will overbalance the small ends of the rods. With unusually heavy pistons, more counterweight could be used.

The most satisfactory balance for a given car will depend somewhat on the location and position of the motor. If the latter is vertical and in front, with the shaft fore and aft, it may be safe to overbalance the pistons a very little, getting to that extent a lateral instead of vertical vibration. If the shaft lies transversely, it would be practicable to add weight enough, if there is room for it, to balance the pistons altogether, which would result in fore and aft shaking at midstroke. The counterweights should be on the cranks themselves, not in the flywheel.

The objection to opposite cranks is not so much the irregular exhaust as it is the irregular torque, with its accompanying irregular rocking of the engine in reaction from the explosive impulses. For a high speed motor this arrangement would usually be less objectionable than the other, but it is not often preferred for medium or slow speeds. It is precisely because no perfect or nearly perfect balance is possible with the two-cylinder vertical motor, without recourse to trappy or "freak" construction, that it is now so seldom found.

Oiling the Crank-Pins.

Editor THE AUTOMOBILE:—

[127].—I was much interested in the device used by Smith & Mabley to ensure lubrication of the crankpins in their Simplex car, as described in your issue of December 10, because I used practically the same device some six years ago in an experimental engine, and have used it and suggested its use in several engines since, always with perfect success. To lubricate the crankpins of a high-speed motor I know of no device so effective.

My own method is to cut a good-sized piece out of the bottom brass, and introduce a piece of coarse felt to hold the oil; but this may or may not be an improvement. I leave the top brass, on which the working pressure comes, perfectly plain. Any break in it, even an oil hole, is a mistake, and reduces the effective area of the bearing by much more than its own size. The reason for this is that the oil film in the bearing is under pressure, which it resists by its own cohesion, and this pressure is at a maximum at the center of the bearing and falls away to nothing at the ends. If the bearing surface is broken by a hole or groove, the oil squeezes into this hole or groove when pressure is applied; and, of course, the pressure thereabouts is below the maximum for a greater or less distance. When oil is supplied freely to the center of a bearing on the slack side, it is carried around by its own cohesion, and works out at both ends, carrying with it any metal particles that may have worn off.

Builders of high-speed motors who attempt to oil their crankpins in the usual way, by oil holes drilled through the upper half of the big ends of the rods, are apt to find that these bearings wear out abnormally fast unless made very long. I have seen crankpin bearings considerably longer than the main bearings—and that, too, in some of the finest makes of French cars—where there was no other reason for it than antiquated methods of lubrication.

HERBERT L. TOWLE

New York.

How to Set Valves.

Editor THE AUTOMOBILE:—

[128].—I own and operate a four-cylinder gasoline car, and write to know if you can give me a good setting for the valves on a four-cylinder, 5 by 5 engine, giving the position of the inlet and exhaust valves at point of opening and closing?

Also, I have considerable difficulty in starting the engine in cold weather. The reason, I think, is that the gasoline does not vaporize properly in the carbureter. Can you not suggest some remedy which will obviate this?

A. W. P.

Wheeling, W. Va.

Assuming that you wish simply to know how to restore the correct setting after the gears have been taken apart, the exhaust valve should close when the crank has got 5 to 10 degrees past the top center, assuming the speed not to exceed the normal maximum of 1,000 or 1,200 r. p. m. The inlet valve, if mechanically opened, should begin to open when the exhaust valve closes, or a very little earlier. Without knowing more about your machine, it would be impossible to advise you as to the best time for opening the exhaust or closing the inlet valves, in case the cams should need alteration.

To start your motor in cold weather, wrap cloths wrung out in hot water around the carbureter, or try a lighter grade of gasoline. Don't let water get into the carbureter, and don't use a torch.

Who Knows the Sapphire Country?

Editor THE AUTOMOBILE:—

[129].—I should be glad to hear from some of your North Carolina subscribers as to whether the roads through the "Sapphire Country" of North Carolina are practicable for an automobile trip along the French Broad.

It is my intention to make a trip through there in the spring, stopping at various points where the fishing is good.

PISCATOR.

The luxuries of one generation are the necessities for the next. It is not impossible that in a few years more the poor man of this country will ride to work in his neat \$50 automobile and look with envy at his rich neighbor who is able to sail round in a \$2,000 airship.—*Oshkosh (Wis.) Northwestern.*

Patents

Two-Cycle Engine.

No. 775,819—C. and W. Hibbard, of Sandyhill, N. Y.

An engine in which the fresh charge is admitted through a cam-actuated valve *J* near the top of the cylinder, and deflected downward by the water-cooled deflector *A*. The shape of the transfer passage *L* just below the valve is such as to concentrate the

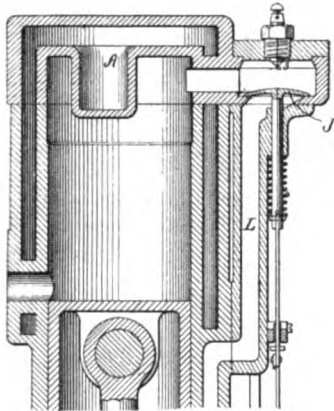

HIBBARD TWO-CYCLE ENGINE.

rush of the charge on the spark plug when the valve is opened, thus insuring positive ignition with throttled charges.

Carbureter.

No. 775,553—G. W. Burton and A. F. Seibel, of Toledo, O.

This carbureter has an air inlet variable to suit the degree of throttle opening. Both functions are controlled by the sleeve *5*, pierced with the triangular holes *7 7* leading to the induction pipe at *3*. In both views the throttle is shut, but when it is open air enters at *2* and draws between the

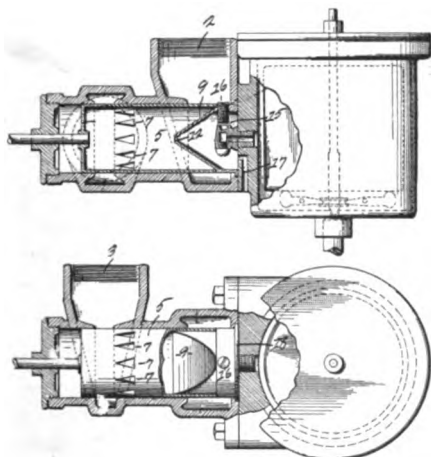

BURTON AND SEIBEL CARBURETER.

wedge *9* and the edge of *5*. A fixed inlet is supplied at *17*, through which air enters to mingle with the gasoline sprayed from *15* before issuing from the slit *12* at the end of the wedge. It is claimed that the spray will impinge against the upper part of

the wedge and the air against the lower part. The spray may be regulated by the screw *16*.

Traction Wheel.

No. 774,246.—A. W. Herrick, of Buffalo, N. Y.

A wheel equipped at one side with sharpened spokes, extending from hub to tire periphery, and normally retracted clear of the ground by springs, but forced out to meet the ground by a sliding cone and levers near the hub. The ends of these spokes are supposed to grip the ground when the tires slip.

Sliding Gear Clutch.

No. 775,503—A. Soames and W. Langdon-Davies, of Surrey County, Eng.

The mechanism for reducing the shocks incident to shifting gears, by disengaging the driving gears from their shaft as well as the shaft from the flywheel, so that these gears do not have to modify the inertia of the driven member of the clutch when shifted. In the drawing, *a* is the clutch shaft, *b* the driven shaft, *c* the clutch

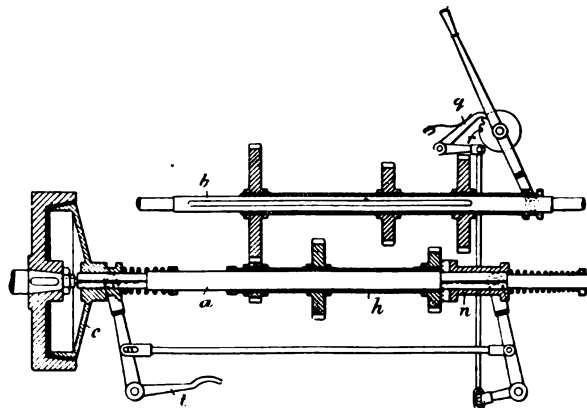

ENGLISH SHOCK REDUCING CHANGE-SPEED MECHANISM.

cone, and *t* the clutch pedal. The three driving gears are fixed to a loose sleeve *h*, which may be locked to the shaft by a positive jaw clutch *n*. The latter is connected to the flywheel clutch and also to the locking mechanism *q r* in such a way that the first depression of *t* releases the cone clutch, a further depression releases the jaw clutch, and at the end of the depression the locking mechanism is released to permit a shift of gears. As *h* is much lighter than *a* plus *c*, the shock of meshing is correspondingly less, and *c* is accelerated or retarded by *n*.

Folding Goggles with Shield.

No. 775,381—H. Newbold, of London, Eng.

A pair of folding goggles with flat glasses and a spring frame supporting a silk shield; the glasses fold against each other.

Radiating Means for Cylinders.

No. 775,860—J. H. Sager and G. D. Green, of Rochester, N. Y.

A system of slotted tubes used in place of the usual flanges or pins. The slotted

edges *c* of the tubes are turned inward, increasing the edge surface, from which the heat is believed to pass more readily to the air. The bases of the tubes are flanged outward, and a perforated sheet *A* is slipped over the tubes till it engages the

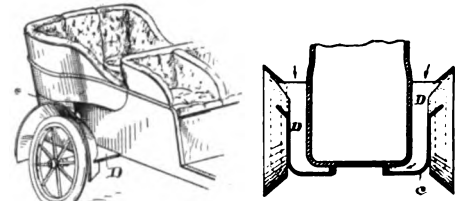

BROWN ATTACHMENT TO DEFLECT DUST.

flanges. Screws *a a b b* then clamp sleeve and flanges tightly in place, and similar means may be used on the cylinder head.

Dust Deflector.

No. 775,595—W. H. Brown, of Chicago.

A flaring mudguard combined with an apron *c* under the overhang of the tonneau seats. This apron forms, with the floor *D*, also provided, an air passage which is carried around to the rear as shown in the

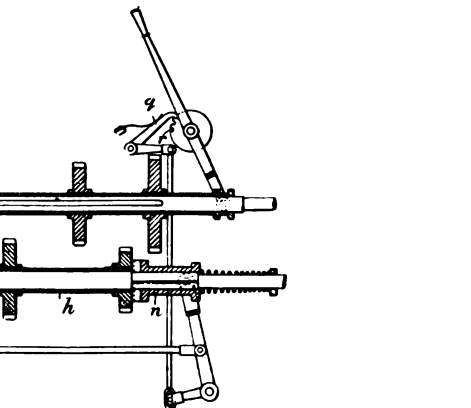

sectional plan. The air thus discharged fills the partial vacuum created at this point by the motion of the car and prevents the dust from being sucked upward into it.

The Russian Minister of Ways of Communication has approved requests for

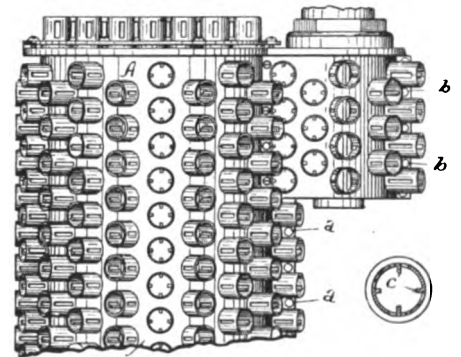

SAGER AND GREEN AIR-COOLING DEVICE.

the purchase of a number of automobiles for use in the transportation of freight between the various railway stations in St. Petersburg.

THE AUTOMOBILE

VOL. XI.

No. 25

Published every Saturday by

THE CLASS JOURNAL CO.,
Flatiron Building, Madison Square,
NEW YORK CITY.

Cable Address - - - Autoland, New York
Long Distance Telephone - 300 Gramercy, New York

SUBSCRIPTION RATES:

United States, Canada and Mexico, - One Year, \$2.00
Other Countries in Postal Union, - One Year, \$3.00

To Subscribers—Do not send money by ordinary mail.
Remit by Draft, Post-Office or Express Money Order,
or Register your letter.

FOREIGN SUBSCRIPTION AGENTS:

ENGLAND:—Liffé & Sons, Limited, 3 St. Bride Street,
Ludgate Circus, London, E. C.

FRANCE:—Boyveau & Chevillet, 22 Rue de la Banque,
Paris.

GERMANY:—A. Seydel, Mohrenstrasse 9, Berlin.

To Advertisers—Copy or changes in orders for advertisements should reach us not later than 5 o'clock p. m. Monday for the issue of Saturday following.

Copyright, 1904, by The Class Journal Company.

Entered at New York, N. Y., as second-class matter.

The Automobile is a consolidation of The Automobile (monthly) and the Motor Review (weekly).

Copies Printed This Issue, - - 12,000
" " Since Jan. 1, - 615,000

Closed Cars for City Work.

The advent of snow and cold weather in New York has served to bring into prominent notice a change that has been taking place for some time in the general adoption of closed automobiles. Three years ago the closed body, except in the case of the electric cabs, was a rarity, and the open car was accepted as a matter of course. Since then many fine specimens of closed body work have been seen at the shows and in the importers' warehouses, and this year a number of large and costly closed cars of both American and foreign make have been in regular use about New York and on Long Island.

For some weeks past, at a season which is frequently only the ending of a tardy Indian summer, the weather has been such as to make an open car decidedly uncomfortable as a pleasure vehicle, but in place of the usual result of a diminution of the number of automobiles seen, if anything, they have been more numerous in the streets than ever. One can hardly pass through the shopping district and the upper part of the city without noticing the very large proportion of enclosed automobiles, the majority of which are not the large, high-powered cars with cumbersome bodies such as are now built for touring, but are of comparatively low power, and intended for city and boulevard use. One distinct type is the imported landaulet with motor of 8 to 15-horsepower now used by women for calling and shopping.

This new type of car appeals to many who have no especial partiality for the automobile, as well as to those whose enthusiasm is not equal to the test of an open tonneau in December. The former find in it a comfortable and practicable substitute for the horse, free at once from the dirt, danger and the stigma of Red-Devilism which in their minds attach to the huge touring car. Such a car saves the horses in stormy weather and on slippery streets, is ready for service at all hours and never tires nor falls ill; it is at least equal in every way to the horse in convenience and efficiency. Where it is a question of protection from the weather for women or elderly men, or for protection to the toilette in calling or attending the theatre or opera, the closed car of light power appeals to an entirely new *clientele* in motoring. Even the seasoned automobilist, who at one time would have scorned the idea of protection, has awakened to the comfort, convenience and safety of the closed car of moderate power for winter work in the city.

Investigation of the Gas Turbine.

The very suggestive résumé, on another page, of a paper read by Mr. R. M. Neilson before the last meeting of the Institution of Mechanical Engineers is of interest not only to the technical man, but to the layman as well. If it had no other merit, Mr. Neilson's paper at least indicates—inferentially, to be sure, but none the less truly—some of the more important problems yet to be solved before a working gas turbine can yet be offered to the public. Incidentally, the futility of attempting to displace the reciprocating gas engine by any form of "rotary" gas engine will be strongly impressed on the mind of every one who reads that article intelligently.

A purely theoretical investigation like the one referred to is more than valuable, it is essential to a correct start on so highly technical a subject as the development of the gas turbine. Without such a preparation, the inventor would almost unavoidably start on what seemed at the time the path of least resistance, and, while producing a working turbine, would miss altogether, unless by happy accident, anything resembling a final type. Before long he would be distanced by his better trained competitors, and would have to abandon all that he had worked for and start afresh. The only complaint that can be brought against the theoretical starting point is that, as the article itself points out, the data are so incomplete. For this reason, too implicit a reliance on the results of calculation should be avoided, and close attention paid to the yet unexplored modifying factors of heat transmission, velocity of nozzle discharge, compressor efficiencies, etc.

Though the scope of Mr. Neilson's paper evidently did not include such concrete matters as weight per horsepower and adaptability to road transportation, it cannot be

questioned that the gas turbine, when perfected, will have advantages over the reciprocating gas engine as great as those enjoyed in its own field by the steam turbine. The one serious objection—the enormously high shaft speed necessary with jet turbines—seems to have been overcome with a fair degree of success in the De Laval turbine by the use of very wide herringbone gears for the first reduction. This, of course, is not the problem troubling inventors most, but it is yet too soon to say how far the difficulties now encountered in gas compression, burning and useful expansion are inherent in the nature of the turbine. As we understand the problem better, it seems safe to say that most of them will disappear.

Against these considerations we may set such positive advantages as light weight per horsepower, great mechanical simplicity as compared with the reciprocating engine, absence of vibration and ease of lubrication—not the least important point, this, of the turbine's practical advantages. All these, be it noted, are in addition to the high thermodynamic efficiency which, to the scientist, is the prime recommendation of the turbine.

It seems not impossible that we may look to the gas turbine for the final solution of the problem of utilizing the heavy hydrocarbons which now go begging for a market because we have as yet learned only to use gasoline—barely kerosene—in our internal combustion engines. Heavy oil, surrounded by the high temperatures of a turbine nozzle or combustion chamber, would burn with far less residuum than in an engine cylinder, and the constantly-burning flame would at a stroke cut the knot of the ignition problem. It may be noted also, as an incidental but important point of superiority over the reciprocating engine, that the turbine motor would give maximum torque at minimum rotative speed, the contrary being one of the chief objections to the present type.

An Opportunity Not Improved.

There was promise of something interesting in itself, and of ultimate benefit to all parties, in the invitation of the Automobile Club of America to one of the city magistrates of New York to address the club from the magisterial standpoint, and it is to be regretted that this first attempt in a new line failed of a realization of its possibilities.

Assuming that the club desired to measure the full force and justice of the prevailing popular opposition to the automobile, the selection of a magistrate as the mouthpiece of such opinion was a wise one. While necessarily in possession of much valuable evidence on both sides, the bench is supposed to represent calm, deliberate opinion, far removed from mere popular clamor, and to base its decisions only on the broadest possible view of the subject under consideration. From the individual standpoint, the

selection was an excellent one, as no one would for a moment consider the speaker as in any way prejudiced toward the automobile.

The opportunity thus offered to the opposition to place a strong case before a representative audience of motorists was an exceptional one; and it is most unfortunate that the speaker failed to appreciate it, and to rise above the hackneyed commonplaces and fallacies of the average autophobe. The theories that the laws are made by the poor people of New York, who must be placated in some way by the automobilist—of necessity a millionaire—; that the automobilist is distinctively a law-breaker in contrast to all other users of the highways, and that he should be subjected to exceptionally severe penalties as compared to the drivers of horse-vehicles, are hardly calculated to solve the one point at issue—the rights and responsibilities of all users of the public highway, and, incidentally, they are hardly calculated to reassure any unfortunate automobilist who may chance to meet the speaker under less auspicious circumstances. Though the phrases were modulated to the rather exceptional nature of the audience, the general tenor of the address was not such as to bring together the public and the automobilists on a common ground of reciprocal relations and mutual benefit, and the discussion tended to bring out only the other side. It was pointed out that the New York automobilist is subject to four separate and conflicting laws, each with a final clause repealing all inconsistent provisions in other acts; so that even with the best intentions, the most cautious of drivers may be at a loss as to the proper legal course.

It has been pointed out repeatedly in this paper that the automobile is in no way the sole cause of danger in the streets, and that it is only a detail of that universal public demand for higher speeds which dates back to the displacement of the horse-car by the first slowly moving electric street cars. There has been a rapid increase in the speed of the whole body of street traffic, this increase being evident even before the advent of the automobile. As a result, new and difficult problems have arisen, the successful solution of which rests with those who make and administer the laws as well as with those subject to them. At the present time it may fairly be said that the automobile clubs, not only in this country but abroad, are doing their part and in no way avoiding their responsibilities.

An English motorphobe, F. W. Verney of the Bucks Chamber of Agriculture, has proposed an ingenious form of punishment for automobilists convicted of fast driving. He would have the offending cars painted yellow and marked with the governmental Broad Arrow.

The Automobile Club of Argentine, recently formed at Buenos Ayres, according to latest reports, has enrolled more than 100 members.

MAGISTRATE CRANE ADDRESSES MOTORISTS.

Gives Characteristic Advice to A. C. A. Members at Weekly Meeting Upon Invitation.—Ex-Presidents Scarritt and Shattuck Call Attention to Inconsistent Laws and Police Discrimination.

Magistrate Crane, famous among New York automobilists for his severity in dealing with those who come before him in his official capacity, was the guest of honor of the Automobile Club of America on Tuesday evening, December 13, having been invited to address the members on the subject of their relations with the law.

The magistrate took his usual stand and insisted that automobilists must obey the laws of the people or be "swept from the highways." Automobilists as a class, he said, are regarded as hard-hearted, unfeeling men, who consider it a huge joke to see a pedestrian jump for his life from in front of a car.

Ex-President Winthrop E. Scarritt replied to the magistrate's remarks, and brought out strongly the point that automobilists were not only willing, but anxious to obey the law, but that they should have a law that could be obeyed. The results of the timing of horse-drawn vehicles and automobiles last summer in Central Park were alluded to, and emphasis was laid on the fact that although many automobilists were arrested while the timing was in progress, not one horse driver was molested, showing that there was discrimination.

Magistrate Crane replied that horse drivers brought before him fared exactly the same as any one else, and declared that automobiles were dangerous because of their tremendous power. He became quite animated in describing several of his narrow escapes, when his jump, that has been often referred to before, was brought into play.

Several other speakers followed with pertinent statements of the facts as they found them. A strong point brought out by A. R. Shattuck was the confused condition of the New York State laws relating to the operation of automobiles. There are four measures, Mr. Shattuck said, and as each was enacted a clause was added repealing conflicting provisions in other laws. Consequently, all the laws must be considered at the same time, and the task was beyond the powers of even the proverbial Philadelphia lawyer. The speaker frankly admitted that he and all other automobilists found it practically impossible to keep within legal speed limits.

Magistrate Crane, while keeping somewhat wide of the main issues, won the unanimous approval of all his hearers by declaring that no man addicted to the use of intoxicants should be permitted to handle an automobile. Mr. Shattuck went a step further and said that no such person should be allowed to drive any kind of vehicle. Several other members spoke in the same vein, and though it was evident that the magistrate and the automobilists did not see matters in the same light, the best of feeling prevailed, even after the guest of the evening stated that his little daughter, on being told that her father was going to address the Automobile Club, exclaimed, "Give it to them, Papa!"

The meeting was the regular Tuesday evening open gathering of club members and their friends. President Morris presided. After the more serious part of the entertainment was concluded the grill-room

was invaded and the guests partook of refreshments.

Following is a list of the committees appointed by the Board of Governors of the Automobile Club of America at their meeting on December 7 at the club headquarters in New York. The chairman, when the only member named, will fill the vacancies in his committee:

House Committee—Captain Homer W. Hedge, chairman; General George Moore Smith, Robert Walton Goelet, W. H. Browning and J. V. Black.

Law Committee—Winthrop E. Scarritt, chairman; W. W. Niles and another to be chosen.

Committee on Membership—Emerson Brooks, chairman; Clifford V. Brokaw and John V. Trevor.

Racing Committee—George I. Scott, chairman; William K. Vanderbilt, Jr., and D. H. Morris.

Library Committee—A. R. Shattuck, chairman, and Philip T. Dodge.

Good Roads Committee—A. R. Shattuck, chairman; William Rockefeller, J. F. Plummer, Jr., and M. D. Chapman.

Runs and Tours Committee—M. M. Belding, Jr., chairman.

Foreign Relations Committee—Clarence Gray Dinsmore, chairman.

Exhibition Committee—General George Moore Smith, chairman.

Motor Boat Committee—J. H. Carpenter, chairman; Frank Croker, P. Chauncey Anderson and C. V. Brokaw.

Technical Committee—Dr. Schuyler Skaats Wheeler, chairman.

GORDON BENNETT ENTRIES.

Two Pope-Toledos and a Locomobile to Represent America.

Only three entries for places on the Gordon Bennett team have been received by Secretary Butler, of the Automobile Club of America, notwithstanding all that has been heard about fast cars under construction in this country for some time past. These are Colonel Albert A. Pope's 90-horsepower Pope-Toledo racer; a similar Pope-Toledo racing car that has just been ordered by W. T. Muir, of Lexington, Ky., and the Locomobile car, the entry of which by Dr. H. F. Thomas, of Chicago, has already been noted. "If none of these cars fall down," said Secretary Butler, "we shall have a team. I don't know why the others who have fast cars have not come in; several other entries were expected, but have not materialized." The entry lists closed Thursday, December 15.

A day or two before the closing of the list a New York man, Andrew Dam, made inquiries at the club rooms on behalf of one Treene, a Michigan man said to be connected with the Corliss steam engine company, who has under construction a special racing car with a motor capable of developing 120-horsepower. Assurances were given that the entry would be made, probably through a member of the club, but up to Thursday evening, however, nothing further had been heard of the Treene wonder.

When in danger of being run down by an automobile, says the Rankin, Ill., *Independent*, a Milwaukee man leaped into the air, alighting on the machine and thereby saving his life which is remindful of the fact that it was the hops that made Milwaukee famous.

"I see that King Edward is traveling incog."

"Something new in automobiles, I suppose."
—Judge.

SENATE COMMITTEE FAVORS ROAD BILL.

Strongly Recommends Latimer Bill Appropriating \$24,000,000 for Highway Construction—Says Congress Has the Power, and Public Would Save Losses of \$500,000,000 Yearly.

Special Correspondence.

WASHINGTON, D. C., Dec. 12.—In a long but highly interesting report, the Senate committee on agriculture and forestry has strongly recommended the passage of the Latimer bill for the improvement of public roads. It carries an appropriation of \$24,000,000, to be available in three annual instalments of \$8,000,000. This fund is to be used in the construction and improvement of the public roads of the country, under the direction of the Secretary of Agriculture through a bureau of highways.

The following excerpts from the report will be of interest to all who want to see the public roads of the country improved:

"The first point of inquiry is as to the constitutional power of the Congress to make an appropriation for road purposes. The broad construction that has been given to the 'commerce clause' of the constitution by the enactment of river and harbor legislation, would seem to leave little doubt of the power of Congress to make an appropriation for the construction and improvement of the roads if such appropriation was thought desirable. In other words, an examination of the course of legislation under that clause will demonstrate the fact that both upon principle and logic, the power to improve roads is as clear as the power to improve non-navigable waters of the country, and that the whole question is not so much one of power as expediency."

After discussing at length the power of Congress in this respect, and pointing out numerous instances in which that power had been invoked, the report goes on to say:

"Under the system of road building and improvement now in vogue in most of the states, about one-third of the people are called upon to do all the road work—the people who live on the road. They are required to work so many days on the road each year or to pay so much in lieu of their labor. The work done in this way is scarcely sufficient to keep the roads in passable condition, much less to build permanent highways. Some of the states levy a road tax, and because of their great wealth have been able to do something toward the building of permanent high-class roads. The real difficulty lies in the fact that under either method a large part of the population and wealth escape taxation for road duty altogether.

"The plan of the bill under consideration is to relieve this difficulty by appropriating one-half of the cost of improving the roads out of the national treasury. The improvement of the roads is a gigantic undertaking, and in that fact lies the first and most urgent reason for national aid. Because it is a gigantic enterprise does not argue that it ought not to be undertaken, provided the plan proposed is within the means of the government and in line with its duty.

"It will not be contended that the roads should be allowed to remain as they are. They must be brought up to the proper standard by some means, and money is that means. The money must come from the people, and it should be drawn equally from all. The only way to accomplish that, is by an appropriation from the general treasury. The average cost of transporting products over the public roads in the United States has been found, after careful investigation,

to be 25 cents per ton per mile, and the total cost per year about \$1,000,000,000. Over improved roads the cost is from 10 to 12 cents per ton per mile, so that under a system of high-class roads the people would save, in the bare cost of transportation alone, about \$500,000,000 per year.

"The roads of the country are the avenues of the prosperity of the whole country and are to a large body of the people the connecting link between them and civilization. They are of vital importance. Their present condition should be a source of mortification to the nation. Their improvement will make for the upbuilding and uplifting of all the people in every department of life, and the passage of this bill would be entirely consistent with our constitutional power and in line with our public policy."

Every automobile owner and user in the country should be an advocate of the Latimer bill, whose enactment would increase one hundredfold the pleasures of automobiling.

GOOD ROADS MEN MEET.

New York Supervisors' Committee to Ask \$4,000,000 Appropriation.

Special Correspondence.

ALBANY, Dec. 12.—A meeting of the executive committee of the annual Good Roads Convention of delegates representing the various boards of supervisors of New York State was held at Albany on December 8, preparatory to the general meeting in the same city on January 24-25. There were present W. Pierrepoint White, Utica; Albert R. Shattuck, New York; Dr. Edward J. Bedell, Albany; S. S. Salisbury, Auburn; Charles T. Chamberlain, Elmira; F. B. Parker, Batavia; Arthur Warren, Rochester; Robert E. Gilman, Syracuse; Ira P. Cribb, Canandaigua, and John Gick, Saratoga county.

The executive committee has announced that its report will ask for \$4,000,000 this year, as the counties have appropriated that much money. It will also ask the Legislature to again pass the \$50,000,000 bond issue to build one mile in ten of all the highways in the state, making a state system of 7,500 miles. The bond issue has been discussed widely throughout the state before boards of supervisors, highway conventions, farmers' institutes and grange meetings, and wherever it has been explained has met with the approval of the people, who want to develop roads leading to the present shipping centers.

The general meeting will bring together 350 delegates, representing fifty-seven counties of the state.

NAPIER HARMSWORTH CUP ENTRIES.

Special Correspondence.

LONDON, Dec. 3.—The Napier Motor Car Company has already entered two launches for the next match for the British International Cup for motor boats, and a third entry of a Napier launch is promised. In addition to *Napier II.* of this year, of thirteen meters length and with a four-cylinder motor of 120 horsepower, there will be *The Napier*, of very light construction unsinkable and self-righting.

The third launch, now under construction, is for Lionel de Rothschild. She will be twelve meters long, designed for heavy weather, and will carry a six-cylinder motor of 180-200 horsepower. The three launches will together be adapted to all extremes of light, moderate and heavy weather, and it is expected that one of the three will run under any conditions.

FLORIDA RACE PROGRAM.

Events Arranged for Six-Day Ormond-Daytona Tournament in January.

Entry blanks for the third annual international racing tournament to be held on the Ormond-Daytona beach, Florida, during the week of January 23, have been mailed. The entries close Tuesday, January 10, 1905, with W. J. Morgan, 136 Liberty street, New York. The list of events is as follows:

Event No. 1.—One hundred mile international race for the W. K. Vanderbilt, Jr., trophy; to be run in five courses of twenty miles each, making four turns at the ends of the straights, and in case the number of starters exceeds six, the cars to be started at one-minute intervals and the winner determined by time instead of place.

No. 2.—One-mile international championship race for the Sir Thomas R. Dewar trophy; to be run in heats of four cars each.

No. 3.—Ormond Derby ten-mile open race for the Maj. C. J. S. Miller trophy.

No. 4.—Daytona Handicap fifty-mile open for the F. E. C. A. A. Burgoyne cup.

No. 5.—One-kilometer record open race for the H. L. Bowden trophy; same conditions as to starters as in event No. 1.

No. 6.—One-mile open race for steam cars for the Col. R. C. Clowry trophy.

No. 7.—One-mile for cars up to 60-horsepower for amateur drivers only.

No. 8.—Fifty-mile handicap for the Lozier trophy, open only to American-built cars; conditions same as in Event 2.

No. 9.—Ten-miles for Mercedes cars only, for the Allen-Halle trophy.

No. 10.—Ten miles for F. I. A. T cars only, for the Hollander & Tangeman cup.

No. 11.—Twenty miles open, for the E. R. Thomas championship trophy.

No. 12.—Five-mile trials against time, open to stock cars listed at \$1,000 to \$1,800.

No. 13.—Five-mile trials for stock cars listed at \$1,801 to \$2,750.

No. 14.—Five-mile trials for stock cars listed at \$2,751 to \$4,000.

No. 15.—Five-mile handicap for stock cars, open only to those cars that have competed in events Nos. 3, 4 and 5.

No. 16.—Five-mile trials for stock cars listed at \$4,001 to \$6,000.

No. 17.—Five-mile trials for racing cars of all weights.

No. 18.—Great Ormond Handicap five-mile race open only to first five cars in events Nos. 7 and 8.

No. 19.—Five miles for gasoline cars of \$650 list or less.

No. 20.—Five miles for stock cars of \$651 to \$1,000 list.

No. 21.—Ten miles for stock cars of \$1,001 to \$1,800 list.

No. 22.—Ten miles for stock cars of \$1,801 to \$2,750 list.

No. 23.—Ten miles for stock cars of \$2,751 to \$4,000 list.

No. 24.—Ten miles for cars of 40 horsepower and less.

No. 25.—One-mile trials for stock cars of 551 to 851 pounds.

No. 26.—One-mile trials for stock cars of 852 to 1,432 pounds.

No. 27.—One-mile trials for stock cars of 1,432 to 2,204 pounds.

No. 28.—Gymkhana race.

The committee in charge of arrangements for the Glidden touring competition will hold a meeting in New York city on December 21 for the purpose of arranging conditions and details of the event.

France has added another new word to the vocabulary of motoring—"domobile"—signifying the new enclosed touring cars with sleeping accommodation.

POWER BOAT EXHIBITORS.

Famous Yacht Builders Engaging Space at Boston's Auto Boat Show.

Special Correspondence.

BOSTON, Dec. 12.—When the Boston Automobile Dealers' Association announced last summer that it was planning to hold a power boat show in connection with its annual automobile show in March, and that it would devote the entire basement of Mechanics Building to the boats, there were many scoffers who said that the association could not get enough boats together to make any kind of a showing in the big basement space. The committee of the association in charge persisted with the idea, however, and now, with the show three months away, the applications received for space demonstrate that Boston will have the best power boat show ever held in this country.

The famous firm of Herreshoffs, of Bristol, R. I., builders of America's cup defenders and of record-making power boats, has taken four large spaces and will have an exhibit of exceptional interest. It will exhibit a racing auto boat which is now in process of construction for a nobleman abroad, and which promises to be a revelation in aquatic speed. This boat will be shipped to its owner direct from Boston. The Herreshoffs will also show other boats and models of famous craft.

Another well-known firm of boat builders, which like the Herreshoffs, has considered its reputation well enough established not to require advertising in shows, is the Lawleys, of South Boston, builders of some of the fastest and finest craft afloat in Massachusetts waters. Murray & Tregurtha will likewise have a large exhibit, and the Fore River Ship & Engine Company, builders of warships, and the seven-masted schooner

eight days, the cars running a distance of 100 kilometers each day from the charging station in Paris. The classes are:

Class I., two-seated vehicles, maximum weight, 1,300 kilos; Class II., four-seated vehicles, maximum weight, 1,500 kilos; Class III., six-seated vehicles, with luggage carrier to take 30 kilos per passenger; maximum weight, 1,800 kilos; the weights being taken when in running order.

All classes may have closed or open bod-

NEW DECAUVILLE QUARTERS.

Standard Company Secures Central Automobile Company's Broadway Garage.

As a result of the recent disastrous fire in its garage, on Thirty-ninth street, New York, the Standard Automobile Co., agents for the Decauville cars, is following the trend of the trade and moving up town.



FRONT OF STANDARD GARAGE IN NEW YORK AFTER FIRE LAST WEEK.

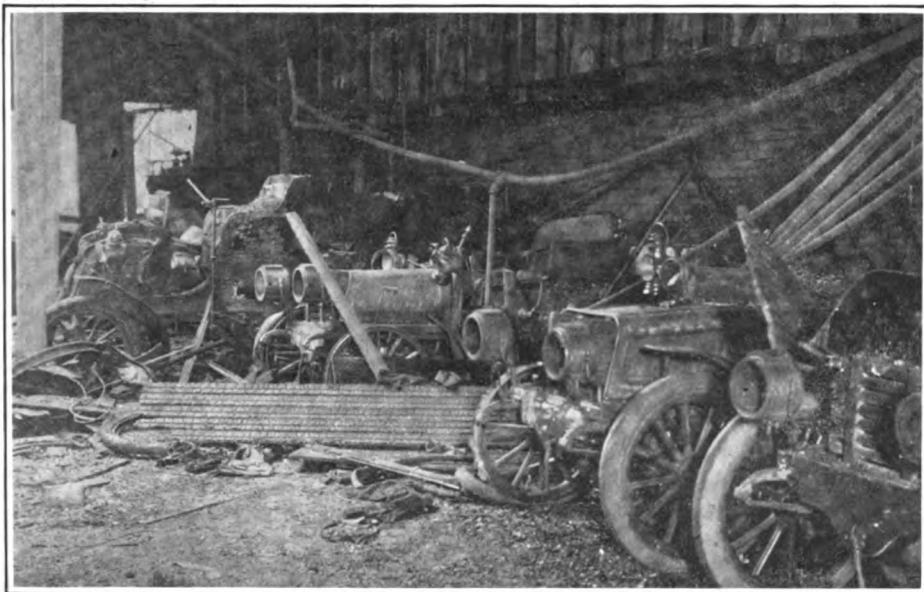

CORNER OF MAIN FLOOR, SHOWING DAMAGE TO DECAUVILLE CARS AND BUILDING.

Thomas W. Lawson, have taken space. Every day sees the space in the power boat department lessening and this section will undoubtedly rival in interest the automobile display.

FRENCH ELECTRIC VEHICLE TRIALS.

A reliability trial of electric vehicles will take place in Paris next May, under the auspices of *L'Auto*. The trials will cover

ies, or bodies which may be closed or opened at will; all bodies must be upholstered.

All cars must have at least one double-acting brake and also a sprag. The entry fee prior to March 15 will be twenty francs; part-entries to May 1, 40 francs.

No maker may enter two vehicles of similar type and dimensions.

The points of the competition will be the cost per day, the comfort, ease of control and freedom from noise, and the price.

The place selected is the Central Automobile Company's large garage, at 1684 Broadway, between Fifty-second and Fifty-third streets. The repair shop and storage business of that concern have been taken over by the Standard company, but for the present the Central company will continue to keep its cars there, pending other arrangements which are not yet completed. The prompt action of the Standard company has been the subject of considerable favorable comment.

A PICTURESQUE PROPOSAL.

Asks Permission to Drive 175-H.P. Racer to New York on Rails.

Special Correspondence.

PHILADELPHIA, Dec. 12.—This city is to be represented in the Ormond-Daytona races next month by Edward M. Steck, a wealthy member of the Automobile Club of Philadelphia. His car, a Darracq, which, it is claimed will develop upward of 175 horsepower and attain a speed in excess of 100 miles an hour, is the subject of conversation in the haunts of Quaker automobilists; not so much on account of what its owner hopes it will do on Florida's sunny strand, as for the spectacular request preferred by Mr. Steck to the Pennsylvania Railroad management, to allow a time trial over its tracks between Jersey City and Philadelphia.

Given the right of way, Mr. Steck thinks his flyer can cover the distance between the two cities in less than fifty minutes. This means more than 100 miles an hour.

BOSTON AUTO CLUB'S HOUSE WARMING.

Enlarged Clubhouse Formally Opened with Dinner, Addresses and Music—Extension of Building Erected Three Years Ago Affords Storage for 200 Cars of Members.

Special Correspondence.

BOSTON, Dec. 12.—It was a jolly company, and one in which informality and good-fellowship ruled that gathered in the club rooms of the Massachusetts Automobile Club last Friday evening to "warm" the enlarged clubhouse. The addition to the Boylston street clubhouse, the first one built and occupied by an automobile club in this country, was completed last summer, but as it was then inconvenient for a large number of the members to attend any meeting the house warming was put off until this week. The committee in charge, consisting of Dr. Joseph Stedman, Stephen Sleeper and Harlan W. Whipple, had prepared an interesting program, which began with dinner at 6:30 o'clock and ended at midnight. Through all that time things were kept going in a lively manner, so that the whole building is now properly dedicated to the cause of automobilism.

About one hundred members of the club and a few guests were seated at the dinner which was held in the parlors of the club. President Elliot C. Lee presided at the head table and near him were President Whipple, of the American Athletic Association; President Asa Goddard, of the Worcester Automobile Club, and Police Inspector Smith, of New York. The speechmaking after dinner was brief and informal. President Lee told of the organization of the club, its amalgamation with the New England Automobile Club, and the erection of the original clubhouse on Boylston street. At that time it was predicted by even enthusiastic automobilists that the club had taken too big a burden on its shoulders in attempting to maintain a clubhouse in the best section of the city. That was three years ago. A year's occupancy of the clubhouse showed that the men who had secured the new house had not even looked far enough into the future and that additional facilities for the storage of cars were needed. The addition was begun about a year ago and the club now has room for the storage of 200 cars. President Lee complimented the members of the club on their spirit which had made possible the finest automobile clubhouse in the country.

Harlan W. Whipple spoke of the good example set by the Massachusetts club, which is now being followed by the Automobile Club of America that has just decided to erect a clubhouse and garage. After the speechmaking, there was a musical program by a glee, mandolin and banjo club and by a quartet, and those present joined in the choruses of the popular songs.

In the course of the evening the members and guests took the opportunity to inspect the different parts of the clubhouse and to examine the many fine machines that are owned by the members. The new building has a frontage on Boylston street of 113 feet and a depth of nearly 100 feet with entrances both from Bolyston street and from a street in the rear. The ground floor contains the office of the superintendent and a ladies' waiting-room, and provides storage room for a large number of vehicles that are in constant use by their owners. In the basement there is more storage space and facilities for recharging the batteries of electric vehicles. There is an entrance to

the basement from the rear, and it is also connected with the other floors by two automobile elevators. From the street floor there are two wide entrances which make it possible to handle cars of longest wheelbase with ease.

The second floor of the older part of the house is given up to quarters for social purposes, reading-rooms, parlor and dining-room. The new part of this floor is devoted to the storage of cars that are used occasionally, and for which there is no room on the ground floor. On this floor there is also a room for chauffeurs. On the third floor there is the repair shop and more storage room, the cars on this floor being mainly those belonging to members of the club who are out of the city, or who, for some reason, are not using them. While the new garage affords adequate accommodations, the growth of the club and the increase in the number of automobiles owned by its members indicates that it will be only a question of time, when still another increase in space will be needed.

BRITISH MOTOR BOAT CLUB.

Special Correspondence.

LONDON, Dec. 3.—A movement for a club of auto boatmen has been under way

MOTOR CLUB ELECTION.

C. H. Hyde Chosen President of New York Club—Membership Now 110.

The New York Motor Club, recently organized, has secured permanent quarters in Bretton Hall, Broadway and 86th Street, where a suite of rooms have been attractively fitted up. The first annual election was held on Thursday evening, December 8, at which time there were two tickets in the field, one headed by S. A. Miles, general manager of the N. A. A. M., and the other by Charles H. Hyde, a prominent Brooklyn attorney. Before the balloting commenced more than forty new members were admitted. A compromise was effected between the supporters of the opposing tickets, which resulted in the election of the following officers:

Chas. H. Hyde, president; S. A. Miles, first vice-president; W. J. P. Moore, second vice-president; A. L. McMurtry, treasurer, and Louis R. Smith, secretary. K. C. Pardee, Frank J. Griffin, Joseph Cowan and Angus Sinclair were elected as board of directors

On Monday evening last a special meeting of the board of directors was held, at which time Mr. McMurtry resigned from the office



MASSACHUSETTS A. C. CLUBHOUSE, BOYLSTON STREET, BOSTON. SHOWING NEW EXTENSION.

for some time at the instance of the paper *Motoring Illustrated*, and a meeting for organization was held on November 23, at the Temple Hotel, London. Mr. Noel Kenealy was made temporary chairman and an organization was effected under the name of the British Motor Boat Club. The following committee was appointed to formulate rules: Noel B. Kenealy, S. F. Edge, Charles Jargott, S. D. Begbie, Harrington Moore, Mowdsley Brooke, F. C. Blake, Linton Hope, H. Harden, D. Dundas, Frederick Coleman, H. H. Henike, W. Stewart, F. R. Simms, Ernest Owers, Capt. Withey and Edmond Kenealy.

Baron De Zuylen, president of the Automobile Club of France; M. Max Richard, president of the Chambre Syndicale de l'Automobile, and the Duke of Ratibor, president of the German Automobile Club, have been elected honorary members of the Automobile Club of Great Britain and Ireland the same day.

of treasurer, stating that the pressure of business on his time was too great to permit him to serve in that capacity. Frank J. Griffin, one of the directors, was then elected in his stead, and Mr. McMurtry was elected to succeed him on the board of directors.

The following heads of committees were appointed, who will in turn appoint other members to fill their respective committees: Tours and runs, S. A. Miles; technical, W. J. P. Moore; library, Frank J. Griffin; entertainment, C. C. Boynton; membership, W. J. P. Moore; law, Stephen C. Baldwin; executive, the president and first and second vice-presidents, A. L. McMurtry and Joseph Cowan.

It was decided to hold a smoker on January 15, Sunday evening following the opening of the Madison Square Garden Show, for which invitations will be issued.

The club roster now numbers 110 members, and the organization is in a flourishing condition.

SALON EXHIBITORS.

Foreign Cars and Accessories to Be Shown at Herald Square January 11-24.

Elaborate preparations are being made for the decoration of Herald Square Exhibition Hall for the Importers' Automobile Salon, which opens there on January 11 and continues to January 24. The decorations will be of uniform character, as will also be the illuminated signs. Raised platforms, carpeted and railed, will be provided for the cars, with broad aisles between. An octagonal band stand will be placed in the center of the hall. Women visitors to the show will be served with tea by Japanese tea-girls.

Following is a list of the exhibits and exhibitors:

Argyll cars, Peter Fisher, New York; C. G. V. cars, Charron, Girardot & Voigt, Paris; Clement-Bayard cars, S. B. Bowman, New York; Darracq cars, American Darracq Co., New York; Decauville cars, Standard Automobile Co., New York; De Dietrich cars, Union Motor Supply Co., New York; Delahaye cars, L. J. Gougler, New York; F.I.A.T. cars, Hollander & Tangeman, New York; Hotchkiss cars, Henry Fournier, Paris; Martini cars, Palmer & Christy, New York; Mercedes, Renault and Panhard cars, Smith & Mabley, New York; Mors cars, E. Lillie; Napier cars, Central Automobile Co., New York; Pipe cars, Joseph S. Heller, New York; Peugeot cars, Peugeot Co., Paris; Richard-Brasier cars, E. B. Gallagher, New York; Rochet-Schneider cars, Auto Import Co., New York; Westinghouse cars, Westinghouse Co., Paris; bodies will be exhibited by Rothschild, Vedrine et Cie. and Kellner, Paris, and J. M. Quinby & Co., New York; ignition apparatus, Leon Rubay, New York; acetylene generators, J. B. Colt, New York; Aster motors, A. J. Myers, New York; Peugeot motorcycles, Julius Piel, New York; automobile parts, Malicet & Blin, Paris. There will also be exhibits of Continental, Michelin, Sampson and Peters tires.

ALDEN SAMPSON TO BUY CREST.

An arrangement has been made between Alden Sampson, 24, of Pittsfield, Mass., and Henry E. Lamb, of the Crest Mfg. Co., Cambridge, Mass., whereby Mr. Sampson is to purchase the entire capital stock of the Crest Mfg. Co., and also the material for production now on hand, in order to continue the output of Crest cars. The transfer of the capital stock carries with it the Crest license privilege of the Association of Licensed Automobile Manufacturers, of which the Crest Mfg. Co. is a member. Mr. Sampson, who formerly built the Moyea, has been experimenting as a builder for a year or more, and last spring entered a car for the international cup race, but it was not finished in time. With the Crest license franchise in hand it is to be expected that a new line will be added at once to the Crest models.

DUQUESNE COMPANY REORGANIZED.

The Duquesne Motor Car Co., of Jamestown, N. Y., formerly of Buffalo, has been reorganized, a majority of the stock having been purchased by business men of New York City and Jamestown, N. Y., and Erie and Corry, Pa. Work will be commenced at once on 100 cars for the spring trade. Distribution of the Duquesne cars will be in the hands of the American Duquesne Co., which will purchase the entire output. Pending certain necessary changes in the charter

of the original concern, the manufacturing business will be conducted by an auxiliary organization, called the Duquesne Construction Co., which will take up the construction of high-speed motor boats when the charter amendments have been made and the original company is in shape for business. LeRoy Pelletier, the founder of the parent company, retains the office of president. The Duquesne machine is a touring car of 16-21-horsepower, with four-cylinder vertical air-cooled motor. The marine motors will, of course, be water cooled.

WISCONSIN MALICIOUSNESS.

Milwaukee Club Men Wrought up Over Practices of Farmers.

Special Correspondence.

MILWAUKEE, Dec. 12.—Automobilists in this city and vicinity are up in arms against the practices of farmers to hamper the operation of machines in the rural districts, and the Milwaukee Automobile Club has signified its intention to prosecute to the full extent of the law any person who maliciously attempts to injure an automobile. For some time past numerous complaints have been made that farmers in this locality have been resorting to many devices to cause annoyance to drivers of machines.

One farmer is reported to have said that he derives great pleasure in shooting from some secluded spot at the tires of passing autos. F. C. Beach was the victim of this man, or some one similarly disposed, a short time ago while driving on a road about thirteen miles north of Milwaukee. Mr. Beach says that he was fired at from the rear, two of the shots puncturing one of his tires.

Others have complained that glass has been strewn about on the country highways; that rails and logs have been used as obstructions, and barbed wire has been laid across the road to puncture tires.

Besides these extremely annoying and destructive practices, it is claimed that farmers have pointed guns at motorists, compelling them to stop while the farmers drove mockingly by.

"We have heard a considerable number of complaints relative to the action of farmers in interfering with the operation of automobiles," said Reverend Szukalski, president of the Automobile Club, "and, in fact, several of them were made at the last meeting of the club. I personally know of one instance when the Kilbourn road was blocked with logs in such a way as to enable wagons to pass without being damaged, but autos would meet with great injury. A gentleman in relating an experience he had in Racine County, recently informed me that the road was covered with glass and that when he attempted to go around it a crowd of bystanders threw missiles at him. The club will not attempt to avenge past outrages, but in the future any interference will be dealt with according to law."

RECENT INCORPORATIONS.

Duquesne Construction Co., Jamestown, N. Y.; to manufacture automobiles. Incorporators, William J. Maddox, Brewer D. Phillips, of Jamestown, and Frank L. Bliss, of Corry, Pa.

Dover Garage Co., Dover, N. J.; capital, \$10,000; to manufacture, deal in and repair motor vehicles. Incorporators, Robert A. Bennett, Charles E. Clark and Hiram P. Hall.

Capen Motor Car Co., St. Louis, Mo.; capital, \$15,000. Incorporators, Samuel D. Capen, George A. Capen and Wallace G. Capen.

NEW YORK NEWS NOTES.

A committee of five, appointed by the heads of the mechanical departments of the automobile building concerns composing the Association of Licensed Automobile Manufacturers, to consider the organization of a permanent body, to be known as the superintendents' and Engineers' Branch of the A.L.A.M., held a meeting in New York city December 9, and discussed the matter at some length. The object of the organization is the exchange of ideas and experiences, with a view to the general improvement of automobile construction. A general meeting of the members of the A.L.A.M. will be held in this city January 19, when the work of organization will be completed. The first step toward the formation of this society was taken at an informal outing of the superintendents and engineers on October 7 last, and reported in these pages. The delegates at last week's meeting were A. L. Riker, George W. Wesley, Karl Almqvist and J. Frank Duryea.

* * *

Fire Commissioner Hayes, of New York, has begun an investigation into the manner in which the garages of the city are conducted with reference to safety from fire. As one result, the license of the Michelin Tire Company to store gasoline in its garage at 132-140 West Twenty-seventh street was revoked on account of the alleged danger to a large number of persons employed in a factory on the upper floors of the building.

* * *

Henry Sanderson, who has been president of the New York Transportation Company since 1900, has resigned that position to enter a banking and brokerage business. The office vacated by Mr. Sanderson has been filled by R. W. Meade. Upon the retirement of Mr. Sanderson the executive staff and employees of the company presented him with a Tiffany desk set in bronze, a presentation speech being made by Herbert H. Vreeland, president of the Metropolitan Street Railway Co., who is a warm personal friend of Mr. Sanderson.

* * *

Two entrances to Central Park, one at West Sixty-sixth street and the other at Fifty-ninth street and Seventh avenue, have been closed to vehicles by the Park Commissioners. These entrances have been in use for three years, and both automobilists and horse drivers express dissatisfaction at their closure. The secretary of the park board makes the statement that the gates were opened to vehicles temporarily, and that the recent order has simply restored the original conditions.

* * *

The new Packard quarters on Longacre square were opened for business on Monday, December 12, and there is already "something doing" in a business way. The establishment will be used only for a sales-room, and, in the rear, a repair shop, there being no garage facilities. The salesroom is large and light, the entire front being of plate glass, and there is plenty of room for showing cars to advantage.

* * *

New York City garage proprietors who are members of the New York Automobile Trade Association have agreed on a maximum rate of \$25 a month for the storage, washing and polishing of large automobiles. The charges for small vehicles may be placed at any figure desired.

* * *

The Automobile Club of France has named W. K. Vanderbilt, Jr., as its representative on the Glidden Trophy Commission.



An automobile touring story of more than usual merit opens the December number of *Field and Stream*. The writer, William Arthur Babson, accompanied James B. Dill on his ride of 250 miles from Quebec to the Rangeley Lake region of Maine last summer, passing through what is still a wilderness, the old route of Arnold's expedition against Quebec. Mr. Babson has a keen appreciation of the natural charms of the region, with its quaint, old-time French-Canadian farmers, and also of the strong contrasts brought out by the new means of travel, and with pen and camera together he has made a most fascinating story.

The appearance of the Sunday editions of Philadelphia's most prominent dailies would seem to indicate that their editors have at last concluded that the reading public is interested in automobile news. In its December 4 issue, the *Press*, in addition to its usual budget of motoring news, began the publication of descriptions of routes, with maps. The *Ledger* followed a week later with similar articles, and others have established automobile departments which show a steady increase in amount of space devoted to this class of news.

The Purdue University, of Lafayette, Ind., is now completing plans for the installation of an automobile testing plant. It is intended to conduct this department somewhat along the lines of its locomotive testing plant, which has been in successful operation for more than ten years. The study of automobile construction is one of growing interest among the students of this university, many of whom are entering the automobile business.

Entry blanks for the Cleveland automobile show to be held at the Grays Armory during the week of February 20, have been sent out, and many applications for space returned, although no diagrams have been issued. In past years the tire manufacturers have had an iron-clad agreement not to exhibit at any shows except those in New York and Chicago, but this year they have informed the Cleveland show managers that they will take part in the local show there.

At a meeting of the city council of Wilmington, Del., held on December 8, an automobile speed ordinance was introduced and referred to the law committee. The provisions call for the licensing of all drivers, the carrying of lights, horns and numbers, and the limitation of speed to ten miles an hour, this to be reduced to six miles at street crossings and corners. The ordinance is subject to revision and amendment before final passage.

The Automobile Club of Great Britain and Ireland has given official recognition to the automobile show promoted by the Society of Motor Manufacturers and Traders at Olympia, London, in February next, and will approach either the King or the Prince of Wales with a view to securing royal aid in the opening of the exhibition.

The National Motor Vehicle Co., of Indianapolis, Ind., has for some years experienced more or less difficulty as a result of the organization of new companies throughout the country that have adopted the word National as a part of their names. The adoption of the name National Automobile Company by a recent New Jersey corporation, is likely to be confusing, and the Na-

tional Motor Vehicle Company wishes to emphasize the fact that it is in no wise connected with the New Jersey company, but is located in Indianapolis, and is continuing the manufacture of its line of National gasoline touring cars and electric vehicles.

C. A. Coey & Co., whose garage and salesrooms are now located at 5313 Cottage Grove avenue, Chicago, will soon begin the erection of a building on Michigan avenue, between Fourteenth and Fifteenth streets, which they will occupy as a garage and salesroom, in addition to their Cottage Grove avenue establishment. While the company will make the automobile livery business the chief feature for 1905, it will continue to handle the Thomas Flyer.

The James Brown Machine Co., of Pawtucket, R. I., manufacturers of the Cameron cars, are bringing out for the season of 1905 a 50-horsepower six-cylinder racing machine, and also an eight-cylinder 90-horsepower car, which will be completed about July next. The company is now entering the racing business, and will no doubt compete in all the important events during the coming season.

Develin & Co., incorporated at Chicago by A. A. Develin, with a capital of \$25,000, will open an automobile establishment at 1407 Michigan avenue. The company has secured the agency as western distributors of the Acme car, embracing Illinois, Wisconsin, Iowa, Missouri, Minnesota and Utah. J. C. Zimmerman, formerly with the Ford Chicago agency will be connected with the new company.

"Mayor Bill" Smith, of Newmarket, N. J., who came in for considerable money through the death, in an automobile accident, of Mr. and Mrs. Charles L. Fair, finds that the business of the Auto Storage Company, Plainfield, N. J., of which he is president, is in such condition that the Court of Chancery at Trenton has been asked to appoint a receiver for it. Mrs. Fair was "Mayor" Smith's sister.

The Williams Messenger Delivery Company, of Louisville, Ky., has bought an Oldsmobile delivery wagon for use in its delivery service. This is the first wagon of the kind to be put in use in Louisville, and if the experiment proves successful the company will purchase several more of a similar type.

Commencing Monday, November 21, *Le Velo*, the old-established Paris sporting journal, appears under the title of *Journal de l'Automobile du Cyclisme et de tous les Sports*. Though having changed its name, the publication, as heretofore, remains under the personal control of M. G. de Pawlowski.

Commissioner West, of the Board of Commissioners of the District of Columbia, has issued an order that all professional chauffeurs applying for license to operate in Washington must obtain certificates of good character from three reputable citizens.

The affairs of the Toronto Automobile Co., of Toronto, Canada, are now being wound up. A statement of condition presented at a recent meeting showed a nominal deficit of \$908.65. The assets were estimated at \$5,272.40, and liabilities at \$6,271.05. The company was originally or-

ganized with an authorized capital of \$40,000.

Although news of the Glidden trophy offered for touring car competition only recently reached England, great interest is being evinced in automobile circles and one English entry has already been forwarded. Roger Fuller, a member of the A. C. G. B. I., having entered his 30-horsepower six-cylinder Napier car.

H. Paulson & Co., 285 State street, Chicago, has been incorporated for \$10,000. They will continue to conduct a garage at the State street address, but will remove the salesrooms to Michigan avenue, the exact location not yet being determined. The company will handle the Pierce cars for 1905.

W. P. Kearney, of Toronto, has recently returned from an extended trip through Europe. While in Paris arrangements were completed whereby he will, in conjunction with Mr. Hyslop, also of Toronto, control the sale of the Darracq cars for the Dominion of Canada.

The Bennett-Bird Co., recently incorporated at Chicago, with a capital of \$10,000, is now occupying quarters at 1404-1406 Michigan avenue, and will handle the Premier air-cooler car as its leader. The car was formerly handled by Arthur G. Bennett, who is a member of the new company.

The annual meeting and election of five members of the executive committee of the National Association of Automobile Manufacturers will be held at the Victoria Hotel, Broadway and 27th street, New York City, at 10 A.M., Wednesday, January 18.

The Hotel Piedmont, of Atlanta, Ga., has inaugurated an automobile sight-seeing service, and daily tours are now being conducted throughout the city and its immediate vicinity. The vehicles used have a seating capacity of thirty-five passengers.

The Post Manufacturing Co., with quarters at 1908 Broadway, New York, has succeeded T. W. Post in the manufacture and sale of the Post auto tire grip. Mr. Post formerly manufactured this device at 600 Degraw street, Brooklyn.

By an unfortunate mistake, the address of Carl E. Lipman, manufacturer of a large line of rotary pumps, was given in our advertising pages last week as Beloit, Mich. It should have been Beloit, Wisconsin.

The Autovehicle Company, of Newark, N. J., has secured the agency for the Thomas cars for 1905. In addition, the company will continue to handle the Oldsmobile runabouts and tonneaus.

The Reichert Automobile Co., of New Haven, Conn., has secured, through C. S. Henshaw, New England representative for the Thomas cars, the agency for these cars for 1905.

In connection with its other business, the Spokane Machinery & Supply Co., of Spokane, Wash., is now conducting a general repair and storage station for automobiles.

The Welch Motor Car Co., of Detroit, Mich., has filed notice of an increase of its capital stock from \$50,000 to \$100,000.

The Snell Motor Car Truck Co., of Toledo, O., has changed its name to that of the American Motor Car Truck Co.

THE AUTOMOBILE

WEEKLY

NEW YORK—SATURDAY, DECEMBER 31 1904—CHICAGO

10 CENTS

FEATURES OF LEADING CARS AT PARIS SHOW.

Changes for the Season of 1905 Made by the Foremost Constructors of the World in Frames, Engines, Clutches, Carbureters and Control Systems.

Especially Reported for THE AUTOMOBILE.

PARIS, Dec. 13.—In the multiplicity of exhibits on the stands of the builders of complete automobiles it is not so easy as we might suppose to pick out the most interesting cars. This not only because of the number of those of merit, but because there has come to be a great similarity in general design. The complicated, too, by the presence of many cars in which defects of design and construction develop upon close inspection, where at first glance the fineness of finish and artistic use of color contrasts were the work of houses of high reputation is always of interest, whether

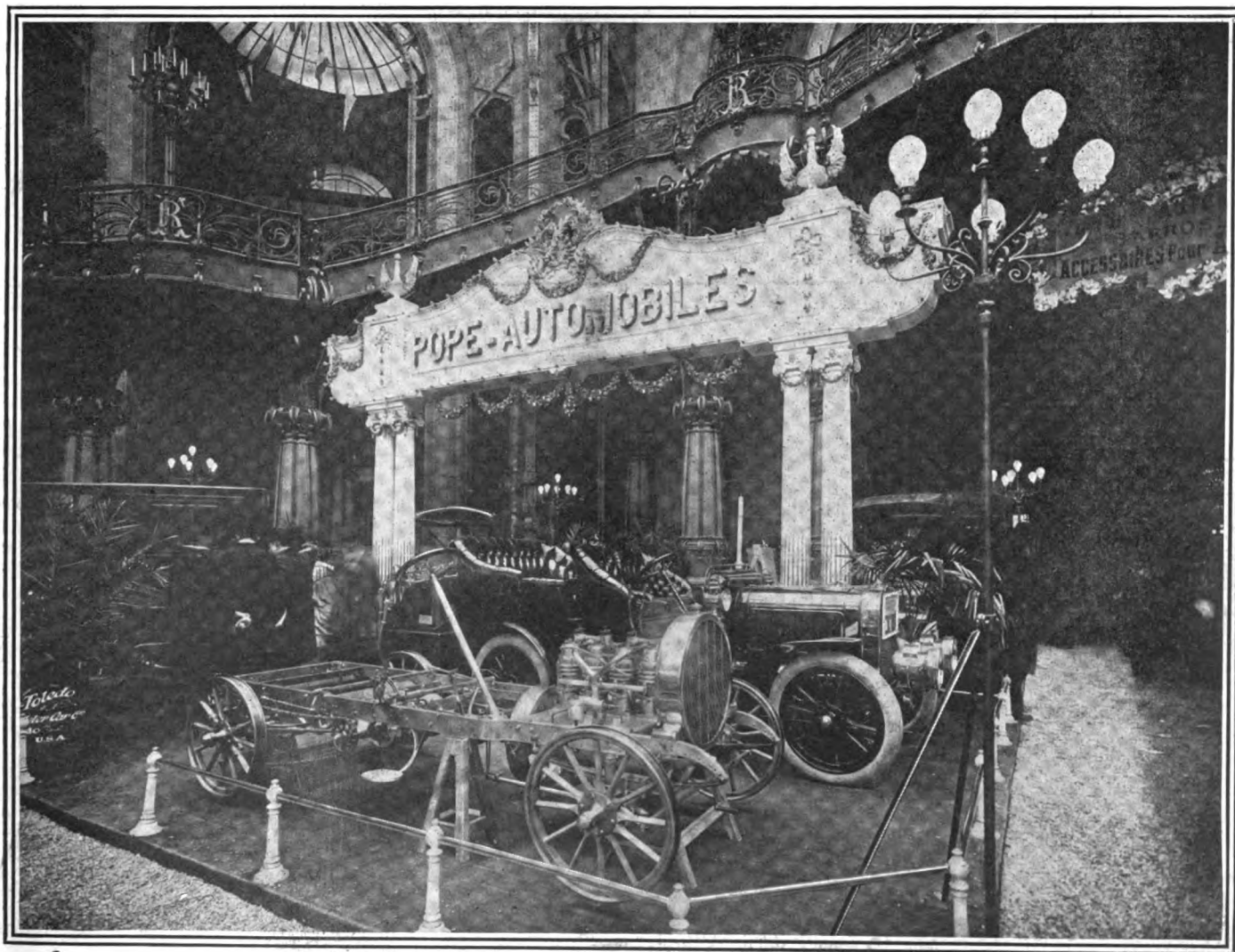

POPE-TOLEDO STAND AT THE SEVENTH ANNUAL PARIS AUTOMOBILE SALON, WHICH CLOSED ON CHRISTMAS DAY.
Chassis of 24-Horsepower Car in Foreground, 45-Horsepower Touring Car in Center Background and 50-Horsepower Pullman at Left Rear

they are old or new comers in this particular field, and to the consideration of the products of some it will be profitable to turn.

Panhard & Levassor show a new 50-horsepower chassis built from their racing experience of the past season, which, although light, since it is below the weight limit for racing cars, is, however, sufficiently strong to carry any type of body that might be desired. The engine, as is usual nowadays with Panhard, has four cylinders, cast separate, with a bearing for each throw of the shaft.

The valves are placed symmetrically on each side of the cylinders, which have cast water-jackets (unusual on a light Panhard engine), the head and cylinder being one single casting. Ignition is by Eisemann high-tension magneto. The Krebs carbureter is used, but instead of the old centrifugal governor heretofore always fitted to the Panhard, a new hydraulic governor is fitted. This governor reminds one very much of the Napier governor, the difference being in greater simplicity and efficiency in the French machine, and also in the fact that on the Napier car it was used to regulate the quantity of air supplied to the mixture in the carbureter, while on the Panhard it is used to actuate the sliding throttle at the carbureter outlet, a work for which it is much better fitted. This governor consists of a diaphragm, bearing on one side the pressure of the water in the water circulation, this pressure being transmitted through a small copper tube from the point of maximum pressure in the water circulating centrifugal pump. This diaphragm, by means of a light rod against a spring, closes the throttle more or less, according to the extent it is deflected by the water pressure. A pedal-actuated accelerator allows the driver to stop or to regulate at his will the action of this regulator, thus permitting the engine to attain any desired speed.

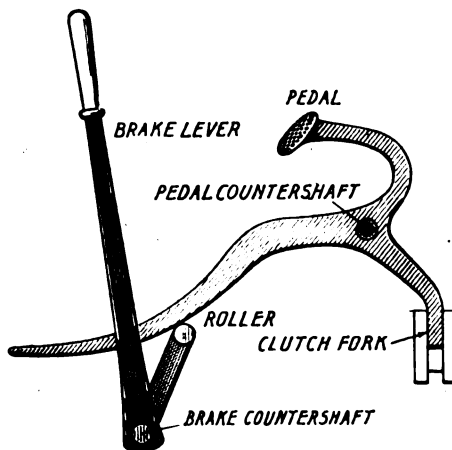

PANHARD CLUTCH PEDAL AND BRAKE LEVER ARRANGEMENT.

The gear-box is the usual Panhard type, except for the differential, which is brought right over to the rear axle, of which it is a component, while the cardan live shaft, instead of being situated between the gear-box and the differential, as is the usual practice, is placed between the clutch and the gear-box, permitting this shaft to be made lighter than would be possible if it were placed in the other portion, since it always has a constant horizontal effort to transmit—that is, that of the explosion, which does not vary, whether the car be on either the high or the low gear.

The car is fitted with two hub brakes, actuated by the side hand lever, which brake throws the clutch out. The foot brake is on the live shaft, and does not affect the clutch. The action by which the hand brake throws the clutch out is very simple and very unlikely to give trouble. The clutch pedal carries a rearward extension, besides the clutch fork. Under this extension is a roller carried by a bracket fast on the hand brake countershaft, so that when the brake is applied, this bracket, through the roller, lifts the extension and withdraws the clutch.

All the pedals on this car are made of stamped steel for lightness.

The engine is carried on an angle iron sub-frame, held to the side members of the frame by means of pressed steel cross pieces.

The frame is not narrowed in front, and deep side members are formed from ordinary stamped steel of very light gauge material, stiffened by an ash cross reach running the entire length of the frame.

The radiator is of the honeycomb type, and is cooled by an air draft induced by a fan, driven by belt from the crankshaft, and by fan blades cast between the clutch and the inside of the flywheel rim.

CLUTCH MADE OF STEEL PLATES.

The clutch, which is one of the most interesting features of the car, consists of a certain number of thin steel plates, made to rotate with the flywheel by means of gudgeons sunk into the latter close to the outside circumference of the plates, which are allowed to slide freely lengthwise on them. Between each pair of these plates is a similar plate, but of smaller diameter, so as to clear the gudgeon pins of the flywheel plates, the small plates sliding on keys on the clutch shaft. When the clutch pedal is in normal position a spring giving only a slight pressure compared to that of the ordinary clutch spring holds these plates together, the great amount of frictional surface thus created being quite sufficient to drive very high powers, while if the pedal is even very slightly depressed, the spring pressure is entirely removed, and the plates, not being under pressure, create no friction, and perfect freedom of the engine is assured.

DE DION ADOPTS SLIDING GEARS.

One of the great novelties of the show, together with this 50-horsepower Panhard, is the new four-cylinder De Dion car, one of the first samples of which has just completed a tour around Europe and has created a great deal of excitement here. The most interesting parts of this car are the engine and the clutch. The frame is made of pressed steel, with tubular cross members, which carry the engine and the change-speed gear. The latter is now of the sliding-gear type by rack and pinion, a system of gears which the de Dion people harshly fought for the past three years, but to which they have come at last. Their great objection to the sliding gear was that it necessitated a main clutch, which was necessarily a more complicated affair than their individual clutch for every speed. The public's objections to the de Dion individual clutches were that they could not be operated by foot, and that for more than two speeds the manipulation was so complex that city driving was becoming an annoyance. Having thus been obliged to adopt a clutch and sliding gear, the de Dion people took the thing very nicely and produced a very fine bit of workmanship.

Their rear axle construction is the same as heretofore; that is, a rigid one-piece

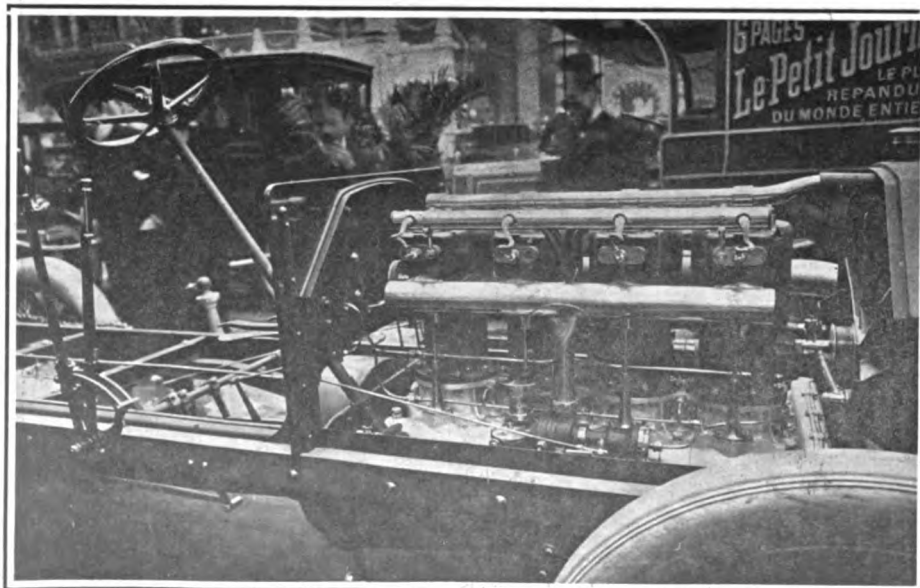

INLET SIDE OF MOTOR OF THE NEW 50-HORSEPOWER PANHARD.

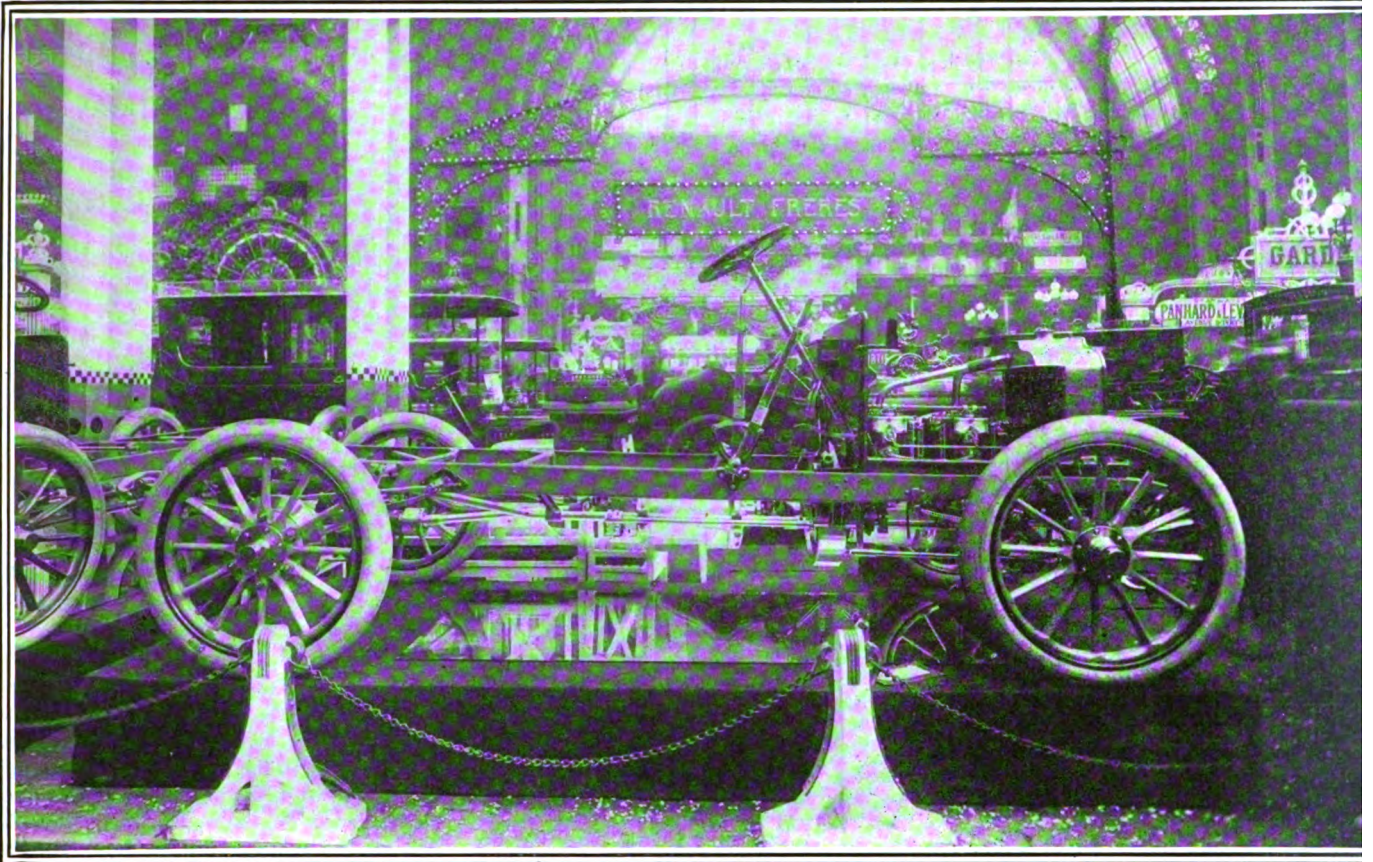

CHASSIS OF 24-H. P. RICHARD-BRASIER, SHOWING NATURAL WATER CIRCULATION SYSTEM—GORDON BENNETT CAR AND TROPHY, IN REAR

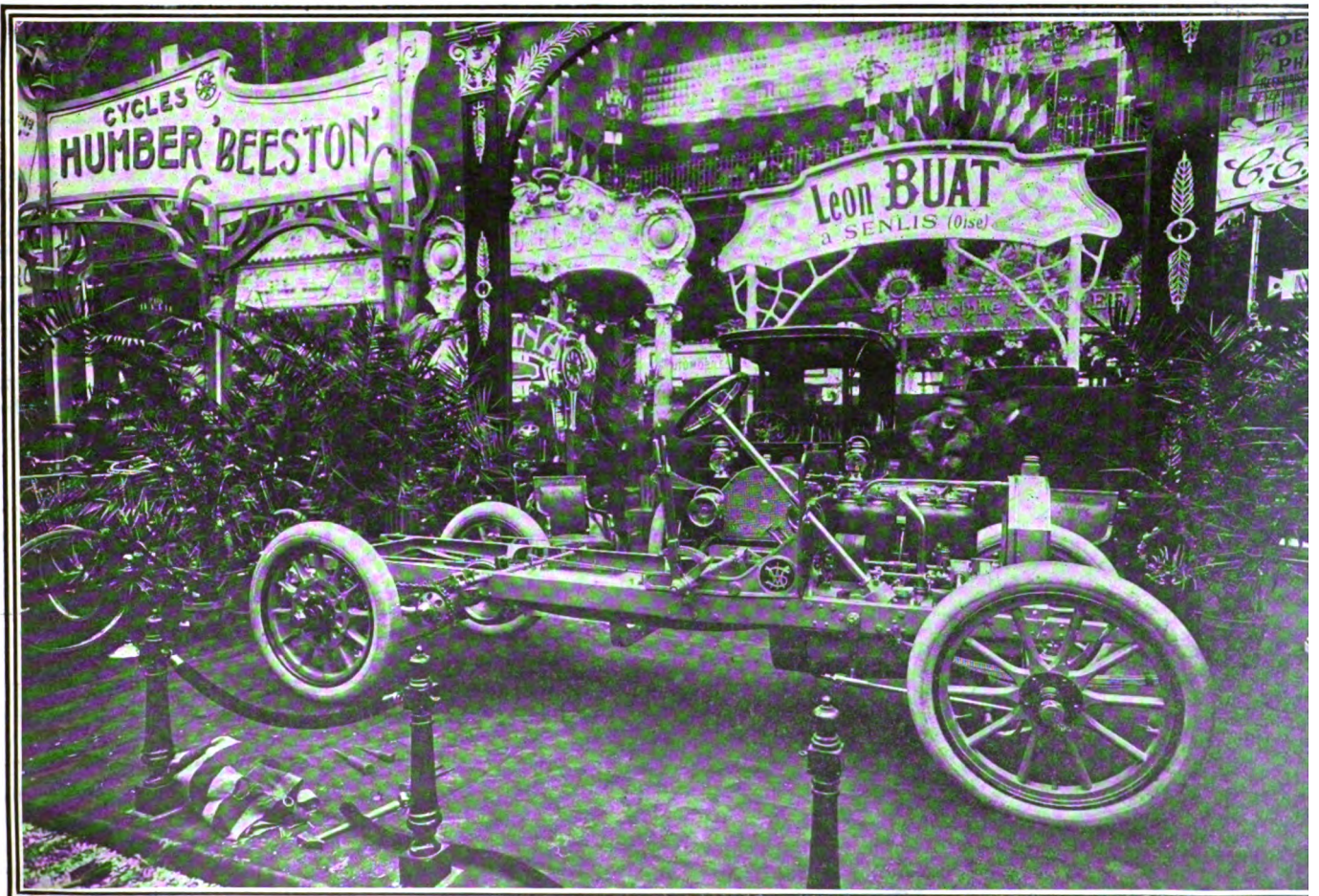

CHASSIS OF THE NEW 24-28 H. P. CAR JUST BROUGHT OUT BY THE FRENCH FACTORY OF THE WESTINGHOUSE COMPANY.

rear axle, with hollow spindles, through which two universal-jointed shafts take the drive to the hubs from a differential suspended on the chassis frame and housed in one casting with the change-speed gear. There are two pedals and two hand levers. The left pedal slows the engine down and then throws the brake on, and when released allows the engine to race and then releases the brake. The right pedal actuates the clutch alone; the reason for not making this pedal also a brake pedal being, according to the builders' theory, that after some wear it will happen that either the braking or the clutch action will have become worn to a greater extent than the other, thus causing irregular working. They, however, made the hand brake to act on the clutch, because, they state, it is merely an emergency brake, and should not be used often enough to cause its transmitting levers and other parts to wear unduly. The second lever acts on the change-speed gear.

FEATURES OF DE DION ENGINE.

The engine of this car has automatic inlet valves, only one contact breaker blade and a high tension distributor, separately cast cylinders and a special starting exhaust cam to release the compression partly. The lower part of the crankcase can be taken off without affecting the crankshaft bearings, a feature now universal in France. The top of the cylinder, but not the valve chamber, is separate, and fits with a screw joint of the type called "autoclave" in France. The pistons are steel and very light. They are fitted with three packing rings at the top for tightness of the explosion chamber, and with a fourth one at the lower part to wipe the excess of oil off the cylinder walls. The crankshaft has five bearings, one for each throw. The valves are of the usual type and disposition, the exhaust valves having the customary variable lift, which, besides being under the

driver's control, is also regulated by a centrifugal governor.

Lubrication is forced by a pump of the gear type, driven from a bevel gear through a coil spring to avoid strains on working parts. Oil is taken from a chamber cast in the crankcase holding enough oil for 400 miles. The oil is thrown to all parts of the crankcase and forced through the hollow crankshaft, from which it returns to the oil chamber, thus causing a constant flow of oil whenever the engine is working.

The carbureter is of the usual de Dion type, with annular float. An improvement has, however, been made, by which the opening or closing of the throttle regulates the quantity of air passing across the nozzle in such a way that this quantity is absolutely constant. This is obtained by spe-

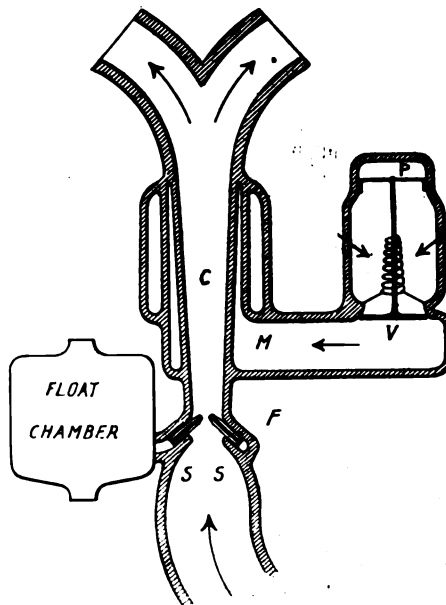

RICHARD-BRASIER CARBURETER WITH OPPOSED FUEL NOZZLES.

cial openings properly cut in one single tubular funnel, used both as throttle and an air regulator.

NEW TRIPLE PLATE CLUTCH.

The clutch is composed of a casing fast on the crankshaft and used as a flywheel, which is practically oil and dust tight, and contains the entire clutch system. The wall of this casing that is closest to the engine bears a friction plate inlaid with cakes of graphite for lubrication; the other side carries six gudgeons and six springs, which press towards the plate mentioned, another plate of a similar type. The action of these springs can be resisted and overcome by toggle levers actuated by the foot clutch pedal. Between the two plates is a third one, which is a plain steel plate fast on the clutch shaft to the change-speed gear. This plate is squeezed between the two others when the clutch is let in, thus causing sufficient friction to drive the car. The graphite is to prevent seizing and to permit a certain amount of slip when the clutch is let in. Ball bearings take up all the end thrusts, and these are all contained in and

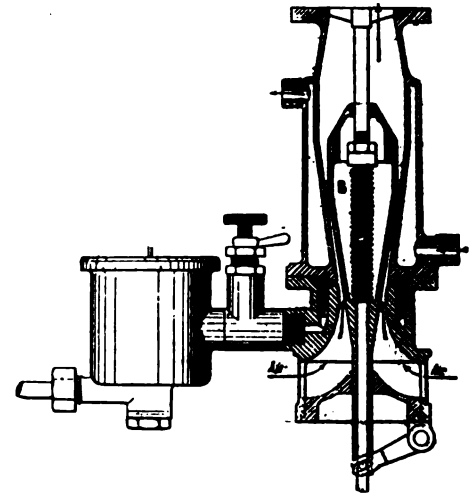

DECAUVILLE CARBURETER, SHOWING AUTOMATIC MIXTURE REGULATING FLOAT.

taken up by the casing, so that none of the shafts is affected by the clutch pressure.

RICHARD-BRASIER COPIES OF RACER.

The Georges Richard-Brasier cars, the sisters of the Gordon Bennett cup winner, are practically reductions of the racing car so far as general engine and gear dimensions are concerned. Some parts which were made very light on the racer have been strengthened on the touring car, but the general design has been preserved. The piston stroke is a little longer in proportion to bore than it was before, the turning speed of the engine being thus 10 per cent slower for the same piston speed.

AUTOMATIC SPARK ADVANCE.

The ignition is by high-tension magneto, with only two positions for the spark timing lever—the starting position, corresponding to a late spark, and the running position, being a slightly advanced spark. The change of time of the spark is automatic. When the starting handle is put in mesh with its ratchet, the spark is automatically retarded, and when it is released, the engine being started, the timing apparatus puts itself in the running position, and the effect corresponding to further advance of spark is produced by the spark, which grows fatter, and thus ignites the charge quicker, as the speed of the engine, and consequently that of the gear-driven magneto, increases.

Except in the 40-horsepower car, the cooling is by natural circulation; in the more powerful type it is by pump. The fan behind the radiator is driven by a large flat belt and is made of spring steel, forged into correctly shaped propeller blades, thick and narrow at centers, and thin and wide at the outer ends.

The exhaust is through very generous pipes into a large muffler at the extreme rear end of the car, and from there into two reed-shaped funnels exhausting right at the contact point of the rear wheels, thus very effectively dispersing the dust. The car is lubricated by a mechanical oiler on the dash.

The clutch is of the ordinary cone type, and the change-speed gearing, which runs

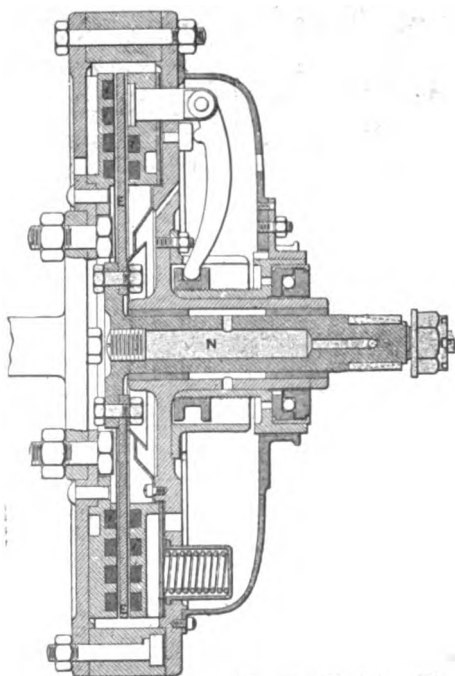

From *La Vie Automobile*.
SECTION OF THE NEW DE DION CLUTCH.

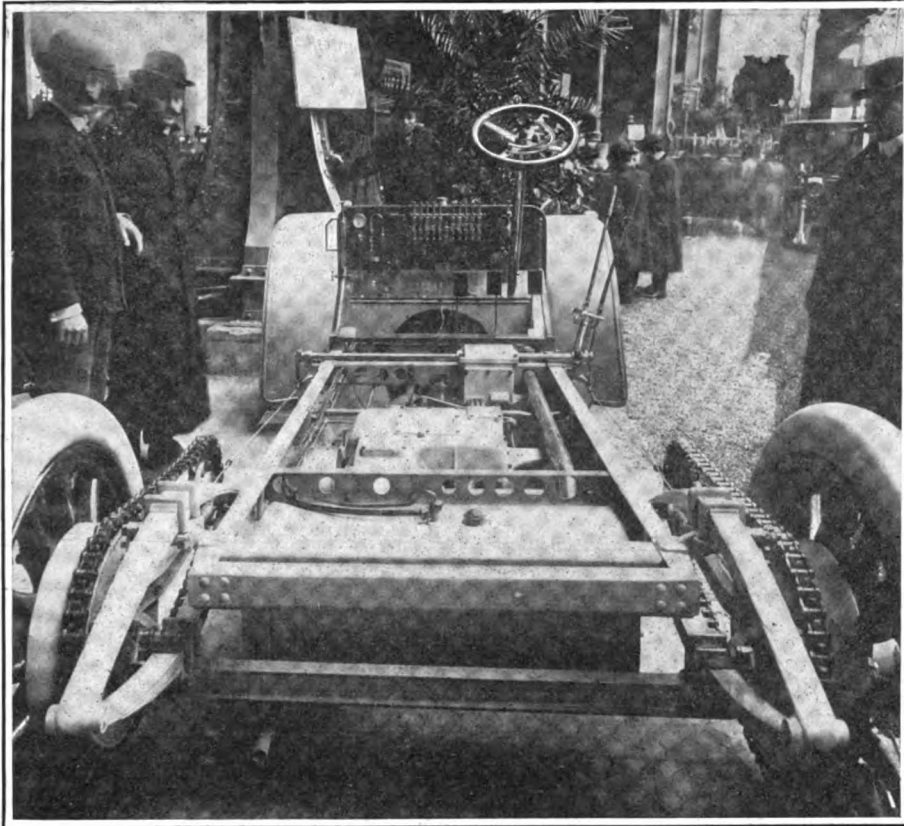

REAR VIEW OF 1905 MERCEDES, SHOWING LONG CHASSIS AND DOUBLE ELLIPTIC SPRINGS.

on balls throughout, is of the sliding gear type. The mechanism is carried on a tubular sub-frame, the frame proper being of stamped steel. The axles are an exact copy of those on They's car.

RICHARD-BRASIER CARBURETER.

The carbureter is of the Brasier opposed jets type. The float chamber communicates with a fuel chamber *F* surrounding the base of an inverted cone *C*, in which the suction of the engine takes effect. Penetrating the cone from the fuel chamber are two sprayers *s s'*, inclined at an angle toward each other, much like the gas jets in an acetylene burner, so that the spray of each breaks the other, thereby forming a large surface of liquid.

The latest addition to this carbureter is the new automatic extra air valve *V*, opening from outside into a chamber *M*, surrounding the spray cone for about three inches, and opening into same through long vertical slots. The characteristic of this valve, which resembles very much an ordinary inlet valve, is that it carries on top of its stem a small spun-brass piston, which is almost a fit in a small closed cylinder. Thus, when the suction of the engine at high speeds tends to open this valve, it is kept from moving too rapidly and spasmodically by the air cushion behind its regulating piston, past which air can only escape very slowly.

CHANGES IN THE SERPOLLET STEAMER.

Another great novelty brought out by an old concern and exhibited at the Salon is the new Serpollet steam car. As far as outside appearances are concerned this car has

now exactly the same look as a gasoline car. The radiator and hood are of excellent design, and enclose the engine and water tank.

The engine did not undergo any changes, but the boiler is reduced in size, and the fuel and water feed are now forced by a small donkey engine as large as a man's hand, which, being controlled by the driver, exactly proportionates the amount of water and fuel sent to the boiler.

NOVEL CARBURETER ON THE DECAUVILLE.

Among the modern cars of well-known make the Decauville retains the characteristics of last year, the main change being in the carbureter. Leaving out the minor details, such as warming chamber, float, etc., to come to the spray chamber, this is seen to have the shape of two cones united at their bases and flushed together by an easy curve. At the base is a circular slot *A A'*, through which the gasoline can spray towards the center of the chamber. This large spraying surface is itself a notable feature, but what is most novel about this apparatus is the olive-shaped spun-brass hollow body *B*, which is held by guides in the center of the chamber. This air-float can be made to operate in two ways; if it is perfectly free to rise and fall it will be in its normal position as close to the walls of the spray chamber, near the sprayers, as the guides will allow, leaving the passage for the air

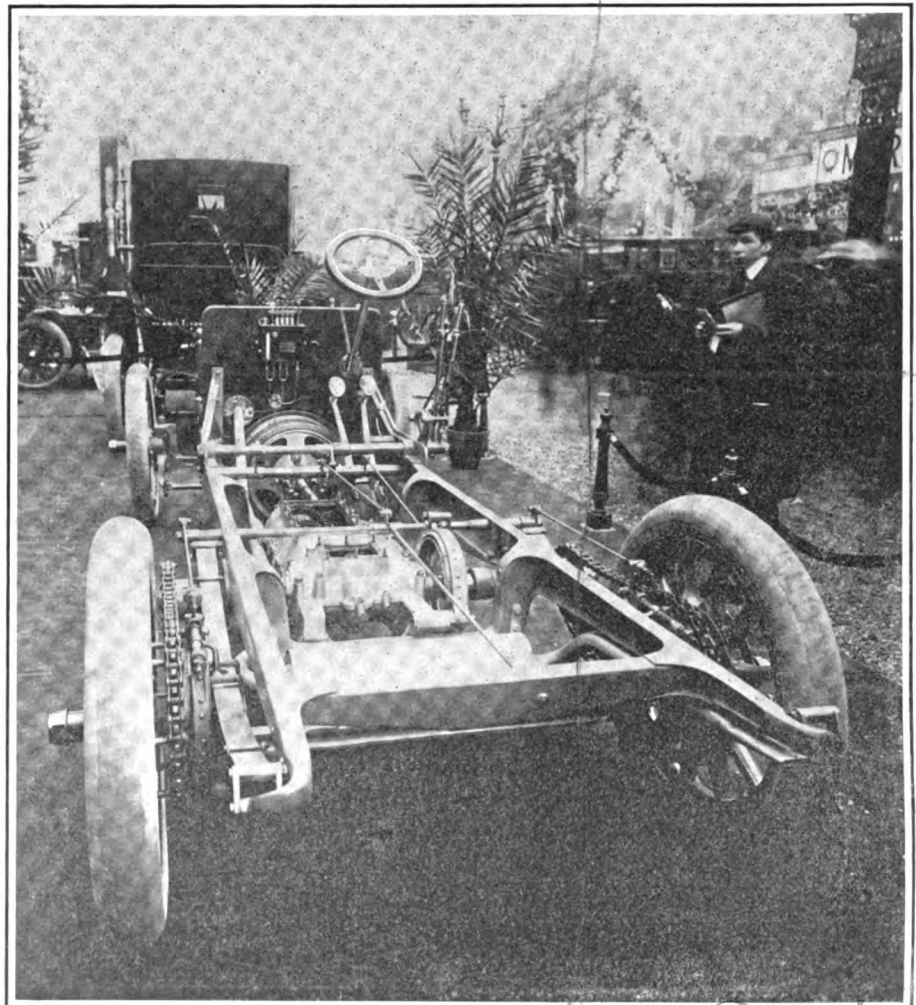

REAR VIEW OF WESTINGHOUSE 24-28-H.P. CHASSIS, SHOWING TRANSMISSION SYSTEM.

very small, while the jet of fuel induced by the powerful motion will be very strong. If the engine now starts revolving at high speeds the motion will be still more powerful, and the olive-shaped piece, being very light, will be lifted until balanced in the current of gas, increasing the space between this float and the walls near the sprayer, and reducing the quantity of air passing in direct contact with the nozzle, so that the quantity of fuel is reduced in proportion to that of air. If a spring is interposed to regulate the motions of this movable piece it will give a constant carburation. The Decauville people found, however, that they could obtain still better results by actuating this float by means of the engine governor, and they connected the lower part of the

to the minimum; when pushed away, it leaves the engine under the control of the driver's special operating lever, so that the driver is allowed to race his engine, if he so desires, with his clutch pedal depressed, as well as with it in engagement.

We again find in this car that the foot brake does not throw the clutch out, but that the hand brake does.

One of the features of the Mors is the lubricating system. Instead of the usual forced-feed oiler on the dash, the car is fitted with a small gear pump without direct drive, but having on its projecting shaft a ratchet wheel that is rotated slowly by a pawl operated by the lifter of the inlet valve of the last cylinder.

There are two foot brakes, neither of

hard is considered the best heavy car. There is, however, no startling change in its construction for next season.

The Renault builders have adopted the pressed steel frame and, as every one knows, the natural cooling system.

BALL BEARING CRANKSHAFT IN HOTCHKISS.

Passing now to the three new cars which were the surprise of the year, we will find in the Hotchkiss, the Westinghouse and the Delaunay-Belleville cars a worthy conclusion for this study. The Hotchkiss is the French car which made the quickest success here. Launched less than a year ago, it is now one of the great French makes.

The Hotchkiss company has from the start been the champion of the ball bearing;

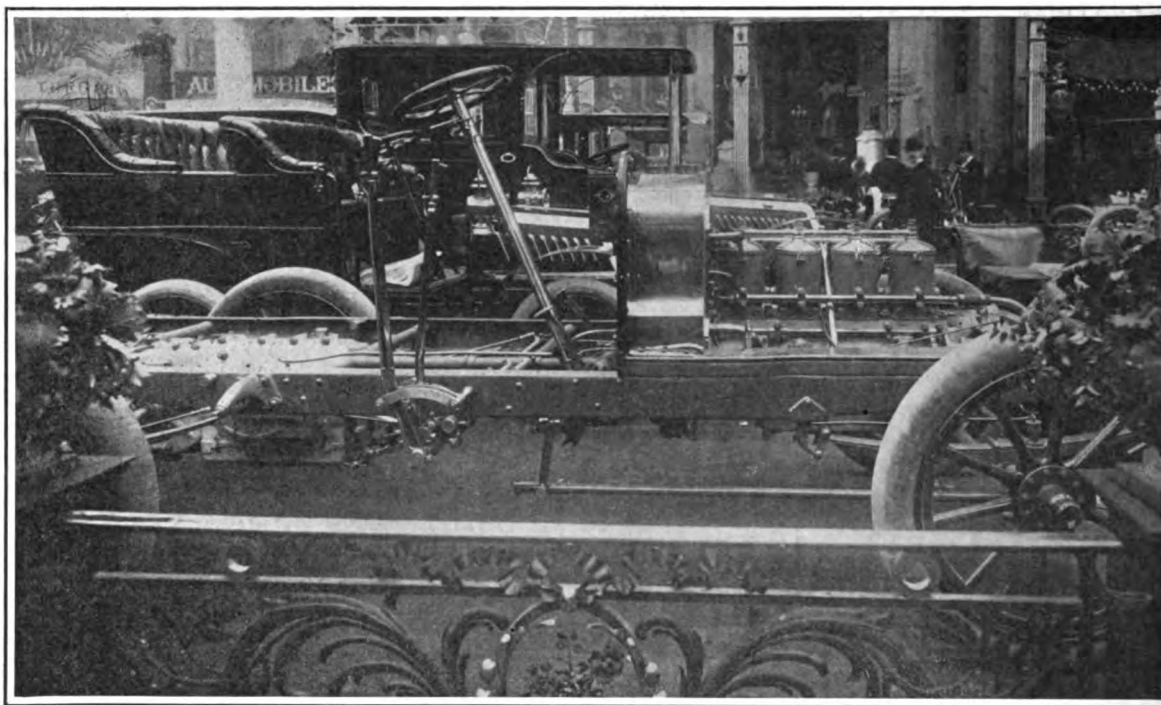

CHASSIS OF THE 15-HORSEPOWER DE DION, WITH RADIATOR AND WATER TANK BETWEEN MOTOR AND DASH.

olive to a bell-crank lever leading to the governor collar.

FEATURES OF THE MORS.

Another car which underwent important modifications for this season is the Mors. In the engine the cylinders are cast by pairs, instead of individually, which fact is, if compared with many other firms, a step backwards; at the same time the separately cast aluminum jacket, which was a characteristic of the Mors, has also disappeared and is replaced by an ordinary cast jacket. The lower part of the crank-case is detachable, for inspection of the bearings without disturbing the latter. The engine is not fitted, any more than it was before, with a governor, but the complicated wire system by which the speed of the engine was automatically cut down when the clutch was out has been suppressed, and instead the dashboard carries a long square taper steel rod, coming about to the height of the driver's knee and having a wooden handle. This rod, when pulled full forward, reduces the speed

which operates the clutch; one is an external brake on the hubs and the other an external brake on the countershaft, while the hand brakes expand inside the wheel hub drums.

It is claimed that the steering gear of this car cannot possibly develop lost motion, as very powerful springs are interposed near the worm and sector, and keep one closely in contact with the other, so that if when turning to the right, for instance, the screw pushes down direct on the teeth of the sector, when turning to the left the spring will still keep the teeth of the sector against the worm, and the motion of the wheels will be obtained through the power of the spring, and not by the lifting action of the other side of the thread of the worm. It will thus be readily understood that while one turns to one side very easily, being assisted by the tension of the spring, it must be much harder to turn to the other, as there is the resistance of the spring to overcome.

The Renault car is considered by many here as the best light car, just as the Pan-

there is not a working bearing in its car except on the connecting rod which is not on balls; the crankshaft itself, with its three bearings, is on balls, and so far the arrangement has given satisfaction. The crankshaft of the engine of the Hotchkiss auto boat with the bearings is shown, and it is absolutely impossible to find the least play in it, while a mere touch of the finger sets the big shaft and flywheel revolving.

Besides this characteristic, the car has a Mercedes type ignition and a very noticeable change-speed, by which it is possible to start the car on the low gear and jump straight to fourth without passing through the two intermediate speeds. This change-speed is also notable because of its suspension; instead of being held on the two side-frame members, is carried by its ends from the cross members made of pressed steel.

WESTINGHOUSE A FINE CAR.

The Westinghouse car, although a beautiful sample of workmanship and a marvel

EXHAUST SIDE OF 50-H. P. PANHARD, SHOWING WOOD AND PRESSED STEEL FRAME.

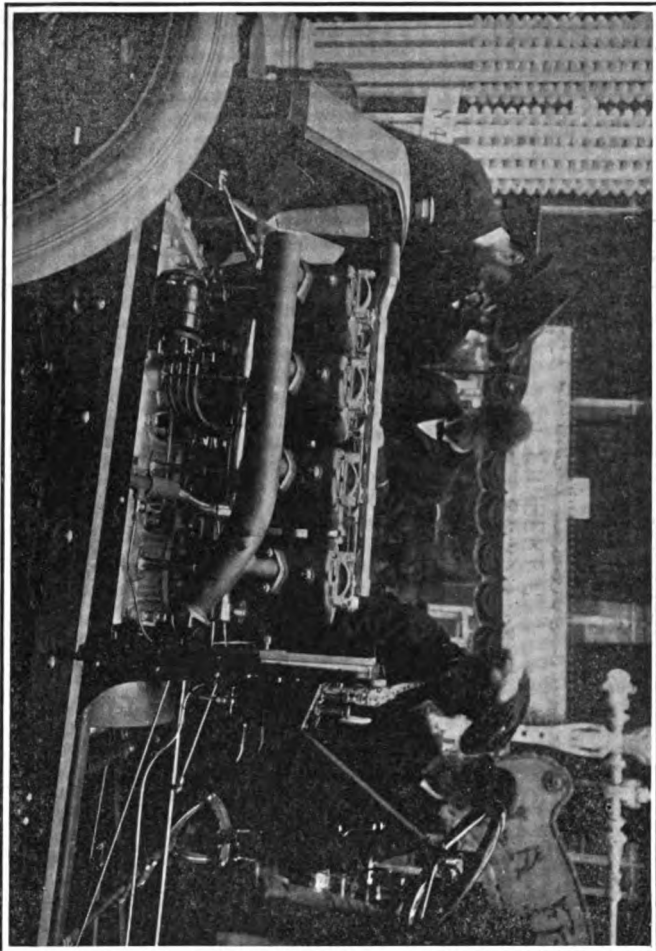

EXHAUST SIDE OF WESTINGHOUSE CHASSIS, SHOWING CRANKCASE RELIEF TUBES.

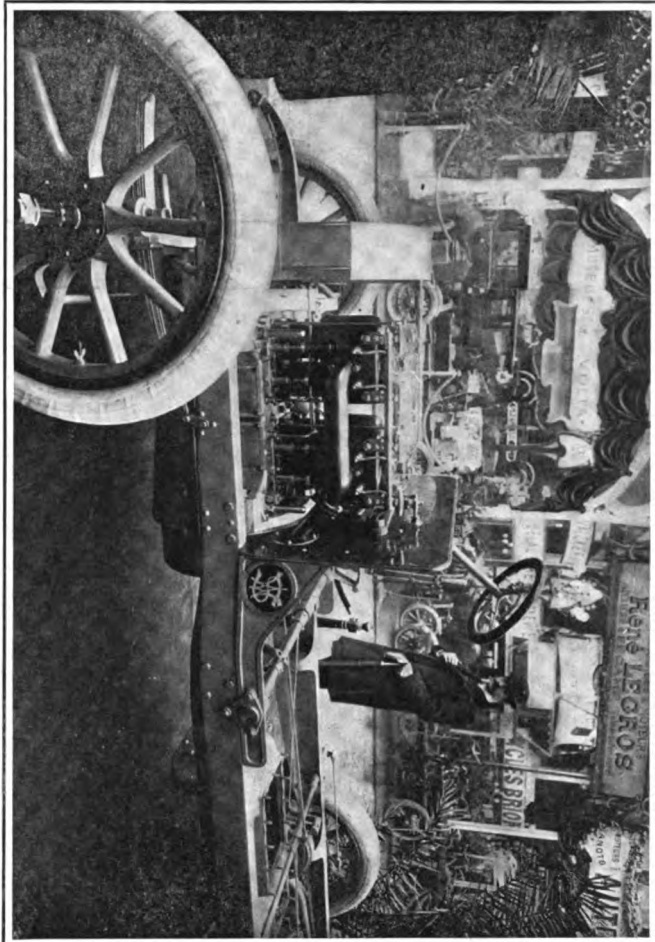

INLET SIDE OF HOTCHKISS ENGINE WHICH HAS BALL-BEARING CRANKSHAFT.

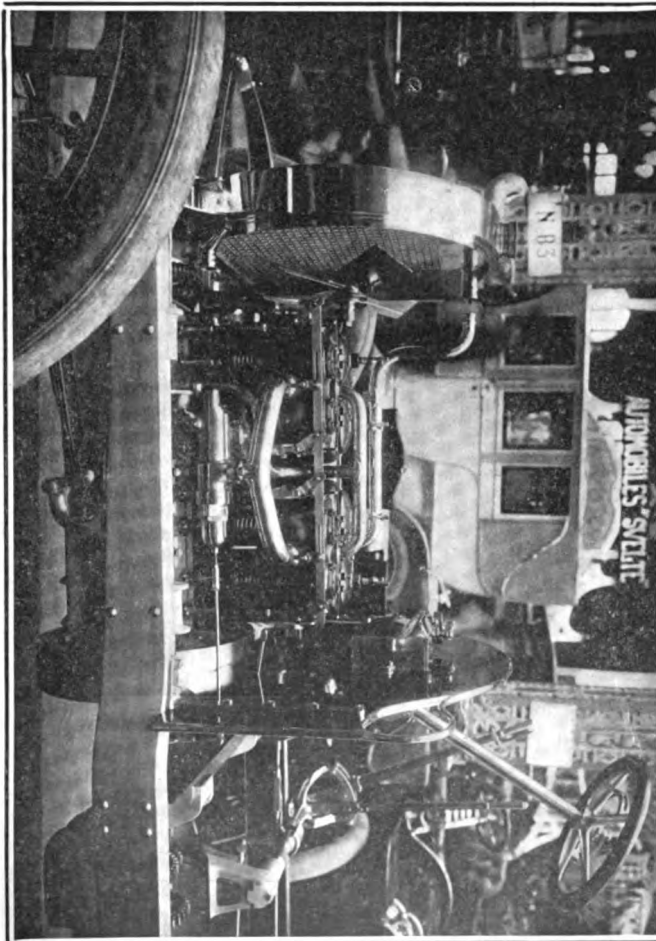

INLET SIDE OF WESTINGHOUSE ENGINE, SHOWING DRIVE FROM WATER PUMP TO MAGNETO.

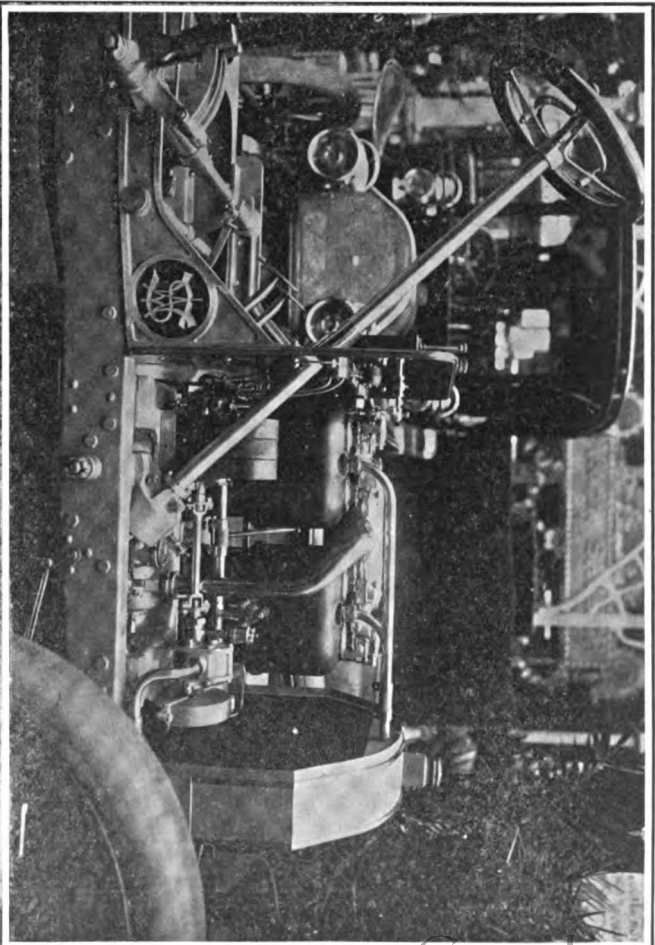

of powerful simplicity, is not a surprising exhibit of mechanical departures. It has a 24-28-horsepower engine with two sets of twin cylinders. The inlet valves on top of the cylinders are mechanically operated by tappets from the same camshaft as the exhausts, which are of the usual type. The ignition is by high-tension magneto. The governor, which is enclosed in the crank-casing, acts upon a piston in the carbureter, which is automatic. A foot accelerator can stop the governing action. The water is circulated by a gear pump and cooled by a honeycomb radiator. The clutch is of the cone type, self-contained as to end thrusts;

The engine is about 30 horsepower, with four cylinders and symmetrical valves on each side of the cylinders, both mechanically operated. The ignition is by low-tension magneto. The water circulation is by centrifugal pump, and the engine is lubricated by an eccentric pump without either checks or valve, giving two atmospheres of oil pressure to all bearings, even the connecting rod knuckle on the piston pin. This pump has been applied on steam engines for many years by this concern, which considers it one of the best features of the car. The radiator is ventilated by a fan with a spring jockey pulley. The carbureter is

a sub-frame. The entire chassis is of pressed steel made entirely at the Belleville works. A large and perfectly enclosed apron covers the entire mechanism most efficiently, being practically dirt tight. The dashboard does not exist, its place being taken by the gasoline tank of roughly twenty gallons capacity, while the entire water supply is carried in the radiator.

One small point which goes to show the carefulness of design is the interposition of fiber pads between the springs and the spring blocks, to add to the life and ease of the springs.

The knuckles of the front wheels are of

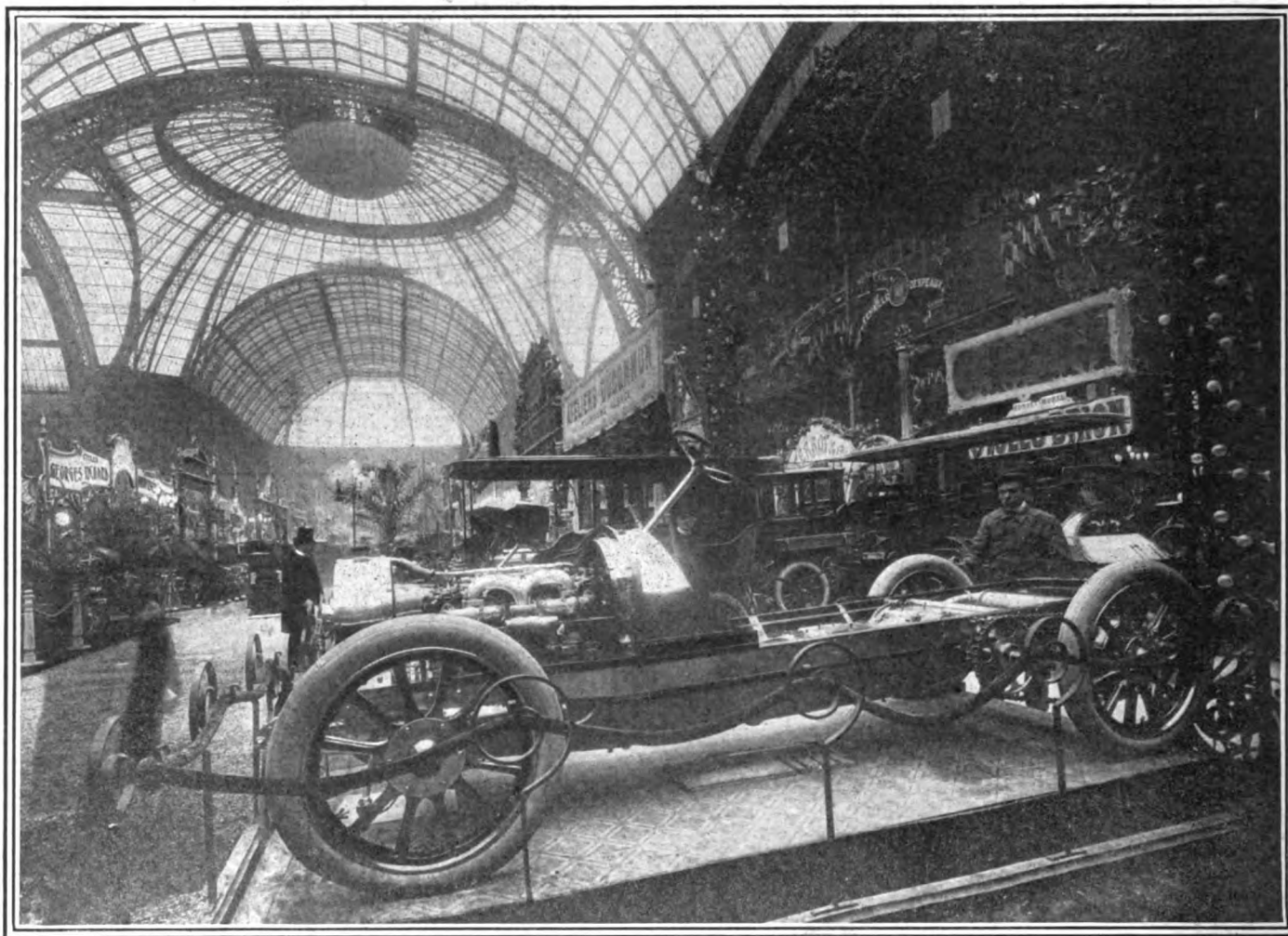

CHASSIS OF THE DELAUNAY-BELLEVILLE, AN INTERESTING NEW FRENCH CAR, SHOWING FULL LENGTH DUST PAN UNDER FRAME.

the spring is easily getatable and removable, and the whole clutch is on a separate shaft easily removed from the car. The frame is stamped steel. There are four speeds and reverse and ball bearings throughout, except at crankshaft. Both hand and foot brakes act on the rear wheels, the hand brake being on the hubs and the foot brake on the chain shaft.

DELAUNAY-BELLEVILLE MAKES A HIT.

Another great engineering concern is the Delaunay-Belleville, the well-known boiler and steam engine makers, who this year start into the automobile trade by making a tremendous hit, having in all respects one of the finest cars at the show.

automatic and somewhat similar to the Mors and the Richard-Brasier as to the means of supplying extra air. All the articulations and all the levers are joined by ball joints, thus giving the connections great ease, as well as great security.

The car is fitted with two brakes, both acting on the clutch, a foot brake acting externally on the countershaft and an internal hub brake operated by the hand lever. The clutch is of ordinary cone type, the cone being made of aluminum to decrease its momentum and facilitate the change of gears, of which there are four, besides the reverse. The engine is carried on the frame direct, while the transmission is carried on

the Mercedes type and are protected by sheet-metal covers, making them mud proof.

The other cars shown, which are of minor interest, but in which many small details of interest are to be found, will be discussed in a subsequent letter.

No doubt the enormous proportions which the automobile industry has assumed in France accounts in a large measure for the fact that of the world's total annual production of rubber, amounting to about 50,000 tons, one-eighth, or 6,250 tons, is consumed by France. Brazil alone exports 30,000 tons annually, and France took one-fifth of this last year.

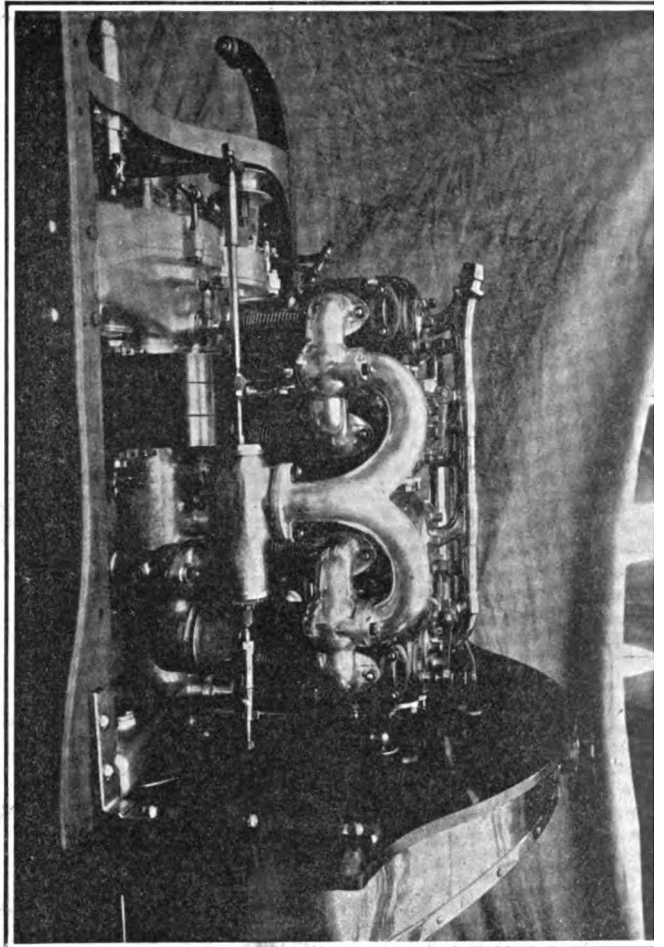

INLET SIDE OF DELAUNAY-BELLEVILLE ENGINE, SHOWING HUGE SWANNESE INTAKE PIPES.

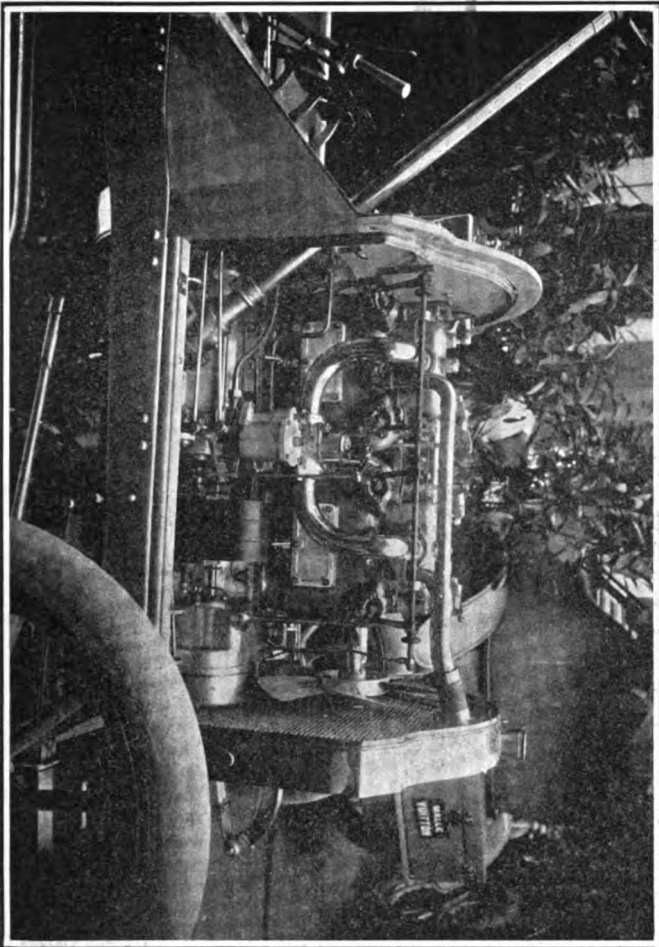

INLET SIDE OF NEW DAIMLER ENGINE SHOWING IGNITION SYSTEM.

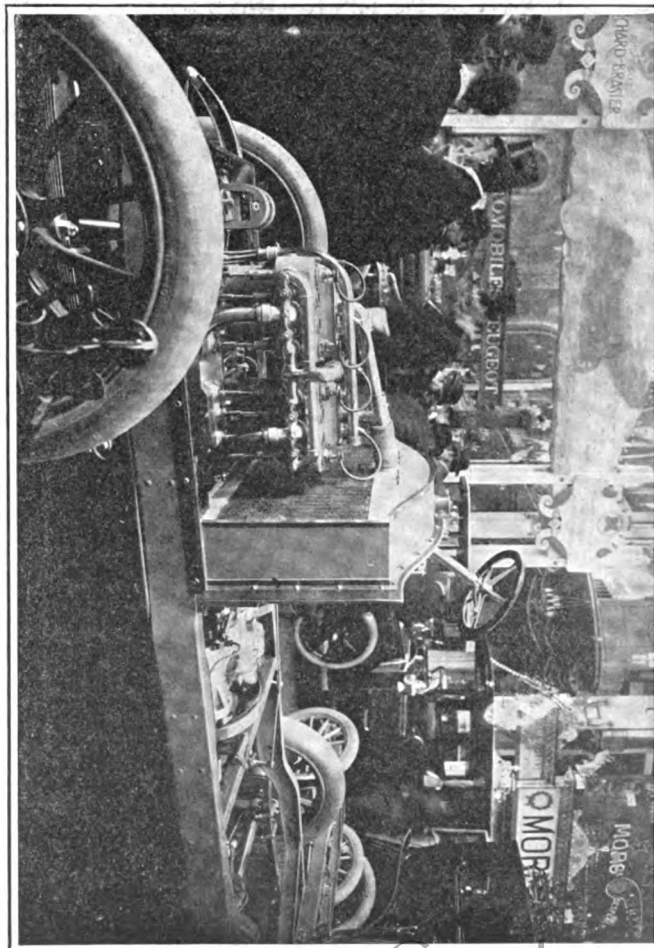

VALVE SIDE OF 15-18-H.P. RENAULT, SHOWING DASH RADIATOR AND WATER CONNECTION.

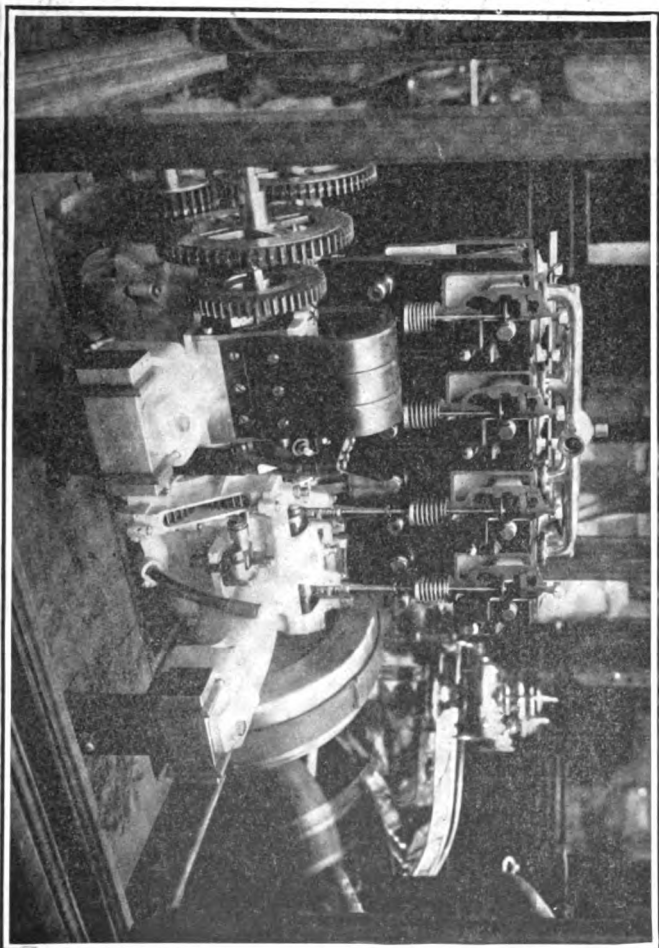

SECTIONED FULL-SIZED C. G. & V. MOTOR IN GLASS CASE, DRIVEN BY ELECTRIC MOTOR.

American Car Exhibits in the 1904 Salon.

Special Correspondence.

PARIS, Dec. 16.—One of the features of the 1904 Salon is the exhibit of American cars, which, though few in number, are of high quality and draw crowds of spectators. The exhibits are those of the Pope-Toledo and Pope-Waverley cars on one stand and the Oldsmobiles on another, both having good positions in the main hall. Colonel Pope has been accused of bringing coals to Newcastle, but the coals are certainly of very good quality, and with the history of the Vanderbilt race fresh in their minds the French visitors "take notice." The

Pope bicycles, which are shown by the local agents.

The Pope vehicles attract a great deal of attention, and seem to promise good business for their makers, the prices being comparatively low considering the size of the cars. The company seems to have foreseen this success, as it has brought over a fine assortment of cars. First of all is a magnificent 50-horsepower Pullman car, lavishly upholstered and beautifully finished, which is second to none in comfort. This car, which is to be shown at Madison

any one as being very smart and likely to match with success the richest bodies for city use. This radiator has the shape of an oval, which suits nicely the special aspect of the water tubes of the Pope cooler. H. L. Pope and H. A. Leinhart, of Hartford, answer the inquiries of the public at the stand and seem to be pleased with things, while H. H. Lyttle, when not at the stand, demonstrates to prospective buyers one of the famous 24-horsepower Pops, which was brought over for the purpose.

The Waverley electrics are also very well represented at the same stand by a physician's carriage, a stanhope, a chelsea and a runabout.

At the Olds stand all the latest styles of



GENERAL VIEW OF OLDSMOBILE STAND AT PARIS SHOW.

Runabout in foreground has glass panels in piano-box body and engine is kept running by electric motor on floor under car.

exhibit of the Oldsmobiles is made by Fournier, the French agent of the builders, and there is largely a French atmosphere about this stand. The Olds is a good deal in the eye of the automobile public just now, as Maurice Fournier is making a tour of Europe in an Olds. One of the cars at the stand is labeled as identical in pattern with that used on this special tour.

The Pope exhibit is made in a large stand—in fact, it has been allotted a much larger space than many of the well-known French firms, and it is attractively decorated with an arched white and gold sign, bearing the name of the company in incandescent lamps, and by various potted plants. Just across the aisle is the stand of the

Square Garden, has been described and illustrated in *THE AUTOMOBILE*. It is a matter of interest here that, although it carries such a long body, it can go at a pace of almost seventy miles an hour in case of emergency.

A very roomy touring car is also shown with a 45-horsepower chassis. It has a side entrance and large seats, and as an open car is a fine sample of a comfortable body. Another very nice type of body is the front entrance tonneau fitted on a 20-horsepower chassis.

A 30-horsepower chassis is exhibited polished up and arranged to show the mechanical features of the Pope cars. It possesses a radiator of a new shape, which strikes

Oldsmobiles are shown, with canopy top, front glass and wheel steering. The new runabout and the still young ancestor, with the sledge front and lever steering, are also shown. One model is shown with glass panels to allow the public to examine the machinery.

Although America did not send many representatives, those that came are worthy ones, and the American colony here, as well as visiting American automobilists, have good reason to be proud of their builders.

Does Newlywed get much pleasure out of his auto?

Oh, yes. His wife doesn't know he's got it yet.—*Judge.*



MAKING PREPARATIONS IN THE RIVER SEINE FOR THE AUTO BOAT RACES HELD DURING THE PARIS AUTOMOBILE SALON.
On the right is the Serres de la Ville, a building erected for the World's Fair of 1900 and now used as an annex to the Grand Palais for exhibits of Auto Boats, Machinery and Commercial Motor Vehicles.

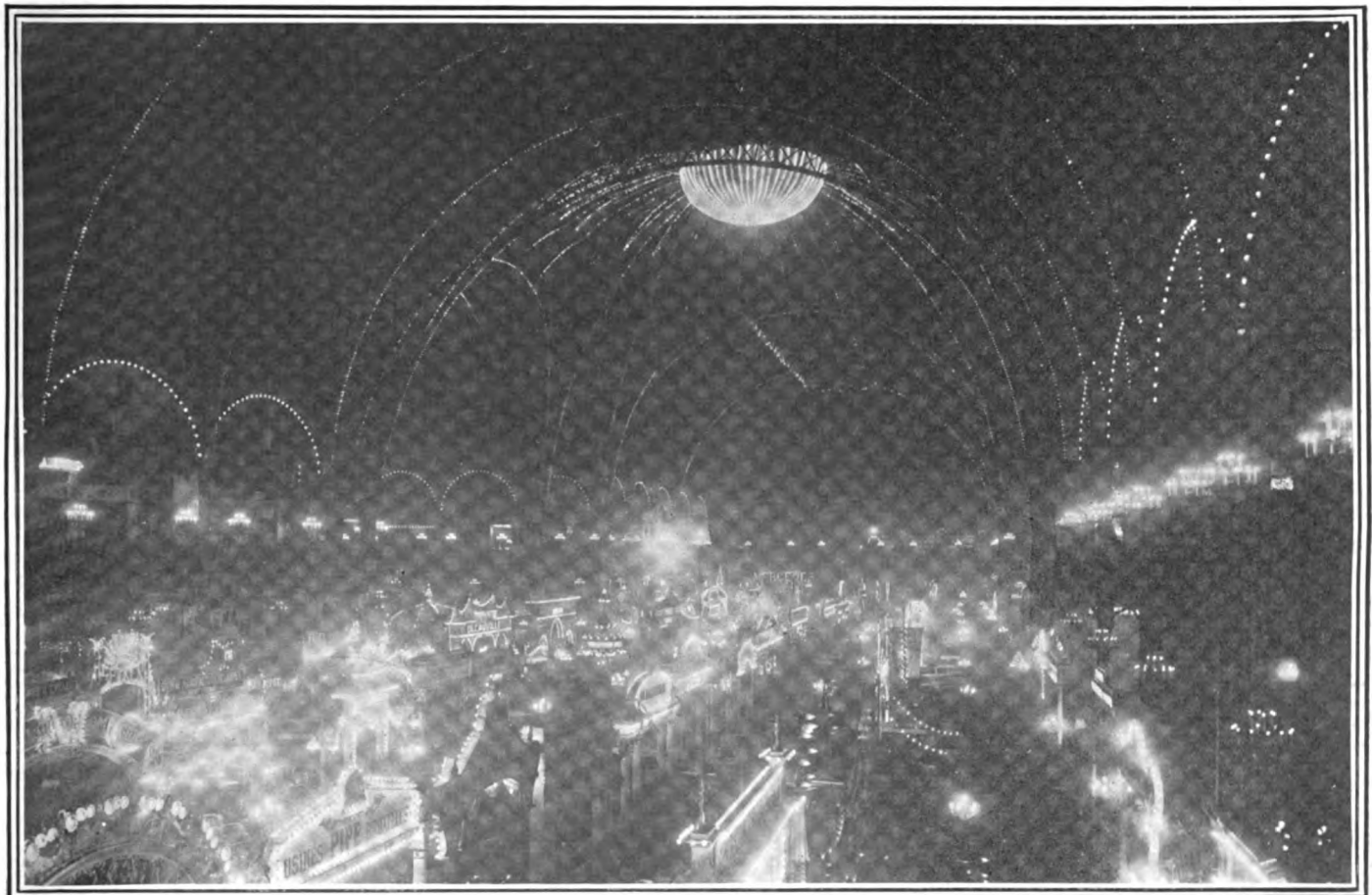

NIGHT ILLUMINATION INSIDE OF THE GRAND PALAIS DURING AUTOMOBILE SALON, DECEMBER 9 TO 25. LOOKING DOWN THE MAIN HALL.
Note skyrocket effect of arched lines of light radiating downward from central dome.

Convenience and Comfort in Show Cars.

Especially Reported for THE AUTOMOBILE.

PARIS, Dec. 16.—There is a remarkable one cannot but be struck with the fact that enormous advance has been made in all that tends to make touring a luxury. The average automobilist is satisfied with the speeds already attained and now seeks perfection in strength of construction, ease of control and immunity from breakdown. The outcome of this demand for more comfortable cars is that chassis are increased in length. Many cars are shown with wheelbases of upwards of ten feet. At the same time it is admitted everywhere that cars have reached their limit in length, the advantage gained by a long wheelbase being more than counterbalanced by the difficulty in turning on winding roads, climbing awkward hills, or moving about in city traffic. In order to overcome—partially, at any rate—this difficulty, nearly all the 1905 models are built much narrower at the fore axle than at the rear.

Another very general move is towards springs of increased length; the old short springs, which meant bumpy riding, have almost entirely disappeared. Some makers have, in addition to the two front and two rear springs, a third spring, placed transversely across the rear of the chassis. This is the case in the Delaunay-Belleville and in the new model of the Mors 40-52-horsepower chassis, a splendid piece of mechanical construction. The brake power has also been increased on the Mors chassis, the braking system now consisting of compensating pedal brakes on the rear wheels (the pedals being so arranged that both can be operated by one foot) and a hand brake acting on the differential, the braking surface of which has been largely increased. M. Charley, of the Mercedes firm, has adopted the American idea of a compressed air brake, which by means of the movement of a lever on the steering wheel will apply power to two brakes on the front hubs and two on the rear hubs.

Steering pillars have been given a little more rake. On the Pope-Toledo cars the steering wheel is hinged, lifting up to allow the chauffeur to reach his place more conveniently. On the Clément cars the spark and gas are regulated by turning two sectors placed in the circumference of the steering itself, and on another car the spark and throttle were controlled by an extra spoke in the wheel.

There appears to be a tendency to increase the size of the gasoline tank on touring cars. In the new Westinghouse automobile it has been placed right at the rear of the chassis, as in the Mercedes pattern. In the Delaunay-Belleville the gasoline tank, having a capacity of about seventy-five liters, is placed behind the dash, under the sloping footboard, the polished wood and brass dash and the circular bonnet giving this car a very smart appearance.

The complete dust pan of the Delaunay-Belleville, extending right up to the rear axle, is claimed to be most effective in keeping down dust. Exhaust pipes are bigger and radiators generally larger than in previous years' models. It is observed also that on all the larger cars there seems to be a tendency to substitute the running footboard for the hanging step.

A PARLOR SLEEPING CAR.

Luxurious traveling cars constitute an important feature of the show. Probably the most completely fitted automobile ever built is one shown at the de Dietrich stand. The interior of the car is divided into two parts. In the fore part are four armchairs, two of which are fixed, while two are of the railroad revolving and reclining

On the opposite side of this little cabin is an ice-chest, a cupboard for photographic appliances, a wardrobe, a small cooking range heated by spirits, a drawer for table linen and a chest for food and table service. This little room has also been so arranged that it can be closed up to serve as a dark room.

A LUXURIOUS CANOPY-TOP CAR.

At the Decauville stand a most luxurious 24-28-horsepower covered phaeton touring car is exhibited. It has a wheelbase of 110 inches. There are roomy side entrances, and the rear seat will hold comfortably three persons. An extra seat is fitted in front of this; it is in two parts, a padded back extending the full width of the car, fitting into grooves at each side of the canopy supports. When not required this back is slid up in its grooves until it reaches the canopy, when it is turned and held secure in longitudinal grooves close

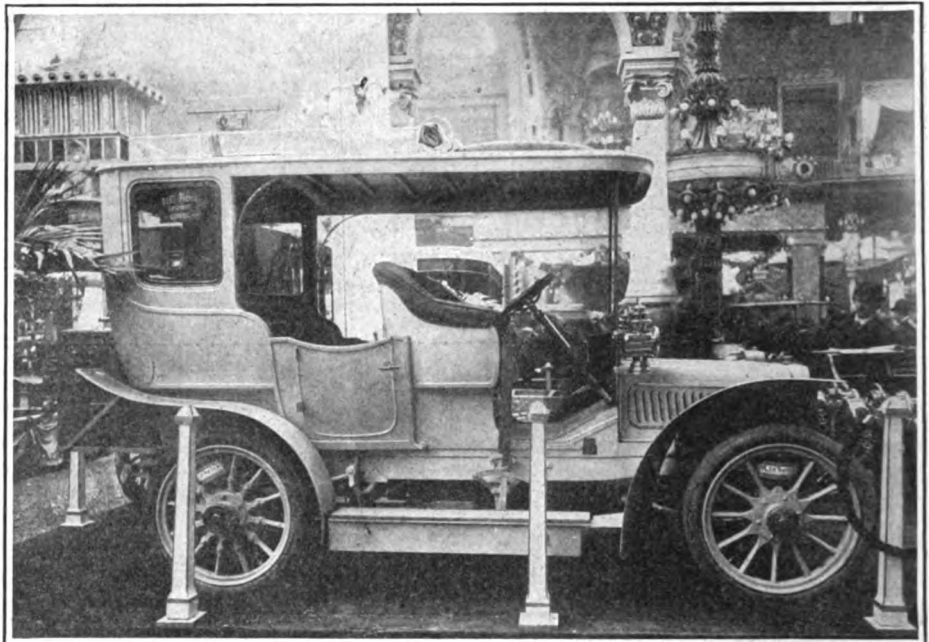

DECAUVILLE DOUBLE PHAETON, WITH SIDE ENTRANCE AND FULL BACK.

Emergency seat lifts up from floor in front of rear seat and back for this seat slides down from under the roof in side slots. Note large tool-box under side step and special luggage boxes strapped on shelf behind.

type. They are so disposed that two chairs can be brought together, the backs lowered so as to make a couch and a mattress unrolled out of the back of one. Two folding tables, which are completely hidden away when not in use, can be opened out for reading or card playing. At the head of each reclining chair there is a small electric lamp, and hidden away in different parts of the room are pockets for note paper, cards, a revolver, medicines, and other small articles. A double folding door with richly carved panels communicates with the rear portion of the car. Here, in a space of 1 meter 50 centimeters by 80 centimeters, the designer of the car has found space to fix up a wash basin with water supply, a toilet table with three mirrors and a seat, a closet flushed automatically, a linen cupboard and a wardrobe.

to the roof. The seat is hinged, and when not in use is folded down behind the front seats. It is entirely out of the way, its supports fitting into grooves in the floor boards, and the whole can be fitted up or stowed away in a moment. The canopy extends right over the driver's seat. The rear and sides of the car are closed in and fitted with windows letting down into pockets. The whole of the sides of the car can also be covered in by means of shades fitted on rollers under the canopy top. There are running-boards fitted with rubber mats bound with brass, which form the lids of very spacious tool boxes. Ample provision is made for carrying luggage. A rail runs round the sides and back of the top, allowing a trunk to be securely strapped on. Behind is a platform hooked on to the car and held horizontally by two side stays, on

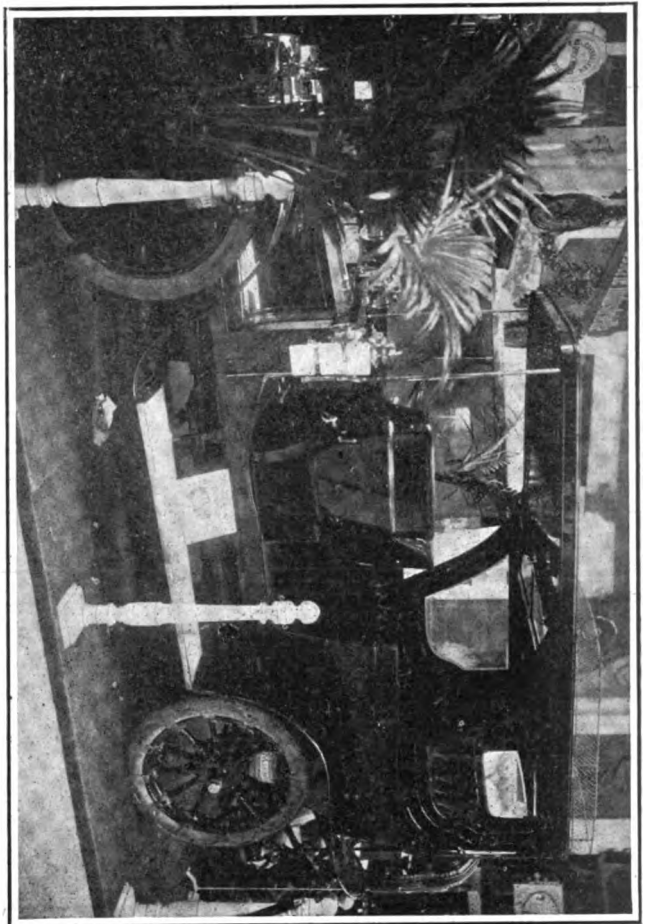

French Cab Body by Benzolin, with Side Entrance and Swiveling Front Seat.—Note glass hinged under top which lets down when front seat is closed.

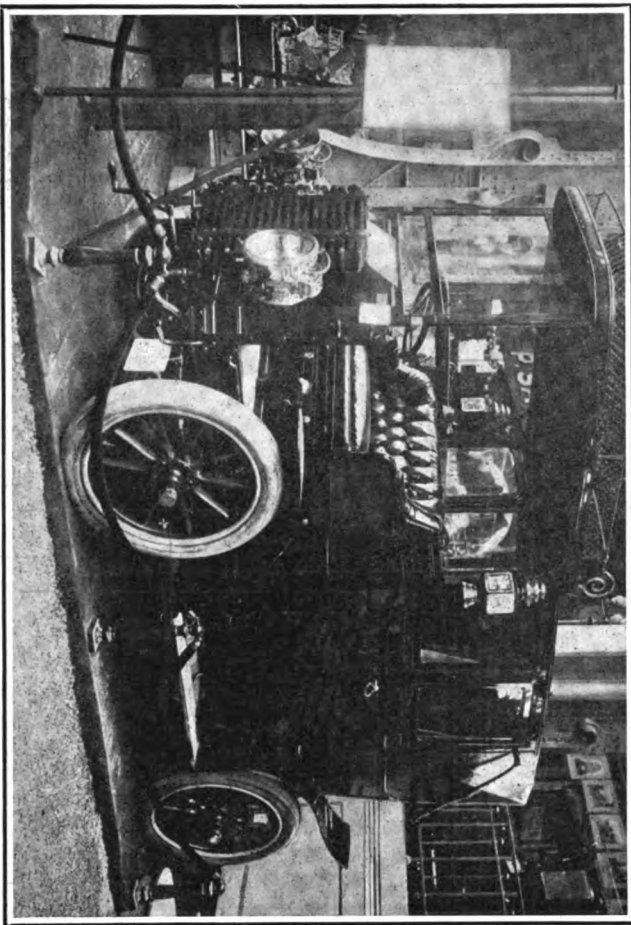

Delage's & Chayette Berline Body, resembling old-fashioned private stage, motor driven.—Four-cylinder motor under front seat, located "noye."
 SOME INTERESTING TYPES OF FRENCH CLOSED BODIES OBSERVED AT THE PARIS SALON.

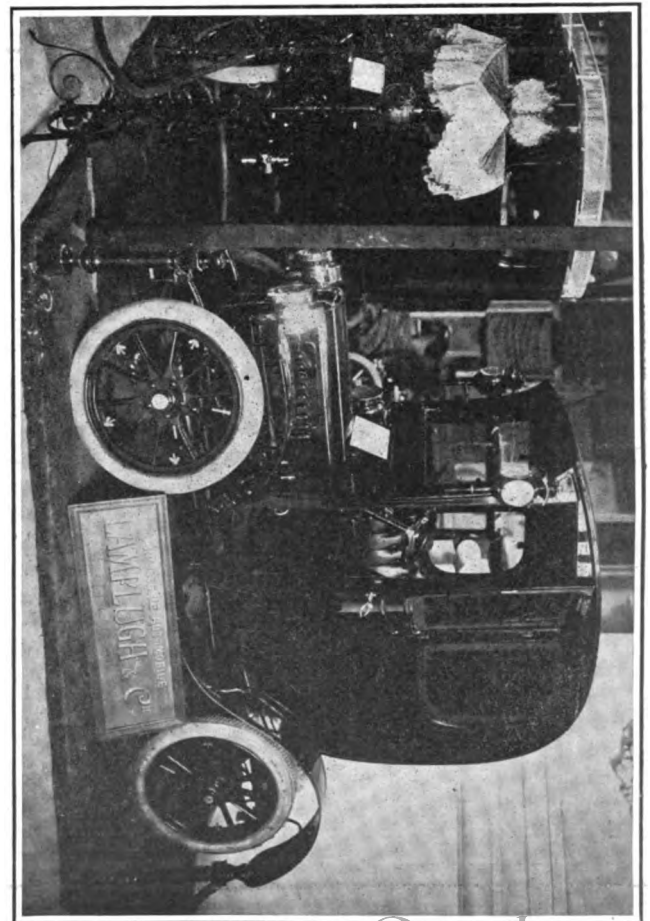

Curved Back Cab Body by Lamplugh, with Inside Drive and Steer.—Suitable for physicians. 7 2 Makers are trying to push this type.

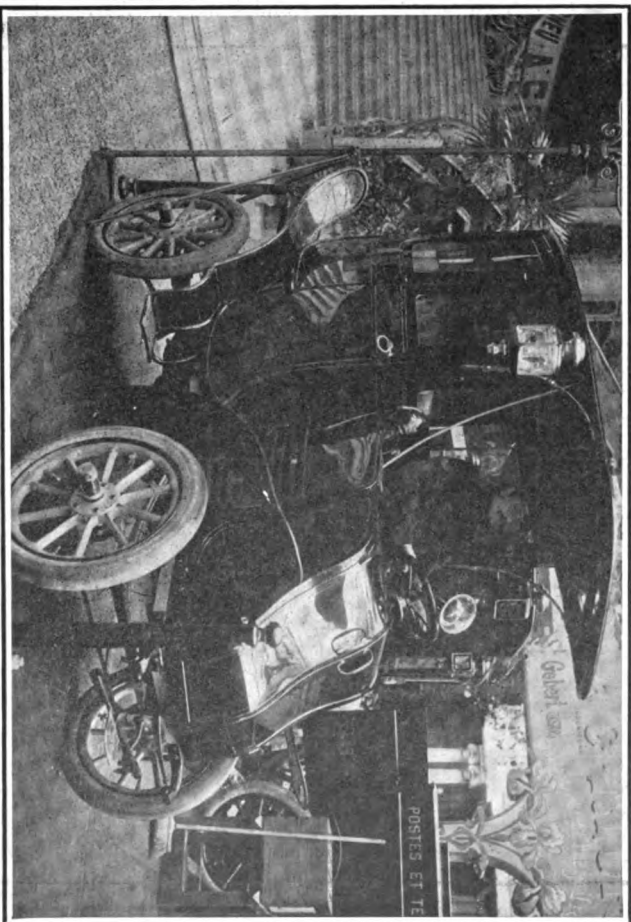

Electric Coupe by Mille.—Note folding doors, hammock cab style, and step in front of driver, who also outside.
 INDICATING THE STRIVING AFTER COMFORT AND LUXURY.

which can be carried two trunks, especially shaped to fit the rear of the car, thus obtaining the maximum of space with a minimum of projection. The upholstery of the car is in pea green leather; the chassis and body are painted gray, with blue beading, giving the car an exceedingly smart appearance.

On the same stand is another handsome carriage—a 40-50-horsepower *berline de voyage* with 110-inch wheelbase. The interior will seat five persons, two on the rear seat, one in each of the two bucket seats, which are swiveled and sliding, and one folding seat. Lockers are fitted under the rear seats; there are two electric lamps in the roof and a speaking tube to the driver. The car is well lighted by side, rear and front windows, those on the side being let down into pockets, making the interior airy in summer. The upholstery is in gray broadcloth. There is a glass shield in front of the driver, hinged to the roof so that it can be swung up out of the way.

THE POPE PULLMAN ATTRACTS ATTENTION.

At the Pope stand the handsome Pullman car attracts considerable attention. It is a four-cylinder 50-horsepower car with a wheelbase of ten feet. The interior, handsomely upholstered in gray broadcloth, seats three persons on the rear seat and two on the individual seats; a strong table can be opened out in the center for serving refreshments. There are large side, front and rear windows, which can be let down into pockets. A speaking tube communicates with the driver.

Another very handsome car is the 35-horsepower Panhard with touring body by Labourdette, which is owned by the Grand Duke Cyril.

The Mors company exhibits a 24-horsepower *berline de voyage* with most of the conveniences supplied in the cars already described. Indeed, these luxurious traveling cars are not confined to one or two stands only. Communication with the driver is fitted on nearly all closed cars and is by means either of a speaking tube or a call bell.

Not many cars with heating apparatus are seen. In a limousine at the Rivot stand a heating apparatus consisted of a flat warming pan fitting in the floor boards, into which passed the hot gases from the exhaust pipes. Provision was, of course, made for opening or closing the feed pipe at will.

ELECTRIC HOSPITAL CAR.

An interesting vehicle was an electric hospital car shown on the Mildé stand. The driver's seat was placed in the ordinary position in front, and entrance to the car, the wheels of which were shod with solid rubber bands, was by means of side and rear doors. The rear entrance consisted of double folding doors, the lower one letting down and the upper one being raised. There is ample space for a hospital bed, additional length being obtained by

making use of the space under the driver's seat. A folding seat is fitted to the side door, and the car is lighted by side and front windows. A medical chest was carried on the top.

At the same stand is an electric brougham, with driver's seat protected by light folding doors opening like those on a hansom cab, the step being placed in front instead of on the side.

REAR ENTRANCE DEAD AS A DOOR NAIL.

There are more novelties in car bodies this year than in anything else pertaining to automobiles. Mechanical contrivances have reached a fixed stage, and engineers have made few radical changes. But in body construction everything has changed. With the increased length of chassis much more roomy bodies are now fitted than was the case a year ago. A striking point is the disappearance of the tonneau body. Not that the tonneau no longer exists, but the old type with bucket seats in front and rear entrance is as dead as a door nail. Side entrances are everywhere in favor. It is obvious that a side entrance cannot be fitted without materially increasing the length of the chassis, and to obviate this many ingenious contrivances have been adopted. On the touring car built by the Westinghouse company, one of the latest arrivals in the automobile world, the wheelbase is 2 meters 70 centimeters, but by means of two angle swivels the two front seats can be raised, leaving a very roomy entrance. The operation is performed by opening a very small side door, on which the front seat hinges forward. Entrance can be from either side, the whole arrangement working very easily and being solidly constructed.

This car possesses many points of interest to the tourist. There is easy access to the driver's seat from the steering side of the car; an advantage not found on all cars. In many respects the chassis is built on the Mercedes model, having a large gasoline

tank placed under the rear of the frame; the sprockets are very close, permitting the use of short chains. It is fitted with a honeycomb radiator, raked steering pillar, and nothing is carried on the dashboard but the lubricator, and even this can be suppressed if desired. The pedals, though not projecting very far, have long leverage, making them easy of action. Altogether this car has an exceedingly smart business like appearance.

A few other firms also have adopted the same kind of door as described on the Westinghouse. At the Darracq stand a touring body was shown with two bucket seats in front and the usual inside or rear seats. The left front seat was pivoted on its right fore edge, leaving a wide entrance on one side of the car only. This style of entrance is not confined to one firm, but plain, hinged side doors are more numerous.

At the Decauville stand a brougham was shown with a revolving entrance of novel construction. The car is entered by the left hand side only, the handle being at the left front corner. The front seat is divided into two parts, the left half being hinged, so that one-half of the front seat of the car swings onto the platform, leaving a wide front entrance.

DOUBLE PHAETON BODIES POPULAR.

Covered cars are largely represented this year, the most popular type appearing to be the double phaeton, with enclosed back and short sides, hinged glass shield in front of driver and side screens that can be readily raised and lowered. At the stand of the Automobile Industriel a covered phaeton of this class is shown with plate-glass windows, capable of being raised or lowered, between the front part of car and the rear seat. A waterproof screen fitted on rollers under the edge of the canopy can be drawn down, extending from dash to the rear of the car, converting an open car into a closed vehicle, the rear portion being entirely closed by means of the transverse windows.

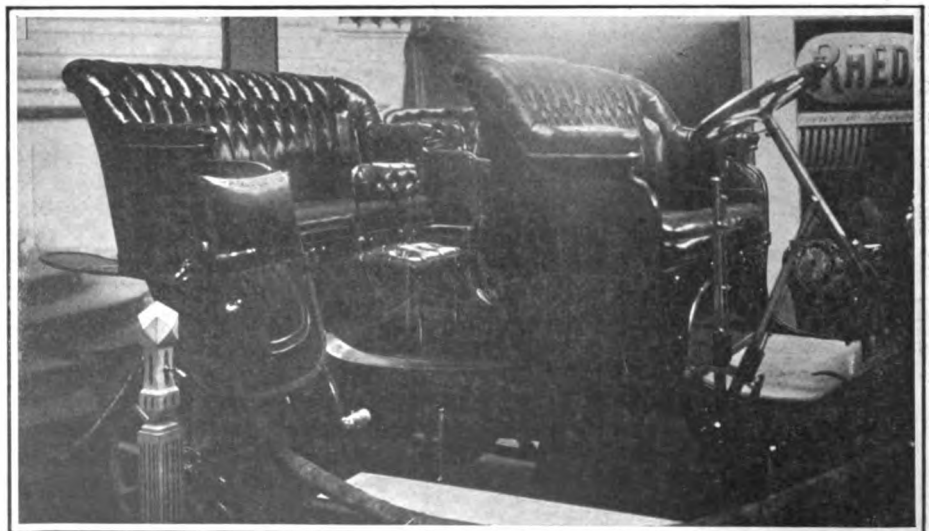

RHEDA DOUBLE PHAETON BODY.—Note wide door and emergency seats in front of rear seat, one folded down forward out of the way and practically out of sight.

The screen is fitted with celluloid windows.

At the same stand is a cab suitable for doctors. It is a two-seated vehicle with steering wheel and controlling levers inside the car. Entrance is by means of doors like those on hansom cabs. A glass screen can be put up between the doors and top of cab, entirely closing in the carriage. A small platform behind is fitted with a convenient locker. This little cab has a most handsome appearance, having turtle-back roof and being well finished.

Close by, at the Beuzetin stand, is a handsome limousine body with two seats in front and room for two or three persons on the rear seat. The left front seat is pivoted to admit to the interior of the car; when inside, a large glass screen can be let down from the roof to close the front of car. A narrow wooden platform occupies the space between the bottom of the screen and the back of front seats, and can be closed or left at any angle desired. When closed, an open carriage is converted into an entirely closed one. One thumb-screw operates the whole affair.

CABS WITH INSIDE STEERING.

Several cabs with inside steering are shown. At the Sage stand, for instance, is an 18-22-horsepower coupé limousine, with four-cylinder motor and chain drive. Inside is a seat for two persons, with steering wheel and levers on the right. Entrance is by side door. The gasoline tank on this car is in the space between the rear of the car and back cushions, and is very conveniently filled from the rear. Behind is a little platform, on which is a seat for a domestic. When not in use this seat folds down and enters into the case on which it stands, disappearing entirely from view. A couple of trunks of good capacity are also fitted in this chest.

At the Audineau stand are exhibited some fine specimens of carriage work. A landaulet limousine, 2 meters 40 centimeters from dash to rear of body, has a roomy interior, with seats for two at the back and two revolving seats with backs to face in any direction; even with four passengers there is ample room for the feet, the space under the driver's seat being open. When not in use the two seats fold up on the side of the carriage between the doorways and rear seats. The carriage is fitted with plate-glass windows, the front one being in one piece, capable of being lowered into a pocket. Owing to the weight of this window springs are being fitted in the pocket to facilitate raising it. The carriage has a collapsible back, running footboard covered with rubber bound in brass and tool boxes underneath it.

Another car on this stand remarkable for its high finish is a brougham, the rounded aluminum back of which is all in one piece. Here no hinges are visible on the outside, a kind of pivoting hinge being employed entirely inside the body work. The same thing can be seen on a brougham at the

Bargin & Beckerich stand. Here, although it is a closed carriage, there is only a half door, the upper part being done away with, and in its place two steel rods fitted with grooves for the window have been placed. Felting along the edges of this window frame prevent it rattling, and suitable beading is fixed above and around the side of the doorway to prevent rain from trickling in.

The Lamplugh firm has two pretty little broughams steered from the inside. The front of the carriage carries nothing but the radiator, lamps and horn, the horn piercing the front and being nearly flush with it. The carriage has a handsome rounding off top. Inside is an electric light; there are plate-glass side and front windows, opening or closing at will. A shelf runs along the front of inside of carriage and below it is the lubricator.

DIVISIBLE DOUBLE PHAETON.

A nice piece of body work is shown on the Driquet Ainé stand. This consists of a

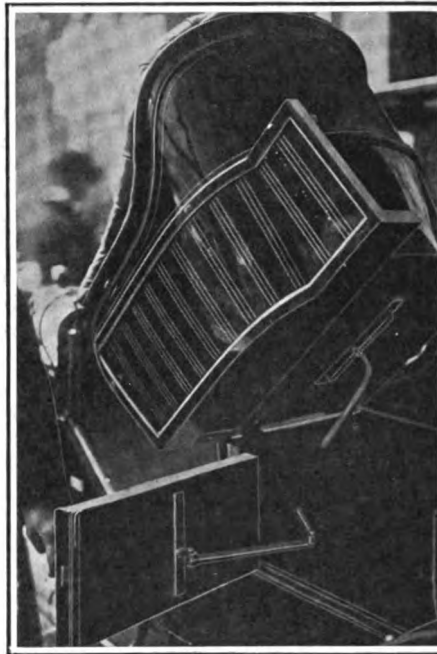

MERCEDES SIDE ENTRANCE, SHOWING FRONT SEAT TILTED FORWARD.

double phaeton with dais and circular-ended back with plate-glass windows. Behind the driver's seat are two revolving bucket seats, which can be made to face forward or reversed toward the rear seat, making a vis-à-vis body. The entrance is by side doors, with handles toward the rear of the car. There is just sufficient space between the two bucket seats to allow passing to the rear seat, and in whatever way these seats are turned they align perfectly with the body of the car. Behind the front seats is a longitudinal glass screen, consisting of three panels, which can be lifted up individually against the top or as a whole. There is also a plate-glass screen on the dash. The sides of the car are protected by roll screens, making the car entirely closed in.

On the Gillotte stand is a limousine which can be converted into an open touring car with side entrance. To make the change the upper part is unbolted from the lower. When used as a limousine it has extending roof over the front seats with hinged glass shield.

NOVELTIES IN HOODS.

Merville Fils show on a double phaeton body a most serviceable looking hood, which extends the whole length of car, passing over the glass shield by an inch or two and being strapped down to the lamp brackets. The screen, by the bye, is divided longitudinally into two parts, the upper part folding over the outside of the lower part. The frame of hood consists of two sections, the first part composed of two stays attached by a pin to a bracket just behind the front seat, and the rear section of three stays attached by a bolt and nut behind the middle seats. The feature of this frame is that it can be easily mounted and dismantled.

Lemoine & Naffrechoux are showing hood frames, the feature of which is that they need no straps. On a long touring car the apparatus consists of the usual two skeletons, the fore one of two and the rear one of three ribs. At each side of the car are two half-circular sectors, on which the metal foot of each rib works. The under side of the sector is notched to receive a catch from the rib. A flexible wire cable runs from the catch at each side and is attached to a small thumb lever on the middle of the hood, one turn of which will release the catch and allow the hood being moved to any position. The same apparatus is also fitted as a dust shield for hanging over the back of an open car.

DE DION IMPROVEMENTS DEMONSTRATED.

One car at least at the Paris Salon has proved its touring qualities before coming on exhibition. This is a 15-horsepower four-cylinder De Dion-Bouton touring car. For several years past the De Dion firm has been in the habit of sending off its new cars on a tour of several thousand miles, in order to test the improvements and changes made. This year the car set off for a 5,000-mile run around Europe, piloted by Cormier, who has made himself quite famous by these lengthy tours. The journey was not without difficulties, and after struggling for more than two months with rain, snow, hail and wind, not to mention difficulties of a more human origin, Cormier has returned safely to Paris in time to take his place in the seventh annual automobile show. The car is a tonneau with folding hood, fitted with Dunlop tires, carrying an extra large gasoline tank in front of the dash and weighing altogether 1,800 kilos.

The automobilist who came near running down Speaker Cannon did not stop to hear Uncle Joe's ejaculatory remarks. There are some things too formidable for even the driver of a motor carriage to face.—*Providence Journal*.

Small Cars at the Paris Show.

Staff Correspondence.

PARIS, Dec. 16.—There is a remarkable scarcity of small cars at the Paris show—that is, cars that would correspond in price and size to our regular runabouts. It is essentially a big-car show. French makers have neglected the small car in later days, though there is a considerable construction of cars that, while small in size, are built upon the lines of their bigger brothers, of costly design. Such cars run from about 8 to 14 horsepower, are rarely fitted with less than two cylinders and are styled here the *voiture légère*. In this class are such makes as the Renault, Clément-Bayard, De Dion and Cottereau.

MINERVA 6-HORSEPOWER RUNABOUT.

The runabout proper, or *voiturette*, is of much greater interest from the fact that it comes in direct competition with our own familiar small cars. Of this type the lightest vehicle shown is the Minerva, made by the concern which was the pioneer in the motor bicycle field and gained an enviable reputation with its small engines. This car is notable for its short wheelbase, its small wire wheels and general toy-like appearance, which last is very unfortunate. The body has two bucket seats and is fairly comfortable, but the lack of comfort of the suspension counteracts a good deal of this quality. The engine, which is in front, under a small hood, is 6-horsepower, single-cylinder, vertical motor, with mechanical valves and enclosed flywheel—a somewhat magnified Minerva bicycle engine, water-cooled. The carbureter is a Minerva, made under Longuemare license. As a whole, the power plant is of a high standard of quality and efficiency, and deserves a much better utilization than that given to it. The drive from this engine to the change-speed gear is by chain. The transmission, which gives two speeds and reverse, is under the front part of the seat, and from it another long chain transmits the power to the differential in the rear axle casing. The steering is by wheel and is not irreversible, a rack and pinion actuating the steering connecting rod. The maximum speed obtainable by an average driver is about twenty miles an hour on the level. The frame of the car is tubular.

WELL MADE LOW-PRICED CAR.

Much better value is shown in the L. B. car, a new make advertised under these initials, and which seems to meet with great appreciation. The standard car is fitted with a De Dion 6-horsepower engine, although any other similar motor will be fitted to order. This is placed in front, under a very smart hood. The frame is neatly and strongly made, the side members being of armored wood in their central part and having their front and rear ends of pressed steel well jointed, with provision for unequal expansion; the cross members

are of strong armored wood. The makers also fit a 9-horsepower engine, and in that case the frame is all of pressed steel.

The change-speed gear is of very compact construction, small and strong. It is bolted on the angle steel sub-frame, is of the sliding gear type, with three speeds and reverse, the high speed driving direct. The shafts are one above the other, the live shaft being practically horizontal when the car is under usual load.

The rear axle, which is of cast steel, is mounted on ball bearings throughout and very strongly braced. The steering is by worm and sector, with an inclined wheel. Ignition is by accumulators and coil and is carefully devised.

There are two hub brakes and one on the live shaft, and the parts for all are exactly the same. This point is worthy of notice considering the greater facility for the getting of spare parts.

The clutch, which is well designed, can be taken entirely out of the car without touching any other part of the engine or speed gear. The water circulation is by a centrifugal pump, friction driven. The wheels have wooden spokes and are of uniform size for convenience in fitting spare tires. The radiator is of oval shape, built up of fine tubes. Lubrication is by a force-feed oiler, which the driver is to operate every twenty miles or so, and which lubricates the car throughout without any stoppage.

The rear suspension is by three springs, two placed lengthwise and the other crosswise, which gives a great increase in comfort. The speed is thirty miles an hour for the 6-horse model and thirty-five for the 9-horse. The French prices are respectively 3,900 francs (\$780) and 4,800 francs (\$960). The wheelbase and tread are of generous dimensions.

LA FAUVETTE LIGHT CAR.

The La Fauvette is also a light car which for outside appearance could hardly be beaten, but the price gets too close to the large car values. It is driven by a De Dion or Aster 6-horsepower engine through a three-speed-and-reverse sliding gear with direct drive on top speed and live shaft drive. The frame is armored wood; the hood and radiator are somewhat on Panhard lines and being of good size gives a look of power to the vehicle; the wheels are artillery type of equal size front and rear. One of the features of the car is the reasonable size of the chassis, allowing the owner to fit either a small tonneau body or a closed body with inside control. The wheelbase is close to seven feet and the tread 48 inches. The total length is ten feet.

GREGOIRE ONE AND TWO CYLINDER CARS.

A very interesting car is the Gregoire, which is made in either one or two cylin-

der, 6-horsepower, at a fair price. The general description is the same for both models. Pressed steel frame, artillery wheels of equal size, irreversible steering, thermo-syphon circulation, combined radiator and tank in front, three speeds and reverse by sliding gear, brake and differential enclosed in change-speed gear-case, double chain drive, straight axles, all brakes internal, one on differential casing and one on each rear hub of large size.

The 6-horsepower single-cylinder engine has a bore of 100 millimeters for a stroke of 120, and the two-cylinder of same power has a bore of 80 millimeters by a stroke of 110. The chassis of the single-cylinder car costs in Paris 3,100 francs (\$620), and that of the twin-cylinder 3,600 francs, or \$720, an extra charge of 400 francs (\$80) being charged for a two-seated body. The engines are fitted with mechanical valves of good size and accumulator ignition.

WOLSELEY VERTICAL ENGINE CAR.

An English novelty and an unexpected one is the new 6-horsepower Wolseley light car with vertical cylinder. It seems that the old champions of the horizontal cylinder are all giving it up slowly, since there is not one maker left now in the European market making horizontal automobile engines who does not make vertical engines also—in fact, the gentleman at Wolseley's stand was not ashamed of his change and admitted proudly almost that since he had tried it he much preferred the vertical engine. And yet, as far as the engine is concerned, the design of this car is not the acme of up-to-dateness, and it can very clearly be seen by any one that the engine is too much on the lines of a horizontal engine turned one end up. Yet it is a step in what is called the right direction in France and is to be noted.

As to other features, the wheels are artillery type, 28 by 3 inches, the frame of pressed steel, the ignition by accumulator and coil, the gearing of the usual Wolseley three-speed type, giving seven, thirteen and twenty miles an hour steadily, with a maximum in short runs of twenty-five. The clutch is of the ordinary cone type. The rear axle is a very stiff, single chain-driven live axle. The brakes are ordinary externals. The car is sprung on a transverse rear spring and four usual semi-elliptics, very long and flat.

BAILLEUL 6 AND 9-HORSEPOWER CARS.

Another interesting car is the Bailleul, which is fitted with a 6-horsepower De Dion engine, or any other similar engine at customer's choice. The frame is built of tubes, and on the 9-horsepower car, which in all other respects is identical to the 6-horsepower model, a stamped steel frame is supplied, if preferred, without any extra charge; the tubular is, however, the standard. The change-speed is of the sliding gear type, with three speeds and reverse and direct drive on high gear, said to climb any hills up to 8 per cent. on the high gear.

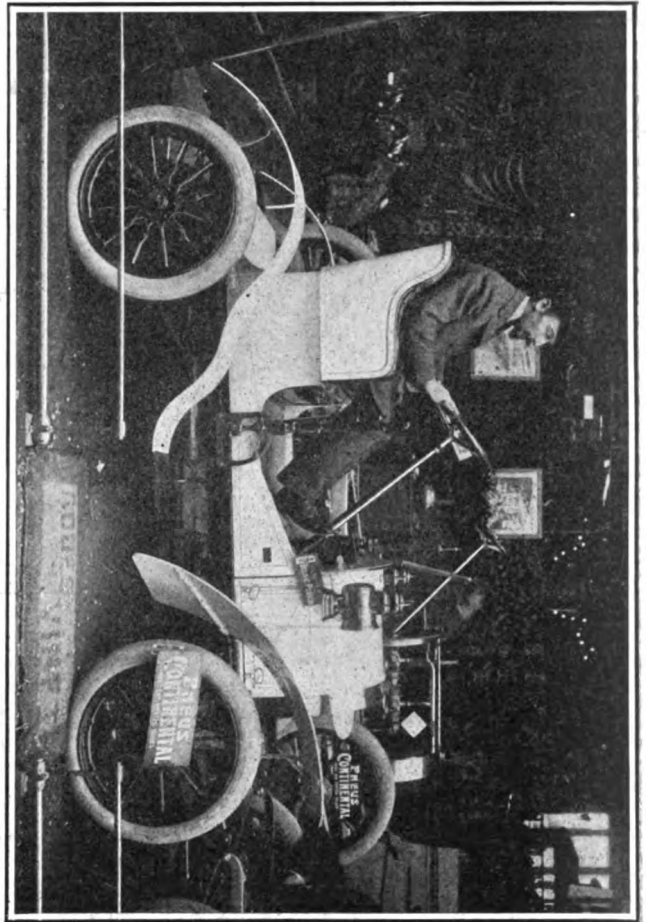

Gregoire 6-Horsepower Runabout, with pressed steel frame, three speeds and reverse, and chain drive. Price, \$700; chassis only, \$620.

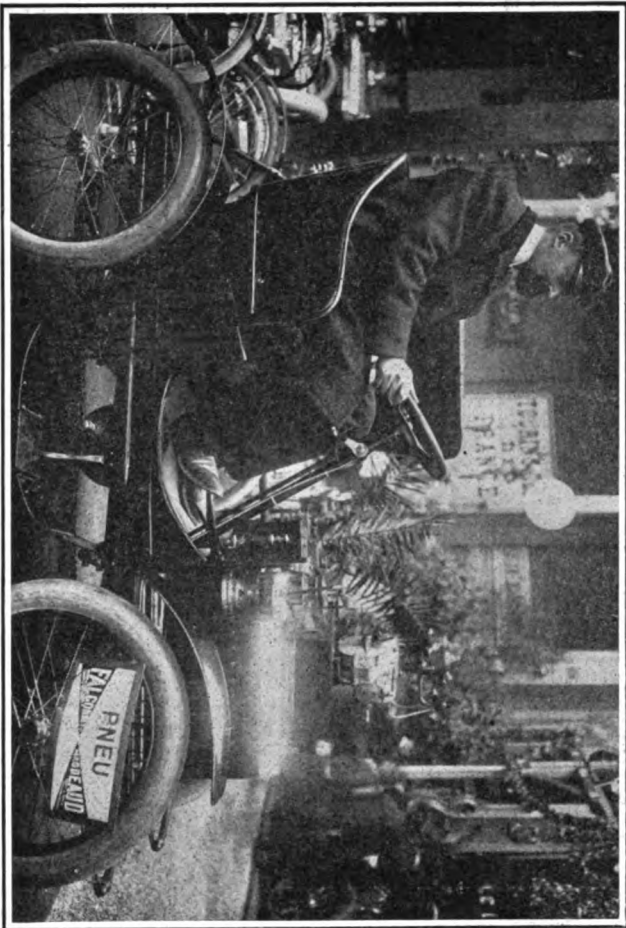

Minerva 6-Horsepower Volturette, with tubular frame, mechanical valves, water cooling, two speeds and reverse.

ATTRACTIVE STYLES OF LIGHT, LOW-POWERED FRENCH CARS PATTERNED AFTER HEAVY TOURING CARS BUT SELLING AT LOW PRICES.

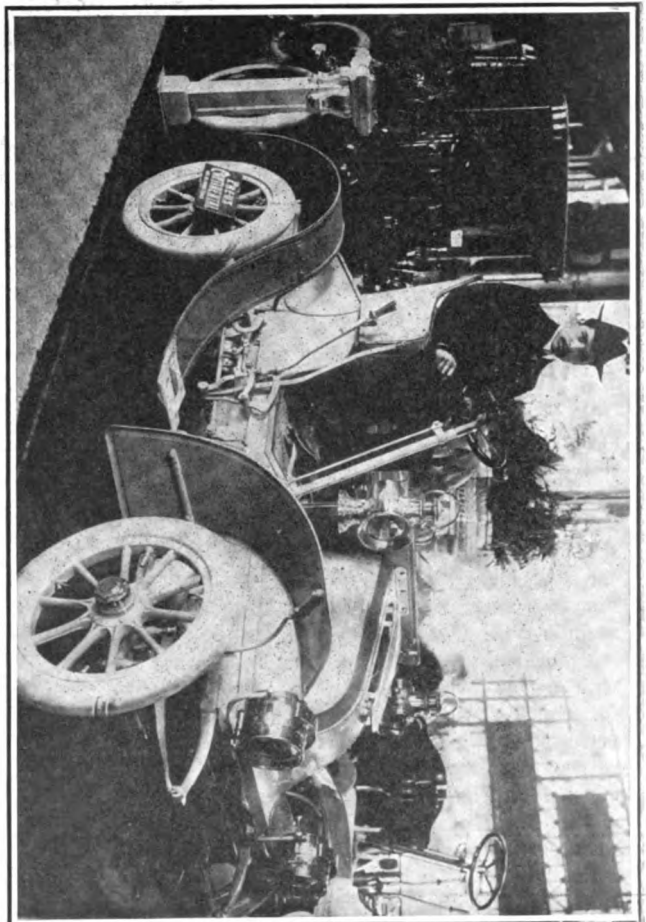

Prosper Lambert 6-Horsepower Small Car, with engine of his own make.

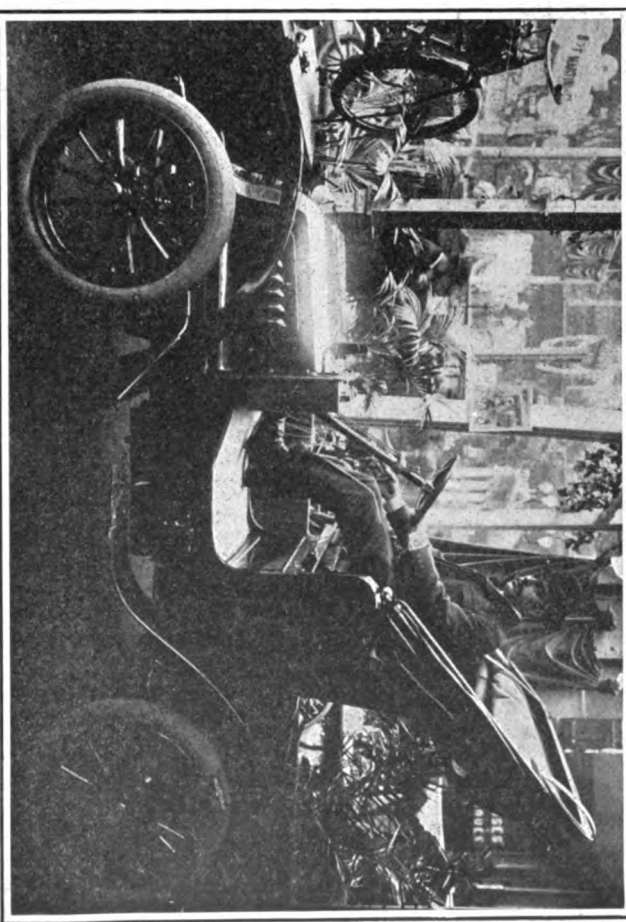

La Savvette, having armored wood frame, and driven by 6-Horsepower De Dion engine. Price, complete, without top, \$600.

The transmission from the gear-case to the rear axle is by a propeller shaft with a special joint. In this joint the pegs at the end of the driver and driving shaft do not revolve in bearings, as in the usual construction, but in a long steel sleeve with four longitudinal grooves, so that all action of the springs causing changes in the distance of the gear box to the axle is taken up in the joint itself, thus avoiding, according to the maker, any tendency to seizing.

The brakes are on the hubs and the transmission, as usual, and do not possess any special features. The ignition is by jump spark and the cooling by thermo-syphon with finned tubes. The bearings are on balls throughout, except in the engine, and are of remarkably large size considering the power of the car. The wheels are of the artillery pattern and are shod with Michelin tires, although the price is very low for the value, since it is only \$600 for the car as

with bucket seats, provision for a large trunk or sample box at rear, sometimes spider seat, wheel steering and hub and shaft brake.

In no instance, except on the Oldsmobile, which it is unnecessary to describe here, are lever steering and planetary speed gear used, while there is not in any size of engine any case of air cooling to be found. In fact, even many 3-horsepower motor bicycles on exhibition are water-cooled.

BANQUET TO AMERICANS.

Trade Visitors to Show Entertained by Continental Tire Company.

Staff Correspondence.

PARIS, Dec. 14.—Probably never before has there been a social event in the French capital at which so many Americans in the automobile trade sat down to dinner together as at the banquet given by the Conti-

the trade in a French hotel. W. Tischbein, chairman of the Continental Tire Company, of Hanover, made a very pretty speech of welcome to the guests.

Among those present were: Sidney B. Bowman, Clément-Bayard; Albert Otto, J. S. Joseph, Rochet-Schneider; Léon Rubay, Lacoste et Compagnie; Clovis Bertrand, Clément-Bayard; H. H. Nelson, Pope-Toledo; M. Loeser, manager, Continental Tire Company, Paris; Harold Pope, Pope-Toledo; H. Leinhart, Pope-Toledo, Hartford, Conn.; Emile Stern, Léon-Bollée; A. J. Myers, Aster Motor; E. B. Gallaher, Georges Richard-Brasier; R. A. Greene, Locomobile Company; J. W. England, E. T. Birdsall and E. S. Partridge, Decauville; H. J. Halle, Allen, Halle & Company, Mercedes agents; W. T. Jones, Clément-Bayard; H. F. Donaldson, editor of THE AUTOMOBILE; J. L. Gibney, Philadelphia Continental agent; E. R. Thomas, Thomas automobiles; H. Chisholm, Peerless Company; H. E. Coffin, Olds Motor Works, and Georges Prade, *Les Sports*.

PHILADELPHIA SHOW.

All Available Space in First Regiment Armory Taken for January 23-28.

Special Correspondence.

PHILADELPHIA, Dec. 26.—The local automobile show for 1905, which is to be held in the First Regiment armory, at Broad and Callowhill streets, during the week of January 23 to 28, is expected to be by far the largest yet held in this city. Every foot of available space has been taken by exhibitors, and, in addition, a number of the rooms used by the individual companies of the regiment have been pressed into the service. Better attendance is looked for than last year owing to the more central location of the First Regiment armory than of the Second Regiment armory, which was used for the last show. H. D. LeCato, who has managed the show for the last four years, is in charge of the 1905 exhibition. Following is a partial list of the exhibitors:

Winton Motor Carriage Co., Quaker City Automobile Co., John Wanamaker, Martin & Hart, MacDonald & Campbell, Pennsylvania Electric Vehicle Co., E. J. Willis Co., Warner Instrument Co., Charles E. Miller, S. F. Bowser & Co., Twentieth Century Mfg. Co., Atlantic Refining Co., Keystone Motor Car Co., Gawthrop & Wister, Diamond Rubber Co., Hartford Rubber Works Co., Locomobile Co. of America, C. W. Kelsey, J. L. Gibney & Bro., Cushman Motor Co., F. A. La Roche & Co., Eastern Automobile Co., B. F. Goodrich Co., Rose Automobile Co., Fairmount Engineering Co., J. T. Halsey, N. A. Petry, Charles Krauss, Neverout Lamp Co., Gray & Davis, Black Diamond Automobile Co., Ideal Stamping Co.

No one ever thinks of speaking of a "horse stable." Why, then, is it considered necessary to say "automobile garage?"

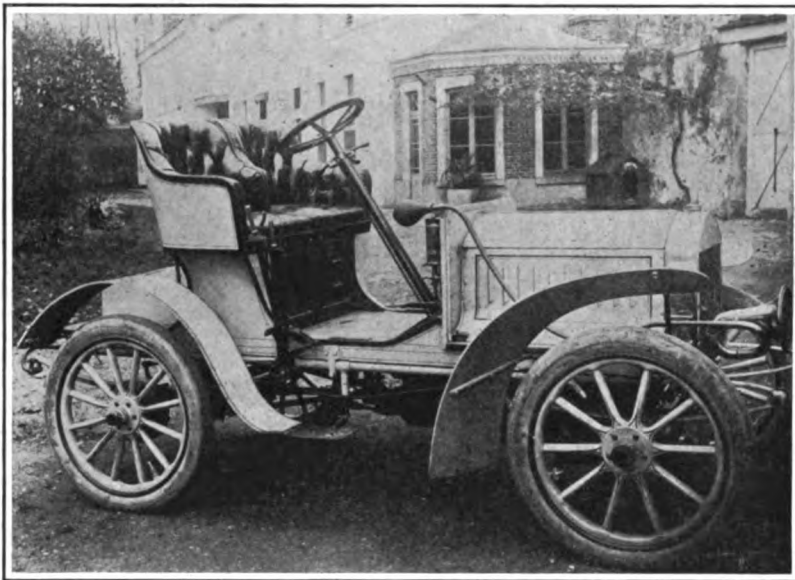

BAILLEAU 6-HORSEPOWER FRENCH VOITURETTE.

Tubular or pressed steel frame, three-speed sliding gear, live axle, and jump spark.—Chassis, \$540; complete, \$600.

shown, the price for the chassis being \$540, with \$7 extra for the tool-box at the rear.

FEATURES OF SMALL CARS IN GENERAL.

There are a few other cars shown of the same general types and of similar prices to those described in detail, but not in great number, on account of the tendency mentioned at the beginning of this article. In short, the general characteristics of the light car at the show are much more standard than in the other types of cars and are about as follows:

Vertical single-cylinder engine in front, with enclosed flywheels, separate flywheel for clutch cone and three speed and reverse sliding gear with cardan drive to rear axle. Armored wood frame, with a very strong tendency to pressed steel, which will probably be the standard at the next show; artillery wheels, low center of gravity and increased wheelbase; large bonnet and radiator with fan, two-passenger body

mental Tire Company at the Elysée Palace here last night. Nearly thirty Americans, most of whom had come over for the 1904 Salon, were seated about the beautifully decorated table at which Emil Grossman, of New York, presided in the toastmaster's chair.

It was an entirely informal gathering, with none of the usual banquet atmosphere and tedious program of set speeches. Business rivals among the New York importers and American manufacturers forgot their trade differences for the occasion. They chatted and laughed and told stories about their experiences as they might in the café of the Navarre or the Dutch room in the club in New York. After dinner coffee and cigars and things in multicolor labeled bottles kept the crowd together until after midnight. It was certainly an international occasion, for the host was a German company, giving a dinner to the Americans in

Lozier 30-35-Horsepower Touring Car.

It has been known for some time in trade circles that the Lozier Motor Company, of New York City, builders of gasoline launches, was preparing to build automobiles, its first automobile type motor having been exhibited at the 1904 Sportsman's Show at Madison Square Garden. The first Lozier cars have been undergoing a thorough road testing for some months, and the announcement is now made that a number of cars are being built for the coming season. The prominent position long held by the Lozier company in the launch and marine motor field causes much interest to attach to the result of its efforts in automobile designing.

Only one size of automobile will be built for the present. This has a motor of four vertical cylinders, which occupies the conventional forward position under the hood and is rated at 30-35-horsepower. The cylinders are cast in pairs and bolted to an aluminum crankcase. All valves are mechanically operated, the inlet valves being on the right hand side and the exhaust valves being on the left of the cylinders. Each pair of valves is held down by a yoke with a single stud and nut. Valves, springs and valve lifters are all alike and are interchangeable. A nickel-steel composition having a low coefficient of expansion is used for the valves, with the object of reducing distortion to a minimum. Enclosed chambers are provided in the crankcase for the cams and valve lifters. These are in com-

carbon steel is used for the crankshaft. A novelty in the construction of this member is that the crank-pins are hardened and ground, a special machine being used for the grinding operation. Reciprocating and rotating parts are made as light as is con-

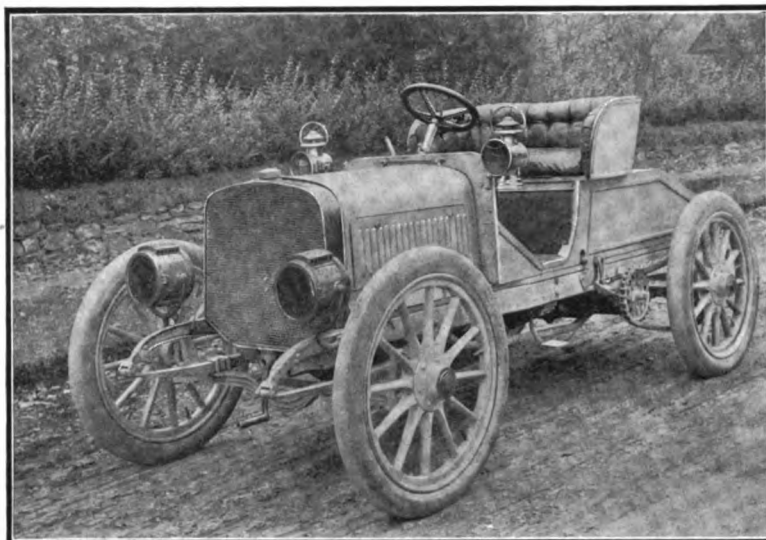

LOZIER 30-35-HORSEPOWER TOURING CAR, FITTED WITH BODY FOR TESTING.

sistent with durability, and are balanced carefully to avoid objectionable vibration when running.

The single carbureter used is said to be absolutely automatic at all motor speeds.

are provided for removing the clutch without disturbing the motor or gearcase when it is necessary to renew the leather facing. Three forward speeds and a reverse are given by the sliding gear transmission, one lever being used for all speed changes. This lever is locked and cannot be moved while the clutch is engaged. The drive on the high gear is direct, the countershaft in the gearcase being idle. Power is transmitted to a cross shaft carrying the differential, and thence by side chains to sprockets on the hubs of the rear wheels. The transmission shafts, which are of nickel steel, and the jack-shaft turn on ball bearings. The gears are of hardened steel with teeth of six pitch. Differential and emergency brakes are fitted, the former having a brass friction band, which may be renewed without difficulty, while the brakes on the rear hubs are of the expanding ring type, enclosed from dust and mud. The differential brake, which is operated by a pedal, is inter-connected with the clutch, so that the application of the brake throws out the clutch. The emergency brake, however, is independent of the clutch, and may be used together with the motor, connected through the slow-speed gears, when descending very steep hills, a method that is recommended by some drivers, who say that skidding is less liable to occur when the motor is used to assist in the braking.

The new Lozier car has a pressed steel frame and I-beam axles, the latter made from nickel-steel forgings. Semi-elliptic springs, 38 inches long and 1 3-4 inches wide, are used at the front of the car, and

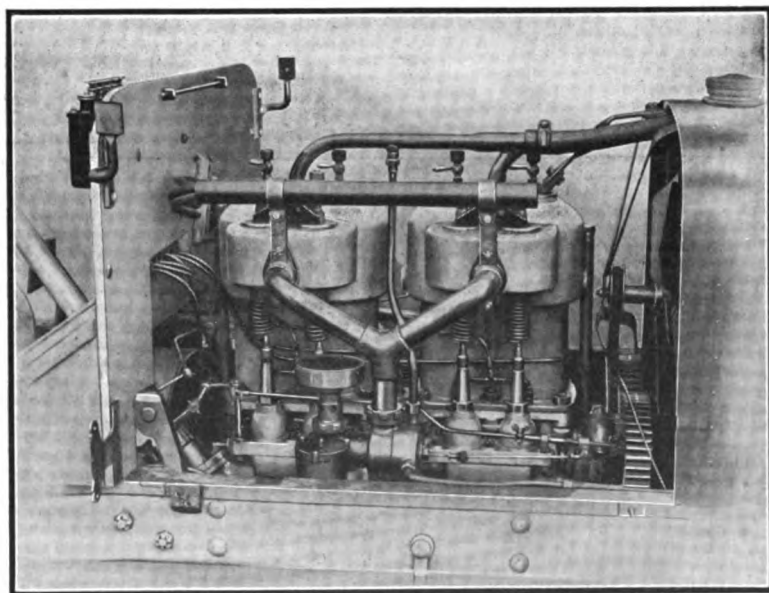

INLET SIDE OF LOZIER FOUR-CYLINDER ENGINE.

munication with the main crank chamber, and are lubricated by the splash therefrom. Small covers give access to the cams. The cam shafts are driven direct from the crankshaft, there being no intermediate gears. There is a steel pinion on the crankshaft and on each cam shaft a built-up gear of fiber and bronze. Mild open-hearth 30-point

Cooling of the cylinders is effected by a system comprising a honeycomb radiator, a gear-driven centrifugal pump and a fan. Jump-spark ignition is fitted, the ignition timing lever being located on top of the steering wheel, together with the throttle lever. Storage batteries or high tension magneto will be supplied at purchaser's option.

similar springs, 42 1-2 inches long and 2 inches wide, at the rear. The rear pair of springs is supplemented by a cross spring. The artillery wheels have ball bearings and are 36 inches in diameter fitted with 4 1-2-inch tires. The wheelbase is 115 1-2 inches, and there is ample clearance over the road surface. Aluminum is used for the body, which is to be built to suit the taste of the purchaser. The weight of the car complete is about 2,500 pounds.

Cadillac Light Models.

Although the Cadillac Automobile Company is building a four-cylinder touring car, particulars of which will shortly be announced, it is retaining and adding to its line of light single-cylinder machines, from which the accompanying photographs are taken.

The satisfactory results given by the Cadillac cars during the past year are attested by the fact that the company has found very few changes necessary. In the new models, the engine in particular remains substantially unchanged, but has been refined in detail, so that it is now rated at from 8 1-2 to 10 horsepower, which is certainly unusual power for a horizontal motor of five inches bore and stroke. The planetary change-speed gear has been changed only in the method of supporting the friction bands, which are now so mounted that no appreciable side pull is exerted on the bearings and crankshaft when these bands are tightened. A special feature of this planetary gear is that it has only one oil hole, into which enough oil can be introduced to last for several days.

A neat feature of the motor, which has been used for the past year, but which is less known than it deserves to be, is the method of oiling the piston. At the bottom of the piston a groove is cut in the first two

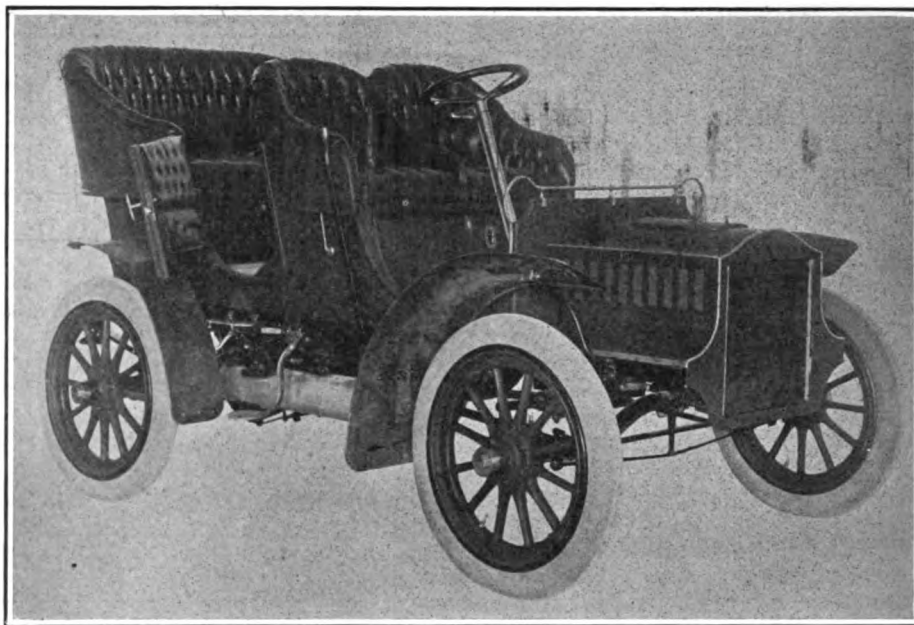

CADILLAC MODEL F 8 1/2-10-HORSEPOWER TOURING CAR WITH SIDE ENTRANCE BODY.

packing rings and the spacing collars or junk rings between them, and this groove terminates in a circular groove in the third junk ring, which extends around both sides to the top of the piston. At the top it meets two other grooves, which are cut in the third packing ring. The effect of these grooves, which form a continuous though minute path of leakage from the cylinder, is to cause any surplus oil collecting at the bottom of the piston to be forced out, following the grooves till it reaches the top of the piston, whence it works down while contributing to the lubrication of the latter. The more familiar copper water jacket and double-insulated spark plug are among the features retained.

The Model B machine, made into a touring car by the addition of a detachable tonneau, is essentially the same machine as

during the past year. The new Model E differs from it chiefly in having a new and much neater false bonnet. In the front of the bonnet is a radiator patterned after the new style, with zigzag tubes and closely set square fins. The Model B has the pressed steel front axle already familiar, but the Model E has an arched tubular axle, built up with a heavy arch, a central strut, and a truss rod below. The top of the arch is attached to the transverse front spring, which, instead of being bent downward at the ends, as in the Model B, is perfectly flat, so that the replacement of possible broken leaves when touring is a much simpler matter. This Model E is sold with a non-convertible runabout body, to which a buggy top may be added for doctor's use, if desired.

The Model F is substantially the same

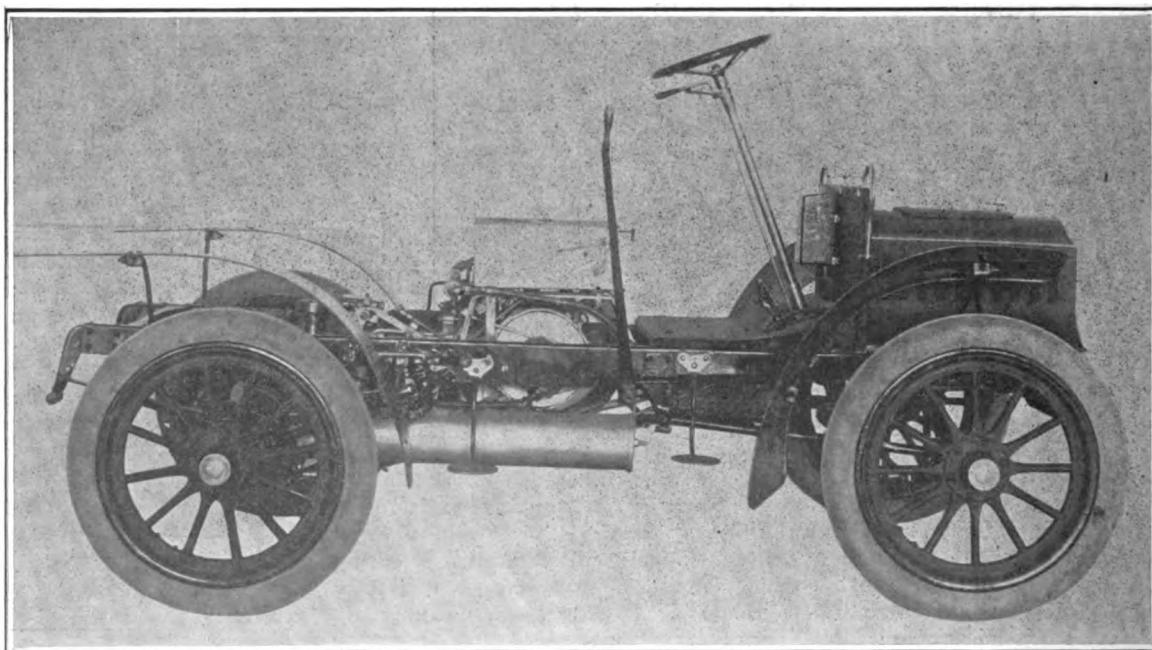

CADILLAC MODEL F CHASSIS, FOR SIDE-ENTRANCE TOURING BODY OR DELIVERY WAGON TOP.

machine, but with side entrance and rear seat added. The wheelbase of Models B and F is the same, 76 inches, while that of Model E is 74 inches. Model E has 28-inch wheels, and the other machines have 30-inch wheels. The delivery wagon, also designated Model F, has likewise a 76-inch wheelbase, and its weight is given as 1,400 pounds. The Model F touring car weighs 1,350 pounds, against 1,450 pounds for the Model B, and 1,100 pounds for Model E with runabout body. The standard tread of all the machines is 56 1-2 inches, but a 61-inch tread is given as an option. On Models E and F, unless otherwise specified, the perfected Dunlop tires are supplied.

Acme 'Opera' Bus.

The opera 'bus, illustrated herewith, was built by the Acme Motor Car Co., of Read-



POPE-TRIBUNE SIDE-ENTRANCE TOURING CAR WITH VERTICAL TWIN-CYLINDER MOTOR. 15

ing, Pa., for a citizen of Chicago, and was fitted up in the finest manner. Entrance is through a rear door; electric lights illuminate the interior, and the driver may be communicated with through a speaking tube. There is a folding writing desk, and receptacles are provided for opera glasses, toilet articles and engagement book or papers. Drab cloth is used in the upholstery. Another feature that will be appreciated in Chicago along about automobile show time there is that the interior is heated. The object was to produce a car that would be comfortable in bad weather, and everything possible was done to ensure the comfort of the passengers.

Pope-Tribune for 1905.

The Pope-Tribune car for 1905, built by the Pope Mfg. Co., in Hagerstown, Md., is of the popular light touring car type with French hood in front, as shown in the ac-

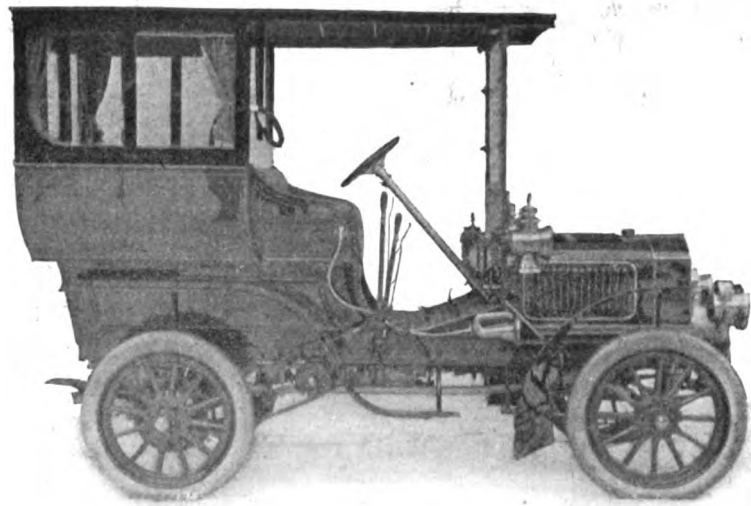

ACME OPERA 'BUS WITH REAR DOOR AND HEATED INTERIOR.

companying illustration. The motor, located in the hood, has two vertical cylinders of 4 1-2 inches bore and stroke, with integral heads and water jackets. The inlet valves are automatic. Three forward speeds and a reverse are given by a transmission gear of the individual clutch type controlled by a single lever. Drive is by propeller shaft and bevel gears. Ignition is by jump spark, the coil being placed on the dashboard, where there is a double-throw switch for making different connections between the two sets of batteries that are supplied with the car.

The body is of laminated wood, and is of the side-entrance type, the front seats being divided. By removing the floor boards between the front seat and the dashboard the transmission may be inspected, while the removal of the tonneau floor exposes the differential. The standard finish will be Cumberland blue with cream colored running gear. Albert L. Pope, vice-president of the Pope Mfg. Co., is shown at the wheel of the new car.

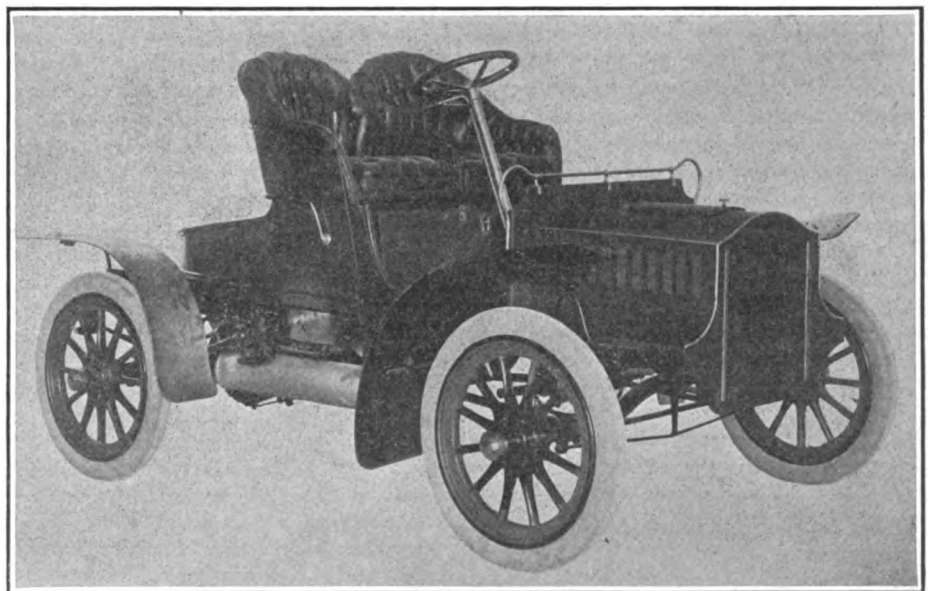

CADILLAC MODEL E, 8 1/2-10-HORSEPOWER RUNABOUT WITH "NON-CONVERTIBLE" BODY

THE AUTOMOBILE

VOL. XI.

No. 27

Published every Saturday by

THE CLASS JOURNAL CO.,

Flatiron Building, Madison Square,
NEW YORK CITY.Cable Address - - - Autoland, New York
Long Distance Telephone - 300 Gramercy, New York

SUBSCRIPTION RATES:

United States, Canada and Mexico, - One Year, \$2.00
Other Countries in Postal Union, - One Year, \$3.00To Subscribers—Do not send money by ordinary mail.
Remit by Draft, Post-Office or Express Money Order,
or Register your letter.

FOREIGN SUBSCRIPTION AGENTS:

ENGLAND:—Hiffe & Sons, Limited, 3 St. Bride Street,
Ludgate Circus, London, E. C.FRANCE:—Boyveau & Chevillet, 22 Rue de la Banque,
Paris.

GERMANY:—A. Seydel, Mohrenstrasse 9, Berlin.

To Advertisers—Copy or changes in orders for advertisements should reach us not later than 5 o'clock p. m. Monday for the issue of Saturday following.

Copyright, 1904, by The Class Journal Company.
Entered at New York, N. Y., as second-class matter.

The Automobile is a consolidation of The Automobile (monthly) and the Motor Review (weekly).

Copies Printed This Issue, - - 12,000
" " Since Jan. 1, - 639,000**Motor Touring and Its Influences.**

An incidental but by no means insignificant and unimportant exhibit at the Paris Show is that of a series of completely decorated and furnished bedrooms and bathrooms, similar in a way to the model room shown in the great American department stores. To the American mind, at least, the connection between the automobile and house-furnishing fails to suggest itself at the outset; but there is, nevertheless, a good practical reason for the seemingly incongruous exhibit. Those who have toured on the Continent in automobiles, or even traveled by less modern means over the conventional routes, stopping only at the large towns, will appreciate the deficiencies in point of both convenience and comfort as understood by Americans. To the average American, accustomed even in the medium walks of life to furnishings, household conveniences, and in particular toilet appliances, which are not merely acceptable but actually elegant, no amount of the quaint and picturesque in foreign travel can compensate for the primitive conditions of everyday life. The object of this new feature of an automobile exhibition is to demonstrate to French hotel and inn keepers the necessity for and the possibilities of a reform through the adoption of modern methods.

As a means to this end, the exhibit is very well arranged; the decorations and furnishings are simple, suitable and in excellent taste, showing how to obtain the

best results at moderate expense. The most important detail, of course, is that of the bathroom, and here much is to be learned from American goods and methods of installation.

If any doubt exists as to the need for reform in hotels, it is dispelled by the present exhibit of strictly touring cars—not merely cars in which motoring enthusiasts patiently endure the discomforts of the weather for the sake of certain compensations, but cars which, by their luxurious furnishings, tempt the non-motorist to abandon the most modern of the continental expresses. The American "Pullman" is but one of many of these new cars, exhibited this year in greater perfection and larger number than ever before, and now claiming the dignity of a distinct and well defined type.

Considering the popularity to which automobile touring has already attained in cars of the open tonneau type, there need be no doubt as to its future when such cars as these are to be had; and with this increase of touring comes the demand for better accommodation for travelers. The reform in this direction which is now promised is attributable solely to the influence of the new method of locomotion.

**Contents for Touring Trophies.**

The question of public competitions is a serious one for all automobile clubs; on the one hand, there is convincing evidence of the benefits of road races and similar contests, while on the other there are the speed laws and the various bodies, general and local, charged with their enforcement. Such road races as the Vanderbilt cup, the Gordon Bennett and those from Paris to the other European capitals are possible only under special conditions, and the endurance runs as held in this country have outgrown their usefulness and interest.

The Automobile Club of Great Britain and Ireland will introduce in 1905 a new form of contest, a combination of the race, the reliability run, the tour and the consumption contest. The course will be from 150 to 250 miles and the cars will be limited in many ways with the idea of restricting the entries to *bona fide* touring cars, with comfortable bodies, accommodating four persons. One of the most important conditions is the limiting of the fuel supply, but one gallon being allowed for every twenty-five miles of average dry road; or only enough for a speed of twenty-five miles an hour.

Though the prizes will be awarded on the basis of speed, it is evident that the ordinary features of a road race will be lacking; in the first place, the large and powerful racing machines will be specifically excluded by the conditions of entry; second, the car which is driven at top speed will in all probability run short of fuel before the end of the course.

It would seem that the conditions are such as to favor directly those engines which are most economical in consumption and those cars which have the most efficient transmission, while the skill and good judgment of the drivers will be severely tested.

This contest presents some features different from those for the Glidden touring trophy, which will be held in this country next summer, the latter being really a tour of ten days' duration. It is possible that a shorter contest on the lines of the English event might also prove popular here and attract entries from those whose time does not permit the longer course.

**Finality in Automobile Design.**

The everyday practicality of the automobile being fully established, as well as its capabilities for dangerous and useless speeds, the next steps in the line of advance are obviously the improvement of the roads to a point where they are usable by all vehicles at all seasons, and the production of reliable cars of moderate speed and at prices within the means of the average user of a horse-drawn carriage. With these two ends even partially attained the automobile will no longer be limited to certain classes in the community, but will take its place with such popular institutions as the horse and carriage and the typewriter in contributing to the advance of civilization.

The first step toward any material cheapening of production must be the acceptance of some one or two final standards of design, thus eliminating the necessity for costly experiments. Another serious drawback which has thus far existed is the uncertainty in the minds of users and intending buyers as to the advantages to be gained by waiting for the next new model. With such finality of design attained in the automobile as has long existed in the horse-drawn carriage, and with a similar standardization of parts, makers will be free to concentrate their attention upon the production of more efficient but less costly vehicles of every grade.

That finality of design is at least within sight is indicated alike by the exhibition of 1905 cars just closed in Paris and the descriptions of the cars now preparing for the New York show.

The vital elements of the automobile are already firmly established—the steering knuckles on the front axle, the differential in the rear axle or countershaft, the form and construction of the chassis, the wheels, tires, springs and brakes, the motor and its place at the front, the change-speed gears, the two transmission systems by chains or central shaft, and the forms of bodies for various uses.

There are, it is true, almost unlimited possibilities of improvement in such lines as electric propulsion, mixed gasoline and electric systems, electric speed change, four-wheel drive and steer and other devices as

yet in the experimental stage, any one of which may in a day almost revolutionize the automobile and necessitate radical and costly changes in models and methods and an entire readjustment of all conditions of making and marketing. In spite of this, however, the indications now are that for some time to come the makers will be free to deal with the two subjects of perfection of detail and economy of construction, while the change from one year to the next will be far less marked than in the past, with proportionately greater inducement to the intending buyer to purchase and use a thoroughly reliable car rather than to wait indefinitely for something better.



Car and Launch Racing in Cuba.

The program of winter sports, which in two years has been greatly lengthened by the institution of automobile races in Florida, will be still further extended this season. The automobile races on the Florida sands will be supplemented by auto boat races on the adjoining waters, and following these events the cars and launches will be transferred to Cuba. A reliability run is already arranged for auto boats from Florida to Havana, the smaller launches being shipped by steamer, and other races and trials will take place subsequently in Havana Harbor.

From the glowing accounts of the adventurous pioneers who have invaded Cuba in the cause of the automobile a veritable paradise for road racing has been discovered—a smooth, even, hard-surfaced road of fifty miles, available by official permit for unlimited speeding. The material advantages, the novelty of the trip and the possibilities from a business standpoint, will probably attract a large attendance of the representatives of both the sport and the industry.

The discovery and prompt utilization of such new courses, free from many of the objections of the northern roads, is well worth the attention of the authorities of Long Island and other similar sections. If, as many maintain, a great race, such as that for the Vanderbilt trophy or the Gordon Bennett cup, is of financial value to a community, then some active measures will be needed in the line of road improvement and of hearty and voluntary coöperation with those in charge of the race to offset the attractions of the semi-tropical courses.

The competition of heavy oils arranged by *L'Auto* for this month in France, has been postponed until the latter part of March, it being considered that the winter weather was not suitable for such a test at this stage of heavy-oil development. This decision has aroused Mr. Gautreau, maker of the carbureter bearing his name, who has issued a personal challenge for a test this month from Paris to Rouen and return for a stake of 1,000 francs. The points of the competition are to be the total fuel consumption per ton kilometer; the proportion of the mixture of heavy oil and the time during which the motors fail to act.

CUBA TOURNAMENT TO FOLLOW FLORIDA.

One Hundred-Mile Road Race from Havana to San Cristobal and Back a Feature of Three-Day Carnival to Open February 9—Auto Boat Endurance Run and Races.

It is now practically certain that an automobile race meet will be held at Havana, Cuba, commencing February 9, and continuing three days. W. J. Morgan and S. A. Miles, of New York, who journeyed to Havana for the purpose of making preliminary arrangements for the carnival, had an interview with President Palma on December 15 and were well satisfied with the result. The President expressed himself as being personally strongly in favor of the movement, chiefly on account of the prominence into which Cuba would be brought through the publicity that would be given the races, and because the wealthy men who would visit the island would doubtless investigate its conditions and possibly become further interested in it. A conference between the President and some of the government officials was necessary before a definite reply could be given, but the automobilists were assured that there was little doubt of satisfactory arrangements being made.

Later the same day Messrs. Morgan and Miles met, at the office of Secretary Mendoza, of the Cuban Automobile Association, a number of prominent Havana men interested in the project, and submitted tentative programs for a three days' carnival, to include a road race from Havana to San Cristobal and return to Camp Columbia, a distance of about 100 miles; short races in Havana; illuminated and floral parades on the Prado, and auto boat races in the harbor. Complete and final arrangements will be made at once, as the government has arrived at a decision in the matter.

On the day previous to their interview with the President, Messrs. Miles and Morgan were driven in an automobile over the roads on which it is proposed to hold the long distance race, Manager Lopez, of the Havana Garage Company, acting as

host. The visitors declared the roads to be among the finest they had ever seen, and that should the meet be carried out, enormous speeds should be made by the big cars.

The policing of the course will be particularly well attended to. Members of the Havana Rural Guard and of six bicycle clubs will be available for this purpose, and it is expected that it will be possible to have men stationed a hundred yards apart along the entire course. The distance, to be exact, is 160 kilometers, and is marked by kilometer posts. The road surface is of limestone, from twenty to thirty feet wide, and Mr. Morgan states that there are several straight smooth stretches from ten to fifteen miles long, where the highest speeds can be attained. San Cristobal will be a control and the usual long-distance race control rules will be in force there. Señor Diaz, Secretary of Public Works, who is himself an automobilist, states that the road, which is government property, will be placed in perfect condition before February 9, the day set for the race. United States Ambassador H. G. Squires, also an enthusiastic automobilist, is doing all in his power to aid in making the affair a success.

About fifty automobiles are owned in Havana, all large cars of European manufacture, and the owners are much pleased at the prospect of a modern automobile tournament on their own roads.

Mr. Morgan returned to New York this week, bringing the news that all the plans are working out satisfactorily, and that the Cuban government has granted the necessary permit to hold the races at Havana. He states that entries are already coming in, among those already received being a F.I.A.T. and Pipe entry.

Automobilists who desire to take their cars to Cuba for use temporarily will be permitted to do so free of duty, provided a bond is posted amounting to at least double the amount of the duties that would be payable under other circumstances; and further, provided that the automobiles are for personal use only and not intended for sale, hire or other commercial purpose. The time during which cars may remain in Cuba under these conditions will be fixed at the discretion of the Collector of Cus-

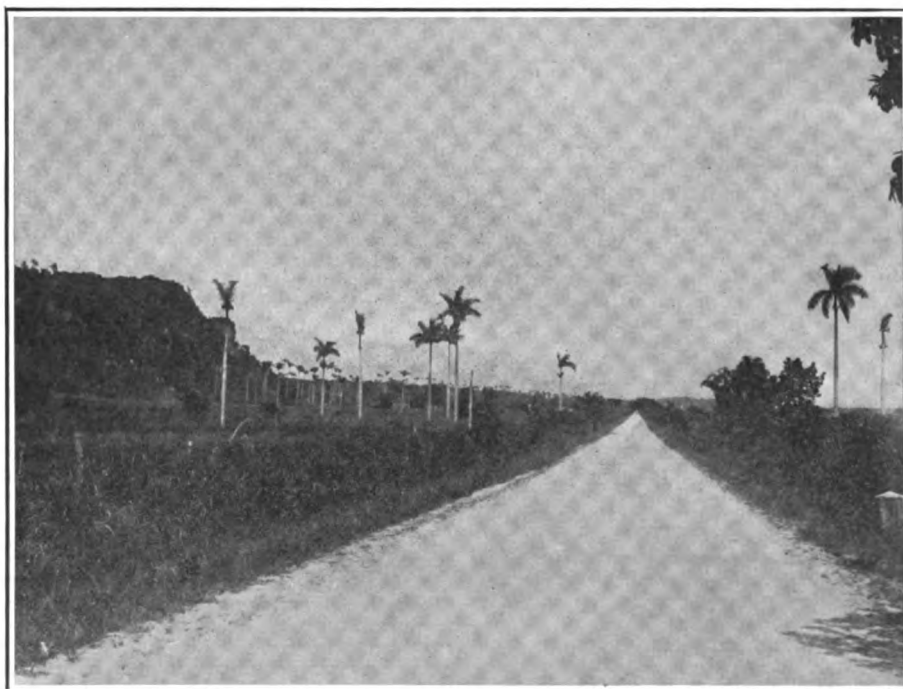

SECTION OF FIFTY-MILE ROAD IN CUBA ON WHICH 100-MILE RACE WILL BE HELD.

toms, but will not exceed six months. The importer is required to make a declaration of his purpose in bringing the car into the country, which being done to the satisfaction of the Collector, the machine will be admitted as "an article for personal use."

Arrangements will be made with the P. & O. steamship company to transport the automobilists from Miami to Havana. An endurance contest for auto boats will be held, the course being from Palm Beach, Florida, to Havana, and those boats which do not take part in this event will be carried across on the P. & O. steamer.

After their conference with the President, Messrs. Morgan and Miles left for Daytona, where they conferred with the Florida East Coast Automobile Association concerning arrangements for the tournament.

One of the reasons given by President Palma for his interest in the proposed tournament at Havana was that he was much interested in the good roads movement, and that, recognizing the influence of the automobile on road improvement, he favored any legitimate plan that would bring automobiles to Cuba.

HALF CENTURY OF RECORDS.

Oldfield Annexes All Records to Fifty Miles in California.

Special Correspondence.

LOS ANGELES, Dec. 24.—Barney Oldfield and his Peerless *Grene Dragon* now hold all track records from one to fifty miles, inclusive, not excepting the nine-mile figure of 8 minutes 17 seconds heretofore held by Charles Basle, who made it with a 90-horsepower Mercedes car. This was the only record not in the possession of Oldfield after the fifty-mile trial at Fresno on December 13, and he chopped a flat 13 seconds from this at Agricultural Park in this city, last Thursday, doing the distance in 8 minutes 4 seconds, and making the list of records in the heavy-car class an exclusively Oldfield-Peerless affair. Incidentally he lowered his own records from two to nine miles, the times being as follows: Two miles, 1:46 2-5; 3 miles, 2:39 4-5; 4 miles, 3:35; 5 miles, 4:29; 6 miles, 5:22 2-5; 7 miles, 6:15 4-5; 8 miles, 7:09 1-5; 9 miles, 8:04.

The record for fifty miles was captured by Oldfield at Fresno last week, the new figure being 48 minutes 39 1-5 seconds, better by 7 minutes 2 4-5 seconds than the best previous record for that distance, made by Charles Gorndt at Cleveland in October last with the *Winton Bullet No. 3*. A light rain fell during the morning of the day of the Fresno trials, and put the track in grand condition, laying the dust. Oldfield covered the first mile in 56 2-5 seconds, the next four in 55 2-5 seconds, and the sixth in 55 1-5 seconds, the sixth being the fastest mile of the fifty. At fifteen miles the time was announced as 14:3 3-5, a new world's record. From sixteen to twenty miles he failed to better his Denver figures, but from the twenty-first mile to the end of the trial he set new marks. Twenty-five miles was made in 23:39 3-5. After this point the *Green Dragon* was allowed to slow up slightly, the succeeding five miles being covered at the rate of about 60 seconds each. Thirty miles were made in 28:38 4-5—nearly five minutes to the good. After this the miles were covered with great regularity at the rate of about a mile a minute until the forty-ninth, when the motor, apparently feeling the strain of the long pull, began to act somewhat queerly, and that mile took 65 seconds. The last mile was made in 63 seconds.

RULES FOR ENGLISH TOURING CAR CONTEST.

Strict Touring Conditions to Govern Race on Isle of Man Over Course of 150 to 250 Miles for Tourist Trophy—Classification for Auto Boat Reliability Trials.

Special Correspondence.

LONDON, Dec. 16.—The Automobile Club of Great Britain and Ireland has been extremely busy of late, arranging next season's contests, and from all tokens 1905 will see England well to the front in motoring events, which absolutely chase one another and comprise contests of every kind.

Of much interest to the world at large is the new cup which the A. C. G. B. I. is presenting for a touring car competition next season, as the outcome of many meetings to consider the question of testing these vehicles under reasonable conditions with a view to absolute efficiency. The prize has been named the Tourist Trophy, and will be competed for annually, the first race taking place next September, probably over the Gordon Bennett elimination course on the Isle of Man. As the event is international, the following conditions may be of interest to American automobilists:

The distance of the race, including controls, shall not be less than 150 and not more than 250 miles. The fuel to be used shall be provided by the club and be petroleum spirit having a specific gravity of 0.695 to 0.705 at 60 degrees Fahrenheit. The allowance of petroleum spirit shall be determined by the club according to the nature of the course selected and the conditions of road surface on the day of the race. The car completing the course in the shortest time shall be the winner, subject to compliance with these regulations, and the entrant of the car shall become the holder of the trophy. The weight of the chassis shall not be less than 1,300 pounds nor more than 1,600 pounds; batteries and other ignition apparatus, tires on the wheels, bonnet, tanks (empty), dashboard, steps, lamp brackets and front mudguards shall be treated as part of the chassis. No ignition battery, magneto or other source of electric energy shall be carried except those fixed to the chassis at the time of weighing. The load carried by the chassis, exclusive of fuel, oil and water, spare tires, spare parts, luggage and provisions, shall not be less than 950 pounds, including the body with rear mudguards and their stays, floor boards and lamps, driver with one passenger, averaging not less than eleven stone (154 pounds) each, and not less than 300 pounds of loose ballast in the portion of the body in which the two unoccupied seats are situated. The body shall be of the ordinary touring type, properly upholstered, comfortably seated for driver and three passengers facing forwards, two in front, side by side, and two behind, side by side. Efficient mudguards to rear wheels shall be fitted to the body.

Between the start and finish of the race the driver and his passenger shall alone be permitted in any way to assist a car, and no stores, supplies, spare parts or spare tires other than those actually on the car at the start shall be taken on during the race. Everything, except fuel, which is on the car at the start must be carried throughout the race. No more than two cars by one manufacturer will be accepted; the minimum entrance fee shall be £20 (\$100) per car. Every car shall be provided with fuel tanks capable of holding no less than twelve gallons, and no other fuel shall be carried except that provided by the club.

Entries will be received at the A. C. G. B. I. at 119 Picadilly, London, W., and forms and full regulations will be forwarded from the same address.

POWER BOAT RELIABILITY TRIALS.

The provisional rules for the next reliability trials for power boats are now out. They are quite similar to the ones issued during the waning season, when the trials were held on Southampton waters immediately preceding the British International Cup race for motor boats.

The trials will be held over a period of ten hours daily for two days, and an innovation has been made in the classification, which now includes six classes: A, yachts' dinghies (clench built), not exceeding 15 feet over all; B, yachts' launches (clench or carvel), not exceeding 20 feet over all; C, yachts' launches (c. or c.), not exceeding 25 feet over all; D, yachts' launches (c. or c.), not exceeding 30 feet over all; E, unrestricted vessels of any description propelled by internal combustion engines and not exceeding 25 feet over all; F, unrestricted vessels of any description propelled by internal combustion engines and exceeding 25 feet over all. The two unrestricted classes are a new addition.

AUTO SCHOOL EXTENSION.

Day and Night Courses to Be Held the Year Around in Boston.

Special Correspondence.

BOSTON, Dec. 26.—Extensive and important changes will be made in the Boston Y. M. C. A. with the beginning of the new year. This school, which was the first of its kind in the country, met with great success last year. It reopened this fall upon practically the same lines as last year, but before the first term was ended it was found that radical changes would be necessary to meet the demands of the pupils.

The most important of the changes that have been decided upon by the advisory board is that the school shall be in operation the year around, instead of merely during the winter months. Private instruction will be given, and there will be special facilities for women students. A competent instructor will be in charge and will instruct upon any type of vehicle. Another notable change is the establishment of a day school. Hitherto instruction has been given only in the evenings, but it was found that there was a large number of business men who did not care to devote their evenings to the school but who would attend classes if they were held on afternoons. The day school will open January 2 at 4:30 p. m. There will be lectures on steam vehicles from 4:30 to 6 o'clock on Mondays and Thursdays, and on gasoline vehicles Tuesday and Friday afternoons between the same hours. The instruction will include shop and road work and arrangements have been made for instruction upon any particular type of car.

The second term of the regular school opens to-morrow evening with the gasoline lecture in charge of Albert L. Clough. The school, with the changes that have been made, will be more comprehensive than ever before, to meet the needs of all classes of motorists. The chauffeurs' department is also a success, students of the school finding ready employment and owners being supplied with competent drivers.

TOLEDO Y. M. C. A. SCHOOL.

Special Correspondence.

TOLEDO, Ohio, Dec. 26.—The local Y. M. C. A. is to open an automobile school which

is to be ready for the enrollment of students by September 1, 1905. The decision to open the school was reached as a result of the receipt of almost daily requests for a school either by officials of the association or some of the local automobile dealers.

The board has not yet determined how extensive a course it will offer, but it will be divided into three courses. The first will take up the construction of the automobile, the second the automobile as a scientific product, and the third the operation of an automobile. The courses are to be illustrated with photographs and drawings and parts of machines will be exhibited. All the leading makes of cars will be taken up and the distinguishing features explained to the pupils. Manufacturers will be asked to furnish such material as they can that will be of assistance to the instructor and the pupils. Local automobile dealers will lend all possible assistance.

A FAREWELL LUNCHEON.

Paul Deming the Guest of Honor at Luncheon Given by White Company.

A farewell luncheon was given to Paul H. Deming, the retiring manager of the New York branch of the White Sewing

tion to Mr. Deming. Others who made speeches were Winthrop E. Scarritt, ex-president of the A. C. A., and Mr. Arozarena, of the City of Mexico. Upwards of sixty well-known automobile owners and members of the trade were guests of the White company on the occasion.

SYRACUSE CLUB BANQUET.

Invitations Out for Third Annual Affair to Be Held January 3.

Special Correspondence.

SYRACUSE, Dec. 26.—Invitations are out for the third annual banquet of the Automobile Club of Syracuse, which will be one of the principal local social functions of the winter. At a meeting of the club last Thursday night, the members voted to hold the banquet Tuesday evening, January 3, at the Yates Hotel. It is the opinion of the club that the annual banquets assist greatly in maintaining the prominence of the organization and in winning new members.

A banquet committee, of which Hurlburt W. Smith is chairman, and C. Arthur Benjamin, Carl L. Amos, Secretary-Treasurer Elliott and President Willet L. Brown are

erty situated on the Lakeview Boulevard two miles and a half from the city.

While such a proposition has been brought forward, the automobilists say that it was advanced by the yachtsmen, who wish to increase the interest in and attendance at the yacht club. The members of the automobile club appreciate the fact that there would be many advantages to be gained by acquiring the privileges of a handsome clubhouse, but they do not wish to saddle themselves with the expense which the move would entail, it being known that there are one or two heavy mortgages on the yacht clubhouse.

The automobilists have received offers of suitably equipped club rooms from a couple of local garage companies, but these they have refused to accept, having noted the trouble which the acceptance of similar offers has brought to certain clubs, and will remain without a clubhouse until they can build one of their own.

President Brown has been selected to attend the annual meeting of the American Automobile Association in New York, January 16, as the club's representative. Hurlburt W. Smith was elected alternate.

The annual election of the local club will be held January 9 and a nominating committee is already preparing the list of officers to be voted upon at that time.

Sigmond Krause has been elected to membership in the club and a number of others are on the waiting list. The prospects are for an excellent season in 1905.

CHICAGO A. C.'S UNIQUE LUNCHESES.

Special Correspondence.

CHICAGO, Dec. 26.—The Chicago Automobile Club is achieving more than local notoriety through a series of novel dinners and luncheons that are being served Thursday noons at the Michigan Avenue home of the organization. John Farson, the president of the club, famous for his injunctions against the city's automobile ordinances and for his crimson ties, is the originator of the idea.

"A fifty cent luncheon," announces the weekly bulletin. "Gasoline soup, au naturel, wind tire pudding and scrambled sprockets."

Next Thursday a New Year's dinner will be given. These club functions have made the clubhouse a popular meeting place for the members. While they are waiting for the New York and Chicago shows and for the Ormond-Daytona races, the entertainment committee has arranged a number of evening theatricals. President Farson has also figured in these. His name, slightly transposed—"Farse Johnson"—was the title of a "burnt cork" show that will be repeated in Steinway Hall January 25.

KANSAS CITY CLUB AFTER MEMBERS.

Special Correspondence.

KANSAS CITY, Dec. 26.—Although there are 300 motorists in the city, only a third of them belong to the Automobile Club of Kansas City. At a recent meeting it was decided to remit the initiation fee to new members temporarily. A radical departure was the employment of a solicitor to see all motorists in the city and urge them to join the club. This is especially desirable, since a suit to test the legality of the city ordinance regulating the use of automobiles is now pending in the local courts and the motorists wish to present a united front in the fight. The club has made no decision regarding a clubhouse, but will attempt to secure one in the spring on one of the boulevards, preferably near one of the parks.

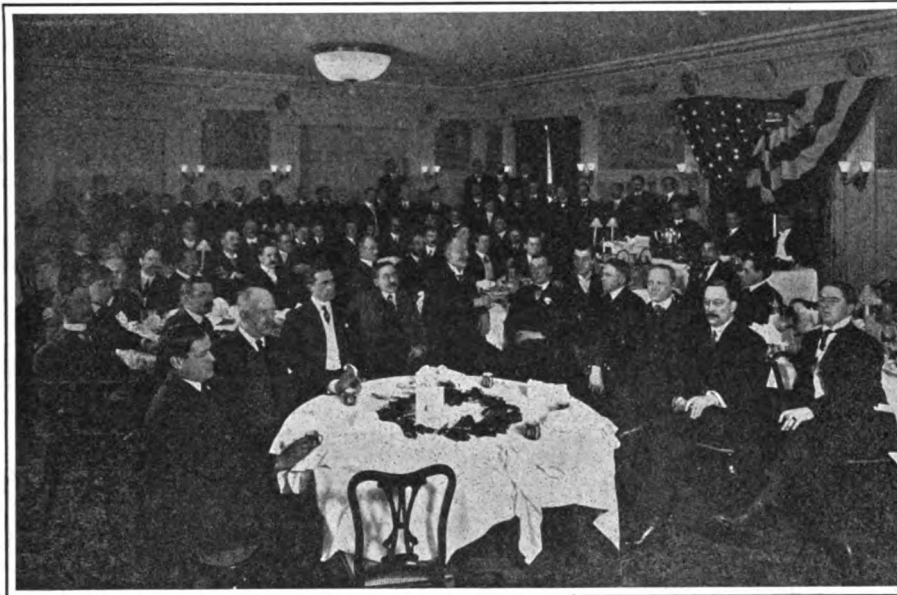

FLASHLIGHT PHOTOGRAPH OF AUTOMOBILISTS AT FAREWELL LUNCHEON TO PAUL DEMING.

Machine Company's automobile department, at the Hotel Astor, New York, on Thursday, December 22. Mr. Deming has been identified with the White branch since its first establishment in New York—in fact, he drove the first White car from Philadelphia to New York in May, 1901, and the following year the White garage was opened on Nineteenth street. Each succeeding year the business has expanded under Mr. Deming's management, and this year the fine premises on Sixty-second street were remodeled for the sale and care of White cars.

Mr. Deming, who relinquishes his position on January 1, to take up his residence in the West, was presented at the dinner with a handsome silver loving-cup, which was first filled with wine and sent the rounds of the tables. When the "psychological moment" came Windsor T. White, who with Mr. Deming on his right and Carl Page on his left, occupied a position of honor at an elevated table, introduced Mr. Page, who in turn made the presenta-

members, was appointed. Henry Walters, a prominent local attorney, has been asked to act as toastmaster. Among the invited guests are Mayor Alan C. Fobes, Commissioner of Public Safety Ralph S. Bowen, Corporation Counsel Walter W. Magee, Police Justice Frederick W. Thompson, Congressman Michael E. Driscoll, State Senator Horace White, Assemblyman Fred W. Hammond, Frank X. Wood, Edward Schoeneck, and Martin L. Cadin, Chairman Robert Gilman and the Highway Committee of the Onondaga County Board of Supervisors, President William H. Hotchkiss of the New York State Automobile Association, Harlan W. Whipple, president of the American Automobile Association and Frank D. Lyons, of Binghamton. Automobile club members of the nearby cities will be present also.

Officers of the club deny the report which has been extensively circulated that the organization would coalesce with the Syracuse Yacht Club and become a half owner in the magnificent yacht club prop-

MANY CHANGES IN CLEVELAND CONCERNS.

Baker Company Acquires Large Agency and Garage Business—Ohio Oldsmobile Company Leases Another Store—Peerless Moving into New Plant, and Reo Agency to Open.

Special Correspondence.

CLEVELAND, Dec. 26.—Several changes will be made by Cleveland retail concerns for next season. The Baker Motor Vehicle Company has acquired the establishment and business of the Automobile Garage & Repair Company on Huron street, but will carry on the business under the old name for the time being at least, with the agency for the Packard and Autocar lines. The second floor of the large Huron street establishment will be fitted up for the sale of Baker electrics. This branch of the business will be managed by the Price Brothers Carriage Company, which has had the Baker agency for several years, and whose contract still holds. The sale of the gasoline cars will be in charge of a representative of the Baker company and a repair shop will be fitted up where electrical work will be taken care of, as well as repairs to gasoline and steam vehicles.

R. H. McGoon, agent for the Pope-Toledo line, has leased a store at 390 Erie street, where he will continue to handle the same line.

CLEVELAND MOTOR CAR CO. OPENS STORE.

The Cleveland Motor Car Company, a new concern headed by W. L. Colt, formerly with the Federal Mfg. Co., has opened a store at 398 Erie street, where he will handle the Cleveland, a new car built to Mr. Colt's order by the Federal company. These two concerns, together with T. C. Whitcomb, who handles the Rambler and Ford, and the Ohio Motor Car Company, which handles the Columbia and Cadillac lines, gives the vicinity at the corner of Erie and Prospect streets four large automobile stores.

B. T. & N. A. Quilling, who for several years handled the Geneva steam vehicle at 254 Euclid avenue, have withdrawn from the field and have leased their store to the Ohio Oldsmobile Company, which will handle the Olds and Franklin lines. Ralph Owen, who is at the head of the concern, will also retain the establishment at 411 Euclid avenue, using it as a storage and repair shop. The Ohio Oldsmobile Company did a good piece of advertising this year by furnishing Uncle Sam with several delivery wagons and operators for collecting mail and packages from mail boxes and branch post offices during the Christmas season.

Otto Owen, who has been with his brother, Ralph Owen, for several years, will open a downtown store, handling the Reo, for which R. M. Owen, of New York, another brother, is general sales agent.

The F. B. Stearns Company will have no agencies this year, and with the exception of an old established agent in Boston, will handle all its cars direct. Mr. Stearns is increasing his facilities and expects to build an even 100 cars this season, all of them high-priced machines.

PEERLESS MOVING TO NEW FACTORY.

The Peerless Motor Car Company has done some remarkable construction work on its new plant, and expects to commence moving into the first of its buildings this week. Other buildings will be erected as soon as possible, and in the meantime work will continue in the old factory. The company built nearly 300 cars in 1904 and ex-

pects to increase this output considerably the coming year.

The Meriam-Abbott Company, manufacturer of gas engine charging outfits, has consolidated with the Bruce Company, manufacturer of gas engines under the name of the Bruce-Meriam-Abbott Co. The factory will be located on Columbus street, the headquarters of the old Bruce company. The lines will be continued and the business expanded. The Meriam-Abbott charging outfit makes it possible to generate current for charging electric vehicles at any time and without the necessity of having city wires run into a barn or garage.

The Perry-Payne Company has commenced work on a large building 125 by 500 feet, at the corner of Murison and Erie streets. The building is designed as an automobile garage, but it is not known what concern will occupy it.

TO BUILD THE IROQUOIS.

Newly Incorporated Company to Begin Making Touring Cars January 1.

Special Correspondence.

SYRACUSE, Dec. 27.—Papers were filed with the Secretary of State at Albany and the clerk of Onondaga County to-day incorporating the Iroquois Motor Car Company, with a capitalization of \$450,000. Charles A. Fox, of the firm of Fox & Rich, of this city, promoted and organized the company, the incorporators of which are: Thomas W. Pelham and Frank H. Clement, of Buffalo; Charles T. Blanchard and L. Frank Ormsbee, of this city, and Leonard F. Mahan, of Fayetteville.

The company will establish a factory and commence the manufacture of cars January 1. There will be a meeting of the incorporators within a few days to decide upon a site. Several offers have been received, and the company has an option on two factories.

The company will manufacture the gasoline touring car formerly built by the J. S. Leggett Company, of this city. Mr. Leggett, it is understood, will be connected with the Iroquois company.

RACING GOBRON-BRILLIE COMING.

Announcement is made by the management of the Importers' Automobile Salon, to be held in Herald Square Hall, New York, January 11-24, that all floor space has been taken by exhibitors, the last applicants being the manufacturers of the Gobron-Brillie and of the Léon Bollee cars. The former will be shown for the first time in this country, and it is anticipated that the exhibit will include one of the famous racing cars of that make. Liberal allotments of space have been made to exhibitors, each of whom will show from three to ten cars. The total number of exhibitors is now forty-one, and the list includes manufacturers of bodies, parts and accessories, tires, clothing, etc., as well as complete cars.

CLEVELAND SHOW ALLOTMENTS.

Special Correspondence.

CLEVELAND, Dec. 26.—Allotments for the Cleveland automobile show will be made tomorrow. Secretary George Collister, of the Cleveland Automobile Club, who is in charge of affairs, has received applications for all the space that can be provided. There will be fifty-eight spaces. Many more than that could be filled if the hall were larger, which emphasizes Cleveland's need for a large exhibition hall; also it brings out the importance of Cleveland as a center of the industry.

NEW ROCHESTER ENTERPRISE

United States Automobile Co. to Erect Large Garage at Once.

Special Correspondence.

ROCHESTER, Dec. 26.—The United States Automobile Company of Rochester has been incorporated with \$200,000 capital stock, to buy, build and sell automobiles, boats, engines and parts and supplies, and to conduct a garage, livery and repair business.

The company has acquired the lease of a store at the corner of Main street East and Elm street, and will use the entire store as a sales and show room. The temporary offices of the company are on the second floor of this store. In addition, the company is planning to erect three garages in the city which are to be among the finest and most perfectly equipped in the country. It is proposed to build a central garage at once. This building will be two stories high and cover an acre of ground. It is planned to have the general offices of the company in the second story and to fit up a clubroom which will be offered to the Automobile Club of Rochester for the use of its members. James A. Barhite, former master mechanic of the Buffalo, Rochester & Pittsburg railroad, is to be in charge of the main repair rooms and have supervision over all the branch shops.

The following officers have been elected: President, Harry S. Woodworth; treasurer, Henry H. Love; secretary, Austin F. Crittenden; directors, Henry S. Woodworth, J. Foster Warner, Charles F. Garfield, John A. Barhite, Austin F. Crittenden and Henry G. Day. All are of Rochester, with the exception of Mr. Day, whose home is at Providence, R. I.

GOOD OUTLOOK IN NASHVILLE.

Special Correspondence.

NASHVILLE, Dec. 26.—The numbering ordinance has gone into effect without friction between motorists and authorities and seventy-nine cars are now registered. A few more are still to be reported, as Nashville has a total of about eighty-five cars of various makes.

Few cars have been placed in storage for the winter, as the naturally mild climate has been even more pleasant than usual during the fall and early winter. Nearly all the cars are in active use on the streets and the country roads.

Dealers expect a heavy trade next year and several of them will add new makes to their now limited lines. John W. Chester, who handles the Oldsmobile, will add the Winton next season. The Southern Automobile Company, which has sold a dozen White steamers this season, will add the Autocar to supply the demand for a gasoline car. The new model White has been received by the agents and several orders for spring delivery have been booked.

A new and up-to-date garage will be opened next month by the Southern Automobile Company and will have storage capacity for forty cars. It is intended to make it the most complete storage and repair establishment in Nashville.

The run of 4,000 miles over English roads, made by Captain Deasy in a 16-horsepower Martini car, terminated December 7. Starting November 14, and continuing on every week day, this run was the first private trial under official recognition and official checking, the observers being provided by the A. C. G. B. & I. Most of the driving was done by Captain Deasy personally, though two assistants relieved him at times.



Announcement is made by the American Daimler Co., whose shops are at Astoria, Long Island, that American Mercedes cars of 40-45-horsepower, exact duplicates of the German Mercedes machines, will be ready for delivery by the end of January. These cars, manufactured under rights from the patent firm, will be built of material made to the specifications used in the German cars, and in some cases the parts themselves will be imported—axles, steering gears and ball bearings, for instance. Owing to delays in securing necessary material, it is probable that the chassis which will be exhibited at the Madison Square Garden automobile show, in New York city, will be incomplete. Some finished parts will also be exhibited. It is intimated that the price, which has not yet been announced, will be a point much in favor of the car. A complete working reorganization has been effected at the Astoria plant.

R. M. Owen, sales manager for the Reo Motor Car Co., of Lansing, Mich., has returned to New York after a trip of more than two weeks through the West, and reports the establishment of a number of agencies for the Reo cars. The Reo Automobile Co. has been formed at Chicago with C. H. Foster, of the Oakley National Bank, as president. The Reo Automobile Co. will handle the Reo car at St. Louis, and the Reo Automobile Co of Ohio, recently formed at Cleveland, will look after the business in that section. Meadows & Hafer, of Buffalo, have been given the agency in that city. Work at the factory at Lansing is reported to be more than a week ahead of schedule, and prompt deliveries are assured. The cars of this company will be exhibited at the New York and Chicago shows, as well as at Boston, Buffalo, Cleveland and Philadelphia.

The report of the first annual convention of the Monroe County, N. Y., Good Roads Association, held in the Rochester courthouse October 10 and 11, has been issued in pamphlet form. The report is of interest to automobilists not only because every move in the direction of road improvement interests them, but also because the automobile played an important part in the proceedings. At the close of the convention members of the Rochester Automobile Club took the members of the meeting for a tour over some of the improved highways in the neighborhood of Rochester, covering a distance of about fifty miles, twenty-six automobiles being used. The convention delegates were the guests of the Automobile Club at Maplewood.

The youngest Kansas chauffeur lives in Powhattan. His father taught him to run his automobile, and one bright morning, when father was away from home and the other members of the family were not looking, he went to the barn, got the car out and was just starting for a spin down the street when his mother interfered. As she could not run the car, the child accommodatingly took it back to the barn. The story does not say what happened then.

The Adams Company, of Dubuque, Iowa, makers of the Adams-Farwell revolving-cylinder automobile, will, in addition to exhibiting in the Chicago automobile show, have an exhibit in a store on the opposite side of the street from the Coliseum. Here the motor can be shown in operation, which

cannot be done in the Coliseum on account of the rule prohibiting the use of gasoline in the building. It is expected that the peculiar construction of the machine will attract a large number of interested persons, and every effort is being made to provide a complete exhibit.

The government is advised that a new law has come into operation in Argentine Republic, whereby the duty on finished motor cars and motor vehicles of all kinds, together with spare parts and fittings, imported into that country, has been fixed at the rate of 10 per cent ad valorem. Under the old law motor cars paid duty at the rate of 50 per cent ad valorem. To the new duty has to be added the duty of 2 per cent, which is leviable on articles subject to a tariff duty of 10 per cent ad valorem or more.

The management of the Madison Square Garden automobile show is calling attention to the fact, already referred to editorially in THE AUTOMOBILE, that only members of the American Automobile Association and the American Motor League are entitled to reduced railroad rates during show time. Members or intending members may obtain information on the subject by addressing C. H. Gillette, secretary of the A. A. A., 39 West 42d street, or Isaac B. Potter, president of the A. M. L., Vanderbilt Building, New York City.

A paper chase has been planned for New Year's in Kansas City and a dozen entries have already been received. The hares probably will be H. L. Loose with a Pope-Toledo; Henry C. Merrill, with a White, and J. F. D. Moriarty, with a Stevens-Duryea. The hounds will probably have several Pope-Toledos, a White, Packard, Locomobile, Winton and several smaller cars. The chase is to be for about forty miles on macadam roads south of Kansas City.

S. K. Dingle and G. M. Wetherbee have purchased the interests of Messrs. Phelps & Taylor in the Boston Automobile Exchange, 177 Berkeley street, Boston. Mr. Dingle, who has been manager of the concern for the past four years, will continue in that capacity, while Mr. Wetherbee will be in charge of the sales department. The company has secured the exclusive agency for Boston and vicinity for the Phelps gasoline cars, manufactured by the Phelps Motor Vehicle Co., of Stoneham, Mass.

The Jackson Automobile Co., of Jackson, Mich., announces having placed agencies for its cars as follows: Chicago and southern Illinois, Hagmann & Hammerly; Chicago; Cincinnati, O., Charles Haupner; Terre Haute, Ind., Hilderbrant Buggy Co.; Akron O., Charles E. Howland; Buffalo, N. Y., Jackson Automobile Co.; Boston, Mass., E. P. Blake & Co.; Trenton, N. J., W. P. Conrad; Buenos Ayres, South America, A. P. Guillard.

The Commercial Automobile Co., of 1336 Michigan avenue, Chicago, selling agent for the Synnestvedt electric automobiles, has received a report to the effect that a Synnestvedt electric omnibus was successfully run in Atlantic City, N. J., during a recent heavy snowstorm which tied up most of the traffic, and that it was the only motor vehicle to remain in service. Snow and slush covered the ground to a depth of eight inches.

While there was considerable business on account of the holidays in "automobile row" in Chicago the dealers said that there was every promise of the heaviest business in the history of the automobile during the coming spring. Every large manufacturer is represented in the number who are on the lookout for larger display and store rooms. There have been a number of realty transfers during the last week in the vicinity of the "row."

H. E. Shiland for the past three years head salesman for Birney A. Robinson's garage in Worcester, Mass., has severed his connection with that concern and it is announced has formed a copartnership with Jesse O. Norcross. The new firm expects to open a store immediately, with a line of machines including the Autocar, which has been handled this past season by Mr. Robinson.

A Chicago man who drove a Locomobile car during the past season has discovered that since taking up automobiling he has been entirely free from asthma and other throat and lung troubles with which he was formerly afflicted, and his daughter, who was similarly troubled, has experienced the same relief. "This is a new one on us," writes the Locomobile company, "but it sounds good."

The Cook & Stoddard Co., which recently opened a garage at 1028 Connecticut avenue, N. W., Washington, D. C., has leased the adjoining building and will cut an archway through from the present quarters. The new part will be used for the electric department. The company's line for 1905 will consist of the Winton, White, Orient, Baker, Cadillac and Stevens-Duryea.

A novel idea has been put into practice by the Lichtie Automobile Co., 822 Jefferson avenue, Toledo, O. This concern has inaugurated a physician's emergency call service, providing small enclosed touring cars in which doctors will be hurried to their patients at any hour of the day or night by drivers employed by the company. The business is reported to be increasing.

A three-story addition to the offices of the Diamond Rubber Co. at its factory in Akron, Ohio, will be ready for occupancy very soon after January 1. The additional space provides increased room and facilities for the tire and executive office departments. The Diamond company has also this season added extensively to its factory equipment in the tire and other departments.

The "Boss of Philadelphia," Israel W. Durham, received a belated Christmas present in the shape of a \$4,000 Panhard, which came over on the *Rhyland*, which, owing to the storms that beset the craft on her passage, did not reach the Quaker City in time to be tucked away in the "Boss" stocking on Christmas eve.

During the ten months ending October, 1903, automobiles to the amount of \$561 were exported to Porto Rico from this country; for the same period in 1904, \$25,171. For the same periods the exports to Hawaii showed an increase from \$3,428 in 1903 to \$15,343 in 1904.

The annual automobile number of *Collier's Weekly* will appear on January 21, 1905. Announcement of the fact is made in

AMERICAN AND FOREIGN AUTOMOBILE AND AUTO-BOAT FIXTURES.

- Dec. 26-Jan. 2.—Reliability Trials. Motor Union of Western India. 883 Miles Reliability Trial, Delhi to Bombay.
- Jan. 11-24.—First Annual Importers' Automobile Salon. Herald Square Hall, New York.
- Jan. 14-21.—Fifth Annual Automobile Show, Madison Square Garden, New York. N. A. A. M., Madison Square Garden Co. and A. C. A.
- Jan. 14-24.—Fourth Annual Automobile Show at Brussels, Belgium.
- Jan. 21.—A. C. A. Banquet, Waldorf-Astoria, New York City.
- Jan. 21-28.—Birmingham Motor Show.
- Jan. 21-Feb. 6.—Turin Automobile Exhibition.
- Jan. 23-28.—Ormond-Daytona Automobile Tournament. Florida East Coast Automobile Association.
- Jan. 23-28.—Philadelphia Annual Automobile Show. A. C. of Philadelphia and Auto Dealers' Assn. of Phila.
- Jan. 27-Feb. 4.—Fourth Annual Automobile Show Crystal Palace, London.
- Feb. 1-4.—First Annual Power Boat Carnival and Races. Lake Worth, Fla., Palm Beach P. B. A.
- Feb. 4-11.—Fifth Annual Automobile Exhibition, Chicago. Coliseum Building. N. A. A. M. and C. A. C.
- Feb. 4-19.—Automobile Exhibition at Berlin, Germany.
- Feb. 5-19.—Automobile Week, Nice, France.
- Feb. 9.—First Annual Cuban Automobile Carnival, Havana.
- Feb. 10-18.—Automobile Exhibition at Olympia, London, England. Society of Motor Manufacturers and Traders.
- Feb. 13-18.—Fourth Annual Exhibition at Detroit. Tri-State Automobile and Sporting Goods Association.
- Feb. 21-March 9.—National Motor Boat Show, Madison Square Garden, New York. Nat. Assn. Engine and Boat Mfrs.
- Feb. 20-25.—Cleveland Automobile Show. Cleveland Automobile Club.
- Feb. 24-Mch. 4.—Edinburgh Automobile Show.
- Feb. 24.—Manchester Automobile Show.
- Feb. 27-March 4.—Automobile Exhibition, Toronto, Canada.
- March 3-11.—Motor Show, Liverpool, England.
- March 6-11.—Third Annual Buffalo Automobile Show, Convention Hall Buffalo. Buffalo Automobile Club.
- March 13-18.—Third Annual Automobile Show, Boston. Boston Automobile Dealers' Assn.
- March 13-18.—Importers' Automobile Salon, Symphony Hall, Boston.
- March 27-April 5.—Fifth Annual Washington Automobile Show. Washington Auto. Dealers' Assn.
- April 1.—Light Van Trials. A. C. of Great Britain.
- April 1-16.—Monaco Motor Boat Fortnight.
- May 11-25.—Stockholm Automobile Show.
- June 26.—Mont Denis Hill Climb.

a handsomely prepared pamphlet, illustrated with a number of quaint pictures of various styles of vehicular transportation, from the solid-wheeled bullock cart and the Assyrian war chariot to the modern automobile with limousine.

F. T. Bedford, a vice-president of the Standard Oil Co., is a recent purchaser of a 24-30-horsepower F.I.A.T. from Hollander & Tangemann, New York. A 90-horsepower racer has also been ordered through this firm for a prominent American amateur, whose name is withheld for the present.

At the recent convention of the Pennsylvania State Grange, at Erie, a resolution was presented, and favorably acted upon, asking the Legislature to enact a law regulating the speed of automobiles and giving horses the right of way on all the roads of the State.

The Auto-Cycle Club of Great Britain is planning an international event for light-weight machines on the Isle of Man course for next season, in which it is expected that representatives of most of the motoring nations will be seen at the start. Details will be given in due time.

W. H. Webster, formerly with the automobile department of John Wanamaker, is now connected with the New York branch of the Maxwell-Briscoe Motor Car Co., recently established at 317-319 West 59th street. Col. K. C. Pardee is in charge of the New York store.

P. A. Williams, Jr., of Boston, has taken the agency for the Marion car in addition to the Ford, which he already had. He will be New England representative for both, and after January 1 will conduct the business under his own name instead of the Ford Automobile Co.

C. A. Coey & Co., Chicago, agents for the Thomas cars, now located at 5311 Cottage Grove avenue, announce that after January 10 they will be located at 1323 and 1325 Michigan avenue. They have had a very successful season and anticipate an even greater business the coming year.

The Houston Motor Car Co. has established a garage and fully equipped repair station at 1013-15 Main street, Houston, Texas. The company has secured the state agency for the Union automobile, and will in addition handle other makes of cars, including a line of electrics.

William Taylor, who recently barely missed running down Mayor Jeffery, of Columbus, O., was fined \$50 and costs in police court for fast driving. The fine, however, was remitted.

The city council of Los Angeles, Cal., at a recent meeting, adopted resolutions empowering the Board of Police and Fire Commissioners to purchase an electric automobile patrol and ambulance at a cost not exceeding \$2,400.

A new garage has been erected to accommodate the business of J. A. Place, 145 Castle street, Geneva, N. Y. This will have a capacity of from fifteen to twenty machines, and will have a machine shop run by a gas engine.

The mid-winter convention of the National Good Roads Association will be held at Jacksonville, Fla., January 19 to 21, two days prior to the Ormond-Daytona automobile tournament.

W. Philip Johnson, 1231 Webster street, New Orleans, La., has secured the agency for that territory for the Thomas cars, made by the E. R. Thomas Motor Co., at Buffalo, N. Y.

Harrington's Automobile Station No. 1, of Worcester, Mass., will retain the agency for the Stevens-Duryea and has taken on the Columbia line. It will probably secure one or two more lines in the near future.

The rumor that a stock company had been formed and had purchased the automobile business of J. J. Mandery, of Rochester, N. Y., is denounced as entirely groundless.

The Central Automobile Exchange, of Worcester, Mass., will retain the Pierce agency and has taken on the Winton, and will doubtless retain the White agency.

The Pan-American Polish Co., formerly of East Cleveland, O., has removed to St. Louis, and is now located at the corner of Olive and Walton streets.

Rev. E. H. Pence, for many years pastor of the First Presbyterian Church at Janesville, Wis., has been presented by his Detroit parishioners with an automobile.

The Thomas Flyer will be represented in Vermont for 1905 by Manley Bros., of Brattleboro, and in Manchester, N. H., by F. H. Emerson.

The Detroit Electric Co., 56 Shelby street, Detroit, has changed its name to the Robert Instrument Co., under which name the business will be conducted as formerly.

The Motor Car Co., of Newark, N. J., has secured the agency for the Winton and Packard cars for 1905, and in addition will also handle the Autocar and Cadillac machines.

Albert Griebel, formerly of Griebel Bros., has opened an automobile repair station at Woodstock, Ill.

SCHOOL OF OPERATION.

Special Correspondence.

PHILADELPHIA, Dec. 26.—With the opening of the new year there is to be inaugurated here a school of instruction in the operation and care of automobiles. The term will consume thirteen weeks, with three lectures and three lessons each week. Day and evening sessions with ladies' classes on Tuesdays and Fridays will be held on a fine indoor driving course, the able corps of instructors being professional chauffeurs, including some foreign experts.

F. W. Reese, secretary of the new school, who has established his headquarters at 244 North Broad street, says that the basis for the foundation of the new scheme is the absolute scarcity of really competent automobile operators and the conviction that within a year or two the demand for experienced men capable of handling an automobile with judgment will increase one hundredfold. Not only that, the number of owners who "know" their cars is comparatively small, and from among this class the founders of the new school expect to secure many pupils. Gasoline, steam and electric vehicles will be thoroughly demonstrated and practice cars will be on hand at all times for the pupils. A special feature will be made of the handling of marine engines, a branch of motoring which is destined to expand greatly during the next year or two. Sessions will be opened early in January.

RECENT INCORPORATIONS.

Hoyt Motor Co., Brooklyn, N. Y.; capital, \$100,000. Directors: G. P. B. Hoyt, Jamaica; F. E. Kruker, Douglaston, and G. A. Phail, Flushing, all of Long Island.

East Coast Automobile Co., Jacksonville, Fla.; capital, \$10,000; to conduct a wholesale and retail automobile, motor boat and marine engine business. Incorporators: P. L. Sutherland, Guy R. Champlain, E. A. Groover, A. D. Covington and A. S. Hubbard.

Ohio Good Roads Association, Cleveland; to promote improvement of public highways. Incorporators: William Faareburgh, C. B. Wilcox, Malcolm Kelly, S. H. Seimbach and Fred. S. Chamberlain.

Wilson Auto-Transit Co., Wilson, N. C.; capital, \$100,000; to establish automobile lines for the transportation of freight and passengers, to buy, sell and manufacture wagons, buggies and motor vehicles. Incorporators: W. B. Young, Hattie B. Young, J. C. Hales, B. W. Kincaid, C. F. Botts, R. E. Massey and S. H. Finch.

INFORMATION FOR BUYERS

FEDERAL HOUSE ORGAN.—Following the practice of many large manufacturing establishments, the Federal Mfg. Co., of Elyria, O., has begun the publication of a periodical devoted to the interests of its business, the first number having been issued in December. This little magazine, called *The Automobile Builder*, is unusually free from one-sidedness—in fact, it requires considerable effort to discover that it is not a well gotten up monthly devoted to the technical side of the automobile industry in general. The articles treat of the mistake of applying standard engineering formulæ to automobile construction: "The Evolution of Minor Transportation," "Designing Pressed Steel Frames," "Care of Electric Vehicles," discussions on wheel material, English trade conditions, steel castings for automobiles, shop equipment, and a number of other subjects, all of great interest to the practical automobile man, and written and printed in an excellent style. *The Automobile Builder* has made a good start. The paper is published at 610 American Trust Building, Cleveland, O. It is edited by Walter Wardrop.

PACKARD IGNITION CABLES.—The method used by the Packard Electric Co., of Warren, O., in the manufacture of insulated cables for wiring the ignition systems of automobiles is described in a little catalogue issued by that concern, and those who read it will, if unfamiliar with the habits of the high tension ignition current, be surprised at the amount of care and labor devoted to preventing electrical leaks. The compound used for coating the many successive coverings used in the Packard cables is of special composition, and is baked on in a steam-heated oven. It is flexible and grease-proof. The manufacturers state that the Packard car which made a trans-continental run in the summer of 1903 was fitted with this cable, and after cleaning off a piece that had been constantly covered with oil and grease, it was found to be quite uninjured, the oil having had no effect even on the surface coating of enamel. It might be mentioned that the two Packard concerns are separate companies, having nothing in common except the name Packard.

GRAPHITE LUBRICATION.—The Joseph Dixon Crucible Co.'s house organ, *Graphite*, contains in its initial number for 1905 considerable information on the subject of lubrication generally, and on graphite lubrication in particular. The advantages of graphite lubrication are dealt with and so are the difficulties of using the material, which are not underestimated or smoothed over in the least. A number of hints are given that should be useful to anyone in charge of machinery, whether they use graphite or not.

INDEX TO ADVERTISERS

Acetylene Gas Illuminating Co.....	24
Acme Motor Car and Repair Co.....	30
Acme Motor Car Co.....	50
Akron Mfg. Co.....	28
Allyne Brass Foundry Co.....	29
American Automobile and Power Co.....	23
American Coil Co.....	23
American Machine Mfg. Co.....	30
American Veneer Co.....	34
Angler Co., The.....	26
Association of Licensed Automobile Mfrs.....	62
Atwood Mfg. Co.....	26

Auto Car Equipment Co.....	31
Automobile Supply Mfg. Co.....	24
Auto Top Co.....	27
A-Z Co., The.....	35
Badger Brass Mfg. Co.....	44
Bartholomew Co., The.....	50
Bay State Stamping Co.....	24
Becker, John.....	24
Biddle & Smart Co.....	27
Big Four Railroad.....	48
Bilas-Chester Co.....	25
Blomstrom Motor Co., C. H.....	60
Borbein & Co., H. F.....	29
Boston Gear Works.....	26
Bradford Motor Works.....	33
Breslin Hotel.....	57
Briscoe Mfg. Co.....	25
Brooke, M. E.....	25
Brown Machine Co., The James.....	70
Burgin Bros.....	25
Byrne-Kingston Co.....	34
Cadillac Automobile Co.....	52
Carbondale Chemical Co.....	23
Central Automobile Co.....	67
Chicago Battery Co.....	30
Cium & Atkinson.....	31
Columbia Automobiles.....	23
Continental Caoutchouc Co.....	38
Covert Manufacturing Co.....	25
Crosby-Frisian Fur Co.....	25
Cullman Wheel Co.....	29
Daimler Mfg. Co.....	50
D'Arcy Spring Co.....	27
Dayton Electrical Mfg. Co.....	33
Diamond Rubber Co.....	40
Diets, R. E.....	45
Dixon Crucible Co., Jos.....	50
Dolson & Sons, John L.....	53
Dow Portable Electric Co.....	25
Draper Bros. Co.....	24
Dyke, A. L.....	26
Dyke Automobile Supply Co., A. L.....	28
Electric Storage Battery Co.....	30
Electrogrip Co.....	24
Elmore Mfg. Co.....	52
Excelsior Supply Co.....	24
Federal Manufacturing Co.....	29
Fifth Annual Automobile Show.....	48
Fisk Rubber Co.....	38
Ford Motor Co.....	62
Forg, Peter.....	25
Franklin Mfg. Co., H. H.....	71
Fuller & Walsh.....	23
Funke, A. H.....	28
G & J Tire Co.....	41-39
Gilbert Manufacturing Co.....	24
Goodrich Co., The B. F.....	42
Grout Bros. Automobile Co.....	65
Ham Mfg. Co., C. T.....	46-47
Hansen Mfg. Co., O. C.....	36
Hardy Co., The E. R.....	30
Harris Oil Co., A. W.....	32
Hartford Pattern and Model Co.....	29
Hartford Rubber Works.....	Cover
Hartford Suspension Co.....	25
Heald Machine Co.....	37
Herz & Co.....	30
Hl-Speed Bronze Co.....	29
Hjorth Wrench Co.....	24
Holly, Geo. M.....	33
Holtzer-Cabot Electric Co.....	31
Hopson & Chapin Mfg. Co., The.....	29
Hotel Breslin.....	57
Hotel Lafayette.....	49
Howarth & Rogers Co.....	27
Hussey Drop Forge and Mfg. Co.....	33
Importers' Automobile Salon.....	49
Induction Coil Co.....	30
Jackson Cushion Spring Co.....	27
Jamesville Wheel Mfg. Co.....	32
Jeffrey & Co., Thomas B.....	Cover
Kells Mfg. Co., W. J.....	29
Kent Mfg. Works, Atwater.....	24
Knoblock-Heldeman Mfg. Co.....	30
Knox Automobile Co.....	51
Lafayette Hotel.....	49
Lear Auto Co., Oscar.....	27
Light Manufacturing and Foundry Co.....	29
Lipman, Carl E. L.....	25
Lobee Pump Co.....	25
Locke & Co.....	35
Locke Regulator Co.....	26
Locomobile Co. of America, The.....	63
Logan Construction Co.....	23
Long Mfg. Co.....	33
Lowell Model Co.....	31
Lozier Motor Co.....	59
Madison Square Show.....	48
Manhattan Lamp Works.....	44
Manhattan Storage Co.....	28
Manufacturers' Foundry Co.....	29
Matheson Motor Car Co.....	Cover
Maxwell Briscoe Motor Co.....	56

McCord & Co.....	24
Meisel Press Mfg. Co.....	24
Meyrowitz, E. B.....	26
Michigan Automobile Co.....	57
Miller, Charles E.....	36
Milwaukee Auto Engine and Supply Co.....	31
Model Gas Engine Works.....	26
Moore & Son Co., M. E.....	39
Morgan & Harding.....	27
Morgan & Wright.....	46
Motor Car Supply Co.....	25
Moss Photo-Engraving Co.....	44
Mugford, A. J.....	27
Myers, A. J.....	31
National India Rubber Co.....	32
National Motor Vehicle Co.....	54
Neustadt Co., J. H.....	35
Never-Miss Spark Plug Co.....	25
New York and New Jersey Lubricant Co.....	25
Nordyke & Marmon Co.....	64
Novelty Mfg. Co.....	36
Nuttall Co., R. D.....	29
Olds Motor Works.....	69
Oriental Hotel.....	49
Packard Electric Co.....	32
Packard Motor Car Co.....	65
Pardee-Ullman Co.....	28
Parker Lock Switch.....	28
Pedersen, J. T.....	20
Pearless Motor Car Co.....	55
Pierce Co., The Geo. N.....	Cover
Pioneer Brass Works.....	51
Pittsburg Reduction Co.....	29
Pittsfield Coll Co.....	39
Post & Lester Co.....	34
Post Mfg. Co.....	27
Premier Motor Mfg. Co.....	58
Providence Steel Casting Co.....	29
Quincy Co., J. M.....	27
Randall, F. E.....	23
Reading Metal Body Co.....	27
Reid Manufacturing Co.....	54
Riverside Body Factory.....	27
Rochester Automatic Oiler and Supply Co.....	25
Rosendale-Reddaway Beiting & Hose Co.....	24
Rotary Motor Vehicle Co.....	31
Royal Equipment Co.....	24
Royal Motor Car Co.....	57
Rubber Appliance Co.....	37
Rushmore Dynamo Works.....	45
R. & C. Indicator Co.....	28
Saks & Co.....	22
Samson Leather Tire.....	39
Saris, J. H.....	30
Scandinavian Fur and Leather Co.....	36
Scoville & Peck Co.....	45
Seaboard Florida Limited Railroad.....	56
Skat Manufacturing Co.....	24
Smith Co., A. O.....	35
Spittdorf, C. F.....	30
Sprague Umbrella Co.....	27
Springfield Hat and Cap Co.....	26
Springfield Metal Body Co.....	27
Springfield Moulding Works.....	25
Standard Automobile Co.....	66
Standard Supply Co.....	25
Steam Carriage Boiler Co.....	28
St. Louis Motor Carriage Co.....	58
Streit Machine Co., A.....	31
Taylor, Geo. R.....	24
Tennant Auto Tire Co.....	38
Thomas Motor Car Co., E. R.....	Cover
Tokheim Mfg. Co.....	37
Trebert Auto and Marine Motor Co.....	31
Trebert Gas Engine Co.....	31
Tucker, C. F.....	24
Ultra Pump and Power Co.....	24
Union Automobile Co.....	51
United Electrical Mfg. Co.....	28
Upton Machine Co., The.....	29
Upton Motor Co.....	24
U. S. Bronze Co., The.....	29
Vanderbeek Tool Works.....	28
Veeder Manufacturing Co.....	34
Vehicle and Implement Spring Co.....	26
Wabash Railroad.....	49
Wagner Electric Mfg. Co.....	32
Waltham Manufacturing Co.....	61
Walworth Manufacturing Co.....	23
Warner Gear Co.....	28
Wayne Automobile Co.....	55
Weeber Mfg. Works, C. F.....	24
Weed Chain Tire Grip Co.....	28
Weston Electrical Instrument Co.....	32
Wheeler, F. H.....	32
Wheelock Motor Car Clock Co.....	24
White Sewing Machine Co.....	50
Whitlock Coil Pipe Co., The.....	28
Whitney Manufacturing Co.....	35
Wiley & Son Co., W. H.....	25
Willard Storage Battery Co.....	30
Willis, E. J., Co.....	25
Wilson & Hayes Mfg. Co.....	24
Winton Motor Carriage Co.....	72
Worthington Automobile Co.....	Cover

SPECIAL NOTICES

Advertisements inserted under this heading at 30 cents per line; about 7 words make a line. Remittances should accompany copy. Replies forwarded if postage is furnished.

AT reasonable price, Waverley Electric; 30 cells; new last spring; A1 condition. Waverley, 12 W. Read st., Baltimore, Md. 31

ASOLUTION to prevent acetylene generators freezing; will nearly double the time a lamp will run with one charging; also preventing the saturated carbide freezing. H. J. Willard, Congress Sq. Auto Station, Portland, Me. Jan 7

AMORE uniform mixture can be obtained by the use of our automatic air governor, when applied to the Oldsmobile mixer; this means more power and speed; easily attached; not necessary to remove mixer; sent upon receipt of price, \$2.50; circular upon application. More-Power Co., Box 175, Lowell, Mass. Jan 7

CHAUFFEUR, strictly temperate, reliable, experienced on high-powered cars, thorough mechanic, desires position; licensed in New York, Massachusetts; best references, factory and present employer. Address Reliable Chauffeur, care Automobile. 31

CLEMENT-BAYARD for sale, 15-h.p. car, in fine condition; light and fast; Springfield top, lamps and tools; Michelin and Samson tires. E. T., room 146, 45 Broadway, N. Y. city. 31

FOR SALE—14-h.p. Renault, 1903; very desirable car. H. A. P., 1684 Broadway, N. Y. 31

FOR SALE—11-2-h.p. Stationary Gasoline Engines; price \$55. Blaine Snapp, Auburn, Ind. 31

FOR SALE—12-h.p. Packard Engine and Transmission; engine not used over four months. J. A. Place, Geneva, N. Y. 31

FOR SALE—Type VIII Autocar Tonneau; good condition; price \$1,000. Address Garretson Cycle Co., Somerville, N. J. Jan 7

FOR SALE—Thomas Flyer; excellent condition; Fisk tires; practically new; color red; side lamps and horn; price \$1,500; no trade considered. Address R. Lipps, S. E. Cor. Balto. and Pulaski sts., Baltimore, Md. 7

FOR SALE—Wire Wheels for old-style Oldsmobiles; \$5 per set net; Mud Guards and irons complete for same machine, \$6 per set net; equip your Olds car with new wheels and mud guards. Olds Motor Works, Detroit, Mich. 31

FOR SALE—71-2-h.p. Panhard Touring Car, complete, with canopy top and all accessories; absolutely fine condition; price \$1,500; 8-h.p. Jones-Corbin Runabout, good as new, price \$600. Apply Oscar Anderson, 438 Oak st., Chicago, Ill. 31

FOR RENT—A large two-story building (40x76), in choicest business location of South Orange, N. J.; a first-class and progressive town; easily adapted for use as Automobile Garage or first-class livery stable. J. Charles O'Brien, 141 Broadway, New York. 31

FOR SALE—One 1904 Franklin Runabout, \$1,000, and one 1904 Franklin Light Tonneau, \$1,200; the above cars have been used but little, and are absolutely as good as new. Address The E. H. Towle Co., Auto Station, Harrison av., Waterbury, Conn. feb 18

FOR SALE—1904 WHITE STEAMER, brand new, never used; 1903 WHITE STEAMER, tires and paint good condition, machinery guaranteed mechanically perfect; 1904 QUEEN, seats five, clincher tires, everything guaranteed in A1 condition; want to buy White Steamers. C. C. Stolz, Marlon, Ohio. Jan 7

FOR SALE.—A solution that will not freeze at 30 below nor attack rubber hose connections or metal; leaves absolutely no deposit, and is a better conductor of heat than water; suitable for cellular coolers. Thoroughly tested last winter. H. J. Willard, Congress Sq. Auto Station, 18 Forest Ave., Portland, Me. Jan. 7.

FOR SALE—16-h.p. four-ton Panhard Le-vassor Delivery Truck, in perfect running condition; a splendid machine at a bargain. Fairmount Engineering Works, 2652 Callowhill st., Philadelphia, Pa. 31

FOR SALE—1904 Pierce Arrow Cars; 1 two-cylinder, with top, baskets and new tires, as good as new; 1 four-cylinder, with baskets and new rear tires, in guaranteed condition; these cars are excellent propositions for used cars, and will stand any test. H. Paulman & Company, No. 285 N. State st., Chicago. 31

FOR SALE—3 new 1905 Mitchel two-cylinder Air-Cooled Cars, \$500; 1 1904 Pope-Tribune, run only two weeks, \$400; 1 1904 Pope-Toledo, four-cylinder, with top, \$2,700; 1 1904 Peerless, four-cylinder, complete, \$2,700; 2 1904 Olds runabouts, nearly new, \$500; 2 1904 Pope-Toledos, two-cylinder, fine condition, \$1,550; 1 1904 Franklin Tonneau, nearly new, \$1,150; 1 1902 Winton, with 1904 improvements, \$700; we have a large stock of other machines on hand; write us for prices. Amos Pierce Automobile Co., 109-111 So. State st., Syracuse, N. Y. Jan 7

MANHATTAN Storage Co., the largest dealers of second-hand, shop-worn and demonstrating automobiles in America; automobiles from \$75 to \$3,000; worth from \$750 to \$8,500. Write, call or telephone. 334-336-338-340 West 44th st., New York city. 'Phone No. 4,290-38th. 31

OUR BARGAIN List.—1 1904 Michigan, with top, \$350; 1 1904 Olds 6-h.p., \$375; 1 Kensington Electric, less battery, \$125. Jacob Roth Auto Co., Erie, Pa. Jan 7

SALES MAN.—A machine salesman, age 30, with seven years' experience, three years with automobiles, desires position. Address E. N. B., care The Automobile. 3-31

WANTED—Oldsmobile Runabout, 1904 pattern, in good condition. L. R. Lee, Hotel Richmond, Washington, D. C. 31

WANTED—1904 large Foreign Car; will pay \$25 for address of owner (provided a purchase results). B. M. Baker, P. O. box 2898, Boston. 31

WANTED—A Mark XXXVIII Columbia Electric Runabout, without top; must be a bargain price; or will exchange a fine gasoline car in trade. Address H. R. T. W., care Automobile. Jan 7

WANTED.—The address of any Autocar owner that would like to have the power of the motor increased 10 to 30 per cent. Write H. J. Willard, Congress Square Automobile Station, Portland, Me. Jan. 7

WANTED—Young man as salesman, competent to manage auto business; will be given half profits of business for services; must be a hustler and unquestionable character; business consists of Premier, Reo and Ford. Address Eastern, care Automobile. 31

WANTED—A high-class salesman of experience, ability and force to demonstrate and sell the Pope-Toledo and other gasoline cars in connection with one of the largest garages in the country; a fine opportunity for a well-educated, able and energetic man, and no other need apply. Reply, with references and full particulars, to Experience, care Automobile. Jan 7

WANTED—A first-class, reliable and experienced man to act as foreman in machine shop building automobile motors and complete cars; new machinery; good chance for a competent man who wants to better his position; give reference and experience, salary wanted, &c.; can go to work immediately. Address Box 135, York, Pa. Jan 7

WANTED—A demonstrator and salesman for the White Steamer in a large eastern city; must be an educated man, of good address and pleasing personality, and thoroughly familiar with the construction and demonstration of the White car; to the right man the position would be remunerative and permanent; complete and responsible references required. Reply, with full particulars, to Permanent, care Automobile. Jan 7

\$300—Winton Surrey, in first-class condition in every respect. Central Motor Car Co., Germantown, Phila. 31

1904 Tonneau Auto Car, canopy top and headlights; run less than 500 miles; A1 condition; \$1,100. Arthur McNall, 76 South av., Rochester, N. Y. 31

AUTO APPAREL

FOR MEN AND WOMEN

First Prize St. Louis Exposition

No. 1000. MASK CAP FOR MEN



Position 1

So favorably were we impressed with this model which our designers conceived, that we petitioned for a patent which has been granted. The

illustrations clearly convey to the eye the four functions which this cap faithfully answers. Figure one presents

a dignified tourist cap which has attached in the back fold a pair of wide vision goggles cleverly concealed.



Position 2

Figure two shows the hood in service.

The visor is flexible and easily turned up into the crown of the cap when the mask and goggles are in



Position 3

service as Figure three depicts.

From the wind, the snow, the dust and rain does the cap warrant immunity.

- a. Of Cheviot Cloth, in mixtures; Burberry Cloth, in grey or tan; Cravenette Cloth in mixtures; Covert Cloth in tan or brown; Linen in tan or any other fabric of which our garments are made, \$4.75
- b. Of Danish Leather, in tan or black, 6.00

Please send for our 373-page catalogue.

Saks & Company

Broadway, 33d to 34th St., New York

BOSTON AUTOMOBILE AGENCIES

STEVENS-DURYEA CLEMENT-BAYARD INDIAN MOTORCYCLE

Send for new illustrated Catalogues!
See the new models.

F. E. RANDALL, Salesroom: 245 Columbus Av.

NEW YORK AUTOMOBILE AGENCIES

SEE THE NEW GARAGE

YONKERS

Having three floors in a new building built for the purpose, and equipped with every modern device. We have some unoccupied space which we can fill with either live or dead storage at interesting prices.

Address, FULLER & WALSH, 71 South Broadway, YONKERS, N. Y.
Fine Touring Cars for Rent by day, week or month.

CHICAGO AUTOMOBILE AGENCIES

Pardee-Ullmann Co.

DEALERS IN HIGH GRADE MOTOR CARS
Chicago Distributors for

WHITE & PACKARD

1400 Michigan Ave., CHICAGO
Phone, SOUTH 557

SUBSCRIBE FOR THE AUTOMOBILE



AUTOMOBILES ELECTRIC and GASOLINE

NEW SALESROOM AND GARAGE
NOW OPEN AT
74-76-78 STANHOPE ST

American POPULAIRE CAR

Without Tonneau With Tonneau
\$850. \$950.

AMERICAN AUTOMOBILE AND POWER CO.

GENERAL OFFICE AND WORKS
SANFORD, ME.

CONSTRUCTION OF A GASOLINE MOTOR VEHICLE.

By C. C. BRAMWELL. Contains: 150 pages, 6xp; one hundred illustrations and diagrams. Publisher's price, \$2.00; our price, 50 cents. Address Book Department, The Automobile Flatiron Building, New York.

Protect Your Automobile by Using the

PARKER LOCK-SWITCH

(The Only true Lock-switch on the market)
For particulars address

THE PARKER LOCK-SWITCH
83 Henry Ave., Newburgh, N. Y.

NON - FREEZING Water Jacket Solution

(Solvay Process Co.'s)

Will stand 20° Below Zero Fahr. Without Freezing.
For Sale by all Automobile Supply Houses.

THE CARBONDALE CHEMICAL CO.,

New York
Boston

CARBONDALE, PA
Baltimore

Chicago
Pittsburg

BOOKS For Automobilists and Motorcyclists

Gas Engine Hand-Book, E. W. Roberts, M.D. \$1.50
Gas, Gasoline and Oil Vapor Engines, Gardner D. Hiscox \$2.50

Gas Engine Construction, Henry V. A. Parcell, and A. J. Weed . . . \$2.50
Horseless Vehicle, Automobile and Motorcycles, G. D. Hiscox \$3.00
The Practical Gas Engineer, E. W. Longnecker \$1.00

THE AUTOMOBILE

Flatiron Building
Madison Square

NEW YORK

THAT CAR OF QUALITY

The 1905 Logan

20 H.P., 1620 lbs.

Our powerful engine levels all hills and our equalized spring trussed frame makes all roads smooth.

Our transmission, (sliding gear) absolutely correct—runs in oil—no gears in action when driving on high speed—impossible to strip gears when shifting.

Our oiling entirely automatic—no grease cups.

No noise—no vibration—no break-downs—no adjustments—no trouble of any kind. In fact, nothing but comfort, elegance, pleasure and satisfaction.

See us at the New York Show, Jan. 14th to 21st, Section B, Exhibition Hall.

The Logan Construction Company.

CHILLICOTHE, OHIO.

When your Auto isn't just right, use the

STILLSON AUTOMOBILE WRENCH

IT WILL OUTLAST ANY OTHER TOOL IN YOUR TOOL-BOX AND GIVE SATISFACTION AT ALL TIMES



The original, most efficient and durable. Used exclusively in all up-to-date garages, machine shops and all places where the best mechanics are employed. Sold by all leading auto-supply jobbers and dealers.

Write for circular and prices.

WALWORTH MFG. CO.

BOSTON, MASS.
U. S. A.

OUTFITS AND SUPPLIES

"DRAPER"
ROBE for AUTOS
 Wind, Cold and Water Proof
 Sent on Approval
 Write for Prices
DRAPER BROS. CO.
 CANTON, MASS.

HJORTH Auto WRENCH



Combination Pipe and Nut Wrench. Sizes, 6, 7 and 9 in.
 #1. Choice of above sizes sent prepaid. #1.
HJORTH WRENCH CO., Jamestown, N. Y.

RUSH FOR Buyers Everywhere
 From **GEO. R. TAYLOR CO.**
 AUTO BASKETS AND HAMPERS
 Springfield, Mass.

THOUGHTFUL
 men anticipate your wants. Equip your car with the Raymond Brake now and it will be ready for you in the spring.
ROYAL EQUIPMENT CO.
 65 Golden Hill St., Bridgeport, Conn.

AUTOMOBILE FLEXIBLE TUBING
 We have manufactured two-thirds of all the tubing sold in the U. S. Send for free sample and prices which are 50 per cent. less than other houses. Flexible tubing for speedometers, phonographs, etc. Flexible stems for portable lamps.
AUTOMOBILE SUPPLY MANUFACTURING CO.
 320 Driggs Avenue, Brooklyn, N. Y.

CANDY CARBIDE
 For FRENCH AUTO LAMPS (Impression dans le vide)
 Packed only in 10 lb. cans. Price, \$2 each. Discount to Dealers in case lot of 12 cans.
 SOLE MANUFACTURERS—
ACETYLENE GAS ILLUMINATING CO., 105 Walker Street, New York.
 In stock, all kinds of imported Lava Burners (BRULEURS) for Acetylene Auto Lamps.

WEEBER MUFFLER
 are being used on the most costly cars and motor boats. Why not fall in line and adopt them! (High in quality, low in price.)
O. F. WEEBER MFG. WORKS, Albany, N. Y.

STANDARD SUPPLIES

Genuine Continental Tires, Funke Autolyte Lamps and Horns, Solar Lamps, Splidorf Coils. All leading Spark Plugs. Everything for Automobile owners and dealers.
 NEW CATALOGUE SENT ON REQUEST.
EXCELSIOR SUPPLY CO.
 233-5-7 Randolph St. Chicago.

Wheclock Motor Clock
 Popular Price
SEND FOR CIRCULAR
WHELOCK MOTOR CAR CLOCK CO.
 Tremont Building
 BOSTON U. S. A.

Kent Pocket Battery Meters
 The Automatic Volt-Ammeter is designed and calibrated especially for testing batteries in connection with gasoline automobiles and lamps. The needle is delicately pivoted, and the readings are accurate. No change is made in the connection to the battery for the two readings, as that in comparison is obtained by simply reversing the leads. The most convenient and complete battery tester on the market. Price of Automatic Volt-Ammeter, \$6.00; price of Ampere meter, \$6.00. Special orders made to order.
ATWATER KENT MFG. WORKS, 116 N. 6th St., Philadelphia

ULTRA AUTO PUMP
 Ultra Pump and Power Co.
 Auburn, N. Y.
 Send for Catalog and Prices.

FOR BRAKE BANDS
 The Rosendale-Rodaway Belting and Hose Co.
NEWARK, N. J.

BONNETS, MUD GUARDS, RADIATORS, TANKS, ETC.
WILSON & HAYES MFG. CO., 70 Bellevue Ave., DETROIT, MICH

McCANNA Force Feed Lubricators
 Write for Booklet containing valuable information on proper oiling
MCCORD & COMPANY, 24 Broad Street New York
 Old Colony Building, Chicago

SKAT
 WILL CLEAN YOUR DIRTY HANDS
SKAT MANUFACTURING CO. HARTFORD, CONN.

Bennett Handy Oilers
 easily reached in unhandy places. No spilling. up. Oil tight and dust proof.
Bay State Stamping Co.
 WORCESTER, MASS.
 European Agents: Chas. Churchill & Co., London, England.
 Pat. July 31, 1903

A Little Money EXPENDED FOR TUCKER OIL CUPS
 WILL SAVE LARGE REPAIR BILLS
C. F. TUCKER, HARTFORD, CONN.

GEARS
 ONE QUALITY—THE BEST
 Write for Circular and Prices. Prompt Deliveries.
WEISEL PRESS & MFG. CO., 925 Deaneville Ave., Boston, Mass.

BECKER IMPROVED VAPORIZER
 For White Steamers
 Vaporizes the gasoline quickly over low pilot flame. Increases gasoline mileage. Carburetors less, and is easily cleaned by removing two plugs. Price \$4.
JOHN BECKER, Hyde Park, Mass.

Automobile Pumps.
 Write for Circulars.
Upton Motor Company, Lebanon, Pa.

AUTO FABRIC SUPPLIES
 TIRE CASES
 Colors to Match Machines
 28-30 in. tires, \$4.00
 32-34-36 in. tires, 4.50
 Beware of Infringing Tire Cases.
 Send for Catalogue
GILBERT MFG. CO.
 New Haven, Conn.

DONT LIE
 on your back with a wrench in one hand and a light in the other trying to repair Cars. The "Electrogrip" frees one hand, holds light in any position desired and is attached anywhere.
FITS ANY SOCKET
 Mailed complete, \$1.
 Necessity in all garages.
ELECTROGRIP COMPANY, Springfield, Mass.

WHEN BUYING OIL GUNS

see that the cylinders are made of heavy gauge seamless brass tubing, otherwise they will dent and easily smash. Spouts should be seamless and set soldered or they will surely give trouble. Incidentally ask to see the 1905 Model of "N. F. O." AUTO LUBRICANT GUN, every up-to-date dealer will have them on hand.

IMPORTED IMITATION DE DION SPARK PLUGS

40c. EACH
THE MOTOR CAR SUPPLY CO.
1427 MICHIGAN AVE., CHICAGO



Imported direct. There is no finer plug made. Guaranteed not to sput or short circuit. Sent prepaid \$2.10 or 3 for \$5.00
THE ANQUIER CO., Auto Supplies,
13 Columbus A. BOSTON.



PLUG IS ALWAYS BUSY. NO DELAYS, NO STOPS
Any size \$1.50 Coils, Battery Connections, Carburetors,
Any car Co emulators, Chain Repair Device.
Anywhere JUST SAY NEVER MISS. JUST WRITE
NEVER MISS SPARK PLUG CO., Lansing, Mich.
A. L. DYKE, Agt., 311 Pine St., St. Louis.

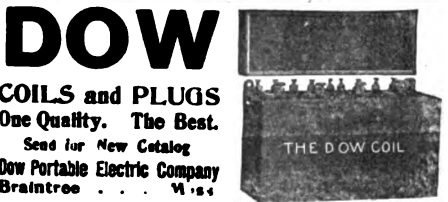

Olds Carbureters Remodeled.
More power, less fuel. Discarded Olds Carbureters bought. Send for circular.
STANDARD SUPPLY COMPANY,
NORTH ADAMS, MASS.



Brooke Patent Airless Tire
The "PERFECT MODERN MOTOR TIRE" for AUTOS, MOTOR CYCLES, VEHICLES, BICYCLES "RESILIENCY without AIR"
No puncture troubles. Two years of successful use since patent was granted. Awarded MEDAL ST. LOUIS EXPOSITION. Easy to apply; Fits any rim. Any diameter of wheel supplied. Resilient rubber core and interlocking casing. Prices, particulars, testimonials of Sole Owner and Manufacturer:
M. E. BROOKE, 1422 Grant Ave., Denver, Col., U. S. A.

RUBBER AUTO SHIRT
\$6—Guaranteed Rain Proof—\$6
One of the many good things in
"EVERYTHING FOR THE AUTOMOBILE"
OUR BIG CATALOGUE SENT FREE
Discounts to Dealers
E. J. WILLIS CO., 14 Park Place, New York City

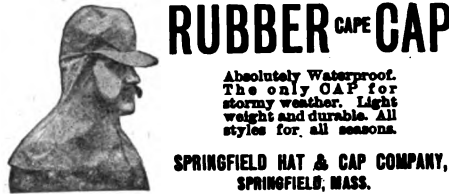

Absolutely Waterproof. The only GAP for stormy weather. Light weight and durable. All styles for all seasons.
SPRINGFIELD HAT & CAP COMPANY,
SPRINGFIELD, MASS.



BEST QUALITY. All Sizes in Black or Russet. Delivered Prepaid \$2.50.
THE ANQUIER CO., AUTO SUPPLIES
43 Columbus Avenue. - Boston.
\$5 Auto Gloves
from natural black dogskins for men and women; also fine leather gauntlet gloves, fur coats and robes. Booklet on request.
THE CROSSBY FRIGIAN FUR COMPANY
116 Mill Street, Rochester, N. Y.

SUBSCRIBE FOR THE AUTOMOBILE WEEKLY — \$2.00 PER YEAR

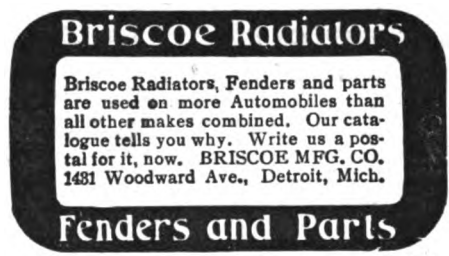

Briscoe Radiators, Fenders and parts are used on more Automobiles than all other makes combined. Our catalogue tells you why. Write us a postal for it, now. BRISCOE MFG. CO., 1481 Woodward Ave., Detroit, Mich.
Fenders and Parts
The Forg Gasoline Burner
P. FORG
Somerville
MASS.



Portable Houses for AUTOS, LAUNCHES, SHORE COTTAGES
All styles and sizes. \$75 and up. Immediate deliveries.
Mfg. by Springfield Moulding Works
Springfield, Mass.
EUREKA
TIRE-CASE
Made of special woven fabric water repellent "Khaki."
Dust-tan color, all sizes.
Burgin Bros., Springfield Mass.

HARTFORD SHOCK-ABSORBER

NOT-A-LUXURY-BUT-A-NECESSITY-ON-YOUR-CAR
3,000 Sets now in use in France, demonstrating its great efficiency.
NO danger of breaking springs, jumping of the car on rough roads.
YES it saves the tires, it is reliable, durable and easily attached.
ISN'T IT ABOUT TIME YOU HAD AN EASY RIDING CAR?
Price per complete set of four suspensions, \$60. Applied at our factory, No. 300 Hudson St., New York City, \$10 additional.

HARTFORD SUSPENSION CO.

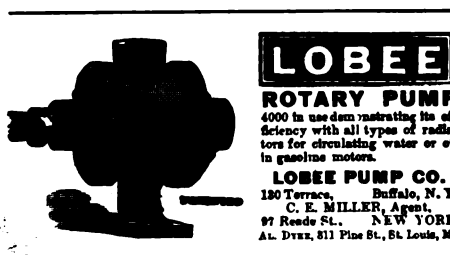

LOBEE ROTARY PUMP
4000 in use demonstrating its efficiency with all types of radiators for circulating water or oil in gasoline motors.
LOBEE PUMP CO.
180 Terrace, Buffalo, N. Y.
C. E. MILLER, Agent,
97 Reeds St., NEW YORK
AL. DYER, 311 Pine St., St. Louis, Mo.
The "LIPMAN" Rotary Pumps
For circulation of water and oil on automobiles, marine and stationary engines. Twenty-five distinct sizes and models carried in stock. Used by leading manufacturers.
C. E. L. LIPMAN
BELOIT, Wis. U. S. A.
Send for Illustrated Circular and Price List (A)
No. 6 and 7 Eccentric Pump

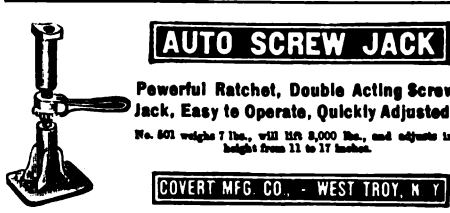

Powerful Ratchet, Double Acting Screw Jack. Easy to Operate, Quickly Adjusted.
No. 601 weighs 7 lbs., will lift 3,000 lbs., and adjusts in height from 11 to 17 inches.
COVERT MFG. CO. - WEST TROY, N. Y.

AUTO OILER

Forces the oil in unhandy places. Gives a drop or stream as desired. Fills automatically through spout like a syringe.
ONE DOLLAR, PREPAID.
CATALOGUE FREE.
Rochester Automatic Oiler and Supply Co.,
50 Andrews St., Rochester, N. Y.

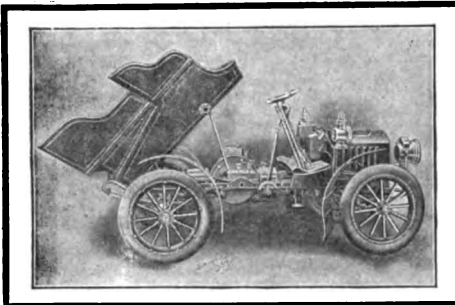

THE MODEL

BUILT IN THREE SIZES
 Five-passenger Touring Car; weight, 1,600 lbs.; 8-cylinder 16 H.P. motor
 Five-passenger Touring Car; weight 1,400 lbs.; 8-cylinder 16 H.P. motor.
 Four-passenger Touring Car and Runabout; weight, 1,200 lbs.; 8-cylinder 12 H.P. Motor.
 If interested in a high power car, in which the designer has not least slight of accessibility, write for catalog of 1905 type
MODEL GAS ENGINE WORKS
 Look Box 2010, - Auburn, Indiana

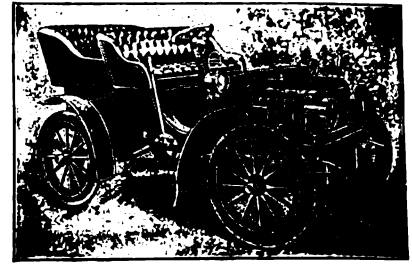

MILE-AHEAD SEARCHLIGHT
Atwood Mfg. Co.
 AMESBURY, MASS.
STAYLIT OIL LAMPS

Construction of a Gasoline Motor Vehicle. By C. C. Bramwell. Contains 150 pages, 125; one hundred illustrations and diagrams. Publisher's price, \$2.00; our price, 50 cents. The Automobile, Flatiron Building, New York.

 Oil Tempered—Hand Fitted—Best Finish.
 Graded to Secure Best Results.
 Send us blue prints, drawings, or write us fully what is required.
WE CAN SATISFY YOU.
 VEHICLE AND IMPLEMENT SPRING CO., Pontiac, Mich.

SPROCKETS, CHAINS,
 Universal Joints
 Differentials
 Steering Devices
GEAR AND CAM CUTTING
 BOSTON GEAR WORKS, BOSTON, MASS.
 Send for catalog

DR. DYKE'S
"ANATOMY OF THE AUTOMOBILE"
\$2.50
 700 Pages—treats on Automobiles, Air Ships.
 Buy your Auto Supplies from the old reliable Dr. Dyke.
 Second-hand Autos Cheap.
 Not with A. L. Dyke Auto Supply Company.
A. L. DYKE, 311 Pine, ST. LOUIS
 — Send for Circulars —

"NOSTARE" The Best Goggle Out.

 We make and import all styles at all prices.
 Write for price list.
E. B. Meyrowitz
 104 East 23d Street, New York
 MINNEAPOLIS ST. PAUL P.A.S.

CHANGE SPEED GEAR
 (Interior view)
 3 Speeds Ahead, Direct Drive or Top Speed and Reverse
 Prompt deliveries. Send for prices and gasoline parts catalog.
Looke Regulator Co
 Salem, Mass.

The Gas Engine

A TREATISE ON THE
INTERNAL COMBUSTION ENGINE
 Using Gas, Gasoline, Kerosene, or Other Hydrocarbon as Source of Energy

BY
FREDERICK REMSEN HUTTON
 E. M., Ph. D.
 Professor of Mechanical Engineering in Columbia University

EXCEEDING FIVE HUNDRED PAGES
Price, \$5.00

THE AUTOMOBILE,
 FLATIRON BUILDING NEW YORK

BOOKS

FOR AUTOMOBILISTS and MOTORCYCLISTS



THE AUTOMOBILE
 FLATIRON BUILDING
 MADISON SQ. " NEW YORK

- Gas Engine Hand-Book, E. W. Roberts, M. E., \$1.50
- Gas, Gasoline and Oil Vapor Engines, Gardner D. Hiscox, \$2.50
- Gas Engine Construction, Henry V. A. Parcell and A. J. Weed, \$2.50
- Horseless Vehicle, Automobile and Motorcycles, G. D. Hiscox, \$3.00

OWNERS OF AUTOMOBILES SHOULD HAVE

Self-Propelled Vehicles

IN THEIR LIBRARIES

IT'S a new book by J. E. Homans, A.M., tells the whole story. It explains in simple, non-technical language the mechanism and management of every type of automobile. 640 pages; 500 illustrations; complete diagrams; ready reference index. \$2.00.

ADDRESS
BOOK DEPT., CLASS JOURNAL CO.
 Flatiron Bldg., Madison Sq., New York.

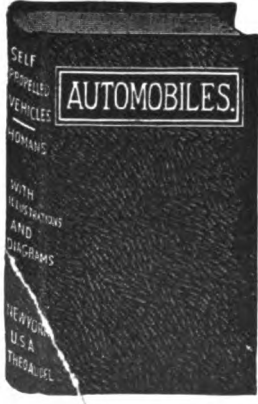

QUINBY
AUTOMOBILE-BODY
 DEPARTMENT.
 1534 BROADWAY, Cor. 45th St.
 EMERSON BROOKS, MANAGER.
 PHONE, 883-838TH ST.

SPRINGFIELD TOP



Patents Pending
 Aluminum Bodies
 Aluminum Fenders
 SPRINGFIELD METAL
 BODY CO.,
 11 Cypress St.,
 Springfield, Mass.

COL. SPRAGUE'S
AUTO CANOPIES
 CAPE TOPS, Etc.

Send for Catalogue
 SPRAGUE UMBRELLA CO., - - NORWALK, OHIO.

OLD Tires Made NEW

NEW Tires Made Puncture Proof

THE NEWMASTIC FILLING

Just as Resilient as a Pneumatic
 Just as Safe as a Solid Tire
 How Do We Do It?
 Write Us and Learn

MORGAN & HARDING
 GENERAL AGENTS
 3970 Olive St. St. Louis, Mo.

A TEST

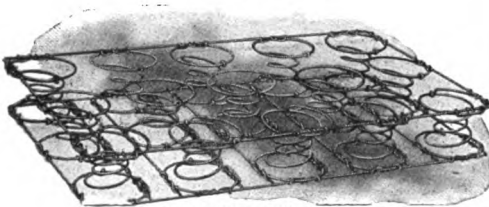

PATENTS ALLOWED AND OTHERS PENDING

For Cushions Without Wood Frames
 ANY SHAPE DESIRED

The customer rides in a car not equipped with the Jackson Cushion Spring, the seat is hard and uncomfortable.

He rides in a car equipped with the Jackson Cushion Spring, the seat is elastic, comfortable, luxurious. He purchases the car equipped with the spring made by the

JACKSON CUSHION SPRING COMPANY
 JACKSON, MICH.

SIDE ENTRANCE BODIES
 In the white or finished complete
HOWARTH & ROGERS CO., - Amesbury, Mass.



1905 STYLES SIDE ENTRANCE AUTO BODIES
 In the White or Finished Complete
BIDDLE & SMART CO., Amesbury, Mass.



Who?
 can illustrate your automobile and supply catalogue?
A. Mugford,
 if you will take advantage of a service which they have to offer, from their different offices, located at
Hartford, Worcester, Boston, Syracuse and New York.
 where competent artists are at your service for the prompt and CORRECT execution of your drawings and designs. Call, write or telephone our nearest office.
A. MUGFORD,
 DESIGNER, ENGRAVER, ELECTROTYPYER.

THE BUCKEYE Air Cooled ENGINE
 The Coolest Air Cooled Engine on the Market.
 Fully Warranted as to Workmanship and Material.
 Write Us—We want to tell you more about it.
The Osoar Lear Automobile Co.
 Selling Agents—
 COLUMBUS OHIO

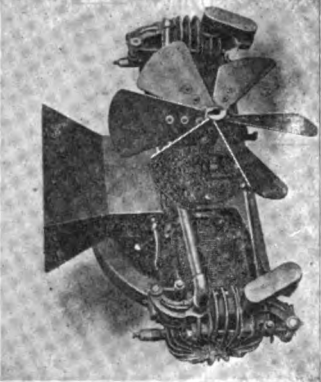

FINE HAND-FINISHED BODIES
 RIVERSIDE BODY FACTORY BUFFALO N. Y.
 Correspondence Solicited.

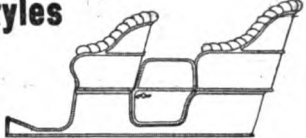

Perfection in Body Making "READING" ALL-METAL BODIES
1905 Styles
 WRITE FOR CATALOG AND ESTIMATES

Reading Metal Body Co.
 7th and Benjamin Streets
 READING, - PA.

TOPS
 Cape Tops, \$40.00 up, Extension Tops, \$100.00 up,
 Coupe Canopies, \$60.00 up,
 Canopy Tops, \$75.00 up. Limousines, \$300.00 up.
 We guarantee to fit any car.
AUTO TOP CO. OF N. Y.
 509 West 30th Street

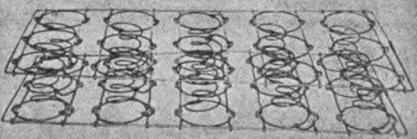
POST NON-SKID GRIP
 Absolutely the best anti-skidding device on the market, irrespective of price. Will give traction and prevent skidding in any going. A tire protector. Price \$10 the set direct from the factory.
THE POST MFG. CO.
 1908 BROADWAY, NEW YORK, N. Y.

The Best Spring Seat in America FOR AUTOMOBILES

 All Steel Wire Construction
 Never Can Work Loose
 Never Get Out of Shape
 We make them in all Shapes and Sizes
 Send us a Diagram of Your Seat, if interested, and we will Make You a Sample. To see it is to buy it.
 We Use the Best Wire made by the American Steel and Wire Co. Temper all our Springs in form, and bake all Japan to 350 degrees of heat.
 All Cross Rods and Outside Rods are of Coppered Wire, making the best possible appearance.
 We make the same construction to drive into wooden frames, and will be pleased to quote you prices on any size or shape. We will save money for you, if you want Strictly High-Class Goods.
D'ARCY SPRING CO., 115 Main Street KALAMAZOO, MICH.



UNEXCELLED IN QUALITY

CRESCENT DRY BATTERIES

All Sizes - All Types
All Shapes - All Satisfactory

RELIABLE UNDER ALL CONDITIONS

Write for Circulars and Prices

UNITED ELECTRICAL MFG. CO.
SOLE MANUFACTURERS

69 Murray Street, New York City

A. L. DYKE

Automobile Supply Co.

"FIRST IN AMERICA"

Under new management. Manufacturers, Jobbers and Agents. We make the Dyke Specialties. Orders filled promptly. Satisfaction guaranteed. Send for our Catalogue.

A. L. DYKE AUTOMOBILE SUPPLY CO.
Olive and Walton Sts., St. Louis, Mo.



This 12-inch **BRASS HORN**
\$2.95

REGULAR PRICE, \$8.00
LOUD, PENETRATING AND DEEP TONED
Get our Catalogue Free for the Asking

MANHATTAN STORAGE COMPANY
44 CORTLANDT STREET, NEW YORK

Autolyte Gas Lamps

The lamps that combine American ingenuity and foreign experience—practical as well as ornamental.

THEY LIGHT THE WAY
Prices \$7.50 to \$40. Automobile makers and dealers everywhere catalogue and recommend these lamps. Ask your dealer to show you the Autolyte Lamps and Generators, or write to us for booklet of lamps, horns and launch whistles.

A. H. FUNKE, 83 Chambers Street, New York

The Practical Gas Engineer

WHAT TO DO AND HOW TO DO IT. A book of 150 pages, neatly bound in cloth. Sent postpaid for \$1.00. Address, Book Department, The Automobile, Flatiron Building, New York.



COILS = DASH =
and other styles.

ONE grade—the BEST
IGNITION EQUIPMENTS EXCLUSIVELY

Write for Catalogue B. **AMERICAN COIL CO., P. O. Box, 592.**
W. Somerville, Mass.

No. 0 VIBRATOR COIL **AUTO SUPPLY CO., 1662 Broadway, New York Agents.**



BOILERS

Do you want satisfaction! The boiler proposition we have to offer will give it to you. Our boilers will cause you no trouble. They are the best! The price is right!

STEAM CARRIAGE BOILER CO.,
111 WATER STREET, OSWEGO, N. Y.

VANDERBEEK AUTO SCREW DRIVER Six In One (Patented)



PULL OUT

Especially made for the AUTOMOBILIST. 5 sizes, 5 in., 8 in., 9 in., 11 in. and 14 in. over all. One screw driver for any size screw.

Sent Prepaid \$1. VANDERBEEK TOOL WORKS, HARTFORD, CT.

LEAKY OIL CANS
have given you trouble.

You may turn a **Maranville Oil Can**
upside down in your tool box and it will not leak. When using it the oil flows in just the quantity—no more. In just the place—no place else.

\$1.25 Each

THE AKRON MFG. CO.
Sole Manufacturers
927 South High Street,
AKRON, OHIO, U. S. A.



Warner Differential Gears

All Sizes for Both Sprocket and Bevel Gear Drive.
—SATISFACTION or "NO PAY."—

Shipping 25 A DAY on Olds Motor Works Order Alone.

MERIT has secured for us the Differential business of Nine other of the leading Companies

WARNER GEAR CO., - - - MUNCIE, IND.

WESTON ELECTRICAL INSTRUMENT CO.

Electrical Measuring Instruments,

FOR USE IN
Electrical Carriages and in Charging Stations

Send for Catalogue

WORKS: - Waverly Park, NEWARK, N. J.
New York Office, 74 CORTLANDT ST.

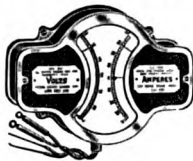

Combination Volt and Ammeter, Model R.



Switchboard Instrument Type K.



THE WHITLOCK COOLER

has been ADOPTED by the LEADING AUTOMOBILE BUILDERS for 1905, because it is the LEADER in EFFICIENCY, STYLE, FINISH and DURABILITY

THE WHITLOCK COIL PIPE CO., HARTFORD, CONN.
Patented in England, France and Belgium. Patents pending in the United States.



THE R. & C. MAGNETIC LIQUID INDICATOR.
FOR AUTOMOBILE AND LAUNCH GASOLINE TANKS.
OPERATED UNDER PRESSURE OR WITHOUT PRESSURE.
SHOWS AMOUNT OF GASOLINE IN TANK. MADE TO APPLY TO THE FILLER OPENING OF ALL MAKES OF AUTOMOBILES. CAN BE PUT IN ANY TANK. IN A FEW SECONDS WITHOUT TOOLS. WRITE FOR CIRCULAR PERFECTED. GUARANTEED.

PAT. AUG. 23 1904.

(SPECIAL INDICATORS FOR ANY KIND OF LIQUID RECEPTICAL)

R. & C. INDICATOR CO.
BRIDGEPORT, CONN. U. S. A.

ALUMINUM

THE PITTSBURGH REDUCTION CO.
PITTSBURGH, PA.

Aluminum Automobile Parts a Specialty

Send us a pattern and let us submit sample

CYLINDER CASTINGS

MANUFACTURERS' FOUNDRY CO.
WATERBURY, CONNECTICUT
MADISON SQUARE GARDEN SHOW
CONCERT HALL—SECTION C

IRON CASTINGS

For Gas Engines. Cylinders a Specialty, made only from CUSTOMERS' PATTERNS.
HOPSON & CHAPIN MFG. CO., New London, Ct.
Cylinders Bored and Machined.

Nuttall Cut or Planed Gears
Are unexcelled for heavy auto trucks
R. D. NUTTALL COMPANY,
Duquesne Way, - Pittsburg, Pa.

The Cullman Spur Equalizing GEAR

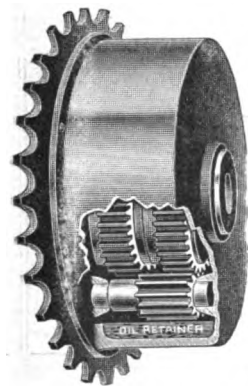

Embodies features not found in any other gear. The Oil Retaining Shoulder and the Solid Steel Hardened Pinions are of special merits. Write for new catalogue.
Cullman Wheel Co.
1027 Dunning St., Chicago, Ill.
Chicago Show Space No. 268.

HI-SPEED No. 8

THE BEST BEARING BRONZE MADE
WILL NOT CUT, POWDER OR CLING

WRITE US ABOUT IT.
HI-SPEED BRONZE CO.
16th and Wood Streets
PHILADELPHIA

ALUMINUM CASTINGS

PHOSPHOR BRONZE and BRASS
FOR AUTOMOBILE WORK
PIONEER BRASS WKS., INDIANAPOLIS, IND.

STEEL CASTINGS

HIGH GRADE
FOR AUTOMOBILE WORK.
Tensile strength 70,000 lbs. per square inch.
PROVIDENCE STEEL CASTING CO., - PROVIDENCE, R. I.

PATTERNS

FOR CYLINDERS, TRANSMISSION CASES, AND OTHER PARTS OF AUTOMOBILES
We solicit the most difficult work in this line in wood or metal. We are pattern makers for some of the largest firms in the country, and can please you. Let us quote you prices. References the best.
THE HARTFORD PATTERN & MODEL CO. Inc. Hartford, Conn. 18 Hicks St.

Our "Automobile" Brand ALUMINUM CASTINGS

are especially adapted for Automobile Use
Have great tensile strength. Are very light. Will break in well as heavier metal.
AUTOMOBILE WORK OUR SPECIALTY
PHOSPHOR BRONZE FOR GEARS AND BEARINGS
LIGHT MFG. AND FOUNDRY CO.,
POTTSTOWN, PA.

ALUMINUM

THE ALLYNE BRASS FOUNDRY CO.
CLEVELAND, OHIO

CASTINGS

RADIATORS

Hoods, Mud Guards, Tanks
ALL STYLES, ALL SIZES
Telephone 185 Jersey City Orders filled on short notice for repairs
W. J. KELLS MFG. CO., Jersey City, N. J.

AUTOMOBILE RUNNING GEARS AND BODIES

WE BUILD ALL STYLES
Bevel Gear or Chain Drive, Hoods, Steering Devices, Wheels, Bearings, etc.
H. F. BORBEIN & CO.
2108 N. 9th St., St. Louis, Mo.

TRANSMISSION GEARS

UPTON MACHINE CO.
WORKS: BEVERLY, MASS.

THE U. S. BRONZE CO.
CLEVELAND, OHIO.
MANUFACTURERS OF

ALUMINUM AND BRONZE CASTINGS

MONITOR METAL
Guaranteed Superior to any Bearing Metal Made
CORRESPONDENCE SOLICITED

Send for Circular No. 8 If you are going to build automobiles you will want this circular. It describes our Axles, Change Gears, Cone Clutches, Mufflers, Steering Gears and other standard parts. All of these parts have been designed with unusual care. They are suitable for cars of all classes.

FEDERAL MANUFACTURING COMPANY, ELYRIA, OHIO
New York Show—Section "D," Concert Hall, Chicago Show—Gallery spaces 241, 242, 243, 244.
Selling Agent: HAYDEN EAMES, American Trust Building, Cleveland.

Saris Automatic Carbureter



Positive Feed and Proper Mixture at all speeds. Perfect Throttling Control. Motor starts immediately. Gives an increase up to 25 per cent. over ordinary types in use. Descriptive circular free.

Patented Dec. 15, '03.

J. H. SARIS, Beloit, Wis. U.S.A.

COIL SWITCHES AND SPARK PLUGS

ONE GRADE ONLY THE BEST

C. F. SPLITDORF
17-27 Vandewater St. NEW YORK

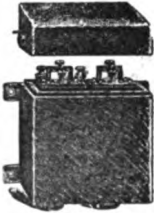

JEWEL

4 CYL. DASHBOARD COIL, showing 1 Coil partly removed.

SEND FOR PRICES

PITTSFIELD COIL CO.
PITTSFIELD, MASS.

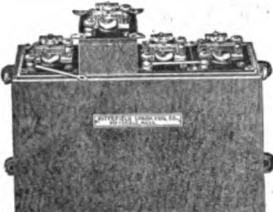

THE WELL KNOWN MICA SPARK PLUG

PERFECTION

NOW

\$1.00

For Standard Sizes

Guaranteed for 365 Days

American Machine Mfg. Co.
South Braintree, Mass.

Your Commutator

is bad and causes you no end of trouble.

THE **HERZ-TIMER** works as promptly as a good watch. No Sticking Vibrator—Tool Steel Contacts—Saving on Current 30-75 per cent. **SPECIAL TYPES FOR ANY MAKE OF MOTOR.** Franklin, Winton, Ford, Cadillac, etc.; also for Primary Igniters, Bullock, etc. Beware of worthless imitations; get the newest model.

Write for our List to-day.

HERZ & CO., Ignition Specialists 55 Grand St., New York



WILLARD Storage Batteries

MANUFACTURED BY

The Willard Storage Battery Co., Cleveland, O.

STA-RITE

"STAYS RIGHT THE LONGEST."

Our Sta-Rite Ignition Plugs DO stay right the longest and cost the least to repair.

21 sizes, regular sizes, \$1.50. Get a set right away.

THE R. E. HARDY CO.,
225 W. Broadway, NEW YORK.



"QUICK ACTION" SPARK COILS

Silk Wire. Perfect Vibrator. Never Fails. Magnetos and Dynamos.

Send for Catalogue "A."

The Knoblock-Heideman Mfg. Co.,
Successors to The Miller-Knoblock Electric Mfg. Co., SOUTH BEND, INDIANA.



JUMP SPARK COILS

For Automobile, Lanch and Stationary Engines

The kind that don't break down. Prompt deliveries. Send for Booklet.

The Induction Coil Co.
Milwaukee, Wis.
Agents The Automobile Supply Co., Chicago.

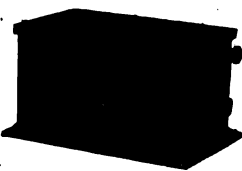

IGNITION DURO BATTERY

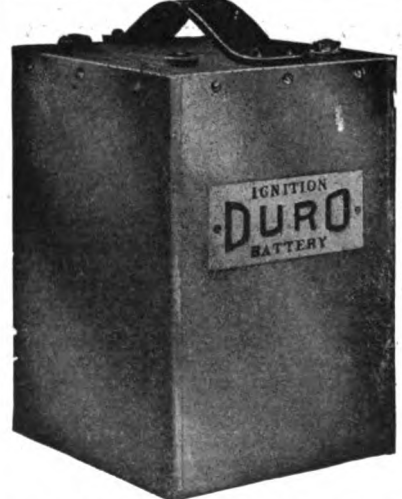

Users of DURO Storage Batteries for Ignition purposes get a mileage certainty obtainable in no other way. A Knox car equipped with a DURO has been run over 1,500 miles without recharging.

ASK FOR PAMPHLET

CHICAGO BATTERY CO.,
1421 MICHIGAN AVENUE, CHICAGO, ILL.

MOORE'S PATENTED AUTOMATIC VALVE GENERATOR

Will maintain a steady white light to the full capacity of the burner. Jarring or jolting does not affect it. Send for circular

M. E. MOORE & SON
Westfield, Mass.

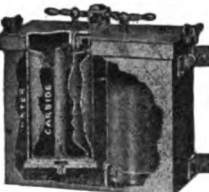

THE PEDERSEN IMPROVED OILERS

are the most reliable. An easy flow of oil always assured.

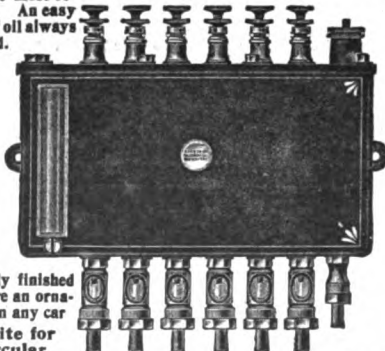

Finely finished they are an ornament on any car

Write for Circular

J. T. PEDERSEN, 642-644 First Ave., New York

The Acme Improved 1905 Muffler

Silent, Light Weight



Simple in Construction without Back Pressure

Automobile, Stationary, Marine

ACME MOTOR CAR & REPAIR CO.
CLEVELAND, O.

Write for Circulars

<i>Southern Agents:</i> A. L. Dyke, 111 Pine St., St. Louis, Mo.	<i>Eastern Agents:</i> Smith J. Edwards, 116 Nassau St., New York City	<i>Western Agents:</i> E. J. Day & Co., 519 Mission St., San Francisco, Cal.
---	---	---

"Exide" SPARKING CELLS

These cells have been designed and assembled with great care, special attention having been given to each detail, making them a practical ignition cell for gasoline engines in Automobiles and Auto Buses.

THE ELECTRIC STORAGE BATTERY CO. PHILADELPHIA, PA.

Depots for the prompt delivery and care of Exide Batteries.

PHILADELPHIA, 260 North Broad St.	PITTSBURG, 5905 Centre Ave.	TOLEDO, 235 Ontario St.
NEW YORK, 49th St. and 8th Ave.	COLUMBUS, 4th and Gay Sts.	SAVANNAH, 309 Bull St.
BUFFALO, 200 Pearl St.	CLEVELAND, 23 Oak Place.	DENVER, 1449 Clarkson St.
ROCHESTER, 188 South Ave.	DETROIT, 285 Jefferson Ave.	SAN FRANCISCO, 636 Howard St.
BOSTON, 39 Stanhope St.	CHICAGO, 204 East Lake St.	PASADENA, 33 South Raymond Ave.
	ST. LOUIS, 809 Walnut St.	

Sales Offices: NEW YORK, BOSTON, CHICAGO, ST. LOUIS, CLEVELAND, SAN FRANCISCO, TORONTO, CANADA

ALUMINUM CASTINGS

PHOSPHOR BRONZE CASTINGS
GAS ENGINE BABBITT



BETTER GOODS
RELIABLE SERVICE
SAVING PRICES

Write us before placing your orders elsewhere

CLUM & ATKINSON
ROCHESTER, N. Y.

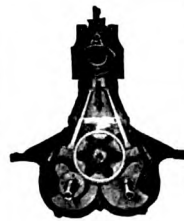

INTREPID MOTOR
Gasoline Single Cylinder
NO VIBRATION
From any source, torque reaction or reciprocating parts.
ROTARY MOTOR VEHICLE CO.
45 Columbus Ave., Boston, Mass.

THE STRIET MOTOR

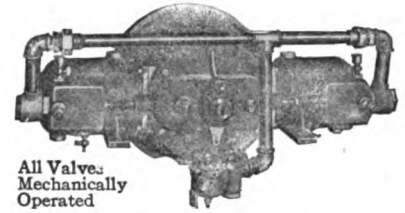

All Valves Mechanically Operated

5x5 Double Cylinders opposed, developing 15-16 H.P. Simple Construction, Efficient—best workmanship guaranteed. **READY SOON—4 Cylinder Vertical—French type.** Write for full specifications of either.

A. STREIT MACHINE CO.
1108 Harrison Avenue, Cincinnati, Ohio.

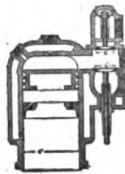

GASOLINE MOTOR
CYLINDERS,
4 by 4, 5 by 5, and 6 by 6 inches
Rough or Machined
LOWELL MODEL CO.
Drawer 1213
LOWELL, MASS.

SUBSCRIBE FOR THE AUTOMOBILE WEEKLY—\$2.00 PER YEAR

CHARGE YOUR BATTERIES WITH A HOLTZER-CABOT MACHINE
Write for particulars



THE HOLTZER-CABOT ELEC. CO.
BOSTON (Brookline) MASS.
NEW YORK CHICAGO

MONARCH

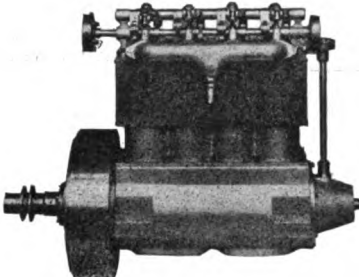

DO YOU WANT MORE POWER?
Replace your present motor with the **MONARCH.** Occupies same space. 34 actual H.P. Weight 340 lbs. Write for circular.
TREBERT AUTO & MARINE MOTOR CO., Rochester, N.Y.

New York Show, Concert Hall, Chicago Show, Gallery Annex, Space 266.

Continental Motors

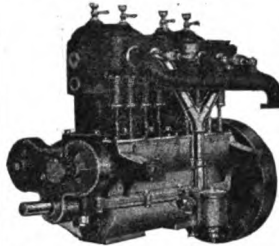

for Auto and Marine use are best on the market, because they are built of the highest grade of materials and are correct in design, and most efficient and satisfactory in operation. They are not cheapest in price, but are most economical and they are guaranteed in every way. Our 1900 models are in advance of all others on market. 2-cylinder 12 B. H. P. and 4-cylinder 24 and 30 B. H. P.

AUTOCAR EQUIPMENT CO.
240-244 West Lake Street, Chicago, Ill., Also Carburetors, Transmissions and Appliances

UP-TO-DATE Engines, Transmission Gears and Clutches

Equal to the very latest French production; air and water-cooled Motors. Air, 1 to 4 cyl.; 2 to 15 H. P. Water-cooled Motors, 2 to 8 cyl.; 10 to 45 H. P.

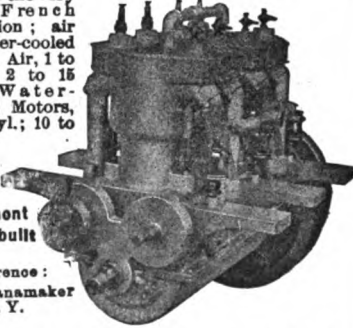

Searchmont Cars Rebuilt

Reference: John Wanamaker N. Y.

Trebert Gas Engine Co., 160 W. Main St., Rochester, N. Y.

We Build From 1 to 12 Cylinders, 12 to 180 H.P.

Gasoline Motors for Racing Cars, Passenger Buses, Launches, Delivery Trucks, Grading Locomotives and Dynamos.

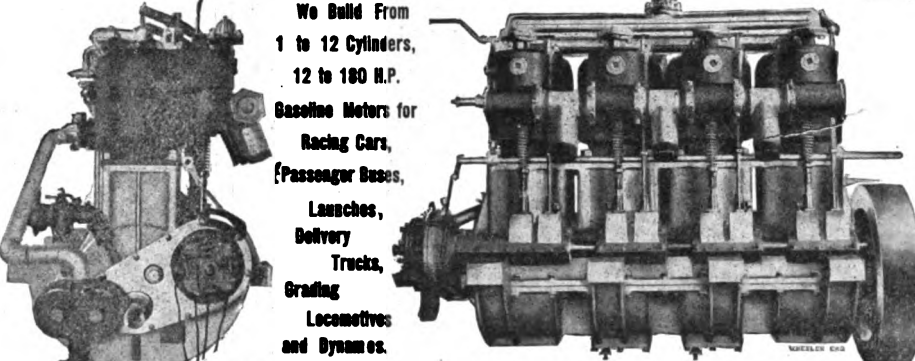

MILWAUKEE AUTO ENGINE & SUPPLY COMPANY
700-708 Winnebago St., Milwaukee, Wis.

The Practical Gas Engineer

WHAT TO DO AND HOW TO DO IT. A book of 150 pages neatly bound in cloth. Sent postpaid for \$1.00. Address Book Department, The Automobile, Flatiron Building, New York.

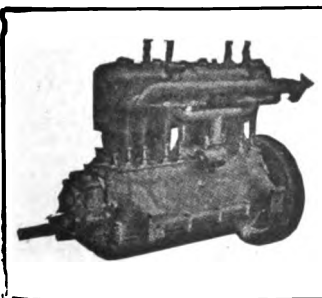

ASTER MOTORS IN U.S.

We have taken the exclusive agency for the Aster Motors made by the celebrated French firm L'Aster. We will keep in stock all sizes from 2½ h.p. to 60 h.p.

See Our Exhibit at the St. Louis Exposition

Send for Circulars

A. J. MYERS, - - 307 WEST 44th STREET, - - NEW YORK

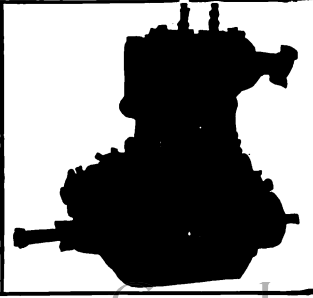



HARRIS OILS

MAKE EASY RUNNING

Years of tests have demonstrated that they are the best for Automobile use. Some our most enthusiastic customers are owners of high-priced foreign Cars. If you have oil troubles write us—we have given relief to many others.

For sale at all the principal Automobile Stations and Garages throughout the country, and

A. W. HARRIS OIL CO., 330 S. Water St., Providence, R. I.

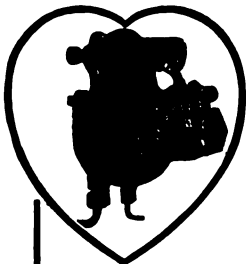

THE SCHEBLER CARBURETOR

IS "King of Them All"

FORD Motor Co.'s racing machine makes new world's records for light and middle-weight cars, fitted with a SCHEBLER. Read this letter from the Ford Motor Co. Detroit, Mich., Nov. 14, '04.

Mr. F. H. WHEELER, P. O. Box 276, Indianapolis Ind.

Dear Sir:—We have yours of the 7th, and our machine was fitted with one of your carburetors in its World's record travels.

Yours truly FORD MOTOR COMPANY, By O'Brien.

F. H. Wheeler, Sales Agent for the World, Indianapolis, Ind. E. J. Edmond, 52 W. 43d St., New York City, New York agent. P. J. Dasey, 435 Wabash Ave., Chicago agent. E. H. Shepard, 43 Boston Ave., West Medford, Mass., Boston agent. Los Angeles Automobile Co., Southern California agents.

PACKARD High Tension-Enameled Cambric Ignition Cable

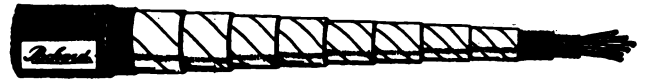

Showing method of building up the Insulation. Two layers thread—eight layers enameled tape. Two braids—four coats enamel and four bakings.

HEAT-CREASE-OIL AND WATER-PROOF

SEND FOR BOOKLET "B"

The Packard Electric Company WARREN, OHIO

"GET A GOOD GRIP

ON THE

SLIPPERY PLACES"

Morally or Physically this is excellent advice. In automobiling it prevents accident and reduces the wear on tires.

THE WEED Chain Tire Grip

gives secure footing to a car and is easily put on or taken off. Will not injure the tire. Send for booklet.

WEED CHAIN TIRE GRIP CO. 28 Moore St., New York

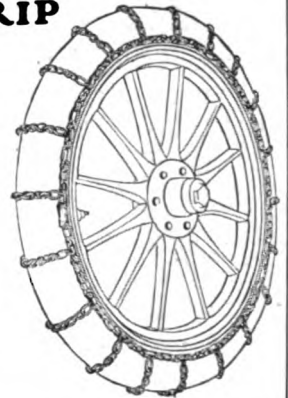

The Perfect Automobile Pail

Light, Compact, Strong and Automatic

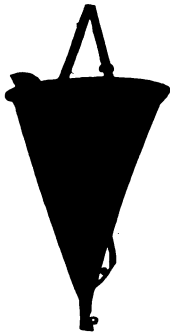

We have worked some time on the problem of a perfect automobile pail. We think we've solved it. Our automobile pail is light, folds into small space, is extremely easy to handle, and very durable.

You can pour from the top or the bottom. The top is so constructed as to prevent slopping over, and is provided with a snout and strainer—a most essential feature where water is dipped from streams.

The nozzle in the bottom has an automatic valve. When the nozzle is dropped into the inlet to tank the ring on the valve-stem catches on the side of the inlet and opens the valve. Raising the pail instantly closes the valve. The stream can be graduated to any size and the pail can be used equally for water or gasoline. Look for the trade-mark—N. I. R.

Chicago Office, 844 Monroe St.

National India Rubber Co.,

BRISTOL, R. I.

The Practical Gas Engineer

WHAT TO DO AND HOW TO DO IT. A book of 150 pages, neatly bound in cloth. Sent postpaid for \$1.00. Address Book Department, The Automobile, Flatiron Building, New York.



ARTILLERY WHEELS

1905-DESIGNS NOW READY.

Hubs equipped with Roller, Ball or Friction Bearings. Steering Devices fitted to all Hubs. : Steel Rims.

Write for Prices.

Prompt Deliveries.

JAMESVILLE WHEEL MFG. CO.,

JAMESVILLE, N. Y.

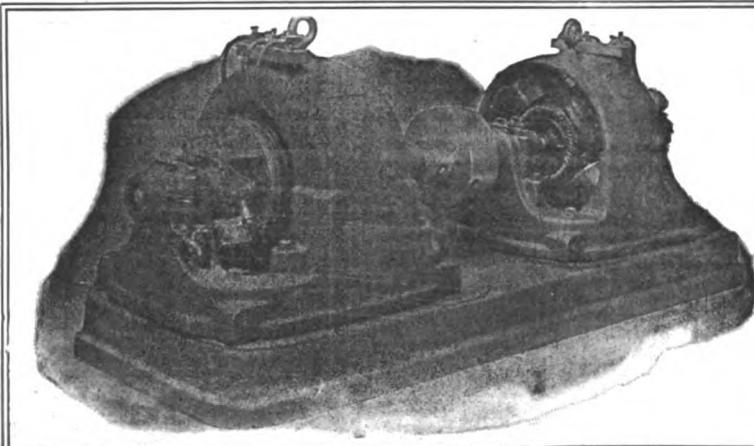

Battery Charging Sets

For Changing either ALTERNATING or DIRECT Current to Suitable Battery Current.

—ALSO—

SWITCH-BOARDS FOR SAME

With Automatic Controlling Switches by which Equipment will take care of itself while charging

WAGNER ELECTRIC MFG. CO., St. Louis, Mo.

Contracts with Vehicle Manufacturers and Dealers especially solicited.

LONGUMARE CARBURETOR

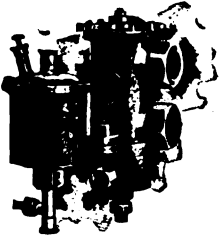

On the market seven years. Thousands in use. Will not flood motor and is absolutely reliable. We carry in stock all sizes of imported Longumare Carburetors, in addition to the American make, suitable for motors from 3 to 30 H. P.

BRADFORD MOTOR WORKS, BRADFORD, PA.

This is IT

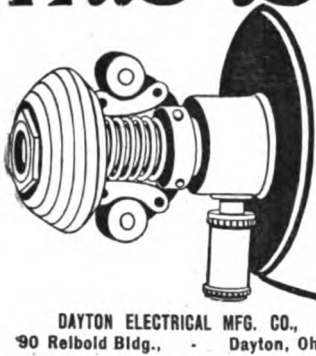

This is the mechanical generator of electric current for ignition that is creating so much enthusiasm among gas motor users everywhere.

The Apple Automatic Sparker

Is the surest and most satisfactory ignition device made. It is a perfect dynamo that furnishes a hotter spark and surer ignition, thus giving greater speed and power than is possible with dry batteries of any sort. When used with our igniting and lighting outfit it furnishes enough current to run three electric lights.

Specify an Apple Automatic Sparker to furnish current for your engine. Write for complete information about our modern ignition apparatus of every kind.

DAYTON ELECTRICAL MFG. CO.,
90 Reibold Bldg., Dayton, Ohio

1905 HOLLEY AUTOMATIC CARBURETORS

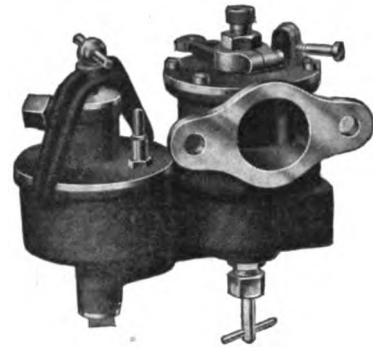

Type "O" carburetor adopted by the Olds Motor Works for their entire output of 1905 Runabouts.

The use of my carburetors have increased the horse power of different cars from 20 to 30 per cent.

This percentage is not guessed at but is the result of actual brake horse power tests taken at the largest factories in the country from elaborate testing apparatus.

I have something of interest to say to dealers representing the Olds Motor Works or in fact any dealer.

New catalog is ready.

HOLLEY, - BRADFORD, PA.

AUTOMOBILE COOLERS

MADE WITH OUR SPIRAL RADIATOR TUBING

"A tube that does more work for the same weight than any other tubing in existence."

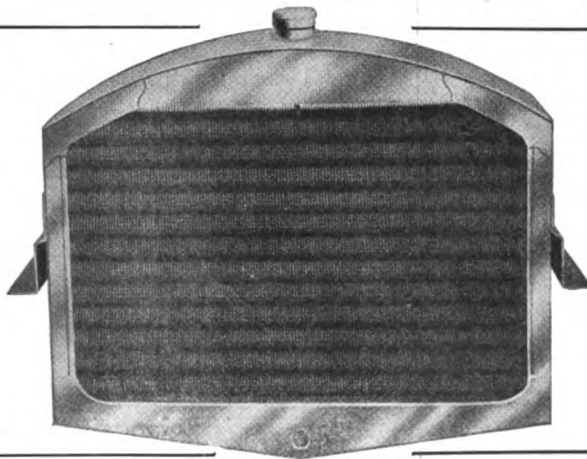

THE TUBE OF SUPERIOR PROPORTION:

Distribution of metal where it will do the most good. Proved to be the most efficient tubing made. Send for catalog of latest types in Automobile Coolers.

LONG MANUFACTURING CO.
CHICAGO, ILL.

THE HUSSEY DROP FORGE AND MFG. CO. CLEVELAND, OHIO.



Manufacturers of Universal Joints, Crank Shafts, of all descriptions and sizes, Steering Knuckles, and Yokes, and all parts pertaining to Frames. Will be pleased to give our best prices on this style of work; Steering Gears, Staff, Double Control and Wheel, complete, ready to attach to an automobile, also circulating pumps and radiators. Prices cheerfully given.

"It's Nice to Know
How Far You Go."
—Veeder Odometers.

THE VEEDER MFG. CO.
22 Sargeant St., Hartford, Conn.
Cyclemeters, Odometers, Tachometers, Counters and
Fine Castings.

Volier Horns

VOLIER : PARIS

MODELE DE LUXE

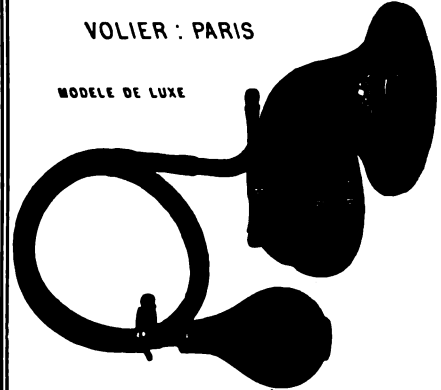

THE VOLIER DRAGON

One of the many 1005 styles on which we
are now prepared to give special quotations
to jobbers and manufacturers.

Put & Lester Co

15 Sargeant Street, - Hartford, Conn.

Laminated Wood

Stronger
Lighter and
More Durable
than Solid
Wood

They Do
Not Crack



Style J.
Special
Prices
to Body
Manufacturers

We have
Special
Facilities
for getting
This work
Out
Promptly

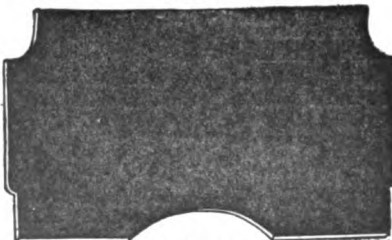

Style 205.

**AMERICAN
VENEER
COMPANY**
100 Market St.
NEW ORANGE, N. J.

Auto-
mobile
Seat Bend-
ings, Dash Boards
and Mud Guards
at attractive prices.

Kingston Carbureter

OVER 23,000 IN USE

Pat. May 12, 1903. Other patents pending.

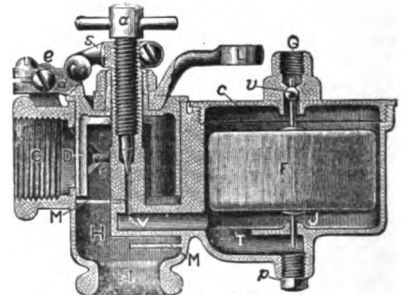

KINGSTON

Carbureters, Mufflers, Spark-
Coils, Spark-Plugs, Steering
Wheels, Pumps, Oiling De-
vices, Etc.



BYRNE, KINGSTON & CO.

Kokomo, Ind., U. S. A.

LOCKE & COMPANY AUTOMOBILE BODIES

218-220 WEST 84TH ST.,
NEW YORK

WITHOUT PRALLEL IN THIS COUNTRY OR ABROAD .
COMBINE EXTREME ELEGANCE, MOST REFINED
DESIGNS AND UNEXCELLED DURABILITY

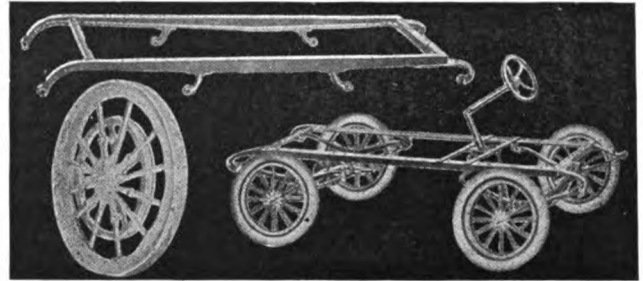
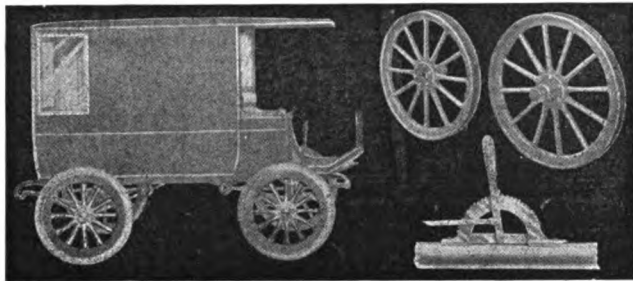

Get ready for **WINTER ASSEMBLING** and be in time
We build or supply everything for the assembler and dealer and
will mail **Free** 1905 catalogue showing the finest collections
of parts ever printed in any catalogue.

Our assortment of parts is the superior of anything ever before offered
for pleasure and commercial use.

J. H. Neustadt, = St. Louis, Mo.

At the Automobile
Shows notice

"Whitney" Chains

on most of the
Leading Cars

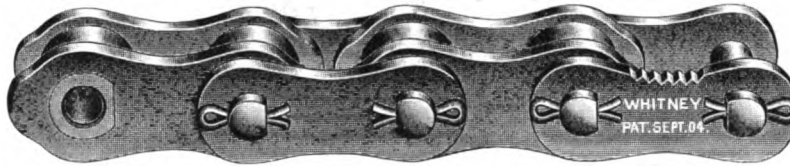

THE
**WHITNEY
MFG. CO.**
Hartford,
Conn.

Brazing Aluminum

Engine Cases, Gear Cases, Pumps, Carburetors
and all kinds of Aluminum parts Brazed

Telephone, 2194-38th



462 ELEVENTH AVE., NEW YORK CITY



The Practical Gas Engineer

What It Is and How To Do It. A book of 180 pages neatly bound in cloth. Sent post-paid for \$1. Address Book Department, The Automobile, Flatiron Building, New York.



PARK, CLINTON & VIRGINIA STS.

**Pressed Steel Frames
Rear Axles, Front Axles
Forgings and Steel Stampings
Transmission Gears
Steering Columns
Hubs and Hub Caps**

Send Blue Print for Estimate

A. O. SMITH COMPANY, Milwaukee, Wis.

Makers of Automobile Parts Exclusively

New York Show—Section "D" Concert Hall.
Chicago Show—Gallery spaces 241, 242, 243 and 244.



HIGHEST GRADE OF
Automobile Apparel

FOR MEN AND WOMEN

Fur Coats, from \$15.00—\$30.00
Leather Jackets \$6.00 up

We deal in Automobile and Driving Apparel exclusively.

We will exhibit at the Madison Garden Show and in importers salon.

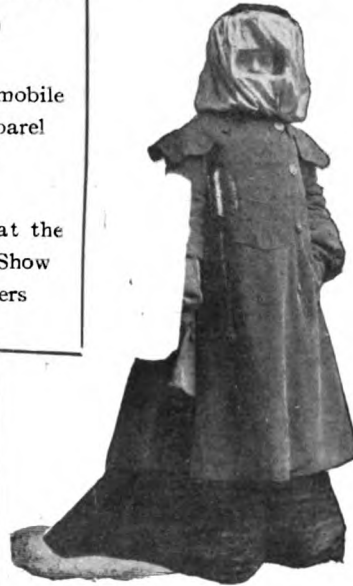

Scandinavian Fur & Leather Co.

16 WEST 33D STREET, NEW YORK

WRITE FOR CATALOGUE



MILLER TOURIST CAP

This is a practical Winter Cap, and furnishes protection against the cold and rain.

Furnished in CRAVENETTE, LEATHER, and raw-edge heavy woolen MELTON CLOTH. Either style or any size.

Price \$2.00 each, postage paid
Catalog mailed on request.

CHARLES E. MILLER

Manufacturer, Jobber, Exporter and Importer.

97-99-101 **Reade Street, N. Y. City**

RETAIL BRANCH—Broadway and 38th Street, N. Y. City.

BOSTON BRANCH—202-204 Columbus Avenue, Boston, Mass.

PHILADELPHIA BRANCH—318-320 North Broad Street, Philadelphia, Pa.

CONSTRUCTION OF A GASOLINE MOTOR VEHICLE. By C. C. BRAMWELL. Contains 150 pages, 6x9; one hundred illustrations and diagrams. Publisher's price, \$2.00; our price, 50 cents. Address Book Department, The Automobile, Flatiron Building, New York



A Tickling Proposition

for the coldest feet—large or small—in the coldest weather, is
The X-Radium Foot Warmer

Requires no fuel—costs nothing to operate. Heats in 20 minutes—stays hot for hours. No smell—no smoke.



It's light in weight; lasts a life-time. Fits any vehicle. It's a hot seller at retail.

You'll find our terms to the trade a most "Tickling Proposition"
Novelty Mfg. Co., Dept. 3, Jackson, Mich.



Hansen's Auto Gauntlets

☞ Specially designed for the automobilist—perfect fit, permitting most delicate adjustments. Made from selected horsehide which wears like iron, and never shrivels or hardens. Either unlined or with warm wool linings, and with large or extra large gauntlet cuffs to cover the largest overcoat sleeves. The various styles are sold at different prices; if your dealer can not supply you, we will.

Send for beautiful catalog illustrated in colors.

O. C. HANSEN M'FG CO.
356 E. Water St., Milwaukee



"Built Like a Hand"

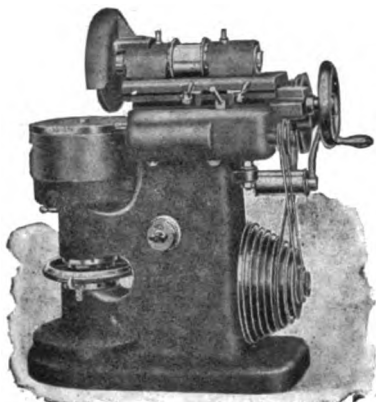

NEW NOVEL ACCURATE RAPID

AUTOMATIC

SIMPLE ECONOMICAL

POWER and SPEED
 Are Wanted To-day in Automobile Engines as NEVER BEFORE.

— THE HEALD —
PISTON RING GRINDER

WILL DO MORE TO ACCOMPLISH THIS RESULT THAN ANY OTHER TOOL YOU CAN PUT INTO YOUR WORKS

BECAUSE

THE INCREASED ACCURACY IN FITTING THE RINGS TOUCHES THE VITAL POINT IN EVERY ENGINE, PREVENTING LEAKAGE AND CORRESPONDING LOSS OF POWER, AND

YOU WILL SAVE MONEY

IN FITTING EVERY RING BESIDES.

The Heald Machine Co., Station D4
 Worcester, Mass.



Goin' Tourin'?

Every Automobilst has experienced the soiled condition of the hands after making adjustments or repairs on the road and the scarcity of water when most needed. To meet these conditions and to make TOURING more pleasant we have placed on the market the

Rubber Auto Wash Basin

(and water tank combined). Pocket at each end of basin; soap and towel

Size of basin 12" x 10" having false bottom or reservoir in BASIN holding water (hot or cold) sufficient for washing a dozen or more times without refilling. Absolutely watertight. Water enters basin *only* when valve is opened. Convenient to carry, folding up like an opera hat when not in use. In cold weather it is filled with hot water and used as a foot warmer. By far the most useful article of the Motor Car Equipment. Send for Catalog Prices. Sold by All Dealers.

(Electros now ready for Jobbers' Catalog) "Skat" Hand Soap furnished with each Basin. **RUBBER APPLIANCE CO., Springfield, Mass.** General Offices, 27-35 Taylor St.

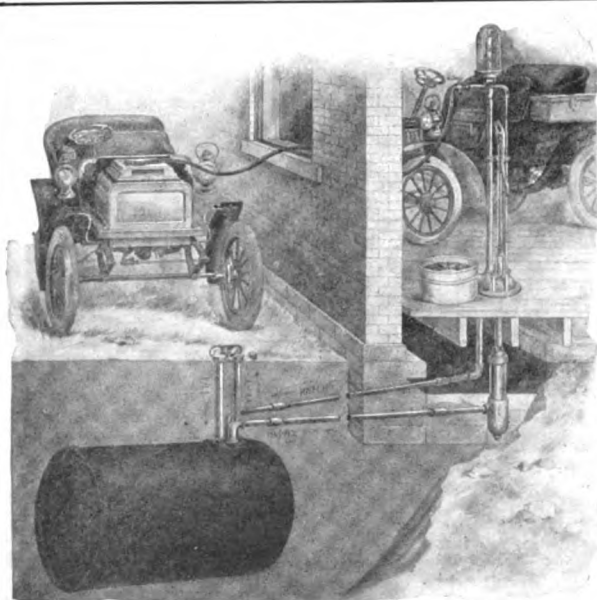

SEND FOR CATALOG NOW

Don't wait till you or your neighbor have suffered from gasoline explosion. Don't wait till excessive insurance and the increased cost of your gasoline amounts to more than the cost of your outfit. Don't wait till repair bills and troubles caused by water and dirt in gasoline causes you to think an automobile is a nuisance and more trouble than pleasure.

— DON'T WAIT —

THE DOME SAFETY GASOLINE STORAGE OUTFIT

Is the only absolutely safe system; It is the only system that allows inspection of every drop of gasoline before it enters your car tank. It is the only system that returns the unused gasoline to the underground tank. It is the only system that is fume proof.

Write for Catalog

See Our Exhibit at the New York and Chicago Shows

(1)
THE TOKHEIM MFG. CO.
 Cedar Rapids, Ia.
 Send me catalogue and prices of your "DOME" Gasoline Storage OUTFIT
 Name _____
 Address _____
 City _____

INCOMPARABLE FISK



It stands alone, the leader in Construction and Fastening.

Note the Construction.

If your dealer can't tell you about the new *Fastening* write us.

Blow-outs Eliminated.

[Mileage Doubled.

["HEAVY CAR TYPE."]

THE FISK RUBBER COMPANY

CHICOPEE FALLS,

MASS.

BRANCHES AND REPAIR DEPOTS:

Boston
Springfield
New York

Syracuse
Buffalo
Detroit

Chicago
San Francisco
Philadelphia

Washington
Toronto
St. Louis

Omaha
Minneapolis
Denver

Los Angeles
London



THE BUCABOO

of Automobiling is a constant worry over what will happen if a tire should puncture or burst. It spoils your pleasure and when the trouble does occur it brings other troubles with it. Why not avoid this strain and make absolutely sure of reaching your destination on time by putting on a set of

Tennant Pneumatic Puncture-Proof Tires?

They cost more! Yes, but they are worth all the difference and more besides, because **you can't puncture them**, and they never burst. We have a little booklet explaining the why and wherefore in detail. We shall be glad to send it to you **free**.

TENNANT AUTO TIRE CO., 150 W. Main St., Springfield, O.
BRANCHES: 1900 Broadway, N. Y.; 1461 Michigan Ave., Chicago; 69 Portland Place, Montclair, N. J.; 3d and Los Angeles Sts., Los Angeles, Cal.

TWO DOLLARS

will insure the regular weekly visits of **THE AUTOMOBILE** for one year * **Subscribe now**

Extract from Editorial in HORSELESS AGE of December 14, 1904.

Mechanically Attached Tires.

"Real tire trouble consists not in the difficulty experienced in removing a tire from or attaching it to a rim, but rather in the cause which makes its removal necessary, and the motorist is not looking with nearly so much anxiety for the tire that can be easily removed as for the tire that need not be removed. So far as he is concerned, if his tires will stay in proper condition it matters not by what means they are attached, and if his tires do not remain in proper condition the ease or difficulty with which he can remove a quantity of damaged rubber and fabric from the rim of a wheel and substitute for it a new tire of substantial value in dollars and cents usually gives him less concern than does the cost of the operation."



Substance of what we have to say regarding CONTINENTAL TIRES

We want to impress on automobile dealers once more that in order to secure the most satisfaction from the sale of 1905 cars, and in replacing tires on old cars, much time and unnecessary annoyance will be saved by furnishing CONTINENTAL TIRES. The 1905 model will be still better, although but little improvement could be made on previous models. CONTINENTAL TIRES have come to STAY in every sense that the word implies. CONTINENTAL TIRES are seen on high grade cars. "Any old tire" will do for poor cars.

Dealers attending the Auto Shows should arrange to study the good points of **CONTINENTAL TIRES** at our exhibits, as demonstrated by our experts. Knowledge is power. **CONTINENTAL** knowledge leads to healthy bank accounts. Send for information regarding our new specification system for 1905.

THE CONTINENTAL CAOUTCHOUC CO., 298 Broadway, NEW YORK.

EMIL GROSSMAN, General Manager.

Department A.

Factory: Hanover, Germany.

WE WILL EXHIBIT AT

New York: Madison Sq. Garden, Jan. 14-21, 1905. Spaces 20 and 21.

Chicago: Coliseum, Feb. 4-11, 1905. Spaces 282 and 283.

Suit Against Michelin Tires

WE beg to notify the trade that we have commenced suit against the United States Agency Michelin Tire Company for infringement of our letters patent on Clincher Automobile Tires, and desire to warn the trade against the purchase of such tires.

The following concerns are operating under licenses granted by us:

- | | |
|-------------------------------|---|
| The Hartford Rubber Works Co. | Morgan & Wright. |
| India Rubber Co. | B. F. Goodrich Co. |
| Diamond Rubber Co. | Fisk Rubber Co. |
| Goodyear Tire & Rubber Co. | Continental Caoutchouc Co. |
| | International Automobile & Vehicle Tire Co. |

The G & J Tire Co.
INDIANAPOLIS, IND.

SAMSON LEATHER TIRE AND PROTECTOR

NON-SKIDDING

NON-PUNCTURABLE

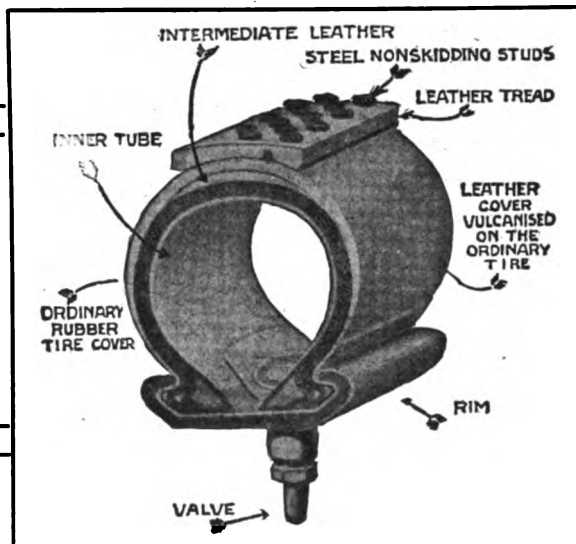

Chicago Agent
J. B. McKEAGUE
324 Dearborn Street
Chicago

A. E. GALLIEN, Mgr.
12 West Thirty-third Street, New York City
OPPOSITE THE WALDORF
Paris Berlin London Brussels Vienna

Boston Agent
JAMES COOESBALL
18 Columbus Avenue
Boston



*Made So Good that
They will give no
Cause for Removal*

Diamond 1905 Detachable Clincher Tires

INVESTIGATE results shown by DIAMOND 1905 wrapped tread construction. Unlimited tests prove it no exaggeration to say that these tires establish a new high grade of tire superiority, and it is exclusively their own. Examine their construction at the auto shows.

The Clincher style of applying and fastening tires has been tried out against every variety of other methods during many years past in Europe, and still the Clincher type leads everything.

THE DIAMOND RUBBER CO.

Branches

NEW YORK, 15 Warren Street
NEW YORK, 1717 Broadway
BOSTON, 174 Columbus Avenue
PHILA., 304-306 No. Broad St.
BUFFALO, 41 Court Street
ST. LOUIS, 3966 Olive St.

AKRON, O.

Branches

DETROIT, 310 Woodward Ave.
CLEVELAND, 823 Huron Street
CHICAGO, 167-169 Lake Street
DENVER, 1655 Blake Street
SAN FRANCISCO, 608 Mission Street
MINNEAPOLIS, 611 1st Ave. S.

Send for book, "How to Get Best Results with Tires." Will be ready soon. A postal will do

BULLETIN

OF

G & J RECORDS

**World's Championship
and World's 10-Mile Track
Record**
PEERLESS GREEN DRAGON
By Barney Oldfield
9:12 3-5

World's Track Records
PEERLESS GREEN DRAGON
By Barney Oldfield

1 mile	:51	1-5
5 "	4:29	"
10 "	9:12	3-5
15 "	14:03	3-5
20 "	18:45	2-5
25 "	23:38	3-5
50 "	48:39	1-5

**World's Track Records,
5 Miles for Light Weight
and Middle Weight Cars**
FORD RACER
By Frank Kulick

First mile	58	sec.
Second mile	57	2-5
Third mile	56	4-5
Fourth mile	55	1-5
Fifth mile	55	1-5
Total	4:43	3-5

**World's 1-Mile Track
Record for Light and
Middle Weight Cars**
20-H.P. FORD
By Frank Kulick
55 sec.

**World's Track Records
6 to 25 Miles for Stripped
Touring Cars**
PEERLESS BLUE STREAK
By Charles Burman

6 miles	6:24
10 "	10:40
15 "	16:02 2-5
20 "	21:24
25 "	26:50 1-5

**World's 5-Mile Track
Record for Stripped Tour-
ing Cars**
POPE-TOLEDO
By B. F. DINGLEY
5:09 3-5

**World's 1-Mile Track
Record for Stripped Tour-
ing Cars**
POPE-TOLEDO
By George Fuller
1:00 3-5

**World's Track Records
1 and 5 Miles for Stock
Cars in Full Touring
Condition**
POPE-TOLEDO
By B. F. Dingley

1 mile	1:11	3-5
5 "	6:02	1-5

Every World's Track Record

Is now held by

G & J Thread Fabric Tires

When the G & J Tires excel so unquestionably in racing work, which is known by everyone to be the hardest of all tests on tires, there can be no question in anyone's mind as to their great durability in ordinary road work. :: :: :: ::

Take a Tip

from the following famous drivers and **use G & J's** Barney Oldfield, Frank Kulick, Webb Jay, Frank Croker, Frank Garbut, B. F. Dingley, Charlie Burman, George Fuller. :: :: ::

Dec. 18, at Los Angeles:

B. F. Dingley, in Pope-Toledo, broke one and five mile records for stock cars in full touring condition.

1 mile 1:11 3-5. 5 miles 6:02 1-5.

Dec. 21, at Los Angeles:

Barney Oldfield, in Peerless Green Dragon, lowered all track records from two to nine miles.

2 miles 1:46. 5 miles 4:29. 9 miles 8:04.

This performance gives Oldfield and G & J Tires every world's track record from one to 50 miles.

G & J TIRE Co.

BRANCH:
429 Wabash Ave.
CHICAGO

FACTORY:
649-617 E. Georgia St.
INDIANAPOLIS

BRANCH:
247 Jefferson Ave.
DETROIT



GOODRICH TIRES FIT ALL ROADS

The Goodrich Clincher Automobile Tire is an American tire built for American roads and affords the opportunity to travel untrammelled and on an itinerary of your own choosing. It is a matter of record that the longest and hardest trips have been successfully made on Goodrich Tires.

WINNERS OF THE GRAND PRIZE AT THE ST. LOUIS FAIR

THE HIGHEST HONOR EVER AWARDED AUTOMOBILE TIRES

THE B. F. GOODRICH COMPANY
AKRON, OHIO

NEW YORK: 66-68 READE ST. and 1625 BROADWAY.
BOSTON: 157 SUMMER ST.
DETROIT: 80 E. CONGRESS ST.

CHICAGO: 141 LAKE ST
PHILADELPHIA: 909 ARCH ST.
DENVER: 1444 CURTIS ST.
LONDON, E. C.: 7 SNOW HILL.

SAN FRANCISCO: 392 MISSION ST.
BUFFALO: 9 W. HURON ST.
CLEVELAND: 420 SUPERIOR ST.

 **W**E wish our friends
and patrons
everywhere a
Happy and Prosperous
New Year.

MORGAN & WRIGHT
CHICAGO

Meet us at the New York Show. Space W.

**Just a matter of
dollars and cents**

**when
the
SOLAR
shows
the way**

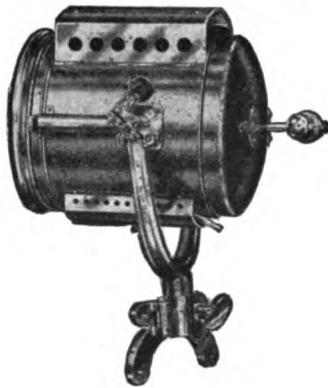

IF YOU knew for sure the car would sell better fitted with Solar lamps, you wouldn't bother much with second-bests, would you?

Specially when the best second-best is a weak imitation of the Solar—and costs about the same?

Some pretty clever men among your rivals have found out it's easier to sell a Solar-fitted car than otherwise.

Easier—and Safer.

No after-kick—"The Solar Shows the Way," and the buyer finds it out—and says so to other folks.

Might be as well to hear more Solar-talk, mightn't it?

And to look at photos of the 1905 line

Whenever you're ready, Mr. Auto Manufacturer.

The Jobber

who doesn't get the

SOLAR proposition

(confidential)

**is going to miss a lot of
auto-lamp sales next season**

Now is writing time

Address

BADGER BRASS CO. Kenosha, Wis.

Eastern Office, 11 Warren St., New York

SAXON

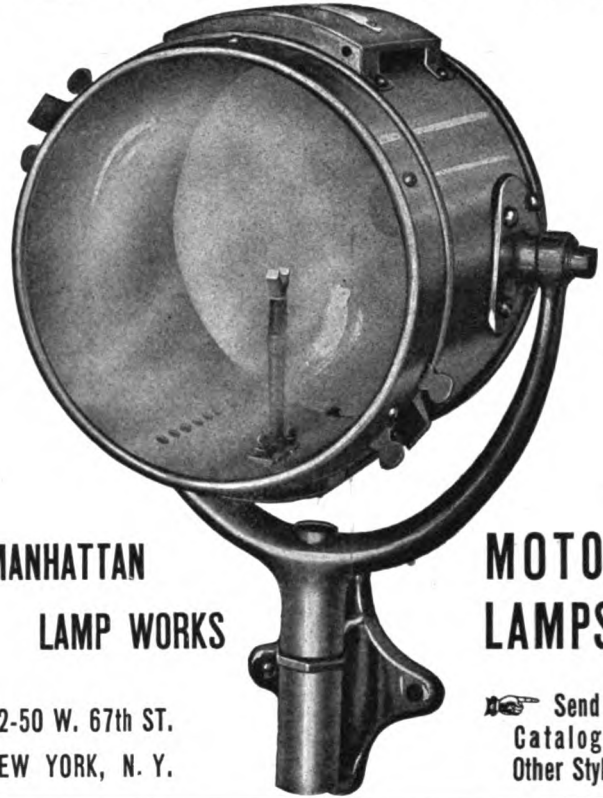

**MANHATTAN
LAMP WORKS**

**MOTOR
LAMPS.**

42-50 W. 67th ST.
NEW YORK, N. Y.

Send for
Catalog of
Other Styles.

**THE
MOSS
PHOTO ENGRAVING
CO.**

**PUCK BUILDING; NEW YORK
ELM ST. COR HOUSTON.
TELEPHONE 81 SPRING
ESTABLISHED
1871.**

*Are you Posted on
Photo Engraving*

**EXPERIENCE HAS TAUGHT US HOW
TO MAKE AUTOMOBILE CUTS**

Write us in relation to half-tones, zinc etchings, wash drawings, electrotyping or any other work you may want.

Work intrusted to us will not only be done well, it will be done quickly and reasonable.



The above illustration first appeared in our catalogue in 1896. It was used in describing the operation of our Tubular Driving Lamp which we had then been manufacturing for 10 years. It illustrates perfectly the principle of our **Oil Motor Lamps** which, as far as the principle and burning parts are concerned, are an exact copy of our Tubular Driving Lamp.

It could just as well be used for any Oil (side) Motor Lamps (of other makes) on the market, as they are all **exact copies** of our **Motor Lamps** and of our **Tubular Driving Lamp**.

We do not blame our competitors for so copying us. It is the only way to make an oil lamp to stay alight on an automobile. To be sure, in copying our Lamps they have varied enough from our models (based on 17 years' experience with this particular Lamp) so that they do not burn as well as they should. Which leads us modestly to say that you can be sure of having Lamps that will burn properly and stay alight by calling for **DIETZ LAMPS**.

R. E. DIETZ COMPANY, 33 LAIGHT ST. NEW YORK
Established 1840

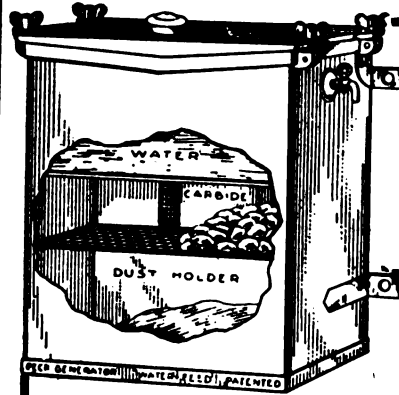

Do You Know
the
**PECK
Generator**
is
GUARANTEED

The No. 2 size is most popular; this holds 2½ lbs. carbide,
PRICE, \$21.00.

The large size, No. 3, is designed for touring, holds 5 lbs.,
PRICE, \$27.00.

There are a dozen little points found in this generator exclusively that combine to add greatly to the convenience of the user. Its superiority is clearly proven by its perfect working under the most adverse conditions. You cannot afford to neglect the opportunity to investigate our claims at New York Show, space No. 3.

Our new styles in Oil Lamps and a full line of Pilot Headlights with lens mirror reflectors, will be exhibited with this generator.

The Scoville & Peck Co.
New Haven, Conn.

C. J. IVEN, Sales Agent, - ROCHESTER, N. Y.

We Did It All with Our Little Searchlights

The wonderful record run of the Columbia Car from Chicago to New York in a little over 58 hours was made possible only by fast night driving. The performance showed that the car, the engine and tires were pretty nearly perfect; but the drivers declare that they could never

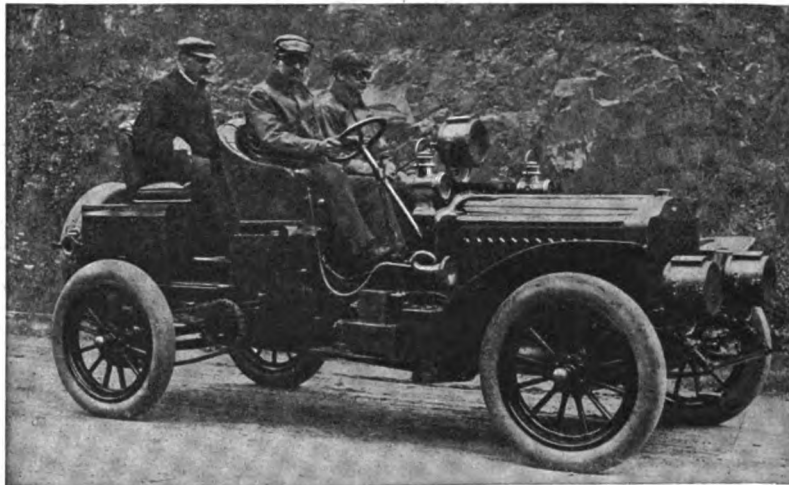

THE RUSHMORE NAVAL PROJECTORS ARE THE STANDARD OF THE WORLD.

THE FASTEST LOCOMOTIVES CARRY THE RUSHMORE HEADLIGHT

have run so fast without the famous Rushmore Searchlight. All Columbia Cars carried Rushmores last season. Nearly all the other highest grade cars will carry them next season. Just watch.

RUSHMORE DYNAMO WORKS,

PLAINFIELD, N. J.

The LAMPS of QUALITY

Write
for
Catalog
and
Prices

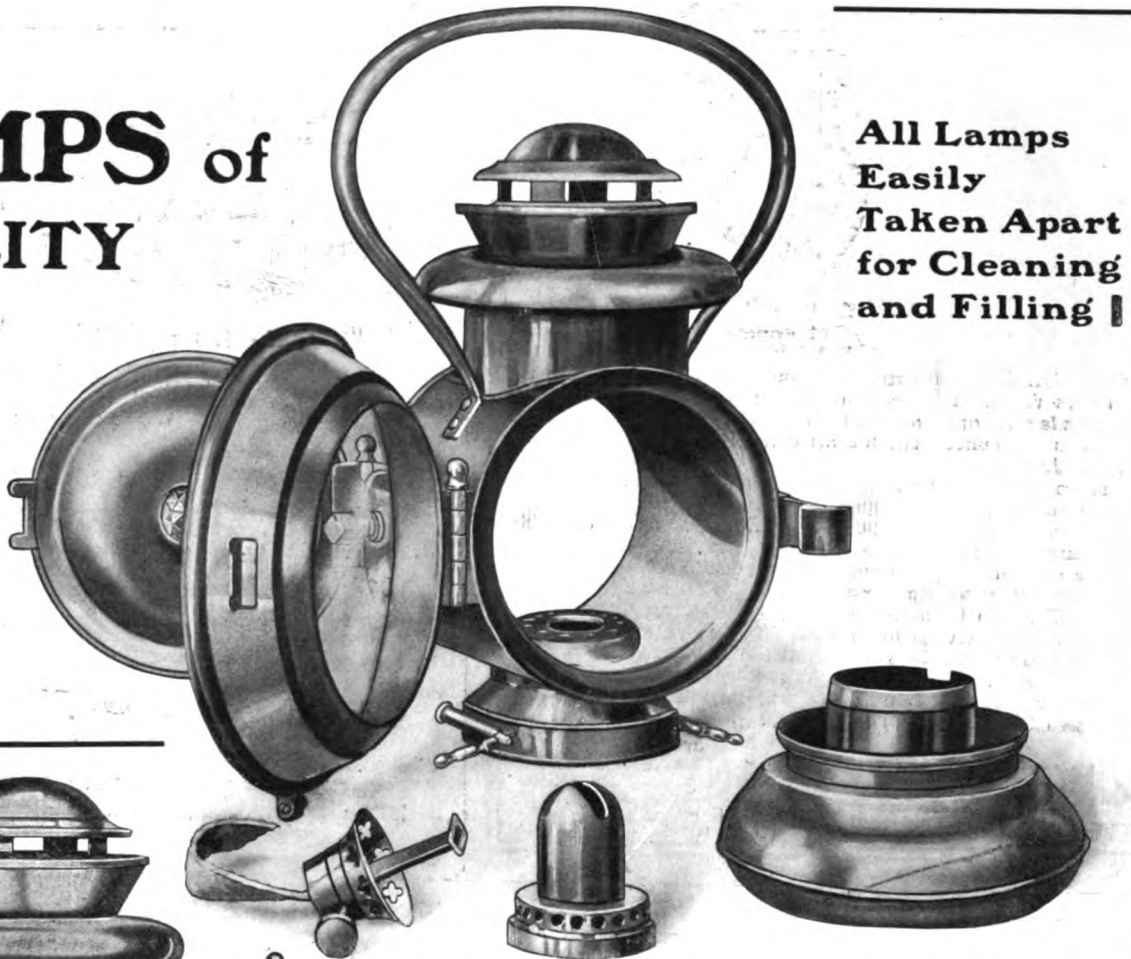

All Lamps
Easily
Taken Apart
for Cleaning
and Filling

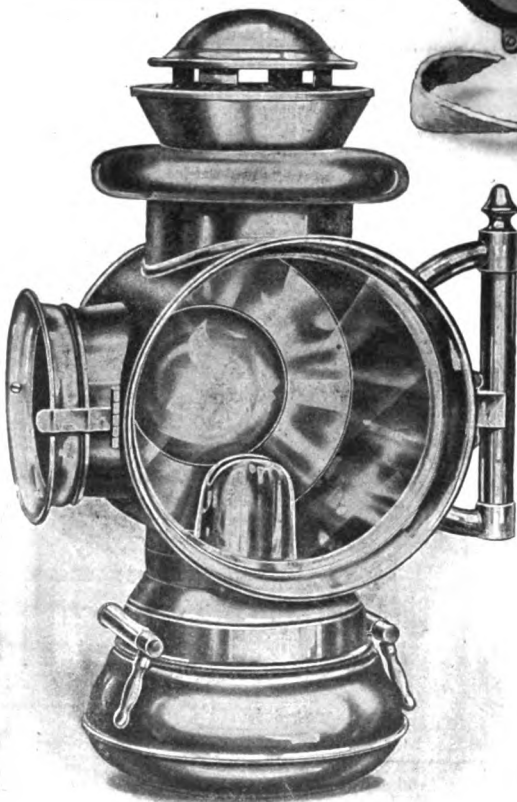

SOMETHING ENTIRELY NEW in a Tail Lamp. Has a ruby lens for rear signal and a double convex white lens for lighting entrance to car, either side or rear as desired.

Ham's Auto Inspector- and-Tail Lamp

Just One Match

C. T. HAM MANUFACTUR

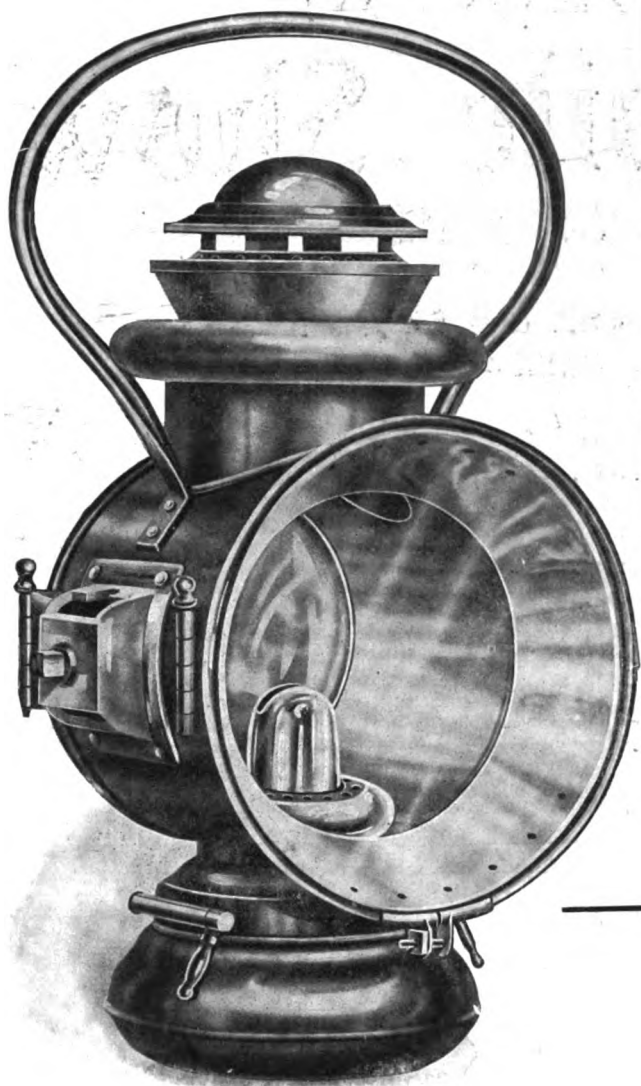

"Auto Cold Blast"

**THE LAMPS
OF QUALITY**

Absolutely Wind proof

Ham's Auto Cold Blast

Will Not Jar Out

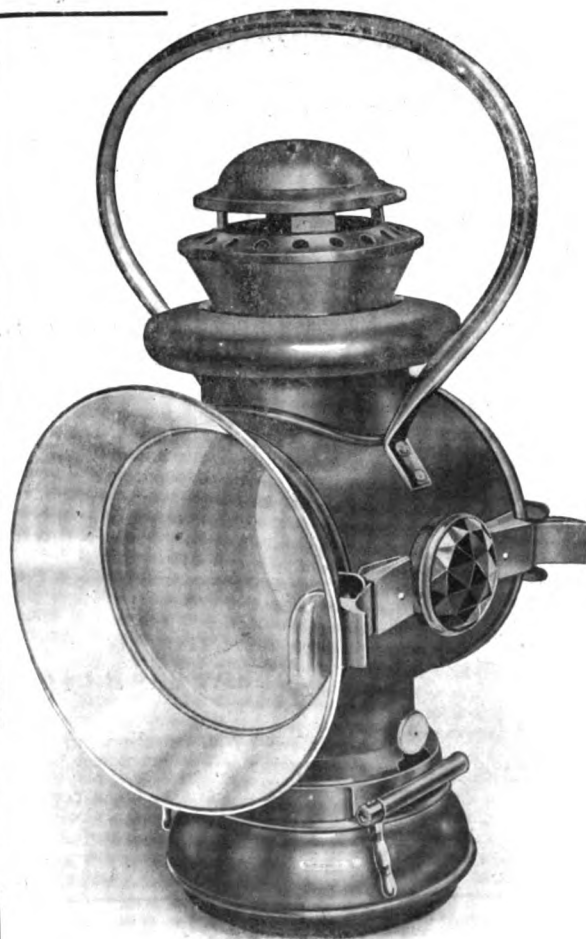

"Cold Blast Runabout"

Ham's Cold Blast Runabout

For Each Trip

ING COMPANY

**ROCHESTER
NEW YORK, U.S.A.**

FIFTH ANNUAL Automobile Show

Under the auspices of the Automobile Club of America,
National Association of Automobile Manufacturers,
and Madison Square Garden Company at

Madison Square Garden

NEW YORK

January 14th to 21st, 1905

JAMES C. YOUNG, Manager

SPECIAL NOTICE The trade admitted free up to 1 o'clock each day upon presentation of business card and registering name and address at the BUREAU OF INFORMATION.

RAILROAD RATES Only those visitors to the New York show who are members of the American Automobile Association or the American Motor League may take advantage of the reduced railroad rates granted to those organizations.
The railroad companies will positively refuse to grant a rate to anyone except members of one or both of the organizations named.
No reduced rate has been granted by the passenger associations on account of the show and none will be.
Those who desire to become members of either of the organizations named, and so take advantage of the rate, should write immediately for details to

C. H. GILLETTE, Sec'y
American Automobile Association
29 West 42d Street, New York City

ISAAC B. POTTER, Pres't
American Motor League
Vanderbilt Building, New York City

Every manufacturer of automobiles of importance in the United States will exhibit at the New York Show.

TO KNOW!

WHAT TO DO AND HOW TO DO IT . . .

When your gasoline motor or gas engine gets stubborn, can be quickly learned by owning a copy of the

PRACTICAL GAS ENGINEER

A Book of 150 Pages Neatly Bound in Cloth

By E. W. LONGANECKER, Twelve years' constant experience with Hydro-Carbon Engines

Third Edition Just Out and selling rapidly. First and Second Editions exhausted in thirteen months

How to start, how to operate, and how to care for all classes of explosive motors or engines using gas, gasoline or similar fuels.

A full and exhaustive chapter on electric and other systems of igniting.

Also chapters covering in a thorough manner troubles and remedies encountered in operating engines in motor vehicles, launches, shops, or on the farm.

Every line tells something. Every page full of interest.

Sent postpaid on receipt of price, \$1.

BOOK DEPT., THE AUTOMOBILE, Flatiron Bldg., Madison Sq., N. Y.

"Big Four"

THE GREAT HIGHWAY BETWEEN

ST. LOUIS, INDIANAPOLIS,

CINCINNATI

AND

COLUMBUS

NEW YORK, BOSTON

AND THE

EAST

M. E. INGALLS,

President.

W. J. LYNCH,

G. P. & T. A.

Cincinnati, O.

Headquarters for Buffalo Automobilists.



THE LAFAYETTE HOTEL
BUFFALO, N. Y.

EUROPEAN PLAN ABSOLUTELY FIREPROOF

This Modern Hotel is Entirely New. It is located at the corner of Washington and Clinton Streets, facing beautiful LAFAYETTE SQUARE, only one short block from Main Street and the shopping district, and in close proximity to the principal theatres.

Trolley cars from and to the various railroad and steamship lines pass the door.

The Lafayette Hotel is superbly furnished. It will cater to the Commercial and Tourist trade and the General Public. Contains three hundred rooms nearly all supplied with tub or shower bath.

Splendidly Appointed Cafes, Palm Room and Buffet

Rates for Rooms—\$1.50 per day and upwards.

SPAULDING & OAKS, Managers.



NEW AND FIRE PROOF.

THE ORIENTAL-GRISWOLD ANNEX

The Only First-Class European Hotel in the City
TURKISH, RUSSIAN and ELECTRIC BATHS

New and Strictly Fire-Proof. Café in Connection at Moderate Prices. Rates, \$1.00, \$1.50 and \$2.00 per day. Including Shower and Plunge Baths and Bath Robe.

60, 62 and 64 FARRAR ST., DETROIT, MICH.

H. L. ZERSE, Mgr. POSTAL & MORRY, Props.

IMPORTERS' AUTOMOBILE SALON



Darracq
Mercedes
Clement-Bayard
Napier
Renault

F.I.A.T.
Mors
Decauville
Panhard
Rochet-Schneider

Exhibiting 1905-Models
of the best known
Foreign Automobiles

Pipe
Argyll
Maximi
Hotchkiss
Richard-Brasier
Westinghouse
Fugot
DeDietrich
De La Haye
c & v

HERALD SQUARE EXHIBITION HALL
NEW YORK CITY

From January 11th Until January 24th

ADMISSION 50¢

MONDAYS \$1.00



"FOLLOW THE FLAG"

TAKE THE

Wabash Line

TO

FIFTH ANNUAL AUTOMOBILE

SHOW

NEW YORK CITY, JANUARY 14-21st, 1905

Elegantly equipped trains and first class service in every particular

C. S. CRANE

General Passenger and Ticket Agent
St. Louis, Mo.

A New Epoch is Marked in American Automobile Engineering

by the line of 1905

ACME CARS

Photos of the line will be shown in this space as soon as cuts can be prepared

The Acme of Perfection for 1905 will be a revelation--that's all

A line from live agents will bring photos. and our 1905 deal. Our travelers are now out. Shall they call?

ACME MOTOR CAR COMPANY, Reading, Pa.

DEVLIN & CO., 1407 Michigan Boulevard, Chicago, Ill. *Our Western Distributors*

We will exhibit at the New York and Chicago Shows



DAIMLER
—MFG CO.
LONG ISLAND CITY
—N.Y.—
MANUFACTURERS OF

**American
MERCEDDES
—AUTOMOBILES—**

OTHER American builders have attempted to duplicate foreign cars point by point, line for line. They have failed; we have succeeded. Our pamphlet, out January 10th, tells how and why.

LOOK FOR US AT THE NEW YORK SHOWS

Lubrication is important

Flake Graphite makes better lubrication possible. Dixon's new booklet

"Graphite for the Motor"

tells many interesting facts.
Send for it today.

JOSEPH DIXON CRUCIBLE CO.,
Jeney City, N. J.
N. Y. City Branch, 68 Reade Street

—THE— GLIDE GASOLENE



STYLE A. WITH TONNEAU

Runs so smooth and easy we say it glides. The mechanical construction is new and reliable. Third year on the market. Built for service anywhere. Handsome in design and finish. It is a genuine family pleasure car. Some good agencies open on fair proposition. Write to-day for full information.

Will exhibit at New York Automobile Show, January 14-21, section H, Exhibition Hall. Chicago Show, February 4-11, spaces 157-158.

THE BARTHOLOMEW CO.
110 BRADLEY AVENUE
PEORIA, ILL.

Motorists and others WHO KNOW select

The Incomparable WHITE

Those who DON'T KNOW, and are oftentimes influenced by the widely advertised achievements of specially built racing cars would do well to look into the "White" record for racing and reliability with stock cars.

**The White is a Touring Car
That Tours.**

Runs noiselessly without odor or vibration. Unqualifiedly the most reliable machine built regardless of motive power or selling price.

WHITE SEWING MACHINE COMPANY, CLEVELAND, OHIO

The Pierce-Racine:

A RUNABOUT AND LIGHT TOURING CAR

Its motor is the heart and life of an automobile. Without a powerful and reliable motor, the car will prove unsatisfactory and of no service.

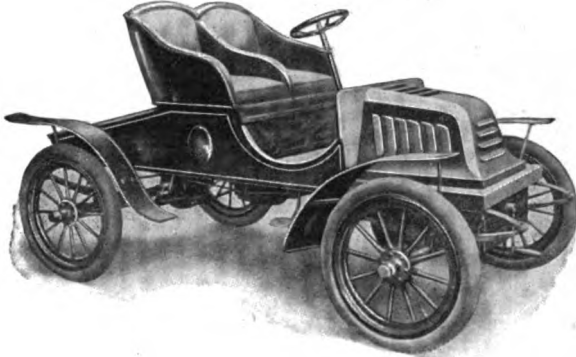

\$750

19 Years Making Gas & Gasoline Engines

Our 8000 motors, aggregating 20,000 h.p. doing business all over the world. Send for booklet.

8 h.p.; mechanically operated valves; transmission, 3 speeds forward and reverse; capacity, 120 miles without recharging.

PIERCE ENGINE CO.
Box 86

\$850

WITH TONNEAU

Facts are our Endorsements

We manufacture a strictly high grade, up-to-date, reliable car thoroughly covered by our guarantee

PIERCE ENGINE CO.
RACINE, WIS.

The Old Reliable WATERLESS KNOX

Cars for 1905

HIGHER IN QUALITY
LOWER IN PRICE



SUPERB IN STYLE AND FINISH

The Knox 1905 two-cylinder (air-cooled) machine is as quiet and as smooth working as any four-cylinder machine with only half its complications.

14-16 H.P. side-door Tonneau,	-	\$1,900.00
14-16 H.P. Convertible Surrey,	-	1,750.00
14-16 H.P. folding front seat Runabout,		1,500.00
Single Cylinder folding front seat Runabout,		1,250.00

1905 Models will be on exhibition at the New York and Chicago Automobile Shows.

Waterless Knox Automobiles awarded the *Grand Prize* at Louisiana Purchase Exposition.

Knox Automobile Co.

SPRINGFIELD, MASS.

Member Association Licensed Automobile Manufacturers

Selling Agents in All Principal Cities



TO KNOW!

WHAT TO DO
AND HOW TO DO IT

When your gasoline motor or gas engine gets stubborn, can be quickly learned by owning a copy of the

Practical Gas Engineer

A BOOK OF 150 PAGES NEATLY BOUND IN CLOTH

By E. W. LONGANECKER, Twelve years constant experience with Hydro-Carbon Engines

THIRD EDITION JUST OUT and selling rapidly. First and Second Editions exhausted in thirteen months.

Sent Postpaid on receipt of Price, \$1.

BOOK DEPT., THE AUTOMOBILE, Flatiron Bldg., Madison Square, N. Y.

The UNION

THE FAMOUS FRICTION DRIVE MACHINE



"In Union there is Strength."

The UNION Tonneau cars have two opposed four-cycle engines with a 5-inch bore and a 4-inch stroke. Artillery wheels. Wheel base 78 inch with standard 56-inch tread. If you want a machine that you can depend on whenever and wherever you want to go, you must get a Friction Drive UNION.

Tonneau, \$900

Runabout, \$825

Send for catalogue.

UNION AUTOMOBILE CO.,
Union City, Ind.

HAND BOOK OF**Gasoline Automobiles**

ISSUED FOR THE INFORMATION OF THE
PUBLIC WHO ARE INTERESTED IN THEIR
MANUFACTURE, SALE AND USE.

THIS new edition of this handsomely bound and artistically printed book containing illustrations of about 125 gasoline cars will be ready for mailing about February 1st, 1905.

The products of the principal manufacturers throughout the United States of America and the importers of gasoline machines are shown by illustrations and specifications. These specifications form a series of the leading questions that arise in the mind of the purchaser, with the answers thereto in red ink. The questions being uniform, the ease of comparison is obvious and the purchaser is enabled to select the machines which are best suited to the service required, to his personal taste, or the means at his command. The 1904 edition is now out of print.

Sent upon receipt of 6c. in stamps for postage.

Association of Licensed Auto. Mfrs.

ROOM 1010

7 East 42nd Street - - - New York

A Plain Talk with the Dealer on the Manufacturer

A PROMINENT dealer in automobiles remarked recently that the Elmore was not a good machine for agents to handle on account of there being no repairs needed. His opinion and ours differ. We do not think that it is necessary to make an automobile that has certain parts that require periodical replacement and the constant care of repairmen, to make it a good selling proposition.

In fact, that is just the opposite to the policy we are pursuing. Our endeavor is to produce an automobile so simple and reliable that the purchaser, if he has received proper instructions from the agent, with the help of our instruction book, can keep his machine in good order without constant help of repairmen.

The records that the Pathfinder made the past year have shown conclusively that our efforts have produced the desired results, and that our 1905 models are as good as an automobile can be made at this time.

Send for literature giving full description.

Elmore Mfg. Company **Clyde, Ohio**

Members Association of Licensed Automobile Manufacturers

Horse Power

Some of our competitors try to make Cadillac dealers believe that we lack sufficient horse power, and that we only "claim six and one-half horse power." It is true we rated our 1903 engine at but six and one-half horse power and our 1904 engine at eight and one-quarter horse power. We had an object in doing this. We knew we had sufficient horse power to drive a Cadillac over any road and up any hill that any automobile would go. No Cadillac engine was sent out of our engine factory that would not test above eight and one-half horse power actual brake test after one hour's run on the block.

For 1905

We have continued to use the same engine in all models under \$1,000.00 in price. We are confident that we increased the horse power delivered to the ground. We gear the heavier models for moderate speed and great power, the light ones for both power and speed. The superior construction of all models enable us to assure all prospective customers of greater road ability than we gave last year. The Cadillac has all the power necessary to drive it anywhere at reasonable speed. We've never claimed any more than we had. A Cadillac engine has on several occasions demonstrated its ability to do more work than some so-called 12 to 16 horse-power gasoline engines can do when mounted in a carriage.

CADILLAC AUTOMOBILE COMPANY,
DETROIT, MICH.

Members of Association of Licensed Automobile Manufacturers.

THE HEIGHT OF THE SEASON FOR THE
PREMIER ————— **AIR COOLED**
 IS JANUARY AND JULY

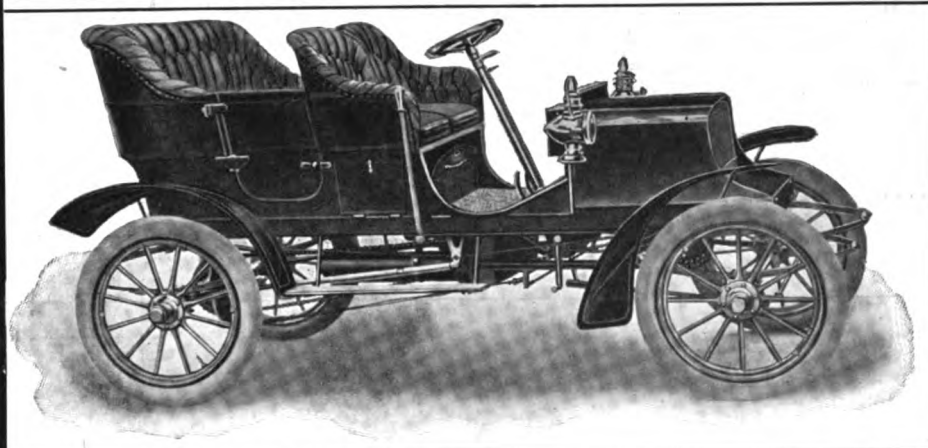

Did you ever stop to think when you saw your neighbor in New York drive away in his Premier, the thermometer at 0°, that the other fellow's neighbor in Los Angeles was enjoying the same privilege with the thermometer at 80°.

It's a business proposition for agents.
 It's a satisfactory proposition for drivers.

Get the "Car of Quality," and have a satisfactory business proposition for next year. (The air cooled has no season.)

PREMIER MOTOR MFG. CO., Indianapolis, Ind.

DOLSON FOR 1905

Our new car—new motor double opposed type—side entrance tonneau, is now ready. Thoroughly tested and absolutely reliable.

Among our many claims we enumerate:

- 1st. Contains the greatest horse-power of any similar type car on the American market. Low total weight, high compression, 5½ in. bore, 6 in. stroke.
- 2d. Embodies many mechanical improvements, properly designed, and of great strength.
- 3d. Side entrance tonneau, individual front seat, all panels of sheet steel, beautiful lines.
- 4th. Money cannot produce finer finish, upholstery or equipment.

Our traveling representatives are now out closing territories.

Write for full set of illustrations showing various views of machines. Interested dealers ask our representatives to call.

We want live agents who will appreciate prompt deliveries.

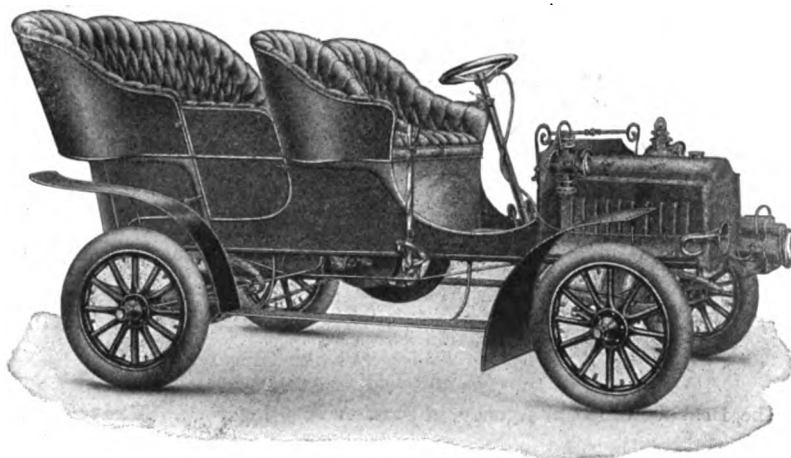

— AT —
NEW YORK AND CHICAGO SHOWS

JOHN L. DOLSON & SONS, Charlotte, Mich.

THE CAR OF MERIT—TWO MODELS

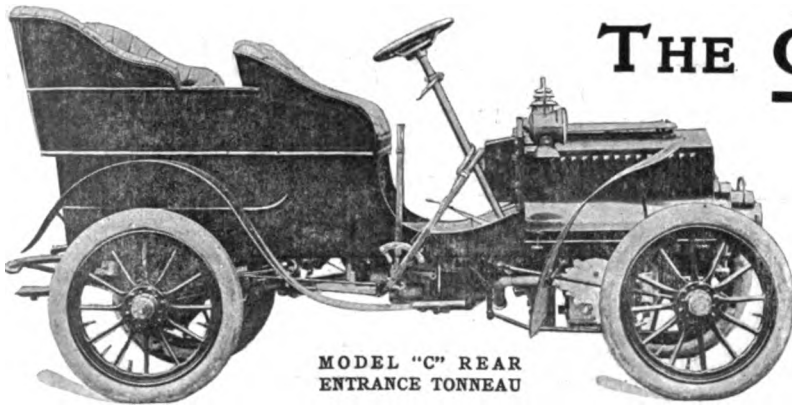

MODEL "C" REAR
ENTRANCE TONNEAU

THE CHAINLESS WOLVERINE

New Catalog Department "C"

SEE US AT SECTION "B"
Exhibition Hall, Madison Sq. Garden
New York, Jan. 14 to 21, '05

ALSO AT SPACES 165 and 166
Coliseum, Chicago, Feb. 4 to 11, '05

Many New Features; A Car With Every Part Accessible.
Plenty of Speed. A Hill Climber.
Simplicity—"Well, That's Our Watchword."
AGENTS—A demonstration will satisfy the most skeptical—
only live agents wanted.
We do not force agents to unreasonable contracts.
Larger discount than other manufacturers. Get in Line Quick.

THE REID MFG. CO.
Department C. DETROIT, MICH.



MODEL "D" SIDE ENTRANCE TONNEAU

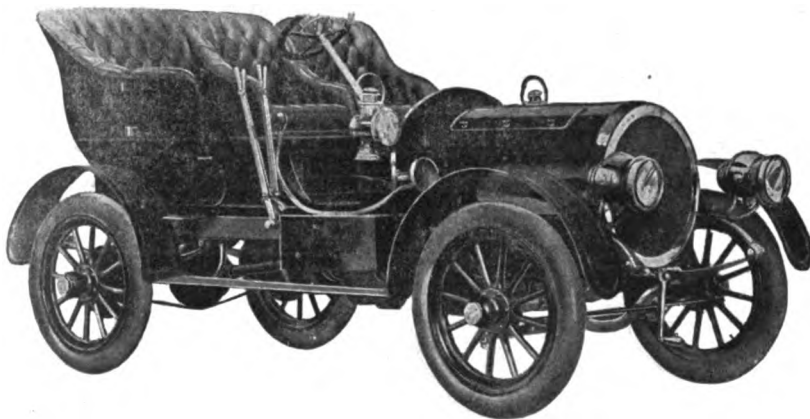

[National Model C. List Price \$2,500.

Side Entrances—Three in Rear.
Two in Divided Front Seats.
Detachable Tonneau.
Best of Finish and Trimming.
New Round Radiator—Oval Hood.

The Best Touring Car Agency in **America** for 1905. **Write Now.**

NATIONAL MODEL C

"Goes the Route"

**With NATIONALS
YOU LEAD, OTHERS FOLLOW**

Four Cylinder, 4½ x 5, Vertical.
Bevel Gear Drive.
Double Ball Bearing Slide Gear.
Transmission, Direct on High.
Hardened Steel Gears.
Gear Driven Commutator.
Rear Wheels Revolve on Double Ball Bearings on Outside Axle Tube.
All Weight Taken off Inner Axle and Differential.
Spherical Drive Case.
Internal Expanding Metal to Metal Brakes.
Pressed Steel Frame—Long Wheel Base—
Engine and Transmission on Sub-Frame.
Double Steering Connections.

NATIONAL MOTOR VEHICLE CO.

1000 East Twenty-second Street,
INDIANAPOLIS, IND.

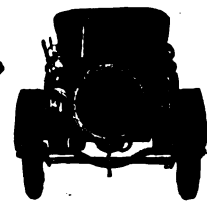

Peerless

The Car
of
Achievement

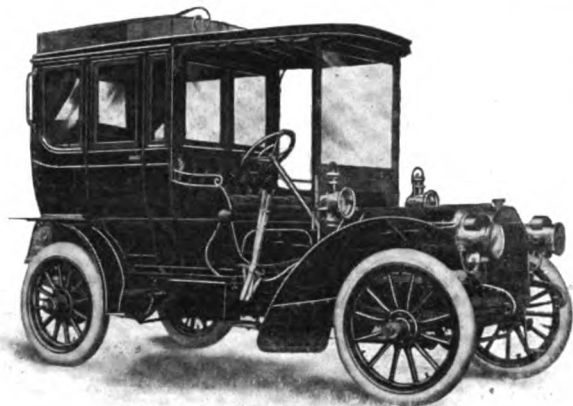

Concerning Limousines

At this season of the year those who have come to depend upon the motor car for constant service turn their attention to the limousine—a type of car which offers complete protection from the elements.

The Peerless Limousine

has a unique record for hard cross-country service. A Peerless limousine won a certificate in the St. Louis tour of the A. A. A. Other Peerless limousines, in everyday use throughout the season, have firmly established the reputation for this style of Peerless cars as being, like our touring cars,

In a Class by themselves

Send for the Limousine booklet we have just issued.

The
Peerless Motor Car Co.
CLEVELAND, OHIO

Members Association Licensed Automobile Manufacturers

THE WAYNE TOURING CAR

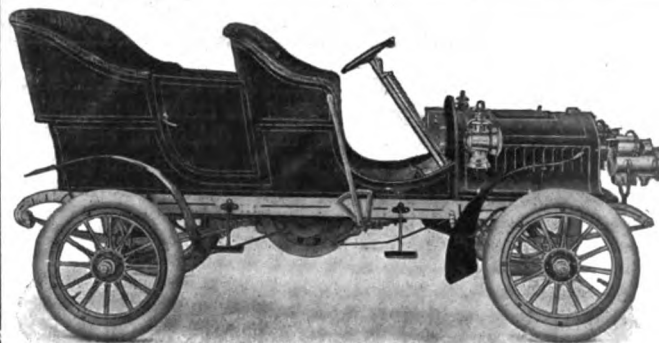

IS a sensible serviceable car for people who want an Automobile for practical use. The 16 H.P. motor has two opposed cylinders, the transmission is of the planetary type and the whole mechanism is as simple as can be made. The 90-inch wheel base ensures comfort in riding over any road. The compression in the Wayne engine is low, so that on the return stroke the pistons do not have to overcome the high compression found in most cars. This makes the Wayne a great hill climber and by economy on wear and tear, ensures long life to the engine.

Price [with double side
entrance tonneau] \$1,250

Price [with detachable ton-
neau rear entrance] \$1,200

We shall be glad to demonstrate the merits of our cars at the New York and Chicago shows or to send our catalogue to those who appreciate quality and reliability at a moderate price. Will you write us to-day?

WE HAVE SOME GOOD TERRITORY OPEN FOR LIVE AGENTS AND HAVE AN ATTRACTIVE PROPOSITION TO MAKE IF YOU WILL WRITE US *at once*

Wayne Automobile Co.

Dept. J. Detroit, Mich.

New York Agency: Wayne Automobile Agency, 308-310 W. 59th St.
Boston Agency: Walter C. Masters, 14-16 Columbus Ave.
Chicago Agency: McDuffee Automobile Co., 1449 Michigan Ave.
New York Show: Space C. Chicago Show: Spaces 107-108

"The Maxwell"

When you have ridden once in a Maxwell Automobile you may perhaps realize its smooth running qualities, its ease of manipulation, and its extreme simplicity of construction; but it is on long acquaintance only that you can fully appreciate those details of construction—those "Maxwell points," as we call them—that have made it a car to be relied on year in and year out, in any weather, on any road—a car that stays out of the repair shop, and in which "there is nothing to do but ride."

16 H. P. Touring Car
\$1,550
for the present

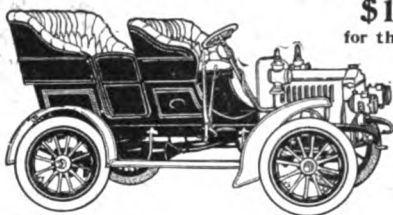

8 H. P. Tourabout
\$700
for the present

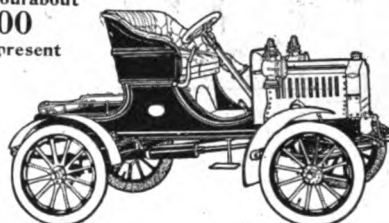

The "Maxwell" cars have no pump (thermosiphon). Their double opposed motor shaft drive is in front under the hood and easily accessible in every part. Bevel Gear Drive. Metal Bodies. Transmission Case and Crank Shaft cast in one piece of Aluminum. "Simply perfect and perfectly simple."

MAXWELL-BRISCOE MOTOR CO.
TARRYTOWN, N. Y.



The SEABOARD FLORIDA LIMITED

The handsomest and quickest train between New York and Florida, has the earliest daily arrival in Florida, therefore its patrons have *The choice of Rooms in Hotels* and best service en route.

The Seaboard Air Line Ry. is the shortest and quickest route to Ormond and all other Resorts in Florida—all trains go via Pinehurst, N. C., and Camden, S. C. These and many other charming resorts are delightful places at which to stop en route.

For Information, Rates and Winter Resort Booklets, address

CHAS. B. Ryan, G. P. A.,
Portsmouth, Va.

W. E. CONKLYN, G. E. P. A.,
1183 Broadway, New York.
Phone 2301 Madison Square.

PRICE **50** CENTS

PUBLISHERS' PRICE \$2.00.

THE
CONSTRUCTION

OF A
**GASOLINE
MOTOR VEHICLE**

By **C. C. BRAMWELL.**

Book contains 150 pages 6x9. One hundred illustrations and diagrams. Only a limited number left. Sent postpaid at 50c per copy. Address *The Automobile*, Flatiron Building, Madison Square, New York.

PUBLISHERS' PRICE \$2.00.—OUR

PRICE **50** CENTS

Broadway

29th Street



The Breslin

Direction of the **BRESLIN HOTEL COMPANY**
JAMES H. BRISLIN, President.
GEORGE T. STOCKHAM, Vice Pres. and Gen'l Manager.

New York's newest and most convenient hotel.

Opened November 12th.

500 **SPLENDID SUNLIT ROOMS.**
300 **BATHS.**

Every Delight of Management.

Prices from \$1.50 a day upward.

ALL CARS TRANSFER DIRECT TO THIS HOTEL.

Telephone 3648 Madison.

THE ROYAL TOURIST

\$3,000.00

32-38-H. P.

Double Side Entrance Body

ITS EQUAL HAS NEVER BEEN PRODUCED BEFORE

Ready to Deliver Now

NEW YORK SHOW, SECTION "M"

CHICAGO SHOW, STANDS 33-34-35

ROYAL MOTOR CAR CO.

CLEVELAND, OHIO

NEW ENGLAND AUTOMOBILE CO.
182 Columbus Ave., BOSTON, MASS.

C. A. DUERR & CO., Inc.
Broadway and 58th St., NEW YORK N. Y.

HARRY BRANSTETTER CO.
CHICAGO, ILL.

1897 "RIGS THAT RUN" 1905

The first of the famous St. Louis "Rigs that Run" was built in 1897, "over eight years ago," and is now being driven nearly forty miles a day, six days a week, and fifty-two weeks a year "by the original purchaser." Naturally we are proud of that record, as it stands for all that is good in automobile construction; most of all "EXPERIENCE," which carries a lot of weight with a successful agent, for he knows that he has something back of him. It is not impossible to assemble a bunch of junk, cover up the defects with a lot of cheap paint and polished brass. "But it's bad business." Such a car may give fairly good satisfaction for a season, although the repair bill usually doubles the cost. We built but ten cars in "1897," twenty in 1898, and have yearly increased our output, until 1905 finds us with the most complete, salable and up-to-date line on the market.

1 - 2 - 3 - 4 CYLINDERS

ranging from 12 to 40 H.P., and including everything known in modern automobile construction. Some of our agents have already received their first '05 shipments. To the prospective purchaser we say, "Do not" under any circumstances make your decision until you have a demonstration in the "Rigs that Run."

To the Agent.—We are making some radical changes in our sales department. We have some desirable territory at our disposal, and are open to talk business with "live ones." You cannot make a mistake in selecting our complete line, and our agency proposition is both attractive and profitable. We know it will please you.

ST. LOUIS MOTOR CARRIAGE CO.

1211-1217 NORTH VANDEVENTER AVENUE, - - ST. LOUIS, MO.

THE MICHIGAN

Two Models "E" and "D"

LIGHT TOURING CARS

For 1905

"The Car of Power"

This superb new creation for the coming season must be seen to be appreciated. It first appeals to the purchaser by its beauty, then it satisfies him by its speed, strength and durability.

These cars have our tried and tested 1904 Motors, 14 Horse Power, 2-cylinder, horizontal, opposed. Strong planetary transmission, Warner differential, Hill Precision Oiler, Kingston or Schebler carburetor, expanding rear-hub brakes, full elliptic springs, 86 inch wheel base, 30 inch wheels. 3 1/4 inch tires, side entrance body, individual front seats.

Get in line for a Michigan Agency while you can get one.

Made by

Michigan Automobile Co.

Kalamazoo, Mich.

We shall be at the New York and Chicago Shows.

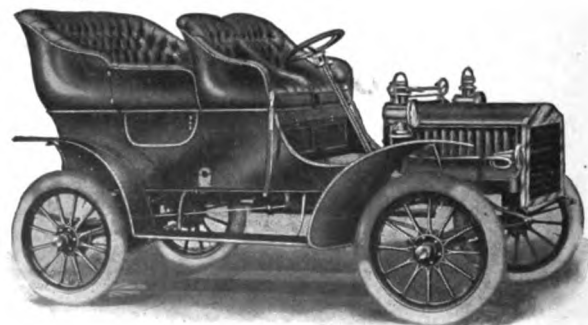

Model E, Price \$1250

Wheel Base
115 1-2 In.
Side Entrance
Tonneau
Double Chain
Drive
Aluminum Body
Any Style

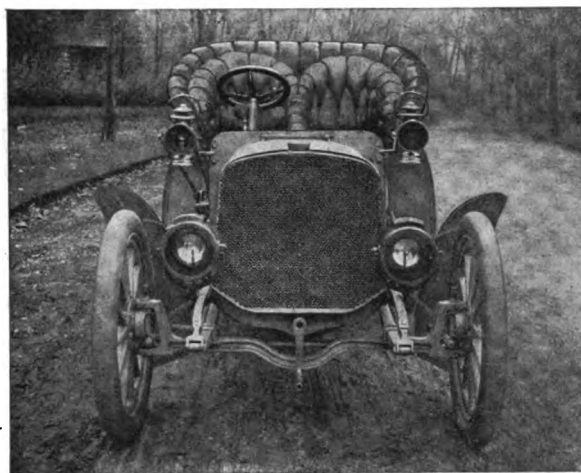

The Lozier Motor Car—30-35 H. P.

High-Class
Construction
Finish
Upholstery
and
Equipment
Price Complete
\$5,000

LOZIER

IN the matter of correct mechanical construction, the name "LOZIER" sticks out so prominently, that in the building of Automobiles it is certain to make an unquestionably strong impression as to what a thoroughly reliable and up-to-date Motor Car should be.

Lozier high-grade Motors and Motor Boats have long been famous and "top-notch," and we therefore bring into the Automobile field a well merited reputation for doing all things well.

The trade, generally, has known that for the past twenty-three months we have been working out our Automobile ideas and it gives us pleasure to announce at the beginning of the New Year,

"The Lozier Motor Car"

We have now in preparation our Motor Car Booklet and would be glad to enter your name for a copy.

Motor Boat Agents are requested to write us for our Motor Boat discounts

The Lozier Motor Company

1 Broadway, New York City Suite 7

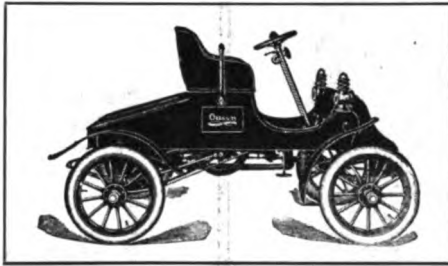

Model B. Runabout.
12 Horse-power two cylinder opposed type.



Model B. Touring Car.
12 Horse-power two cylinder opposed type.

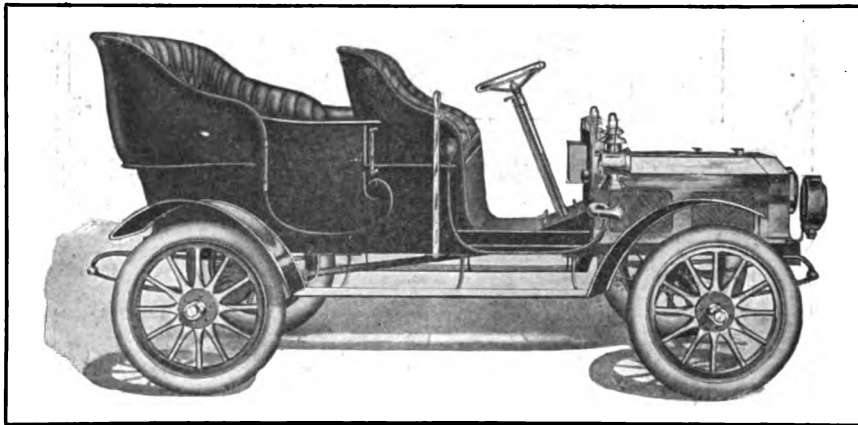

Model D. Touring Car.
24 Horse-power four cylinder opposed type

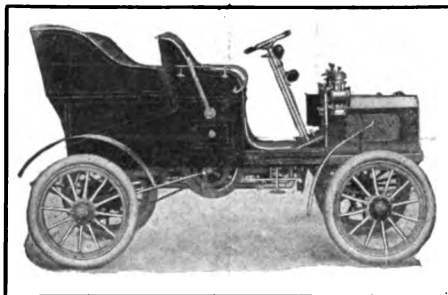

Model C. Touring Car.
16 Horse-power two cylinder opposed type.

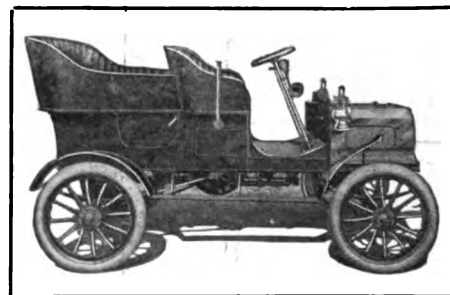

Model E. Touring Car.
16 Horse-power two cylinder opposed type.

QUEEN AUTOMOBILES

—FIVE ATTRACTIVE MODELS FOR 1905—

The most complete line offered by any manufacturer. No matter what your business or profession may be, we have the machine that will meet your requirements. Don't make the mistake of purchasing before seeing the "QUEEN" We will exhibit our full line at the New York Show, January 14th to 21st, 1905. Our motto "BIG POWER AND FEW PARTS" combined with superior workmanship, high finish and at prices that are not equalled by others, has made the "QUEEN" the most popular automobile on the market. Write for catalog of our different models and be convinced of above facts.

C. H. BLOMSTROM MOTOR CO., 72 Clark Avenue, DETROIT, MICH.

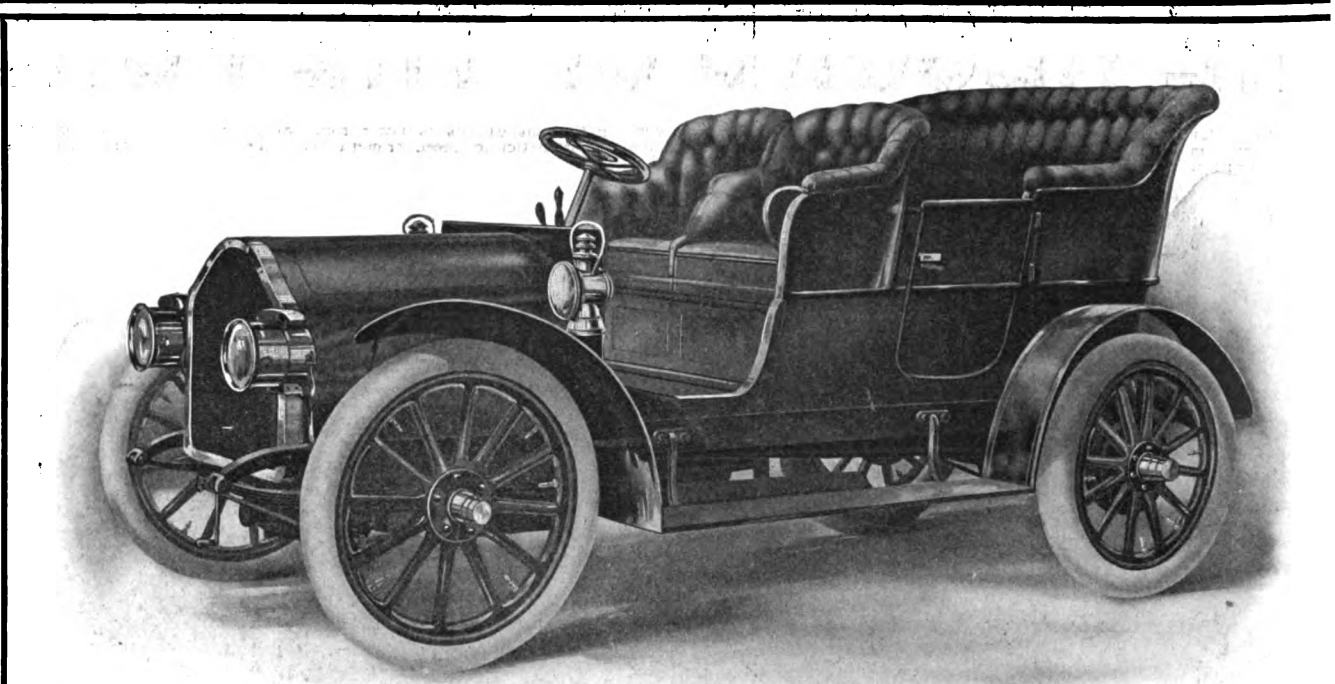

Orient Touring Car, Model de Luxe, 18-20 Horsepower. Price, \$2,250.

Three thousand air-cooled Orientals in successful operation is about as good proof as we can think of to back our statement that the Orient 4-cylinder, vertical, tandem, air-cooled motor is the best engine to bank on for 1905.

To the dealer who is undecided, however, we are prepared to positively demonstrate that there is more money for him in this season's Orientals than in any other line.

The eight Orient cars for 1905 make a complete line from the \$375 Buck-board (fool-proof, this year) to the \$2,250 Model de Luxe Touring Car—the best machine in the world at anywhere near the price.

With the Orient line, you can sell any possible customer in your territory.

The whole story is told in the prices, in the reliability of the Waltham Manufacturing Company, and in the superbly designed 1905 Orient cars. Study the illustration shown here of our 18-20 Horsepower Touring Car at \$2,250, and see if there's anything on the market to equal it.

Arrangements are now being made with dealers for the sale of the entire Orient line for 1905, and we shall be pleased to furnish complete information in reply to your request.

Waltham Manufacturing Co.

Sales Office for New York, New Jersey, Pennsylvania, Delaware, Maryland,
Virginia, North Carolina, South Carolina, Georgia and Florida,
44 Broad St., New York City.

FACTORY AND GENERAL SALES OFFICES,
WALTHAM, MASS.

POSITIVELY:—

We are Going to Push the Orient Line in 1905 as no Line Was Ever Pushed Before

THE RECORD OF THE FORD

Victory after victory is credited to the Ford light racing car. When you consider that this car gets its power from two of our standard type horizontal motors, you must admit it is proof positive of the correctness of the Ford design and construction for speed, strength and power. The Ford cars have established a record in everyday use of consistent reliability and unvarying satisfaction.

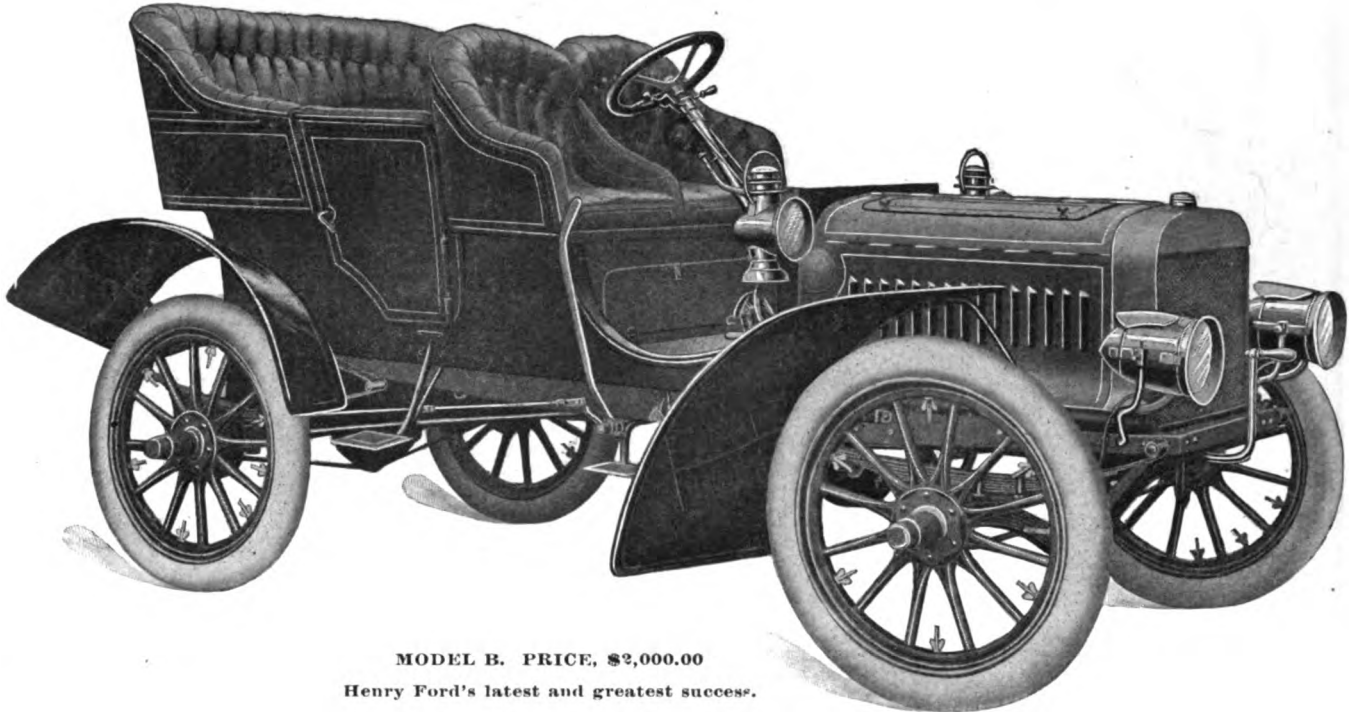

MODEL B. PRICE, \$2,000.00

Henry Ford's latest and greatest success.

A striking example of the distinctive Ford construction. Weight, 1,710 lbs. Four cylinder vertical motor, developing over 20 horsepower. This gives our car more power for its weight than any car of equal price in the world. Consequently there is less wear on the tires and ample reserve power for steep grades and sandy roads. Wheel base, 92 inches; direct drive with universal coupling; cylinders 4x5, water cooled; automatic oiling devices with force feed; large side entrance tonneau seating three people.

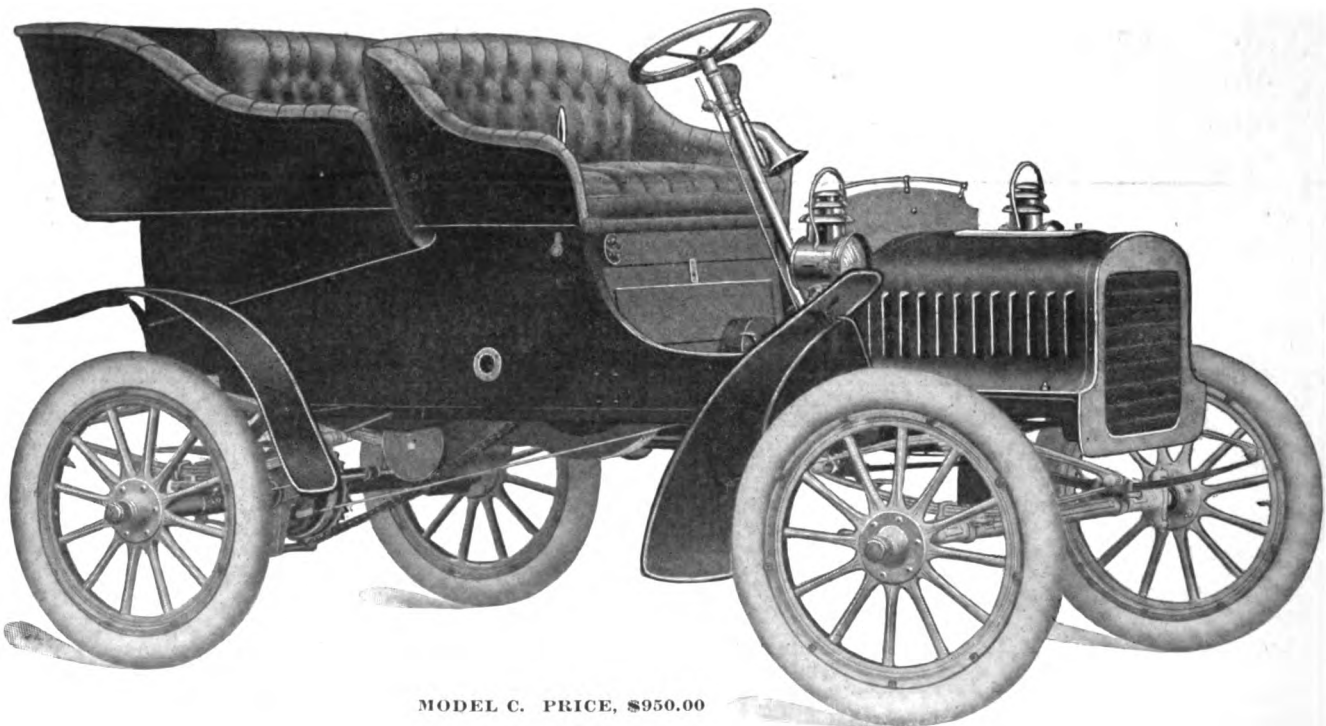

MODEL C. PRICE, \$950.00

The improvements on the FORD two-cylinder car place this model ahead of any car on the market at anywhere near the price. Both in style and mechanical construction this car is a year in advance of its nearest competitor. Double opposed motor of 10 actual horsepower, planetary transmission, chain drive, and increased gasoline capacity. The most stylish low-priced car on the market.

SOME GOOD TERRITORY YET FOR LIVE AGENTS. WRITE US TO-DAY FOR FULL INFORMATION.

THE FORD MOTOR CO.

Detroit, Mich.

See Exhibit, Space G, at New York Show.

JOHN WANAMAKER, Selling Agent for New York and Philadelphia.

CANADIAN FACTORY, THE FORD MOTOR CO. OF CANADA, WALKERVILLE, ONT.

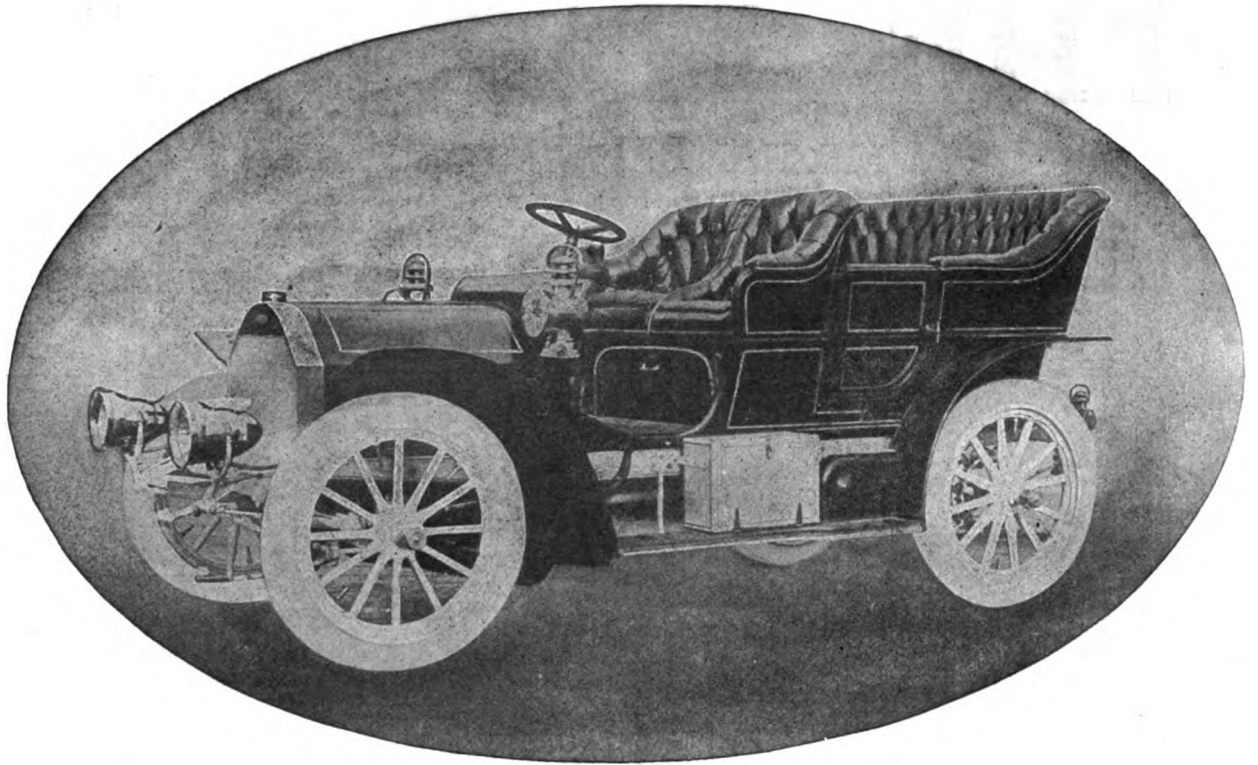

"Easily the best built car in America."

The Locomobile

OUR complete four-cylinder line; record for reliability; and facilities for making early Spring delivery will interest every agent.

1905 MODELS

<p>15-20 H.P., \$2,800 20 H.P. motor with mechanically operated valves, all interchangeable. Make and break ignition magneto. Three-speed transmission. Pressed steel frame. Wheel base, 92 inches. Weight, 1,800 lbs. Side-entrance tonneau.</p>	<p>20-25 H.P., \$3,700 25-H.P. motor, with automatic inlet valves and jump spark ignition. Three-speed transmission, direct drive on top speed. Channel steel frame. Wheel base, 96 inches. Weight, 2,300 lbs. Side-entrance tonneau.</p>	<p>30-35 H.P., \$5,000 35 H.P. motor with mechanically operated valves, all interchangeable. Make and break ignition magneto. Three-speed transmission. Pressed steel frame. Wheel base, 106 in. Weight, 2,500 lbs. Side-entrance tonneau.</p>	<p>40-45 H.P., \$7,500 45 H.P. motor with mechanically operated valves, all interchangeable. Make and break ignition magneto. Four-speed transmission. Pressed steel frame. Wheel base, 110 in. Weight, 2,800 lbs. Side-entrance tonneau.</p>
--	--	---	--

The Locomobile Company of America, Bridgeport, Conn.

Member Association of Licensed Automobile Manufacturers.

BRANCHES

NEW YORK—Bway., c-r. of 76th St.
 PHILADELPHIA—No. 249 N. Broad St.
 CHICAGO—No. 1354 Michigan Ave.
 BOSTON—No. 15 Berkeley St.

THE MARMON

A MECHANICAL MASTERPIECE

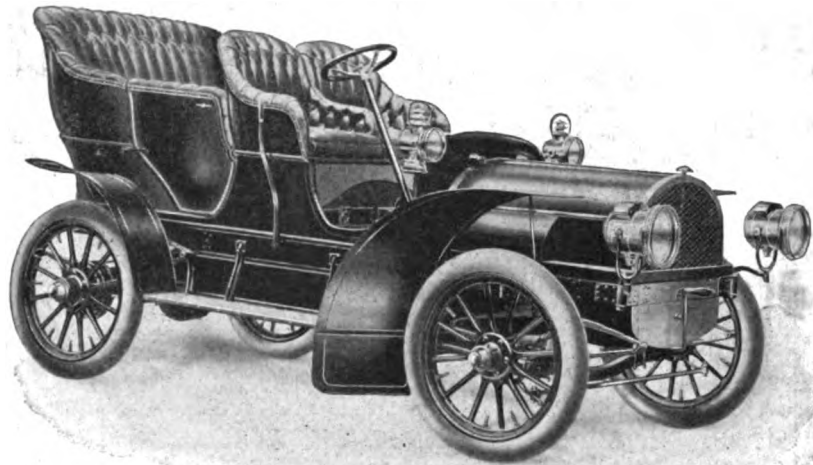

THE MARMON—1905 MODEL—PRICE, \$2,500.

THE EXTREME LUXURY OF MOTION

One ride in the Marmon Car makes a ready purchaser of any man who has determined to buy a high-grade car. Conceive a combination of the gentle swing of a hammock with the rush of a fast train and you have some notion of the sensation given by a ride in the Marmon. Double Three-Point Suspension, and engine built on correct principles, and a driving mechanism that does its work smoothly and well, tell the story. It is a car ahead of the times.

DOUBLE THREE-POINT SUSPENSION.—Long recognized and vainly sought by experts and designers as the ideal, is embodied in the only successful construction yet devised, in the Marmon Car. Broad patents cover this feature. The body is on one frame, and engine and transmission on another, independent of each other, and both hung on three-point suspension.

THE BODY is roomy and luxurious, and, since it has no engine vibration and almost none from rough roads, it rides like a parlor car. Seats and dash are of single-piece aluminum castings, as are also fenders and bonnet, giving light weight and high and durable finish. Ninety-inch wheel base. Double side entrance tonneau.

MOTOR AND TRANSMISSION.—The motor is a four-cylinder engine, thoroughly and perfectly air-cooled. Tested under the most severe conditions, it has proven its great value. Direct drive is had by means of a rigid shaft from engine to bevel gear in a unique rear axle, within which and bearing no weight moves the driving shaft. Cardan joints are eliminated, and transmission is never out of alignment. Absence of vibration and undue friction allows the whole mechanism to do its full duty without strain or interference; hence 20-H. P. in the Marmon is equivalent to 35-H. P. in many automobiles.

AUTOMATIC FORCE OILING SYSTEM providing copious lubrication and insuring against the slightest oil troubles. All gears run in oil and the whole mechanism, while readily accessible, is dust proof and oil tight.

THE CONTROL is simple, quick and sure.

The Marmon is made throughout of the very best materials with the most minute and precise workmanship; is built, tested, and guaranteed in every part by a company that for fifty years has known no superior in the production of high-grade machinery. It is an interesting proposition for agents with a high-class trade.

NORDYKE & MARMON COMPANY,

FACTORY AND EXECUTIVE OFFICES

INDIANAPOLIS, IND.

GROUT 1905 STEAM TOURING CAR.

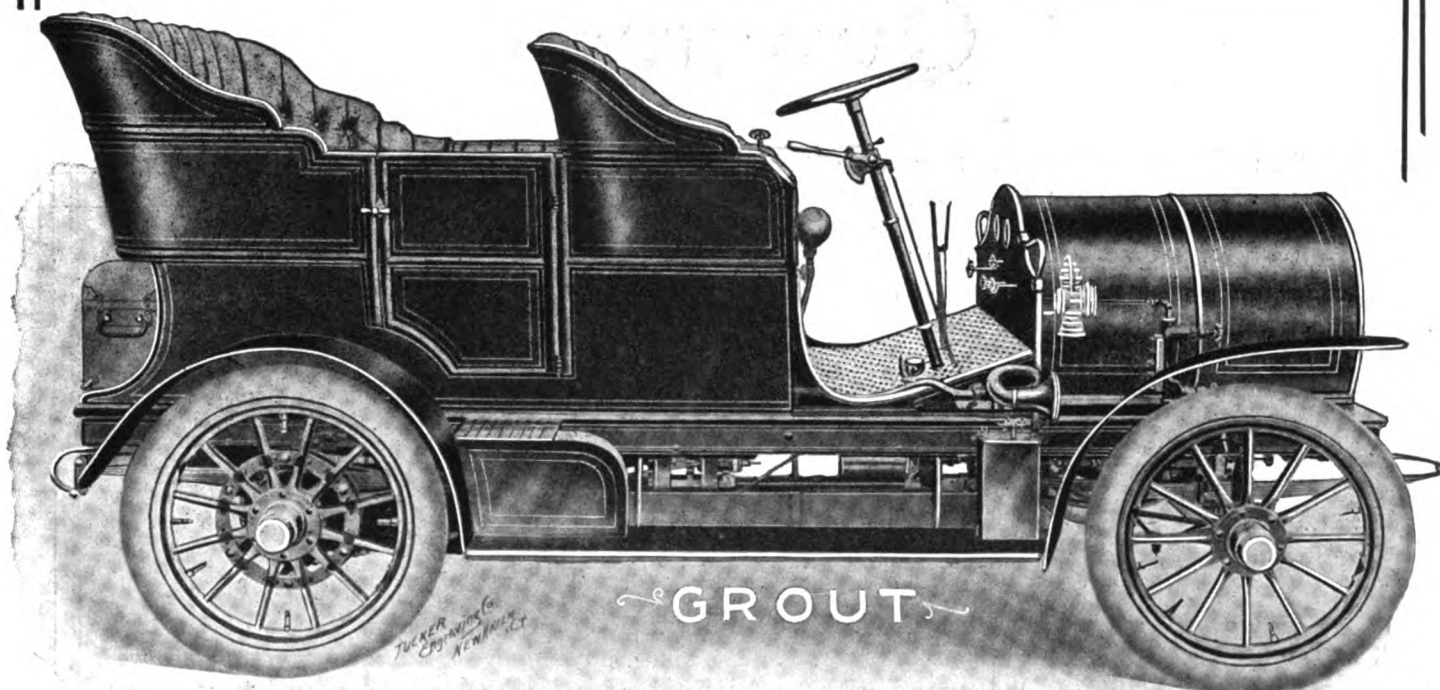

\$1500 SIDE DOOR TONNEAU \$1500

Entirely new construction throughout. New and Improved 18-inch Boiler and Fuel System. 12-H.P., 2-cylinder Horizontal Engine in dust-proof aluminum case. Positive lubrication to all working parts. Compensating gear in center shaft. Two expanding rear-hub brakes. Grout patented one piece slot burner, noiseless torch, the air being automatically regulated, insuring perfect combustion. Back firing impossible. Irreversible wheel steer: wheel base 86 inches. Weight 1,750 lbs. Wheel diameter, 30 inches, size of tires, 30 x 3½ inches. Water capacity 45 gallons, gasoline 15 gallons. Car sold complete with 4 lamps, horn and full set of tools. **NO DANGER OF FREEZING IN ZERO WEATHER.**

Agents Now Being Appointed in Unoccupied Territory

We Exhibit at the New York Show—Space J, Main Floor

GROUT BROS. AUTOMOBILE CO., 285 East Main St.
ORANGE, MASS.

BOSTON BRANCH
151-153 Columbus Avenue

NEW YORK CITY
Eastman Auto Co.
308-310 West 59th Street

WASHINGTON, D. C.
Clarence Pittman
1310 Staunton Court

The Standard Automobile Company in New Quarters

We take pleasure in announcing to the public that we have purchased the storage, repair and supply business of the Central Automobile Co., 1684 Broadway, where we have the most commodious, convenient and up-to-date garage in New York, with accommodations for 250 cars.

Our Vice-President and General Manager are now attending the Paris Automobile Salon, arranging for our importation of 1905 DECAUVILLE CARS. They are carefully inspecting every leading garage in Paris and London, and upon their return will be given "carte blanche" to remodel our new quarters, embodying every feature that their experience and observations can suggest. We purpose to maintain an establishment in keeping in every way with the standing of

"That Decauville Car"

Patented Nov. 5, 1895; May 12, 1903; June 28, 1903.

A Repair Department will be installed, equipped with the most modern machinery obtainable. Neither expense nor effort will be spared to maintain, and if possible excel, the same high standard we have already established. We appreciate that a satisfied customer is the best possible advertisement, and we shall advertise this department through our patron.

We extend a cordial invitation to all who are interested to call and inspect our new quarters and listen to our plans for the future. We shall be very grateful for suggestions from experienced owners that will help us to render a superior service.

We have just received for immediate delivery three sizes of

"That Decauville Car"

12-16 H. P. SIDE ENTRANCE.

18-24 H. P. LANDAULETTE.

40-50 H. P. SPECIAL BODY.

Standard Automobile Company of New York

Sole United States Agent "That Decauville Car."

SALESROOM,
136 West 38th St.
Phone, 476-38th St.

GARAGE,
1684 Broadway.
Phones, 2397 & 2398 Columbus.

1905 MODELS NOW  **READY**

MORS

24-35 H.P.

40-50 H.P.

NAPIER

15-18 H.P. FOUR CYLINDERS 18-35 H.P. SIX CYLINDERS

PLACE ORDERS NOW TO INSURE DELIVERY.

The Central Automobile Co.

1684 Broadway

Having sold out our storage and repair departments to The Standard Automobile Co. very suddenly, we will be at our old address until suitable arrangements for a new Sales-room can be made.

You will be notified of our new address later.

Packard

Model N

combines all the proven excellence of our Model "L" with the addition of more motor power, longer wheel base, double side entrance.

Personally investigate the merits of the following distinctive Packard features as contained in the construction of our Model "N," before placing your order.

PACKARD motor with mechanically actuated and interchangeable valves.

PACKARD expanding clutch.

PACKARD flexible driving shaft. (The simplest thing of its kind made.)

PACKARD combined driving and transmission gear all in one.

PACKARD three-point spring suspension.

PACKARD new positive circulation radiator.

PACKARD direct-acting duplex brakes.

PACKARD liberal use of aluminum.

PACKARD thoroughness in all things.

PACKARD power carried on ball bearings.

PACKARD quality, simplicity, efficiency.

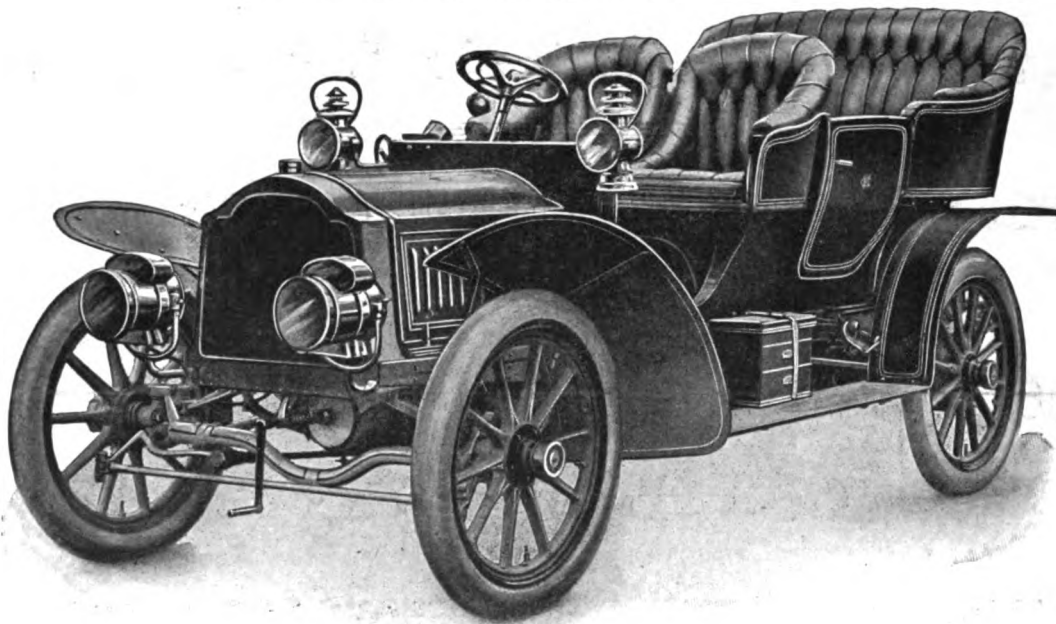

28-H.P. Wheel base, 106 inches. Rear springs, 50 inches. Price standard equipment f. o. b. factory \$3500. Winner of The Grand Prize, World's Fair, St. Louis. Send for catalog 3 and name of nearest Packard dealer to

PACKARD MOTOR CAR CO., Detroit, Mich.

Member A. L. A. M.

New York Branch, 1540 Broadway.

OLDSMOBILE

PROCLAMATION

—No. 2—

MR. BUYER:

We ought to know how to build the best automobile of to-day. We have had twenty years' experience, have built more machines than any other maker in the world and have the largest factories. The crowning triumph of up-to-date American Automobile construction, the 100 per cent. plus of Oldsmobile excellence is our new

20 H.P. TOURING CAR

Here is what we give you at the price:

SPEED—6 to 40 miles per hour. Has surprising ability to climb hills on high gear.

BODY—Side entrance, heavily upholstered, hand puffed leather.

SEATING CAPACITY—Five passengers. Wheel base, 90 inches.

RADIATOR—Honeycomb cooler, unsurpassed for efficiency.

MOTOR—Double opposed, 20 horsepower; cylinders, 5 $\frac{1}{4}$ x 6 inches. Simplest construction. All parts readily accessible. Valve mechanism above cylinders, away from dust and mud. Both valves mechanically operated. Noise of exhaust completely eliminated.



\$1,400

Do you want the discomfort, small power, breakages and trouble of the cheap tonneaus—the complication, chauffeur and difficult adjustment of the four-cylinder cars? We think not. You want extreme comfort, a side entrance, surplus of power on hills and speed on the level, simplicity of construction, and that well known Oldsmobile reliability.

IT IS YOURS AT \$1,400, JANUARY DELIVERY

Write us or our agents for further information and place your order early

OLDS MOTOR WORKS

DETROIT, MICH., U. S. A.

Member of Licensed Association of Automobile Manufacturers.

CAMERON

**King of All Weather Read How and Why
It is the Car of Economy**

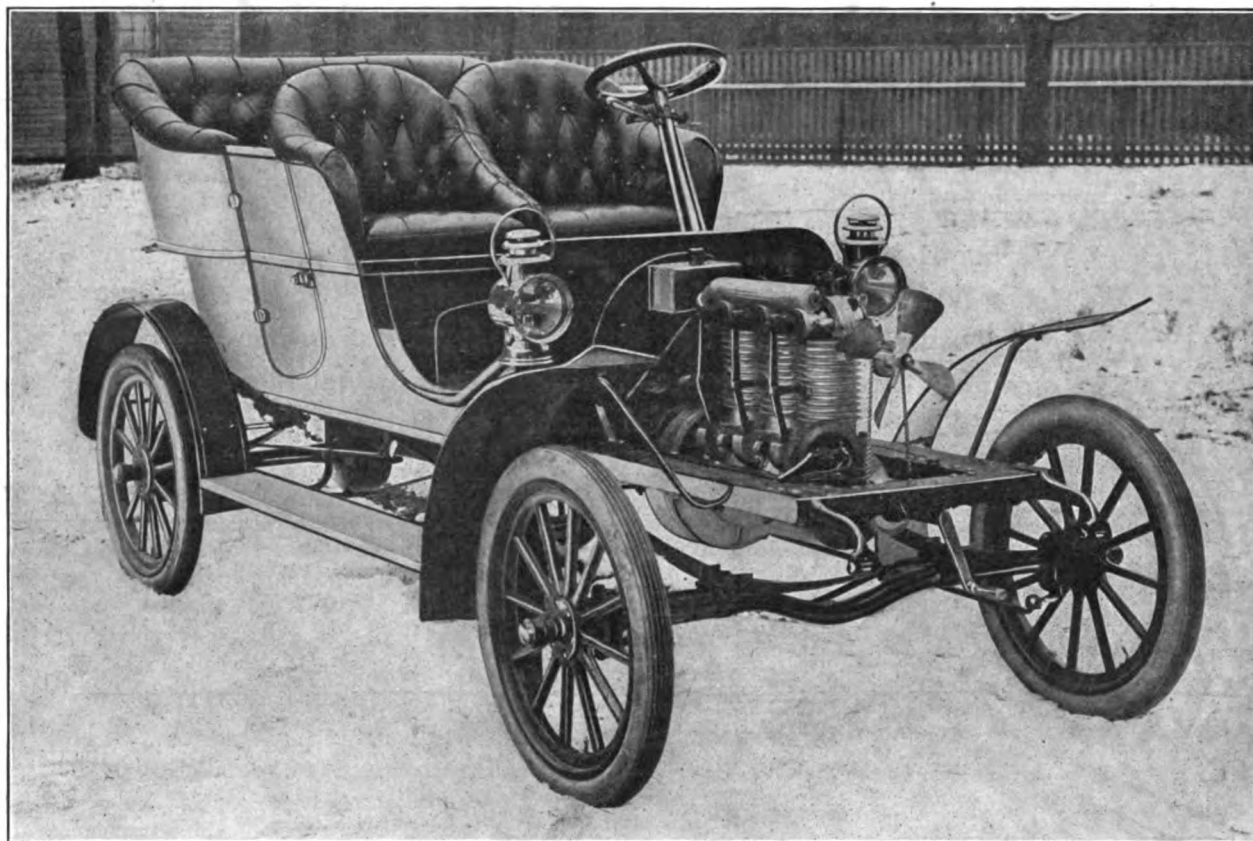

Model L, with Hood Removed, Showing Easy Access to Motor

MODEL H—TWO CYLINDER, 8-10 H. P. RUNABOUT -	-	-	\$650
MODEL I—TWO CYLINDER, 8-10 H. P. LIGHT TONNEAU -	-	-	750
MODEL J—THREE CYLINDER, 12-15 H. P. SPECIAL SURREY	-	-	1050
MODEL K—THREE CYLINDER, 12-15 H. P. RUNABOUT -	-	-	950
MODEL L—THREE CYLINDER, 12-15 H. P. SAME AS CUT	-	-	1050

**Air-Cooled Shaft Drive
Sliding Gear Transmission
No Gears in Mesh on
High Speed**

Perfect Control. Can be stopped and started without changing from high speed

How and Why The sturdy Cameron will cost you less at the end of the year than any other car yet manufactured—hence, the car of economy. Simplicity, together with absolute durability in our cars, has reduced the cost of maintenance to a minimum. **BUILT FOR SERVICE, IT SERVES YOU.**

DEALERS who are looking for a reliable proposition, write quickly. Cars sell on demonstration. No competition at the same price—investigate.

THE JAMES BROWN MACHINE CO.

Established 1829

PAWTUCKET, RHODE ISLAND

The Motor Car *of the* Future

WE want you to know where the Franklin stood when we began, and where we stand now: We started with the four-cylinder air-cooled car and have never made anything else. At that time, it was the only four-cylinder car manufactured in the United States. All other cars, made in this country, were either two-cylinder or one-cylinder, the manufacturers claiming that four cylinders were unnecessary as well as

expensive. Many of the high-grade cars have followed our lead in the matter of four cylinders, and there have been several weak imitations of the Franklin air-cooled system. It is important for buyers of motor cars to remember that we began right.

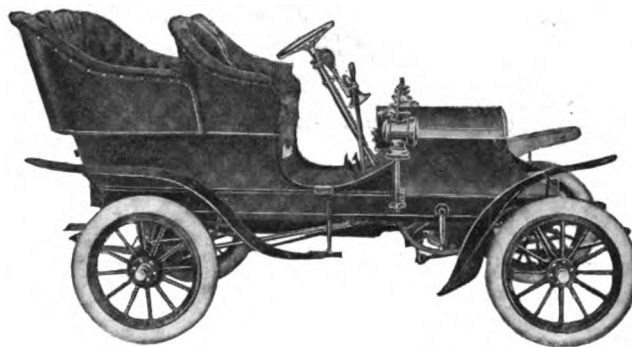

Four cylinders is not all; air-cooling is not all; light weight is not all—though we have accomplished all three of these. It is a matter of fine and successful engineering; the economical and thorough application of power, so that none of it is wasted.

It is as difficult for makers of water-cooled, clumsy, wasteful motor-cars to build all at once, a correct and effective air-cooled engine, as it would be for us, who have devoted all our thoughts to this one subject, to build a Hoe Press.

Experience counts. Three years ago the Franklin pointed out the way to makers of motor cars. Today it still points out the way and leads by miles and years.

That is what we mean by saying "THE FRANKLIN is the Motor Car of the Future."

H. H. FRANKLIN MFG. CO.

Member Association Licensed Automobile Manufacturers.

SYRACUSE, N. Y.

WINTON

ALL motors depending upon splash lubrication have, under the cylinders, a supposedly airtight oil crank case. Bottom of crank case is an inch or two below the lowest point of connecting rod travel. Connecting rods are attached to crankshaft. They support the pistons in the cylinders. Lubricating oil, to a depth of three inches or so, is dumped into the crank case. Theory is that as the connecting rods travel they strike the oil in the crank case and "splash feed" it to the bearings. Theory is all right. System all right with stationary gas engines, where a leaky crank case can be quickly detected and where oil will remain at a constant level. But here is something to consider: For driving up hill, what happens to the oil? Doesn't it flood the rear of crank case? Will it not flood the rear cylinder and cause a foul spark plug?

Or, let the car be driven down hill. Same thing happens to forward cylinder. Remember, too, that when one cylinder is flooded, the others are suffering from a *total lack of lubrication*. Result: Hot brasses and damaged bearings at one end and fouled spark plugs at the other.

There is *no splash lubrication* in the Winton. We do not depend upon *chance oiling*. All working parts—even the connecting rod bearings—are lubricated positively.

These bearings travel around a circuit and can be reached for positive lubrication only through the crank shaft. This is accomplished as follows: Oil is fed through tubes (No. 196) to stationary crank shaft bearings and is then directed through a spiral groove (169) to a small channel bored through the center of crank shaft. These channels terminate at the connecting rod bearings and constantly supply all the lubricant that is needed for these important points of friction.

Catalogue No. 5 describes other exclusive Winton features. Shall we send you a copy?

Four models---all with four cylinder vertical motors. 16-20 H. P., \$1,800; 24-30 H. P., \$2,500; 40-50 H. P., \$3,500 and \$4,500

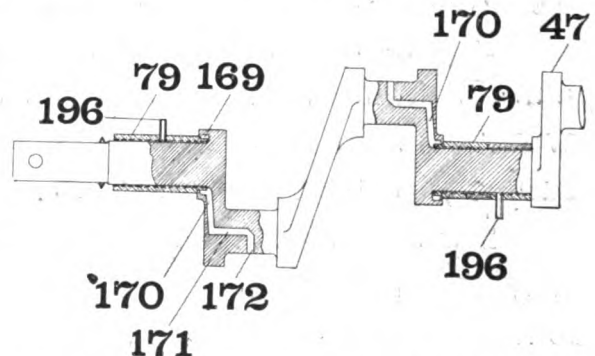
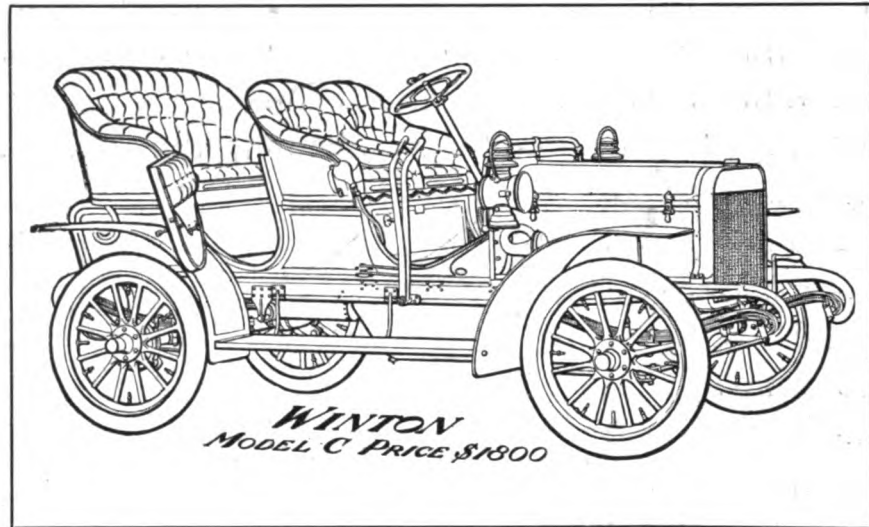

POLAR COMPOUND

Non-freezing. Keeps water fluid at 10° above zero. One filling lasts all winter. 25 cents a gallon, f. o. b. Cleveland. Shipping cans—5 gal. 50c., 10 gal. 75c., —extra.

THE WINTON MOTOR CARRIAGE CO.

Member A. L. A. M.

CLEVELAND, OHIO, U. S. A.



1905 ~ Mercedes

We have the honor to announce the taking over of the entire and exclusive business management and distribution of 1905 Mercedes in the United States by arrangement with

ALLEN HALLE CO.,
LONDON, PARIS, STUTGART,
Sole Concessioners.

Full prices, particulars and information on request.

All parts and accessories will be kept in stock.

Smith & Mabley

INCORPORATED

513-519 Seventh Ave.
New York, N.Y.

MEMBERS



A.L.A.M.

WINTON

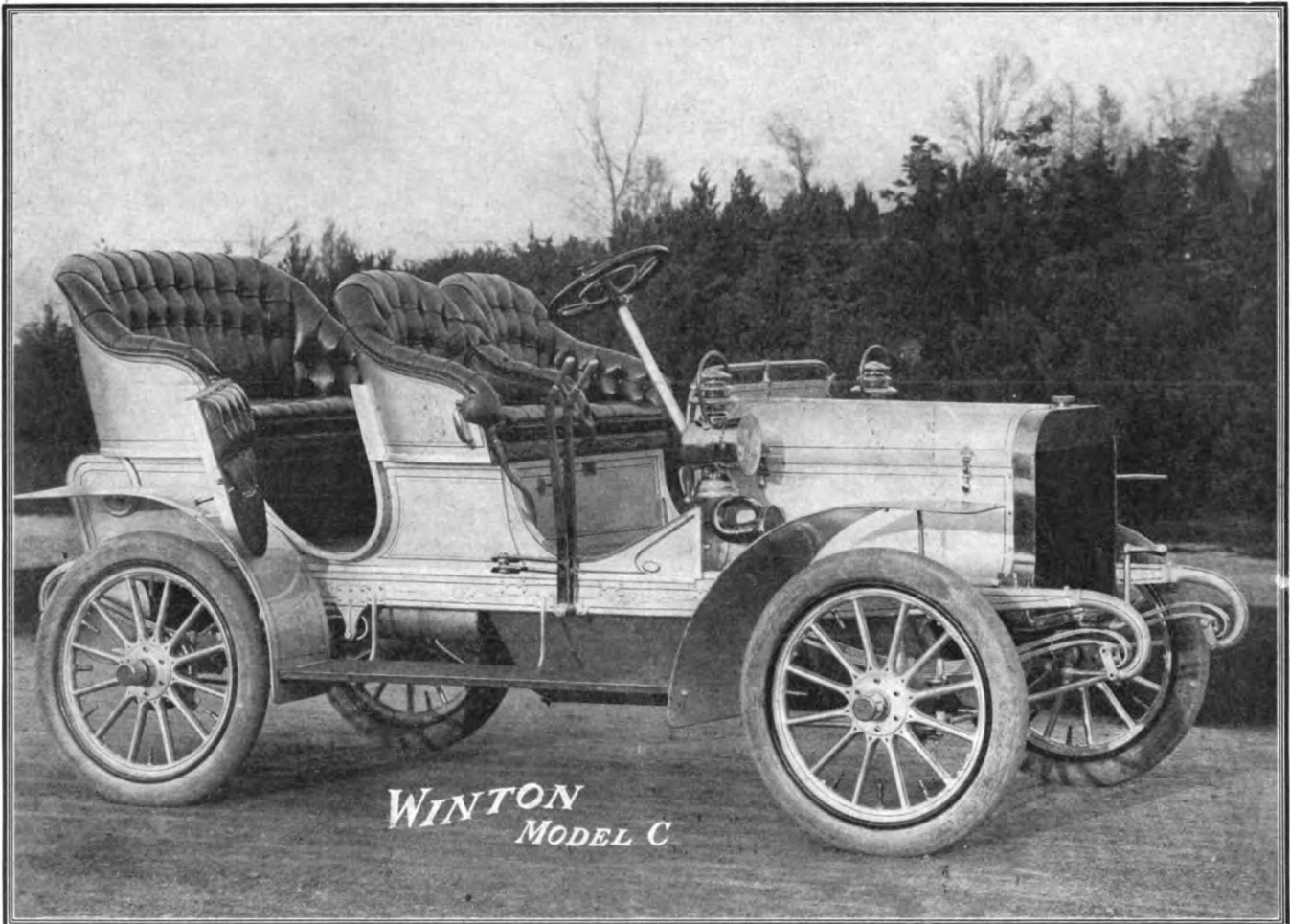

EXCLUSIVE ADVANTAGES:

Purchasers of 1905 WINTON cars secure in our new four-cylinder vertical construction *many exclusive advantages*. These features remove previous automobile faults and make motoring safe, easy and inexpensive.

Positive, gear operated lubrication.
Automatic air governor.
Easy Accessibility.
Simplicity, strength and power.
Absolutely sure ignition.
Compensating springs.

Catalog No. 5, just out, presents the facts and nothing else. May we send you a copy?

Model C, 16-20 H.P., . \$1,800
 Model B, 24-30 H.P., . 2,500

Model A, 40-50 H.P., . \$3,500
 Model A, Special, 40-50 H.P., 4,500

POLAR COMPOUND

Non-freezing. Keeps water fluid at 10° below zero. Will not crystalize. Not injurious to metal or rubber. One filling lasts all winter. 25 cents per gallon, f. o. b. Cleveland.

THE WINTON MOTOR CARRIAGE CO.

Member A. L. A. M.

CLEVELAND, OHIO, U. S. A.



UNIVERSITY OF MICHIGAN



3 9015 06713 8894

